

# LOCAL CONNECTIVITY OF THE MANDELBROT SET AT SOME SATELLITE PARAMETERS OF BOUNDED TYPE

DZMITRY DUDKO AND MIKHAIL LYUBICH

ABSTRACT. We consider the unstable manifold of a pacman renormalization operator constructed in [DLS]. It comprises rescaled limits of quadratic polynomials. Every such limit admits a maximal extension to a  $\sigma$ -proper branched covering of the complex plane. Using methods and ideas from transcendental dynamics, we show that certain maps on the unstable manifold are hybrid equivalent to quadratic polynomials. This allows us to construct a stable lamination in the space of pacmen. Combined with hyperbolicity of pacman renormalization, we obtain various scaling results near the main cardioid of the Mandelbrot set. As a consequence, we show that the Mandelbrot set is locally connected at certain infinitely renormalizable parameters of *bounded satellite* type (which provide first examples of this kind). Moreover, the corresponding Julia sets are locally connected as well. We then show, adapting the method of [AL2], that these Julia sets have positive area. (Note that the examples constructed in [BC] are of *unbounded satellite* type, while the examples from [AL2] are of *bounded primitive* type).

## CONTENTS

1. Introduction	1
2. Sector renormalization	10
3. Background on the pacman renormalization	24
4. Dynamics of maximal prepacmen	36
5. External structure of $\mathbf{F}_*$	45
6. Holomorphic motion of the escaping set	72
7. Parabolic bifurcation and small $\mathcal{M}$ -copies	79
8. The valuable flower theorem	94
9. Proof of the main results	103
References	115

## 1. INTRODUCTION

**1.1. Main themes.** This paper touches upon several central themes of Holomorphic Dynamics: Rigidity and MLC, local connectivity and area of Julia sets, in their interplay with Renormalization Theory. Developing further the *Pacman Renormalization Theory* designed in [DLS] (jointly with Nikita Selinger), and employing methods and ideas from transcendental dynamics, we produce parameters of new kind where the Mandelbrot set is locally connected and whose Julia sets are locally connected and have positive area.

The MLC problem (of local connectivity of the Mandelbrot set) goes back to the classical work of Douady and Hubbard from the 1980s. The original motivation was to produce a precise topological model for the Mandelbrot set  $\mathcal{M}$ . Soon afterwards a deep connection to the Mostow kind Rigidity phenomenon was revealed, due to insights by Thurston and Sullivan. Around 1990s, due to the work of Yoccoz, the problem was closely linked to the Quadratic-Like Renormalization, by reducing it to the case of *infinitely renormalizable parameters*.

*Quadratic-Like Renormalization* appears in two flavors: *primitive* and *satellite*. The former generates stronger expansion allowing for a better control, which has led to substantial progress in the past 20 years. In particular, MLC was established by Jeremy Kahn and the second author [L2, KL1, KL2] under the *molecule condition* when all the renormalizations stay uniformly away from the satellite type. This covers, in particular, all parameters of *bounded primitive type* [K].

The satellite renormalization is delicately related to the non-expanding rotation regime near the main cardioid of  $\mathcal{M}$ , and progress in understanding of this kind of phenomenon has been slower. Recently, Cheraghi and Shishikura [CS], using the Inou-Shishikura *Almost Parabolic Renormalization* [IS] have constructed a certain set of parameters of *unbounded satellite type* where MLC holds. In this paper we construct, by completely different methods, first examples of parameters of *bounded satellite type* where MLC holds. Moreover, Julia sets are also locally connected at these parameters (“JLC”).

Problem of area of Julia sets is intimately related to the MLC and JLC problems, and progress in these three has been made in parallel. First examples of Julia sets of positive area were constructed by Buff and Cheritat around 2006 [BC]. Their machinery has produced examples of three types: *Cremer*, *Siegel* and *infinitely renormalizable of unbounded type* (probably, all *non-locally-connected*). In a more recent work by Artur Avila and the second author [AL2], *infinitely renormalizable* examples of *bounded primitive type* were constructed (all *locally connected*). The machinery developed there applies to maps constructed in this paper giving first examples of Julia sets of positive area for *infinitely renormalizable* maps of *bounded satellite type* (also locally connected).

Our main tool is *Pacman Renormalization* developed in [DLS]. It combines features of two classical Renormalization Theories: *Quadratic-like* and *Siegel*. The latter originated in the 1980s in physics literature, which yielded a long-standing renormalization conjecture. In the 1990s McMullen constructed a Siegel renormalization periodic point and described its maximal analytic extension for any rotation number of periodic type [McM2]. It was proven in [DLS] that this point is hyperbolic with one-dimensional unstable manifold  $\mathcal{W}^u$ . (Let us note that in the mid 2000s Inou and Shishikura proved the existence and hyperbolicity of Siegel renormalization fixed points of sufficiently high combinatorial type using a completely different approach, based upon the parabolic perturbation theory [IS].)

In this paper we study the above unstable manifold  $\mathcal{W}^u$  as a one-parameter transcendental family. It was shown in [DLS] that every map in  $\mathcal{W}^u$  admits a maximal analytic extension to a  $\sigma$ -proper map onto  $\mathbb{C}$ . Using ideas of Transcendental Dynamics (compare [DK, EL, E, SZ, RRRS, Re, BL, BR]), we construct “external rays” and describe the associated “puzzle structure” for this family (§§5–6). This allows us to construct an appropriate quadratic-like family inside  $\mathcal{W}^u$  (§7). Using hyperbolicity of  $f_*$  established in [DLS], we transfer this family, along the *hybrid lamination* in

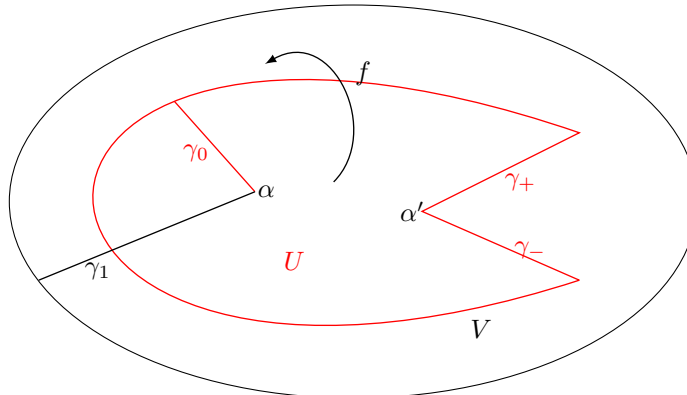

FIGURE 1. A (full) pacman is a  $2 : 1$  map  $f : U \rightarrow V$  such that the critical arc  $\gamma_1$  has 3 preimages:  $\gamma_0$ ,  $\gamma_+$  and  $\gamma_-$ .

the space of pacmen, from  $\mathcal{W}^u$  to the quadratic family, yielding desired parameters (§9).

We remark that the unstable manifold of a quadratic-like renormalization operator can be described in a similar way as it is done in this paper for a pacman renormalization operator. In fact, some steps are simpler for quadratic-like maps thanks to their nice external structure.

**1.2. Statement of the results.** Let us pass to a more technical description. Let  $c(\theta), \theta \in \mathbb{R}/\mathbb{Z}$ , be the parameterization of the main cardioid  $\partial\Delta$  by the rotation number  $\theta$ . Consider the molecule map  $\mathbf{R}_{\text{prm}} : \mathcal{M} \dashrightarrow \mathcal{M}$  (see [DLS, Appendix C]); its action on  $\partial\Delta$  is given by

$$(1.1) \quad \theta \longrightarrow \frac{\theta}{1-\theta} \quad \text{if } 0 \leq \theta \leq \frac{1}{2}; \quad \theta \longrightarrow \frac{2\theta-1}{\theta} \quad \text{if } \frac{1}{2} \leq \theta \leq 1.$$

Let us fix an  $\mathbf{R}_{\text{prm}}$ -periodic point  $c(\theta) \in \partial\Delta$  with period  $m$ .

Let  $\mathcal{M}_0$  be a small copy of the Mandelbrot set centered at the main molecule such that  $\mathcal{M}_0$  is close to  $c(\theta)$ . By the Yoccoz inequality,  $\mathcal{M}_0$  is contained in a small neighborhood of  $c(\theta)$ . Define inductively  $\mathcal{M}_{n-1}$  to be the unique preimage of  $\mathcal{M}_n$  under  $\mathbf{R}_{\text{prm}}^m$  so that  $\mathcal{M}_{n-1}$  is also in a small neighborhood of  $c(\theta)$ ; i.e.  $\mathcal{M}_n$  shrinks to  $c(\theta)$ . For  $n \leq 0$  denote by  $\mathbf{R}_n : \mathcal{M}_n \rightarrow \mathcal{M}$  the Douady-Hubbard straightening map.

A map  $g : \mathbb{C} \dashrightarrow \mathbb{C}$  is  $1 + \varepsilon$ -conformal at  $z_0 \in \text{Dom } g$  if  $g$  has the derivative  $g'(z_0)$  at  $z_0$  such that the corresponding linear map approximates  $g$  with an error term:

$$g(z_0 + z) = g(z_0) + g'(z_0)z + O(|z|^{1+\varepsilon}), \quad z + z_0 \in \text{Dom } g.$$

**Theorem 1.1.** *There is a small copy  $\mathcal{M}_0$  of the Mandelbrot set close to  $c(\theta)$  and centered at the main molecule such that the preimages  $\mathcal{M}_n$  of  $\mathcal{M}_0$  as above **scale linearly** at  $c(\theta)$ : the map*

$$(1.2) \quad \mathbf{R}_{\text{prm}}^m : \{c(\theta)\} \cup \bigcup_{n < 0} \mathcal{M}_n \rightarrow \{c(\theta)\} \cup \bigcup_{n \leq 0} \mathcal{M}_n$$

is  $1 + \varepsilon$ -conformal at  $c(\theta)$ . Moreover, for every  $n \leq 0$  we have

- **rigidity:** the set  $\bigcap_{i \geq 0} \text{Dom}(\mathbf{R}_n^i) = \{c_n\}$  is a singleton;
- **JLC:** the Julia set of  $z^2 + c_n$  is locally connected;
- **positive measure:** the Julia set of  $z^2 + c_n$  has positive measure.

In fact, we construct a horseshoe of parameters where local connectivity holds. We also show that  $p_n(z) := z^2 + c_n$  has a forward invariant valuable flower  $X_n$  containing the postcritical set of  $p_n$  such that  $X_n$  is in a small neighborhood of the closed Siegel disk of  $z^2 + c(\theta)$ . This is a partial case of the conjecture on the upper semi-continuity of the mother hedgehog, see [DLS, Appendix C].

There are examples of infinitely renormalizable polynomials with non-locally connected Julia sets [Mi]. The examples are based on near-parabolic effects when small Julia sets are forced not to shrink. This may actually be the only mechanism for non-locally connectivity of the Julia sets in the infinitely renormalizable case. See [H, Mi, J, McM1, L2, KL1, KL2] for classes of locally connected Julia sets. Our results demonstrate that the Julia sets behave nicely near Siegel parameters of bounded type. There is also substantial progress in understanding near-parabolic Julia sets in the Inou-Shishikura class, see [CS, Ch].

It was shown in [Y] that the Julia set of an infinitely renormalizable polynomial  $p$  has measure 0 if the renormalizations of  $p$  stay “sufficiently far away” from the main molecule. Our results indicate that if the renormalizations of  $p$  are close to the Siegel maps, then the Julia set of  $p$  inherits a positive mass from Siegel filled-in Julia sets. Thus, one may expect a certain monotonicity of the measure depending on how far the renormalizations of  $p$  are away from the main hyperbolic component. This is also consistent with the Hubbard conjecture stating that the measure of the filled-in Julia set of every parameter in the main hyperbolic component is at least some universal  $\varepsilon > 0$ . It is recently shown in [DS] that the classical Feigenbaum polynomial has Hausdorff dimension less than 2, and consequently it has measure 0.

**1.3. Outline of the paper.** Consider a hyperbolic pacman renormalization operator  $\mathcal{R}: \mathcal{B} \dashrightarrow \mathcal{B}$  associated with a periodic rotation number  $c(\theta) = \mathbf{R}_{\text{prm}}^m(c(\theta))$ . The operator  $\mathcal{R}$  has a hyperbolic fixed point  $f_\star$  which is a Siegel pacman. We denote by  $\mathcal{W}^u$  and  $\mathcal{W}^s$  the unstable and stable manifolds of  $f_\star$  respectively.

*Global unstable manifold.* Every pacman  $f \in \mathcal{W}^u$  has an associated “maximal prepacman”  $\mathbf{F}$  (see (3.7)) depending analytically on  $f$ . Let  $\mathbf{W}^u$  be the space of maximal prepacmen. The operator  $\mathcal{R}$  acts on  $\mathbf{W}^u$  as the multiplication by  $\lambda_\star$ , where  $\lambda_\star > 1$ . Using the property that  $\mathcal{R}: \mathbf{W}^u \dashrightarrow \mathbf{W}^u$  is an iteration and rescaling (see (3.11)), we can globalize  $\mathbf{W}^u \simeq \mathbb{C}$ . We can also view  $\mathbf{W}^u$  as the space of rescaled limits of quadratic polynomials, see §4.1. Therefore, a zoomed picture of the Mandelbrot set near  $c_\star$  gives a good approximation to  $\mathbf{W}^u$ , see Figure 15.

*Power-triples.* Consider a maximal prepacman  $\mathbf{F} \in \mathcal{W}^u$ , and set  $\mathbf{F}_n := \mathcal{R}^n(\mathbf{F})$ . For  $n \leq 0$  we denote by  $\mathbf{F}_n^\#$  the rescaled version of  $\mathbf{F}_n$  so that  $\mathbf{f}_\pm = \mathbf{f}_{0,\pm}$  are iterates of  $\mathbf{f}_{n,\pm}^\#$ . Given a ‘‘power-triple’’  $P = (n, a, b) \in \mathbb{Z}_{\leq 0} \times \mathbb{Z}_{\geq 0}^2$ , we write

$$\mathbf{F}^P := \left( \mathbf{f}_{n,-}^\# \right)^a \circ \left( \mathbf{f}_{n,+}^\# \right)^b.$$

Since  $\mathbf{f}_{n,+}^\#$  and  $\mathbf{f}_{n,-}^\#$  commute, the order in the composition is irrelevant.

There is a natural equivalence relation on the set of power-triples (see §4.2) such that  $P \simeq Q$  if and only if  $\mathbf{F}^P = \mathbf{F}^Q$ . The set of equivalence classes of power-triples  $\mathbb{T}$  naturally forms an abelian semi-group (see §2.1.2) such that

$$\mathbf{F}^{P+Q} = \mathbf{F}^P \circ \mathbf{F}^Q \quad \text{and} \quad \mathbf{F}^0 = \text{id}, \quad 0 \simeq (n, 0, 0), P, Q \in \mathbb{T}.$$

We view  $\mathbb{T}$  as a dense sub-semigroup of  $(\mathbb{R}_{\geq 0}, +)$ , see Lemma 4.1: given a power-triple  $(n, a, b)$ , the rescaled projection of  $(a, b)$  to the leading eigen-covector of the antirenormalization matrix  $\mathbb{M}$  (see (4.2)) produces a real number associated with  $(n, a, b)$ . We have

$$(1.3) \quad \mathbf{F}_0^P = \left( \mathbf{F}_{-n}^\# \right)^{\mathfrak{t}^n P},$$

where  $\mathfrak{t} > 1$  is the leading eigenvalue of  $\mathbb{M}$ . If  $\mathbf{F} = \mathbf{F}_*$ , then (1.3) takes form

$$(1.4) \quad \mathbf{F}_*^P = A_*^{-n} \circ \left( \mathbf{F}_*^{\mathfrak{t}^n P} \right) \circ A_*^n,$$

where  $A_*: z \mapsto \mu_* z$  is the dynamical self-similarity.

Most of the paper concerns the analyzes of the transcendental cascade  $\mathbf{F}^{\geq 0} = (\mathbf{F}^P)_{P \in \mathbb{T}}$ . Every map  $\mathbf{F}^P$  is a  $\sigma$ -proper map onto  $\mathbb{C}$  whose domain is an open dense subset of  $\mathbb{C}$ . The domain of  $\mathbf{F}^P$  shrinks when  $P$  increases:  $\text{Dom}(\mathbf{F}^{P+Q})$  is the preimage of  $\text{Dom}(\mathbf{F}^Q)$  under  $\mathbf{F}^P: \text{Dom}(\mathbf{F}^P) \rightarrow \mathbb{C}$ .

The cascade  $\mathbf{F}^{\geq 0}$  is combinatorially similar to the cascade of translations  $(T^P)_{P \in \mathbb{T}}$ , where  $T^{(n,a,b)}: z \mapsto z + \mathfrak{t}^{-n}(b\mathfrak{w} - a\mathfrak{v})$  and  $\begin{pmatrix} -\mathfrak{v} \\ \mathfrak{w} \end{pmatrix}$  is an eigenvector of  $\mathbb{M}$ , see §2.1.2. In particular,  $(\mathbf{F}^P | \bar{\mathbf{Z}}_*)_{P \in \mathbb{T}}$  is quasisymmetrically conjugate to  $(T^P)_{P \in \mathbb{T}}$ , where  $\mathbf{Z}_*$  is the Siegel disk of  $\mathbf{F}_*$ , see Lemma 5.2.

*Fatou, Julia, and escaping sets.* The *Fatou set*  $\mathfrak{F}(\mathbf{F})$  of  $\mathbf{F}$  is the set of points where the family  $\{\mathbf{F}^P\}$  is normal. The *Julia set*  $\mathfrak{J}(\mathbf{F})$  is the complement of the Fatou set. The cascade  $\mathbf{F}^{\geq 0}$  has a single critical orbit: the set of critical values of  $\mathbf{F}^P$  is exactly  $\bigcup_{Q < P} \mathbf{F}^Q\{0\}$ . The postcritical set of  $\mathbf{F}^P$  is  $\mathfrak{P}(\mathbf{F}) = \bigcup_{Q \in \mathbb{T}} \mathbf{F}^Q\{0\}$ . The action of  $\mathbf{F}^{\geq 0}$

is proper discontinuous: for every  $P \in \mathbb{T}$  and every  $x \in \mathbb{C}$  the set  $\bigcup_{Q < P} \mathbf{F}^Q\{x\}$  is discrete, see Lemma 4.4.

Given  $P \in \mathbb{T}_{>0}$ , the *P-th escaping set* is

$$\mathbf{Esc}_P(\mathbf{F}) := \mathbb{C} \setminus \text{Dom}(\mathbf{F}^P).$$

The *escaping set* is

$$\mathbf{Esc}(\mathbf{F}) := \bigcup_{P > 0} \mathbf{Esc}_P(\mathbf{F}).$$

Since  $\mathbf{Esc}(\mathbf{F}) \neq \emptyset$ , we have  $\overline{\mathbf{Esc}(\mathbf{F})} = \mathfrak{J}(\mathbf{F})$ , see Corollary 6.8.

*Renormalization triangulations.* We denote by  $(\mathbf{f}_\pm: \mathbf{U}_\pm \rightarrow \mathbf{S})$  the natural embedding of the prepacman  $F = (f_\pm: U_\pm \rightarrow S)$  of  $f \in \mathcal{W}^u$  to the dynamical plane of  $\mathbf{F}$ . The renormalization triangulation  $\Delta_0(\mathbf{F})$  of  $\mathbf{F}$  is the forward orbits of  $\Delta(0) = \overline{\mathbf{U}}_-$  and  $\Delta(1) = \overline{\mathbf{U}}_+$  before they return back to  $\mathbf{S}$ , see §4.3. The action of  $\mathbf{F}^{\geq 0}$  on  $\Delta_0$  is essentially translation (unless the orbit passes through  $\mathbf{S}$ ), see Figure 16.

We say that  $\Delta(\mathbf{F})$  is the *full lift* of  $\Delta_0(f)$  – the triangulation consisting of  $U_\pm(f)$ . Similarly, given an object  $K$  in the dynamical plane of  $f$ , the *full lift*  $\mathbf{K}$  of  $K$  is obtained by embedding  $K$  into the dynamical plane of  $\mathbf{F}$  via  $U \setminus \gamma_1 \simeq \Delta_0(0) \cup \Delta(1)$ , and then by spreading around  $K$  to other triangles of  $\Delta_0$ . Conversely, we say that  $\mathbf{K}$  *projects* to  $K$ .

We define the *n*th renormalization triangulation  $\Delta_n(\mathbf{F})$  to be  $\Delta_0(\mathbf{F}_n^\#)$ ; it is an appropriate rescaling of  $\Delta_0(\mathbf{F}_n)$ .

*The boundary point  $\alpha(\mathbf{F})$ .* We add a boundary point  $\alpha(\mathbf{F})$  to  $\mathbb{C}$  at “ $-i\infty$ ,” see §4.7. We endow  $\mathbb{C} \sqcup \{\alpha\}$  with a “wall topology”: the full lift of an open neighborhood of  $\alpha(f)$  is an open neighborhood of  $\alpha(\mathbf{F})$ .

*Fundamental domains.* The pacman  $f: U \rightarrow V$  is the quotient of  $\mathbf{f}_\pm \mid \Delta(\mathbf{F})$  under the “deck transformation”  $\mathbf{f}_+ \circ \mathbf{f}_-^{-1}$  in the following sense. Let  $\mathbb{P}_0(\mathbf{F}) \subset \Delta_0(\mathbf{F})$  be a “wall” of  $\Delta_0(\mathbf{F})$  – it is a certain thickening of  $\partial\Delta_0(\mathbf{F})$  such that, in particular, points in  $\mathbf{Q}_0(\mathbf{F}) := \Delta_0 \setminus \mathbb{P}_0(\mathbf{F})$  can not jump over  $\mathbb{P}_0(\mathbf{F})$  under  $\mathbf{f}_\pm^{\pm 1}$ . A *fundamental domain* for  $f$  (see Figure 17) is a sector  $\mathbf{S}^{\text{new}}$  with the distinguished left side  $\lambda$  and the distinguished right side  $\rho$  such that

- $\mathbf{S}^{\text{new}}$  coincide with  $\mathbf{S}$  on  $\mathbb{C} \setminus \mathbf{Q}_0$ ;
- $\lambda$  and  $\rho$  land at  $\alpha$ ; and
- $\mathbf{f}_+ \circ \mathbf{f}_-^{-1}$  maps  $\lambda$  to  $\rho$ .

Theorem 4.7 asserts that  $f: U \rightarrow V$  is the quotient of  $\mathbf{f}_\pm: \mathbf{U}_\pm^{\text{new}} \rightarrow \mathbf{S}^{\text{new}}$  under  $\mathbf{f}_+ \circ \mathbf{f}_-^{-1}: \lambda \rightarrow \rho$ , independently of the choice of the fundamental domain.

*The dynamical plane of  $\mathbf{F}_*$ .* By (1.4), the dynamical self-similarity  $A_*: z \mapsto \mu_* z$  conjugates  $\mathbf{F}_*^P$  to  $\mathbf{F}_*^{P^t}$ . This allows us to give an explicit description of the dynamical plane of  $\mathbf{F}_*$ . It has an invariant unbounded Siegel disk  $\mathbf{Z}_*$  – the recalled limit of  $Z_*$ . Every Fatou component  $\mathbf{Z}_i$  of  $\mathbf{F}_*$  is either  $\mathbf{Z}_*$  or a preimage under a certain  $\mathbf{F}^T$  with  $T \in \mathbb{T}_{>0}$ . We prove in §5.5 that  $\mathbf{Z}_i$  is a bounded subset of  $\mathbb{C}$ . Moreover, if  $T$  is minimal, then  $\overline{\mathbf{Z}}_i \cap \mathbf{Esc}_T(\mathbf{F}_*) = \{\alpha_i\}$  is a singleton, and  $\mathbf{F}^T: \mathbf{Z}_i \rightarrow \mathbf{Z}_*$  extends continuously to  $\mathbf{F}^T: \overline{\mathbf{Z}}_i \rightarrow \overline{\mathbf{Z}}_* \cup \{\alpha\}$ . We say that  $\alpha_i$  is an *alpha-point of generation*  $|\alpha_i| := T$ .

Alpha-points are cut points of  $\mathbf{Esc}(\mathbf{F}_*)$ : if  $\alpha_i \in \mathbf{Esc}(\mathbf{F}_*)$ , then  $\mathbf{Esc}(\mathbf{F}_*) \setminus \{\alpha_i\}$  has two bounded components and one unbounded, see Figure 24. Moreover, there is a unique curve in  $\mathbf{Esc}(\mathbf{F}_*)$  connecting two alpha-points. We write  $\alpha_i \succ \alpha_j$  if  $\alpha_i$  is in one of the bounded components of  $\mathbf{Esc}(\mathbf{F}_*) \setminus \{\alpha_j\}$ . It follows that  $|\alpha_i| > |\alpha_j|$  and, moreover, there is a unique simple arc  $[\alpha_i, \alpha_j] \subset \mathbf{Esc}(\mathbf{F}_*)$  connecting  $\alpha_i$  and  $\alpha_j$ . We say that  $[\alpha_i, \alpha_j]$  is a *ray segment*. An *external ray* is a maximal concatenation of ray segments, see §5.9. External rays have a tree structure: every two external rays eventually meet.

*External rays for  $\mathbf{F}$ .* We show in §6 that the escaping set  $\mathbf{Esc}_P(\mathbf{F})$  is the set of accumulation points of  $\mathbf{F}^{-P}(x)$ . Therefore,  $\mathbf{Esc}_P(\mathbf{F})$  moves holomorphically unless it hits a critical point. In particular, external rays are well-defined (unless they hit a precritical point) for  $\mathbf{F} \in \mathcal{W}^u$  and depend holomorphically on  $\mathbf{F}$ .

*Parabolic pacmen.* Consider a rational number  $\tau = p/q$  close to  $\theta$  and let  $f_\tau$  be the parabolic pacman with rotation number  $\tau$ . An attracting basin of  $\alpha(f_\tau)$  admits the globalization  $\mathbf{H}$  in the dynamical plane of  $\mathbf{F}_\tau$ , see §3.2.14. It was shown in [DLS, §6] that  $\mathbf{H}$  contains the critical orbit. Periodic components of  $\mathbf{H}$  are attached to  $\alpha(\mathbf{F}_\tau)$  and are enumerated as  $(\mathbf{H}^i)_{i \in \mathbb{Z}}$  from left-to-right with  $\mathbf{H}^0 \ni 0$ . We denote by  $Q(\tau) \in \mathbb{T}_{>0}$  the period of  $\mathbf{H}^i$ .

We show in §7 that a certain periodic cycle of external rays  $(\mathbf{R}^i)_{i \in \mathbb{Z}}$  lands at  $\alpha$ . This way we obtain a puzzle partition; we denote by  $\mathbf{W}$  the puzzle piece containing  $\mathbf{H}^0$ , see Figure 32. Let  $\mathbf{W}^1$  be the pullback of  $\mathbf{W}$  along  $\mathbf{F}_\tau^{Q(\tau)}: \mathbf{H}^0 \rightarrow \mathbf{H}^0$ . We obtain a two-to-one “pinched quadratic-like” map

$$(1.5) \quad \mathbf{F}_\tau^{Q(\tau)}: \mathbf{W}^1 \rightarrow \mathbf{W}$$

and we call it the *primary renormalization map*.

*Small copies of the Mandelbrot set.* Puzzle technique allows us to control a parabolic bifurcation at  $\mathbf{F}_\tau$ ; we will show (see Figure 39) that there is

- a primary satellite hyperbolic component  $\Delta_\tau \subset \mathcal{W}^u$  attached to  $\mathbf{F}_\tau$ ;
- a secondary satellite hyperbolic component  $\Delta_{\tau,s} \subset \mathcal{W}^u$  attached to  $\partial\Delta_\tau$ ;
- and
- a ternary small copy of the Mandelbrot set  $\mathcal{M}_0 = \mathcal{M}_{\tau,s,t} \subset \mathcal{W}^u$  attached to  $\partial\Delta_{\tau,s}$ , see Theorem 7.9.

We set  $\mathcal{M}_n := \mathcal{R}^n(\mathcal{M}_0)$  and we denote by  $\mathcal{M}_n \subset \mathcal{W}^u$  the set of pacmen  $g \in \mathcal{W}^u$  with  $\mathbf{G} \in \mathcal{M}_n$ . We obtain a sequence of small copies of the Mandelbrot set  $\mathcal{M}_n \subset \mathcal{W}^u$  invariant under the antirenormalization.

*Valuable flowers.* A map  $g \in \mathcal{M}_n$  is encoded by its “valuable flower”  $X(g)$  around  $\alpha(g)$ , where  $X(g)$  is the “combinatorial connected hull” of the cycle of secondary small filled-in Julia sets, see §8.2. The flower  $X(g)$  is in a small neighborhood of  $\bar{Z}_*$  and depend upper semicontinuously on  $g$ .

For every  $g \in \mathcal{M}_n$ , there is a unique quadratic polynomial  $p \in \mathcal{M}$  such that  $p$  has a valuable flower  $X(p)$  and  $g$  and  $p$  are hybrid conjugate in neighborhoods of their valuable flowers  $X(g)$  and  $X(p)$ . In this way,  $\mathcal{M}_n$  is associated with the small copy  $\mathcal{M}_n \subset \mathcal{M}$  containing all  $p = p(g)$  with  $g \in \mathcal{M}_n$ .

*A stable lamination.* There is a natural codimension-one lamination  $\mathcal{F}_n$  in a small neighborhood of  $\mathcal{M}_n$  characterized by the property that pacmen in the same leaf are hybrid conjugate in neighborhoods of their valuable flowers, see §9.1. For  $m \leq n$  we define  $\mathcal{F}_m$  to be the pullback of  $\mathcal{F}_n$  under  $\mathcal{R}^{n-m}$ . By hyperbolicity of  $\mathcal{R}$ ,

$$\mathcal{F} := \bigcup_{m \leq n} \mathcal{F}_m \cup \{\mathcal{W}^s\}$$

forms a codimension-one lamination.

*Proof of the main results (outline).* Theorem 1.1 essentially follows from the hyperbolicity of  $\mathcal{R}$  combined with the holonomy along  $\mathcal{F}$ . The stable manifold  $\mathcal{W}^s$  intersects the slice of quadratic polynomials  $\mathcal{Q}$  at  $c(\theta)$ . For  $n \ll 0$ , the intersection of  $\mathcal{F}_n$  with the slice  $\mathcal{Q}$  is the ternary copy  $\mathcal{M}_n$  of the Mandelbrot set. The map  $\mathbf{R} := \mathbf{R}_{\text{prm}}^m$  from (1.2) factorizes as  $\mathcal{R} \mid \mathcal{Q}$  postcompose with the holonomy along  $\mathcal{F}$  bringing  $\mathcal{R}(\mathcal{Q}) \cap \mathcal{F}$  back to  $\mathcal{Q}$ . Since the holonomy is asymptotically conformal, the hyperbolicity of  $\mathcal{R}$  implies the scaling theorem.

For  $k < n$ , we have  $\mathbf{R}_k = \mathbf{R}_n \circ \mathbf{R}^{n-k}$ . Since

$$\mathbf{R}^{n-k}(c(\theta) + z) \approx c(\theta) + \lambda_\star^{n-k}z, \quad \lambda_\star > 1$$

is expanding, the composition  $\mathbf{R}_n \circ \mathbf{R}^{n-k} = \mathbf{R}_k$  is expanding for  $k \ll n$ . This implies the rigidity theorem.

In the dynamical plane of  $p_n(z) := z^2 + c_n$ , there is a dynamical scaling near the critical value, thus  $p_n$  enjoys *a priori* bounds (in fact, uniformly over  $n$ ). This implies JLC for  $p_n$ .

For  $n \ll 0$ , the map  $p_n$  inherits geometric properties of  $p_\star(z) := z^2 + c(\theta)$ . In particular, the Julia set of  $p_n$  inherits the positive measure from the filled-in Julia set of  $p_\star$ , and the postcritical set of  $p_n$  tends to the postcritical set of  $p_\star$ .

**1.4. Conventions and Notations.** We denote a pacman by a lowercase letter (for example  $f$  or  $g$ ), its bold capital version denotes the corresponding maximal prepacman (resp  $\mathbf{F}$  or  $\mathbf{G}$ ). Objects in the dynamical planes of maximal prepacmen are often written in bold script. Objects in the parameter plane are usually written in calligraphic script.

For a pacman  $f$  we write  $f_n = \mathcal{R}^n f$  if  $f$  is in the domain of  $\mathcal{R}^n$ ; in particular  $f_0 = f$ . If  $f \in \mathcal{W}^u$ , then  $f_n$  are well-defined for all  $n \leq 0$ . The corresponding maximal prepacmen are denoted by  $\mathbf{F}_n$ .

To keep notations simple, we will often suppress indices. For example, we denote a pacman by  $f : U_f \rightarrow V$ , however a pacman indexed by  $i$  is denoted as  $f_i : U_i \rightarrow V$  instead of  $f_i : U_{f_i} \rightarrow V$ .

We will suppress “ $\star$ ” in §5. For example,  $\mathbf{F}$  denotes the fixed maximal prepacman  $\mathbf{F}_\star$ .

We denote by

- $\overline{\mathbb{D}}(a, r)$  the closed disk around  $a \in \mathbb{C}$  with radius  $r$ ;
- $\overline{\mathbb{D}}(r) := \overline{\mathbb{D}}(0, r)$  and  $\overline{\mathbb{D}} := \overline{\mathbb{D}}(0, 1)$ ;
- $\mu_\star$  and  $\lambda_\star$  the dynamical and parameter self-similarity constants with  $|\lambda_\star| > 1$  and  $|\mu_\star| < 1$ ;
- $f_\star \in \mathcal{W}^u$  a fixed pacman:  $f_\star = \mathcal{R}(f_\star)$ ;
- $c_0$  and  $c_1$  the critical point and the critical value of a pacman  $f$ ;
- $Z_f$  is the Siegel disk of a Siegel map  $f$ ;
- $T_c : z \rightarrow z + c$  the translation by  $c \in \mathbb{C}$ ;
- $A_c : z \rightarrow cz$  the scaling by  $c \in \mathbb{C} \setminus \{0\}$ ;
- $A_\star = A_{\mu_\star}$ ; and
- $\mathbf{e} : z \mapsto e^{2\pi iz}$ .

By a *tree* in an open set  $U \subset \mathbb{C}$  we mean an increasing union of finite trees  $T_1 \subset T_2 \subset \dots$  such that  $T_i \setminus T_{i-1}$  does not intersect any given compact subset of  $U$  for  $i \gg 0$ . A *forest* and a *graph* are defined similarly.

We write  $f \asymp g$  if positive functions  $f$  and  $g$  are comparable:  $1/C \leq \frac{f(x)}{g(x)} \leq C$  for a constant  $C$  independent of  $x$ .

We often write a partial map as  $f : W \dashrightarrow W$ ; this means that  $\text{Dom } f \cup \text{Im } f \subset W$ .

A *simple arc* is an embedding a closed interval. We often say that a simple arc  $\ell : [0, 1] \rightarrow \mathbb{C}$  connects  $\ell(0)$  and  $\ell(1)$ . A *simple closed curve* or a *Jordan curve* is an embedding of the unit circle. A *simple curve* is either a simple closed curve or a simple arc.



A *closed topological disk* is a subset of a plane homeomorphic to the closed unit disk. In particular, the boundary of a closed topological disk is a Jordan curve. A *quasidisk* is a closed topological disk qc-homeomorphic to the closed unit disk.

Given a subset  $U$  of the plane, we denote by  $\text{int } U$  the interior of  $U$ .

Let  $U$  be a closed topological disk. For simplicity we say that a homeomorphism  $f: U \rightarrow \mathbb{C}$  is *conformal* if  $f|_{\text{int } U}$  is conformal. Note that if  $U$  is a quasidisk, then such an  $f$  admits a qc extension through  $\partial U$ .

A *closed sector*, or *topological triangle*  $S$  is a closed topological disk with two distinguished simple arcs  $\gamma_-, \gamma_+$  in  $\partial S$  meeting at the *vertex*  $v$  of  $S$  satisfying  $\{v\} = \gamma_- \cap \gamma_+$ . Suppose further that  $\gamma_-, \text{int } S, \gamma_+$  have clockwise orientation at  $v$ . Then  $\gamma_-$  is called the *left boundary* of  $S$  while  $\gamma_+$  is called the *right boundary* of  $S$ . A closed *topological rectangle* is a closed topological disk with four marked sides.

Let  $f: (W, \alpha) \rightarrow (\mathbb{C}, \alpha)$  be a holomorphic map with a distinguished  $\alpha$ -fixed point. We will usually denote by  $\lambda$  the multiplier at the  $\alpha$ -fixed point. If  $\lambda = e(\phi)$  with  $\phi \in \mathbb{R}$ , then  $\phi$  is called the *rotation number* of  $f$ . If, moreover,  $\phi = \mathbf{p}/\mathbf{q} \in \mathbb{Q}$ , then  $\mathbf{p}/\mathbf{q}$  is also the *combinatorial rotation number*: there are exactly  $\mathbf{q}$  local attracting petals at  $\alpha$  and  $f$  maps the  $i$ -th petal to  $i + \mathbf{p}$  counting counterclockwise.

Consider a continuous map  $f: U \rightarrow \mathbb{C}$  and let  $S \subset \mathbb{C}$  be a connected set. An  *$f$ -lift* is a connected component of  $f^{-1}(S)$ . Let

$$x_0, x_1, \dots, x_n, \quad x_{i+1} = f(x_i)$$

be an  $f$ -orbit with  $x_n \in S$ . The connected component of  $f^{-n}(S)$  containing  $x_0$  is called the *pullback of  $S$  along the orbit  $x_0, \dots, x_n$* .

Consider two partial maps  $f: X \dashrightarrow X$  and  $g: Y \dashrightarrow Y$ . A homeomorphism  $h: X \rightarrow Y$  is *equivariant* if

$$(1.6) \quad h \circ f(x) = g \circ h(x)$$

for all  $x$  with  $x \in \text{Dom } f$  and  $h(x) \in \text{Dom } g$ . If (1.6) holds for all  $x \in T$ , then we say that  $h$  is *equivariant on  $T$* .

We will usually denote an analytic renormalization operator as “ $\mathcal{R}$ ”, i.e.  $\mathcal{R}f$  is a renormalization of  $f$  obtained by an analytic change of variables. A renormalization postcompose with a straightening will be denoted by “ $\mathbf{R}$ ”; for example,  $\mathbf{R}_s: \mathcal{M}_s \rightarrow \mathcal{M}$  is the Douady-Hubbard straightening map from a small copy  $\mathcal{M}_s$  of  $\mathcal{M}$  to the Mandelbrot set. The action of the renormalization operator on the rotation numbers will be denoted by “ $R$ ”.

Slightly abusing notations, we will often identify a lamination (or a triangulation) with its support. Given a triangulation  $\Delta$ , we denote by  $\Delta(i)$  its  $i$ -th triangle;

$\Delta(i, i+1, \dots, i+j)$  denotes the union  $\bigcup_{k=0}^j \Delta(i+k)$ .

**Acknowledgments.** The first author was partially supported by Simons Foundation grant of the IMS and ERC grant “HOLOGRAM”. The second author thanks the NSF for their continuing support.

We also thank Artur Avila for stimulating a discussion of the area problem.

The results of this paper were announced at the conference in memory of Yoccoz, May 2017, Collège de France (Paris).

A number of our pictures are made with W. Jung’s program *Mandel*.

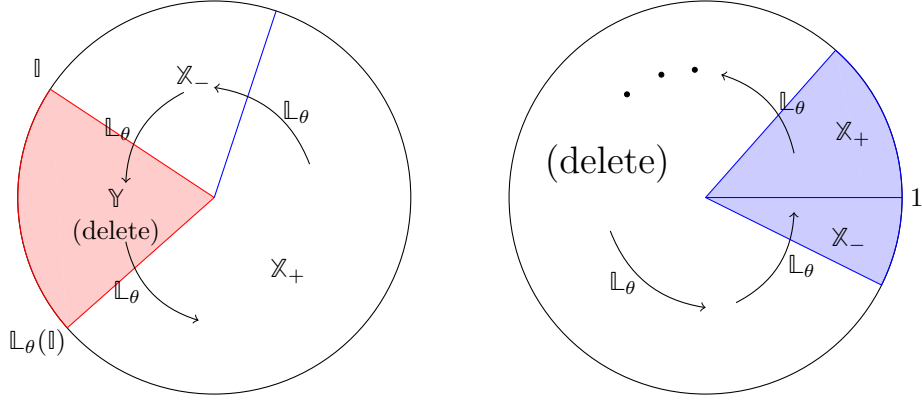

FIGURE 2. Left: the prime renormalization deletes the smallest sector  $\Upsilon$  between  $\mathbb{l}$  and  $\mathbb{L}_\theta(\mathbb{l})$  and projects  $(\mathbb{L}_\theta^2 | \mathbb{X}_-, \mathbb{L}_\theta | \mathbb{Y}_+)$  to a new rotation. Right: more generally, a sector renormalization realizes the first return map to a sector  $\mathbb{X}_- \cup \mathbb{X}_+$

## 2. SECTOR RENORMALIZATION

In this section we refine the discussion of the sector renormalization from [DLS, Appendices A and B].

**2.1. Sector renormalization of rotations.** Consider the rotation of the unit disk

$$(2.1) \quad \mathbb{L}_\theta: \overline{\mathbb{D}} \rightarrow \overline{\mathbb{D}}, \quad z \rightarrow e(\theta)z$$

by an angle  $\theta \in \mathbb{R}/\mathbb{Z}$ . Choose a closed internal ray  $\mathbb{l}$  of  $\overline{\mathbb{D}}$ , and let  $\Upsilon \subset \overline{\mathbb{D}}$  be the smallest closed sector between  $\mathbb{l}$  and  $\mathbb{L}_\theta(\mathbb{l})$ , see the left side of Figure 2. Consider

$$\mathbb{X}_- := \mathbb{L}_\theta^{-1}(\Upsilon) \quad \text{and} \quad \mathbb{X}_+ := \overline{\mathbb{D} \setminus (\Upsilon \cup \mathbb{X}_-)}.$$

Then

$$(2.2) \quad (\mathbb{L}_\theta | \mathbb{X}_+, \mathbb{L}_\theta^2 | \mathbb{X}_-)$$

is the first return of points in  $\mathbb{X}_- \cup \mathbb{X}_+$  back to  $\mathbb{X}_- \cup \mathbb{X}_+$ . Let  $\omega \in [0, 1/2]$  be the angle of  $\Upsilon$  at the vertex 0. Assuming  $1 \notin \Upsilon$ , the map  $z \rightarrow z^{1/(1-\omega)}$  projects (2.2) to a new rotation  $\mathbb{L}_{R_{\text{prm}}(\theta)}: \overline{\mathbb{D}} \rightarrow \overline{\mathbb{D}}$ , called the *prime renormalization* of  $\mathbb{L}_\theta$ . Direct calculations (see [DLS, Lemma A.1]) shows that

$$(2.3) \quad R_{\text{prm}}(\theta) = \begin{cases} \frac{\theta}{1-\theta} & \text{if } 0 \leq \theta \leq \frac{1}{2}, \\ \frac{2\theta-1}{\theta} & \text{if } \frac{1}{2} \leq \theta \leq 1. \end{cases}$$

More generally, a *sector renormalization*  $\mathcal{R}$  of  $\mathbb{L}_\theta$  is (see Figure 2)

- a *renormalization* sector  $\mathbb{X}$  presented as a union of two subsectors  $\mathbb{X}_- \cup \mathbb{X}_+$  normalized so that  $1 \in \mathbb{X}_- \cap \mathbb{X}_+$ ;
- a pair of iterates, called a *sector pre-renormalization*,

$$(2.4) \quad (\mathbb{L}_\theta^{\mathbf{a}} | \mathbb{X}_-, \mathbb{L}_\theta^{\mathbf{b}} | \mathbb{X}_+)$$

realizing the first return of points in  $\mathbb{X}_- \cup \mathbb{X}_+$  back to  $\mathbb{X}$ ; and

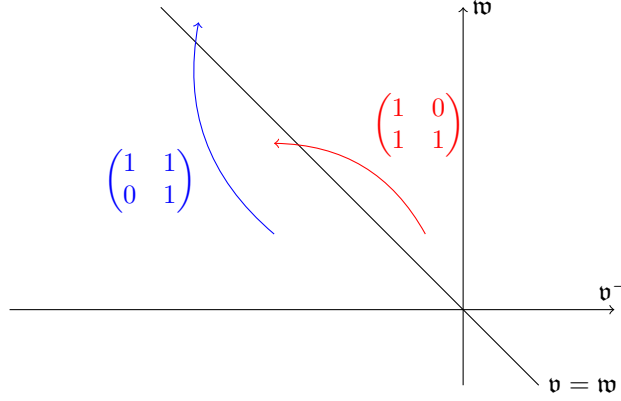

FIGURE 3. The map  $R_{\text{prm}}$  is 2-to-1 on  $\mathbb{R}_{\leq 0} \times \mathbb{R}_{\geq 0}$ ; it maps two  $1/8$ -subsectors to  $\mathbb{R}_{\leq 0} \times \mathbb{R}_{\geq 0}$ .

- the gluing map

$$\psi: \mathbb{X}_- \cup \mathbb{X}_+ \rightarrow \overline{\mathbb{D}}, \quad z \rightarrow z^{1/\omega},$$

projecting (2.4) to a new rotation  $\mathbb{L}_\mu$ , where  $\omega$  is the angle of  $\mathbb{X}$  at 0.

A sector renormalization is an iteration of a prime renormalization (see [DLS, Lemma A.2]); in particular,  $\mu = R_{\text{prm}}^m(\theta)$  for some  $m \geq 1$ .

2.1.1. *Renormalization of pairs of translations.* Let us now lift these renormalizations of rotations to the universal cover of  $\overline{\mathbb{D}}^* := \overline{\mathbb{D}} \setminus \{0\}$ . Write

$$\mathbb{H}_- := \{z \mid \text{Im}(z) < 0\}.$$

The translations

$$T_{\mathbf{v}^-} = T_{-\mathbf{v}} := T_\theta: z \mapsto z - \theta, \quad T_{\mathbf{w}} := T_{1-\theta}: z \mapsto z + 1 - \theta$$

are two lifts of  $\mathbb{L}_\theta: \overline{\mathbb{D}}^* \rightarrow \overline{\mathbb{D}}^*$  under

$$(2.5) \quad \mathbf{e}_-: z \mapsto e^{-2\pi iz}: \overline{\mathbb{H}}_- \rightarrow \overline{\mathbb{D}}^*.$$

Since  $\chi := T_{\mathbf{w}} \circ T_{\mathbf{v}^-}^{-1}$  is a deck transformation of (2.5), we have  $\mathbb{L}_\theta \simeq T_{-\mathbf{v}} / \langle \chi \rangle$  as a map on  $\overline{\mathbb{D}}^*$ .

For a non-zero vector  $\begin{pmatrix} \mathbf{v}^- \\ \mathbf{w} \end{pmatrix} = \begin{pmatrix} -\mathbf{v} \\ \mathbf{w} \end{pmatrix}$  in  $\mathbb{R}_{\leq 0} \times \mathbb{R}_{\geq 0}$  write, (see Figure 3)

$$(2.6) \quad \begin{pmatrix} -\mathbf{v}_1 \\ \mathbf{w}_1 \end{pmatrix} = \begin{pmatrix} \mathbf{v}_1^- \\ \mathbf{w}_1 \end{pmatrix} = R_{\text{prm}} \begin{pmatrix} \mathbf{v}^- \\ \mathbf{w} \end{pmatrix} := \begin{cases} \begin{pmatrix} \mathbf{v}^- + \mathbf{w} \\ \mathbf{w} \end{pmatrix} & \text{if } \mathbf{v} \geq \mathbf{w}, \\ \begin{pmatrix} \mathbf{v}^- \\ \mathbf{w} + \mathbf{v}^- \end{pmatrix} & \text{if } \mathbf{w} > \mathbf{v}. \end{cases}$$

and observe that (2.3) is the *projectivization* of (2.6) via

$$(2.7) \quad \begin{pmatrix} -\mathbf{v} \\ \mathbf{w} \end{pmatrix} \rightarrow \frac{\mathbf{v}}{\mathbf{v} + \mathbf{w}} =: \theta \in \mathbb{R}/\mathbb{Z}.$$

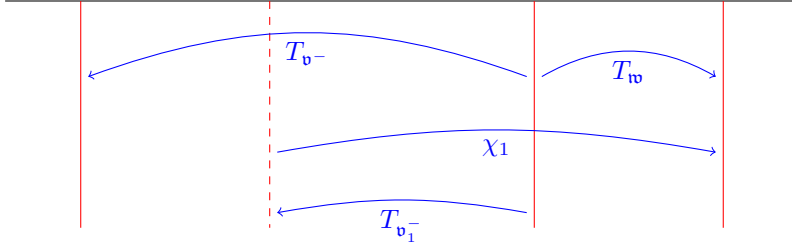

FIGURE 4. The prime pre-renormalization of a pair of translations  $T_{v^-}$ ,  $T_w$  replaces  $T_{v^-}$  with  $T_{v_1^-} := T_{v^-} \circ T_w$  if  $v \geq w$ ; in this case the new deck transformation is  $\chi_1 = T_v = T_{w_1} \circ T_{v_1}^{-1}$ .

The *prime pre-renormalization* of the commuting pair  $T_{v^-}$ ,  $T_w$  with  $v^-, w \in \mathbb{R}_{\leq 0} \times \mathbb{R}_{\geq 0}$  is the commuting pair

$$(T_{v_1^-}, T_{w_1}) = \mathcal{R}_{\text{prm}}(T_{v^-}, T_w);$$

it is obtained (see Figure 4) by replacing  $T_{v^-}$  with  $T_{v^-} \circ T_w$  if  $v \geq w$ , and by replacing  $T_w$  with  $T_{v^-} \circ T_w$  otherwise. We denote by  $\chi_1 := T_{w_1} \circ T_{v_1}^{-1}$  the new deck transformation. If  $\mathbb{L}_\theta \simeq T_{v^-} / \langle \chi \rangle$  (i.e. (2.7) holds), then  $\mathbb{L}_{R_{\text{prm}}(\theta)} \simeq T_{v_1^-} / \langle \chi_1 \rangle$  as a map on  $\overline{\mathbb{D}}^*$ .

Let us now consider an iteration of (2.6). Recall that matrices  $\begin{pmatrix} 1 & 1 \\ 0 & 1 \end{pmatrix}$  and  $\begin{pmatrix} 1 & 0 \\ 1 & 1 \end{pmatrix}$  generate the modular group  $\text{SL}_2(\mathbb{Z})$ . We write

$$\text{SL}_2^{(m)}(\mathbb{Z}) := \left\{ I_1 I_2, \dots, I_m \mid I_i \in \left\{ \begin{pmatrix} 1 & 1 \\ 0 & 1 \end{pmatrix}, \begin{pmatrix} 1 & 0 \\ 1 & 1 \end{pmatrix} \right\} \right\},$$

and we denote by  $\text{SL}_2^+(\mathbb{Z}) = \bigcup_{m \geq 0} \text{SL}_2^{(m)}(\mathbb{Z})$  the “positive” sub-semigroup of  $\text{SL}_2(\mathbb{Z})$ .

The quadrant  $\mathbb{R}_{\leq 0} \times \mathbb{R}_{\geq 0}$  splits into  $2^m$  equal closed sectors so that on each sector  $S$  the map  $R_{\text{prm}}^m$  is equal to

$$(2.8) \quad x \mapsto \mathbb{M}x: \quad S \rightarrow \mathbb{R}_{\leq 0} \times \mathbb{R}_{\geq 0}$$

for a certain  $\mathbb{M} \in \text{SL}_2^{(m)}(\mathbb{Z})$ . (As a consequence,  $\text{SL}_2^+(\mathbb{Z})$  is a free semigroup.)

Since  $S$  is a proper subsector of  $\mathbb{R}_{\leq 0} \times \mathbb{R}_{\geq 0}$ , the operator (2.8) has an eigenvector  $\begin{pmatrix} v^- \\ w \end{pmatrix} \in S$ , unique up to scaling. Note that  $v = -v^-$ ,  $w > 0$  unless  $S$  is a boundary sector containing either  $\begin{pmatrix} -1 \\ 0 \end{pmatrix}$  or  $\begin{pmatrix} 0 \\ 1 \end{pmatrix}$ ; in that case  $\mathbb{M} \in \left\{ \begin{pmatrix} 1 & n \\ 0 & 1 \end{pmatrix}, \begin{pmatrix} 1 & 0 \\ n & 1 \end{pmatrix} \right\}$ .

We assume that  $S$  is not a boundary sector. Then all the entries of  $\mathbb{M}$  are positive and  $\mathbb{M}$  has two eigenvalues  $t > 1$  and  $1/t < 1$  so that

$$(2.9) \quad \begin{pmatrix} v_1^- \\ w_1 \end{pmatrix} := 1/t \begin{pmatrix} v^- \\ w \end{pmatrix} = \mathbb{M} \begin{pmatrix} v^- \\ w \end{pmatrix}.$$

Writing  $\theta = \frac{v}{v+w}$ , we see that  $\theta = R_{\text{prm}}^m(\theta)$ , and we say that  $\mathbb{M}$  is the *antirenormalization matrix* associated with  $\theta = R_{\text{prm}}^m(\theta)$ . It is easy to see that all periodic points of  $R_{\text{prm}}^m$  arise from the above construction.

**Lemma 2.1.** *For  $\theta$  and  $\mathfrak{t}$  as above, we have*

$$(R_{\text{prm}}^m)'(\theta) = \mathfrak{t}^2.$$

*Proof.* We can view  $\theta$  as a fixed point of the Möbius transformation induced by  $\mathbb{M}$ ; its derivative  $(R_{\text{prm}}^m)'(\theta)$  is equal to  $\mathfrak{t}^2$ .

Equivalently, direct calculations show that if  $\begin{pmatrix} \mathfrak{v}_1^- \\ \mathfrak{w}_1 \end{pmatrix} = R_{\text{prm}} \begin{pmatrix} \mathfrak{v}^- \\ \mathfrak{w} \end{pmatrix}$ , then

$$R'_{\text{prm}} \left( \frac{\mathfrak{v}}{\mathfrak{v} + \mathfrak{w}} \right) = \left( \frac{\mathfrak{v} + \mathfrak{w}}{\mathfrak{v}_1 + \mathfrak{w}_1} \right)^2.$$

If (2.9) holds, then  $\frac{\mathfrak{v} + \mathfrak{w}}{\mathfrak{v}_1 + \mathfrak{w}_1} = \mathfrak{t}$  and the claim follows.  $\square$

2.1.2. *Cascade*  $(T^P)_{P \in \mathbb{T}}$ . Let us fix  $\mathfrak{v}, \mathfrak{w}, \theta, m, \mathfrak{t}, \mathbb{M}$  as above so that, in particular, (2.9) holds. Observe that  $\mathfrak{t} \notin \mathbb{Q}$ , because  $\mathfrak{t} > 1$ ,  $\det \mathbb{M} = 1$ , but the entrances of  $\mathbb{M}$  are positive integers. We set  $R := R_{\text{prm}}^m$ . For  $n \in \mathbb{Z}$ , write

$$\mathfrak{v}_n := \mathfrak{t}^{-n} \mathfrak{v}, \quad \mathfrak{w}_n := \mathfrak{t}^{-n} \mathfrak{w};$$

then  $(T_{\mathfrak{v}_n^-}, T_{\mathfrak{w}_n})_{n \in \mathbb{Z}}$  is the full pre-renormalization tower:

$$(2.10) \quad \mathcal{R} \left( T_{\mathfrak{v}_n^-}, T_{\mathfrak{w}_n} \right) = \left( T_{\mathfrak{v}_{n+1}^-}, T_{\mathfrak{w}_{n+1}} \right),$$

where  $\mathcal{R} = \mathcal{R}_{\text{prm}}^m$ .

For an abelian semigroup

$$\mathbb{T}^n := \{(n, a, b) \mid a, b \in \mathbb{Z}_{\geq 0}\} \simeq \mathbb{Z}_{\geq 0}^2$$

we define the monomorphism

$$\sigma_n: \mathbb{T}^n \hookrightarrow \mathbb{T}^{n-1}: (n, (a, b)) \mapsto (n-1, (a, b)\mathbb{M}).$$

For a *power-triple*  $(n, a, b) \in \mathbb{Z} \times \mathbb{Z}_{\geq 0} \times \mathbb{Z}_{\geq 0}$  we write

$$(2.11) \quad T^{(n, a, b)} := T_{\mathfrak{v}_n^-}^a \circ T_{\mathfrak{w}_n}^b = T_{\mathfrak{t}^{-n}(b\mathfrak{w} - a\mathfrak{v})},$$

(Later on the non-invertible maximal prepacman  $(\mathbf{f}_{n,-}^\#, \mathbf{f}_{n,+}^\#)$  will play the role of  $(T_{\mathfrak{v}_n^-}, T_{\mathfrak{w}_n})$ .)

Observe that

$$(2.12) \quad T^{(n, a, b)} = T^{\sigma_n(n, a, b)}.$$

Indeed,  $T^{(n, a, b)}$  is the translation by

$$(a, b) \begin{pmatrix} \mathfrak{v}_n^- \\ \mathfrak{w}_n \end{pmatrix} = (a, b) \left( \mathbb{M} \begin{pmatrix} \mathfrak{v}_{n-1}^- \\ \mathfrak{w}_{n-1} \end{pmatrix} \right) = ((a, b)\mathbb{M}) \begin{pmatrix} \mathfrak{v}_{n-1}^- \\ \mathfrak{w}_{n-1} \end{pmatrix};$$

thus  $T^{(n, a, b)} = T^{(n-1, (a, b)\mathbb{M})}$ .

We define the *semi-group of power-triples* as the direct limit

$$(2.13) \quad \mathbb{T} := \varinjlim \mathbb{T}^n = \{(x_i)_{i \leq k} \mid k \in \mathbb{Z}, \sigma_i(x_i) = x_{i-1}\}.$$

We also write  $\mathbb{T} = \bigcup_{n \in \mathbb{Z}} \mathbb{T}^n = \{(n, a, b) \in \mathbb{Z} \times \mathbb{Z}_{\geq 0}^2\} / \sim$ . By (2.12),  $\mathbb{T}$  acts naturally on  $\mathbb{R}$  by translations; i.e.  $(T^P)_{P \in \mathbb{T}}$  is a *cascade*.

**Lemma 2.2.** *The action of  $\mathbb{T}$  on  $\mathbb{R}$  is free:  $T^{(n,a,b)} = T^{(m,c,d)}$  if and only if*

$$(2.14) \quad (a, b)\mathbb{M}^n = (c, d)\mathbb{M}^m.$$

Let  $e_t \in \mathbb{R}_{>0}^2, e_{1/t} \in \mathbb{R}_{<0} \times \mathbb{R}_{>0}$  be the eigen-covectors (viewed as rows) of the eigenvalues  $t$  and  $1/t$  of  $\mathbb{M}$ :

$$e_t \mathbb{M} = t e_t, \quad e_{1/t} \mathbb{M} = (1/t) e_{1/t}.$$

Decompose every covector  $\omega \in \mathbb{R}_{\geq 0}^2$  as

$$\omega = \text{proj}_t(\omega) e_t + \text{proj}_{1/t}(\omega) e_{1/t}, \quad \text{proj}_t(\omega) \in \mathbb{R}_{\geq 0}, \quad \text{proj}_{1/t}(\omega) \in \mathbb{R}.$$

Then

$$\iota(n, a, b) := t^n \text{proj}_t \begin{pmatrix} a \\ b \end{pmatrix}$$

induces an embedding of  $\mathbb{T}$  into  $\mathbb{R}_{\geq 0}$  such that

$$\iota(n-1, a, b) = \iota(n, a, b)/t.$$

View now  $\mathbb{T}$  as a sub-semigroup of  $\mathbb{R}_{\geq 0}$ . This turns  $\mathbb{T}$  into a linearly ordered semi-group with subtraction:

$$\text{if } P \geq T, \quad \text{then } P - T \in \mathbb{T}, \quad P, T \in \mathbb{T} \subset \mathbb{R}_{\geq 0};$$

$P \mapsto tP: (n, a, b) \mapsto (n+1, a, b)$  is an automorphism of  $\mathbb{T}$ ; and:

$$(2.15) \quad T^P = A_{t^{-n}} \circ (T^{t^n P}) \circ A_{t^n}.$$

*Proof.* If the action of  $\mathbb{T}$  on  $\mathbb{R}$  is not free, then there are  $(n, a, b) \neq (n, c, d)$  such that  $T^{(n,a,b)} = T^{(n,c,d)}$ ; this is equivalent to  $(a-c)\mathbf{v}^- + (b-d)\mathbf{w} = 0$ . Since  $t \notin \mathbb{Q}$ , the coordinates  $\mathbf{v}^-$  and  $\mathbf{w}$  are rationally independent. Therefore,  $a = c$  and  $b = d$ .

Clearly,  $\iota: \mathbb{T} \rightarrow \mathbb{R}_{\geq 0}$  is a homomorphism such that  $\iota(n-1, a, b) = \iota(n, a, b)/t$ . If  $\iota$  was not an embedding, then there would be  $(a, b) \neq (c, d) \in \mathbb{Z}_{\geq 0}^2$  with  $\text{proj}_t(a, b) = \text{proj}_t(c, d)$ ; i.e.  $(a-c, b-d)$  is a non-zero integer covector parallel to  $e_{1/t}$ . This is impossible because coordinates of  $e_{1/t}$  are rationally independent.

If  $\iota(n, a, b) > \iota(n, c, d)$ , then for sufficiently big  $m \gg 0$  the covector

$$\begin{aligned} (a_m, b_m) &:= (a-c, b-d) \mathbb{M}^m \\ &= t^m \text{proj}_t(a-c, b-d) e_t + t^{-m} \text{proj}_{1/t}(a-c, b-d) e_{1/t} \end{aligned}$$

has positive coordinates because  $t > 1$  and  $\text{proj}_t(a-c, b-d) = \iota(n, a, b) - \iota(n, c, d) > 0$ . Therefore,  $(n, a, b) - (n, c, d) \simeq (n-m, a_m, b_m) \in \mathbb{T}$ . The remaining claims follow immediately from the definitions.  $\square$

**2.1.3. Renormalization tilings.** Consider the following closed intervals

$$J_0(0) := [-\mathbf{v}, 0], \quad J_0(1) = [0, \mathbf{w}].$$

Note that  $\tilde{J}_0 := J_0(0) \cup J_0(1)$  is a fundamental domain for the deck transformation  $\chi$  and that

$$T_{\mathbf{v}^-}: J_0(0) \rightarrow \tilde{J}_0, \quad T_{\mathbf{w}}: J_0(1) \rightarrow \tilde{J}_0$$

realizes the first return of points in  $\tilde{J}_0$  back to  $\tilde{J}_0$  under the cascade  $T^{\geq 0} := (T^P)_{P \in \mathbb{T}}$ .

The *renormalization tiling*  $\mathbb{J}_0$  of level 0 (see Figure 5) consists of closed intervals

$$\{T^P(J_0(0)) \mid P < (0, 0, 1)\} \cup \{T^P(J_0(1)) \mid P < (0, 1, 0)\},$$

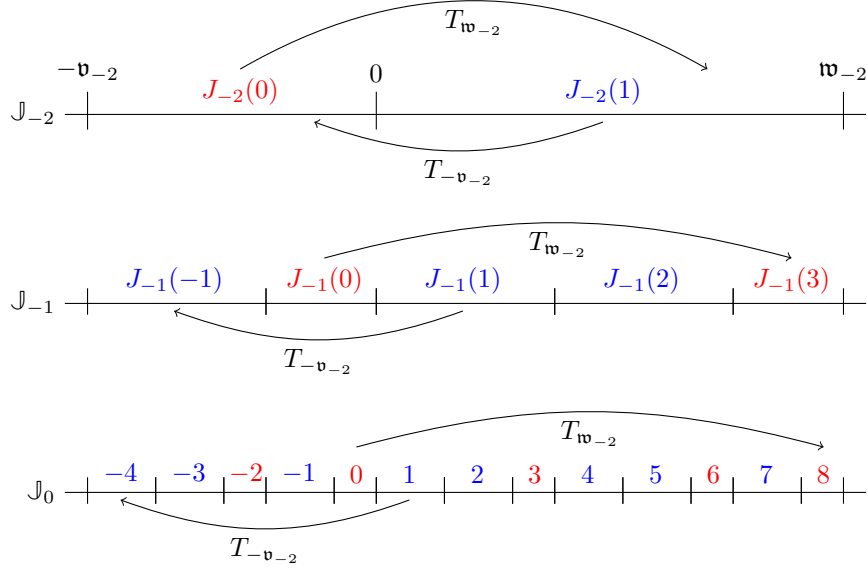

FIGURE 5. Renormalization tilings  $\mathbb{J}_0, \mathbb{J}_{-1}, \mathbb{J}_{-2}$  for the golden mean combinatorics:  $-\mathbf{v} \approx -0.382$  and  $\mathbf{w} \approx 0.618$ . The tiling  $\mathbb{J}_0 \cap [-\mathbf{v}_2, \mathbf{w}_2]$  is obtained by spreading around  $J_0(0)$  and  $J_0(1)$  using  $T_{-\mathbf{v}_2}$  and  $T_{\mathbf{w}_2}$ . Similarly,  $\mathbb{J}_{-1} \cap [-\mathbf{v}_2, \mathbf{w}_2]$  is obtained by spreading around  $J_{-1}(0)$  and  $J_{-1}(1)$  using  $T_{-\mathbf{v}_2}$  and  $T_{\mathbf{w}_2}$ . Note that  $\mathbb{J}_{n-1}$  is the rescaling of  $\mathbb{J}_n$  by  $\approx 2.618$ .

i.e.  $\mathbb{J}_0$  consists of all the interval in the forward  $T^{\geq 0}$ -orbits of  $J_0(0), J_0(1)$  before they return back to  $\tilde{\mathbb{J}}_0$ . We say that  $\mathbb{J}_0$  is *obtained by spreading* around  $J_0(0)$  and  $J_0(1)$  and we enumerate intervals in  $\mathbb{J}_0$  by  $\mathbb{Z}$  from left-to-right.

Similarly, the *renormalization tiling*  $\mathbb{J}_n$  of level  $n$  is defined: it is obtained by spreading around the intervals  $J_n(0) := [-\mathbf{v}_n, 0]$  and  $J_n(1) = [0, \mathbf{w}_n]$ . Note that  $\mathbb{J}_n$  is the rescaling of  $\mathbb{J}_0$  by  $\mathbf{t}^{-n}$ .

**Lemma 2.3** (Proper discontinuity). *If  $P \in \mathbb{T}_{>0} \subset \mathbb{R}_{>0}$  is small, then  $|T^P(0)|$  is large.*

*Proof.* For  $n \ll 0$ , consider  $\tilde{\mathbb{J}}_n := J_n(0) \cup J_n(1) = [-\mathbf{v}_n, \mathbf{w}_n]$ . By construction, if  $P < \min\{(n, 0, 1), (n, 1, 0)\}$ , then  $T^P(0) \notin \tilde{\mathbb{J}}_n$ .  $\square$

**2.2. Combinatorics of close returns.** Consider the cascade  $(T^P)_{P \in \mathbb{T}}$  from §2.1.2. By Lemma 2.2, we view  $\mathbb{T}$  as a sub-semigroup of  $\mathbb{R}_{\geq 0}$ .

For  $P \in \mathbb{T}_{>0}$ , let  $b_P = \mathbb{T}^{-P}(0)$  be the unique preimage of 0 under  $T^P$ . Then  $P$  is the *generation* of  $b_P$ . We say that  $b_P$  is *dominant* if  $[0, b_P]$  contains no  $b_Q$  with  $Q < P$ . By definition, if  $b_P$  and  $b_Q$  are dominant such that  $P < Q$ , then  $b_Q, 0$  are on the same side of  $b_P$ .

Since every interval  $[a, b] \subset \mathbb{R}$  contains at most finitely many  $b_P$  with  $P \leq Q$  for every  $Q$  (see Lemma 2.3), dominant points can accumulate only at 0 and  $\infty$ . Moreover, if  $b_P$  is close to 0, then  $P$  is big; while if  $b_P$  is close to  $\infty$ , then  $P$  is small.

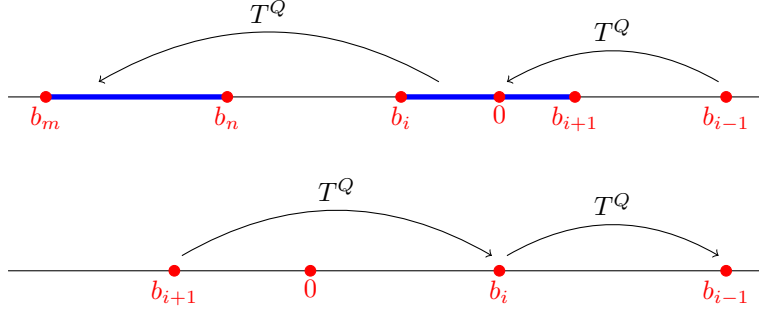

FIGURE 6. Illustration to the proof of Lemma 2.4. Above: the configuration  $b_i < 0 < b_{i-1}$ , then  $b_{i+1} \in [b_i, b_{i-1}]$ . Set  $Q := P_{i-1}$ . Since  $b_i$  dominates on  $[b_i, b_{i-1})$ , we see that  $b_m$  is dominant; similarly  $b_n$  is dominant. Below: the configuration  $0 < b_i < b_{i-1}$ , then  $b_{i+1} < b_i$ . For  $Q := P_i - P_{i-1}$  we obtain  $T^Q(b_{i+1}) = b_i$  because  $T^{-Q}(b_i)$  dominates in  $T^{-Q}[0, b_{i-1})$ . Note that in both configurations the relative position of 0 and  $b_{i+1}$  is irrelevant.

Therefore, we can enumerate all dominant points as  $(b_{P_n})_{n \in \mathbb{Z}}$  such that  $P_n > P_{n-1}$  for all  $n \in \mathbb{Z}$ . Suppressing indices, we write  $b_n = b_{P_n}$ .

By (2.15),  $b_P$  is dominant if and only if  $b_{tP} = A_{1/t}(b_P)$  is dominant. Since  $\{b_n\}$  are enumerated by their escaping time, there is a  $k > 0$  such that

$$tP_i = P_{i+k}.$$

Let us also note that if  $b_n, b_m$  are on the same side of 0, then  $b_n$  is closer to 0 than  $b_m$  if and only if  $P_n > P_m$ .

**Lemma 2.4.** *For every  $[b_i, b_{i+1}]$  there is a  $Q \in \mathbb{T}_{>0}$  and  $[b_n, b_m]$  with  $i \geq m > n$  such that  $T^Q$  maps  $[b_i, b_{i+1}]$  to  $[b_n, b_m]$ .*

*Proof.* Suppose first that  $0 \in [b_i, b_{i-1}]$ , see Figure 6. Then  $b_{i+1} \in [b_i, b_{i-1}]$ . Set  $Q := P_{i-1}$ . Observe that  $T^Q(b_i)$  is of smallest generation in

$$[T^Q(b_i), 0] = T^Q[b_i, b_{i-1}]$$

among  $b_P$ , while  $T^Q(b_{i+1})$  is of smallest generation in

$$[T^Q(b_{i+1}), 0] = T^Q[b_{i+1}, b_{i-1}].$$

Therefore,  $T^Q(b_i)$  and  $T^Q(b_{i+1})$  are dominant; i.e.  $T^Q(b_i) = b_n$  and  $T^Q(b_{i+1}) = b_m$  for some  $n, m < i - 1$ .

Suppose now that  $b_i \in [0, b_{i-1}]$  and assume that  $0 < b_i < b_{i-1}$ ; the opposite case is symmetric. Set  $Q := P_i - P_{i-1}$ . We claim that  $T^{-Q}(b_i)$  is dominant and, moreover,  $T^Q(b_{i+1}) = b_i$ . Indeed, since  $b_i$  dominates (i.e. has smallest generation) in  $[0, b_{i-1})$ , we obtain that  $T^{-Q}(b_i)$  dominates in  $T^{-Q}[0, b_{i-1}) = [T^{-Q}(0), b_i) \ni 0$ . This implies that  $T^{-Q}(b_i)$  is dominant, thus  $T^{-Q}(b_{i+1}) = b_{i+a}$  for some  $a \geq 1$ .

Suppose  $a > 1$ . Since  $P_{i+a} > P_{i+1}$ , the image  $T^Q(b_{i+1})$  has smaller generation than  $b_i$ . Since  $T^Q(b_{i+1}) \in (b_i, b_{i-1})$ , we obtain that  $T^Q(b_{i+1})$  is dominant. This contradicts the enumeration of  $(b_i)_{i \in \mathbb{Z}}$ : the generation of  $T^Q(b_{i+1})$  is between the generations of  $b_i$  and  $b_{i-1}$ .  $\square$



**2.3. Sector renormalization of homeomorphisms.** Consider a homeomorphism  $f: \overline{\mathbb{D}} \rightarrow \overline{\mathbb{D}}$  with  $f(0) = 0$ . We denote by  $\theta$  the rotation angle of  $f|_{\mathbb{S}^1}$ . If  $\theta \notin \mathbb{Q}$ , then  $f|_{\mathbb{S}^1}$  is semi-conjugate to the rotation  $\mathbb{L}_\theta: \mathbb{S}^1 \rightarrow \mathbb{S}^1$ , see (2.1). As we will show in this section, sector (anti- and pre-) renormalization can be defined for homeomorphisms of  $\overline{\mathbb{D}}$  in the same way as for rotations. We will specify certain conditions ensuring the transfer of curves between different dynamical planes in the renormalization tower of  $f$ . The results also hold with necessary adjustments for partial homeomorphisms  $f: \overline{\mathbb{D}} \dashrightarrow \overline{\mathbb{D}}$ .

**2.3.1. Dividing arcs.** Let  $\gamma_0$  be a simple arc connecting 0 to a point in  $\partial\mathbb{D}$ . Then  $\gamma_0$  is called *dividing* if  $\gamma_0 \cap f(\gamma_0) = \{0\}$ . Clearly,  $\gamma_0$  is dividing if and only if  $\gamma_i := f^i(\gamma_0)$  is dividing for all  $i \in \mathbb{Z}$ . Note that  $\gamma_i$  and  $\gamma_{i+j}$  can intersect away from 0 if  $j \geq 2$ .

The curves  $\gamma_0, \gamma_1$  split  $\overline{\mathbb{D}}$  into two closed sectors  $\mathbf{A}$  and  $\mathbf{B}$  denoted so that  $\text{int } \mathbf{A}, \gamma_1, \text{int } \mathbf{B}, \gamma_0$  are clockwise oriented around 0, see the left-hand of Figure 7. We say that  $\gamma_0 = \ell(\mathbf{A}) = \rho(\mathbf{B})$  is the *left boundary of  $\mathbf{A}$*  and the *right boundary of  $\mathbf{B}$*  and we say that  $\gamma_1 = \rho(\mathbf{A}) = \ell(\mathbf{B})$  is the *right boundary of  $\mathbf{A}$*  and the *left boundary of  $\mathbf{B}$* .

Let  $X, Y$  be topological spaces and let  $g: X \dashrightarrow Y$  be a partially defined continuous map. We define

$$X \sqcup_g Y := X \sqcup Y / (\text{Dom } g \ni x \sim g(x) \in \text{Im } g).$$

Consider two sectors  $S_0, S_1 \in \{\mathbf{A}, \mathbf{B}\}$ ; each  $S_i$  is a copy of either  $\mathbf{A}$  or  $\mathbf{B}$ . We define the map  $g: \rho(S_0) \dashrightarrow \ell(S_1)$  by

$$(2.16) \quad g := \begin{cases} \text{id}: \gamma_1 \rightarrow \gamma_1 & \text{if } (S_0, S_1) \cong (\mathbf{A}, \mathbf{B}), \\ \text{id}: \gamma_0 \rightarrow \gamma_0 & \text{if } (S_0, S_1) \cong (\mathbf{B}, \mathbf{A}), \\ f^{-1}: \gamma_1 \rightarrow \gamma_0 & \text{if } (S_0, S_1) \cong (\mathbf{A}, \mathbf{A}), \\ f: \gamma_0 \rightarrow \gamma_1 & \text{if } (S_0, S_1) \cong (\mathbf{B}, \mathbf{B}). \end{cases}$$

The *dynamical gluing* of  $S_0, S_1$  is  $S_0 \sqcup_g S_1$ . Similarly, the dynamical gluing is defined for any finite or infinite sequence  $\mathbf{s} = (S_i)_i \in \{\mathbf{A}, \mathbf{B}\}^k$  with  $k \leq \infty$ . If  $\mathbf{s}$  is a finite sequence, then the result of the dynamical gluing is a closed sector. If, in addition, we glue the right boundary of the last sector of  $\mathbf{s}$  with the left boundary of the first sector of  $\mathbf{s}$ , then the result is a closed topological disk.

**2.3.2. Prime antirenormalizations.** The (clockwise)  $1/3$  *antirenormalization* of  $f$  is a homeomorphism  $f_{-1}: W \rightarrow W$  such that (see Figure 7)

- $W$  is a closed topological disk that is the dynamical gluing of sectors  $W[0], W[1], W[2]$ , where  $W[0]$  and  $W[1]$  are copies of  $\mathbf{A}$ , while  $W[2]$  is a copy of  $\mathbf{B}$ ;
- the map  $f_{-1}: W[0] \rightarrow W[1]$  is the canonical isomorphism of copies of  $\mathbf{A}$ ;
- the map  $f_{-1}: W[1, 2] \rightarrow W[0, 1]$  is identified with  $f: W \setminus \gamma_0 \rightarrow W \setminus \gamma_1$ .

Similarly, the  $p/q$ -antirenormalization is defined for any rational number  $p/q$ , see [DLS, § B.1.3]. The  $1/3$  and  $2/3$  antirenormalization are called *prime*. Any other antirenormalization is an iteration of prime antirenormalizations, see [DLS, Lemma B.3].

It follows from direct calculations, that:

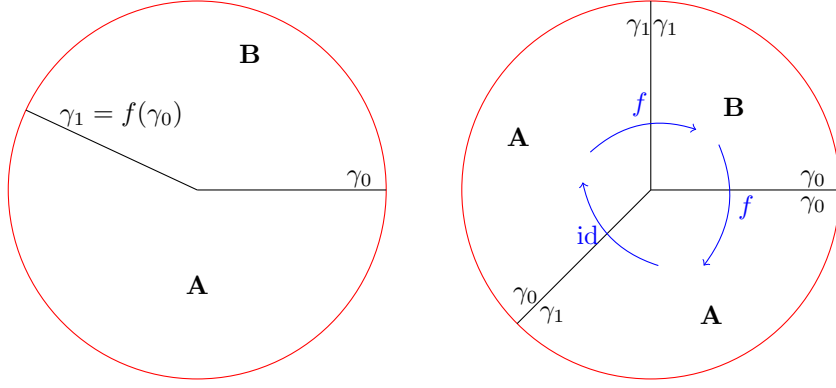

FIGURE 7. Left: a homeomorphism  $f: W \rightarrow W$  and a diving pair  $\gamma_0, \gamma_1$ . Right: the  $1/3$  antirenormalization of  $f$  (with respect to the clockwise orientation).

**Lemma 2.5** (Inverse to (2.3)). *Let  $f: \bar{\mathbb{D}} \rightarrow \bar{\mathbb{D}}$  be a homeomorphism and let  $\mu$  be the rotation number of  $f|_{\mathbb{S}^1}$ .*

- *If  $f_{-1}: \bar{\mathbb{D}} \rightarrow \bar{\mathbb{D}}$  is the  $1/3$  antirenormalization of  $f$ , then the rotation number of  $f_{-1}|_{\mathbb{S}^1}$  is*

$$\theta = \frac{1}{2 - \mu}.$$

- *If  $f_{-1}: \bar{\mathbb{D}} \rightarrow \bar{\mathbb{D}}$  is the  $2/3$  antirenormalization of  $f$ , then the rotation number of  $f_{-1}|_{\mathbb{S}^1}$  is*

$$\theta = \frac{\mu}{1 + \mu}.$$

□

2.3.3. *Pre-antirenormalizations.* Recall from (2.5) that  $e_-: \bar{\mathbb{H}}_- \rightarrow \bar{\mathbb{D}}^*$  denotes the universal covering map from the lower half plane to the punctured disk. We enumerate preimages of  $\gamma_0, \gamma_1$  under  $e_-$  as  $\tilde{\gamma}_i$  from left-to-right such that  $e_-$  maps  $\tilde{\gamma}_i$  to  $\gamma_{i \bmod 2}$ . We specify the lifts  $f_-$  and  $f_+$  of  $f$  such that

- $f_-$  maps  $\tilde{\gamma}_0$  to  $\tilde{\gamma}_{-1}$ ; and
- $f_+$  maps  $\tilde{\gamma}_0$  to  $\tilde{\gamma}_1$ .

Then  $\chi := f_+ \circ f_-^{-1}$  is a deck transformation of  $e_-$ . Note that  $f_-$  and  $f_+^{-1}$  move points to the left of  $\bar{\mathbb{H}}_-$  while  $f_+$  and  $f_-^{-1}$  move points to the right of  $\bar{\mathbb{H}}_-$ .

The  $1/3$  pre-antirenormalization of  $(f_-, f_+)$  is the commuting pair

$$(2.17) \quad (f_{-, -1} := f_- \circ f_+^{-1} = \chi^{-1}, \quad f_{+, -1} := f_+).$$

Setting  $\chi_{-1} := f_{+, -1} \circ f_{-, -1}^{-1}$  and identifying  $\bar{\mathbb{D}}^* \simeq \bar{\mathbb{H}}_- / \langle \chi_{-1} \rangle$ , we recover the  $1/3$  antirenormalization of  $f$ :

$$f_{-1} := f_{-, -1} / \langle \chi_{-1} \rangle: \bar{\mathbb{D}} \rightarrow \bar{\mathbb{D}}, \quad f_{-1}(0) = 0,$$

see [DLS, Lemma B.4].

Similarly, the  $2/3$  pre-antirenormalization of  $(f_-, f_+)$  is the commuting pair

$$(2.18) \quad (f_{-, -1} := f_-, \quad f_{+, -1} := f_+ \circ f_-^{-1} = \chi).$$

Setting  $\chi_{-1} := f_{+,-1} \circ f_{-,-1}^{-1}$  and identifying  $\overline{\mathbb{D}}^* \simeq \overline{\mathbb{H}}_- / \langle \chi_{-1} \rangle$ , we recover the 2/3 *antirenormalization*

$$f_{-1} := f_{-1, -} / \langle \chi_{-1} \rangle : \overline{\mathbb{D}} \rightarrow \overline{\mathbb{D}}, \quad f_{-1}(0) = 0,$$

see [DLS, Lemma B.6].

**2.3.4. Tower of pre-antirenormalizations.** Let us fix an irrational periodic point  $\theta = R_{\text{prm}}^m(\theta)$  of (2.3). Then  $R_{\text{prm}}^m$  has an inverse branch  $R^-$  mapping  $\mathbb{S}^1 \setminus \{0\}$  into a neighborhood of  $\theta$ . Let us specify the antirenormalization operator associated with  $R^-$ . For  $i \in \{1, \dots, m\}$ , set  $\mathcal{R}_i^-$  to be

- the 1/3 pre-antirenormalization if  $R_{\text{prm}}^i(\theta_*) \in (1/2, 1)$ ,
- the 2/3 pre-antirenormalization if  $R_{\text{prm}}^i(\theta_*) \in (0, 1/2)$ ;

and set

$$(2.19) \quad \mathcal{R}^- := \mathcal{R}_1^- \circ \mathcal{R}_2^- \circ \dots \circ \mathcal{R}_m^-.$$

This operator is inverse to  $\mathcal{R}$  from (2.10). Since  $\theta \notin \mathbb{Q}$ , both 1/3 and 2/3 pre-antirenormalizations appear in (2.19).

We have the *pre-antirenormalization tower*:

$$F_n := (f_{n,-}, f_{n,+}) := (\mathcal{R}^-)^{-n}(f_-, f_+) \quad \text{for } n \leq 0.$$

Writing  $\chi_n := f_{n,-}^{-1} \circ f_{n,+}$  and identifying  $\overline{\mathbb{H}}_- / \langle \chi_n \rangle \simeq \overline{\mathbb{D}}^*$ , we obtain the projection

$$(2.20) \quad \rho_n : \overline{\mathbb{H}}_- \rightarrow \overline{\mathbb{H}}_- / \langle \chi_n \rangle \subset \overline{\mathbb{D}}$$

semi-conjugating the pair  $F_n$  to a homeomorphism  $f_n : \overline{\mathbb{D}} \rightarrow \overline{\mathbb{D}}$ , where  $f_n(0) := 0$ . If  $\mu$  is the rotation number of  $f_0 | \mathbb{S}^1$ , then  $(R^-)^{-n}(\mu)$  is the rotation number of  $f_n | \mathbb{S}^1$ .

**Lemma 2.6.** *For  $m \leq n \leq 0$ , we have:*

- $f_{m,-}$  and  $f_{m,+}^{-1}$  are compositions of  $f_{n,-}$  and  $f_{n,+}^{-1}$ ; and
- $f_{m,+}$  and  $f_{m,-}^{-1}$  are compositions of  $f_{n,+}$  and  $f_{n,-}^{-1}$ .

*Proof.* The operator  $\mathcal{R}^-$  is a composition of prime pre-antirenormalizations; the corresponding statement for a prime antirenormalization is immediate from the definition, see (2.17) and (2.18).  $\square$

**2.3.5. Cascade  $F^{\geq 0} = (F^P)_{P \in \mathbb{T}}$ .** Similar to (2.11), we define

$$(2.21) \quad F^{(n,a,b)} := f_{n,-}^a \circ f_{n,+}^b,$$

where  $(n, a, b) \in \mathbb{Z}_{\leq 0} \times \mathbb{Z}_{\geq 0}^2$ . As in §2.1.2,  $F^T$  depends only on the image of  $(n, a, b)$  in the semi-group of power-triples  $\mathbb{T}$ , see (2.13).

Using Lemma 2.2, we view  $\mathbb{T}$  as a sub-semigroup of  $\mathbb{R}_{\geq 0}$ .

**2.3.6. Renormalization triangulations.** Let  $\Delta_0(0)$  be the strip between  $\tilde{\gamma}_{-1}$  and  $\tilde{\gamma}_0$ , and let  $\Delta_0(1)$  be the strip between  $\tilde{\gamma}_0$  and  $\tilde{\gamma}_1$ . We will refer to  $\Delta_0(0)$  and  $\Delta_0(1)$  as *triangles*.

As in §2.1.3 we define the *renormalization triangulation*  $\Delta_0$  of level 0 to be

$$\{F^P(\Delta_0(0)) \mid P < (0, 0, 1)\} \cup \{F^P(\Delta_0(1)) \mid P < (0, 1, 0)\},$$

i.e.  $\Delta_0$  consists of all the triangles in the forward  $F$ -orbits of  $\Delta_0(0)$ ,  $\Delta_0(1)$  before they return back to  $\Delta_0(0, 1)$ . We say that  $\Delta_0$  is obtained by spreading around  $\Delta_0(0)$  and  $\Delta_0(1)$ . We enumerate triangles of  $\Delta_0$  from left-to-right as  $\Delta_0(i)$  with  $i \in \mathbb{Z}$ .

Similarly, we define the triangulation  $\Delta_n$  for  $n \leq 0$ . The triangle  $\Delta_n(0)$  is bounded by  $f_{n,-}(\tilde{\gamma}_0) \cup \tilde{\gamma}_0$ , and the triangle  $\Delta_n(1)$  is bounded by  $\tilde{\gamma}_0 \cup f_{n,+}(\tilde{\gamma}_0)$ . The triangulation  $\Delta_n$  is obtained by spreading around  $\Delta_n(0)$  and  $\Delta_n(1)$ .

Note that  $\Delta_n(0,1)$  is a fundamental domain of  $\chi_n$ , and we have a projection  $\rho_n: \Delta_n(0,1) \rightarrow \overline{\mathbb{D}}$  (see (2.20)) gluing the left and right boundaries of  $\Delta_n(0,1)$ .

**2.3.7. Dynamics of triangles of  $\Delta_0$ .** Consider the triangulation  $\Delta_0$ . For every  $i \in \mathbb{Z}$ , we write  $\mathbf{s}[i] := \mathbf{B}$  if  $\Delta_0(i)$  is in the forward orbit of  $\Delta_0(0)$  before it returns to  $\Delta_0(0,1)$ ; and we write  $\mathbf{s}[i] := \mathbf{A}$  if  $\Delta_0(i)$  is in the forward orbit of  $\Delta_0(1)$  before it returns to  $\Delta_0(0,1)$ .

We can view  $\Delta_0 \simeq \overline{\mathbb{H}}_-$  as the dynamical gluing of  $(\mathbf{s}[i])_{i \in \mathbb{Z}}$  (see §2.3.1), where the left boundary of  $\mathbf{s}[i+1]$  is glued with the right boundary of  $\mathbf{s}[i]$ . The dynamics of triangles of  $\Delta_0$  is described as follows. For every  $i \in \mathbb{Z}$  there exists  $P(i)$  such that

- if  $\mathbf{s}[i] = \mathbf{B}$ , then  $P(i) < (0, 0, 1)$  and

$$(2.22) \quad F^{P(i)}: \Delta_0(0) \rightarrow \Delta_0(i)$$

is an isomorphism of copies of  $\mathbf{B}$ ;

- if  $\mathbf{s}[i] = \mathbf{A}$ , then  $P(i) < (0, 1, 0)$  and

$$(2.23) \quad F^{P(i)}: \Delta_0(1) \rightarrow \Delta_0(i)$$

is an isomorphism of copies of  $\mathbf{A}$ .

Conversely, for every  $P < (0, 0, 1)$  there exists  $i$  such that  $\mathbf{s}[i] = \mathbf{B}$  and  $P = P(i)$ ; and for every  $P < (0, 1, 0)$  there exists  $i$  such that  $\mathbf{s}[i] = \mathbf{A}$  and  $P = P(i)$ . On the other hand, for every  $Q < \min\{(0, 0, 1), (0, 1, 0)\}$  there exists  $j$  with

$$(2.24) \quad \mathbf{s}[j] = \mathbf{B}, \quad \mathbf{s}[j+1] = \mathbf{A}, \quad P(j) = (0, 0, 1) - Q, \quad P(j+1) = (0, 1, 0) - Q$$

such that

$$(2.25) \quad F^Q: \Delta_0(j, j+1) \rightarrow \Delta_0(0, 1) \quad \text{is identified with} \quad f: \overline{\mathbb{D}} \setminus \gamma_0 \rightarrow \overline{\mathbb{D}} \setminus \gamma_1.$$

In other words,  $\mathbf{F}^{-Q} | \Delta(0, 1)$  is identified with  $f^{-1} | (\overline{\mathbb{D}} \setminus \gamma_1)$ .

**2.3.8. Walls.** A wall around 0 respecting  $\gamma_0, \gamma_1$  is either a closed annulus or a simple closed curve  $\Pi \subset \overline{\mathbb{D}}$  such that

- (1)  $\mathbb{C} \setminus \Pi$  has two connected components. Moreover, denoting by  $\Omega$  the bounded component of  $\mathbb{C} \setminus \Pi$ , we have  $0 \in \Omega$ .
- (2)  $\gamma_0 \cap \Pi$  and  $\gamma_1 \cap \Pi$  are connected.
- (3) if  $x \in \Omega$ , then  $f^{\pm 1}(x) \in \Pi \cup \Omega$ .

In other words, points in  $\overline{\mathbb{D}}$  do not jump over  $\Pi$  under one iteration of  $f$ . If  $\Pi$  is a simple closed curve, then  $f$  restricts to an actual homeomorphism  $f: \overline{\Omega} \rightarrow \overline{\Omega}$ .

We say that  $\Pi$  is an  $N$ -wall if it takes at least  $N \geq 1$  iterates of  $f^{\pm 1}$  for points in  $\Omega$  to cross  $\Pi$ .

By definition,  $\Pi \cap \mathbf{B}$  and  $\Pi \cap \mathbf{A}$  are connected closed rectangles (possibly degenerate if  $\Pi$  is a curve). Let us denote by  $\Pi(0)$  and  $\Pi(1)$  the images of  $\Pi \cap \mathbf{B}$  and  $\Pi \cap \mathbf{A}$  under  $\Delta_0(0) \simeq \mathbf{B}$  and  $\Delta_0(1) \simeq \mathbf{A}$ . The wall  $\mathbb{I}$  is obtained by spreading around  $\Pi(0)$  and  $\Pi(1)$

$$\mathbb{I} := \{F^P(\Pi(0)) \mid P < (0, 0, 1)\} \cup \{F^P(\Pi(1)) \mid P < (0, 1, 0)\},$$

i.e.  $\mathbb{I}$  consists of all the rectangles in the forward  $F^{\geq 0}$ -orbits of  $\Pi(0), \Pi(1)$  before they return back to  $\Delta_0(0, 1)$ . We enumerate rectangles of  $\mathbb{I}$  from left-to-right as  $\Pi(i)$  with  $i \in \mathbb{Z}$ .

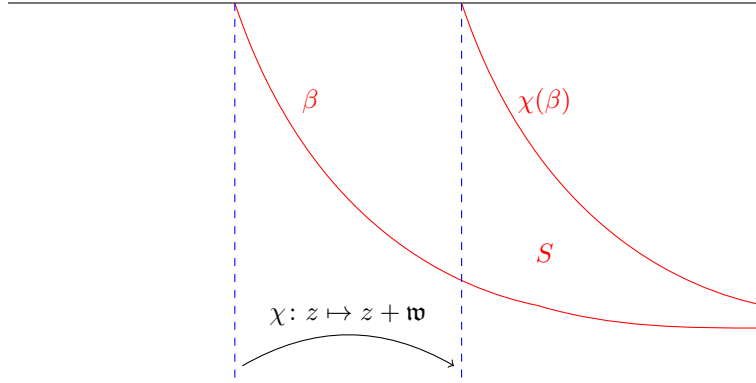

FIGURE 8. The sector  $S$  between  $\beta$  and  $\chi(\beta)$  is not a fundamental domain of  $\chi: z \mapsto z + \mathfrak{w}$  because not every orbit passes through  $S$ .

Every  $\Pi(i)$  is a copy of either  $\Pi \cap \mathbf{B}$  or  $\Pi \cap \mathbf{A}$ , and  $\Pi(i)$  is glued to  $\Pi(i+1)$  along  $\text{id}$  or  $f^{\pm 1}$ , see (2.16). Therefore,  $\mathbb{P}$  is connected, and, moreover, if  $\Pi$  is an  $N$ -wall, then  $\mathbb{P}$  is an  $(N-1)$ -wall: it takes at least  $N-1$  iterates of  $f_{\pm}$  for a point to cross  $\mathbb{P}$ .

2.3.9. *The boundary point  $\alpha$ .* Let us add the *boundary point*  $\alpha$  to  $\overline{\mathbb{H}}_-$  which will be the preimage of 0 under  $\rho_n: \Delta_n(0, 1) \sqcup \{\alpha\} \rightarrow \overline{\mathbb{D}}$ .

We now introduce the *wall topology*  $\Xi$  on  $\overline{\mathbb{H}}_- \sqcup \{\alpha\}$ . For a wall  $\mathbb{P} \subset \overline{\mathbb{H}}_-$ , let  $Q'_{\mathbb{P}} \subset \overline{\mathbb{H}}_-$  be the connected component of  $\mathbb{C} \setminus \mathbb{P}$  below  $\mathbb{P}$ , i.e.  $Q'_{\mathbb{P}} \not\cong 0$ . We write  $Q_{\mathbb{P}} := Q'_{\mathbb{P}} \sqcup \{\alpha\}$ . In the topology  $\Xi$  of  $\overline{\mathbb{H}}_- \sqcup \{\alpha\}$  open sets are generated by open sets of  $\overline{\mathbb{H}}_-$  and  $\{Q_{\mathbb{P}}: \mathbb{P} \text{ is a wall}\}$ .

**Remark 2.7.** *It can be shown that  $\Xi$  is independent of the choice of  $\gamma_0$ .*

2.3.10. *Fundamental domains.* A simple arc  $\beta: [0, 1] \rightarrow \overline{\mathbb{H}}_-$  is *dividing for  $n$*  if

- (1)  $\beta(0) \in \partial\mathbb{H}_-$  and  $\beta(t) \in \mathbb{H}_-$  for  $t > 0$ ;
- (2)  $\beta$  lands at  $\alpha$  with respect to  $\Xi$ ; and
- (3)  $\beta$  does not intersect  $f_{n,-}(\beta)$  and  $f_{n,+}(\beta)$ .

For example,  $\tilde{\gamma}_i$  are dividing arcs.

If  $\beta$  is dividing, then  $\overline{\mathbb{H}}_- \setminus \beta$  has two connected components. (Indeed, the image of  $\beta$  under the Riemann map  $\overline{\mathbb{H}}_- \sqcup \{\infty\} \simeq \overline{\mathbb{D}}$  is a simple arc connecting two points in  $\partial\overline{\mathbb{D}}$ .) We denote the closures of the connected components of  $\overline{\mathbb{H}}_- \setminus \beta$  by  $\mathfrak{L}$  and  $\mathfrak{R}$  enumerated so that  $\mathfrak{L}$  is on the left of  $\beta$  (i.e.  $\mathfrak{L} \ni x$  for  $x \ll 0$ ) while  $\mathfrak{R}$  is on the right of  $\beta$  (i.e.  $\mathfrak{R} \ni x$  for  $x \gg 0$ ).

**Lemma 2.8.** *For every  $m \leq n$ , the maps  $f_{m,-}, f_{m,+}^{-1}$  move points to the left:*

$$f_{m,-}(\mathfrak{L}) \subset \mathfrak{L} \quad \text{and} \quad f_{m,+}^{-1}(\mathfrak{L}) \subset \mathfrak{L},$$

while  $f_{m,+}, f_{m,-}^{-1}$  move points to the right:

$$f_{m,-}^{-1}(\mathfrak{R}) \subset \mathfrak{R} \quad \text{and} \quad f_{m,+}(\mathfrak{R}) \subset \mathfrak{R}$$

*Proof.* The case  $m = n$  follows from the definition. The general case follows by induction because  $f_{m,-}$  and  $f_{m,+}^{-1}$  are compositions of  $f_{n,-}$  and  $f_{n,+}^{-1}$ , while  $f_{m,+}$  and  $f_{m,-}^{-1}$  are compositions of  $f_{n,+}$  and  $f_{n,-}^{-1}$ , see Lemma 2.6.  $\square$

**Proposition 2.9.** *If  $\beta$  is a dividing curve for  $n$ , then for all  $m \leq n$  the closed sector  $S_m \subset \overline{\mathbb{H}}_-$  bounded by  $f_{m,-}(\beta) \cup f_{m,+}(\beta)$  and containing  $\beta$  is a fundamental domain for  $\chi_m$ .*

*Conversely, if  $\beta_0 \subset \overline{\mathbb{D}}$  is a dividing curve of  $f_n$  (see §2.3.1), then a lift  $\beta \subset \overline{\mathbb{H}}_-$  of  $\beta_0$  is a dividing arc for  $n$ .*

As a corollary,

$$\overline{\mathbb{D}} \simeq \overline{\mathbb{H}}_- / \langle \chi_m \rangle \simeq S_m / f_{m,-}(\beta) \ni x \sim \chi_m(x) \in f_{m,+}(\beta).$$

To prove Proposition 2.9 we need to verify that every  $\chi_m$ -orbit passes through  $S_m$ . Figure 2 illustrates that Condition (2) can not be relaxed to the condition “ $\beta$  goes to infinity.”

*Proof of Proposition 2.9.* Since  $f_{m,-}(\beta)$  is on the left of  $f_{n,-}(\beta)$  (by Lemmas 2.6 and 2.8), the arcs  $f_{m,-}(\beta)$  and  $\beta$  are disjoint. Similarly,  $f_{m,+}(\beta)$  and  $\beta$  are disjoint. We need to show that for every  $z \in \overline{\mathbb{H}}_-$  there is a  $k \in \mathbb{Z}$  such that  $\chi_m^k(z) \in S_m$ .

Suppose converse, there is a  $z \in \overline{\mathbb{H}}_-$  such that  $\chi_m^k(z) \notin S_m$  for all  $k \in \mathbb{Z}$ . Since point can not jump over  $S_m$  under the iteration of  $\chi_m$ , the orbit of  $z$  is either on the left of  $S_m$  or on the right of  $S_m$ .

Let us assume that there is a  $z \in \overline{\mathbb{H}}_-$  whose orbit is on the left of  $S_m$ ; the opposite case is analogous. We will show that  $F^P(z)$  is on the right from  $S_m$  for some  $P \in \mathbb{T}$ . Then for some  $a, b \geq 0$  and  $k \in \mathbb{Z}$ , we would have

$$f_{n,+}^a \circ f_{n,-}^{-b} \circ F^P(z) = \chi_m^k(z).$$

This will be a contradiction, because  $\chi_m^k(z)$  is still on the right of  $S_m$  for all  $k \in \mathbb{Z}$  by Lemma 2.8.

Let us choose a 1-wall  $\mathbb{A}$  separating  $z$  from  $\alpha$ . We denote by  $Q$  the connected component of  $\overline{\mathbb{H}}_- \setminus \mathbb{A}$  attached to  $\alpha$ . Since  $f_{m,-}(\beta)$  and  $f_{m,+}(\beta)$  land at  $\alpha$ , the sector  $S_m$  intersects at most finitely many truncated triangles  $\Delta(i) \setminus Q$ . This means that  $\Delta(j) \setminus Q$  is on the right of  $S_m$  for  $j \gg 0$ .

Write  $z \in \Delta(i)$ . There is a small  $P \in \mathbb{T}$  and a big  $j \gg 0$  such that  $F^P: \Delta(i) \rightarrow \Delta(j)$  is a homeomorphism. Then  $F^P(z) \in \Delta(j) \setminus Q$  is on the right from  $S_m$ . This proves that  $S_m$  is a fundamental domain.

The converse statement is immediate. □

**2.3.11. Partial homeomorphisms.** Let us show that Proposition 2.9 with necessary adjustments holds for partial homeomorphisms.

Consider a partial homeomorphism  $f: \overline{\mathbb{D}} \dashrightarrow \overline{\mathbb{D}}$  with  $f(0) = 0$  such that  $\text{Dom } f$  and  $\text{Im } f$  are closed topological disks containing 0 in their interiors.

As in §2.3.1, let  $\gamma_0, \gamma_1$  be two simple arcs connecting 0 to points in  $\partial\overline{\mathbb{D}}$  such that  $\gamma_0$  and  $\gamma_1$  are disjoint except for 0 and such that  $\gamma_1$  is the image of  $\gamma_0$  in the following sense:  $\gamma'_0 := \gamma_0 \cap \text{Dom } f$  and  $\gamma'_1 := \gamma_1 \cap \text{Im } f$  are simple closed curves such that  $f$  maps  $\gamma'_0$  to  $\gamma'_1$ . We call  $\gamma_0, \gamma_1$  a *dividing pair*. Then  $\gamma_0 \cup \gamma_1$  splits  $\overline{\mathbb{D}}$  into two closed sectors  $\mathbf{A}$  and  $\mathbf{B}$  denoted so that  $\text{int } \mathbf{A}, \gamma_1, \text{int } \mathbf{B}, \gamma_0$  are clockwise oriented around 0.

Given two sectors  $S_i, S_{i+1} \in \{\mathbf{A}, \mathbf{B}\}$ , we naturally have a partial map  $g: \rho(S_0) \dashrightarrow \ell(S_1)$  defined by

$$(2.26) \quad g := \begin{cases} \text{id}: \gamma_1 \rightarrow \gamma_1 & \text{if } (S_i, S_{i+1}) \cong (\mathbf{A}, \mathbf{B}), \\ \text{id}: \gamma_0 \rightarrow \gamma_0 & \text{if } (S_i, S_{i+1}) \cong (\mathbf{B}, \mathbf{A}), \\ f^{-1}: \gamma'_1 \rightarrow \gamma'_0 & \text{if } (S_i, S_{i+1}) \cong (\mathbf{A}, \mathbf{A}), \\ f: \gamma'_0 \rightarrow \gamma'_1 & \text{if } (S_i, S_{i+1}) \cong (\mathbf{B}, \mathbf{B}), \end{cases}$$

compare with (2.16). The *dynamical gluing* of a sequence of sectors  $(S_i)_i \in \{\mathbf{A}, \mathbf{B}\}^k$  with  $k \leq \infty$  is defined in the same way as in §2.3.1; i.e. the left boundary of  $S_i$  is glued with the right boundary of  $S_{i+1}$  along (2.26).

Let  $\mathbf{s} \in \{\mathbf{A}, \mathbf{B}\}^{\mathbb{Z}}$  be the sequence from §2.3.6 (where  $f$  is assumed to be a homeomorphism), and let  $\Delta_0$  be corresponding dynamical gluing. Then  $\Delta_0$  is a triangulation *associated* with  $\gamma_0, \gamma_1$ , we enumerate triangles of  $\Delta_0$  from left-to-right as  $\Delta_0(i) \simeq \mathbf{s}[i]$ , with  $i \in \mathbb{Z}$ .

For every  $Q < \min\{(0, 1, 0), (0, 0, 1)\}$ , we define the partial homeomorphism  $\mathbf{F}^Q: \Delta_0 \dashrightarrow \Delta_0$  trianglewise using (2.22), (2.23), and (2.25). Taking iterates, we obtain the cascade of partial homeomorphisms

$$F^{\geq 0} := \{F^P: \Delta_0 \dashrightarrow \Delta_0 \mid P \in \mathbb{T}\}.$$

In particular,  $f_- = F^{(0,1,0)}$  and  $f_+ = F^{(0,0,1)}$  are well defined. The commuting pair

$$(2.27) \quad f_+: \Delta_0(0) \rightarrow \Delta_0(0,1) \quad \text{and} \quad f_-: \Delta_0(1) \rightarrow \Delta_0(0,1)$$

realizes the first return of points in  $\Delta_0(0,1)$  back to  $\Delta_0(0,1)$ . The pair (2.27) is obtained by cutting  $f: \overline{\mathbb{D}} \dashrightarrow \overline{\mathbb{D}}$  along  $\gamma_1$ . Conversely, there is a projection

$$\rho: \Delta_0(0,1) \rightarrow \overline{\mathbb{D}}$$

semi-conjugating  $F = (f_-, f_+)$  to  $f$  such that  $\rho$  glues the left boundary  $\lambda$  of  $\Delta_0(0,1)$  with its right boundary  $\rho$ . The gluing map  $\chi: \lambda \rightarrow \rho$  coincides with  $f_+ \circ f_-^{-1}: \lambda \dashrightarrow \rho$  in  $\text{Dom}(f_+ \circ f_-^{-1})$ .

A wall  $\Pi \subset \text{Dom } f \cap \text{Im } f$  around 0 respecting  $\gamma_0, \gamma_1$  for  $f: \overline{\mathbb{D}} \dashrightarrow \overline{\mathbb{D}}$  is defined in the same way as in the case of homeomorphisms, see §2.3.8. Lifting  $\Pi$  under  $\rho$  and spreading  $\Pi$  around, we obtain the connected strip  $\mathbb{I} \subset \Delta$ . As in §2.3.9, we add the boundary point  $\alpha$  to  $\Delta_0$ , and we endow  $\Delta_0 \sqcup \{\alpha\}$  with the *wall topology*.

Fix a wall  $\Pi$  and its full lift  $\mathbb{I} \subset \Delta$ . Let us denote by  $Q$  the connected component of  $\Delta \setminus \mathbb{I}$  attached to  $\alpha$ . Note that  $Q \subset \text{Dom}(f_-) \cap \text{Dom}(f_+)$ .

A *fundamental domain* for  $f$  is a sector  $S^{\text{new}}$  with distinguished sides  $\lambda^{\text{new}}$  and  $\rho^{\text{new}}$  such that

- (1)  $S^{\text{new}} \setminus Q = \Delta(0,1) \setminus Q$ , and  $\lambda^{\text{new}} \setminus Q = \lambda \setminus Q$ , and  $\rho^{\text{new}} \setminus Q = \rho \setminus Q$ ,
- (2)  $f_+ \circ f_-^{-1}(\lambda^{\text{new}} \cap (\mathbb{I} \cup Q)) \subset \rho^{\text{new}}$  and  $f_-^{-1}(\lambda^{\text{new}} \cap (\mathbb{I} \cup Q)) \subset \text{int}(S^{\text{new}})$ ;
- (3)  $\lambda^{\text{new}}$  and  $\rho^{\text{new}}$  land at  $\alpha$ .

We define the gluing map

$$\chi^{\text{new}}: \lambda \rightarrow \rho$$

to be

- $\chi$  on  $\lambda \setminus Q$ ; and
- $F^{(0,0,1)-(0,1,0)} = f_+ \circ f_-^{-1}$  on  $\lambda \cap Q$ .

Gluing the left and right boundaries of  $S^{\text{new}}$  along  $\chi^{\text{new}}$ , we obtain a closed topological disk  $W$ . We realize  $W$  as a subset of  $\mathbb{C}$ , and we denote by

$$\rho^{\text{new}}: S^{\text{new}} \rightarrow W, \quad \rho^{\text{new}}(\alpha) = 0$$

the induced projection. Then  $F = (f_-, f_+)$  projects to

$$f^{\text{new}}: W \dashrightarrow W.$$

Write  $\Omega = \rho(Q \cap S) \subset \overline{\mathbb{D}}$  and  $\Omega^{\text{new}} = \rho^{\text{new}}(Q \cap S^{\text{new}}) \subset W$ .

**Proposition 2.10.** *Let  $S^{\text{new}}$  be a fundamental domain for  $f$  as above. Then the quotient map  $f^{\text{new}}: W \dashrightarrow W$  is canonically conjugate to  $f: \overline{\mathbb{D}} \dashrightarrow \overline{\mathbb{D}}$ .*

*Conversely, suppose  $\gamma_0^{\text{new}}, \gamma_1^{\text{new}}$  is a dividing pair such that  $\gamma_0^{\text{new}} \setminus \Omega = \gamma_0 \setminus \Omega$  and  $\gamma_1^{\text{new}} \setminus \Omega = \gamma_1 \setminus \Omega$ . Let  $\Delta_0^{\text{new}}$  be the triangulation associated with  $\gamma_0^{\text{new}}, \gamma_1^{\text{new}}$ . Then the cascades  $F \upharpoonright \Delta_0$  and  $F \upharpoonright \Delta_0^{\text{new}}$  are canonically conjugate.*

The canonical homeomorphism  $h: \overline{\mathbb{D}} \rightarrow W$  has the following characterization:

- $h: \overline{\mathbb{D}} \setminus \Omega \rightarrow W \setminus \Omega^{\text{new}}$  is the canonical identification using Condition (1);
- if  $h \circ \rho(x) = \rho^{\text{new}}(y) \in \Omega^{\text{new}}$  for some  $x, y \in \Delta$ , then  $x$  and  $y$  are related by the action of the deck transformation  $\chi \upharpoonright Q \cup$ : for some  $n \in \mathbb{Z}$  we have  $x \in \text{Dom}(\chi \upharpoonright Q)^n$  and  $\chi^n(x) = y$ .

Equivalently, the canonical homeomorphism  $h: \overline{\mathbb{D}} \rightarrow W$  can be characterized using unique extension along curves as in [DLS, Theorem B.8]. A similar characterization has a canonical homeomorphism between  $\Delta_0$  and  $\Delta_0^{\text{new}}$ .

*Proof of Proposition 2.10.* Denote by  $\Omega$  and  $\Omega^{\text{new}}$  the images of  $Q \sqcup \{\alpha\}$  under  $\rho$  and  $\rho^{\text{new}}$  respectively. Condition (1) implies that  $\overline{\mathbb{D}} \setminus \Omega$  is canonically identified with  $W \setminus \Omega^{\text{new}}$  by an equivariant homeomorphism.

We can now modify  $f: \overline{\mathbb{D}} \dashrightarrow \overline{\mathbb{D}}$  away from  $\Omega \cup f(\Omega) \cup f^{-1}(\Omega)$  to obtain a self-homeomorphism  $f: \overline{\mathbb{D}} \rightarrow \overline{\mathbb{D}}$  mapping  $\gamma_0$  to  $\gamma_1$ . Since the modification does not affect  $f \upharpoonright \Omega$ , we obtain a reformulation of Proposition 2.9.  $\square$

### 3. BACKGROUND ON THE PACMAN RENORMALIZATION

**3.1. Quadratic-like renormalization.** Recall that copies of the Mandelbrot set are canonically homeomorphic via the straightening map, see [DH2]. See also [DH1, L4] for the background on the Mandelbrot set. Given a small copy  $\mathcal{M}_s$  of the Mandelbrot set, we denote by  $\mathbf{R}_s: \mathcal{M}_s \rightarrow \mathcal{M}$  the canonical homeomorphism between  $\mathcal{M}_s$  and  $\mathcal{M}$ .

A quadratic polynomial  $p_c = z^2 + c$ ,  $c \in \mathcal{M}$ , is *renormalizable* if  $c$  belongs to a small copy of the Mandelbrot set. Let  $\mathcal{M}_s$  be the biggest small copy of  $\mathcal{M}$  containing  $c$ . We set  $\mathbf{R}_{\text{QL}}(c) := \mathbf{R}_s(c)$ . This way we obtain the partial map  $\mathbf{R}_{\text{QL}}: \mathcal{M} \dashrightarrow \mathcal{M}$ .

A map  $p_c$  is *infinitely renormalizable* if  $c$  is within the non-escaping set

$$\text{NE}(\mathbf{R}_{\text{QL}}) := \bigcap_{i \geq 0} \text{Dom } \mathbf{R}_{\text{QL}}^i$$

of  $\mathbf{R}_{\text{QL}}$ . If the connected component of  $\text{NE}(\mathbf{R}_{\text{QL}})$  containing  $c$  is a singleton, then  $\mathcal{M}$  is locally connected at  $c$ . The global MLC conjecture is equivalent to the assertion that every connected component of  $\text{NE}(\mathbf{R}_{\text{QL}})$  is a singleton.



3.1.1. *Analytic renormalization operator.* (See [L3] for details.) Let us write a quadratic-like map as  $f: U \rightarrow V$ , and let us denote by  $[f: U \rightarrow V]$  the quadratic-like germ of  $f$  considered up to affine equivalence. The modulus of the fundamental annulus  $V \setminus \bar{U}$  is the *modulus of  $f$* , denoted by  $\text{mod } f$ . We denote by  $\mathfrak{K}(f)$  and  $\mathfrak{P}(f)$  the non-escaping and postcritical sets of  $f$ .

In [L3] the space  $\mathcal{QL}$  of *quadratic-like germs* is supplied with complex analytic structure. Let  $\mathfrak{M} \subset \mathcal{QL}$  be the connectedness locus; i.e. the set of germs with a non-escaping critical point.

The hybrid classes form a codimension-one lamination  $\mathcal{F}_{\text{QL}}$  of  $\mathfrak{M}$  with complex codimension-one analytic leaves. Every leaf of  $\mathcal{F}_{\text{QL}}$  contains a unique parameter  $c_i$  in the actual Mandelbrot set. By collapsing every  $\mathcal{F}_i \in \mathcal{F}_{\text{QL}}$  to  $c_i$ , we obtain the projection  $\chi: \mathfrak{M} \rightarrow \mathcal{M}$ .

Consider a small copy  $\mathcal{M}_s \subsetneq \mathcal{M}$  of period  $n > 1$ . There is an analytic operator  $\mathcal{R}_s: \mathcal{QL} \dashrightarrow \mathcal{QL}$  associated with  $\mathcal{M}_s$  such that

$$\mathcal{R}_s[f: U \rightarrow V] = [f^n: U_i \rightarrow V_i].$$

We assume that  $V_i$  contains the critical value of  $f$ . The operator  $\mathcal{R}_s$  is defined on a neighborhood of  $\chi^{-1}(\mathcal{M}_s \setminus \{\text{cusp}\})$  and satisfies  $\chi \circ \mathcal{R}_s = \mathbf{R}_s \circ \chi$ .

Combining all  $\mathcal{R}_s$  over all the maximal copies  $\mathcal{M}_s \subsetneq \mathcal{M}$ , we obtain an analytic operator  $\mathcal{R}_{\text{QL}}: \mathcal{QL} \dashrightarrow \mathcal{QL}$  such that (with appropriate choices of branches)

$$\chi \circ \mathcal{R}_{\text{QL}} = \mathbf{R}_{\text{QL}} \circ \chi.$$

3.1.2. *Satellite copies.* Consider a rational number  $\tau \in \mathbb{Q}$  between 0 and 1. We denote by  $\mathcal{M}_\tau \subset \mathcal{M}$  the primary satellite copy of  $\mathcal{M}$  with rotation number  $\tau$ . In other words,  $\mathcal{M}_\tau$  is the unique copy of the Mandelbrot set attached to the parabolic parameter  $p_{c(\tau)} \in \partial\Delta$  with rotation number  $\tau$ . We have the canonical homeomorphism  $\mathbf{R}_\tau: \mathcal{M}_\tau \rightarrow \mathcal{M}$ .

For  $\tau, s \in \mathbb{Q} \cap (0, 1)$ , we write  $\mathcal{M}_{\tau,s} := \mathcal{R}_\tau^{-1}(\mathcal{M}_s)$  and we denote by  $\mathbf{R}_{\tau,s}: \mathcal{M}_{\tau,s} \rightarrow \mathcal{M}$  the canonical homeomorphism. The construction continues by induction. In particular,  $\mathcal{M}_{\tau,s,t} := \mathbf{R}_{\tau,s}^{-1}(\mathcal{M}_t)$ .

3.1.3. *Local connectivity of the Julia set.* An infinitely renormalizable quadratic-like map  $f: U \rightarrow V$  is said to satisfy an *unbranched a priori bounds* (see [McM1]) if there is an  $\varepsilon > 0$  such that for infinitely many  $n$  the renormalization  $f_n := \mathcal{R}_{\text{QL}}^n(f)$  can be written as  $f_n: U_n \rightarrow V_n$  so that

$$(3.1) \quad V_n \cap \mathfrak{P}(f) \subset \mathfrak{K}(f_n)$$

and the modulus of  $V_n \setminus U_n$  is at least  $\varepsilon$ . We will refer to (3.1) as the *unbranched condition*. It is known that any infinitely renormalizable quadratic-like map with unbranched a priori bounds has locally connected Julia set; see [J],[McM1], [L2, Theorem VI] for the reference.

3.2. **Pacmen.** A *full pacman* is a map

$$f: \bar{U} \rightarrow \bar{V}$$

such that (see Figure 1 and [DLS, Definition 2.1])

- $f(\alpha) = \alpha$ ;
- $\bar{U}$  is a closed topological disks with  $\bar{U} \subset V$ ;

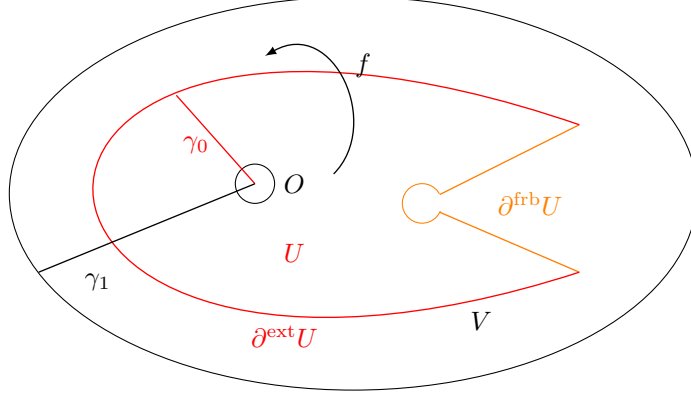

FIGURE 9. A pacman is a truncated version of a full pacman, see Figure 1; it is an almost 2 : 1 map  $f : (U, O_0) \rightarrow (V, O)$  with  $f(\partial U) \subset \partial V \cup \gamma_1 \cup \partial O$ .

- the critical arc  $\gamma_1$  has exactly 3 lifts  $\gamma_0 \subset U$  and  $\gamma_-, \gamma_+ \subset \partial U$  such that  $\gamma_0$  start at the fixed point  $\alpha$  while  $\gamma_-, \gamma_+$  start at the pre-fixed point  $\alpha'$ ; we assume that  $\gamma_1$  does not intersect  $\gamma_0, \gamma_-, \gamma_+$  away from  $\alpha$ ;
- $f : U \rightarrow V$  is analytic and  $f : U \setminus \gamma_0 \rightarrow V \setminus \gamma_1$  is a two-to-one branched covering;
- $f$  admits a locally conformal extension through  $\partial U \setminus \{\alpha'\}$ .

A pacman is obtained from a full pacman by removing a small neighborhood of  $\alpha'$ , see Figure 9. More precisely, a *pacman* is an analytic map

$$(3.2) \quad f : (U, O_0) \rightarrow (V, O)$$

with  $f(\partial U) \subset \partial V \cup \gamma_1 \cup \partial O$  such that

- $O_0$  and  $O$  are disk neighborhoods of  $\alpha$  and  $f$  maps  $O_0$  conformally to  $O_1$ ;
- $f$  admits a locally conformal extension through  $\partial U$ ;
- $f$  can be topologically extended to a full topological pacman.

We recognize the following two subsets of the boundary of  $U$ : the *external boundary*  $\partial^{\text{ext}} U := f^{-1}(\partial V)$  and the *forbidden part of the boundary*  $\partial^{\text{frb}} U := \partial U \setminus \partial^{\text{ext}} U$ .

Given a pacman  $f : U \rightarrow V$ , its *non-escaping set* is

$$\mathfrak{K}_f := \bigcap_{n \geq 0} f^{-n}(\bar{U}),$$

it is sensitive to a small deformation of  $\partial U$ . The *escaping set* of  $f$  is  $V \setminus \mathfrak{K}_f$ .

Let us embed a rectangle  $\mathfrak{R}$  in  $\bar{V} \setminus U$  so that bottom horizontal side is equal to  $\partial^{\text{ext}} U$  and the top horizontal side is a subset of  $\partial V$ . The images of the vertical lines

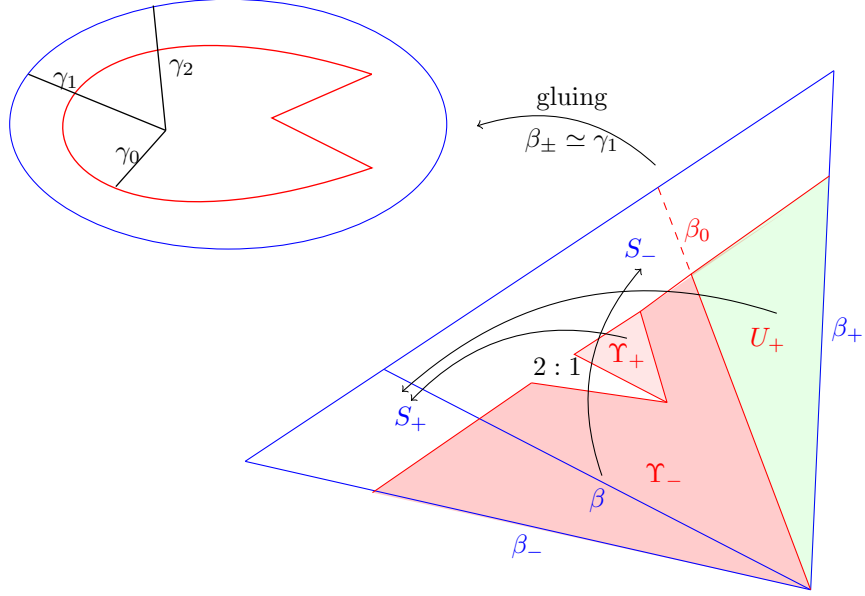

FIGURE 10. A (full) prepacman  $(f_- : U_- \rightarrow S, f_+ : U_+ \rightarrow S)$ . We have  $U_- = \Upsilon_- \cup \Upsilon_+$  and  $f_-$  maps  $\Upsilon_-$  two-to-one to  $S_-$  and  $\Upsilon_+$  to  $S_+$ . The map  $f_+$  maps  $U_+$  univalently onto  $S_+$ . After gluing dynamically  $\beta_-$  and  $\beta_+$  we obtain a full pacman: the arc  $\beta_-$  and  $\beta_+$  project to  $\gamma_1$ , the arc  $\beta_0$  projects to  $\gamma_0$ , and the arc  $\beta$  projects to  $\gamma_2$ .

within  $\mathfrak{R}$  form a lamination of  $\overline{V} \setminus U$ . We pull back this lamination to all iterated preimages  $f^{-n}(\mathfrak{R})$ . Leaves of this lamination that start at  $\partial V$  are called *external ray segments* of  $f$ ; infinite external ray segments are called *external rays* of  $f$ . Note that if  $\gamma$  is an external ray, then  $f(\gamma) := f(\gamma \cap U)$  is also an external ray. Every external ray  $\gamma$  has a well defined external angle  $\phi$  such that the angle of  $f(\gamma)$  is  $2\phi$ , see [DLS, §2.1].

3.2.1. *Prepacmen.* (See Figure 10 and [DLS, Definition 2.2].) A *prepacman*  $F = (f_{\pm} : U_{\pm} \rightarrow S)$  is a pair of commuting maps obtained by cutting a pacman  $f : U \rightarrow V$  along its critical arc  $\gamma_1$ . There is a gluing map  $\psi : S \rightarrow V$ , called *renormalization change of variables*, such that

- $\psi$  projects  $(f_-, f_+)$  onto  $f$
- $\psi$  projects  $\beta_-$  and  $\beta_+$  to  $\gamma_1$  via  $\beta_- \ni f_-(x) \sim f_+(x) \in \beta_+$ .

Dynamical objects (such as the non-escaping set) of a prepacman  $F$  are preimages of the corresponding dynamical objects of  $f$  under  $\psi$ .

3.2.2. *Pacman renormalization.* (See Figure 11.) We say that a holomorphic map  $f : (U, \alpha) \rightarrow (V, \alpha)$  with a distinguished  $\alpha$ -fixed point is *pacman renormalizable* if there exists a prepacman

$$G = (g_- = f^a : U_- \rightarrow S, g_+ = f^b : U_+ \rightarrow S)$$

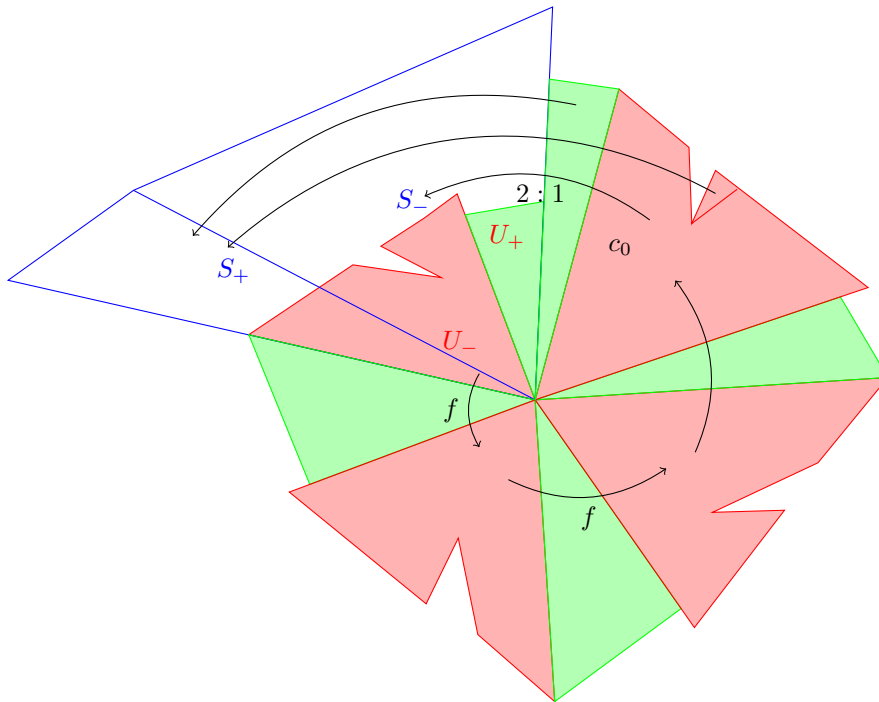

FIGURE 11. Pacman renormalization of  $f$ : the first return map of points in  $U_- \cup U_+$  back to  $S = S_- \cup S_+$  is a prepacman. Spreading around  $U_{\pm}$ : the orbits of  $U_-$  and  $U_+$  before returning back to  $S$  triangulate a neighborhood  $\Delta$  of  $\alpha$ ; we obtain  $f: \Delta \rightarrow \Delta \cup S$ , and we require that  $\Delta$  is compactly contained in  $\text{Dom } f$ .

defined on a sector  $S \subset V$  with vertex at  $\alpha$  such that  $g_-, g_+$  are iterates of  $f$  realizing the first return map to  $S$  and such that the  $f$ -orbits of  $U_-, U_+$  before they return to  $S$  cover a neighborhood of  $\alpha$  compactly contained in  $U$ . We call  $G$  the *pre-renormalization* of  $f$  and the pacman  $g: \widehat{U} \rightarrow \widehat{V}$  is the *renormalization* of  $f$ . By default, we assume that  $S$  contains a critical value of  $f$ .

The numbers  $\mathbf{a}, \mathbf{b}$  are the *renormalization return times*. The renormalization of  $f$  is called *prime* if  $\mathbf{a} + \mathbf{b} = 3$ . Combinatorially, a pacman renormalization is an iteration of prime renormalizations, see §2.

We define  $\Delta = \Delta_G$  to be the union of points in the  $f$ -orbits of  $\overline{U}_-, \overline{U}_+$  before they return to  $S$ . Naturally,  $\Delta$  is a triangulated neighborhood of  $\alpha$ , see Figure 11. We call  $\Delta$  a *renormalization triangulation* and we will often say that  $\Delta$  is obtained by *spreading around*  $U_-, U_+$ . We require  $\Delta_G \in \text{Dom } f$  and  $\Delta_G \cup S \in \text{Im } f$ .

An *indifferent pacman* is a pacman with indifferent  $\alpha$ -fixed point. The *rotation number* of an indifferent pacman  $f$  is  $\theta \in \mathbb{R}/\mathbb{Z}$  so that  $\mathbf{e}(\theta)$  is the multiplier at  $\alpha(f)$ . If, in addition,  $\theta \in \mathbb{Q}$ , then  $f$  is *parabolic*. A pacman renormalization of an indifferent pacman is again an indifferent pacman.

**3.2.3. Banach neighborhoods.** (See [DLS, §2.4].) Consider a pacman  $f: (U_f, O_0, \gamma_0) \rightarrow (V, O, \gamma_1)$  with a non-empty truncation disk  $O$ . We assume that there is a topological disk  $\widetilde{U} \ni U_f$  with a piecewise smooth boundary such that  $f$  extends analytically

to  $\tilde{U}$  and continuously to its closure. Choose a small  $\varepsilon > 0$  and define  $N_{\tilde{U}}(f, \varepsilon)$  to be the set of analytic maps  $g : \tilde{U} \rightarrow \mathbb{C}$  with continuous extensions to  $\partial\tilde{U}$  such that

$$\sup_{z \in \tilde{U}} |f(z) - g(z)| < \varepsilon.$$

Then  $N_{\tilde{U}}(f, \varepsilon)$  is a Banach ball.

**3.2.4. Pacman analytic operator.** (See [DLS, §2.5].) Suppose that a pacman  $\hat{f} : \hat{U} \rightarrow \hat{V}$  is a renormalization of a holomorphic map  $f : (U, \alpha) \rightarrow (V, \alpha)$  via a quotient map  $\psi_f : S_f \rightarrow \hat{V}$ . Assume that the curves  $\beta_0, \beta_-, \beta_+$  (see Figures 10 and 11) land at  $\alpha$  at pairwise distinct well-defined angles. Then for every sufficiently small neighborhood  $N_{\tilde{U}}(f, \varepsilon)$ , there exists a compact analytic pacman renormalization operator  $\mathcal{R} : g \mapsto \hat{g}$  defined on  $N_{\tilde{U}}(f, \varepsilon)$  such that  $\mathcal{R}(f) = \hat{f}$ . Moreover, the gluing map  $\psi_g$ , used in this renormalization, also depends analytically on  $g$ . Note that the operator  $\mathcal{R}$  is non-dynamical: it goes from a small Banach neighborhood of  $f$  (where  $f$  needs not be a pacman) to a certain small Banach neighborhood of the pacman  $\hat{f}$ .

**3.2.5. Siegel pacmen.** (See [DLS, §3]) A holomorphic map  $f : U \rightarrow V$  is *Siegel* if it has a fixed point  $\alpha$ , a Siegel quasidisk  $\bar{Z}_f \ni \alpha$  compactly contained in  $U$ , and a unique critical point  $c_0 \in U$  that is on the boundary of  $Z_f$ . Note that in [AL2] a Siegel map is assumed to satisfy additional technical requirements; these requirements are satisfied by restricting  $f$  to an appropriate small neighborhood of  $\bar{Z}_f$ .

It follows from [AL2, Theorem 3.19, Proposition 4.3] that any two Siegel maps with the same rotation number are hybrid conjugate on neighborhoods of their closed Siegel disks.

A pacman  $f : U \rightarrow V$  is *Siegel* if

- $f$  is a Siegel map with Siegel disk  $Z_f$  centered at  $\alpha$ ;
- the critical arc  $\gamma_1$  is the concatenation of an external ray  $R_1$  followed by an inner ray  $I_1$  of  $Z_f$  such that the unique point in the intersection  $\gamma_1 \cap \partial Z_f$  is not precritical; and
- writing  $f : (U, O_0) \rightarrow (V, O)$  as in (3.2), the disk  $O$  is a subset of  $Z_f$  bounded by its equipotential.

The *rotation number* of a Siegel pacman (or a Siegel map) is  $\theta \in \mathbb{R}/\mathbb{Z}$  so that  $e(\theta)$  is the multiplier at  $\alpha$ . It follows that the rotation number of Siegel map is in  $\Theta_{\text{bnd}}$ .

If  $f$  is a Siegel pacman, then all external rays of  $f$  land. Moreover,  $\partial Z_f$  is in the closure of repelling periodic points, and every neighborhood of  $\partial Z_f$  contains a repelling periodic cycle.

A Siegel pacman is *standard* if  $\gamma_0$  passes through the critical value; equivalently if  $\gamma_1$  passes through the image of the critical value. By [DLS, Corollary 3.7 and Lemma 3.4] every Siegel map can be renormalized to a standard Siegel pacman.

**3.2.6. Hyperbolic pacman self-operator.** Let us now fix  $\theta_\star := \theta$  from Theorem 1.1 with  $\mathbf{R}_{\text{prm}}^{\text{m}}(c(\theta_\star)) = c(\theta_\star)$ . By [DLS, Theorems 3.16 and 7.7], there is a compact analytic hyperbolic pacman renormalization operator  $\mathcal{R} : N_{\tilde{U}}(f_\star, \varepsilon) \rightarrow N_{\tilde{U}}(f_\star, \delta)$  with a fixed standard Siegel pacman  $\mathcal{R}f_\star = f_\star$  such that the rotation angle of  $f_\star$  is  $\theta_\star$ . We write the operator as  $\mathcal{R} : \mathcal{B} \dashrightarrow \mathcal{B}$ , where  $\mathcal{B} = N_{\tilde{U}}(f_\star, \delta)$ . The renormalization  $\mathcal{R}f_\star = f_\star$  restricted to the Siegel quasidisk  $\bar{Z}_\star$  of  $f_\star$  is a sector

renormalization of the rotation  $f_\star: \overline{Z}_\star \rightarrow \overline{Z}_\star$ ; this sector renormalization is the  $m$ -th iterate of the prime renormalization (see §2.1). Without loss of generality, we allow ourselves to pass to a bigger period  $m$  in order to guarantee a sufficient improvement of the domain during the renormalization, see (3.13).

The renormalization operator  $\mathcal{R}: \mathcal{B} \dashrightarrow \mathcal{B}$  is hyperbolic at  $f_\star$  with one-dimensional unstable manifold  $\mathcal{W}^u$  and codimension-one stable manifold  $\mathcal{W}^s$ . In a small neighborhood of  $f_\star$  the stable manifold  $\mathcal{W}^s$  coincide with the set of pacmen in  $\mathcal{B}$  that have the same multiplier at the  $\alpha$ -fixed point as  $f_\star$ . Every pacman in  $\mathcal{W}^s$  is Siegel. In a small neighborhood of  $f_\star$  the unstable manifold  $\mathcal{W}^u$  is parametrized by the multipliers of the  $\alpha$ -fixed points of  $f \in \mathcal{W}^u$ .

The renormalization change of variables  $\psi_f: S_f \rightarrow V$  associated with  $\mathcal{R}f$  is defined near the critical value; i.e.  $S_f \ni c_1(f)$  and  $\psi_f(c_1(f)) = c_1(\mathcal{R}f)$ .

**3.2.7. Combinatorics of  $\mathcal{R}: \mathcal{B} \dashrightarrow \mathcal{B}$ .** Since the renormalization  $\mathcal{R}f_\star = f_\star$  restricted to the Siegel quasidisk  $\overline{Z}_\star$  is the  $m$ -th iterate of the prime renormalization, we have (see §2.1):

$$(3.3) \quad \theta_\star = R_{\text{prm}}^m(\theta_\star).$$

**Lemma 3.1** ([DLS, Lemma 3.17]). *If  $f \in \mathcal{B}$  is an indifferent pacman with a rotation number  $\theta$ , then  $\mathcal{R}f$  is again an indifferent pacman with rotation number  $R_{\text{prm}}^m(\theta)$ .*

Since the unstable manifold  $\mathcal{W}^u$  is parametrized by the multipliers of the  $\alpha$ -fixed points, the unstable eigenvalue  $\lambda_\star$  is equal to the derivative  $(R_{\text{prm}}^m)'(\theta_\star)$ .

Let  $\mathbb{M}$  be the antirenormalization matrix associated with (3.3), see (2.8). Recall that  $\mathbb{M}$  has positive entrances. As in §2.1.1, let  $\mathfrak{t}$  be the leading eigenvalue of  $\mathbb{M}$ . By Lemma 2.1,

$$(3.4) \quad \lambda_\star = \mathfrak{t}^2.$$

**3.2.8. Operators on near Siegel maps.** Consider a Siegel map  $g$  with rotation angle  $\theta_g$ . Suppose  $R_{\text{prm}}^k(\theta_g) = \theta_\star$  for some  $k \geq 0$ . Then  $g$  can be renormalized to a pacman on the stable manifold of  $f_\star$ , see [DLS, Corollary 3.7 and Lemma 7.8]. This allows us to define a compact analytic renormalization operator  $\mathcal{R}_{\text{Sieg}}: \mathcal{A} \rightarrow \mathcal{B}$  with  $\mathcal{R}_{\text{Sieg}}(g) \in \mathcal{W}^s$ , where  $\mathcal{A}$  is a small Banach neighborhood of  $g$ .

**3.2.9. Maximal prepacmen.** (See [DLS, §5].) Every pacman  $f \in \mathcal{W}^u$ , can be anti-renormalized infinitely many times. For  $n \leq 0$ , we write  $f_n := \mathcal{R}^n f$  and we denote by  $F_n$  the associated prepacman (obtained by cutting  $f_n$  along its critical arc  $\gamma_1$ ). Let  $\psi_n: S_n \rightarrow V$  be the renormalization change of variables realizing the renormalization of  $f_{n-1}$ . This means that there is a prepacman

$$\begin{aligned} F_n^{(n-1)} &= \left( f_{n,\pm}^{(n-1)}: U_{n,\pm}^{(n-1)} \rightarrow S^{(n-1)} \right) \\ &= \left( f_{n-1}^{\mathbf{a}}: U_{n,-}^{(n-1)} \rightarrow S^{(n)}, \quad f_{n-1}^{\mathbf{b}}: U_{n,+}^{(n-1)} \rightarrow S^{(n)} \right), \end{aligned}$$

in the dynamical plane of  $f_n$  such that  $\psi_n$  projects  $F_n^{(n-1)}$  to  $f_n$ . We also say that  $\psi_n^{-1}$  embeds  $F_n$  to the dynamical plane of  $f_n$ , and we call  $F_n^{(n-1)}$  the *embedding*.

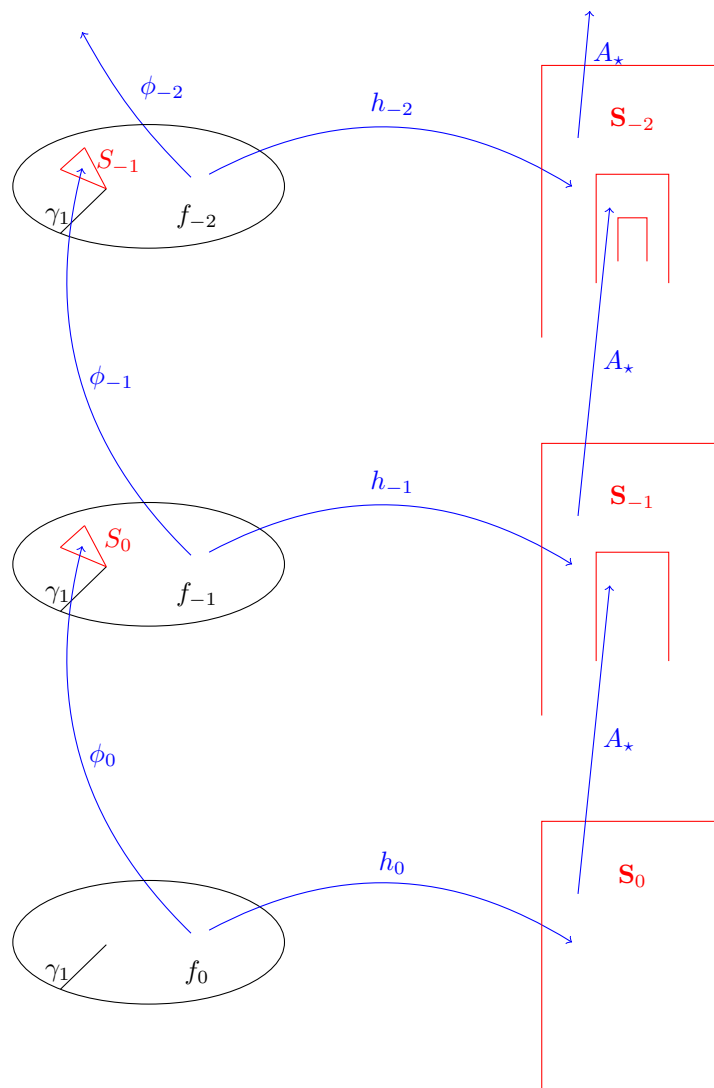

FIGURE 12. Tower of antirenormalizations.

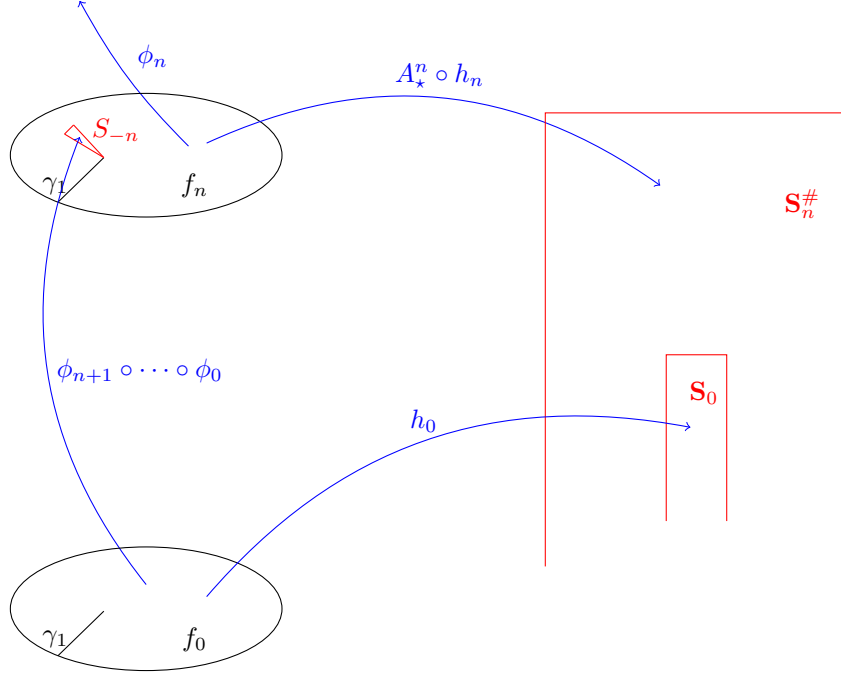

FIGURE 13.  $\mathbf{S}_n^\# = A_\star^n \mathbf{S}_n$  and  $\bigcup_{n \leq 0} \mathbf{S}_n^\# = \mathbb{C}$ , compare with Figure 12.

Write

$$\begin{aligned} \psi_\star &= \psi_{f_\star}, \\ \mu_\star &:= (\psi_\star^{-1})'(c_1), \\ A_\star &: z \mapsto \mu_\star z, \\ T_n &: z \mapsto z - c_1(f_n). \end{aligned}$$

Then the limit

$$(3.5) \quad h_0(z) := \lim_{n \rightarrow -\infty} A_\star^n \circ T_{n+1} \circ (\psi_{n+1}^{-1} \circ \dots \circ \psi_{-1}^{-1} \circ \psi_0^{-1}(z))$$

exists; similarly  $h_n$  are defined for  $n \leq 0$ . The maps  $h_n$  linearize  $\psi$ -coordinates (see Figure 12): let

$$(3.6) \quad \mathbf{F} = (\mathbf{f}_\pm : \mathbf{U}_\pm \rightarrow \mathbf{S})$$

be the image of  $F = F_0$  via  $h_0$  (i.e.  $\mathbf{S} :=$  is the closure of  $h_0(V \setminus \gamma_1)$ , and  $\mathbf{f}_\pm := h_0 \circ f_\pm \circ h_0^{-1}$ ), then  $\mathbf{f}_{0,\pm}$  are iterations of  $\mathbf{f}_{n,\pm}$  rescaled by  $A_\star^n$  (see (3.11) below).

Let  $g : X \rightarrow Y$  be a holomorphic map between Riemann surfaces. Recall that  $g$  is:

- proper, if  $g^{-1}(K)$  is compact for each compact  $K \subset Y$ ;
- $\sigma$ -proper (see [McM2, §8]) if each component of  $g^{-1}(K)$  is compact for each compact  $K \subset Y$ ; or equivalently if  $X$  and  $Y$  can be expressed as increasing unions of subsurfaces  $X_i, Y_i$  such that  $g : X_i \rightarrow Y_i$  is proper.



A proper map is clearly  $\sigma$ -proper.

[DLS, Theorem 5.5] asserts that  $\mathbf{f}_\pm$  admit maximal analytic extension to  $\sigma$ -proper maps of the complex plane; we call the pair of extensions

$$(3.7) \quad \mathbf{F} = (\mathbf{f}_- : \mathbf{X}_- \rightarrow \mathbb{C}, \quad \mathbf{f}_+ : \mathbf{X}_+ \rightarrow \mathbb{C}),$$

a *maximal prepacman*. The maximal extension (3.7) is obtained by iterating a certain number of times in the dynamical plane of  $f_k$ ,  $k \leq 0$ . Namely, a big open topological disk  $\mathbf{D}^k$  around 0 in the dynamical plane of  $\mathbf{F}$  is identified via  $A_\star^k \circ h_k$  with a fixed disk  $D$  in the dynamical plane of  $f_k$  around the critical value  $c_1(f_k)$ , compare with Figure 13. Moreover,  $D$  also contains  $f_k^{\mathbf{a}_k}(c_1)$  and  $f_k^{\mathbf{b}_k}(c_1)$  for certain  $\mathbf{a}_k, \mathbf{b}_k$ . Let  $W_-^{(k)}$  and  $W_+^{(k)}$  be the pullbacks of  $D$  along the orbits  $c_1, f_k(c_1), \dots, f_k^{\mathbf{a}_k}(c_1)$  and  $c_1, f_k(c_1), \dots, f_k^{\mathbf{b}_k}(c_1)$  respectively. This way we obtain a pair of branched coverings (see [DLS, (5.9)])

$$(3.8) \quad (f_k^{\mathbf{a}_k} : W_-^{(k)} \rightarrow D, \quad f_k^{\mathbf{b}_k} : W_+^{(k)} \rightarrow D).$$

(The main step is to show that the backward orbits of  $D$  in these pullbacks do not hit  $\partial^{\text{fib}}U_k$ , see Figure 9.) Then  $A_\star^k \circ h_k$  conjugates (3.8) to the pair

$$(3.9) \quad (\mathbf{f}_- : \mathbf{W}_-^{(k)} \rightarrow \mathbf{D}^k, \quad \mathbf{f}_+ : \mathbf{W}_+^{(k)} \rightarrow \mathbf{D}^k)$$

so that  $\bigcup_{k \ll 0} \mathbf{D}^k = \mathbb{C}$  and

$$\text{Dom } \mathbf{f}_- = \bigcup_{k \ll 0} \mathbf{W}_-^{(k)}, \quad \text{Dom } \mathbf{f}_+ = \bigcup_{k \ll 0} \mathbf{W}_+^{(k)}.$$

It follows from the construction that  $\text{Dom } \mathbf{f}_-$  and  $\text{Dom } \mathbf{f}_+$  are simply connected.

Let

$$\mathbf{F}_n^\# = (\mathbf{f}_{n,-}^\#, \mathbf{f}_{n,+}^\#) := A_\star^n \circ \mathbf{F}_n \circ A_\star^{-n}$$

be the rescaled version of  $\mathbf{F}_n$ , see Figure 13. Then  $\mathbf{F}_n^\#$  is an iteration of  $\mathbf{F}_{n-1}^\#$ : writing the antirenormalization matrix as

$$(3.10) \quad \mathfrak{M} := \begin{pmatrix} m_{1,1} & m_{1,2} \\ m_{2,1} & m_{2,2} \end{pmatrix}$$

we obtain

$$(3.11) \quad \begin{cases} \mathbf{f}_{n,-}^\# = \left( \mathbf{f}_{n-1,-}^\# \right)^{m_{1,1}} \circ \left( \mathbf{f}_{n-1,+}^\# \right)^{m_{1,2}} \\ \mathbf{f}_{n,+}^\# = \left( \mathbf{f}_{n-1,-}^\# \right)^{m_{2,1}} \circ \left( \mathbf{f}_{n-1,+}^\# \right)^{m_{2,2}} \end{cases} .$$

In particular,  $\mathbf{F} = \mathbf{F}_0^\#$  is an iteration of  $\mathbf{F}_n^\#$ .

**3.2.10. Renormalization triangulation.** (See [DLS, §4.1] and Figure 14.) For a pacman  $f_0 \in \mathcal{B}$  its *0th renormalization triangulation*  $\Delta_0(f_0)$  consists of two closed triangles  $\Delta_0(0, f_0)$  and  $\Delta_0(1, f_0)$  that are the closures of the connected components of  $U_0 \setminus (\gamma_0 \cup \gamma_1)$ . For  $n > 0$ , the *nth renormalization triangulation*  $\Delta_n(f_0)$  consists of all the triangles obtained by spreading around  $\Delta_n(0, f_0)$  and  $\Delta_0(1, f_0)$  (compare with Figure 11), where the latter triangles are the embeddings of  $\Delta_0(0, f_n)$  and  $\Delta_0(1, f_n)$  to the dynamical plane of  $f_0$ . We also say that  $\Delta_n(f_0)$  is the *full lift* of  $\Delta_0(f_n)$ . [DLS, Theorem 4.6] asserts that  $\Delta_m(f)$  approximates  $\bar{Z}_\star$  dynamically and geometrically.

More precisely, suppose  $f_0 \in \mathcal{B}$  is renormalizable  $m \geq 1$  times. We write

$$\phi_k := \psi_k^{-1}.$$

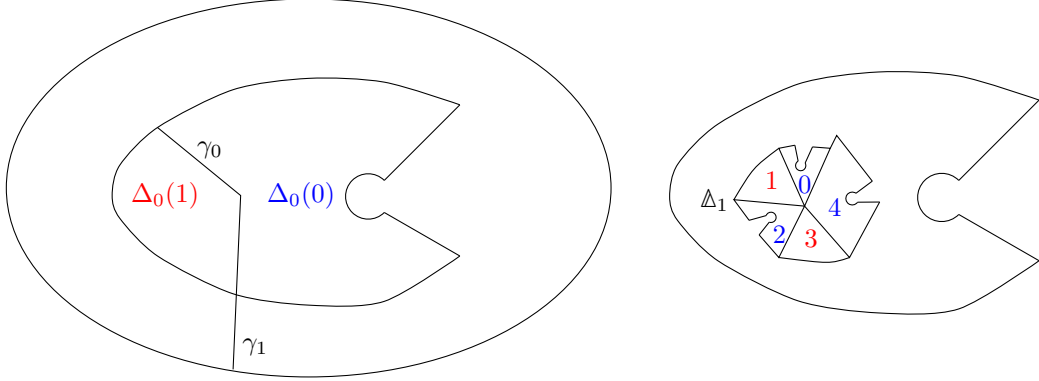

FIGURE 14. Left: the triangulation  $\Delta_0 = \Delta_0(0) \cup \Delta_0(1)$ . The closed triangles  $\Delta_0(0)$  and  $\Delta_1(1)$  are the closures of the connected components of  $U \setminus (\gamma_0 \cup \gamma_1)$ . Right: the triangulation  $\Delta_1(f_0)$  is obtained by spreading around  $\Delta_1(0, f_0)$  and  $\Delta_1(1, f_0)$  – the embeddings of  $\Delta_0(0, f_1)$  and  $\Delta_0(1, f_1)$  into the dynamical plane of  $f_0$ .

The map

$$\Phi_m := \phi_1 \circ \phi_2 \circ \cdots \circ \phi_m$$

admits a conformal extension from a neighborhood of  $c_1(f_m)$  (where  $\Phi_m$  is defined canonically) to  $V \setminus \gamma_1$ . The map  $\Phi_m: V \setminus \gamma_1 \rightarrow V$  embeds the prepacman  $F_n$  to the dynamical plane of  $f_0$ ; we denote the embedding by

$$\begin{aligned} F_m^{(0)} &= \left( f_{m,\pm}^{(0)}: U_{m,\pm}^{(0)} \rightarrow S_m^{(0)} \right) \\ &= \left( f_0^{\mathbf{a}_m}: U_{m,-}^{(0)} \rightarrow S_m^{(0)}, \quad f_0^{\mathbf{b}_m}: U_{m,+}^{(0)} \rightarrow S_m^{(0)} \right), \end{aligned}$$

where the numbers  $\mathbf{a}_m, \mathbf{b}_m$  are the renormalization return times satisfying

$$(3.12) \quad \begin{pmatrix} \mathbf{a}_m \\ \mathbf{b}_m \end{pmatrix} = \mathbb{M}^{m-1} \begin{pmatrix} \mathbf{a} \\ \mathbf{b} \end{pmatrix} = \mathbb{M}^m \begin{pmatrix} 1 \\ 1 \end{pmatrix}.$$

Write  $\Delta_n(0, f_0) := \overline{U_{m,+}^{(0)}}$  and  $\Delta_n(1, f_0) := \overline{U_{m,-}^{(0)}}$ . Then  $\Delta_m$  consists of triangles  $\{f_0^i(\Delta_n(0, f_0)) \mid i \in \{0, 1, \dots, \mathbf{a}_m - 1\}\} \cup \{f_0^i(\Delta_n(1, f_0)) \mid i \in \{0, 1, \dots, \mathbf{b}_m - 1\}\}$ .

We enumerate counterclockwise these triangles as  $\Delta_n(i)$  with  $i \in \{0, 1, \dots, \mathbf{q}_n - 1\}$ . By construction,  $\Delta_n(0, 1) := \Delta_n(0) \cup \Delta_n(1)$  contains the critical value  $c_1$ , while  $\Delta_n(-\mathbf{p}_n, -\mathbf{p}_n + 1)$  contains a critical point, where  $\mathbf{p}_n/\mathbf{q}_n$  is the *combinatorial rotation number* of  $f \mid \Delta_n$ .

We have:

$$(3.13) \quad \Delta_n(f) \Subset \Delta_{n-1}(f) \Subset \cdots \Subset \Delta_1(f) \Subset \Delta_1(f) \cup S_f \Subset \Delta_0(f),$$

and renormalization sector  $S_f$  is disjoint from  $\gamma_1$  away from a small neighborhood of  $\alpha$ .

3.2.11. *Walls  $\mathbb{P}_n$  of  $\Delta_n$ .* Consider the dynamical plane of a pacman  $f$ . By a *univalent  $N$ -wall* we mean a closed annulus  $A$  surrounding an open disk  $O$  containing  $\alpha$ , such that  $f \mid O \cup A$  is univalent, and for every  $z \in O$ , we have  $(f \mid A \cup O)^{\pm k}(z) \in A \cup O$  for  $k \in \{0, 1, \dots, N\}$ . In other words, it takes at least  $N$  iterates for a point in  $O$  to cross  $A$ . An  *$N$ -wall* is an annulus  $A$  surrounding an open disk  $O$  containing  $\alpha$  such that  $A$  contains a univalent  $N$ -wall. A wall  $A$  *respects*  $\gamma_0, \gamma_1$  if  $A \cap \gamma_0$  and  $A \cap \gamma_1$  are two arcs.

Just like  $\Delta_n(f)$  approximates  $\bar{Z}_*$ , the wall  $\mathbb{P}_n$  of  $\Delta_n(f)$  approximates  $\partial Z_*$ . In the dynamical plane of  $f_*$  consider its Siegel disk  $Z_*$ . It is foliated by equipotentials parametrized by their heights ranging from 0 (the height of  $\alpha$ ) to 1 (the height of  $\partial Z_*$ ). Fix an  $r \in (0, 1)$  and consider the open subdisk  $Z^r$  of  $Z_*$  bounded by the equipotential at height  $r$ . Consider next  $f \in \mathcal{W}^u$  close to  $f_*$ . Then  $\gamma_0(f)$  and  $\gamma_1(f)$  still intersect  $\partial Z^r$  at single points. The *wall  $\mathbb{P}_0(f)$  of  $\Delta_0(f)$*  is the closed annulus  $\Delta_0(f) \setminus Z^r$  consisting of rectangles

$$\mathbb{P}_0(0) = \mathbb{P} \cap \Delta_0(0) \text{ and } \mathbb{P}_0(1) = \mathbb{P} \cap \Delta_0(1).$$

Suppose that  $f_n$  with  $n > 0$  is sufficiently close to  $f_*$  so that  $\mathbb{P}_0(f_n)$  is defined. Let  $\mathbb{P}_n(0, f_0)$  and  $\mathbb{P}_n(1, f_0)$  be the embedding of the rectangles  $\mathbb{P}_0(0, f_n)$  and  $\mathbb{P}_0(1, f_n)$  into the dynamical plane of  $f_0$ , see [DLS, Lemma 4.2, (2)]. The *wall  $\mathbb{P}_n = \mathbb{P}_n(f)$  of  $\Delta_n(f)$*  is obtained by spreading around  $\mathbb{P}_n(0, f_0)$  and  $\mathbb{P}_n(1, f_0)$ . The wall  $\mathbb{P}_n$  consists of rectangles  $\mathbb{P}_n(i) = \mathbb{P}_n \cap \Delta_n(i)$ . We have  $\mathbb{P}_n(f_0) \Subset \mathbb{P}_{n-1}(f_0)$  is an annulus approximating  $\partial Z_*$  and, moreover, the dynamics  $f \mid (\Delta_n \setminus \mathbb{P}_n)$  is univalent.

3.2.12. *Siegel triangulation.* A Siegel triangulation  $\Delta(f)$  is a triangulation mimicking properties of  $\Delta_n(f)$ . We may think that  $\Delta(f)$  is a qc image of  $\Delta_n(f)$  changing the spiral speed of the triangles near  $\alpha$ . More precisely, a *Siegel triangulation  $\Delta$*  is a triangulated neighborhood of  $\alpha$  consisting of closed triangles, each has a vertex at  $\alpha$ , such that

- triangles of  $\Delta$  are  $\{\Delta(i)\}_{i \in \{0, \dots, q\}}$  enumerated counterclockwise around  $\alpha$  so that  $\Delta(i)$  intersects only  $\Delta(i-1)$  (on the right) and  $\Delta(i+1)$  (on the left);  $\Delta(i)$  and  $\Delta(i+j)$  are disjoint away from  $\alpha$  for  $j \notin \{-1, 0, 1\}$ ;
- there is a  $\mathfrak{p} > 0$  such that  $f$  maps  $\Delta(i)$  to  $\Delta(i+\mathfrak{p})$  for all  $i \notin \{-\mathfrak{p}, -\mathfrak{p}+1\}$ ;
- $\Delta$  has a distinguished 2-wall  $\mathbb{P}$  enclosing  $\alpha$  and containing  $\partial \Delta$  such that each  $\mathbb{P}(i) := \mathbb{P} \cap \Delta(i)$  is connected and  $f$  maps  $\mathbb{P}(i)$  to  $\mathbb{P}(i+\mathfrak{p})$  for all  $i \notin \{-\mathfrak{p}, -\mathfrak{p}+1\}$ ; and
- $\mathbb{P}$  contains a univalent 2-wall  $Q$  such that each  $Q(i) := Q \cap \mathbb{P}(i)$  is connected and  $f$  maps  $Q(i)$  to  $Q(i+\mathfrak{p})$  for all  $i \notin \{-\mathfrak{p}, -\mathfrak{p}+1\}$ .

We say that  $\mathbb{P}$  *approximates*  $\partial Z_*$  if  $\partial Z_*$  is a concatenation of arcs  $J_0 J_1 \dots J_{q-1}$  such that  $\mathbb{P}(i)$  and  $J_i$  are close in the Hausdorff topology.

**Lemma 3.2** ([DLS, Lemma 4.4]). *Let  $f \in \mathcal{B}$  be a pacman such that all  $f, \mathcal{R}f, \dots, \mathcal{R}^n f$  are in a small neighborhood of  $f_*$ . Let  $\Delta(\mathcal{R}^n f)$  be a Siegel triangulation in the dynamical plane of  $\mathcal{R}^n f$  such that  $\mathbb{P}(\mathcal{R}^n f)$  approximates  $\partial Z_*$ . Then  $\Delta(\mathcal{R}^n f)$  has a full lift  $\Delta(f)$  which is again a Siegel triangulation. Moreover,  $\mathbb{P}(f)$  also approximates  $\partial Z_*$ .*

If  $f_0 \in \mathcal{W}^u$  has a Siegel triangulation  $\Delta(f_0)$ , then  $\Delta(f_0)$  has a full lift  $\Delta(f_n)$  converging to  $\bar{Z}_*$  as  $n \rightarrow -\infty$ .

3.2.13. *Renormalization change of variable near  $c_0$ .* We will consider in §9.3 the renormalization change of variables  $\psi_0$  defined on a neighborhood of the critical point  $c_0$ ; i.e.  $\psi_0(c_0(f)) = c_0(f_1)$  and  $\psi_0$  projects the first return of  $f$  to  $f_1 = \mathcal{R}f$ . If  $\psi: S \rightarrow V$  is the renormalization change of variables near the critical value as above, then  $\psi_0$  is uniquely characterized by

$$\psi \circ f = f_1 \circ \psi_0.$$

We have  $\text{Dom } \psi_0 = f^{-1}(S)$  and  $\text{Im } \psi_0 = \text{Dom } f_1$ .

3.2.14. *Parabolic pacmen.* (See [DLS, §6]) In a small neighborhood of  $f_*$  consider a parabolic pacman  $f_\tau \in \mathcal{W}^u$  with rotation number  $\tau = \mathfrak{p}/\mathfrak{q}$  close to  $\theta_*$ . We denote by  $H_0$  a small attracting parabolic flower around  $\alpha$ . Petals in  $H_0$  are enumerated counterclockwise as  $H_0^i$  with  $i \in \{0, 1, \dots, \mathfrak{q} - 1\}$

We assume that  $H_0$  is small enough so that  $H_0 \subset V \setminus \gamma_1$ , possibly up to a slight rotation of  $\gamma_1$ . Therefore, the flower  $H_0$  lifts to the dynamical plane of  $\mathbf{F}_\tau$  via the identification  $V \setminus \gamma_1 \simeq \text{int } \mathbf{S}$ ; we denote by  $\mathbf{H}_0$  the lift. The *global attracting basin*  $\mathbf{H}$  of  $\mathbf{F}_\tau$  is the full orbit of  $\mathbf{H}_0$ . There are Fatou coordinates in  $\mathbf{H}_0$ ; globalizing the Fatou coordinates we obtain that  $0 \in \mathbf{H}$ . [DLS, Proposition 6.5] parametrizes periodic components of  $\mathbf{H}$  as  $\mathbf{H}^i$  from left-to-right with  $0 \in \mathbf{H}^0$ , see Figure 32. Every petal  $\mathbf{H}^i$  is an open topological disk in  $\widehat{\mathbf{C}}$ . By re-enumerating, we assume that the lift  $\mathbf{H}_0^0$  of  $H_0^0$  is contained in  $\mathbf{H}^0$ . Note that  $\mathbf{H}_0^0$  is disjoint from  $\partial\mathbf{H}^0$ . The actions of  $\mathbf{f}_{n,\pm}^\#$  on  $(\mathbf{H}^i)_{i \in \mathbb{Z}}$  are given by (see [?SLD, (6.7)])

$$(3.14) \quad \mathbf{f}_{n,-}^\#(\mathbf{H}^i) = (\mathbf{H}^{i-\mathfrak{p}n}) \text{ and } \mathbf{f}_{n,+}^\#(\mathbf{H}^i) = \mathbf{H}^{i+\mathfrak{q}n-\mathfrak{p}n},$$

where  $\mathfrak{p}_n/\mathfrak{q}_n$  is the rotation number of  $f_n$ .

3.2.15. *The molecule map.* (See [DLS, Appendix C].) Consider a primary  $\mathfrak{p}/\mathfrak{q}$ -limb  $\mathcal{L}_{\mathfrak{p}/\mathfrak{q}}$  of the Mandelbrot set. In the dynamical plane of  $p \in \mathcal{L}_{\mathfrak{p}/\mathfrak{q}}$  there are exactly  $\mathfrak{q}$  external rays landing at the  $\alpha$ -fixed point; these rays are permuted as  $\mathfrak{p}/\mathfrak{q}$ . We can apply the Branner–Douady surgery [BD] and delete the smallest sector between external rays  $\gamma, p(\gamma)$  landing at  $\alpha$  (as with the prime renormalization of a rotation); the result is a map  $\mathbf{R}_{\text{prm}}(p) \in \mathcal{L}_{R_{\text{prm}}(\mathfrak{p}/\mathfrak{q})}$ , where  $R_{\text{prm}}(\mathfrak{p}/\mathfrak{q})$  is defined in (2.3). This defines a partial continuous map  $\mathbf{R}_{\text{prm}}: \mathcal{L}_{\mathfrak{p}/\mathfrak{q}} \dashrightarrow \mathcal{L}_{R_{\text{prm}}(\mathfrak{p}/\mathfrak{q})}$  whose inverse is an embedding of  $\mathcal{L}_{R_{\text{prm}}(\mathfrak{p}/\mathfrak{q})}$  into  $\mathcal{L}_{\mathfrak{p}/\mathfrak{q}}$ . If  $\mathfrak{p}/\mathfrak{q} = 1/2$ , then  $\mathbf{R}_{\text{prm}}: \mathcal{L}_{1/2} \dashrightarrow \mathcal{L}_{0/1} = \mathcal{M}$  is the canonical homeomorphism between  $\mathcal{M}_{1/2}$  and  $\mathcal{M}$ .

The *molecule map* is obtained by taking all  $\mathbf{R}_{\text{prm}}: \mathcal{L}_{\mathfrak{p}/\mathfrak{q}} \rightarrow \mathcal{L}_{R_{\text{prm}}(\mathfrak{p}/\mathfrak{q})}$  and extending continuously  $\mathbf{R}_{\text{prm}}$  to the boundary of the main hyperbolic component  $\partial\Delta$ . Rotation angles naturally parametrize  $\partial\Delta$  by  $\mathbb{S}^1$ ; in this parameterization  $\mathbf{R}_{\text{prm}}|_{\partial\Delta}$  is  $R_{\text{prm}}$ .

The molecule map is a 3-to-1 partial map whose non-escaping set is the boundary of the main molecule.

#### 4. DYNAMICS OF MAXIMAL PREPACMEN

Recall from §3.2.9 that every pacman  $f \in \mathcal{W}^u$  has the associated maximal prepacmen  $\mathbf{F} = (\mathbf{f}_-, \mathbf{f}_+)$  consisting of two  $\sigma$ -proper maps. We denote by  $\mathcal{W}_{\text{loc}}^u \simeq \mathcal{W}^u$  the space of maximal prepacmen arising this way.

The renormalization operator on  $\mathcal{W}_{\text{loc}}^u$  is an iteration and rescaling: there are  $m_{1,1}, m_{1,2}, m_{2,1}, m_{2,2} \geq 1$  such that (see (3.11))

$$(4.1) \quad \begin{cases} \mathbf{f}_{n,-}^{\#} = \left( \mathbf{f}_{n-1,-}^{\#} \right)^{m_{1,1}} \circ \left( \mathbf{f}_{n-1,+}^{\#} \right)^{m_{1,2}} \\ \mathbf{f}_{n,+}^{\#} = \left( \mathbf{f}_{n-1,-}^{\#} \right)^{m_{2,1}} \circ \left( \mathbf{f}_{n-1,+}^{\#} \right)^{m_{2,2}} \end{cases} .$$

In particular,  $\mathbf{F} = \mathbf{F}_0^{\#}$  is an iteration of  $\mathbf{F}_n^{\#}$ . Set

$$(4.2) \quad \mathbb{M} := \begin{pmatrix} m_{1,1} & m_{1,2} \\ m_{2,1} & m_{2,2} \end{pmatrix} .$$

Clearly, if

$$(4.3) \quad (c, d) = (a, b) \mathbb{M},$$

then

$$(4.4) \quad \left( \mathbf{f}_{n,-}^{\#} \right)^a \circ \left( \mathbf{f}_{n,+}^{\#} \right)^b = \left( \mathbf{f}_{n-1,-}^{\#} \right)^c \circ \left( \mathbf{f}_{n-1,+}^{\#} \right)^d .$$

We denote by  $\mathfrak{F}$  the tower  $(\mathbf{F}_n)_{n \leq 0}$  and we denote by  $\mathfrak{F}^{\#}$  the rescaled tower  $(\mathbf{F}_n^{\#})_{n \leq 0}$ .

We can now globalize  $\mathcal{W}_{\text{loc}}^u$  as follows. The operator  $\mathcal{R}: \mathcal{W}_{\text{loc}}^u \dashrightarrow \mathcal{W}_{\text{loc}}^u$  is conjugate, say via  $\mathbf{h}$ , to  $v \mapsto \lambda_{\star} v$  in a neighborhood of  $\mathbf{F}_{\star}$  so that  $\mathbf{h}(\mathbf{F}_{\star}) = 0$ . Using (4.4), we inductively define  $\mathbf{F}_n^{\#}$  for all  $n \geq 0$  and all  $\mathbf{F}_0$  in a neighborhood of  $\mathbf{F}_{\star}$ . Note that the domain of  $\mathbf{F}_n^{\#}$  needs not be connected. Define  $\mathbf{F}_n = \mathcal{R}^n \mathbf{F}$  to be  $A_{\star}^{-n} \circ \mathbf{F}_n^{\#} \circ A_{\star}^n$  and set  $\mathbf{h}(\mathbf{F}_n) := \lambda_{\star}^n \mathbf{h}(\mathbf{F}_0)$ . We enlarge  $\mathcal{W}_{\text{loc}}^u$  by adding all new maximal prepacmen  $\{\mathbf{F}_n\}$ . Then  $\mathbf{h}$  parameterizes  $\mathcal{W}^u$  by  $\mathbb{C}$ ; i.e. the new operator  $\mathcal{R}: \mathcal{W}^u \rightarrow \mathcal{W}^u$  is globally conjugate to  $v \mapsto \lambda_{\star}: \mathbb{C} \rightarrow \mathbb{C}$ .

**4.1.  $\mathcal{W}^u$  as a geometric limit of the quadratic slice.** The space  $\mathcal{W}^u$  naturally arises as the set of limits of rescaled iterations of quadratic polynomials. Let us write  $c_{\star} := c(\theta_{\star})$  and let us change the normalization of  $f_c$  by putting the critical value and the parameter  $c_{\star}$  at 0:

$$g_c := T_{c+c_{\star}}^{-1} \circ f_{c+c_{\star}} \circ T_{c+c_{\star}} .$$

Using the hyperbolicity of  $\mathcal{R}$ , it is possible to show that the limit

$$\mathbf{F}_c = \lim_{n \rightarrow +\infty} A_{\star}^{-n} \circ \left( g_{c\lambda_{\star}^{-n}}, g_{c\lambda_{\star}^{-n}}^{\mathbf{b}_n} \right) \circ A_{\star}^n$$

exists and defines the parameterization of  $\mathcal{W}^u$  by  $c$  such that  $\mathcal{R}\mathbf{F}_c = \mathbf{F}_{c\lambda_{\star}}$ . The existence of the limit for  $c = 0$  is shown in [McM1, Theorem 8.1, Claim 7].

Therefore, a zoomed picture of the Mandelbrot set near  $f_{c_{\star}}$  gives a good approximation of  $\mathcal{W}^u$ , see Figure 15. Similarly, a zoomed picture of  $f_{c_{\star} + \lambda_{\star}^{-n} c}$  near the critical value gives a good approximation of  $\mathbf{F}_c$ . This will help us to illustrate by pictures different constructions in the parameter and dynamical planes.

Let us denote by  $\Delta$  the *main hyperbolic component* of  $\mathcal{W}^u$ : the set of maximal prepacmen  $\mathbf{F} \in \mathcal{W}^u$  such that the  $\alpha$ -fixed point of  $f_n$  is attracting for  $n \ll 0$ . Then  $\Delta$  is the rescaled limit of the main hyperbolic component of the Mandelbrot set and  $\partial\Delta$  is a straight line passing through 0.

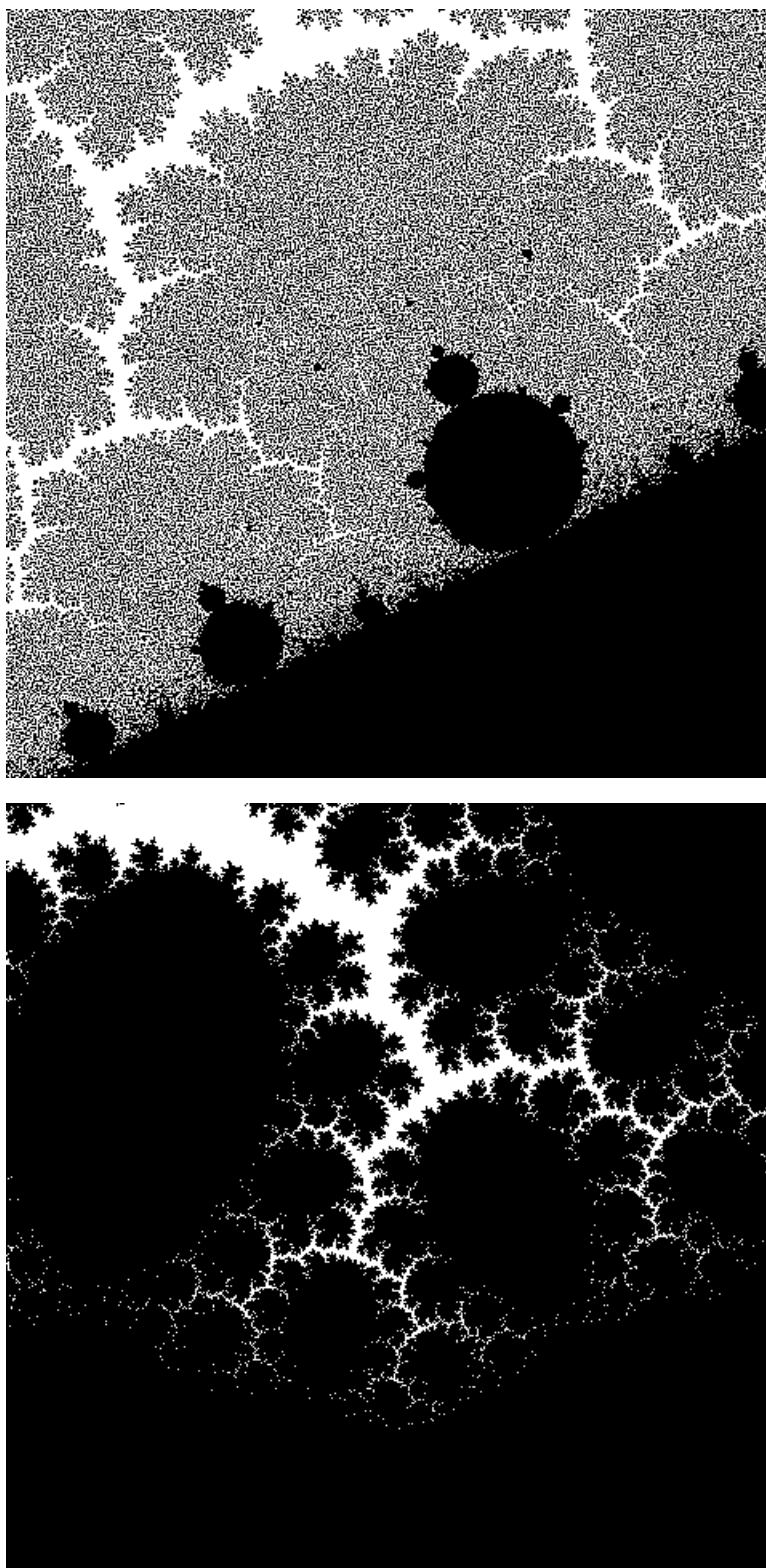

FIGURE 15. Approximations of  $\mathcal{W}^u$  (top) and of the maximal prepacmen  $\mathbf{F}_*$  (bottom), see §4.1. Note that the white set between limbs disappears in the limit.

**4.2. Power-triples.** (Compare with §2.1.2.) A *power-triple* is a triple  $(n, a, b) \in \mathbb{Z} \times \mathbb{Z}_{\geq 0}^2$ . Given a power-triple  $P = (n, a, b)$ , we write

$$\mathbf{F}^P := \left( \mathbf{f}_{n,-}^\# \right)^a \circ \left( \mathbf{f}_{n,+}^\# \right)^b ;$$

$\mathbf{F}^P$  is a  $\sigma$ -proper map; however its domain needs not be connected.

If  $a, b, c, d$  satisfy (4.3), then we say that  $(n, a, b)$  and  $(n-1, c, d)$  are *equivalent power-triples*. This generates the equivalence relation “ $\simeq$ ” on the set of power-triples; we will usually consider power-triples up to this natural equivalence relation. By construction,  $\mathbf{F}^P$  depends only on the equivalence class of  $P$ .

Let  $P, Q$  be two power-triples. For every  $n \ll 0$ , there are  $a, b, c, d$  such that  $P \simeq (n, a, b)$  and  $Q \simeq (n, c, d)$ . We set

$$P + Q \simeq (n, a + c, b + d).$$

Then

$$\mathbf{F}^{P+Q} = \mathbf{F}^P \circ \mathbf{F}^Q.$$

We denote by  $\mathbb{T}$  the commutative semigroup consisting of the equivalence classes of power-triples with the operation “+.” We denote by  $0 \simeq (n, 0, 0)$  the *zero power-triple*:  $\mathbf{F}^0 = \text{id}$ .

For  $P, Q \in \mathbb{T}$  we say that  $P \geq Q$  if for every sufficiently big  $n \ll 0$  the following holds. Write  $P \simeq (n, a, b)$  and  $Q \simeq (n, c, d)$ . Then  $a \geq c$  and  $b \geq d$ . Clearly,  $\geq$  is a well defined order on  $\mathbb{T}$ . The next lemma is a consequence of Lemma 2.2:

**Lemma 4.1.** *For every  $P, Q \in \mathbb{T}$  either  $P \geq Q$  or  $P \leq Q$  holds. There is an order-preserving embedding*

$$\iota: (\mathbb{T}, +, \geq) \hookrightarrow (\mathbb{R}_{\geq 0}, +, \geq)$$

and there is a  $t > 1$  such that

$$(4.5) \quad \iota(n-1, a, b) = \iota(n, a, b)/t$$

for all  $a, b \geq 0$ . □

From now on we fix the order-preserving embedding  $\mathbb{T} \subset \mathbb{R}_{\geq 0}$  as in Lemma 4.1. Then (4.5) takes form

$$(n, a, b)/t := (n-1, a, b).$$

We denote by  $\mathbf{F}^{\geq 0}$  the *cascade*  $(\mathbf{F}^P)_{P \in \mathbb{T}}$ . It follows from (4.1) that

$$(4.6) \quad \mathbf{F}_0^P = \left( \mathbf{F}_{-n}^\# \right)^{\iota^n P}.$$

**4.3. Renormalization triangulations.** Recall from §3.2.10 that the triangulation  $\Delta_{-n}(f_n)$  is the full lift of  $\Delta_0(f_0)$ . For  $\mathbf{F}$  close to  $\mathbf{F}_\star$  we define the renormalization triangulation  $\Delta_0(\mathbf{F}_0)$  to be the full lift of  $\Delta_0(f_0)$  to the dynamical plane of  $\mathbf{F}_\star$ . More precisely, consider

$$(4.7) \quad \mathbf{f}_- : \mathbf{U}_- \rightarrow \mathbf{S}, \quad \mathbf{f}_+ : \mathbf{U}_+ \rightarrow \mathbf{S},$$

see (3.6), and note that this realizes the first return map of points in  $\overline{\mathbf{U}}_\pm$  back to  $\mathbf{S}$  under the cascade  $\mathbf{F}^{\geq 0}$  because (4.7) is the first return map under  $\mathbf{f}_{n,\pm}^\# : \mathbf{U}_{n,\pm}^\# \rightarrow \mathbf{S}_n^\#$  for all  $n \leq 0$ . Then  $\Delta = \Delta_0(\mathbf{F})$  is obtained by spreading around  $\Delta_0(0) := \overline{\mathbf{U}}_+$  and  $\Delta_0(1) := \overline{\mathbf{U}}_-$ ; i.e.  $\Delta_0$  consists of triangles

$$\{\mathbf{F}^P(\Delta_0(0)) \mid P < (0, 0, 1)\} \cup \{\mathbf{F}^P(\Delta_0(1)) \mid P < (0, 1, 0)\}.$$

We enumerate triangles in  $\Delta_0(\mathbf{F})$  as  $(\Delta_0(i, \mathbf{F}))_{i \in \mathbb{Z}}$  from left-to-right so that

$$\Delta_0(0, \mathbf{F}) = \overline{\mathbf{U}}_- \quad \text{and} \quad \Delta_0(1, \mathbf{F}) = \overline{\mathbf{U}}_+,$$

see Figure 16. The triangulation  $\Delta_0(\mathbf{F})$  depends holomorphically on  $\mathbf{F}$ .

**Lemma 4.2.** *Every  $\Delta_0(i)$  is a triangle in  $\widehat{\mathbb{C}}$  with a vertex at  $\infty$ . For every compact subset  $X \subset \mathbb{C}$ , there are at most finitely many triangles in  $\Delta_0$  intersecting  $X$ .*

*Proof.* Since  $\Delta_0(\mathbf{F})$  depends holomorphically on  $\mathbf{F}$  in a small neighborhood of  $\mathbf{F}_*$ , it is sufficient to prove the lemma for  $\mathbf{F}_*$ .

For  $f_*$ , the map  $h_* := h_0$  (see (3.5)) is the linearizer of  $\psi_*$  (the renormalization change of variables associated with  $f_* = \mathcal{R}f_*$ ). This implies that  $\mathbf{S}_*$ ,  $\mathbf{U}_{*,\pm}$ , and all  $\Delta(i, \mathbf{F}_*)$  are triangles of  $\widehat{\mathbb{C}}$  with a vertex at  $\infty$ , see Figure 12.

Since triangles of  $\Delta_n(f_*)$  intersect  $Z_*$  along its internal rays, we can slightly rotate  $\gamma_1$  so that the new  $\gamma_1^{\text{new}}$  intersects  $\Delta_n(f_*)$  along the boundary of a certain triangle in  $\Delta_n(f_*)$ . Let us cut  $\Delta_n(f_*)$  along  $\gamma_1^{\text{new}}$  and embed using  $A_*^{-n} \circ h_*$  the obtained triangulation to the dynamical plane of  $\mathbf{F}_*$ ; we denote by  $\Delta_0^{(n)}(\mathbf{F}_*)$  the embedding. Let us also denote by  $\mathbf{S}_{\text{new}, -n}^\#$  the closure of  $A_*^{-n} \circ h_*(V \setminus \gamma_1^{\text{new}})$ , compare with Figure 13.

Then  $\Delta_0^{(n)}(\mathbf{F}_*) \subset \Delta_0^{(n+1)}(\mathbf{F}_*)$ , and the union of  $\Delta_0^{(n)}(\mathbf{F}_*)$  is  $\Delta_0(\mathbf{F}_*)$ . Moreover,

$$\Delta_0^{(n)} = \mathbf{S}_{\text{new}, -n}^\# \cap \Delta_0.$$

Since  $\mathbf{S}_{\text{new}, -n}^\#$  contains a disk around 0 with a big radius for  $n \ll 0$ , we have  $X \subset \mathbf{S}_{\text{new}, -n}^\#$  for  $n \ll 0$ .  $\square$

The  $n$ th renormalization triangulation  $\Delta_n(\mathbf{F})$  is  $\Delta_0(\mathbf{F}_n^\#) = A_*^n(\Delta_0(\mathbf{F}_n))$ .

From now on we assume that  $\mathcal{W}^u$  is chosen in a sufficiently small neighborhood of  $f_*$  so that every  $f \in \mathcal{R}^{-n}(\mathcal{W}^u)$  has a renormalization triangulation  $\Delta_n(f)$  and every  $\mathbf{F} \in \mathcal{R}^{-n}(\mathcal{W}_{\text{loc}}^u)$  has a renormalization triangulation  $\Delta_n(\mathbf{F})$  for  $n \geq 0$ .

For  $\mathbf{F} \in \mathcal{W}^u$ , the triangulation  $\Delta_n(\mathbf{F})$  is defined for all sufficiently big  $n \ll 0$ . We have

$$(4.8) \quad \bigcup_{m \ll 0} \Delta_m(j, \mathbf{F}) = \mathbb{C} \quad \text{if} \quad \Delta_0(j, \mathbf{F}_*) \ni 0.$$

Moreover,

$$(4.9) \quad \mathbf{S} \setminus \Delta_0(0, 1) \subset \Delta_{-1}(0, 1).$$

because  $S_f \setminus \Delta_1(f) \Subset V \setminus \gamma_1$ , see (3.13).

Given a set  $K \subset U_f$  in the dynamical plane of  $f \in \mathcal{W}^u$ , the *full lift*  $\mathbf{K}$  of  $K$  to the dynamical plane of  $\mathbf{F}$  is defined as follows. Write

$$K_0 := K \cap \Delta_0(0, f), \quad \text{and} \quad K_1 := K \cap \Delta_0(1, f).$$

(Recall that the triangles of  $\Delta_0(f)$  are closed thus  $K = K_- \cup K_+$ ). Let  $\mathbf{K}_0$  and  $\mathbf{K}_1$  be the embeddings of  $K_0$  and  $K_1$  to the dynamical plane of  $\mathbf{F}$  via  $\mathbf{S} \simeq V \setminus \gamma_1$ . Then

$$\mathbf{K} := \bigcup_{0 \leq P < (0,1,0)} \mathbf{F}^P(\mathbf{K}_0) \quad \bigcup_{0 \leq P < (0,0,1)} \mathbf{F}^P(\mathbf{K}_1).$$

In the dynamical plane of  $\mathbf{F}_*$ , we define its *Siegel disk*  $\mathbf{Z}_*$  to be the full lift of  $Z_*$  (the Siegel disk of  $f_*$ ). Then  $\mathbf{Z}_*$  is a forward invariant unbounded open disk.



Since  $f \in \mathcal{W}^u$  is sufficiently close  $f_*$ , the wall  $\mathbb{P}_0(f)$  contains a univalent wall  $A$  (see §3.2.11) respecting  $\gamma_0, \gamma_1$  for a sufficiently big  $N > 1$ . The full lift of a univalent  $N$ -wall of  $\mathbb{P}_0(f_n)$  is a univalent  $N - 1$  wall in  $\mathbb{P}_0(f_0)$ .

**4.4. Rational and critical points.** A point  $x$  is *periodic* if  $\mathbf{F}^P(x) = x$  for a power-triple  $P > 0$ . It will follow from Lemma 4.4 that every periodic point has a unique minimal *period*  $P$ . If  $P$  is the minimal period of  $x$ , then the *multiplier* of  $x$  is  $(\mathbf{F}^P)'(x)$ . Periodic and preperiodic points are called *rational*.

A *critical point* of a cascade  $\mathbf{F}^{\geq 0}$  is a critical point of some  $\mathbf{F}^P$  for  $P \in \mathbb{T}$ . The following lemma describes basic properties of critical points.

**Lemma 4.3.** *Consider  $\mathbf{F} \in \mathcal{W}^u$ . Then  $x$  is a critical point of  $\mathbf{F}^{\geq 0}$  if and only if there is a  $P > 0$  such that  $\mathbf{F}^P(x) = 0$ . The set of critical points  $\text{CP}(\mathbf{F}^P)$  of  $\mathbf{F}^P$  is  $\bigcup_{0 < S \leq P} \mathbf{F}^{-S}(0)$ . The set of critical values  $\text{CV}(\mathbf{F}^P)$  of  $\mathbf{F}^P$  is  $\{\mathbf{F}^S(0) \mid S < P\}$ . The postcritical set  $\mathfrak{P}(\mathbf{F})$  of  $\mathbf{F}^P$  is the forward orbit of 0.*

Write  $K := \min\{(0, 1, 0), (0, 0, 1)\}$ . Then

$$(4.10) \quad \text{CV}(\mathbf{G}^P) \setminus \{0\} \subset \Delta_0(\mathbf{G}) \setminus \mathbf{S} \quad \text{for } P < K \quad \text{and} \quad \mathbf{G} \in \mathcal{W}_{\text{loc}}^u.$$

For every  $P < K$ , the set  $\text{CV}(\mathbf{G}^P)$  moves holomorphically with  $\mathbf{G} \in \mathcal{W}_{\text{loc}}^u$ , and every critical point of  $\mathbf{G}^P$  has degree 2 for  $\mathbf{G} \in \mathcal{W}_{\text{loc}}^u$ .

For every  $\mathbf{F} \in \mathcal{W}^u$ , there is a  $K_{\mathbf{F}} > 0$  such that every critical point of  $\mathbf{G}^P$  has degree 2 for  $P < K_{\mathbf{F}}$ .

For every  $\mathbf{F} \in \mathcal{W}^u$  and every  $P \in \mathbb{T}$ , there exists  $k \in \mathbb{N}$  such that the degree of every critical point of  $\mathbf{F}^P$  is at most  $k$ . If 0 is not periodic, then the degree of every critical point of  $\mathbf{F}^P$  is 2.

The first claim is essentially [DLS, Lemma 6.1].

*Proof.* Let  $\mathbf{W} \Subset \mathbb{C}$  be an open topological disk, and let  $\mathbf{W}_1$  be a connected component of  $\mathbf{F}^{-P}(\mathbf{W})$ . For  $n \ll 0$ , the map  $\mathbf{F}^P: \mathbf{W}_1 \rightarrow \mathbf{W}$  is identified via  $A_*^k \circ h_k: V \setminus \gamma_1 \rightarrow \mathbf{S}_k^\#$  with  $f_n^{\mathfrak{t}(k)}: W_1 \rightarrow W$  for some  $\mathfrak{s}(k) \geq 0$  because  $A_*^k \circ h_k$  conjugates (3.8) and (3.9), see §3.2.9. Therefore,  $z \in \mathbf{W}_1$  is a critical point of  $\mathbf{F}^P$  if and only if the  $f_k$ -orbit of  $(A_*^k \circ h_k)^{-1}(z)$  passes through 0 during the first  $\mathfrak{s}(k)$  iterates. This is equivalent to  $\mathbf{F}^S(z) = 0$  for some positive  $S \leq P$ . The degree of  $\mathbf{F}^P$  at  $z$  is  $2^t$ , where  $t$  is the number of positive  $S \leq P$  with  $\mathbf{F}^S(z) = 0$ .

The claims about  $\text{CP}(\mathbf{F}^P)$ ,  $\text{CV}(\mathbf{F}^P)$  and  $\mathfrak{P}(\mathbf{F})$  are immediate.

For  $\mathbf{G} \in \mathcal{W}_{\text{loc}}^u$  and  $P \leq K$ , the point  $\mathbf{G}^S(0)$  belongs to a certain triangle  $\Delta_0(i, \mathbf{G})$  that is disjoint from  $\mathbf{S}(\mathbf{G})$ . This implies that  $\mathbf{G}^S(0)$  is well defined, depends holomorphically on  $\mathbf{G}$ , and does not collide with 0. Since points  $\mathbf{G}^S(0), \mathbf{G}^Q(0)$  with  $0 < S < Q < T$  belong to different triangles of  $\Delta_0(\mathbf{G}) \setminus \mathbf{S}$ , we obtain a holomorphic motion of  $\text{CV}(\mathbf{G}^T) = \{\mathbf{G}^S(0) \mid S < T\}$  with  $\mathbf{G} \in \mathcal{W}_{\text{loc}}^u$ . We also proved (4.10). Since every critical point of  $\mathbf{G}^P$  with  $P \leq K$  passes exactly once through 0, the degree of every such critical point is 2.

For  $\mathbf{F} \in \mathcal{W}^u$ , choose  $n \in \mathbb{Z}$  so that  $\mathcal{R}^n(\mathbf{F}) \in \mathcal{W}_{\text{loc}}^u$ . Then  $K_{\mathbf{F}}$  can be taken to be  $\mathfrak{t}^n K$ .

The last claim follows from the observation that every critical point of  $\mathbf{F}^P$  passes through 0 at most  $(P/K_{\mathbf{F}}) + 1$  times.  $\square$

**4.5. Proper discontinuity of  $\mathbf{F}^{\geq 0}$ .** The action of the cascade  $\mathbf{F}^{\geq 0}$  is proper discontinuous in the following sense

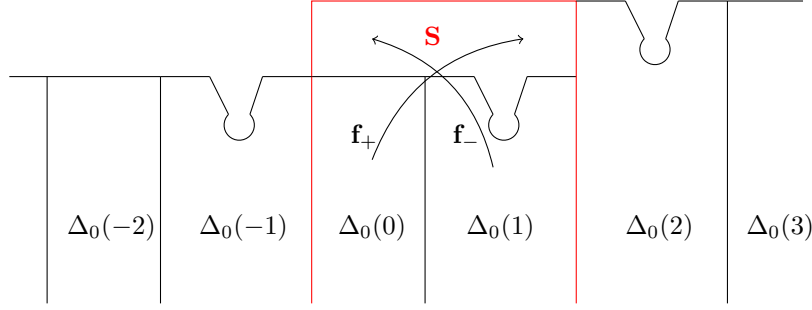

FIGURE 16. The triangulation  $\Delta_0(\mathbf{F})$  is obtained by spreading around the triangles  $\Delta_0(0, \mathbf{F})$  and  $\Delta_0(1, \mathbf{F})$  – the embeddings of  $\Delta_1(1, f)$  and  $\Delta_1(0, f)$ , see Figure 14. The triangulation has the same combinatorics as the renormalization tiling of  $\mathbb{R}$ , see Figure 5

**Lemma 4.4.** *For every bounded open set  $W \subset \mathbb{C}$  there is a  $Q > 0$  such that for all  $\mathbf{G}$  close to  $\mathbf{F}$  the following holds:*

- $W \in \text{Dom } \mathbf{G}^P$  for all  $P \leq Q$ ;
- $\mathbf{G}^P \upharpoonright W$  is univalent for all  $P \leq Q$ ; and
- $\mathbf{G}^P(W) \cap \mathbf{G}^T(W) = \emptyset$  for all  $P < T \leq Q$ .

For every  $x \in \mathbb{C}$  and  $T \in \mathbb{T}$ , the set

$$\bigcup_{P \leq T} \mathbf{F}^P \{x\}$$

is discrete in  $\mathbb{C}$ . In particular, the set of critical values  $\text{CV}(\mathbf{F}^T)$  of  $\mathbf{F}^T$  is discrete in  $\mathbb{C}$  for all  $T \in \mathbb{T}$ .

*Proof.* By (4.8) there is an  $m \leq 0$  such that  $W \subset \Delta_m(j, \mathbf{G})$  for all  $\mathbf{G}$  close to  $\mathbf{F}$ . Let us take  $Q = \min\{(0, 0, 1), (0, 1, 0)\}t^m$ . For  $P \leq Q$  the map  $\mathbf{G}^P$  maps  $\Delta_m(j, \mathbf{G})$  to a different triangle of  $\Delta_m(\mathbf{G})$ ; this shows the first claim.

Suppose that  $\bigcup_{P \leq T} \mathbf{F}^P \{x\}$  accumulates on  $y$ . Choose a small neighborhood  $W$  of  $y$ . Then there is a  $Q > 0$  such that  $\mathbf{F}^P(W)$  is disjoint from  $W$  for all  $P < Q$ . Since  $Q < kT$  for some  $k \gg 1$ , the intersection  $W \cap \bigcup_{P \leq T} \mathbf{F}^P \{x\}$  consists of at most  $k$  points.

The set of critical values of  $\mathbf{F}^T$  is discrete because it is equal to  $\bigcup_{P < T} \mathbf{F}^P \{0\}$ , see

Lemma 4.4. □

**Corollary 4.5.** *Let  $\mathbf{Y}$  be a compact set such that  $\mathbf{Y} \in \text{Dom } \mathbf{F}^P$ . Then for every  $\mathbf{X} \in \mathbb{C}$  there are at most finitely many  $T \leq P$  such that  $\mathbf{F}^T(\mathbf{Y})$  intersects  $\mathbf{X}$ .*

*Proof.* For every  $y \in \mathbf{Y}$ , the orbit  $\text{orb}_z^P := \{\mathbf{F}^S(z) \mid S \leq P\}$  is discrete and depends continuously on  $z$  in a small neighborhood of  $y$  because  $y \in \text{Dom } \mathbf{F}^P$ . (In fact, if  $x \notin \text{Dom } \mathbf{F}^P$ , then  $\text{orb}_z^P$  does not depend continuously on  $z$  in a small neighborhood of  $x$ ). The corollary now follows from a compactness argument. □

**Corollary 4.6.** *Every periodic point has a minimal period.*

For every critical point  $x$  of  $\mathbf{F}^{\geq 0}$ , there is a minimal  $P > 0$ , called the generation of  $x$ , such that  $\mathbf{F}^P(x) = 0$ .

*Proof.* Let  $x$  be a periodic point of  $\mathbf{F}$ , and let

$$\mathbb{T}_x := \{P \in \mathbb{T} \mid \mathbf{F}^P(x) = x\}$$

be the semigroup of all the periods of  $x$ . By Lemma 4.4, there is a neighborhood  $W$  of  $x$  and a small  $Q > 0$  such that  $\mathbf{F}^T(W) \cap W = \emptyset$  for all  $T \leq Q$ ; in particular,  $\mathbf{F}^T(x) \neq x$ . Therefore,  $\mathbb{T}_x$  is of the form  $\{nS \mid n \geq 1\}$ , where  $S > 0$  is the minimal period.

By Lemma 4.3, if  $x$  is a critical point of  $\mathbf{F}^{\geq 0}$ , then  $\mathbf{F}^P(x) = 0$  for some  $P \in \mathbb{T}$ . Since  $\{\mathbf{F}^S(x) \mid S \leq P\}$  does not accumulate on 0, there is a minimal  $S > 0$  such that  $\mathbf{F}^S(x) = 0$ .  $\square$

**4.6. Walls  $\mathbb{P}_0(\mathbf{F})$ .** Recall from §3.2.11 that a triangulation  $\Delta_n(f)$  has a wall  $\mathbb{P}_n(f)$  for  $f \in \mathcal{W}^u$ . Let  $\Pi_0(0, \mathbf{F})$  and  $\Pi_0(1, \mathbf{F})$  be the embeddings of the rectangles  $\Pi_0(0, f)$  and  $\Pi_0(1, f)$  to the dynamical plane of  $\mathbf{F}$  via  $\mathbf{S} \simeq V \setminus \gamma_1$ . The wall  $\mathbb{P}_0(\mathbf{F})$  of  $\Delta_0(\mathbf{F})$  is obtained by spreading around  $\Pi_n(0, \mathbf{F})$  and  $\Pi_n(1, \mathbf{F})$ .

The wall  $\mathbb{P}_n(\mathbf{F})$  is  $A_\star^{-n}(\mathbb{P}_0(\mathcal{R}^n f))$ . We define  $\mathbf{Q}_n(\mathbf{F}) := \Delta_n \setminus \mathbb{P}_n(\mathbf{F})$ . This is the interior of the full lift of  $Q_n(f) := \Delta_n(f) \setminus \mathbb{P}_n(f)$ .

**4.7. The boundary point  $\alpha$ .** As in §2.3.9, we add a boundary point  $\alpha$  at “ $-i\infty$ ” to the dynamical space of a prepacman. The boundary point  $\alpha(\mathbf{F})$  would correspond to  $\alpha(f)$ . Let us introduce the wall topology for  $\mathbb{C} \sqcup \alpha(\mathbf{F})$ , compare with §2.3.9.

Consider a univalent wall  $A$  respecting  $\gamma_0, \gamma_1$  in a small neighborhood of  $\alpha(f)$ . Then the full lift  $\mathbb{A}(\mathbf{F})$  of  $A(f)$  is a closed strip in  $\mathbb{C}$  such that  $\mathbb{C} \setminus \mathbb{A}(\mathbf{F})$  has two connected components. We denote by  $\Omega = \Omega(A)$  the component of  $\mathbb{C} \setminus \mathbb{A}(\mathbf{F})$  not containing 0. Equivalently,  $\Omega$  is the interior of the full lift of the component of  $\mathbb{C} \setminus A$  containing  $\alpha$ . We say that  $\Omega$  is *below*  $\mathbb{A}$ . The open sets of  $\mathbb{C} \sqcup \{\alpha(\mathbf{F})\}$  are generated by open sets in  $\mathbb{C}$  and by  $\Omega(A) \sqcup \{\alpha(\mathbf{F})\}$  for all univalent wall as above.

A curve  $\ell: [0, 1) \rightarrow \mathbb{C}$  lands at  $\alpha$  if  $\lim_{t \rightarrow 1} \ell(t) = \alpha$ .

**4.8. A fundamental domain for  $\mathbf{F}$ .** Recall that for  $\mathbf{F} \in \mathcal{W}_{\text{loc}}^u$ , the sector  $\mathbf{S}$  has distinguished sides  $\lambda(\mathbf{S})$  and  $\rho(\mathbf{S})$ . Moreover  $V$  is a quotient of  $\mathbf{S}$  under  $\mathbf{F}^{(0,1,0)-(0,0,1)} = \mathbf{f}_-^{-1} \circ \mathbf{f}_+$ :  $\lambda(\mathbf{S}) \rightarrow \rho(\mathbf{S})$ , and  $\lambda(\mathbf{S}), \rho(\mathbf{S})$  project to  $\gamma_1$ .

Suppose  $\mathbf{F} \in \mathcal{R}^{-n}(\mathcal{W}_{\text{loc}}^u)$  for  $n \geq 0$ . Recall §4.6 that  $\mathbf{Q}_n(\mathbf{F}) = \Delta_n(\mathbf{F}) \setminus \mathbb{P}_n(\mathbf{F})$ . A *fundamental domain* in the dynamical plane of  $\mathbf{F}$  is a sector  $\mathbf{S}^{\text{new}}$  with distinguished sides  $\lambda(\mathbf{S}^{\text{new}})$  and  $\rho(\mathbf{S}^{\text{new}})$  such that

- (1)  $\mathbf{S} \setminus \mathbf{Q}_n = \mathbf{S}^{\text{new}} \setminus \mathbf{Q}_n$  and  $\lambda(\mathbf{S}) \setminus \mathbf{Q}_n = \lambda(\mathbf{S}^{\text{new}}) \setminus \mathbf{Q}_n$  and  $\rho(\mathbf{S}) \setminus \mathbf{Q}_n = \rho(\mathbf{S}^{\text{new}}) \setminus \mathbf{Q}_n$ ,
- (2)  $\lambda(\mathbf{S}^{\text{new}})$  and  $\rho(\mathbf{S}^{\text{new}})$  land at  $\alpha$ ; and
- (3)  $\text{int}(\mathbf{S}^{\text{new}})$  contains an arc  $\ell$  such that  $\mathbf{f}_-(\ell) = \lambda(\mathbf{S}^{\text{new}})$  and  $\mathbf{f}_+(\ell) = \rho(\mathbf{S}^{\text{new}})$ .

Similar to §2.3.11, we say that  $\beta_0, \beta_1 = f(\beta_0)$  is a diving pair of arcs in the dynamical plane of a pacman  $f: U \rightarrow V$  if

- $\beta_0$  is a simple arc connecting  $\alpha$  and point on  $\partial U$ ;
- $\beta_1$  is a simple arc connecting  $\alpha$  and a point on  $\partial V$ ;
- $\beta_0, \beta_1$  are disjoint away from  $\alpha$ .

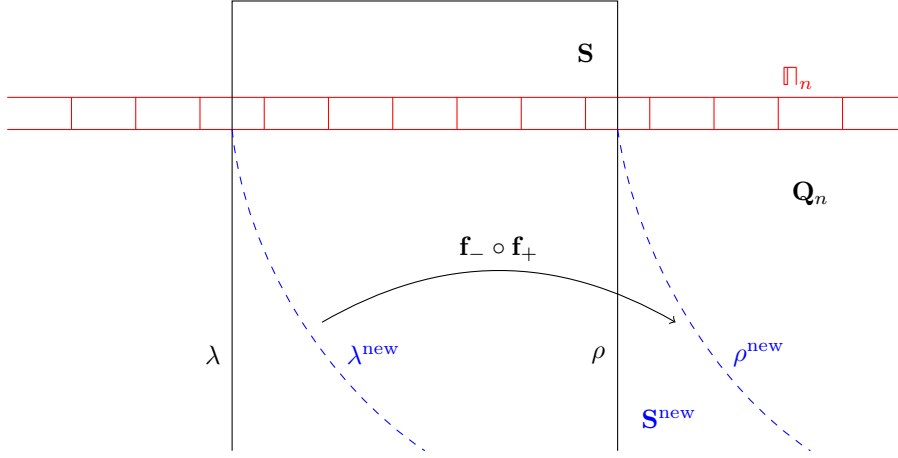

FIGURE 17. A fundamental domain  $\mathbf{S}^{\text{new}}$  is a sector in  $\mathbb{C} \sqcup \{\alpha\}$  such that  $\mathbf{S}^{\text{new}} \setminus \mathbf{Q}_n$  coincide (or close) to  $\mathbf{S} \setminus \mathbf{Q}_n$  and such that the “deck transformation”  $\mathbf{f}_-^{-1} \circ \mathbf{f}_+$  maps the left boundary  $\lambda^{\text{new}}$  of  $\mathbf{S}^{\text{new}}$  to its right boundary  $\rho^{\text{new}}$ .

**Theorem 4.7.** *Suppose  $\mathbf{S}^{\text{new}}$  is a fundamental domain in the dynamical plane of  $\mathbf{F} \in \mathcal{R}^{-n}(\mathcal{W}_{\text{loc}}^u)$  as above. Then the quotient of  $\mathbf{S}^{\text{new}}$  under*

$$\mathbf{F}^{(n,1,0)-(n,0,1)}: \lambda(\mathbf{S}^{\text{new}}) \rightarrow \rho(\mathbf{S}^{\text{new}})$$

*is canonically conformally homeomorphic to  $V$ . Under this homeomorphism  $\mathbf{F}$  projects to  $f_n$ .*

*Conversely, if  $\gamma_0^{\text{new}}, \gamma_1^{\text{new}}$  is a dividing pair of arcs such that  $\gamma_0^{\text{new}} \setminus \mathbf{Q}_n = \gamma_0$  and  $\gamma_1^{\text{new}} \setminus \mathbf{Q}_n = \gamma_1$ , then  $h$  extends from a neighborhood of  $c_1$  to a conformal map defined on  $V \setminus \gamma_1^{\text{new}}$  so that the closure of  $h(V \setminus \gamma_1^{\text{new}})$  is a fundamental domain.*

*Proof.* Choose in  $\mathbb{P}_n(f)$  a univalent wall  $A$  respecting  $\gamma_0, \gamma_1$  and surrounding  $\Omega \ni \alpha$ . Let  $\mathbb{A} \subset \mathbb{P}_n(\mathbf{F})$  and  $\mathbb{\Omega}$  be the full lifts of  $A$  and  $\Omega$  to the dynamical plane of  $\mathbf{F}$ . The theorem now follows from Proposition 2.10 applied to  $f \mid \Omega \cup A$  and  $\mathbf{F} \mid \mathbb{\Omega} \cup \mathbb{A}$ .  $\square$

**4.9. Fatou, Julia, and escaping sets.** Consider  $x \in \mathbb{C}$ . If there is an open set  $U$  such that  $U \subset \text{Dom } \mathbf{F}^P$  for all  $P \geq 0$  and, moreover,  $\{\mathbf{F}^P \mid U\}_{P \geq 0}$  forms a normal family, then  $x$  is a *regular point* of  $\mathbf{F}$ . The *Fatou set*  $\mathfrak{F}(\mathbf{F})$  of  $\mathbf{F}$  is the set of regular points of  $\mathbf{F}$ . By construction, all  $\mathbf{F}_n^\#$  have the same Fatou sets.

The *Julia set*  $\mathfrak{J}(\mathbf{F})$  of  $\mathbf{F}$  is  $\mathbb{C} \setminus \mathfrak{F}(\mathbf{F})$ . Clearly, all repelling periodic points are within the Julia set of  $\mathbf{F}$ .

The cascade  $\mathbf{F}^{\geq 0}$  acts on the set of components of  $\mathfrak{F}(\mathbf{F})$ . A component  $X$  of  $\mathfrak{F}(\mathbf{F})$  is *periodic* if there is a power-triple  $P$  such that  $\mathbf{F}^P(X) = X$ . We call  $P$  a *period* of  $X$ .

A Fatou component  $X$  is *invariant* if  $\mathbf{F}^P(X) = X$  for every  $P \in \mathbb{T}$ . By Corollary 4.6, if a Fatou component  $X$  has an attracting point in  $\mathbb{C}$ , then  $X$  has a minimal period; in particular,  $X$  is not invariant. (It may happen that  $\alpha$  is an attracting point for an invariant Fatou component.)

Two Fatou components  $X, Y$  are *dynamically related* if they are in the same grand orbit: there are  $P, Q \in \mathbb{T}$  such that a certain branch of  $\mathbf{F}^{-P} \circ \mathbf{F}^Q$  maps  $X$  to  $Y$ . Dynamically related periodic components have the same periods.

A Fatou component  $X$  is *preperiodic* if there is a power-triple  $Q$  such that  $\mathbf{F}^Q(X)$  is a periodic Fatou component. In this case,  $Q$  is the *preperiod*.

Given  $P \in \mathbb{T}$ , we define the  *$P$ -th escaping set* as

$$\mathbf{Esc}_P(\mathbf{F}) := \mathbb{C} \setminus \text{Dom}(\mathbf{F}^P).$$

The *escaping set* is

$$\mathbf{Esc}(\mathbf{F}) := \bigcup_{P \geq 0} \mathbf{Esc}_P(\mathbf{F}).$$

Since the domains of  $\mathbf{f}_\pm$  are simply connected (see §3.2.9) for  $\mathbf{F} \in \mathcal{W}_{\text{loc}}^u$ , every connected component of  $\text{Dom} \mathbf{F}^P$  is simply connected. Therefore, every connected component of  $\mathbf{Esc}_P(\mathbf{F})$  is unbounded. Since  $\mathbf{Esc}_P(\mathbf{F})$  is a rescaling of  $\mathbf{Esc}_{t^n P}(\mathbf{F}_{-n})$ , every connected component of  $\mathbf{Esc}_P(\mathbf{G})$  is unbounded for every  $\mathbf{G} \in \mathcal{W}^u$ .

By definition,  $\overline{\mathbf{Esc}(\mathbf{F})} \subset \mathfrak{J}(\mathbf{F})$ . We will show in Corollary 6.8 that  $\overline{\mathbf{Esc}(\mathbf{F})} \neq \emptyset$ , hence  $\mathbf{Esc}(\mathbf{F}) = \mathfrak{J}(\mathbf{F})$ .

**4.10. QC deformation of maximal prepacmen.** Suppose that  $\mathbb{C}$  has a Beltrami form  $\mu$  such that  $\mu$  is invariant under the cascade  $\mathbf{F}^{\geq 0}$ , where  $\mathbf{F} \in \mathcal{W}^u$ . Integrating  $\mu$ , we obtain a path  $\mathbf{F}_t^{\geq 0}$  with  $t \geq 0$  of cascades emerging from  $\mathbf{F}_0^{\geq 0} = \mathbf{F}^{\geq 0}$ . We claim that  $\mathbf{F}_t$  is, up to calling, a path on the unstable manifold  $\mathcal{W}^u$ . We will use the argument from [DLS, §8.0.2] to find a correct scaling.

Applying antirenormalization, we can assume that  $\mathbf{F}$  is in a small neighborhood of  $\mathbf{F}_*$ . In particular,  $\mathbf{F} \in \mathcal{W}_{\text{loc}}^u$ . Projecting  $\mu$  to the dynamical plane of  $f_n$  for  $n \leq 0$ , we obtain the Beltrami form  $\mu_n$  invariant under  $f_n$ . Integrating  $\mu_n$ , we obtain a path  $f_{n,t} \in \mathcal{B}$  emerging from  $f_{n,0} = f_n$ . Set  $f_t^{(n)} := \mathcal{R}^{-n} f_{n,t}$ , and observe that for small  $t$  all  $f_t^{(n)}$  are qc conjugate with bounded dilatation uniformly on  $n$ . Therefore, we can take a limit and construct a path  $f_t^\infty$  in  $\mathcal{B}$  of infinitely anti-renormalizable pacmen. Therefore,  $f_t^\infty$  is a path in  $\mathcal{W}^u$ .

The qc deformation of maximal prepacmen allows to modify multipliers of attracting periodic cycles.

## 5. EXTERNAL STRUCTURE OF $\mathbf{F}_*$

In this section we set  $\mathbf{F} = \mathbf{F}_*$  and we let  $\mathbf{Z} = \mathbf{Z}_*$  to be its Siegel disk which is defined to be the full lift of  $Z_*$ , see §4.3. We also write the fixed pacman  $f_*: U_* \rightarrow V$  as  $f: U \rightarrow V$ .

**5.1. Chess-board rule.** Let us say that a simply connected open set  $U \subset \mathbb{D}$  has a *single access to the infinity* if  $\partial\mathbb{D} \cap \partial U$  and  $\mathbb{D} \setminus U$  are connected. Similarly, a simply connected open set  $U \subset \mathbb{C}$  has a *single access to the infinity* if  $U$  is unbounded and  $\mathbb{C} \setminus U$  is connected.

We need the following fact.

**Lemma 5.1.** *Let  $g: \text{Dom } g \rightarrow \mathbb{C}$  be a  $\sigma$ -proper map, where  $\text{Dom } g$  is either  $\mathbb{D}$  or  $\mathbb{C}$ . Suppose that the set of critical values  $\text{CV}(g)$  of  $g$  is discrete and assume that  $\ell: \mathbb{R} \rightarrow \mathbb{C}$  is a simple properly embedded arc such that*

- 1)  $\ell(\mathbb{R}) \supset \text{CV}(g)$ , and
- 2)  $\ell$  splits  $\mathbb{C}$  into two open half-planes  $V$  and  $W$ .

Then

- $g^{-1}(\ell)$  is a tree in  $\text{Dom } g$ ; in particular, if  $U$  is a connected component of  $\text{Dom } g \setminus g^{-1}(\ell)$ , then  $U$  has a single access to the infinity; and
- there is a “chess-board rule”: if  $U_1$  and  $U_2$  are two different components of  $g^{-1}(V)$ , then  $\partial U_1 \cap \partial U_2 \cap \text{Dom } g$  is either empty or a single critical point of  $g$ .

Note that since  $g$  is  $\sigma$ -proper,  $g^{-1}(\text{CV}(g))$  is discrete  $\text{Dom } g$ .

*Proof.* We will verify the case when  $\text{Dom } g = \mathbb{D}$ ; the case  $\text{Dom } g = \mathbb{C}$  is completely analogous.

Consider a connected component  $U$  of  $\mathbb{D} \setminus g^{-1}(\ell)$ . Recall that a  $\sigma$ -proper map has no asymptotic values. Since  $\text{CV}(g) \subset \ell$ , the map

$$g: U \rightarrow g(U) \in \{V, W\}$$

is a covering. Since  $V$  and  $W$  are simply connected, so is  $U$ ; i.e.  $g: U \rightarrow g(U)$  is univalent. And since  $V$  and  $W$  are unbounded,  $U$  is not properly contained in  $\mathbb{D}$ . This implies that  $g^{-1}(\ell)$  is a forest.

Suppose  $g^{-1}(\ell)$  is not a tree. Then there is a component  $U$  of  $\mathbb{D} \setminus g^{-1}(\ell)$  with at least two accesses to  $\partial \mathbb{D}$ . Since  $g$  is  $\sigma$ -proper and  $g: U \rightarrow g(U)$  is univalent,  $g(U)$  has at least two accesses to the infinity. This contradicts the assumption that  $\ell$  is connected.

Let  $U_1$  and  $U_2$  be two different components of  $g^{-1}(V)$ . Then  $\partial U_1 \cap \partial U_2 \cap \text{Dom } g$  is a discrete set of critical points. If  $\partial U_1 \cap \partial U_2 \cap \text{Dom } g$  has at least two points, then  $\bar{U}_1 \cup \bar{U}_2$  surround a component of  $g^{-1}(W)$ ; this is a contradiction.  $\square$

**5.2. Bubbles of  $\mathbf{F}$ .** Recall from §4.3 that  $\mathbf{Z} = \mathbf{Z}_*$  is the full lift of  $Z = Z_*$ . Alternatively,  $\bar{\mathbf{Z}}_*$  can be viewed as a rescaled limit of  $\bar{Z}_*$ , [McM1].

**Lemma 5.2** (Compare with [McM1, Theorem 8.1]). *The disk  $\mathbf{Z}$  is an invariant Fatou component of  $\mathbf{F}$ . Let  $\mathbf{h}: \mathbf{Z} \rightarrow \{\text{Im } z < 0\}$  be a conformal map. Then  $\mathbf{h}$  extends to a quasimetric map  $\mathbf{h}: \bar{\mathbf{Z}} \rightarrow \{\text{Im } z \leq 0\}$ .*

*Let us normalize  $\mathbf{h}$  so that  $\mathbf{h}(0) = 0$  and  $|\mathbf{h}'(0)| = 1$ . Then  $\mathbf{h}$  conjugates  $\mathbf{f}_-, \mathbf{f}_+$  to a pair of translations  $z \mapsto z - \mathbf{v}$  and  $z \mapsto z + \mathbf{w}$  with  $\mathbf{v}, \mathbf{w} \geq 0$  such that  $\theta_* = \mathbf{v}/(\mathbf{v} + \mathbf{w})$ . Moreover,  $\mathbf{h}$  conjugates the cascade  $(\mathbf{F}^P | \bar{\mathbf{Z}})_{P \in \mathbb{T}}$  with the cascade of translations  $(T^P)_{P \in \mathbb{T}}$  from §2.1.1.*

*Proof.* Recall from §4.3 that the support of the renormalization triangulation  $\Delta_0(\mathbf{F})$  is a neighborhood of  $\bar{\mathbf{Z}}$  and  $\Delta_0(\mathbf{F})$  is the full lift of  $\Delta_0(f)$ . As a consequence,  $\partial \mathbf{Z}$  is locally a quasiarc;  $\partial \mathbf{Z}$  is globally a quasiarc because it is invariant under the scaling  $A_*$ .

In the dynamical plane of  $f$ , the boundary  $\partial Z_*$  is contained in the closure of repelling periodic points (see §3.2.5). Lifting these periodic points to the dynamical plane of  $\mathbf{F}$  we obtain that  $\partial \mathbf{Z}$  is also in the closure of repelling periodic points; thus  $\partial \mathbf{Z} \subset \mathfrak{J}(\mathbf{F})$ .

Clearly,  $\mathbf{F}_\pm | \bar{\mathbf{Z}}$  is conjugate to a pair of translations  $z \mapsto z - \mathbf{v}$  and  $z \mapsto z + \mathbf{w}$  as required; thus  $\mathbf{Z}$  is a Fatou component of  $\mathbf{F}$ .  $\square$

Since  $\mathbf{F}_\pm | \bar{\mathbf{Z}}$  is a pair of homeomorphisms,  $\mathbf{F}_+ \circ \mathbf{F}_-^{-1}$  is a deck transformation of  $\bar{\mathbf{Z}}$  and the quotient  $\bar{\mathbf{Z}}/\langle \mathbf{F}_-^{-1} \circ \mathbf{F}_+ \rangle$  is identified with  $\bar{Z}_*$ ; i.e.  $\bar{\mathbf{Z}}$  is the universal cover of  $\bar{Z}_*$  and  $\mathbf{F}_\pm | \bar{\mathbf{Z}}$  are lifts of  $f | Z_*$ .

Observe that  $\partial\mathbf{Z} \supset \mathfrak{P}(\mathbf{F}) \supset \text{CV}(\mathbf{F})$  because  $0 \in \partial\mathbf{Z}$  and  $\partial\mathbf{Z}$  is invariant. We have the following corollary of Lemma 5.1:

**Corollary 5.3.** *For every  $P \in \mathbb{T}_{>0}$  the preimage  $\mathbf{F}^{-P}(\partial\mathbf{Z})$  is a tree in  $\text{Dom } \mathbf{F}^P$ .  $\square$*

Since  $\mathbf{F}^P \mid \partial\mathbf{Z}$  is a homeomorphism, for every  $P > 0$ , there is a unique critical point  $c_P \in \partial\mathbf{Z}$  of  $\mathbf{F}^{\geq 0}$  of generation  $P$ , see Lemma 4.3. Since  $\mathbf{F}^P$  is two-to-one around  $c_P$ , there is a preperiodic Fatou component  $\mathbf{Z}_P$  attached to  $c_P$  such that  $\mathbf{F}^P(\mathbf{Z}_P) = \mathbf{Z}$ .

**Lemma 5.4.** *For  $c_P$  and  $\mathbf{Z}_P$  as above,  $\bar{\mathbf{Z}} \cap \bar{\mathbf{Z}}_P = \{c_P\}$ . Set*

$$\hat{\mathbf{Z}}_P := \bar{\mathbf{Z}}_P \cap \text{Dom } \mathbf{F}^P.$$

*Then  $\mathbf{F}^P : \hat{\mathbf{F}}_P \rightarrow \bar{\mathbf{Z}}$  is a homeomorphism.*

The point  $c_P$  is called the *root* of  $\mathbf{Z}_P$ . We will show in Lemma 5.11 that

$$\tilde{\alpha}_P := \bar{\mathbf{Z}}_P \setminus \hat{\mathbf{Z}}_P$$

consists of a single point, called the *top* of  $\mathbf{Z}_P$ . We set

$$\partial^c \mathbf{Z}_P := \partial\mathbf{Z}_P \cap \text{Dom}(\mathbf{F}^P) = \hat{\mathbf{Z}}_P \setminus \mathbf{Z}_P.$$

*Proof.* By Corollary 5.3,  $\mathbf{F}^{-P}(\partial\mathbf{Z})$  is a tree in  $\text{Dom}(\mathbf{F}^P)$ . Therefore,  $\mathbf{Z}_P$  is a connected component of  $\text{Dom}(\mathbf{F}^P) \setminus \mathbf{F}^{-P}(\partial\mathbf{Z})$  specified so that  $\bar{\mathbf{Z}} \cap \bar{\mathbf{Z}}_P = \{c_P\}$ . Moreover,  $\partial^c \mathbf{Z}_P = \partial\mathbf{Z}_P \cap \text{Dom}(\mathbf{F}^P)$  is a simple arc.

Since  $\mathbf{F}^Q(\partial^c \mathbf{Z}_P)$  is disjoint from 0 for all  $Q < P$  (because  $\mathbf{F}^Q(\partial^c \mathbf{Z}_P) \subset \partial^c \mathbf{Z}_{P-Q}$ ), the curve  $\partial^c \mathbf{Z}_P$  contains a single critical point  $c_P$  of  $\mathbf{F}^P$ . Therefore,  $\mathbf{F}^P : \partial^c \mathbf{Z}_P \rightarrow \partial\mathbf{Z}$  is a homeomorphism; this proves the second claim.  $\square$

For every  $Q \in \mathbb{T}$ , there is a unique critical point  $c_{P,Q} \in \partial\mathbf{Z}_P$  of  $\mathbf{F}^{\geq 0}$  of generation  $P+Q$ . If  $Q > 0$ , then there is a unique Fatou component  $\mathbf{Z}_{P,Q}$  attached to  $\mathbf{Z}_P$  at  $c_{(P,Q)}$  such that  $\mathbf{F}^{P+Q}(\mathbf{Z}_{P,Q}) = \mathbf{Z}$ . As above, we have a homeomorphism  $\mathbf{F}^{P+Q} : \hat{\mathbf{Z}}_{(P,Q)} \rightarrow \bar{\mathbf{Z}}$ .

Continuing this process, we define  $c_{P_1, \dots, P_m}$  and the *bubble*  $\mathbf{Z}_{P_1, \dots, P_m}$  for every finite sequence in  $s = (P_1, \dots, P_n) \in \mathbb{T}_{>0}^n$ . We call  $|s| = P_1 + \dots + P_n$  the *generation* of  $\mathbf{Z}_s = \mathbf{Z}_{P_1, \dots, P_m}$ . Lemma 5.4 implies:

**Lemma 5.5.** *For every bubble  $\mathbf{Z}_s$  with  $|s| > 0$ , there is a unique bubble  $\mathbf{Z}_v$  with  $|v| \leq |s|$  (possibly  $\mathbf{Z}_v = \mathbf{Z}$ ) and  $v \neq s$  such that  $\partial^c \mathbf{Z}_s \cap \partial^c \mathbf{Z}_v \neq \emptyset$ . Moreover,  $\partial^c \mathbf{Z}_s \cap \partial^c \mathbf{Z}_v = \{c_s\}$ .  $\square$*

We define the corresponding *finite bubble chain* as

$$B_s = (\hat{\mathbf{Z}}_{P_1}, \hat{\mathbf{Z}}_{P_1, P_2}, \dots, \hat{\mathbf{Z}}_{P_1, P_2, \dots, P_n}).$$

The *primary limb* rooted at  $c_{P_1}$  is

$$\mathbf{L}_{P_1} := \bigcup_{n \geq 1} \bigcup_{(P_1, \dots, P_n)} \hat{\mathbf{Z}}_{P_1, \dots, P_n},$$

where the union is taken over all finite sequences in  $\mathbb{T}_{>0}$  starting with  $P_1$ <sup>1</sup>. Similarly, the *secondary limbs*  $\mathbf{L}_{P_1, P_2}$  of  $\mathbf{Z}_{P_1}$  are defined.

We also consider *infinite bubble chains*: given

$$s = (P_1, P_2, \dots) \in \mathbb{T}_{>0}^{\mathbb{N}},$$

<sup>1</sup>This is not a standard definition of a limb because  $\mathbf{L}_{P_1}$  is not closed.

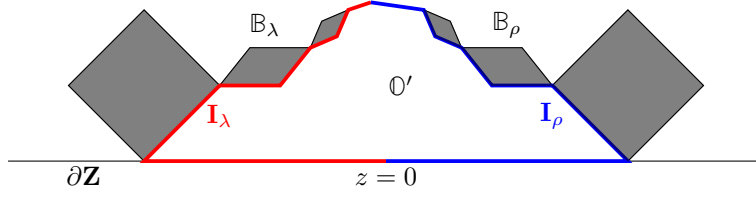

FIGURE 18. The case  $z = 0$ : the bubble chains  $\mathbb{B}_\lambda$  and  $\mathbb{B}_\rho$  of the lake  $\mathcal{O}'$  contain  $\mathbf{I}_\lambda \setminus \partial\mathbf{Z}$  and  $\mathbf{I}_\rho \setminus \partial\mathbf{Z}$  – the left and right sides of  $\partial^c\mathcal{O}'$ .

we set  $B_s = (\widehat{\mathbf{Z}}_{P_1}, \widehat{\mathbf{Z}}_{P_1, P_2}, \dots)$ . The *generation* of  $B_s$  is

$$|s| = P_1 + P_2 + \dots \leq \infty$$

(recall that we view  $\mathbb{T}$  as a sub-semigroup of  $\mathbb{R}_{>0}$ ); it is the supremum of generations of all the bubbles in the chain.

Given a finite or infinite bubble chain  $B_s$  with  $s = (P_1, P_2, \dots)$ , we write its geometric realization as

$$\mathbb{B}_s = \widehat{\mathbf{Z}}_{P_1} \cup \widehat{\mathbf{Z}}_{P_1, P_2} \cup \dots$$

and call it a *bubble chain* as well.

Suppose  $s$  is an infinite sequence. The *accumulating set* of  $B_s$  (and of  $\mathbb{B}_s$ ) is the accumulating set of  $\widehat{\mathbf{Z}}_{P_1}, \widehat{\mathbf{Z}}_{P_1, P_2}, \dots$ . If the accumulating set is a singleton  $\{x\}$ , then we say that  $B_s$  *lands* at  $x$ . (It will follow from Lemma 5.34 that every infinite bubble chain lands.)

If  $s$  is a finite sequence, then the *accumulating set* of  $B_s$  is

$$(5.1) \quad \overline{\mathbf{Z}}_s \setminus \widehat{\mathbf{Z}}_s \subset \mathbf{Esc}_P.$$

**Proposition 5.6.** *Every strictly preperiodic preimage of  $\mathbf{Z}$  component is contained in some limb  $\mathbf{L}_x$ .*

*Proof.* Let  $\mathbf{Z}' \neq \mathbf{Z}$  be a component of  $\mathbf{F}^{-P}(\mathbf{Z})$ . By Corollary 5.3,  $\partial^c\mathbf{Z}'$  is a simple arc in the tree  $\mathbf{F}^{-P}(\partial\mathbf{Z})$ . Let  $\gamma \subset \mathbf{F}^{-P}(\partial\mathbf{Z})$  be the tree-geodesic connecting  $\partial\mathbf{Z}$  to  $\partial^c\mathbf{Z}'$ . There are finitely many critical points

$$c_{P_1}, c_{P_2}, \dots, c_{P_1, \dots, P_n}$$

of  $\mathbf{F}^P$  in  $\gamma$ . We have  $\mathbf{Z}' = \mathbf{Z}_{P_1, \dots, P_n}$ . □

For a limb  $\mathbf{L}_s$  we write

$$\partial^c\mathbf{L}_s = \bigcup_{\mathbf{Z}_v \subset \mathbf{L}_s} \partial^c\mathbf{Z}_v$$

and, similarly, for a bubble chain  $\mathbb{B}_s$ :

$$\partial^c\mathbb{B}_s = \bigcup_{\mathbf{Z}_v \subset \mathbb{B}_s} \partial^c\mathbf{Z}_v.$$



**5.3. Lakes.** We call  $\mathbb{O} := \mathbb{C} \setminus \overline{\mathbf{Z}}$  the *lake of generation 0* or the *ocean*. A *lake of generation*  $P \in \mathbb{T}_{>0}$  is a connected component of  $\mathbf{F}^{-P}(\mathbb{O})$ . If  $\mathbb{O}_1$  is a lake of generation  $P \in \mathbb{T}$ , then its *coast* is

$$\partial^c \mathbb{O}_1 := \partial \mathbb{O}_1 \cap \text{Dom } \mathbf{F}^P.$$

By Lemma 5.1:

- $\mathbb{O}_1$  has a single access to  $\mathbf{Esc}_P(\mathbf{F})$ ;
- $\mathbf{F}^P: \mathbb{O}_1 \rightarrow \mathbb{O}$  is conformal;
- $\partial^c \mathbb{O}_1$  is a properly embedded simple arc in the tree  $\mathbf{F}^{-P}(\partial \mathbf{Z})$ ;
- $\mathbf{F}^P: \partial^c \mathbb{O}_1 \rightarrow \partial^c \mathbb{O} = \partial \mathbf{Z}$  is a homeomorphism.

We will call lakes of positive generation *proper*.

Since  $\mathbf{Z}$  is invariant, every two lakes are either disjoint or one is contained in the other. We can think that lakes are open puzzle pieces surrounded by bubble chains. For  $R > P > 0$ , every lake  $\mathbb{O}'$  of generation  $P$  consists of lakes of generation  $R$  and of bubbles of generation in  $(P, R]$ . The map  $\mathbf{F}^{R-P}: \mathbb{O}' \rightarrow \mathbb{O}$  is univalent, maps every lake of generation  $R$  to a lake of generation  $R - P$ , and maps every bubble of generation  $S$  to a bubble of generation  $S - P$ . Informally speaking, when  $P$  growth there are less water and more land, and the “drought” occurs in a self-similar fashion.

Consider a lake  $\mathbb{O}'$  of generation  $P$ . Let  $z \in \partial^c \mathbb{O}'$  be the closest point to 0 in the tree  $\mathbf{F}^{-P}(\partial \mathbf{Z})$ . Then  $z$  splits  $\partial^c \mathbb{O}'$  into two arcs  $I_\lambda$  and  $I_\rho$ . We assume that  $I_\lambda, [z, 0], I_\rho$  has a counterclockwise orientation at  $z$ ; if  $z = 0$ , then we assume that  $I_\lambda$  is on the left of 0 relative  $\partial \mathbf{Z}$  while  $I_\rho$  is on the right of 0, see Figure 18.

There are unique bubble chains  $\mathbb{B}_\lambda$  and  $\mathbb{B}_\rho$  containing  $I_\lambda \setminus \partial \mathbf{Z}$  and  $I_\rho \setminus \partial \mathbf{Z}$  respectively. (If  $I_\lambda \subset \mathbf{Z}$ ,<sup>2</sup> then set  $\mathbb{B}_\lambda = \emptyset$ , and similarly with  $I_\rho$ .) If  $\partial \mathbf{Z} \cap \partial \mathbb{O}' = \emptyset$ , then  $\partial^c \mathbb{O}' \subset \partial^c \mathbb{B}_\lambda \cup \partial^c \mathbb{B}_\rho$ . We now view  $\lambda = \lambda(\mathbb{O}')$  and  $\rho = \rho(\mathbb{O}')$  as sequences of positive power-triples parameterizing bubble chains as above, and we say that  $\mathbb{B}_\lambda$  and  $\mathbb{B}_\rho$  are the *left and the right* bubble chains of  $\mathbb{O}'$ .

**Lemma 5.7.** *Consider a lake  $\mathbb{O}'$  of generation  $P$  and let  $\mathbb{B}_\lambda$  and  $\mathbb{B}_\rho$  be the left and right bubble chains of  $\mathbb{O}'$ . Then  $\mathbb{B}_\lambda$  and  $\mathbb{B}_\rho$  have generation  $P$  as well. Moreover, one of the  $\lambda, \rho$  is a finite sequence while another is an infinite sequence.*

Lemma 5.7 is illustrated on Figure 19.

*Proof. Claim.* If  $J := \mathbb{O}' \cap \mathbf{Z} \neq \emptyset$ , then  $\mathbb{B}_\lambda$  and  $\mathbb{B}_\rho$  are non-empty.

*Proof.* By Corollary 5.3,  $J$  is an arc; choose  $x \in J$ . Both connected components of  $\partial \mathbf{Z} \setminus \{x\}$  contain infinitely many critical points of generation  $\leq P$  and these points are branch points of the tree  $\mathbf{F}^{-P}(\partial \mathbf{Z})$ . Since  $J$  does not cross such branch points,  $\mathbb{B}_\lambda$  and  $\mathbb{B}_\rho$  are non-empty.  $\square$

Suppose now that the generation  $R$  of  $\mathbb{B}_\lambda$  is less than  $P$ . Choose  $S$  with  $R < S < P$  such that  $\mathbf{F}^S(\mathbb{O}')$  intersects  $\partial \mathbf{Z}$ . The left bubble chain of  $\mathbf{F}^S(\mathbb{O}')$  is  $\mathbf{F}^S(\mathbb{B}_\lambda)$  which is empty; this is impossible by the above *Claim*. Since  $\mathbb{O}'$  is bounded by  $\mathbf{F}^{-P}(\partial \mathbf{Z})$ , the generation of  $\mathbb{B}_\lambda$  can not be bigger than  $P$ . This shows that  $\mathbb{B}_\lambda$  (and similarly  $\mathbb{B}_\rho$ ) has generation  $P$ .

<sup>2</sup>this is in fact impossible by Lemma 5.7

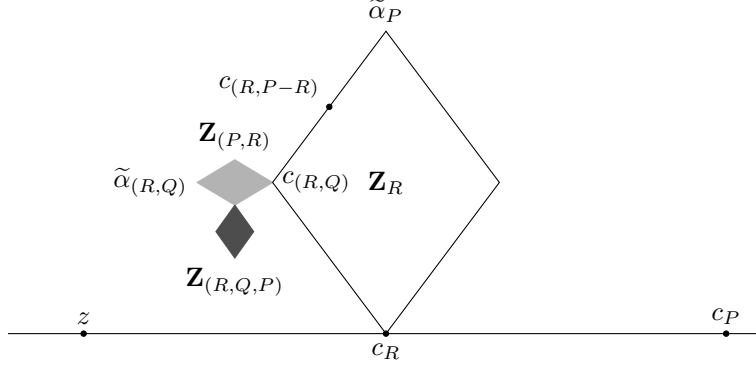

FIGURE 19. Suppose a lake  $\mathcal{O}'$  touches  $\partial\mathbf{Z}$ ; say  $z \in \overline{\mathcal{O}'} \cap \partial\mathbf{Z}$ . If  $c_P$  is on the right from  $z$ , then  $\mathbb{B}_\rho(\mathcal{O}')$  is finite. Indeed, let  $c_R$  be the critical point of generation  $\leq P$  such that  $c_R$  is the closest to  $z$  on the right. Assume  $R < P$ . Then  $c_{(R,P-R)} \in \partial^c \mathbf{Z}_R$  is on the left of  $c_R$ . Let  $c_{(P,Q)}$  be the critical point of generation  $\leq P-R$  closest to  $c_R \in \partial^c \mathbf{Z}_R$  on the left. Assume  $Q < P-R$ . Then  $c_{(R,Q,P-R-Q)} \in \partial^c \mathbf{Z}_{(R,Q)}$  is on the left of  $c_{(R,Q)}$ . Assume now that  $c_{(R,Q,P-R-Q)}$  is the closest to  $c_{(R,Q)} \in \partial^c \mathbf{Z}_{(R,Q)}$  on the left. Then  $\mathbb{B}_\rho(\mathcal{O}') = \mathbb{B}_{(R,Q,P-R-Q)} = \mathbf{Z}_R \cup \mathbf{Z}_{(R,Q)} \cup \mathbf{Z}_{(R,Q,P-R-Q)}$ .

Suppose now that  $\lambda$  and  $\rho$  are finite; write  $\lambda = (P_1, P_2, \dots, P_n)$  and  $\rho = (Q_1, Q_2, \dots, Q_m)$ . Then  $P_1 + \dots + P_n = Q_1 + \dots + Q_m = P$ . Choose  $H \in \mathbb{T}$  so that

$$P > H > \max\{P_1 + \dots + P_{n-1}, Q_1 + \dots + Q_{m-1}\}.$$

On the one hand,  $\mathbf{F}^H(\widehat{\mathbf{Z}}_\lambda) = \widehat{\mathbf{Z}}_{P-H}$  (the unique bubble of generation  $P-H$  attached to  $\partial\mathbf{Z}$ ) is the left bubble chain of the lake  $\mathbf{F}^H(\mathcal{O}')$ ; and on the other hand  $\mathbf{F}^H(\widehat{\mathbf{Z}}_\rho) = \widehat{\mathbf{Z}}_{P-H}$  is the right bubble chain of  $\mathbf{F}^H(\mathcal{O}')$  – this is impossible.

Let us now prove that either  $\lambda$  or  $\rho$  is a finite sequence.

*Case 1:* assume  $J = \mathcal{O}' \cap \mathbf{Z} \neq \emptyset$  and there is  $y \in J$  such that the subarc  $[y, c_P]$  of  $\partial\mathbf{Z}$  contains no critical points of generation  $< P$ . Since  $[y, c_P]$  and  $\partial^c \mathbf{Z}_P \setminus \{c_P\}$  contain no branch points of the tree  $\mathbf{F}^{-P}(\partial\mathbf{Z})$ , we obtain that  $\widehat{\mathbf{Z}}_P$  is either  $\mathbb{B}_\lambda$  or  $\mathbb{B}_\rho$ .

*Case 2:* assume  $J = \mathcal{O}' \cap \mathbf{Z} \neq \emptyset$ . Choose  $y \in J$ . There are at most finitely many critical points in  $[y, c_P]$  of generation  $< P$ . Then the generation of these critical points is less than some  $R < P$ . Then  $[\mathbf{F}^R(y), c_{P-R}]$  contains no critical points of generation  $< P-R$ ; i.e.  $\mathbf{F}^R(\mathcal{O}')$  satisfies Case 1. Therefore, either  $\mathbf{F}^R(\mathbb{B}_\lambda)$  or  $\mathbf{F}^R(\mathbb{B}_\rho)$  is a finite chain; this implies that either  $\mathbb{B}_\lambda$  or  $\mathbb{B}_\rho$  is a finite chain.

For a general lake  $\mathcal{O}'$  consider  $R < P$  such that  $\overline{\mathbf{F}^R(\mathcal{O}')} \cap \partial\mathbf{Z}$  intersects  $\partial\mathbf{Z}$ . By Case 2, either  $\mathbf{F}^R(\mathbb{B}_\lambda)$  or  $\mathbf{F}^R(\mathbb{B}_\rho)$  is a finite chain, implying the desired.  $\square$

Consider a bubble  $\mathbf{Z}_s$  where  $s = (P_1, P_2, \dots, P_n) \in \mathbb{T}_{>0}^n$ . Write  $P = P_1 + \dots + P_n$ . Let  $\gamma \subset \mathbf{F}^{-P}(\partial\mathbf{Z})$  be the unique tree-geodesic connecting 0 to  $c_s$  which is the root of  $\mathbf{Z}_s$ . Denote by  $\partial_-^c \mathbf{Z}_s$  and  $\partial_+^c \mathbf{Z}_s$  two connected components of  $\partial^c \mathbf{Z}_s \setminus \{c_s\}$  enumerated so that the triple  $\partial_-^c \mathbf{Z}_s, \gamma, \partial_+^c \mathbf{Z}_s$  has counterclockwise orientation at  $c_s$ .

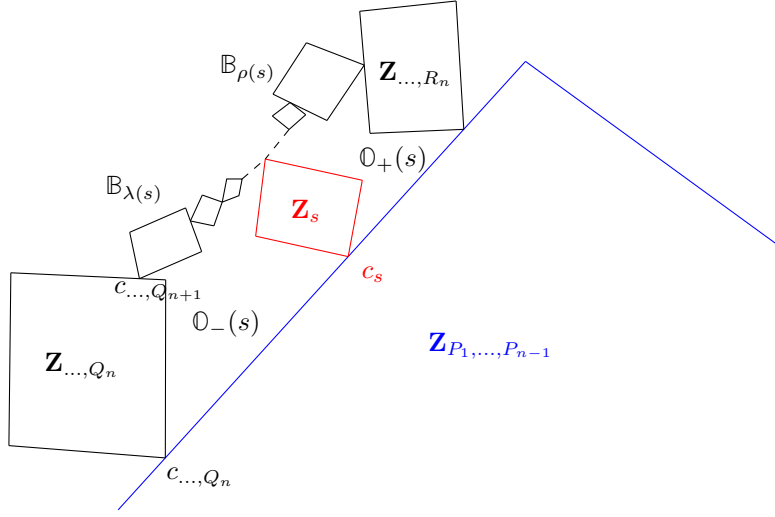

FIGURE 20. The bubble chains  $\mathbb{B}_\lambda$  and  $\mathbb{B}_\rho$  are the closest to  $\mathbf{Z}_s$  of generation  $\leq P$  (see also Figure 24). By Lemma 5.11,  $\mathbb{B}_\lambda$  and  $\mathbb{B}_\rho$  actually land at the top of  $\mathbf{Z}_s$ .

There are unique lakes  $\mathbb{O}_-(s)$  and  $\mathbb{O}_+(s)$  of generation  $P$  such that

$$\partial^c \mathbb{O}_-(s) \supset \partial^c \mathbf{Z}_s \quad \text{and} \quad \partial^c \mathbb{O}_+(s) \supset \partial^c \mathbf{Z}_s$$

because  $\partial^c \mathbf{Z}_s$  and  $\partial^c_+ \mathbf{Z}_s$  have no critical points of generation  $\leq P$ . We define  $\mathbb{B}_{\lambda(s)}$  to be the left bubble chain of  $\mathbb{O}_-(s)$  and we define  $\mathbb{B}_{\rho(s)}$  to be the right bubble chain of  $\mathbb{O}_+(s)$ , see Figure 20.

We call  $\mathbb{O}_-(s)$  the *left lake* of  $\mathbf{Z}_s$  and we call  $\mathbb{O}_+(s)$  the *right lake* of  $\mathbf{Z}_s$ . By construction,  $\mathbb{B}_{\lambda(s)}$  and  $\mathbb{B}_{\rho(s)}$  are the closest to  $\mathbf{B}_s$  bubble chains of generation at most  $P$ .

**Lemma 5.8.** *For every  $\mathbf{Z}_s$  the bubble chains  $\mathbb{B}_{\lambda(s)}$  and  $\mathbb{B}_{\rho(s)}$  are infinite chains of generation  $|s|$ .*

*For every proper lake  $\mathbb{O}'$  there is a unique  $\mathbf{Z}_s$  such that either  $\mathbb{O}' = \mathbb{O}_-(s)$  or  $\mathbb{O}' = \mathbb{O}_+(s)$ .*

*Proof.* The first claim follows immediately from Lemma 5.7.

By Lemma 5.7, either the left bubble chain  $\mathbb{B}_\lambda$  of  $\mathbb{O}'$  or its right bubble chain  $\mathbb{B}_\rho$  is a finite chain. In the former case,  $\mathbb{O}' = \mathbb{O}_+(\lambda)$ ; in the latter case,  $\mathbb{O}' = \mathbb{O}_-(\rho)$ .  $\square$

For a finite or infinite sequence  $s = (P_1, P_2, \dots)$  let us write  $\mathbf{t}s := (tP_1, tP_2, \dots)$

**Lemma 5.9.** *The self-similarity  $A_\star$  preserves the Fatou and Julia sets of the fixed maximal prepacman  $\mathbf{F}$ ; moreover for every finite sequence  $s$  we have:*

- $A_\star(c_s) = c_{\mathbf{t}s}$ ;
- $A_\star(\mathbf{Z}_s) = \mathbf{Z}_{\mathbf{t}s}$ ;
- $A_\star(\mathbb{B}_s) = \mathbb{B}_{\mathbf{t}s}$ , here  $s$  is either a finite or an infinite sequence;
- $A_\star(\mathbf{L}_s) = \mathbf{L}_{\mathbf{t}s}$ ;
- $A_\star(\tilde{\alpha}_s) = \tilde{\alpha}_{\mathbf{t}s}$ .

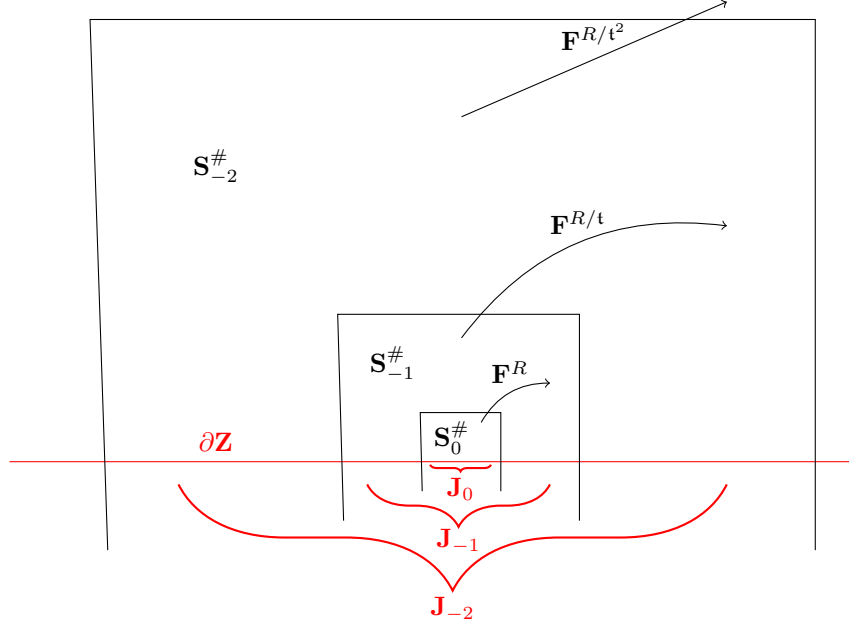

FIGURE 21. Illustration to the proof of Lemma 5.10: it takes  $R/t^n$  iterates to cover  $\mathbf{S}_{-n-1}^\# \setminus \mathbf{Z}$  from a domain in  $\mathbf{S}_{-n}^\# \setminus \mathbf{Z}$ .

*Proof.* Recall that  $A_\star$  conjugates  $\mathbf{F}^P$  to  $\mathbf{F}^{tP}$ ; hence  $A_\star$  preserves the Fatou and Julia sets. Since  $A_\star(\partial\mathbf{Z}) = \partial\mathbf{Z}$ , we have  $A_\star(c_P) = c_{tP}$ . As a consequence,  $A_\star(\mathbf{Z}_P) = \mathbf{Z}_{tP}$  and  $A_\star(\tilde{\alpha}_P) = \tilde{\alpha}_{tP}$ . Since  $A_\star(\partial^c\mathbf{Z}_P) = \partial^c\mathbf{Z}_{tP}$ , we also have  $A_\star(c_{(P,Q)}) = c_{(tP,tQ)}$  and we can proceed by induction on  $|s|$ .  $\square$

#### 5.4. Boundedness of limbs.

**Lemma 5.10.** *The closure of every limb is compact.*

*Proof.* The idea of the proof is illustrated in Figure 21. We will show that there is an  $R \in \mathbb{T}_{>0}$  such that  $\mathbf{F}^R(\mathbf{S}_0^\# \setminus \mathbf{Z}) \supset \mathbf{S}_{-1}^\# \setminus \mathbf{Z}$ . By self-similarity,  $\mathbf{F}^{R/t}(\mathbf{S}_{-1}^\# \setminus \mathbf{Z}) \supset \mathbf{S}_{-2}^\# \setminus \mathbf{Z}$ . Therefore, if  $Q \geq R + R/t + R/t^2 + \dots$ , then  $\mathbf{F}^Q(\mathbf{S}_0^\# \setminus \mathbf{Z}) = \mathbb{C}$ . This implies that some limbs are bounded. Therefore, all the limbs are bounded because they are dynamically related. Let us provide more details.

Consider the dynamical plane of  $f: U \rightarrow V$ . For every  $n$ , there is a gluing map  $\rho_n: \mathbf{S}_n^\# \rightarrow V \setminus \{\alpha\}$  projecting  $\mathbf{F}_n^\#$  to  $f$ . The map  $\rho_n$  glues two distinguished sides of  $\mathbf{S}_n^\#$  to  $\gamma_1$ ; the preimage of  $\alpha$  is at infinity. Since  $\mathbf{F}$  is a renormalization fixed point,  $\mathbf{S}_{n-1}^\#$  is a rescaling of  $\mathbf{S}_n^\#$ ; we also recall that:

- $\mathbf{S}_n^\# \subset \mathbf{S}_{n-1}^\#$ ; and
- $\bigcup_n \mathbf{S}_n^\# = \mathbb{C}$ .

Choose a big  $m \ll 0$  and let  $X$  and  $Y$  be the open sectors in the dynamical plane of  $f$  obtained by projecting  $\mathbf{S}_0^\#$  and  $\mathbf{S}_{-1}^\#$  via  $\rho_n: \mathbf{S}_n^\# \rightarrow V$ , see Figure 22. Write

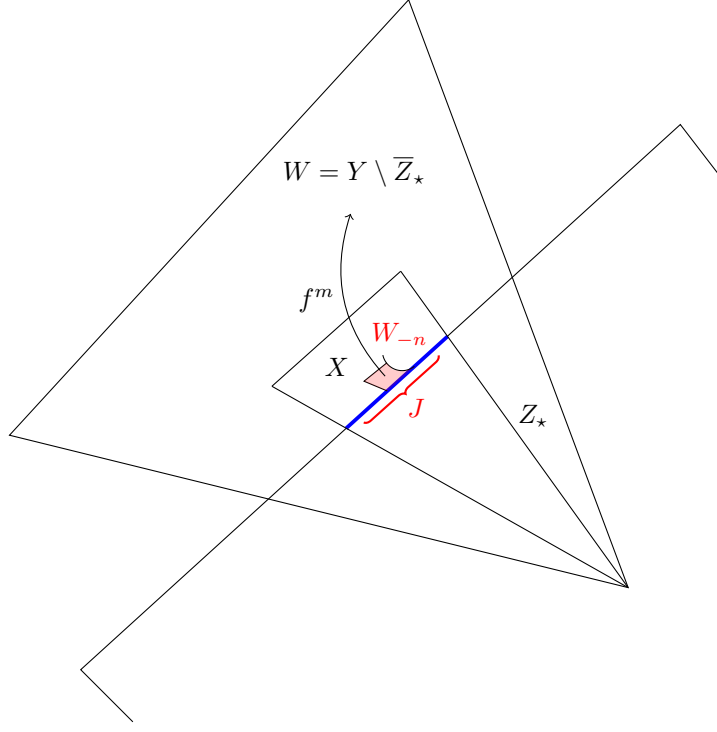

FIGURE 22. Illustration to Claim 1: the disk  $W = Y \setminus \overline{Z}_*$  pullbacks along the orbit of  $x$  to the disk  $W_{-m} \subset S$ .

$W = Y \setminus Z_*$  and  $I := X \cap \partial Z_*$  (depicted in blue bold on Figure 22); and let  $J$  be a slightly shrunk version of  $I$ .

**Claim 1.** *There is an  $M > 0$  such that the following property holds. If  $m \geq M$ ,  $x \in J$ , and  $f^m(x) \in \partial W$ , then  $W$  has a conformal pullback  $W_{-m}$  along the orbit  $x, f(x), \dots, f^m(x) \in W$  such that  $W_{-m} \subset X$ .*

We remark that if  $x$  is a critical point, then there are two choices for  $W_{-m}$ : on the left and on the right of  $c_0$ .

*Proof.* Let  $W_{-k}$  be the pullback of  $W$  along the orbit of  $f^{-k}(x), \dots, f^m(x)$ . Let us show that  $W_{-k}$  does not intersect the forbidden boundary  $\partial^{\text{frb}}U$  for all  $k \in \{m-1, \dots, 0\}$ ; this will imply that  $W_{-m}$  is a conformal pullback.

Recall from §3.2.5 that  $f$  has a lamination by external rays. Choose two rays  $R_-$  and  $R_+$  landing at  $\overline{Z}_*$  such that  $R_-$  is slightly on the left of  $W$  and  $R_+$  is slightly on the right of  $W$ . Since  $m \ll 0$ , the difference  $\delta$  between the external angles of  $R_-$  and  $R_+$  is small.

Let  $R_{-k,-}$  and  $R_{-k,+}$  be the preimages of  $R_-$  and  $R_+$  under  $f^{m-k}$  such that  $R_{-k,-}$  is slightly on the left of  $W_{-k}$  and  $R_{-k,+}$  is slightly on the right of  $W_{-k}$ . Then the difference between the external angles of  $R_{-k,-}$  and  $R_{-k,+}$  is  $\delta/2^k$ ; i.e.  $W_{-k}$  has a small angular size. Recall that  $\gamma_- \cup \gamma_+ \setminus \overline{Z}'_*$  are external rays that are disjoint

from  $\overline{Z}_*$ , see §3.2.5. Since  $\partial W_{-k}$  intersects  $\partial Z_*$ , we obtain that  $\partial W_{-k}$  is disjoint from  $\partial^{\text{frb}}U$ . This shows that  $f^m: W_{-m} \rightarrow W$  is conformal.

If  $m$  is big, then  $W_{-m}$  is contained in a small neighborhood of the non-escaping set  $K$  between  $R_{-m,-}$  and  $R_{-m,+}$ . Since  $K$  is locally connected and the difference between the external angles of  $R_{-m,-}$  and  $R_{-m,+}$  is small, the set  $W_{-m}$  is contained in a small neighborhood of  $J$ ; hence  $W_{-m} \subset X$ .  $\square$

Suppose  $\mathbf{J}_n$  corresponds to  $J$  under the identification  $\mathbf{S}_n^\# \simeq X$ , see Figure 21. As a corollary of Claim 1 we have:

**Claim 2.** *There is power-triple  $R > 0$  with  $\mathbf{F}^R(\mathbf{J}_0) \subset \mathbf{J}_{-1}$  such that the following property holds. If  $x \in \mathbf{J}_0$  and  $\mathbf{F}^P(x) \in \mathbf{S}_{-1}^\#$  for some  $P \geq R$ , then there is an open set  $W_P \subset \mathbf{S}_0$  with  $x \in \partial W_P$  such that  $\mathbf{F}^P$  maps  $W_P$  conformally onto  $\text{int}(\mathbf{S}_{-1}^\# \setminus \mathbf{Z})$ .*

*Proof.* By Lemma 5.2, the cascade  $(\mathbf{F}^P | \partial \mathbf{Z})_{P \in \mathbb{T}}$  is conjugate to the cascade of translations  $(T^P | \mathbb{R})_{P \in \mathbb{T}}$ . Therefore, we can choose a sufficiently big  $R$  with  $\mathbf{F}^R(\mathbf{J}_0) \subset \mathbf{J}_{-1}$ .

Since  $\mathbf{F}^P(x) \in \mathbf{S}_{-1}^\#$ , we can write

$$\mathbf{F}^P = \mathbf{f}_{-1,\iota(1)}^\# \circ \mathbf{f}_{-1,\iota(2)}^\# \circ \cdots \circ \mathbf{f}_{-1,\iota(m)}^\#, \quad \iota(j) \in \{-, +\}$$

because the prepacman  $\mathbf{f}_{-1,\pm}^\#: \mathbf{U}_\pm^\# \rightarrow \mathbf{S}_{-1}^\#$  realizes the first return of the cascade  $\mathbf{F}^{\geq 0}$ . If  $R$  is sufficiently big, then  $m \geq M$ , where  $M$  is the constant from Claim 1. The statement now follows from Claim 1.  $\square$

By self-similarity, we can shift indices in Claim 2: we can replace  $\mathbf{J}_0, \mathbf{J}_{-1}, \mathbf{S}_{-1}^\#$  by  $\mathbf{J}_n, \mathbf{J}_{n-1}, \mathbf{S}_{n-1}^\#$  and replace  $R$  by  $R/t^{-n}$ . Inductively applying Claim 2, we obtain:

**Claim 3.** *There is power-triple  $Q > 0$  such that for every  $n < 0$  the following property holds. Let  $x \in \mathbf{J}_0$  be a point such that  $\mathbf{F}^P(x) \in \mathbf{S}_n^\#$  with  $P \geq Q$ . Then there is an open set  $W \subset \mathbf{S}_0$  with  $x \in \partial W$  such that  $\mathbf{F}^P$  maps  $W$  conformally to  $\text{int}(\mathbf{S}_n^\# \setminus \mathbf{Z})$ .*

*Proof.* Let  $R$  be a power-triple from Claim 2. Choose a power-triple  $Q$  with

$$Q > R + R/t + R/t^2 + \dots,$$

see Lemma 4.1. Write  $x_0 = x$  and for  $j \in \{0, -1, \dots, n+2\}$  inductively set  $P_j := R/t^{-j}$  and  $x_{j-1} := \mathbf{F}^{P_j}(x_j)$ . Finally set

$$P_{n+1} := P - P_0 - P_1 - \dots - P_{n+2} \geq R/t^{n+1}.$$

and  $x_n = \mathbf{F}_{n+1}^{P_{n+1}}(x_{n+1})$ . Since  $P_{n+1} \geq R/t^{-n-1}$ , we can apply Claim 2 and construct  $W_{n+1} \subset \mathbf{S}_{n+1}^\# \setminus \mathbf{Z}$  so that  $x_{n+1} \in \partial W_{n+1}$  and  $\mathbf{F}^{P_{n+1}}$  maps  $W_{n+1}$  conformally to  $\mathbf{S}_n^\# \setminus \mathbf{Z}$ . Applying induction from upper levels to dipper ones, we construct  $W_j \subset \mathbf{S}_j^\# \setminus \mathbf{Z}$  such that  $x_j \in \partial W_j$  and  $\mathbf{F}^{P_j}$  maps  $W_j$  conformally to  $W_{j-1}$ . Therefore,  $\mathbf{F}^P$  maps  $W_0$  conformally to  $\mathbf{S}_n^\# \setminus \mathbf{Z}$ .  $\square$

Consider a limb  $\mathbf{L}_M$ ; recall that its root is denoted by  $c_M$ . Choose a big  $T \geq Q + M$  such that the critical point  $c_T$  is in  $\mathbf{J}_0$ . Then  $c_T$  is the root of  $\mathbf{L}_T$  and  $\mathbf{F}^{T-M}$  maps  $\mathbf{L}_T$  to  $\mathbf{L}_M$ .

By Claim 3, for all  $n \ll 0$  the connected component of  $\mathbf{S}_n^\# \cap \mathbf{L}_M$  containing  $c_M$  can be pulled back along  $\mathbf{F}^{T-M}: c_T \mapsto c_M$  and, moreover, the pullback is within

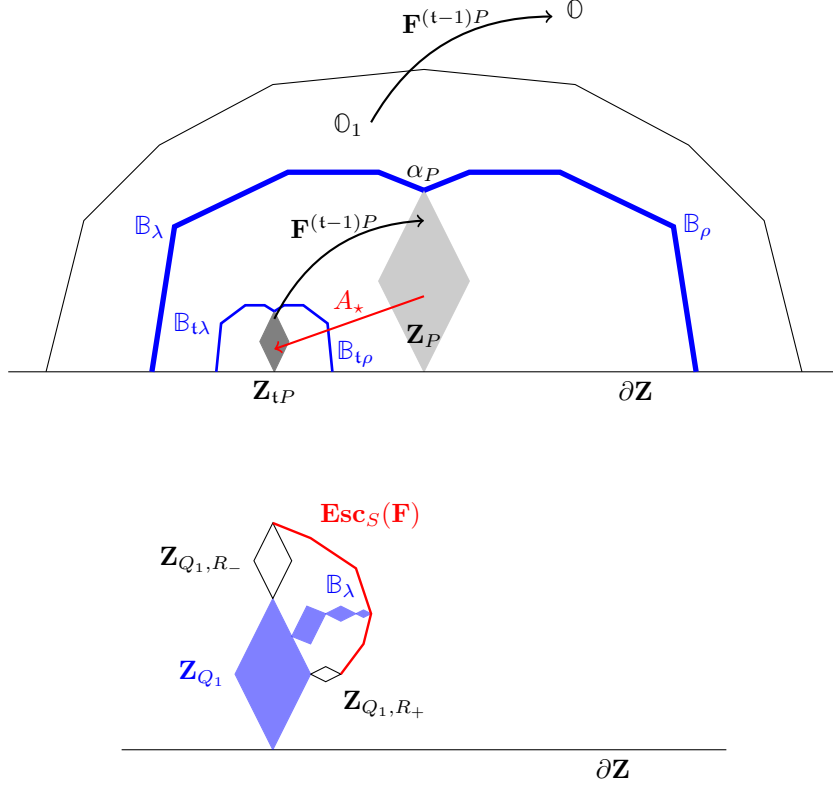

FIGURE 23. Illustration to the proof of Lemma 5.11 (see also Figure 24): the accumulating set of  $\mathbf{Z}_P, \mathbb{B}_\lambda, \mathbb{B}_\rho$  is invariant under the expanding map  $\mathbf{F}^{(t-1)P} \circ A_*: \mathbb{O}_1 \rightarrow \mathbb{O}$ ; thus  $\mathbf{Z}_P, \mathbb{B}_\lambda$ , and  $\mathbb{B}_\rho$  land at  $\alpha_P$ . Bottom:  $\text{Esc}_S(\mathbf{F}) \cup \mathbf{Z}_{Q_1, R_-} \cup \mathbf{Z}_{Q_1} \cup \mathbf{Z}_{Q_1, R_+}$  separates the accumulating set of  $\mathbb{B}_\lambda$  from  $\partial \mathbf{Z}$ .

$\mathbf{S}_0$ . Since  $n \ll 0$  is arbitrary and  $\mathbf{S}_n^\# \cap \mathbf{F}^M$ , the pullbacks of  $\mathbf{S}_n^\# \cap \mathbf{L}_M$  exhaust  $\mathbf{L}_T$ , and we obtain that  $\mathbf{L}_T \subset \mathbf{S}_0$ .

By self-similarity, the limb  $\mathbf{L}_{T/t^m}$  is within  $\mathbf{S}_{-m}^\#$  for all  $m \geq 0$ . For every  $H > 0$  choose an  $m \geq 0$  with  $H \geq T/t^m$ . Then  $\mathbf{F}^{H-T/t^m}$  maps  $\mathbf{L}_H$  conformally to  $\mathbf{L}_{T/t^m}$ . Since  $\mathbf{L}_{T/t^m}$  is bounded, so is  $\mathbf{L}_H$  by  $\sigma$ -properness.  $\square$

**5.5. Alpha-points.** Consider a finite sequence  $s = (P_1, P_2, \dots, P_n)$  in  $\mathbb{T}_{>0}$  and the corresponding bubble  $\mathbf{Z}_s$ . Write  $P = |s| = P_1 + \dots + P_n$ . Recall from (5.1) that  $\mathbb{B}_s$  denotes the accumulating set of  $\mathbb{B}_s$ . By Lemma 5.10,  $\tilde{\alpha}_s$  is a compact subset of  $\text{Esc}_P(\mathbf{F})$ , which is disjoint from  $\partial \mathbf{Z}$ .

**Lemma 5.11.** *The set  $\tilde{\alpha}_s = \{\alpha_s\}$  is a singleton. Moreover,  $\alpha_s$  is the landing point of  $\mathbb{B}_s, \mathbb{B}_{\lambda(s)}, \mathbb{B}_{\rho(s)}$ . We have:*

$$\partial \mathbb{O}_-(s) = \partial^c \mathbb{O}_-(s) \cup \tilde{\alpha}_s \quad \text{and} \quad \partial \mathbb{O}_+(s) = \partial^c \mathbb{O}_+(s) \cup \tilde{\alpha}_s,$$

$\mathbb{O}_-(s)$  and  $\mathbb{O}_+(s)$  are bounded sets, and  $\bar{\mathbf{Z}}_s, \bar{\mathbb{O}}_-(s), \bar{\mathbb{O}}_+(s)$  are closed topological disks.

*Proof.* Consider a critical point  $c_P \in \partial \mathbf{Z}$  of generation  $P$ . Since all  $(\mathbb{O}_-(s), \mathbf{Z}_s, (\mathbb{O}_+(s)))$  are dynamically related it is sufficient to verify the statement for  $(\mathbb{O}_-(P), \mathbf{Z}_P, (\mathbb{O}_+(P)))$ .

By Lemma 5.9,  $c_{tP} = A_\star(c_P)$ , and

$$(5.2) \quad A_\star \text{ maps } (\mathbb{O}_-(P), \mathbf{Z}_P, (\mathbb{O}_+(P))) \text{ to } (\mathbb{O}_-(tP), \mathbf{Z}_{tP}, (\mathbb{O}_+(tP))).$$

On the other hand (see Figure 23),

$$(5.3) \quad \mathbf{F}^{(t-1)P} \text{ maps } (\mathbb{O}_-(tP), \mathbf{Z}_{tP}, (\mathbb{O}_+(tP))) \text{ to } (\mathbb{O}_-(P), \mathbf{Z}_P, (\mathbb{O}_+(P))).$$

Let  $\mathbb{O}_1$  be the lake of generation  $(t-1)P/t$  containing  $\mathbb{O}_-(P) \cup \mathbf{Z}_P \cup \mathbb{O}_+(P)$ . Then the lake  $A_\star(\mathbb{O}_1) \supset \mathbb{O}_-(tP) \cup \mathbf{Z}_{tP} \cup \mathbb{O}_+(tP)$  has generation  $(t-1)P$ . By Schwarz lemma,

$$(5.4) \quad \mathbf{F}^{(t-1)P} \circ A_\star: \mathbb{O}_1 \rightarrow \mathbb{O} \quad (\text{where } \mathbb{O} = \mathbb{C} \setminus \mathbf{Z} \text{ is an ocean})$$

expands the hyperbolic metric of  $\mathbb{O}$ . Since  $\tilde{\alpha}_P$  is a set compactly contained in  $\mathbb{O}$  (because  $\tilde{\alpha}_P$  is a compact subset of  $\mathbf{Esc}_P(\mathbf{F})$ , which is disjoint from  $\partial \mathbf{Z}$ ) and since  $\tilde{\alpha}_P$  is invariant under (5.4), we see that  $\tilde{\alpha}_P = \{\alpha_P\}$  is a singleton and  $\alpha_P$  is a repelling fixed point of (5.4).

Let  $\tilde{\alpha}_P^-$  be the accumulating set of  $\mathbb{B}_{\lambda(s)}$ . Let us argue that  $\tilde{\alpha}_P^- \in \mathbb{O}$ . By Lemma 5.10,  $\tilde{\alpha}_P^-$  is a compact subset of  $\mathbb{C}$ . Write  $\lambda(s) = (Q_1, Q_2, \dots)$  and choose two  $R_-$  and  $R_+$  such that  $\mathbf{Z}_{Q_1, R_-}$  is on the left of  $\mathbf{Z}_{Q_1, Q_2}$  while  $\mathbf{Z}_{Q_1, R_+}$  is on the right of  $\mathbf{Z}_{Q_1, Q_2}$ , see Figure 23 (bottom). Set  $S = \max\{Q_1 + R_-, Q_2 + R_+\}$ . Since every connected component of  $\mathbf{Esc}_P(\mathbf{F})$  is unbounded (see §4.9),

$$\mathbf{Esc}_S(\mathbf{F}) \cup \mathbf{Z}_{Q_1} \cup \mathbf{Z}_{Q_1, R_-} \mathbf{Z}_{Q_1, R_+}$$

separates  $\tilde{\alpha}_P^- \setminus \mathbf{Esc}_S(\mathbf{F})$  from  $\mathbf{Z}$ .

Since  $\tilde{\alpha}_P^-$  is also invariant under (5.4) (because of (5.2) and (5.3)), we obtain that  $\tilde{\alpha}_P^- = \tilde{\alpha}_P = \{\alpha_P\}$ ; i.e.  $\mathbb{B}_{\lambda(s)}$  lands at  $\alpha_P$ . Similarly,  $\mathbb{B}_{\rho(s)}$  lands at  $\alpha_P$ . As a consequence,  $\overline{\mathbf{Z}}_s, \overline{\mathbb{O}}_-(s), \overline{\mathbb{O}}_+(s)$  are closed topological disks.  $\square$

We say that  $\{\alpha_s\}$  are *alpha-points*. They viewed as preimages of  $\alpha$ :

**Lemma 5.12.** *Suppose  $\gamma: [0, 1) \rightarrow \mathbf{Z}$  is a curve that goes to  $\infty$ . Let  $\Gamma = \{\gamma_i\}$  be the set of lifts of  $\gamma$  under  $\mathbf{F}^T$ , where  $T \in \mathbb{T}_{>0}$ . There is a unique lift  $\gamma_0 \in \Gamma$  such that  $\gamma_0 \subset \mathbf{Z}$ . Every remaining  $\gamma_i \in \Gamma \setminus \{\gamma_0\}$  is within  $\mathbf{Z}_s$  with  $0 < |s| \leq T$  and, moreover,  $\gamma_i$  lands at  $\alpha_s$ . Conversely, for every  $\alpha_s$  with  $|s| \leq T$  there is a unique  $\gamma_i \in \Gamma$  such that  $\gamma_i$  lands at  $\alpha_i$ .*

*Proof.* Since  $\mathbf{Z}_s$  with  $|s| \leq T$  are univalent preimages of  $\mathbf{Z}$ , every  $\gamma_i$  is contained in a certain  $\mathbf{Z}_s$ . Moreover,  $\gamma_i$  accumulates at  $\tilde{\alpha}_s = \{\alpha_s\}$  which is a singleton by Lemma 5.11; i.e.  $\gamma_i$  lands at  $\alpha_s$ .  $\square$

**Lemma 5.13.** *If  $\alpha_s = \alpha_v$ , then  $s = v$ .*

*Proof.* If  $\alpha_s$  and  $\alpha_v$  have different generations, then  $\alpha_v \neq \alpha_s$ . Suppose that  $|s| = v$  and write  $s = (P_1, P_2, \dots, P_n)$  and  $v = (Q_1, Q_2, \dots, Q_m)$ . Choose  $R < |s|$  such that  $R > \max\{P_1 + \dots + P_{n-1}, Q_1 + \dots + Q_{m-1}\}$ . Then  $\mathbf{F}^R(\mathbf{Z}_s) = \mathbf{F}^R(\mathbf{Z}_v) = \mathbf{Z}_{|s|-R}$ . Since  $\overline{\mathbf{Z}}_{|s|-R}$  does not contain a critical value of  $\mathbf{F}^R$ , we obtain that  $\mathbf{Z}_s$  and  $\mathbf{Z}_v$  are different degree one preimages of  $\mathbf{Z}_{|s|-R}$ .  $\square$

**Corollary 5.14** (The tree structure of  $\{\overline{\mathbf{Z}}_s\}$ ). *Suppose that  $\overline{\mathbf{Z}}_v \cap \overline{\mathbf{Z}}_w \neq \emptyset$  for  $|w| \geq |v|$  and  $w \neq v$ . Then  $c_w \in \partial \mathbf{Z}_w$  and  $\mathbf{Z}_v \cap \overline{\mathbf{Z}}_w = \{c_w\}$ .*



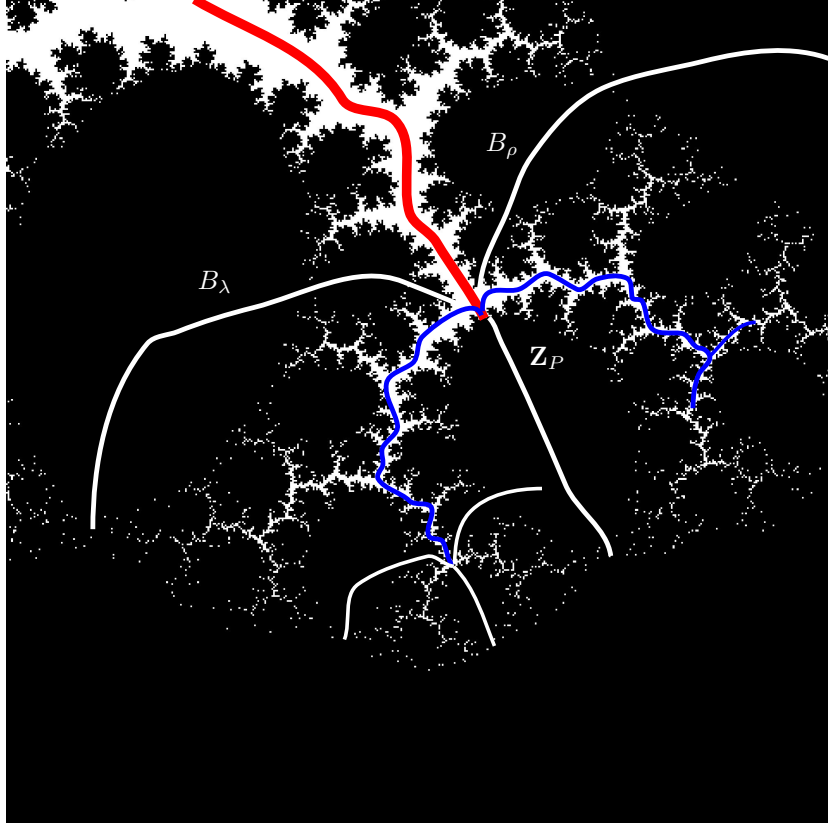

FIGURE 24. Illustration to the proof of Lemma 5.11 (compare with Figure 15):  $\mathbf{Z}_P, B_\lambda, B_\rho$  land at  $\alpha_P$  that belongs to  $\mathbf{Esc}_P(\mathbf{F})$  (marked red). There are two branches of  $\mathbf{Esc}_{tP}(\mathbf{F}) \setminus \mathbf{Esc}_P(\mathbf{F})$  (marked blue) at  $\alpha_P$ . The left branch ends at  $\alpha_{tP}$  that is the landing point of  $\mathbf{Z}_{tP}, B_{t\lambda}, B_{t\rho}$ .

For every two closed bubbles  $\bar{\mathbf{Z}}_v \neq \bar{\mathbf{Z}}_w$ , there is a unique sequence of pairwise different closed bubbles  $\bar{\mathbf{Z}}_{s(1)}, \bar{\mathbf{Z}}_{s(2)}, \dots, \bar{\mathbf{Z}}_{s(n)}$  such that

- $\bar{\mathbf{Z}}_{s(i)}$  intersects  $\bar{\mathbf{Z}}_{s(i+1)}$ ;
- $s(1) = v$  and  $s(n) = w$ .

*Proof.* By Lemma 5.13,  $\bar{\mathbf{Z}}_v$  and  $\bar{\mathbf{Z}}_w$  do not intersect at their alpha-points. By Lemma 5.5,  $\bar{\mathbf{Z}}_v$  and  $\bar{\mathbf{Z}}_w$  can only intersect when  $\bar{\mathbf{Z}}_v$  contains the root of  $\bar{\mathbf{Z}}_w$ .

The second claim follows from Lemma 5.5.  $\square$

Since every lake  $\mathcal{O}'$  is either  $\mathcal{O}_-(s)$  or  $\mathcal{O}_+(s)$  for a certain sequence  $s$  (Lemma 5.8), we have:

**Corollary 5.15.** *The closure of every proper lake is a compact subset of  $\mathbb{C}$ . For a lake  $\mathcal{O}'$ , we have  $\partial\mathcal{O}' = \partial^c\mathcal{O}' \cup \{\alpha'\}$ , where  $\alpha'$  is an alpha-point of the same generation as  $\mathcal{O}'$ .*  $\square$

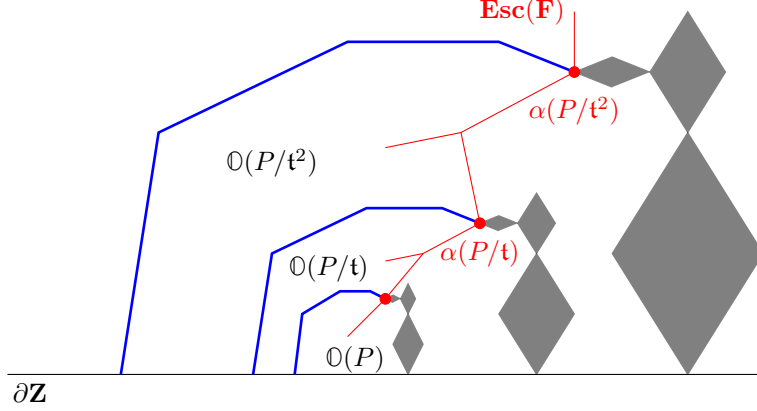

FIGURE 25. Lakes  $\mathbb{O}(t^n P)$  cover  $\mathbb{C}$ . The boundary  $\partial\mathbb{O}(t^n P)$  contains a unique point  $\alpha(t^n P)$  in  $\mathbf{Esc}(\mathbf{F})$ . Therefore, every connected component of  $\mathbf{Esc}_P(\mathbf{F})$  intersecting  $\mathbb{O}(t^n P)$  also contains  $\alpha(t^n P)$ .

**5.6. Lakes exhaust the ocean.** Choose  $P \in \mathbb{T}_{>0}$  and let  $\mathbb{O}(P)$  be the lake of generation  $P$  such that  $\partial\mathbb{O}(P) \ni 0$ . Then  $\partial\mathbb{O}(P)$  also contains an arc  $J \ni 0$  of  $\partial\mathbf{Z}$  such that  $0$  is not an endpoint of  $J$ . It follows that  $\mathbb{O}(t^n P) = A_\star^n(\mathbb{O}(P))$  also contains  $0$  on its boundary, and we have (see Figure 25).

$$(5.5) \quad \bigcup_{n < 0} \mathbb{O}(t^n P) = \mathbb{O}.$$

Let us denote by  $\alpha(t^n P)$  the unique alpha-point in  $\partial\mathbb{O}(t^n P)$ , see Corollary 5.15.

**Lemma 5.16.** *Let  $I$  be a connected component of  $\mathbf{Esc}_P(\mathbf{F})$ . Then  $I$  contains  $\alpha(t^n P)$  for all sufficiently big  $n \ll 0$ .*

*If  $J$  is a connected subset of  $\mathbf{Esc}_P(\mathbf{F})$  such that  $J \cap \mathbb{O}(t^n P) \neq \emptyset$  but  $J \not\ni \alpha(t^n P)$ , then  $J \subset \mathbb{O}(t^n P)$ ; in particular,  $J$  is bounded.*

*Proof.* Recall from §4.9 that every connected component  $I$  of  $\mathbf{Esc}_Q(\mathbf{F})$  is unbounded. Thus if  $I$  intersects  $\overline{\mathbb{O}(t^n P)}$ , then  $I \ni \alpha_{t^n P}$  (otherwise  $\partial\mathbb{O}(t^n P)$  encloses  $I$  by Corollary 5.15). By (5.5)  $I$  intersects  $\mathbb{O}(t^n P)$  for  $n \ll 0$ . Therefore,  $I$  contains all  $\alpha(t^m P)$  for  $m \geq n$ .

In the second claim,  $J$  is surrounded by  $\partial\mathbb{O}(t^n P)$ ; thus  $J \subset \mathbb{O}(t^n P)$ .  $\square$

**Corollary 5.17.** *The escaping set  $\mathbf{Esc}_Q(\mathbf{F})$  is connected. For every  $R > Q$ , every connected component of  $\mathbf{Esc}_R(\mathbf{F}) \setminus \mathbf{Esc}_Q(\mathbf{F})$  is bounded.*  $\square$

*Proof.* By Lemma 5.16, every two connected components contain  $\alpha(t^n P)$  for  $n \ll 0$ ; thus  $\mathbf{Esc}_Q(\mathbf{F})$  has a single connected component.

If  $J$  is a connected component of  $\mathbf{Esc}_R(\mathbf{F}) \setminus \mathbf{Esc}_Q(\mathbf{F})$ , then  $J$  intersects  $\mathbb{O}(t^n P)$  for  $n \ll 0$  but does not contain  $\alpha(t^n P)$  for  $n \ll 0$ ; thus  $J$  is bounded.  $\square$

Similarly to Lemma 5.12, we have:

**Lemma 5.18.** *Let  $\gamma: [0, 1) \rightarrow \mathbb{O}$  is a curve that goes to  $\infty$ . Let  $\{\gamma_i\}$  be the set of lifts of  $\gamma$  under  $\mathbf{F}^T$  with  $T \in \mathbb{T}_{>0}$ . Then every  $\gamma_i$  is contained in a unique  $\mathbb{O}_\iota(s)$  with  $\iota \in \{-, +\}$  and  $|s| = T$ . Moreover,  $\gamma_i$  lands at  $\alpha_s$ . Conversely, every  $\mathbb{O}_\iota(s)$  with  $|s| = T$  contains a unique  $\gamma_i$  which lands at  $\alpha_s$ .*

For  $R > T$  every connected component  $\mathbf{L}$  of  $\mathbf{Esc}_R(\mathbf{F}) \setminus \mathbf{Esc}_T(\mathbf{F})$  is contained in a unique  $\mathbb{O}_\iota(s)$  with  $\iota \in \{-, +\}$  and  $|s| = T$ . Moreover,  $\mathbf{L}$  is a lift of  $\mathbf{Esc}_{R-T}(\mathbf{F})$  under  $\mathbf{F}^T$  and  $\mathbf{L}$  is attached to  $\alpha_s$ :  $\mathbf{L} \cup \{\alpha_s\}$  is compact and connected. Conversely, for every  $\alpha_s$  with  $|s| = T$  there are two connected components of  $\mathbf{Esc}_R(\mathbf{F}) \setminus \mathbf{Esc}_T(\mathbf{F})$  attached to  $\alpha_s$ .

*Proof.* Every  $\gamma_i$  is contained in a unique lake which is of the form  $\mathbb{O}_\iota(s)$  by Lemma 5.8. By Lemma 5.11,  $\gamma_i$  lands at  $\alpha_s$ .

Similarly, connected components of  $\mathbf{Esc}_R(\mathbf{F}) \setminus \mathbf{Esc}_T(\mathbf{F})$  are in bijection with lifts of  $\mathbf{Esc}_{R-T}(\mathbf{F})$  under  $\mathbf{F}^T$  and are in certain  $\mathbb{O}_\iota(s)$  with  $|s| = T$ . By Lemma 5.11, every component of  $\mathbf{Esc}_R(\mathbf{F}) \setminus \mathbf{Esc}_T(\mathbf{F})$  is attached to a certain  $\alpha_s$  with  $|s| = T$ .  $\square$

**5.7. The tree-like structure of  $\mathbf{Esc}(\mathbf{F})$ .** For a finite or infinite sequences  $v = (P_1, P_2, \dots)$  and  $w = (Q_1, Q_2, \dots)$ , let

$$v \Delta w = (P_1, \dots, P_m)$$

be the largest common prefix of  $v$  and  $w$ ; i.e.  $P_i = Q_i$  for  $i \leq m$  but  $P_{m+1} \neq Q_{m+1}$ . If  $v = w$ , then  $v \Delta w = v = w$ .

Let us introduce two orders on the set  $\{\alpha_s\}_s$ . We write  $\alpha_v \succeq \alpha_w$  and  $\alpha_w = \alpha_v \wedge \alpha_s$  if  $\alpha_v \wedge \alpha_w$  if

$$\alpha_v \in \overline{\mathbb{O}_-(w) \cup \mathbb{O}_+(w)}.$$

We call “ $\succeq$ ” the *tree order*. If  $\alpha_s \in \mathbb{O}_-(w)$  and  $\alpha_v \in \mathbb{O}_+(w)$ , then we say that  $\alpha_s$  and  $\alpha_v$  are  *$\prec$ -separated* by  $\alpha_w$ ; in this case we write  $\alpha_w = \alpha_v \wedge \alpha_s$ .

Given a bubble  $\mathbf{Z}_s$  and two different points  $x, y \in \partial \mathbf{Z}_s$ , let us write by  $(x, y)_{\mathfrak{F}} \subset \mathbf{Z}_s$  the unique hyperbolic geodesic joining  $x$  and  $y$  (recall that  $\overline{\mathbf{Z}_s}$  is a closed topological disk by Lemma 5.11). Similarly, for  $x, y \in \partial \mathbf{Z}$ , the arc  $(x, y)_{\mathfrak{F}}$  is the hyperbolic geodesic of  $\mathbf{Z}$  connecting  $x$  and  $y$ . We also denote by  $(0, \infty)_{\mathfrak{F}}$  the hyperbolic geodesic of  $\mathbf{Z}$  connecting  $0$  and  $\infty$ .

Given a finite chain  $s = (P_1, P_2, \dots, P_n)$ , we define the *skeleton* of  $\mathbb{B}_s$  as

$$\mathfrak{T}_s := [0, c_{P_1}]_{\mathfrak{F}} \cup [c_{P_1}, c_{P_2}]_{\mathfrak{F}} \cup \dots \cup [c_{P_{n-1}}, c_{P_n}]_{\mathfrak{F}} \cup [c_{P_n}, \alpha_{P_n}]_{\mathfrak{F}}.$$

If  $s = (P_1, P_2, \dots)$  is an infinite sequence, then the *skeleton* of  $\mathbb{B}_s$  is

$$\mathfrak{T}_s := [0, c_{P_1}]_{\mathfrak{F}} \cup [c_{P_1}, c_{P_2}]_{\mathfrak{F}} \cup [c_{P_2}, c_{P_3}]_{\mathfrak{F}} \cup \dots$$

By construction, every two skeletons eventually separates:  $c_{v \Delta w}$  is the last point in  $\mathfrak{T}_v \cap \mathfrak{T}_w$  counting from  $0$ . Note also that the union of any number of skeletons is uniquely geodesic. Let us say that  $\mathfrak{T}_v$  is on the *left* of  $\mathfrak{T}_w$  and write  $\mathfrak{T}_v < \mathfrak{T}_w$ , if  $[0, \infty)_{\mathfrak{F}}, \mathfrak{T}_w, \mathfrak{T}_v$  have a counterclockwise orientation around  $\mathfrak{T}_w \cap \mathfrak{T}_v$ . We say that  $\mathfrak{T}_w$  and  $\mathfrak{T}_v$  are  *$<$ -separated* by  $\mathfrak{T}_s$  if either

$$\mathfrak{T}_v < \mathfrak{T}_s < \mathfrak{T}_w \quad \text{or} \quad \mathfrak{T}_v > \mathfrak{T}_s > \mathfrak{T}_w$$

holds.

For an infinite sequence  $s = (P_1, P_2, \dots)$ , we say that  $s(n) := (P_1, P_2, \dots, P_n)$  is the  *$n$ th truncation* of  $s$ . Clearly,  $\mathfrak{T}_v, \mathfrak{T}_w$  are  *$<$ -separated* by  $\mathfrak{T}_s$  if and only if  $\mathfrak{T}_v, \mathfrak{T}_w$  are  *$<$ -separated* by  $\mathfrak{T}_{s(n)}$  for all sufficiently big  $n$ .

We also define the order “ $<$ ” on alpha-points:  $\alpha_v < \alpha_w$  if and only if  $\mathfrak{T}_v < \mathfrak{T}_w$ . We call “ $<$ ” the *ambient order*.

**Lemma 5.19.** *Consider finite distinct skeletons  $\mathfrak{T}_v$  and  $\mathfrak{T}_w$ .*

- *If  $|v| = |w|$ , then there is a finite skeleton  $\mathfrak{T}_s$  with  $|s| < |v|$  such that  $\mathfrak{T}_v$  and  $\mathfrak{T}_w$  are  *$<$ -separated* by  $\mathfrak{T}_s$ .*

- If  $\mathfrak{T}_v$  and  $\mathfrak{T}_w$  are separated by a finite bubble chain of generation  $\leq \min\{|v|, |w|\}$ , then there is a unique finite skeleton  $\mathfrak{T}_s$  with the following properties. The skeletons  $\mathfrak{T}_v$  and  $\mathfrak{T}_w$  are  $\leftarrow$ -separated by  $\mathfrak{T}_s$  and  $|s| < \min\{|v|, |w|\}$ . If  $\mathfrak{T}_v$  and  $\mathfrak{T}_w$  are  $\leftarrow$ -separated by  $\mathfrak{T}_{s'}$ , then either  $|s'| > |s|$  or  $s' = s$ .

*Proof.* Suppose  $\mathfrak{T}_v$  is on the left of  $\mathfrak{T}_w$ . Recall that the infinite bubble chain  $\mathbb{B}_{\rho(v)}$  is the closest bubble chain on the right of  $\mathbb{B}_v$  of generation  $\leq |v|$ . Therefore,  $\mathfrak{T}_v$  and  $\mathfrak{T}_w$  are  $\leftarrow$ -separated by  $\mathfrak{T}_{\rho(v)}$ . For  $m \gg 0$ , let  $s$  be the  $m$ th truncation of  $\rho(v)$ . Then  $\mathfrak{T}_s$  separates  $\mathfrak{T}_v$  and  $\mathfrak{T}_w$  and  $|s| < |\rho(v)| < |v|$ .

For the second claim, set  $\tau \in \mathbb{R}_{\geq 0}$  be the infimum over all  $|x|$  such that  $\mathfrak{T}_x$  separates  $\mathfrak{T}_v$  and  $\mathfrak{T}_w$ .

Observe first that  $\tau < \min\{|v|, |w|\}$ . Indeed, let  $\mathfrak{T}_y$  be a skeleton separating  $\mathfrak{T}_v$  and  $\mathfrak{T}_w$  with  $|y| \leq \min\{|v|, |w|\}$ . Then  $|y| = \tau$  and  $y$  is finite (otherwise we can truncate  $y$  and construct a skeleton of smaller generation that still separates  $\mathfrak{T}_v$  and  $\mathfrak{T}_w$ ). This contradicts to the first claim: there is a finite skeleton of smaller generation between  $\mathfrak{T}_y$  and one of  $\mathfrak{T}_v, \mathfrak{T}_w$ .

We claim that  $\tau$  is realized by a finite sequence  $x$ . Then it would follow from the first claim that  $x$  is unique.

*Proof of the statement.* Let  $\bar{\mathbf{Z}}_{s(1)}, \bar{\mathbf{Z}}_{s(2)}, \dots, \bar{\mathbf{Z}}_{s(n)}$  be a finite sequence of neighboring closed bubbles from Lemma 5.14 connecting  $\mathbf{Z}_v = \mathbf{Z}_{s(1)}$  and  $\mathbf{Z}_w = \mathbf{Z}_{s(n)}$ . For every  $s(i)$  let  $\tau_i$  be the infimum over all  $|x|$  such that  $\mathfrak{T}_x$  separates  $\mathfrak{T}_v$  and  $\mathfrak{T}_w$  and either  $x \triangle v = s(i)$  or  $x \triangle w = s(i)$  holds. In other words, the infimum is taken over all  $\mathfrak{T}_x$  that coincide with one of  $\mathfrak{T}_v, \mathfrak{T}_w$  up to  $c_{s(i)}$  (if  $\mathbf{Z}_{s(i)} = \mathbf{Z}_\emptyset = \mathbf{Z}$ , then  $c_{s(i)} = 0$ ). Observe that  $\tau_1 \geq |v|$  and  $\tau_k \geq |w|$  because every skeleton associated with either  $\tau_1$  or  $\tau_2$  travels through either  $c_v$  or  $c_w$ . Therefore,  $\tau = \tau_k$  for some  $k \in \{2, \dots, n-1\}$ .

If  $\mathfrak{T}_v$  and  $\mathfrak{T}_w$  are  $\leftarrow$ -separated by  $\mathfrak{T}_{s(k)}$ , then  $|s(k)| = \tau_k$  and the claim follows. Otherwise, let  $J \subset \partial^c \mathbf{Z}_{s(k)}$  be an open arc between  $\bar{\mathbf{Z}}_{s(k-1)}$  and  $\bar{\mathbf{Z}}_{s(k+1)}$ . By construction, every skeleton associated with  $\tau_k$  travels through  $J$ . Since  $\bar{J}$  is disjoint from  $\alpha_{s(k)}$ , there is a unique point  $c_y$  of smallest generation in  $J$ . Therefore,  $\mathfrak{T}_y$  is a required skeleton.  $\square$

$\square$

**Proposition 5.20.** *Consider  $\alpha_w \neq \alpha_v$  with  $|v| \geq |w|$ . Then the following are equivalent:*

- (1)  $\alpha_v \succ \alpha_w$ ;
- (2)  $\alpha_v$  and  $\alpha_w$  are not  $\leftarrow$ -separated by  $\alpha_s$  with  $|s| < |v|$ ;
- (3)  $\alpha_v$  and  $\alpha_w$  are not  $\prec$ -separated.

*Proof.* Suppose that  $\alpha_v < \alpha_w$ ; the opposite case is symmetric.

We have  $\alpha_v \succ \alpha_w$  if and only if  $\alpha_v \in \mathcal{O}_-(w)$ . The latter is equivalent to the property that  $\mathfrak{T}_v$  and  $\mathfrak{T}_w$  are not  $\leftarrow$ -separated by  $\mathfrak{T}_{\lambda(w)}$  (where  $\mathbb{B}_{\lambda(w)}$  is defined in §5.3). For  $m \gg 1$ , let  $s$  be the  $m$ th truncation of  $\lambda(w)$ . Note that  $|s| < |\lambda(w)| = |w|$ . Then  $\mathfrak{T}_v$  and  $\mathfrak{T}_w$  are not  $\leftarrow$ -separated by  $\mathfrak{T}_{\lambda(w)}$  if and only if  $\mathfrak{T}_v$  and  $\mathfrak{T}_w$  are not separated by  $\mathfrak{T}_s$ . This proves the first claim.

Let us prove the second claim. If  $\alpha_v \succ \alpha_w$ , then clearly  $\alpha_v$  and  $\alpha_w$  are not  $\prec$ -separated. Suppose  $\alpha_v \not\succeq \alpha_w$ . By the first claim,  $\mathfrak{T}_v$  and  $\mathfrak{T}_w$  are  $\leftarrow$ -separated by a finite skeleton  $\mathfrak{T}_s$  with  $|s| < |w|$ . Using Lemma 5.19 we can assume that  $\mathfrak{T}_s$  has

the smallest possible generation. Therefore,  $\mathfrak{T}_v$  is between  $\mathfrak{T}_{\lambda(s)}$  and  $\mathfrak{T}_s$  while  $\mathfrak{T}_w$  is between  $\mathfrak{T}_{\rho(s)}$  and  $\mathfrak{T}_s$ . By definition,  $\alpha_v$  and  $\alpha_w$  are  $\prec$ -separated by  $\alpha_s$ .  $\square$

Suppose  $\alpha_v \succ \alpha_w$ . The *external chain*  $[\alpha_v, \alpha_w]$  is

$$\mathbf{Esc}_{|v|}(\mathbf{F}) \cap \overline{\mathbb{O}_-(w) \cup \mathbb{O}_+(w)} \setminus \bigcup_{\mathbb{O}_\iota(s) \not\prec \alpha_v} \mathbb{O}_\iota(s),$$

where the union is taken over all  $\iota \in \{-, +\}$  and all the sequences  $s$  satisfying  $\mathbb{O}_\iota(s) \not\prec \alpha_v$ . In other words,  $[\alpha_v, \alpha_w]$  is obtained from  $\mathbf{Esc}(\mathbf{F})$  by chopping off all the lateral decorations at alpha-points.

**Lemma 5.21.** *We have*

$$[\alpha_v, \alpha_s] = [\alpha_v, \alpha_w] \cup [\alpha_w, \alpha_s] \quad \text{and} \quad [\alpha_v, \alpha_w] \cap [\alpha_w, \alpha_s] = \{\alpha_w\}$$

for all  $\alpha_v \succ \alpha_w \succ \alpha_s$ , and

$$A_\star[\alpha_w, \alpha_v] = [\alpha_{tw}, \alpha_{tv}]$$

for all  $\alpha_v \succ \alpha_w$ .

*Proof.* Since  $\alpha_w$  is a cut point between  $\alpha_v$  and  $\alpha_w$  with respect to the tree order “ $\prec$ ,” we have  $[\alpha_v, \alpha_w] \cap [\alpha_w, \alpha_s] = \{\alpha_w\}$ . Recall from Lemma 5.18 that components of  $\mathbf{Esc}_P \setminus \mathbf{Esc}_{|v|}$  are attached to alpha-points of generation  $|s|$ , we also have

$$[\alpha_v, \alpha_w] = \mathbf{Esc}_P(\mathbf{F}) \cap \overline{\mathbb{O}_-(w) \cup \mathbb{O}_+(w)} \setminus \bigcup_{\mathbb{O}_\iota(s) \not\prec \alpha_v} \mathbb{O}_\iota(s)$$

for all  $P \geq |s|$  (because every component  $\mathbf{Esc}_P \setminus \mathbf{Esc}_{|v|}$  is deleted). As a consequence,  $[\alpha_v, \alpha_s] = [\alpha_v, \alpha_w] \cup [\alpha_w, \alpha_s]$ .

The second claim follows  $A_\star(\alpha_w) = \alpha_{tw}$  and  $A_\star(\alpha_v) = \alpha_{tv}$ , see Lemma 5.9.  $\square$

**5.8. External chains are arcs.** Recall that  $\mathbf{F}^P \mid \overline{\mathbf{Z}}$  is conjugate by  $\mathbf{h}$  to the cascade of translations  $(T^P)_{P \in \mathbb{T}}$ , see Lemma 5.2. By construction,  $\mathbf{h}(c_P) = b_P$ , where  $b_P$  are defined in §2.2. As in §2.2, we say that a critical point  $c_P$  is *dominant* if the arc  $[0, c_P]$  contains no critical point of generation less than  $P$ ; in this case  $\mathbf{Z}_P$  and  $\alpha_P$  are also called *dominant*.

Let  $c_P$  and  $c_Q$  be two dominant critical points and assume that  $P < Q$ . Then  $c_Q, 0 \in \partial \mathbf{Z}$  are on the same side of  $c_P$ .

As in §2.2, we enumerate dominant critical points as  $(c_{P_n})_{n \in \mathbb{Z}}$  with  $P_{n+1} > P_n$ . Suppressing indices, we write  $\alpha_i = \alpha_{P_i}$ ,  $c_i = c_{P_i}$ , and  $\mathbf{Z}_i = \mathbf{Z}_{P_i}$ .

**Lemma 5.22.** *We have*

$$\dots \succ \alpha_1 \succ \alpha_0 \succ \alpha_{-1} \succ \dots,$$

*Proof.* We claim that there is no  $\alpha_s$  separating  $\alpha_{i+1}$  and  $\alpha_i$  with respect to the ambient order “ $\prec$ ” such that the generation of  $\alpha_s$  is less than  $P_i$ . Write  $s = (R, \dots)$ . Since  $R < P_i$ , the chain  $\mathbb{B}_s$  does not go through  $\mathbf{Z}_i$  and  $\mathbf{Z}_{i+1}$ ; hence  $\mathbf{Z}_R$  is attached to  $(c_{i+1}, c_i)$ . This is impossible, because  $c_R$  is not counted as dominant. By Proposition 5.20,  $\alpha_{i+1} \succ \alpha_i$ .  $\square$

The *zero chain* (see Figure 26) is

$$(5.6) \quad \dots \cup [\alpha_1, \alpha_0] \cup [\alpha_0, \alpha_{-1}] \cup \dots$$

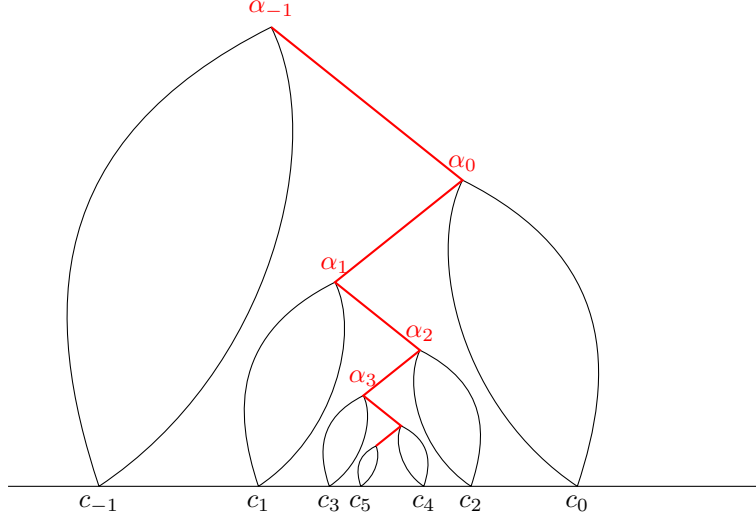

FIGURE 26. Fibonacci (golden mean rotation number) combinatorics: for every  $i$  the map  $\mathbf{F}^{P_{i+1}}$  maps  $[\alpha_i, \alpha_{i-1}]$  to  $[\alpha_{i+1}, \alpha_{i+3}]$ .

By definition,  $c_R$  is dominant if and only if  $A_*(c_R)$  is dominant. Therefore, there is a  $k > 0$  such that  $tP_i = P_{i+k}$  and (equivalently)  $A_*(\alpha_i) = \alpha_{i+k}$  for all  $i \in \mathbb{Z}$ . As a consequence,

$$(5.7) \quad A_*[\alpha_{tk}, \alpha_{(t-1)k}] = [\alpha_{(t+1)k}, \alpha_{tk}],$$

thus the  $[\alpha_{(t+1)k}, \alpha_{tk}]$  shrink to 0; i.e. 0 is the landing point of the zero chain.

**Lemma 5.23.** *For every  $[\alpha_i, \alpha_{i+1}]$  there is a  $Q \in \mathbb{T}_{>0}$  and  $[\alpha_n, \alpha_m]$  with  $i \geq m > n$  such that  $\mathbf{F}^Q$  maps  $[\alpha_i, \alpha_{i+1}]$  homeomorphically to  $[\alpha_n, \alpha_m]$ .*

*Proof.* Follows from Lemma 2.4, which provides the corresponding property for  $b_P = \mathbf{h}(c_P)$ .  $\square$

Given  $M \in \mathbb{R}_{>0}$ , we write  $\mathbf{Esc}_M(\mathbf{F}) = \bigcap_{T>M} \mathbf{Esc}_T(\mathbf{F})$ . Given  $x \in \mathbf{Esc}(\mathbf{F})$ , its *escaping time* is the minimal  $M$  such that  $\mathbf{Esc}_M(\mathbf{F}) \ni x$ .

**Corollary 5.24.** *The zero chain is an arc landing at 0. The points on this arc are parametrized by their escaping time ranging continuously from  $+\infty$  (for points close to 0) to 0. Alpha-points are dense on the zero chain.*

*Proof.* Consider  $I := [\alpha_{tk}, \alpha_{(t+1)k}]$ . Let us construct Markov partitions  $\mathfrak{T}_r$  of  $I$  for  $r \geq 0$ . For  $i \in \{tk, \dots, (t+1)k - 1\}$ , the chain  $I_i := [\alpha_i, \alpha_{i+1}]$  is an element of the partition  $\mathfrak{T}_0$  of level 0. By Lemma 5.23,  $\mathbf{F}^Q(I_i) = [\alpha_n, \alpha_m]$  for some  $Q > 0$  depending on  $i$ . For  $j \in \{n, n+1, m-1\}$  we say that the preimage of  $[\alpha_j, \alpha_{j+1}]$  under  $\mathbf{F}^Q: I_i \rightarrow [\alpha_n, \alpha_m]$  is an element of the partition  $\mathfrak{T}_1$  of level 1.

By construction, for every chain  $J$  of  $\mathfrak{T}_1$  there is a chain  $\tilde{J}$  of  $\mathfrak{T}_0$  and an expanding map

$$(5.8) \quad \chi_J = A_*^m \circ \mathbf{F}^Q: J \rightarrow \tilde{J} \quad \text{with } Q > 0, m \geq 0.$$

Elements of the partition  $\mathfrak{T}_{r+1}$  are the preimages of the elements in  $\mathfrak{T}_r$  under all possible  $\chi_J$ . Since  $\chi_J$  are expanding, the diameters of elements in  $\mathfrak{T}_r$  are bounded by  $C\lambda^{-r}$  for some  $C > 0$  and  $\lambda > 1$ .

We can enumerate chains in  $\mathfrak{T}_r$  as  $I_i^r$  with  $i \in \{1, \dots, a(r)\}$  such that  $I_i^r$  and  $I_j^r$  are disjoint if  $i > j + 1$  (see Lemma 5.21). Since the diameters of chains in  $\mathfrak{T}_r$  tends to 0, we obtain that  $I$  is an arc by a well-known characterization of arcs, see [Na, Theorems 6.16 and 6.17].

By construction,  $I_i^r$  are arcs connecting two alpha-points. Since  $I_i^r$  are small, alpha-points are dense in  $I$ .

For every  $I_i^r$  write  $\bar{\chi} = \chi_1 \circ \dots \circ \chi_r$  a composition of maps (5.8) mapping  $I_i^r$  to an element of  $\mathfrak{T}_0$ . Using (1.4) we write  $\bar{\chi} = A_\star^{m(r,i)} \circ \mathbf{F}^{Q(r,i)}$ . Observe that  $m(r,i) \rightarrow +\infty$  as  $r \rightarrow +\infty$  uniformly on  $i$ . (Indeed, since  $Q > 0$  in (5.8), there is a constant  $M \geq 0$  such that  $\bar{\chi}$  contains at most  $M$  consecutive  $\chi_j$  that does not contain the scaling  $A_\star$ .) Then

$$\mathbf{F}^{Q(r,i)}(I_i^r) \in A_\star^{-m(r,i)}[\alpha_{tk}, \alpha_{(t+1)k}],$$

and the difference in the escaping times between the endpoints of  $I_i^r$  is less than  $(|\alpha_{(t+1)k}| - |\alpha_{tk}|)/t^{m(r,i)}$ . This proves that the escaping time parameterizes continuously points on  $I$ .  $\square$

**Remark 5.25.** *In fact, the zero chain is a quasi-arc. In the proof of Corollary 5.24, we can extend  $\chi_J$  to a conformal map defined on a neighborhood of  $J$ . The Koebe distortion theorem implies that the distance between any pair of points  $x, y$  in  $I$  is comparable to the diameter of the subarc  $[x, y] \subset I$ . This is one of the characterizations of a quasi-arc.*

For every  $\alpha_s$  there is a sequence  $\alpha_s \succ \alpha_{v_1} \succ \alpha_{v_2} \succ \dots$  with  $|v_i|$  tending to 0. We define:

$$[\alpha_s, \infty) := [\alpha_s, \alpha_{v_1}] \cup [\alpha_{v_1}, \alpha_{v_2}] \cup [\alpha_{v_2}, \alpha_{v_3}] \cup \dots$$

**Proposition 5.26.** *The chain  $[\alpha_s, \infty)$  is a simple arc for every alpha-point  $\alpha_s$  with  $|s| > 0$ . Points in  $[\alpha_s, \infty)$  are parametrized by their escaping time ranging continuously from  $|s|$ , the escaping time of  $\alpha_s$ , to 0. Alpha-points are dense in  $[\alpha_s, \infty)$ .*

As a consequence,  $[\alpha_s, \alpha_v]$  is a simple arc for every  $\alpha_s \succ \alpha_v$ . We call both  $[\alpha_s, \alpha_v]$  and  $[\alpha_s, \infty)$  *external ray segments*.

*Proof.* Suppose first  $\alpha_s = \alpha_Q$ . Choose a dominant  $\alpha_P$  with  $P \geq Q$ . By Corollary 5.24,  $[\alpha_P, \infty)$  is a simple arc. Let  $x \in [\alpha_P, \infty)$  be the unique point of generation  $P - Q$ . Then  $\mathbf{F}^{P-Q}$  maps  $[\alpha_P, x)$  to  $[\alpha_Q, \infty)$ ; i.e.  $[\alpha_Q, \infty)$  is a simple arc.

Suppose now  $s = (Q_1, Q_2, \dots, Q_n)$ . Then  $(\infty, \alpha_s]$  is  $(\infty, \alpha_{Q_1}]$  followed by the lift of  $(\infty, \alpha_{Q_2}]$  under  $\mathbf{F}^{Q_1}$  connecting  $\alpha_{Q_1}$  and  $\alpha_{(Q_1, Q_2)}$ , followed by the lift of  $(\infty, \alpha_{Q_3}]$  under  $\mathbf{F}^{Q_1+Q_2}$  connecting  $\alpha_{(Q_1, Q_2)}$  and  $\alpha_{(Q_1, Q_2, Q_3)}$ , and so on. By Lemma 5.18,  $(\infty, \alpha_s]$  is a simple arc. The claims about the parameterization and alpha-points follow from Corollary 5.24.  $\square$

**5.9. External rays.** An external ray  $\mathbf{R}$  is a simple arc

$$\dots \cup [\alpha_{i+1}, \alpha_i] \cup [\alpha_i, \alpha_{i-1}] \cup \dots$$

subject to the condition

$$\cdots \succ \alpha_{i+1} \succ \alpha_i \succ \alpha_{i-1} \succ \cdots$$

such that

- the generation of  $\alpha_i$  tends to 0 as  $i$  tends  $+\infty$ , and
- there is no alpha-point  $\alpha'$  such that  $\alpha' \succ \alpha_i$  for all  $i \in \mathbb{Z}$ .

In other words, an external ray is a simple arc between  $\infty$  and an end of the escaping set. The *generation* of  $\mathbf{R}$  is  $\lim_{i \rightarrow -\infty} |\alpha_i| \in \mathbb{R}_{>0} \cup \{+\infty\}$ . We say that

- $\mathbf{R}$  has *type I* if the generation of  $\mathbf{R}$  is  $\infty$ ; and
- $\mathbf{R}$  has *type II* if the generation of  $\mathbf{R}$  is  $< \infty$ .

Given a ray  $\mathbf{R}$ , its *image* is

$$\mathbf{F}^P(\mathbf{R}) := \mathbf{F}^P(\mathbf{R} \cap \text{Dom } \mathbf{F}^P).$$

Note that  $\mathbf{R} \cap \text{Dom } \mathbf{F}^P$  is a subarc (possibly empty) of  $\mathbf{R}$  consisting of all the points with the escaping time in  $(P, +\infty)$ , see Proposition 5.26. If  $Q$  is the generation of  $\mathbf{R}$ , then the generation of  $\mathbf{F}^P(\mathbf{R})$  is  $Q - P$ . Thus  $\mathbf{F}^P(\mathbf{R})$  is empty if and only if  $P \geq Q$ .

The following is a corollary of Proposition 5.20:

**Corollary 5.27.** *Any two external rays  $\mathbf{R}_1 \neq \mathbf{R}_2$  meet at a unique  $\alpha_s$ ; i.e.  $\mathbf{R}_1 \cap \mathbf{R}_2 = [\alpha_s, \infty)$ .  $\square$*

A ray  $\mathbf{R}$  is *periodic* if  $\mathbf{F}^P(\mathbf{R}) = \mathbf{R}$  for some  $P > 0$ . In this case  $P$  is a *period* of  $\mathbf{R}$ . We will show in Corollary 5.35 that every periodic ray has a minimal period. Preperiodic rays are defined accordingly.

The zero chain (5.6) is a ray landing at 0; we will denote this ray as  $\mathbf{R}^* = \mathbf{R}^0$ . Writing  $\mathbf{I}_t = [\alpha_{tk}, \alpha_{(t-1)k}]$  in (5.7), we obtain the decomposition

$$(5.9) \quad \mathbf{R}^* = \cdots \cup \mathbf{I}_1 \cup \mathbf{I}_0 \cup \mathbf{I}_{-1} \cup \cdots$$

where

$$(5.10) \quad \mathbf{I}_i \subset \overline{\text{Esc}_{P^i} \setminus \text{Esc}_{P^{i-1}}(\mathbf{F})}, \quad P := |\alpha_0|$$

is an external ray segment satisfying

$$(5.11) \quad \mathbf{I}_i = A_x(\mathbf{I}_{i-1}).$$

**5.10. Wakes.** Since the zero ray  $\mathbf{R}^0$  lands at 0, for every critical point  $c_s$ , there are two preimages  $\mathbf{R}_{s,-}$  and  $\mathbf{R}_{s,+}$  of  $\mathbf{R}^0$  landing at  $c_s$ . We assume that  $\mathbf{R}_{s,-}$  is on the left of  $c_s$  and  $\mathbf{R}_{s,+}$  is on the right of  $c_s$  (relative the boundary of the bubble containing  $c_s$ ). Let  $\alpha_{s,-} \in \mathbf{R}_{s,-}$  and  $\alpha_{s,+} \in \mathbf{R}_{s,+}$  be two alpha-points on the rays close to  $c_s$ . Observe that  $\alpha_{s,+}$  and  $\alpha_{s,-}$  are  $\prec$ -separated by  $\alpha_s$ . We denote by  $\mathbf{R}'_{s,-}$  and  $\mathbf{R}'_{s,+}$  the closed subarcs of  $\mathbf{R}_{s,-}$  and  $\mathbf{R}_{s,+}$  between  $\alpha_s$  and  $c_s$ , see Figure 27. By Corollary 5.27,

$$(5.12) \quad \{c_s\} \cup \mathbf{R}'_{s,-} \cup \mathbf{R}'_{s,+} =: \partial \mathbf{W}_s$$

encloses the closed topological disk  $\mathbf{W}_s$  containing  $\mathbf{L}_s$ . We call  $\mathbf{W}_s$  the (closed) *wake* at  $c_s$ . We will show in Corollary 5.36 that  $\mathbf{W}_s = \overline{\mathbf{L}_s}$ . If  $s = (P_1, P_2, \dots, P_m)$ , then  $m$  is called the *level* of  $\mathbf{W}_s$ . We say that  $\alpha_s$  is the *top* point of  $\mathbf{W}_s$ . Wakes  $\mathbf{W}_P$  are called *primary*.

The dynamics of wakes follows the dynamics of their points:



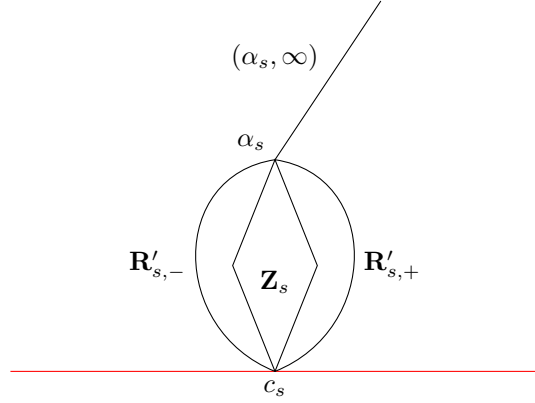

FIGURE 27. The wake  $\mathbf{W}_s$  is the closed topological disk containing  $\mathbf{Z}_s$  and enclosed by  $\overline{\mathbf{R}_{s,-} \cup \mathbf{R}_{s,+}}$ .

**Lemma 5.28.** *If  $\mathbf{F}^Q(c_v) = c_s$ , then  $\mathbf{F}^Q: \mathbf{W}_v \rightarrow \mathbf{W}_s$  is a homeomorphism. For every wake  $\mathbf{W}_s$ , we have a conformal map*

$$\mathbf{F}^{|\cdot|}: \text{int } \mathbf{W}_s \rightarrow \mathbb{C} \setminus \overline{\mathbf{R}^0}.$$

*Proof.* By construction,  $\mathbf{F}^Q$  maps  $\overline{\mathbf{R}_{v,-} \cup \mathbf{R}_{v,+}}$  homeomorphically to  $\overline{\mathbf{R}_{s,-} \cup \mathbf{R}_{s,+}}$ . Therefore,  $\mathbf{F}^Q: \mathbf{W}_v \rightarrow \mathbf{W}_s$  is a homeomorphism.

Since  $\mathbf{F}^{|\cdot|}$  maps each curve  $\mathbf{R}_{v,-}, \mathbf{R}_{v,+}$  homeomorphically to  $\mathbf{R}^0$ , we see that  $\mathbf{F}^{|\cdot|}: \text{int } \mathbf{W}_s \rightarrow \mathbb{C} \setminus \overline{\mathbf{R}^0}$  is conformal.  $\square$

As before, we write  $\mathbf{J}_n := \partial \mathbf{Z} \cap \mathbf{S}_n^\#$  and  $\mathbf{J} = \mathbf{J}_0$ .

**Lemma 5.29** (Primary wakes shrink). *For every  $n \in \mathbb{Z}$  and every  $\varepsilon > 0$  there are at most finitely many primary wakes  $\mathbf{W}_P$  with  $c_P \in \mathbf{J}_n$  such that the diameter of  $\mathbf{W}_P$  is greater than  $\varepsilon$ .*

*Proof.* It is sufficient to prove the statement for  $n = 0$ . Write

$$\mathbf{J}_- := \mathbf{J} \cap \mathbf{U}_- \quad \text{and} \quad \mathbf{J}_+ := \mathbf{J} \cap \mathbf{U}_+$$

(see (3.6)); then  $\mathbf{f}_\pm: \mathbf{J}_\pm \rightarrow \mathbf{J}$  realizes the first return of points in  $\mathbf{J}$  back to  $\mathbf{J}$ . Let  $\mathbf{W}_0$  be the primary wake of smallest generation touching  $\mathbf{J}$ . Then all other primary wakes touching  $\mathbf{J}$  are iterated lifts of  $\mathbf{W}_0$  under  $\mathbf{f}_\pm: \mathbf{J}_\pm \rightarrow \mathbf{J}$ ; we enumerate these wakes as  $(\mathbf{W}_i)_{i \leq 0}$  so that  $\mathbf{W}_{i-1}$  is a preimage of  $\mathbf{W}_i$  under  $\mathbf{f}_\pm$ . We will show that the diameter of  $\mathbf{W}_i$  tends to 0.

Let  $\mathcal{O}_\ell$  be the union of all the lakes whose generation is  $(0, 0, 1)$  and whose closure intersect  $\mathbf{J}_-$ . Similarly,  $\mathcal{O}_\rho$  is the union of all the lakes whose generation is  $(0, 1, 0)$  and whose closure intersect  $\mathbf{J}_+$ . If  $\mathbf{W}_0 = \mathbf{W}_P$  intersects  $\mathbf{J}_-$ , then  $\mathcal{O}_\ell = \mathcal{O}_+(P) \cup \mathcal{O}_i(P)$  because  $\mathbf{J}_-$  contains a unique critical point  $c_P$  of generation  $\leq P = (0, 0, 1)$ . On the other hand,  $\mathcal{O}_\rho$  consists of a single lake because  $\mathbf{J}_+$  does not contain a critical point of generation  $\leq P$ . If  $\mathbf{W}_0$  intersects  $\mathbf{J}_+$ , then  $\mathcal{O}_\rho$  consists of two lakes and  $\mathcal{O}_\ell$  consists of a single lake.

The maps

$$(5.13) \quad \mathbf{f}_-: \mathcal{O}_\ell \rightarrow \mathcal{O} = \mathbb{C} \setminus \overline{\mathbf{Z}} \quad \text{and} \quad \mathbf{f}_+: \mathcal{O}_\rho \rightarrow \mathcal{O} = \mathbb{C} \setminus \overline{\mathbf{Z}}$$

expand the hyperbolic metric of  $\mathcal{O}$ .

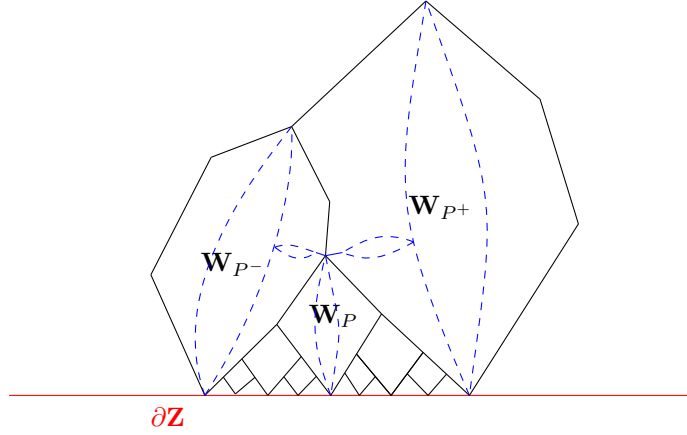

FIGURE 28. Combinatorics of primary wakes:  $\partial W_P \setminus \{c_P\}$  is covered by neighboring wakes. The bubble chains  $\mathbb{B}_{\lambda(P)}, \mathbb{B}_P = \mathbf{Z}_P, \mathbb{B}_{\rho(P)}$  landing at  $\alpha_P$  are marked blue dashed.

Let us denote by  $c_n$  the root of  $\mathbf{W}_n$ . Let  $y_0$  be an arbitrary point in  $\mathbb{O}$  and let  $\ell_0$  be a curve in  $\overline{\mathbb{O}}$  connecting  $c_0$  to  $y_0$  such that  $\ell_0 \setminus \{c_0\} \subset \mathbb{O}$ . For  $n \leq 0$ , denote by  $\ell_n$  the unique lift of  $\ell$  (by an appropriate  $\mathbf{F}^{P^n}$ ) starting at  $c_n$  and denote by  $y_n$  the endpoint of  $\ell_n$ .

*Claim.* There is a sequence  $\varepsilon_n > 0$  converging to 0 such that the following holds. If the diameter of  $\ell_0$  is less than  $\varepsilon_0$ , then the diameter of  $\ell_n$  is less than  $\varepsilon_n$ .

Since (5.13) are expanding, it follows from the Claim that  $\mathbf{W}_n$  shrink (because  $\mathbf{W}_0$  minus a small neighborhood of  $c_0$  is a compact subset of  $\mathbb{O}$ ).

*Proof of the Claim.* It is sufficient to verify the claim in the dynamical plane of the pacman  $f$ . Since Siegel maps with the same rotation number are conjugate in small neighborhoods of their Siegel disks (see §3.2.5), it is sufficient to prove the claim in the dynamical plane of the quadratic polynomial  $p$  that has a Siegel fixed point with the same rotation number as  $f$ .

Choose two points  $a, b \in \partial Z_p$  such that  $a$  is slightly on the left of  $c_0$  while  $b$  is slightly on the right of  $c_0$ . Let  $R_a$  and  $R_b$  be two external rays landing at  $a$  and  $b$ . Let  $X$  be an open topological disk bounded by  $\overline{Z}_p \cup R_a \cup R_b$  and truncated by some equipotential such that the boundary of  $X$  contains  $c_0$ . Let  $X_n$  be the unique lift of  $X$  under  $p^n$  such that  $\partial X_n$  contains  $c_n$  – the unique preimage of  $c_0$  under  $p^n$ :  $\partial Z_p \rightarrow \partial Z_p$ . Then  $X_n$  is bounded by  $p^{-n}(\overline{Z}_p)$ , two preimages  $R_{a,n}, R_{b,n}$  of  $R_a, R_b$ , and an equipotential. If  $n$  is big, then the difference between the external angles of  $R_{a,n}, R_{b,n}$  is small and the equipotential is close to the Julia set. Since the Julia set of  $p$  is locally connected [Pe], the diameter of  $X_n$  tends to 0.  $\square$

$\square$

**Lemma 5.30** (Combinatorics of primary wakes, Figure 28). *Consider a wake  $\mathbf{W}_P$ . Write*

$$\lambda(P) = (P^-, \dots) \quad \text{and} \quad \rho(P) = (P^+, \dots).$$

*Then  $\mathbf{W}_P, \mathbf{W}_{P^-}, \mathbf{W}_{P^+}$  are all the primary wakes containing  $\alpha_P$  on the boundary.*

As in (5.12), write  $\partial\mathbf{W}_P = \{c_P\} \cup \mathbf{R}'_{P,-} \cup \mathbf{R}'_{P,+}$ . Then  $\mathbf{R}'_{P,-}$  splits as a concatenation

$$\mathbf{R}'_{P,-} = [\alpha_P, \alpha_{Q_1}] \cup [\alpha_{Q_1}, \alpha_{Q_2}] \cup \dots$$

such that

- $[\alpha_P, \alpha_{Q_1}] = \mathbf{W}_{P^-} \cap \mathbf{W}_P$ ;
- $[\alpha_{Q_i}, \alpha_{Q_{i+1}}] = \mathbf{W}_{Q_i} \cap \mathbf{W}_P$  for  $i \geq 1$ ;
- $Q_{i+1}^- = Q_i$ ,  $Q_1^- = P^-$ , and  $Q_i^+ = P$ ;
- $\alpha_{Q_i}$  tends to  $c_P$ .

Similarly,  $\mathbf{R}'_{P,+}$  splits as a concatenation

$$\mathbf{R}'_{P,+} = [\alpha_P, \alpha_{S_1}] \cup [\alpha_{S_1}, \alpha_{S_2}] \cup \dots$$

such that

- $[\alpha_P, \alpha_{S_1}] = \mathbf{W}_{P^+} \cap \mathbf{W}_P$ ;
- $[\alpha_{S_i}, \alpha_{S_{i+1}}] = \mathbf{W}_{S_i} \cap \mathbf{W}_P$  for  $i \geq 1$ ;
- $S_{i+1}^+ = S_i$ ,  $S_1^+ = P^+$ , and  $S_i^- = P$ ;
- $\alpha_{S_i}$  tends to  $c_P$ .

*Proof.* Recall that  $\alpha_P$  is the landing point of  $\mathbb{B}_P = \widehat{\mathbf{Z}}_P, \mathbb{B}_{\lambda(P)}, \mathbb{B}_{\rho(P)}$ , see Lemma 5.11. Since  $\mathbb{B}_{\lambda(P)}, \mathbb{B}_{\rho(P)}$  are in wakes  $\mathbf{W}_{P^-}, \mathbf{W}_{P^+}$ , the first claim follows.

We will verify the decomposition of  $\mathbf{R}'_{P,-}$ ; the decomposition of  $\mathbf{R}'_{P,+}$  can be verified similarly. It follows from Corollary 5.27 that the intersection  $\mathbf{W}_{P^-} \cap \mathbf{W}_P$  is an arc of the form  $[\alpha_v, \alpha_P]$  with  $\alpha_v \succ \alpha_P$ . Observe that all three bubble chains landing at  $\alpha_v$  (see Lemma 5.11) belong to different prime wakes because  $\alpha_v$  is a point where  $\partial\mathbf{W}_P$  and  $\partial\mathbf{W}_{P^-}$  split. This implies that  $\alpha_v = \alpha_{Q_1}$  for some  $Q_1 \in \mathbb{T}_{>0}$ ; by the first claim,  $Q_1^- = P^-$ , and  $Q_1^+ = P$ .

Similarly, the intersection  $\mathbf{W}_{Q_1} \cap \mathbf{W}_P$  is of the form  $[\alpha_{Q_1}, \alpha_{Q_2}]$ , where  $Q_2^- = Q_1$ , and  $Q_2^+ = P$ . Applying induction, we construct  $Q_i$  for all  $i \geq 1$ . It remains to show that  $\alpha_{Q_i}$  converges to  $c_P$ .

By Proposition 5.26, there is an alpha-point  $\alpha_s \in \mathbf{R}'_{P,-}$  close to  $c_P$ . At least one of the rays  $\mathbb{B}_s, \mathbb{B}_{\lambda(s)}, \mathbb{B}_{\rho(s)}$  is not in  $\mathbf{W}_P$ ; thus  $\alpha_s$  is on the boundary of a primary wake  $\mathbf{W}_T \neq \mathbf{W}_P$ . As above, the intersection  $\mathbf{W}_T \cap \mathbf{W}_P$  is of the form  $[\alpha_T, \alpha_{T_2}]$ , where  $T_2^- = T$ .

Since there are at most finitely many critical points in  $[c_T, c_{P^-}]$  (a subarc of  $\partial\mathbf{Z}$ ) of generation less than  $T$ , the arc  $[\alpha_T, \alpha_P]$  intersects only finitely many primary wakes. This means that  $T = Q_i$  for some  $i \geq 1$ . Since  $c_s$  can be chosen arbitrary close to  $c_P$ ,  $\alpha_{Q_i}$  converges to  $c_P$ .  $\square$

**Corollary 5.31** (Tiling). *The union of primary wakes  $\bigcup_{P>0} \mathbf{W}_P$  contains  $\mathbb{O}$ . Similarly, for every wake  $\mathbf{W}_s$  with  $s = (P_1, \dots, P_n)$  we have*

$$(5.14) \quad \mathbf{W}_s = \overline{\mathbf{Z}}_s \cup \bigcup_{P_{n+1}>0} \mathbf{W}_{(P_1, \dots, P_n, P_{n+1})}.$$

*For every  $z \in \mathbf{Esc}(\mathbf{F})$  and every  $m \geq 1$  there are at most three wakes with disjoint interiors of level  $\geq m$  containing  $z$ . The union of these wakes is a neighborhood of  $z$ .*

*Proof.* There is a pair of primary wakes  $\mathbf{W}_P$  and  $\mathbf{W}_Q$  such that  $\mathbf{W}_P \cup \mathbf{W}_Q \cup \bar{\mathbf{Z}}$  surrounds an open topological disk  $X$  with  $0 \in \partial X$ . Then for every  $y \in \mathbb{O}$ , there is an  $n \ll 0$  such that  $A_\star^n(\mathbf{W}_P \cup \mathbf{W}_Q \cup \bar{\mathbf{Z}})$  encloses  $y$ .

By Lemma 5.30, if  $y \notin \bar{\mathbf{Z}}$  is not contained in any prime wake, then there is connected set  $Y \ni y$  (a “ghost limb”) such that  $Y \subset \mathbb{O} \setminus \bigcup_P \mathbf{W}_P$  and  $\bar{Y}$  intersects

$\partial \mathbf{Z}$ , say at  $x$ . We can choose sequences  $\mathbf{W}_{P_i}$  and  $\mathbf{W}_{Q_i}$  such that  $\mathbf{W}_{P_i} \cup \mathbf{W}_{Q_i} \cup \bar{\mathbf{Z}}$  encloses  $Y$  and  $c_{P_i}, c_{Q_i}$  tend to  $x$ . By Lemma 5.29, the diameters of  $\mathbf{W}_{P_i}$  and  $\mathbf{W}_{Q_i}$  tend to 0. This is a contradiction.

By construction,

$$(5.15) \quad \mathbf{F}^{|\mathbf{s}|}: \text{int}(\mathbf{W}_s) \rightarrow \mathbb{C} \setminus \bar{\mathbf{R}}^0$$

is conformal. Then (5.14) follows from the first claim by applying the inverse of (5.15).  $\square$

**Corollary 5.32.** *For every  $\varepsilon > 0$  there is a  $P \in \mathbb{T}_{>0}$  such that every connected component of*

$$(5.16) \quad \mathbb{C} \setminus \left( \bar{\mathbf{Z}}_\star \cup \bigcup_{S \leq P} \mathbf{W}_S \right)$$

*is less than  $\varepsilon$  in the spherical metric.*

*Proof.* Follows from Lemmas 5.29 and 5.30.  $\square$

**5.11. Rigidity of the escaping set.** For an open topological disk  $U$ , we denote by  $\text{diam}_U$  and  $\text{dist}_U$  the diameter and distance with respect to the hyperbolic metric of  $U$ .

**Lemma 5.33.** *For every primary wake  $\mathbf{W}_P$  the following holds. The map*

$$(5.17) \quad \mathbf{F}^P: \mathbf{W}_P \setminus \bar{\mathbf{Z}}_P \rightarrow \mathbb{O}$$

*is uniformly expanding with respect to the hyperbolic metric of  $\mathbb{O}$ . There is a  $C > 0$  such that  $\text{diam}_{\mathbb{O}}(\mathbf{W}_{(P,Q)}) \leq C$  for every secondary subwake  $\mathbf{W}_{(P,Q)}$  of  $\mathbf{W}_P$ .*

*Proof.* Since  $\partial \mathbf{W}_P \cap \partial \mathbb{O} = \{c_P\}$ , the map (5.17) is uniformly expanding away from a neighborhood of  $c_P$ . We will prove that (5.17) is also uniformly expanding in a small neighborhood of  $c_P$ . In fact, we will show that the expansion rate of (5.17) tends to  $\infty$  as the neighborhood shrinks to  $c_P$ .

The wake  $\mathbf{W}_P$  is self-similar near its root  $c_P$ , and the global self-similarity  $A_\star$  can be lifted to a local self-similarity near  $c_P$  as follows. Let  $U \ni A_\star(U)$  be a small open disk around 0 such that 0 is the only critical value of  $\mathbf{F}^P$  in  $U$ . Let  $V \ni c_P$  be the lift of  $U$  along  $\mathbf{F}^P: c_P \mapsto 0$ . Then  $A_\star|_U$  lifts to a conformal map  $\psi$  defined on  $V$ . By construction,  $c_P$  is an attracting fixed point of  $\psi$ . Let  $L: (V, c_P) \rightarrow (\mathbb{C}, 0)$  with  $L'(c_P) = 1$  be the linearizer conjugating  $\psi$  to the scaling  $A_\nu$ . (We note that  $\nu^2 = \mu_\star$  because  $\mathbf{F}^P$  is 2-to-1 near  $c_P$ .)

Consider

$$(5.18) \quad L(\mathbf{W}_P), \quad L(\mathbf{Z}), \quad L(\mathbf{Z}_P), \quad L(\mathbb{O});$$

these objects are forward invariant under  $A_\nu$ . Using backward iterates of  $A_\nu$ , we globalize (5.18); we denote the result by

$$\mathbf{W}_P^\circ, \quad \mathbf{Z}^\circ, \quad \mathbf{Z}_P^\circ, \quad \mathbb{O}^\circ;$$

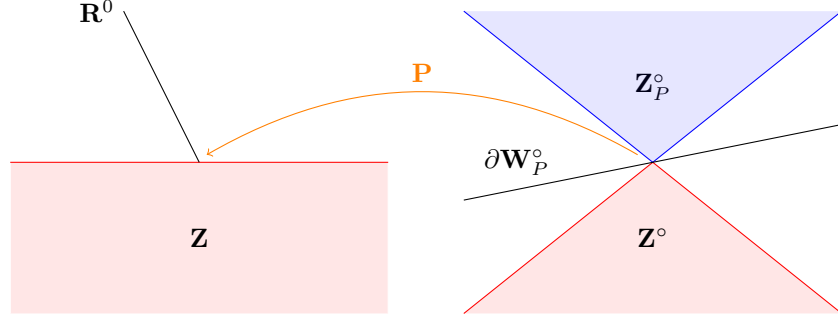

FIGURE 29.  $\mathbf{Z}^\circ, \mathbf{Z}_P^\circ$  are the preimages of  $\mathbf{Z}$  under  $\mathbf{P}$ . Note that  $\mathbb{O} = \mathbb{C} \setminus \overline{\mathbf{Z}}$  and  $\mathbb{O}^\circ = \mathbb{C} \setminus \overline{\mathbf{Z}^\circ}$ .

these new objects are completely invariant under  $A_\nu$ . We also write  $\mathbf{W}_{(P,Q)}^\circ := L(\mathbf{W}_{(P,Q)})$ ; this is a secondary wake of  $\mathbf{W}_P^\circ$ .

Observe that the scaling  $A_\nu$  is a global 2-to-1 lift of  $A_\star$ , because  $\psi$  is a local 2-to-1 lift of  $A_\star$ . Since a global 2-to-1 map is a quadratic polynomial,  $A_\nu$  is a lift of  $A_\star$  under  $\mathbf{P}: z \rightarrow az^2$  with  $a \neq 0$ . We have (see Figure 29):

- $\mathbf{Z}^\circ$  and  $\mathbf{Z}_P^\circ$  are the components of  $\mathbf{P}^{-1}(\mathbf{Z})$ ;
- $\mathbb{O}^\circ = \mathbb{C} \setminus \overline{\mathbf{Z}^\circ}$ ;
- $\mathbf{P}: \text{int}(\mathbf{W}_P^\circ) \rightarrow \mathbb{C} \setminus \overline{\mathbf{R}^0}$  is conformal, and  $\mathbf{P}$  projects  $\partial\mathbf{W}_P$  to  $\overline{\mathbf{R}^0}$ .

For an open topological disk  $U$ , we denote by  $\mu_U$  the hyperbolic metric of  $U$ . We also denote by  $\mu_U(z)$  the density of  $\mu_U$  at  $z$  with respect to the Euclidean metric. We recall that  $\mu_U(z) \asymp 1/\text{dist}(z, \partial U)$ , where “dist” denotes the Euclidean distance.

Observe also that if a secondary wake  $\mathbf{W}_{(P,S)}$  is close to  $c_P$ , then  $\mathbf{W}_{(P,S)}$  is contained in a small neighborhood of  $c_P$ . Indeed,  $\mathbf{F}^P(\mathbf{W}_{(P,S)})$  is close to 0, thus  $\mathbf{F}^P(\mathbf{W}_{(P,S)})$  is small by Lemma 5.29. Therefore, the second claim of the lemma is obvious unless  $\mathbf{W}_{(P,S)}$  is contained in a small neighborhood of  $c_P$ . Since  $\psi: (\mathbb{O}^\circ, \mu_{\mathbb{O}^\circ}) \rightarrow (\mathbb{O}, \mu_{\mathbb{O}})$  is close to an isometry near  $c_P$ , the lemma follows from the following two statements:

- (1)  $\mathbf{P}: (\mathbf{W}_P^\circ \setminus \overline{\mathbf{Z}_P^\circ}, \mu_{\mathbb{O}^\circ}) \rightarrow (\mathbb{O}, \mu_{\mathbb{O}})$  is uniformly expanding near 0; and
- (2)  $\text{diam}_{\mathbb{O}^\circ}(\mathbf{W}_{(P,Q)}^\circ) \leq C$  for every secondary subwake  $\mathbf{W}_{(P,Q)}^\circ$  of  $\mathbf{W}_P^\circ$ .

*Proof of (1) and (2).* Let  $X$  be the closed annulus between the circles with radii  $\nu$  and 1. Since  $X \cap \mathbf{W}_P^\circ$  is compact and disjoint from  $\partial\mathbf{Z}^\circ$ , for every  $z \in X \cap \mathbf{W}_P^\circ$  we have  $|z| = \text{dist}(z, 0) \asymp \text{dist}(z, \partial\mathbf{Z}^\circ)$ . Since  $X$  is a fundamental domain for  $A_\nu$ , we have  $\mu_{\mathbb{O}^\circ}(z) \asymp 1/|z|$  for all  $z \in \mathbf{W}_P^\circ$ . We obtain:

$$\mu_{\mathbb{O}}(\mathbf{P}(z)) \geq 1/|\mathbf{P}(z)| \asymp 1/|z|^2 \asymp (\mu_{\mathbb{O}^\circ}(z))^2.$$

This confirms Claim (1) with the expansion rate  $\asymp \frac{1}{|z|}$ .

Since  $A_\nu | (\mathbb{O}^\circ, \mu_{\mathbb{O}^\circ})$  is an isometry, we can assume that the root of  $\mathbf{W}_{(P,Q)}^\circ$  is contained in  $X$ . Since all the secondary wakes with root in  $X$  are disjoint from a small neighborhood of 0 and are contained in a bounded set (because if  $\mathbf{W}_{(P,Q)}^\circ$  is close to 0, then  $\mathbf{W}_{(P,Q)}^\circ$  is contained in a small neighborhood of 0), we obtain Claim 2.  $\square$

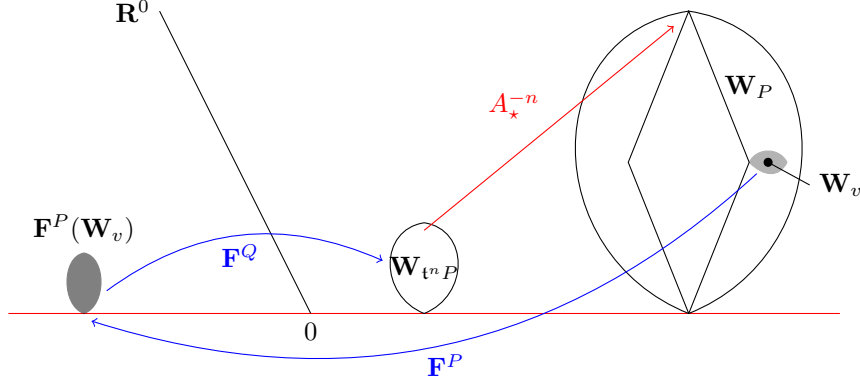

FIGURE 30. Construction of the first scaled return  $\chi := A_*^{-n} \circ \mathbf{F}^{P+Q}: \mathbf{W}_v \rightarrow \mathbf{W}_P$ .

□

**Lemma 5.34** (Nested wakes shrink). *For an infinite sequence  $(P_1, P_2, \dots)$  write  $s(n) := (P_1, \dots, P_n)$ . Then*

$$\bigcap_{n \geq 1} \mathbf{W}_{s(n)}$$

*is a singleton*

*Proof.* For a secondary wake  $\mathbf{W}_v \subset \mathbf{W}_P$ , we define its *first scaled return*

$$\chi := A_*^{-n} \circ \mathbf{F}^{P+Q}: \mathbf{W}_v \rightarrow \mathbf{W}_P$$

as follows, see Figure 30. The map  $\mathbf{F}^P: \text{int}(\mathbf{W}_P) \rightarrow \mathbb{C} \setminus \overline{\mathbf{R}^0}$  is univalent and  $\mathbf{F}^P(\mathbf{W}_v)$  is a primary wake. Let  $Q \in \mathbb{T}$  be the minimal such that  $\mathbf{F}^{P+Q}(\mathbf{W}_v) = \mathbf{W}_{t^n P}$  for some  $n \in \mathbb{Z}$ . Then  $A_*^{-n} \circ \mathbf{F}^{P+Q}(\mathbf{W}_v) = \mathbf{W}_P$ . By Lemma 5.17,  $\chi = \mathbf{F}^{P+Q}$  is expanding uniformly over all the secondary subwakes of  $\mathbf{W}_P$ .

The first scaled return  $\chi$  is defined for all  $x \in \mathbf{W}_P \setminus \mathbf{Z}_P$  (with a natural interpretation of the ambiguity at common boundary point of secondary wakes). By Lemma 5.17,

$$\text{diam}_0 \chi^{k-2}(\mathbf{W}_{s(k)}) \leq C.$$

Since  $\chi$  is uniformly expanding, we obtain that  $\text{diam}_0(\mathbf{W}_{s(k)})$  tends to 0. □

**Corollary 5.35.** *Every external ray lands. Every periodic external ray has a minimal period.*

*Proof.* Observe that the accumulating set  $Y$  of a ray does not transversally intersect the boundaries of wakes: either  $Y \subset \mathbf{W}_s$  or  $Y \subset \overline{\mathbb{C}} \setminus \mathbf{W}_s$  for every wake  $\mathbf{W}_s$ . If  $Y$  intersects  $\partial \mathbf{Z}_s$  for some  $s$ , then  $Y \subset \partial \mathbf{Z}_s$  by Corollary 5.31. Since the roots of wakes (i.e. critical points) are dense on  $\partial \mathbf{Z}_s$ , we obtain that  $Y$  is a singleton. If  $Y$  does not intersect any  $\partial \mathbf{Z}_s$ , then  $Y$  belongs to a nested sequence of closed wakes (by Corollary 5.31). By Lemma 5.34,  $Y$  is a singleton.

If  $\mathbf{R}$  is a periodic ray, then  $\mathbf{R}$  lands, say at  $x$ . By Corollary 4.6,  $x$  has a minimal period  $P \in \mathbb{T}_{>0}$ . Therefore,  $\mathbf{R}$  has a minimal period  $mP$  for some  $m \geq 1$ . □

Lemma 5.34 implies that a limb is dense in the corresponding wake:

**Corollary 5.36.** *We have  $\mathbf{W}_s = \overline{\mathbf{L}}_s$  for every  $s$ .*  $\square$

Two points  $x, y \in \mathbf{Esc}_P(\mathbf{F})$  are *combinatorially equivalent* if there is no alpha-point  $\alpha_s$  such that  $x, y$  are in different connected components of  $\mathbf{Esc}_P(\mathbf{F}) \setminus \{\alpha_s\}$ . A point  $x \in \mathbf{Esc}(\mathbf{F})$  is an *endpoint* of  $\mathbf{Esc}(\mathbf{F})$  if  $x \notin [\alpha_1, \alpha_2]$  for alpha-points  $\alpha_1 \succ \alpha_2$ .

**Proposition 5.37.** *Every combinatorial class of  $\mathbf{Esc}(\mathbf{F})$  is a singleton. For every  $M \in \mathbb{R}_{>0}$  we have*

$$(5.19) \quad \mathbf{Esc}_M(\mathbf{F}) = \overline{\bigcup_{P < M} \mathbf{Esc}_P(\mathbf{F})}.$$

For every  $P \in \mathbb{T}_{>0}$  the escaping set  $\mathbf{Esc}_P(\mathbf{F})$  is uniquely geodesic.

*Proof.* Consider  $x \in \mathbf{Esc}_P(\mathbf{F})$ . If  $x$  is not an endpoint of  $\mathbf{Esc}(\mathbf{F})$ , then Proposition 5.26 implies that  $x$  can be separated by alpha-point from any other point in the escaping set.

Suppose  $x$  is an endpoint of  $\mathbf{Esc}(\mathbf{F})$ . By Corollary 5.31,  $x$  belongs to a nested sequence of wakes. By Lemma 5.34, the combinatorial class of  $x$  is a singleton. Moreover, the external ray  $(x, \infty)$  lands at  $x$ ; i.e.  $\mathbf{Esc}_P$  is uniquely geodesic.

Equation (5.19) is immediate.  $\square$

**Corollary 5.38.** *Suppose  $X \subset \mathbf{Esc}_P(\mathbf{F})$  is a discrete subset of  $\mathbb{C}$ . Then the connected hull of  $X$*

$$\bigcup_{x, y \in X} [x, y]$$

*is a tree.*

*Proof.* Since  $\mathbf{Esc}_P(\mathbf{F})$  is uniquely geodesic, the intersection of  $\bigcup_{x, y \in X} [x, y]$  with any proper lake is a finite tree. Since lakes exhaust  $\mathbb{O}$  (see for example (5.5)), the claim follows.  $\square$

**Lemma 5.39.** *The escaping set  $\mathbf{Esc}(\mathbf{F})$  has empty interior and supports no invariant line field. Every Fatou component of  $\mathbf{F}$  is either  $\mathbf{Z}$  or its iterated preimage.*

Such a statement is referred to the Hairiness Theorem.

*Proof.* We give the sketch of the proof because the argument are standard.

Since every combinatorial class of  $\mathbf{Esc}(\mathbf{F})$  is trivial (Proposition 5.37), we have  $\text{int}(\mathbf{Esc}(\mathbf{F})) = \emptyset$ .

Suppose  $X$  is a Fatou component of  $\mathbf{F}$  such that  $X$  is not an iterated preimage of  $\mathbf{Z}$ . By Corollary 5.31,  $X$  belongs to a nested sequence of wakes; the wakes shrink to a point by Lemma 5.34. This is a contradiction.

Suppose  $\mathbf{Esc}(\mathbf{F})$  supports an invariant line field  $L$ . There are two cases. If the integration along  $L$  as in §4.10 gives a non-trivial continuous path  $\mathbf{G}_t$  emerging from  $\mathbf{F} = \mathbf{F}_*$ , then  $\mathbf{G}_t$  is a path in  $\mathcal{W}^u$  contradicting the rigidity of  $\mathbf{F}$ .

In the second case, we would obtain a non-trivial qc map  $h: \mathbb{C} \rightarrow \mathbb{C}$  commuting with  $\mathbf{F}$ . Since  $h$  is identity on  $\overline{\mathbf{Z}}$ , we obtain that  $h$  is identity on all  $\mathbf{Z}_s$  which are dense. This implies that  $h$  is identity everywhere.  $\square$

**Lemma 5.40.** *The closure of the escaping set  $\mathbf{Esc}_P(\mathbf{F}) \cup \{\infty\} \subset \widehat{\mathbb{C}}$  is locally connected for all  $P \in \mathbb{T}_{>0}$ .*

*Proof.* Local connectivity of  $\mathbf{Esc}_P(\mathbf{F})$  at any its point  $z$  follows from Lemma 5.34. Indeed, if  $\bigcup_i \mathbf{W}_i$  is a neighborhood of  $z$  consisting of at most 3 pairwise non-nested

wakes of level  $\geq m$  (see Corollary 5.31), then  $\left(\bigcup_i \mathbf{W}_i\right) \cap \mathbf{Esc}_P(\mathbf{F})$  is a neighborhood of  $z$  in  $\mathbf{Esc}_P(\mathbf{F})$ . By Lemma 5.34,  $\bigcup_i \mathbf{W}_i$  shrinks as  $m$  increases.

Recall that there are nested lakes  $\mathbb{O}(P) \subset \mathbb{O}(t^{-1}P) \subset \dots$  such that  $\mathbb{C} = \bigcup_{n \leq 0} \mathbb{O}(t^n P)$ , see (5.5). Then  $(\mathbf{Esc}_P(\mathbf{F}) \cup \{\infty\}) \setminus \mathbb{O}(t^n P)$  is a small neighborhood of  $\infty$ .  $\square$

## 6. HOLOMORPHIC MOTION OF THE ESCAPING SET

Consider a maximal prepacman  $\mathbf{F} \in \mathcal{W}^u$ . Recall that the escaping set  $\mathbf{Esc}_S(\mathbf{F}) = \mathbb{C} \setminus \mathbf{Esc}_S(\mathbf{F})$  is defined for  $S \in \mathbb{T} \subset \mathbb{R}_{\geq 0}$ . For  $M \in \mathbb{R}_{\geq 0}$  we define

$$\mathbf{Esc}_M(\mathbf{F}) := \bigcap_{S \geq M} \mathbf{Esc}_S(\mathbf{F}),$$

where the intersection is taken over all  $S \in \mathbb{T}$  with  $S \geq M$ . For  $x \in \mathbf{Esc}(\mathbf{F})$  its *escaping time* is the minimal  $M$  such that  $\mathbf{Esc}_M(\mathbf{F}) \ni x$ .

**6.1. Stability of  $\sigma$ -branched structure.** We need the following approximation of  $\mathbf{F}$  by finite degree branched coverings.

**Lemma 6.1.** *There is a neighborhood  $\mathcal{U} \subset \mathcal{W}^u$  of  $\mathbf{F}_*$  such that for every  $\mathbf{F} \in \mathcal{U}$  there are sequences  $\mathbf{D}^{(-1)} \subset \mathbf{D}^{(-2)} \subset \dots$  and  $\mathbf{W}_{\pm}^{(-1)} \subset \mathbf{W}_{\pm}^{(-2)} \subset \dots$  with  $\bigcup_{k < 0} \mathbf{D}^{(k)} = \mathbb{C}$  and  $\bigcup_{k < 0} \mathbf{W}_{\pm}^{(k)} = \text{Dom } \mathbf{f}_{\pm}$  such that*

$$(6.1) \quad (\mathbf{f}_{0,-}, \mathbf{f}_{0,+}): \mathbf{W}_{-}^{(k)} \cup \mathbf{W}_{+}^{(k)} \rightarrow \mathbf{D}^{(k)}$$

are proper branched coverings of finite degree depending continuously on  $\mathbf{F}$  when  $k$  is fixed. Moreover, all maps (6.1) are Hurwitz equivalent for a fixed  $k$ .

It follows, in particular, that the degree of  $\mathbf{f}_{0,\pm} | \mathbf{W}_{\pm}^{(k)}$  is constant and critical points of  $\mathbf{f}_{0,\pm}$  do not collide.

*Proof.* The proof follows the lines of [DLS, Theorem 5.5] asserting that a pacman on the unstable manifold extends to a maximal prepacman. Let us first review the proof of [DLS, Theorem 5.5]; see also §3.2.9.

For a pacman  $f_0 \in \mathcal{W}^u$ , let

$$\mathfrak{F}_0 = (f_{0,\pm}: \mathfrak{U}_{0,\pm} \rightarrow \mathfrak{S} := V \setminus (\gamma_1 \cup O))$$

be a commuting pair obtained from  $F_0 = (f_{0,\pm}: U_{0,\pm} \rightarrow V \setminus \gamma_1)$  by removing a small neighborhood  $O$  of  $\alpha$  from  $V \setminus \gamma_1$  and by removing  $f_{0,\pm}^{-1}(O)$  from  $U_{0,\pm}$ . The map  $\phi_k \circ \dots \circ \phi_{-1}$  embeds  $\mathfrak{F}_0$  to the dynamical plane of  $f_k$  as a commuting pair denoted by

$$(6.2) \quad \mathfrak{F}_0^{(k)} = \left( f_k^{\mathbf{a}_k}, f_k^{\mathbf{b}_k} \right): \mathfrak{U}_{0,-}^{(k)}, \mathfrak{U}_{0,+}^{(k)} \rightarrow \mathfrak{S}_0^{(k)}.$$



Since  $\phi_k$  is contracting at the critical value the diameter of  $U_{0,-}^{(k)} \cup U_{0,+}^{(k)} \cup \mathfrak{S}_0^{(k)} \ni c_1(f_n)$  tends to 0. The key step in verifying the maximal  $\sigma$ -proper extension is the following lemma:

**Lemma 6.2** ([DLS, Key Lemma 4.8]). *There is a small open topological disk  $D$  around  $c_1(f_*)$  and there is a small neighborhood  $\mathcal{U} \subset \mathcal{W}^u$  of  $f_*$  such that the following property holds. For every sufficiently big  $n \geq 1$ , for each  $\mathfrak{t} \in \{\mathfrak{a}_n, \mathfrak{b}_n\}$ , and for all  $f \in \mathcal{R}^{-n}(\mathcal{U})$ , we have  $c_{1+\mathfrak{t}}(f) := f^{\mathfrak{t}}(c_1) \in D$  and  $D$  pullbacks along the orbit  $c_1(f), c_2(f), \dots, c_{1+\mathfrak{t}}(f) \in D$  to a disk  $D_0$  such that  $f^{\mathfrak{t}}: D_0 \rightarrow D$  is a branched covering; moreover,  $D_0 \subset U_f \setminus \gamma_1$ .*

Lemma 6.2 implies that for a sufficiently big  $k < 0$  the pair (6.2) extends into a pair of commuting branched coverings

$$(6.3) \quad F_0^{(k)} = \left( f_k^{\mathfrak{a}_k}, f_k^{\mathfrak{b}_k} \right) : W_-^{(k)} \cup W_+^{(k)} \rightarrow D,$$

with  $W_-^{(k)} \cup W_+^{(k)} \cup D \subset V \setminus \gamma_1$ . Conjugating (6.3) by  $A_*^k \circ h_k$  we obtain the commuting pair

$$(\mathbf{f}_{0,-}, \mathbf{f}_{0,+}) : \mathbf{W}_-^{(k)}, \mathbf{W}_+^{(k)} \rightarrow \mathbf{D}^{(k)}$$

such that  $\bigcup_{k \ll 0} \mathbf{D}^{(k)} = \mathbb{C}$  (because the modulus of  $\mathbf{D}^{(tm-t)} \setminus \mathbf{D}^{(tm)}$  is uniformly bounded away from 0 for  $t \gg 0$  and all  $m \leq 0$ ). This implies that

$$(\mathbf{f}_{0,-}, \mathbf{f}_{0,+}) : \bigcup_{k \ll 0} \mathbf{W}_-^{(k)}, \bigcup_{k \ll 0} \mathbf{W}_+^{(k)} \rightarrow \mathbb{C}$$

is a pair of  $\sigma$ -proper maps.

Let us argue that (6.3) can be slightly adjusted such that the new commuting pair depends continuously on  $f_0$  as required. Recall that  $c_0$  and  $c_1$  denote the critical point and the critical value of a pacman  $f$ . For  $i \geq 0$  we write  $c_i = f^i(c_0)$ .

By [DLS, Theorem 4.6], if  $f_0$  is sufficiently close to  $f_*$ , then for every  $k \ll 0$  the disk  $D$  can be slightly shrunk to the disk  $D(f_0, k)$  (uniformly on  $k$  and  $f_0$ ) such that the following property holds: for  $i \leq \max\{\mathfrak{a}(k), \mathfrak{b}(k)\}$  we have

$$(6.4) \quad D(f_*, k) \ni c_i(f_*) \quad \text{if and only if} \quad D(f_0, k) \ni c_i(f_k)$$

(because points  $c_i(f_k)$  are sufficiently close to  $c_i(f_*)$ ). Pulling back  $D(f_0, k)$  along the orbit of (6.3), we obtain the extension of (6.3) to the commuting pair

$$(6.5) \quad F_0^{(k)} = \left( f_k^{\mathfrak{a}_k}, f_k^{\mathfrak{b}_k} \right) : W_-^{\text{new},(k)}, W_+^{\text{new},(k)} \rightarrow D(f_0, k),$$

that depends continuously on  $f_0$ . Moreover, all maps (6.5) are Hurwitz equivalent. Conjugating (6.5) by  $A_*^k \circ h_k$  we obtain the required commuting pair (6.1).  $\square$

Combining with the Implicit Function Theorem, we obtain:

**Corollary 6.3.** *Set*

$$T := \min\{(0, 1, 0), (0, 0, 1)\}.$$

*There is a point  $x$  and an open neighborhood  $\mathcal{U}$  of  $\mathbf{F}_*$  such that  $\bigcup_{S \leq T} \mathbf{F}^{-S}(x)$  moves holomorphically with  $\mathbf{F} \in \mathcal{U}$ .*

*Proof.* By Lemma 4.3,  $\text{CV}(\mathbf{F}^T)$  moves holomorphically within a small neighborhood of  $\mathbf{F}_*$ . Therefore, we can shrink  $\mathcal{U}$  from Lemma 6.1 and choose a point  $x \in \mathbf{U}_-(\mathbf{F}_*)$  such that  $x$  belongs to the interior of  $\mathbf{U}_-(\mathbf{F})$  and  $x$  does not hit  $\text{CV}(\mathbf{F})$  for all  $\mathbf{F} \in \mathcal{U}$ . By Lemma 6.1,  $\mathbf{F}^{-S}(x)$  moves holomorphically with  $\mathbf{F} \in \mathcal{U}$  for all  $S \leq T$ . Since the points  $\mathbf{F}^S(x)$  with  $S \leq T$  belong to different triangles of  $\Delta_0(\mathbf{F})$ , the set  $\mathbf{F}^{-S}(x)$  is disjoint from  $\mathbf{F}^{-Q}(x)$  for  $S < Q \leq T$ . We obtain a holomorphic motion of  $\bigcup_{S \leq T} \mathbf{F}^{-S}(x)$ .  $\square$

**6.2. Holomorphic motion of the escaping set.** We need the following facts.

**Lemma 6.4.** *Let  $g: U \rightarrow V$  be a finite branched covering between open topological disks. If  $g$  has a unique critical value, then  $g$  also has a unique critical point.*

*Proof.* By assumption,  $g: U \setminus \text{CP}(g) \rightarrow V \setminus \text{CV}(g)$  is a covering. Since  $\pi_1(V \setminus \text{CV}(g))$  is an abelian group, so is  $\pi_1(U \setminus \text{CP}(g))$ . Therefore,  $\text{CP}(g)$  is a singleton.  $\square$

**Lemma 6.5.** *Let  $g: \mathbb{D} \rightarrow \mathbb{C}$  be a  $\sigma$ -proper map. Fix an open disk  $W \subset \mathbb{C}$ . Let  $U$  be an open set intersecting  $\partial\mathbb{D}$ . Then  $g^{-1}(W)$  intersects  $U$ .*

*Proof.* Suppose  $g^{-1}(W) \cap U = \emptyset$ . Choose an open topological disk  $V \subset U \cap \mathbb{D}$  such that  $\partial V$  is a simple closed curve containing an arc  $I \subset \partial\mathbb{D}$ . Choosing a point  $w$  in  $W$  and postcomposing  $g$  with a Möbius transformation  $h$  moving  $w$  to  $\infty$ , we obtain that the new function  $s := h \circ g: \mathbb{D} \rightarrow \widehat{\mathbb{C}}$  is bounded on  $V$ . By the Fatou Theorem,  $s|_V$  has radial limit at almost every point in  $\partial V$ . By the Riesz Theorem, almost all of the radial limits are different from any fixed number, in particular from  $h(\infty)$ . Therefore, there is an  $x \in I$  such that  $g$  has a finite radial limit  $y$  at  $x$ . This contradicts to the assertion that  $g$  is  $\sigma$ -proper: if  $\Sigma$  is a small neighborhood of  $y$ , then every connected component of  $g^{-1}(\Sigma)$  is disjoint from  $\partial\mathbb{D} \ni x$ .  $\square$

**Corollary 6.6.** *Consider  $\mathbf{F} \in \mathcal{W}^u$  and  $P \in \mathbb{T}_{>0}$ . Then for every  $x \in \mathbb{C}$ , the boundary  $\partial \text{Dom}(\mathbf{F}^P)$  is the set of accumulating points of  $\mathbf{F}^{-P}(x)$ .*

*Proof.* Let  $U$  be a connected component of  $\text{Dom}(\mathbf{F}^P)$ . We claim that the preimages of  $x$  under  $\mathbf{F}^P|_U$  accumulate at  $\partial U$ .

Since the set of critical values of  $\mathbf{F}^P$  is discrete (Lemma 4.4), we can choose small neighborhoods  $W \ni \Omega \ni x$  so that  $W \cap \text{CV}(\mathbf{F}^P) \subset \{x\}$ . Thus  $W$  contains at most one critical value. By Lemma 6.4, every connected component  $W'$  of  $\mathbf{F}^{-P}(W)$  contains at most one critical point. By Lemma 4.3, the degree of  $\mathbf{F}^P: W' \rightarrow W$  is at most  $k$ , where  $k$  is independent of  $W'$ . Therefore, if  $\Omega'$  is the connected component of  $\mathbf{F}^{-P}(\Omega)$  within  $W'$ , then the modulus of  $W' \setminus \Omega'$  is uniformly bounded from 0.

Let us precompose  $\mathbf{F}^P: U \rightarrow \mathbb{C}$  with a Riemann map  $\mathbb{D} \rightarrow \text{Dom}(\mathbf{F}^P)$ ; we obtain a  $\sigma$ -proper map  $g: \mathbb{D} \rightarrow \mathbb{C}$ . By Lemma 6.5, for every  $y \in \partial\mathbb{D}$ , there is a connected component  $\Omega'$  of  $g^{-1}(\Omega)$  close to  $y$ . Denote by  $W'$  the connected component of  $g^{-1}(W)$  containing  $\Omega'$ . Since  $W' \setminus \Omega' \subset \mathbb{D}$  and the modulus of  $W' \setminus \Omega'$  is bounded from 0, the component  $\Omega'$  is small. Since  $\Omega'$  contains a preimage of  $x$ , the corollary is verified.  $\square$

A *conformal motion* of a set  $E \subset \mathbb{C}$  parametrized by a complex manifold is a holomorphic motion whose dilatation on  $E$  is 0. Combined with Corollary 6.3 we obtain:

**Lemma 6.7.** *The set*

$$(6.6) \quad \mathcal{D}_P = \mathbb{C} \setminus \mathcal{E}_P := \{\mathbf{F} \in \mathcal{W}^u \mid 0 \notin \mathbf{Esc}_P(\mathbf{F})\}$$

*is open. There is a unique equivariant conformal motion  $\tau$  of  $\mathbf{Esc}_P(\mathbf{F})$  along any curve in  $\mathcal{D}_P$ .*

*The escaping set  $\mathbf{Esc}(\mathbf{F})$  has empty interior and supports no invariant line field for every  $\mathbf{F} \in \mathcal{W}^u$ .*

We do not claim in this lemma that  $\mathcal{D}_P$  is connected.

*Proof.* Consider  $T, \mathcal{U}$ , and  $x$  from Corollary 6.3; i.e.  $\bigcup_{S \leq T} \mathbf{F}^{-S}(x)$  moves holomorphically with  $\mathbf{F} \in \mathcal{U}$ , where  $\mathcal{U}$  is a neighborhood of  $\mathbf{F}_*$ . Applying the  $\lambda$ -lemma, we obtain the holomorphic motion  $\tau$  of  $\bigcup_{S \leq T} \mathbf{F}^{-S}(x)$ . By Corollary 6.6,

$$(6.7) \quad \partial \mathbf{Esc}_T(\mathbf{F}) \subset \overline{\bigcup_{S \leq T} \mathbf{F}^{-S}(x)}$$

moves holomorphically with  $\mathbf{F} \in \mathcal{U}$ . Clearly,  $\tau$  is an equivariant motion.

In particular,  $\tau$  induces an equivariant qc map between  $\mathbf{Esc}_T(\mathbf{F})$  and  $\mathbf{Esc}_T(\mathbf{F}_*)$  for every  $\mathbf{F} \in \mathcal{U}$ . By Lemma 5.39,  $\mathbf{Esc}_T(\mathbf{F})$  has empty interior and supports no invariant line field. Therefore,  $\tau$  is a holomorphic motion of  $\mathbf{Esc}_T(\mathbf{F}) = \partial \mathbf{Esc}_T(\mathbf{F})$ . Observe that the dilatation of  $\tau$  is small if  $\mathbf{F}$  is close to  $\mathbf{F}_*$ . Moreover, by Proposition 5.37, we have:

$$(6.8) \quad \mathbf{Esc}_M(\mathbf{F}) = \overline{\bigcup_{S < M} \mathbf{Esc}_S(\mathbf{F})}.$$

for all  $M \leq T$ .

Let us now show that the definition of  $\tau$  is independent of  $x$ . Suppose that  $y_{\mathbf{G}} \in \mathbb{C} \setminus \mathcal{CV}(\mathbf{G})$  is a point that depends holomorphically on  $\mathbf{G}$  in a small neighborhood of  $\mathbf{F} \in \mathcal{U}$ . In a smaller neighborhood of  $\mathbf{F}$ , we can connect  $x, y$  by a simple arc  $\ell \subset \mathbb{C} \setminus \mathcal{CV}(\mathbf{G})$  and surround  $\ell$  by an annulus  $A \subset \mathbb{C} \setminus \mathcal{CV}(\mathbf{G})$  (we recall that  $\mathcal{CV}(\mathbf{G}^T)$  depends continuously on  $\mathbf{G}$  by Lemma 4.3). If  $\ell_n$  is a sequence of preimages of  $\ell$  under  $\mathbf{G}^T$  accumulating at a point in  $\mathbf{Esc}_T(\mathbf{G}) = \partial \mathbf{Esc}_T(\mathbf{G})$ , then the diameter of  $\ell_n$  tends to 0 because every  $\ell_n$  is separated from  $\mathbf{Esc}_T(\mathbf{G})$  by a conformal preimage of  $A$ . Therefore, the motion  $\tau$  coincides with the motion of

$$\mathbf{Esc}_T(\mathbf{G}) \subset \overline{\mathbf{G}^{-T}(y_{\mathbf{F}})}$$

in a small neighborhood of  $\mathbf{F}$ .

We claim that  $\tau$  is the unique equivariant holomorphic motion of  $\mathbf{Esc}_T(\mathbf{F})$ . Suppose  $\tau'$  is another equivariant holomorphic motion of  $\mathbf{Esc}_T(\mathbf{G})$  defined in some neighborhood of  $\mathbf{F}$ . Choose a small  $S \in \mathbb{T}$  and a point  $y \in \mathbf{Esc}_S(\mathbf{G})$  and let  $y_{\mathbf{F}}$  be the motion of  $y$  induced by  $\tau'$ . Since  $\tau'$  is equivariant, the motion of  $\mathbf{F}^{S-T}(y_{\mathbf{F}})$  is  $\tau'$ . Since

$$\mathbf{Esc}_{T-S}(\mathbf{F}) \subset \overline{\mathbf{F}^{S-T}(y_{\mathbf{F}})}$$

we see that  $\tau'$  and  $\tau$  coincide on  $\mathbf{Esc}_{T-S}(\mathbf{F})$  for all  $S \in \mathbb{T}_{>0}$ . By (6.8), the motions  $\tau$  and  $\tau'$  coincide on  $\mathbf{Esc}_T(\mathbf{F})$ .

Let us show that the set

$$(6.9) \quad \mathcal{D}_P \cap \mathcal{U} = \{\mathbf{F} \in \mathcal{U} \mid 0 \notin \mathbf{Esc}_P(\mathbf{F})\}$$

is open for every  $P \in \mathbb{T}$ . If  $P < T$ , then  $\mathcal{D}_P \supset \mathcal{U}$  and the claim is immediate. Otherwise, we have:  $\mathbf{F} \in \mathcal{D}_P \cap \mathcal{U}$  if and only if  $\mathbf{F}^{P-T}(0) \notin \mathbf{Esc}_T(\mathbf{F})$ ; this is an open condition because  $\mathbf{Esc}_T(\mathbf{F})$  moves holomorphically with  $\mathbf{F} \in \mathcal{U}$ . For every  $\mathbf{F} \in \mathcal{D}_P \cap \mathcal{U}$  we can pullback the holomorphic motion of  $\mathbf{Esc}_T(\mathbf{F})$  to the holomorphic motion of  $\mathbf{Esc}_P(\mathbf{F})$ . The dilatation does not change under the conformal pullback.

For every  $\mathbf{F} \in \mathcal{W}^u$ , there is a sufficiently big  $n \ll 0$  such that  $\mathbf{F}_n$  is close to  $\mathbf{F}_*$ ; in particular,  $\mathbf{F}_n \in \mathcal{U}$ . Setting  $S = Pt^{-n}$ , we obtain that  $\mathbf{F} \in \mathcal{D}_P$  if and only if  $\mathbf{F}_n \in \mathcal{D}_S$ . This shows that (6.6) is open as a union of open sets. It also follows that  $\mathbf{Esc}_P(\mathbf{F})$  moves holomorphically with  $\mathbf{F} \in \mathcal{D}_P$ . The dilatation of the motion of  $\mathbf{Esc}_P(\mathbf{F})$  can be made arbitrary small by choosing  $\mathbf{F}_n$  close to  $\mathbf{F}_*$ . This shows that the holomorphic motion is conformal.

It was already proven that  $\mathbf{Esc}_S(\mathbf{F})$  has empty interior and supports no invariant line field for sufficiently small  $S$ . Therefore,  $\mathbf{Esc}_P(\mathbf{F})$  supports no invariant line field and has empty interior.  $\square$

**Corollary 6.8.** *For every  $\mathbf{F} \in \mathcal{W}^u$  we have  $\mathbf{Esc}(\mathbf{F}) \neq \emptyset$  and  $\mathfrak{J}(\mathbf{F}) = \overline{\mathbf{Esc}(\mathbf{F})}$ .*

*Proof.* For a small  $P \in \mathbb{T}_{>0}$ , the escaping set  $\mathbf{Esc}_P(\mathbf{F})$  is homeomorphic to  $\mathbf{Esc}_P(\mathbf{F}) \neq \emptyset$ . Since  $\mathbf{Esc}_P(\mathbf{F})$  contains at least two points, applying the Montel theorem we obtain that every neighborhood of  $z \in \mathfrak{J}(\mathbf{F})$  contains a preimage of a point in  $\mathbf{Esc}_P(\mathbf{F})$ .  $\square$

**6.3. External rays and alpha-points of  $\mathbf{F}$ .** Choose  $S \in \mathbb{T}_{>0}$  and a sufficiently small  $\varepsilon > 0$  such that the open  $\varepsilon$ -neighborhood  $\mathcal{U}$  of  $\mathbf{F}_* \in \mathcal{W}^u \simeq \mathbb{C}$  is contained in  $\mathcal{D}_S$ , see Lemma 6.7. For every pair of prepacmen  $\mathbf{F}, \mathbf{G}$  there is a sufficiently small  $n \ll 0$  such that  $\mathbf{F}_n, \mathbf{G}_n \in \mathcal{U}$ . Since  $\mathcal{U}$  is a topological disk, there is a unique up to homotopy path  $\ell$  in  $\mathcal{U}$  connecting  $\mathbf{F}_n$  and  $\mathbf{G}_n$ . The holomorphic motion  $\tau$  (from Lemma 6.7) along  $\ell$  produces an equivariant homeomorphism between  $\mathbf{Esc}_S(\mathbf{F}_n)$  and  $\mathbf{Esc}_S(\mathbf{G}_n)$ ; after rescaling we obtain an equivariant homeomorphism

$$h: \mathbf{Esc}_{t^n S}(\mathbf{F}) \rightarrow \mathbf{Esc}_{t^n S}(\mathbf{G}).$$

Taking the restriction, we obtain an equivariant homeomorphism

$$h: \mathbf{Esc}_Q(\mathbf{F}) \rightarrow \mathbf{Esc}_Q(\mathbf{G}).$$

for all  $Q < t^n S$ ; clearly  $h$  is independent of  $n$  (because  $\mathcal{R}^{-1}(\mathcal{U}) \subset \mathcal{U}$ ). We say that  $h$  is the *canonical identification* of  $\mathbf{Esc}_Q(\mathbf{F})$  and  $\mathbf{Esc}_Q(\mathbf{G})$ .

Consider  $\mathbf{G} \in \mathcal{W}^u$  and choose a sufficiently small  $T \in \mathbb{T}_{>0}$  so that  $\mathbf{Esc}_T(\mathbf{G})$  and  $\mathbf{Esc}_T(\mathbf{F}_*)$  are canonically identified. *Alpha-points of  $\mathbf{G}$  of generation  $S \leq T$*  are the images of the corresponding alpha-points of  $\mathbf{F}_*$  under the canonical identification. Similarly, *ray segments in  $\mathbf{Esc}_T(\mathbf{G})$*  are the images of ray segments in  $\mathbf{Esc}_T(\mathbf{F}_*)$  under the canonical identification.

If  $\alpha_i \in \mathbf{Esc}_T(\mathbf{G})$  is an alpha-point of generation  $S$ , then  $\mathbf{F}^{-P}(\alpha_i)$  are *alpha-points of generation  $S + P$* . Similarly, if  $\gamma \subset \mathbf{Esc}_T(\mathbf{F})$  is a ray segment connecting two alpha-points and  $\ell$  is a connected component of  $\mathbf{F}^{-P}(\gamma)$  such that  $\mathbf{F}^P: \gamma \rightarrow \ell$  is a homeomorphism, then  $\ell$  is also a *ray segment*. Note that  $\ell$  also connects two alpha-points.

External rays for  $\mathbf{G}$  are defined in the same way as for  $\mathbf{F}_*$ , see §5.9. Namely, an external ray  $\mathbf{R}$  is a maximal concatenation of external ray segments provided that it does not hit iterated preimage of 0. (An external ray “breaks” at a pre-critical point.)

**Lemma 6.9.** *Suppose  $0 \notin \mathbf{Esc}_P(\mathbf{F})$  and  $0 \notin \mathbf{Esc}_P(\mathbf{G})$ . Then there is a unique equivariant bijection  $h: \mathbf{Esc}_P(\mathbf{F}) \rightarrow \mathbf{Esc}_P(\mathbf{G})$  such that  $h: \mathbf{Esc}_Q(\mathbf{F}) \rightarrow \mathbf{Esc}_Q(\mathbf{G})$  coincides with the homeomorphism induced by  $\tau$  for all sufficiently small  $Q \in \mathbb{T}_{>0}$ .*

*Let  $\mathbf{R}$  be an external ray of  $\mathbf{G}$ . Then  $\mathbf{R}$  has a unique counterpart  $\mathbf{R}(\mathbf{F}_\star)$  in the dynamical plane of  $\mathbf{F}_\star$  such that for all sufficiently small  $Q$  the natural homeomorphism  $h: \mathbf{Esc}_Q(\mathbf{G}) \rightarrow \mathbf{Esc}_Q(\mathbf{F}_\star)$  induced by  $\tau$  extends to a homeomorphism*

$$h: \mathbf{Esc}_Q(\mathbf{G}) \cup \mathbf{R}(\mathbf{G}) \rightarrow \mathbf{Esc}_Q(\mathbf{F}_\star) \cup \mathbf{R}(\mathbf{F}_\star)$$

*that is equivariant in the following sense. For every  $x \in \mathbf{R}(\mathbf{G})$  with  $\mathbf{G}^T(x) \in \mathbf{Esc}_Q(\mathbf{G})$  we have  $h \circ \mathbf{G}^T(x) = \mathbf{F}_\star^T \circ h(x)$ .*

*Proof.* Let  $P'$  be the minimal escaping time of 0 for  $\mathbf{F}$  and  $\mathbf{G}$ ; we have  $P < P'$ . Since  $\mathbb{T}$  is dense in  $\mathbb{R}_{\geq 0}$ , we can slightly increase  $P$  so that the new  $P$  is still less than  $P'$ , and  $R := P/m \in \mathbb{T}$ , and  $R < Q/3$  for some  $m \in \mathbb{Z}_{>0}$ .

Let us say that a *decoration* is a connected component of  $\mathbf{Esc}_{iR}(\mathbf{F}) \setminus \mathbf{Esc}_{(i-1)R}(\mathbf{F})$  for  $i \in \{1, 2, \dots, m\}$ ; we say that  $i$  is the *generation* of the decoration. Note that  $\mathbf{Esc}_R(\mathbf{F})$  is a decoration of generation 1. We will show that decorations for  $\mathbf{G}$  and  $\mathbf{F}_\star$  are arranged in the same way.

*Claim.* In the dynamical planes of  $\mathbf{F} \in \{\mathbf{F}_\star, \mathbf{G}\}$  consider a decoration  $X_j$  of generation  $i > 1$ . Then  $X_j$  is precompact and there is a unique alpha-point  $\alpha_j$  of generation  $(i-1)R$  such that  $X_j \cup \alpha_j$  is compact. Moreover,  $X_j$  and  $X_j \cup \alpha_j$  are filled-in. The image  $\mathbf{F}^R(X_j)$  is a decoration  $X_{\mathbf{F}_\star(j)}$  of generation  $i-1$ . If  $i < m$ , then for every  $\alpha_s \in \mathbf{F}^{-R}(\alpha_i)$ , there is a unique decoration  $X_s$  of generation  $i+1$  such that  $\bar{X}_s = X_s \cup \{\alpha_s\}$  and  $\mathbf{F}^R(X_s) = X_j$ .

*Proof of the Claim.* The case  $\mathbf{F} = \mathbf{F}_\star$  follows from Lemma 5.18. Since there is an equivariant homeomorphism between  $\mathbf{Esc}_{3R}(\mathbf{G})$  and  $\mathbf{Esc}_{3R}(\mathbf{F}_\star)$  (recall that ), the claim is also true if  $\mathbf{F} = \mathbf{G}$  and  $i \leq 3$ .

Suppose that  $X_j$  is a decoration of generation  $i > 3$  in the dynamical plane of  $\mathbf{G}$ . Choose  $x \in X_j$  and let  $X_k$  be the decoration of generation 2 containing  $\mathbf{F}^{(i-2)R}(x)$ . Since the claim is already verified for  $X_k$ , we have  $\bar{X}_k = X_k \cup \{\alpha_k\}$  is compact and filled-in. Since  $\bar{X}_k$  does not contain a critical values of  $\mathbf{F}^{(i-2)R}$  and since the set of the critical values is discrete (see Lemma 4.4), there is an open topological disk  $U_k \supset \bar{X}_k$  such that  $U_k$  does contain any critical point of  $\mathbf{F}^{(i-2)R}$ . Pulling back  $U_k$  along the orbit of  $x$  and using  $\sigma$ -properness, we construct a univalent preimage  $U_j \ni x$  of  $U_k$  under  $\mathbf{F}^{(i-2)R}$ . It now follows that  $\bar{X}_j = X_j \cup \{\alpha_j\}$  is the preimage of  $X_k \cup \{\alpha_k\}$  under  $\mathbf{F}^{(i-2)R}: U_j \rightarrow U_k$ .

If  $\alpha_s \in \mathbf{G}^{-R}(\alpha_j)$ , then pulling back  $U_i$  along  $\mathbf{F}^R: \alpha_s \mapsto \alpha_i$  we construct a univalent preimage  $U_s \ni \alpha_s$  of  $U_i$ . Then  $X_s$  is the preimage of  $X_j$  under  $\mathbf{F}^R: U_s \rightarrow U_k$ .  $\square$

Observe that all decorations of  $\mathbf{F}_\star$  and  $\mathbf{G}$  are canonically homeomorphic by an equivariant homeomorphism: all decorations are univalent preimages of  $\mathbf{Esc}_R(\mathbf{F}_\star)$  and  $\mathbf{Esc}_R(\mathbf{G})$  which are canonically identified. We proceed by induction: suppose that  $h$  has been already extended to an equivariant bijection

$$h: \mathbf{Esc}_{tR}(\mathbf{F}_\star) \rightarrow \mathbf{Esc}_{tR}(\mathbf{G})$$

where  $t < m$ . Then  $h$  induces a bijection between alpha-points of generation  $tR$ . There is a decoration of generation  $t+1$  attached to every alpha-point of generation

$tR$ ; since these decorations are canonically homeomorphic, we can uniquely extend  $h$  to the bijection

$$h: \mathbf{Esc}_{(t+1)R}(\mathbf{F}_\star) \rightarrow \mathbf{Esc}_{(t+1)R}(\mathbf{G}).$$

To prove the second claim, fix  $T < Q$  and decompose  $\mathbf{R}$  as a concatenation of arcs  $\mathbf{R}_1 \cup \mathbf{R}_2 \cup \dots$  such that  $\mathbf{R}_i \subset \mathbf{Esc}_{iT}(\mathbf{G}) \setminus \mathbf{Esc}_{(i-1)T}(\mathbf{G})$ . Inductively define  $\mathbf{R}_i(\mathbf{F}_\star)$  to be the unique lift of  $h \circ \mathbf{G}^{T(i-1)}(\mathbf{R}_i(\mathbf{G}))$  under  $\mathbf{F}_\star^{T(i-1)}$  starting where  $\mathbf{R}_{i-1}(\mathbf{F}_\star)$  ends.  $\square$

By Lemma 6.9, the combinatorics of external rays for  $\mathbf{G} \in \mathcal{W}^u$  is the same as for  $\mathbf{F}_\star$ .

**Corollary 6.10** ( $\tau$  has no holonomy). *If  $\mathbf{F}, \mathbf{G}$  are in the same connected component of  $\mathcal{D}_P$ , then the equivariant homeomorphism  $h: \mathbf{Esc}_P(\mathbf{F}) \rightarrow \mathbf{Esc}_P(\mathbf{G})$  induced by  $\tau$  (see Lemma 6.7) is independent of the curve connecting  $\mathbf{F}$  and  $\mathbf{G}$ .*  $\square$

**Corollary 6.11.** *For every  $K > 1$  and  $\mathbf{F}, \mathbf{G} \in \mathcal{W}^u$ , there exists a sufficiently small  $T \in \mathbb{T}_{>0}$  such that the equivariant homeomorphism*

$$h: \mathbf{Esc}_T(\mathbf{F}) \rightarrow \mathbf{Esc}_T(\mathbf{G})$$

*induced by the holomorphic motion from Lemma 6.7 extends to a qc map  $\tilde{h}: \mathbb{C} \rightarrow \mathbb{C}$  with dilatation less than  $K$ .*

*Proof.* For a sufficiently small  $T$ , the hyperbolic distance between  $\mathbf{F}$  and  $\mathbf{G}$  in  $\mathcal{D}_T$  is small. The  $\lambda$ -lemma extends  $h$  to a qc map with a small dilatation.  $\square$

**6.4. Puzzle pieces.** Consider a dynamical plane of  $\mathbf{G}$ . Let us say a ray  $\mathbf{R}$  *lands* if either  $\mathbf{R}$  lands at a point  $x \in \mathbb{C}$  in the classical sense, or  $\mathbf{R}$  lands at  $\alpha$ , see §4.7. A *rational ray* is either a periodic or preperiodic ray.

Let  $\tilde{\mathbf{R}} = \{\mathbf{R}^1, \mathbf{R}^2, \dots, \mathbf{R}^n\}$  be a finite set of rational (i.e. periodic or preperiodic) rays. We assume that every  $\mathbf{R}^i$  lands. We define

$$\bar{\mathbf{R}} := \bigcup_i \bigcup_{P \geq 0} \mathbf{G}^P(\mathbf{R}^i)$$

to be the forward orbit of rays in  $\tilde{\mathbf{R}}$ .

**Lemma 6.12.** *The set  $\bar{\mathbf{R}}$  is a forward invariant connected graph.*

*Proof.* Recall from Corollary 5.27 that every two external rays eventually meet. Therefore,  $\bar{\mathbf{R}}$  is connected.

Fix a compact subset  $\mathbf{X} \Subset \mathbb{C}$ . Let  $T_1$  be a common period of rays in  $\tilde{\mathbf{R}}$  and let  $T_2$  be a common preperiod of rays in  $\tilde{\mathbf{R}}$ ; write  $T := T_1 + T_2$ . We need to prove that there are at most finitely many  $P < T$  such that  $\mathbf{G}^P(\mathbf{R}^i)$  intersects  $\mathbf{X}$  for some  $i$ ; this would imply that  $\bar{\mathbf{R}}$  is an increasing union of finite graphs as required, see §1.4.

Choose a sufficiently small  $Q > 0$  such that  $\mathbf{Esc}_Q(\mathbf{G})$  is disjoint from  $\mathbf{X}$ . And choose a sufficiently small neighborhood  $\mathcal{O}$  of  $\alpha$  such that  $\mathbf{G}^P(\mathcal{O})$  is disjoint from  $\mathbf{X}$  for all  $P < T$ . We can choose finitely many external ray segments  $\mathbf{R}_1, \dots, \mathbf{R}_m$  in  $\bar{\mathbf{R}}$  such that

$$\bigcup_i \mathbf{R}^i \setminus (\mathcal{O} \cup \mathbf{Esc}_Q(\mathbf{G})) \subset \bigcup_j \mathbf{R}_j$$

and such that for every  $\mathbf{R}_j$  there exists  $P_j$  with  $\mathbf{R}_j \Subset \text{Dom}(\mathbf{G}^{P_j})$  such that  $\mathbf{G}^{P_j}(\mathbf{R}_j) \subset \mathbf{Esc}_Q(\mathbf{G})$ . In particular,  $\bar{\mathbf{R}} \cap \mathbf{X}$  is covered by the orbits of  $\mathbf{R}_j$ . By

Corollary 4.5, there are at most finitely many  $T < P_j$  such that  $\mathbf{G}^T(\mathbf{R}_j)$  intersects  $\mathbf{X}$ .  $\square$

A *puzzle piece*  $\mathbf{X}$  is the closure of a connected component of  $\mathbb{C} \setminus \overline{\mathbf{R}}$ . Since the forward orbit of  $\partial\mathbf{X}$  is disjoint from  $\text{int } \mathbf{X}$ , we have the following classical property. If  $\mathbf{Y}$  is the closure of a connected component of  $\mathbf{F}^{-S}(\text{int } \mathbf{X})$ , then either  $\mathbf{X}$  and  $\mathbf{Y}$  have disjoint interiors, or  $\mathbf{Y} \subset \mathbf{X}$ .

Let us note that a puzzle piece can be surrounded by a single external ray, see example in Lemma 7.3. This happens when a preperiodic ray lands at itself; a certain iterate of such ray eventually lands at  $\alpha$ .

## 7. PARABOLIC BIFURCATION AND SMALL $\mathcal{M}$ -COPIES

**7.1. Parabolic prepacman  $\mathbf{F}_\tau$ .** In a small neighborhood of  $f_\star$  consider a parabolic pacman  $f_\tau \in \mathcal{W}^u$  with rotation number  $\tau = \mathfrak{p}/\mathfrak{q}$ . Recall from §3.2.14 that  $\mathbf{H}$  denotes the global attracting basin; its periodic components are parametrized as  $(\mathbf{H}^i)_{i \in \mathbb{Z}}$ . We write the first return map to  $\mathbf{H}^0$  as

$$(7.1) \quad \mathbf{F}_\tau^{Q(\tau)}: \mathbf{H}^0 \rightarrow \mathbf{H}^0.$$

For standard reasons,  $\mathbf{H}^i$  is a Fatou component.

Let  $U \subsetneq \mathbb{C}$  be an open simply connected set.

We say that a univalent map  $f: U \rightarrow U$  is a *local attracting parabolic petal* if it admits a *local Fatou coordinate*: a univalent map  $h: U \rightarrow \mathbb{C}$  conjugating  $f: U \rightarrow U$  to the translation  $T_1: z \rightarrow z + 1$  such that  $\text{Im } f \supset \{z \in \mathbb{C} \mid \text{Re } z \geq M\}$  for some  $M \in \mathbb{R}$ .

We say that a branched covering of finite degree  $f: U \rightarrow U$  is a *full attracting parabolic petal* if  $f$  restricts to a local attracting parabolic petal  $f: U' \rightarrow U'$  for some  $U' \subset U$ . For standard reasons, every point in  $U$  is eventually attracted by  $U'$ . Hence, a local Fatou coordinate system  $h: U' \rightarrow \mathbb{C}$  extends to a branched covering  $h: U \rightarrow \mathbb{C}$  semi-conjugating  $f$  to  $T_1$ . We call  $h: U \rightarrow \mathbb{C}$  a *global Fatou coordinate*.

We say that a full attracting parabolic petal  $f: U \rightarrow U$  is *unicritical* if  $f$  has a unique critical value. By Lemma 6.4,  $f$  also has a unique critical point.

**Lemma 7.1.** *Let  $f: U \rightarrow U, g: V \rightarrow V$  be two unicritical full attracting parabolic petals of the same degree. Then  $f$  and  $g$  are conformally conjugate.*

*Proof.* We normalize full Fatou coordinate systems  $h_f: U \rightarrow \mathbb{C}$  and  $h_g: V \rightarrow \mathbb{C}$  so that

$$0 = h_f(\text{critical value of } f) = h_g(\text{critical value of } g).$$

Choose next local attracting parabolic petals  $f: U' \rightarrow U'$  and  $g: V' \rightarrow V'$  so that  $h := h_f \circ h_g^{-1}$  is a conjugacy between  $f: U' \rightarrow U'$  and  $g: V' \rightarrow V'$ . We can also assume that  $U'$  and  $V'$  contain the critical values of  $f$  and  $g$ . Since  $h$  respects the postcritical sets, we can apply the pullback argument and extend  $h$  to a global conjugacy  $h: U \rightarrow V$  between  $f$  and  $g$ .  $\square$

Recall that the quadratic polynomial  $p_{1/4} = z^2 + 1/4$  has a parabolic fixed point at  $\alpha(p_{1/4}) = 1/2$ . We denote by  $\mathbb{P}$  the attracting basin of  $\alpha(p_{1/4})$ . Note that  $p_{1/4}: \partial\mathbb{P} \rightarrow \partial\mathbb{P}$  is topologically conjugate to  $z \mapsto z^2: \mathbb{S}^1 \rightarrow \mathbb{S}^1$ . By Lemma 7.1, there is a conformal conjugacy

$$(7.2) \quad \mathbf{h}_i: \mathbf{H}^i \rightarrow \mathbb{P}$$

between  $\mathbf{F}_\tau^{Q(\tau)}: \mathbf{H}^i \rightarrow \mathbf{H}^i$  and  $p_{1/4}: \mathbb{P} \rightarrow \mathbb{P}$ .

Recall that  $\Delta$  denotes the main hyperbolic component of  $\mathcal{W}^u$ , see §4.1. Choose a curve  $\ell \subset \overline{\Delta}$  connecting  $\mathbf{F}_*$  to  $\mathbf{F}_\tau$ . For every  $T \in \mathbb{T}$  there is a small neighborhood of  $\ell$  where the holomorphic motion  $\tau$  of  $\mathbf{Esc}_T(\mathbf{G})$  is defined, see Lemma 6.7. Then  $\tau$  produces an equivariant homeomorphism

$$h: \mathbf{Esc}_T(\mathbf{F}_*) \rightarrow \mathbf{Esc}_T(\mathbf{F}_\tau).$$

Therefore,  $\mathbf{Esc}(\mathbf{F}_\tau)$  has the same properties as  $\mathbf{Esc}(\mathbf{F}_*)$ ; in particular,  $\mathbf{Esc}(\mathbf{F}_\tau)$  is uniquely geodesic.

**Theorem 7.2.** *If  $i \neq j$ , then  $\overline{\mathbf{H}}^i \cap \overline{\mathbf{H}}^j = \emptyset$ . The conjugacy  $\mathbf{h}_i: \mathbf{H}^i \rightarrow \mathbb{P}$  extends uniquely to a topological conjugacy*

$$(7.3) \quad \mathbf{h}_i: \overline{\mathbf{H}}^i \cup \{\alpha(\mathbf{F}_\tau)\} \rightarrow \overline{\mathbb{P}}$$

For every  $i$  there is a unique external ray  $\mathbf{R}^i$  landing at  $\alpha(\mathbf{F}_\tau)$  such that  $\mathbf{R}^i$  is between  $\mathbf{H}^i$  and  $\mathbf{H}^{i+1}$ . The ray  $\mathbf{R}^i$  is  $Q(\tau)$ -periodic. Moreover,  $\mathbf{R}^i$  and  $\mathbf{R}^{i+1}$  meet at  $\alpha(1/2, \mathbf{H}^i)$  – the unique preimage of  $\alpha(\mathbf{F}_\tau)$  in  $\mathbb{C}$  under  $\mathbf{F}_\tau^{Q(\tau)}: \overline{\mathbf{H}}^0 \rightarrow \overline{\mathbf{H}}^0$ .

Let  $\mathbf{W}(i)$  be the closed puzzle piece bounded by  $\mathbf{R}^{i-1}$  and  $\mathbf{R}^i$  and containing  $\mathbf{H}^i$ , and let  $\mathbf{W}^1$  be the pullback of  $\mathbf{W} := \mathbf{W}(0)$  along  $\mathbf{F}_\tau^{Q(\tau)}: \mathbf{H}^0 \rightarrow \mathbf{H}^0$ , see Figure 32. Then

$$(7.4) \quad \mathbf{F}_\tau^{Q(\tau)}: \mathbf{W}^1 \rightarrow \mathbf{W}.$$

is a 2-to-1 map.

We say that (7.4) is the *primary renormalization map*. It can be thickened to a “pinched quadratic-like map”. Before giving the proof of Theorem 7.2 let us introduce an expanding metric for  $\mathbf{F}_\tau$ .

7.1.1. *Expanding metric for  $\mathbf{F}_\tau$ .* Let  $B \subset \mathbb{P}$  be a forward invariant open topological disk containing  $[1/4, 1/2)$  such that  $\overline{B}$  is a closed topological disk with

$$\partial B \cap p_{1/4}(\overline{B}) = \alpha(p_{1/4}) = \overline{B} \cap \partial \mathbb{P}$$

(recall that  $1/4$  is the critical value of  $p_{1/4}$ ). We can take  $B$  to be an appropriate small neighborhood of  $[1/4, 1/2)$ .

Define  $\mathbb{B}^0 := \mathbf{h}_0^{-1}(B)$  and observe that  $\overline{\mathbb{B}}^0 \subset \mathbf{H}^0$ . Spreading around  $\overline{\mathbb{B}}^0$ , we obtain

$$\mathbb{B} := \bigcup_{P \geq 0} \mathbf{F}_\tau^P(\overline{\mathbb{B}}^0) \subset \bigcup_{i \in \mathbb{Z}} \mathbf{H}^i.$$

By construction,  $\mathbb{B}$  contains the postcritical set  $\mathfrak{P}(\mathbf{F}_\tau)$ . Consider the hyperbolic surface  $\mathbf{X} := \mathbb{C} \setminus \overline{\mathbb{B}}$ . Then  $\mathbf{F}_\tau^{-T}(\mathbf{X}) \subsetneq \mathbf{X}$  and

$$(7.5) \quad \mathbf{F}_\tau^T: \mathbf{F}_\tau^{-T}(\mathbf{X}) \rightarrow \mathbf{X}$$

is a covering for all  $T$ . By Schwartz lemma, (7.5) expands the hyperbolic metric.

*Proof of Theorem 7.2.* Choose  $\mu \in (1/4, 1/2)$ . In the dynamical plane of  $p_{1/4}$ , define  $\delta'_0$  to be the interval  $[\mu, 1/2) \subset \mathbb{P}$  landing at  $1/2$ . We view  $\delta'_0$  as a simple arc parametrized by  $[0, 1)$ . Set  $\alpha(k/2^n, p_{1/4})$  to be the landing point of the external ray with angle  $k/2^n$ , where  $k \in \{1, 3, 5, \dots, 2^n - 1\}$ . Note that  $\alpha(k/2^n, p_{1/4})$  is a preimage of  $\alpha$  under  $p_{1/4}^n$ . We define  $\delta'_{k/2^n}$  to be the lift of  $\delta'_0$  under  $p_{1/4}^n$  landing at  $\alpha(k/2^n, p_{1/4})$ . Let  $\delta_{k/2^n}$  be the lift of  $\delta'_{k/2^n}$  under  $\mathbf{h}_0$ .



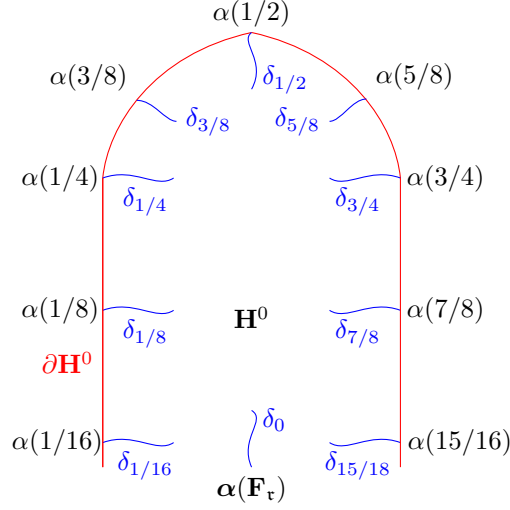

FIGURE 31. Alpha-points of  $\partial\mathbf{H}^0$  are defined at the landing points of curves in  $\mathbf{H}^0$  (compare with Figure 32).

*Claim 1:*  $\delta_0$  lands at  $\alpha(\mathbf{F}_\tau)$  while  $\delta_{k/2^n}$  with  $k \in \{1, 3, 5, \dots, 2^n - 1\}$  land at pairwise different alpha-points of generation  $nQ(\tau)$ . We denote by  $\alpha(k/2^n, \mathbf{H}^0)$  the landing point of  $\delta_{k/2^n}$ , see Figure 31.

*Proof of the claim.* Recall that  $\mathcal{W}_{\text{loc}}^u$  denotes the set of maximal prepacmen close to  $\mathbf{F}_*$  that have the associated pacmen on  $\mathcal{W}^u$ . By definition,  $\mathbf{F}_\tau \in \mathcal{W}^u$ . Applying the  $\lambda$ -lemma, we will first show that a certain version of Lemma 5.12 holds in the dynamical plane of  $\mathbf{G} \in \mathcal{W}_{\text{loc}}^u$ .

Since  $\delta_0$  is invariant under  $\mathbf{F}_\tau^{Q(\tau)}$ , by replacing  $\delta_0$  with its subcurve  $\delta_0[t, 1)$ , we can assume that  $\delta_0$  is contained in  $\mathbf{H}_0^0$  (see §3.2.14). Thus  $\delta_0(\mathbf{F}_\tau)$  projects to the dynamical plane of  $f_\tau$ , and the projection, call it  $\delta_0(f_\tau)$ , is disjoint from the critical arc  $\gamma_1$ , possibly up to a slight rotation of  $\gamma_1$  as in §3.2.14.

For  $g \in \mathcal{W}^u$ , let  $T_g$  be the unique translation mapping  $\alpha(f_\tau)$  to  $\alpha(g)$ . For every  $\mathbf{G} \in \mathcal{W}_{\text{loc}}^u$ , we define  $\delta_0(\mathbf{G})$  to be the lift of  $\delta_0(g) := T_g(\delta_0(f_\tau))$  to  $\mathbf{S}(\mathbf{G}) \simeq V \setminus \gamma_1$ . By construction,  $\delta_0(\mathbf{G})$  depends holomorphically on  $\mathbf{G}$ .

For a small  $T \in \mathbb{T}_{>0}$  and  $\mathbf{G} \in \mathcal{W}_{\text{loc}}^u$ , the set of critical values  $\text{CV}(\mathbf{G}^T)$  is disjoint from  $\delta(\mathbf{G})$  because

$$\text{CV}(\mathbf{G}^T) \setminus \{0\} \subset \Delta_0(\mathbf{G}) \setminus \mathbf{S} \quad \text{and} \quad \delta(\mathbf{G}) \subset \mathbf{S},$$

see (4.10). Therefore,  $\mathbf{G}^{-T}(\delta)$  moves holomorphically with  $\mathbf{G} \in \mathcal{W}_{\text{loc}}^u$ . Applying the  $\lambda$ -lemma, we obtain the holomorphic motion of  $\overline{\mathbf{G}^{-T}(\delta)}$  with  $\mathbf{G} \in \mathcal{W}_{\text{loc}}^u$ . Since curves in  $\overline{\mathbf{F}_\tau^{-T}(\delta)}$  land at different alpha-point (Lemma 5.12), the same is true for  $\overline{\mathbf{F}_\tau^{-T}(\delta)}$  in the dynamical plane of  $\mathbf{F}_\tau$ .

Let  $\mathbf{H}^i$  be the unique (by (3.14)) periodic preimage of  $\mathbf{H}^0$  under  $\mathbf{F}_\tau^T$ . Since  $T$  is small, the map  $\mathbf{F}_\tau^T: \mathbf{H}^i \rightarrow \mathbf{H}^0$  is two-to-one. There are two lifts  $\delta_0^T$  and  $\delta_{1/2}^T$  of  $\delta$  under  $\mathbf{F}_\tau^T: \mathbf{H}^i \rightarrow \mathbf{H}^0$ . One of them lands at  $\alpha(\mathbf{F}_\tau)$ , while the other  $\delta_{1/2}^T$  lands at the alpha-point  $\alpha(1/2, \mathbf{H}^i)$  of generation  $T$ .

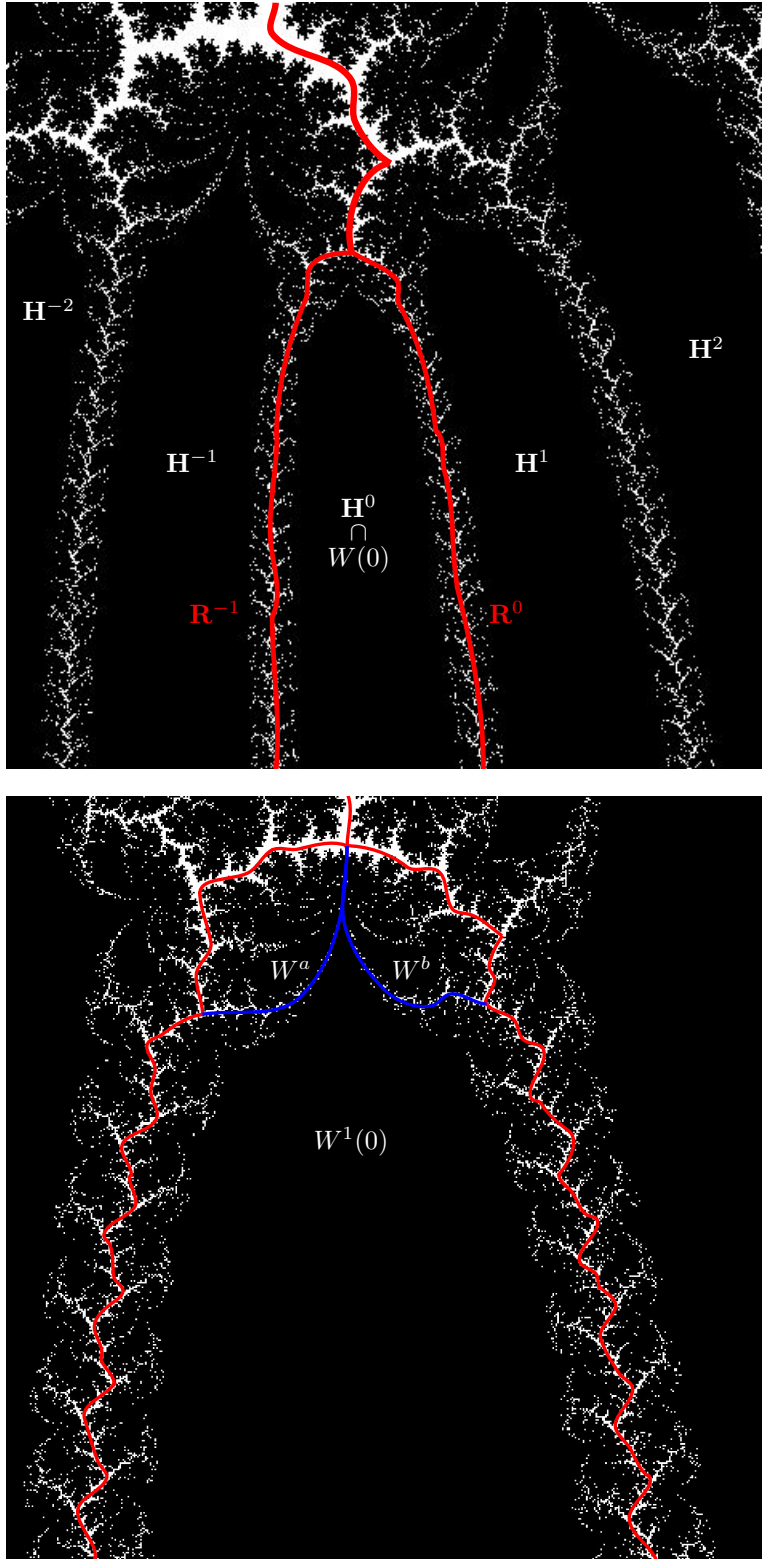

FIGURE 32. Parabolic maximal prepacmen: attracting petals  $H^i$  and puzzle pieces  $W = W^1 \cup W^a \cup W^b$  (where  $W^1$  is bounded by two red and two blue curves).

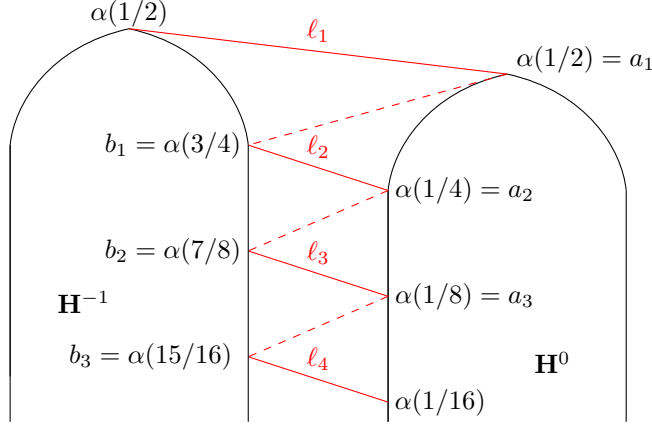

FIGURE 33. Curves  $\ell_n$  and  $[b_n, a_{n+1}]$  (dashed), compare with Figure 322.

Observe that  $\overline{\delta_{1/2}^T} = \delta_{1/2}^T \cup \alpha(1/2, \mathbf{H}^i)$  is contained in  $\mathbf{X}$  (see §7.1.1). Therefore, for all  $P \in \mathbb{T}$  all the lifts of  $\delta_{1/2}^T$  under  $\mathbf{F}_\tau^P$  land at pairwise different preimages of  $\alpha(1/2, \mathbf{H}^i)$ . Since  $\delta_{k/2^n}$  are lifts of  $\delta_{1/2}^T$ , the claim follows.  $\square$

For  $\mathbf{H}^i$  we define  $\alpha(k/2^n, \mathbf{H}^i)$  to be the images of  $\alpha(k/2^n, \mathbf{H}^i)$  under the univalent map  $\mathbf{F}_\tau^S: \mathbf{H}^0 \rightarrow \mathbf{H}^i$ , where  $S < Q(\tau)$ .

Let

$$\ell_n := [\alpha(1/2^n, \mathbf{H}^0), \alpha((2^n - 1)/2^n, \mathbf{H}^{-1})] \subset \mathbf{Esc}_{nQ(\tau)}(\mathbf{F}_\tau)$$

be the unique geodesic (in  $\mathbf{Esc}(\mathbf{F}_\tau)$ ) connecting the alpha-points, see Figure 33.

*Claim 2:*  $\mathbf{F}_\tau^{Q(\tau)}$  maps  $\ell_{n+1}$  to  $\ell_n$ . The curves  $\ell_n$  converge to  $\alpha(\mathbf{F}_\tau)$ , and for  $n \gg 0$  the curve  $\ell_n$  is contained in a repelling petal between  $\mathbf{H}^{-1}$  and  $\mathbf{H}^0$

*Proof of the claim.* Note that  $(-1/4, 1/4) \subset \mathbb{R} \cap \mathbb{P}$  is  $p_{1/4}$ -invariant and connects  $\alpha(p_{1/4})$  and  $\alpha(1/2, p_{1/4})$ . Let  $\beta'_{+,n}$  be the unique geodesic in  $p_{1/4}^{-n+1}((-1/4, 1/4))$  connecting  $\alpha(1/2^n, p_{1/4})$  and  $\alpha(p_{1/4})$ . Set  $\beta_{+,n} := \mathbf{h}_0^{-1}(\beta'_{+,n})$ . Similarly, let  $\beta'_{-,n}$  be the unique geodesic in  $p_{1/4}^{-n+1}((-1/4, 1/4))$  connecting  $\alpha((2^n - 1)/2^n, p_{1/4})$  and  $\alpha(p_{1/4})$ ; set  $\beta_{-,n} := \mathbf{h}_{-1}^{-1}(\beta'_{-,n})$ .

Define  $\mathcal{O}_n$  to be the open disk bounded by  $\beta_{-,n} \cup \ell_n \cup \beta_{+,n}$  and containing a small repelling petal between  $\mathbf{H}^{-1}$  and  $\mathbf{H}^0$ . Then  $\mathcal{O}_{n+1} \subset \mathcal{O}_n$  and we claim that  $\mathbf{F}_\tau^{Q(\tau)}$  maps  $\mathcal{O}_{n+1}$  univalently onto  $\mathcal{O}_n$ . Indeed,  $\mathbf{F}_\tau^{Q(\tau)}$  maps  $\beta_{-,n+1}$  and  $\beta_{+,n+1}$  to  $\beta_{-,n}$  and  $\beta_{+,n}$ . Since  $\mathcal{O}_n$  does not contain any critical values of  $\mathbf{F}_\tau^{Q(\tau)}$ , the lift of  $\mathcal{O}_n$  attached to  $\beta_{-,n+1}$  and  $\beta_{+,n+1}$  is attached to the unique lift  $\tilde{\ell}_{n+1}$  of  $\ell_n$ . Then  $\tilde{\ell}_{n+1}$  connects  $\alpha(\mathbf{H}^0, 1/2^n)$  and  $\alpha(\mathbf{H}^{-1}, (2^n - 1)/2^n)$ ; since  $\mathbf{Esc}_{(n+1)Q(\tau)}$  is uniquely geodesic, we obtain  $\tilde{\ell}_{n+1} = \ell_{n+1}$ .

Note that between  $\mathbf{H}^{-1}$  and  $\mathbf{H}^0$  there is a repelling petal  $\mathbf{P}^{-1}$  emerging from  $\alpha$ ; this repelling petal is obtained from lifting the repelling petal of  $\alpha(f_\tau)$  between  $\mathbf{H}^{-1}$  and  $\mathbf{H}^0$ . Let  $(y_n)_{n \geq 0}$  with  $\mathbf{F}_\tau^{Q(\tau)}(y_{n+1}) = y_n \in \mathbf{X} \cap \mathcal{O}_n$  be the orbit emerging from  $\alpha(\mathbf{F}_\tau)$  in  $\mathbf{P}^{-1}$ . Connect  $\ell_{n+1}$  and  $y_{n+1}$  by a curve in  $\mathcal{O}_n \cap \mathbf{X}$ ; then the lift of

this curve is a curve connecting  $\ell_{n+2}$  and  $y_{n+2}$ . Since  $\mathbf{F}_\tau^{Q(\tau)}$  expands the hyperbolic metric of  $\mathbf{X}$  (see (7.5)), and since  $\ell_n \subset \mathbf{X}$ , we obtain that  $\ell_n$  shrinks to  $\alpha(\mathbf{F}_\tau)$ .  $\square$

Since  $\mathbf{Esc}(\mathbf{F}_\tau)$  is uniquely geodesic, there is a unique geodesic  $[b_n, a_{n+1}] \subset \mathbf{Esc}(\mathbf{F}_\tau)$  connecting  $\ell_n$  and  $\ell_{n+1}$ . (In fact,  $b_n = \alpha(1/2^n, \mathbf{H}^0)$  and  $a_n = \alpha((2^n - 1)/2^n, \mathbf{H}^{-1})$ , see Figure 33.) Then  $\mathbf{F}_\tau^{Q(\tau)}$  maps  $[b_{n+1}, b_{n+2}]$  to  $[b_n, b_{n+1}]$ . Since  $\mathbf{F}_\tau^{Q(\tau)}$  is expanding (see (7.5)),  $[b_n, b_{n+1}]$  shrinks to  $\alpha(\mathbf{F}_\tau)$ . We obtain that

$$\mathbf{R}^{-1} := (\infty, b_1] \bigcup_{n \geq 0} [b_n, b_{n+1}]$$

is a periodic ray landing between  $\mathbf{H}^{-1}$  and  $\mathbf{H}^0$ .

Similarly, there is a periodic ray  $\mathbf{R}^i$  landing at  $\alpha(\mathbf{F}_\tau)$  between  $\mathbf{H}^i$  and  $\mathbf{H}^{i+1}$ . The rays  $(\mathbf{R}^i)_i$  form a periodic cycle.

Let  $\mathbf{W}(i) \supset \mathbf{H}^i$  be the puzzle piece bounded by  $\mathbf{R}^i \cup \mathbf{R}^{i+1}$ . Recall (3.14) that for every  $\mathbf{H}^i$  there is a unique  $P \in \mathbb{T}$  such that  $\mathbf{F}_\tau^P: \mathbf{H}^0 \rightarrow \mathbf{H}^i$  is a conformal map.

*Claim 3:* the conformal map  $\mathbf{F}_\tau^P: \mathbf{H}^0 \rightarrow \mathbf{H}^i$  extends to a conformal map  $\mathbf{F}_\tau^P: \mathbf{W}(0) \rightarrow \mathbf{W}(i)$ . Moreover,  $\mathbf{R}^{-1}$  and  $\mathbf{R}^0$  meet at  $\alpha(\mathbf{H}^0, 1/2)$ .

*Proof of the Claim.* The critical values of  $\mathbf{F}_\tau^P$  are exactly

$$\{\mathbf{F}_\tau^Q(0) \mid Q < P\} \subset \bigcup_{Q < P} \mathbf{F}_\tau^Q(\mathbf{H}^0)$$

and this set is disjoint from  $\mathbf{W}(i)$ . Therefore,  $\mathbf{W}(0)$  is the conformal pullback of  $\mathbf{W}(i)$  along  $\mathbf{F}_\tau^P: \mathbf{H}^0 \rightarrow \mathbf{H}^i$ . This shows the first claim

For every  $S < Q(\tau)$  there is an  $i \in \mathbb{Z}$  such that  $\mathbf{F}_\tau^S: \mathbf{W}(0) \rightarrow \mathbf{W}(i)$  is conformal. Therefore,  $\alpha(\mathbf{H}^i) = \mathbf{F}_\tau^S(\alpha(\mathbf{H}^0))$  and we see that the generation of  $\alpha(\mathbf{H}^0, 1/2)$  is exactly  $Q(\tau)$ . This also implies that  $\alpha(\mathbf{H}^0, 1/2)$  has the smallest generation among all the preimages of  $\alpha(\mathbf{F}_\tau)$  in  $\mathbf{W}(0)$ . If  $\alpha_-$  and  $\alpha_+$  are alpha-points in  $\mathbf{R}^{-1} \setminus \mathbf{R}^0$  and  $\mathbf{R}^0 \setminus \mathbf{R}^{-1}$  respectively, then  $\alpha_-$  and  $\alpha_+$  are  $\prec$ -separated by  $\alpha(\mathbf{H}^0, 1/2)$  (see §5.7). By Corollary 5.27,  $\mathbf{R}^0 \cap \mathbf{R}^{-1} = [\alpha(\mathbf{H}^0, 1/2), \infty)$ .  $\square$

Since  $\mathbf{W}(0)$  contains a unique critical value of  $\mathbf{F}_\tau^{Q(\tau)}$ , pulling back  $\mathbf{W}(0)$  we obtain the two-to-one map (7.4).

By a standard puzzle argument,  $\partial\mathbf{H}^i$  is a simple arc. Indeed, every alpha-point  $\alpha(t, \mathbf{H}^i)$  is accessible from the interior and the exterior of  $\mathbf{H}^i$ . We can cover  $\partial\mathbf{H}^i$  by closed topological disks  $(D_j)_{j \in \mathbb{Z}}$  with disjoint interiors whose boundaries intersect  $\partial\mathbf{H}^i$  at exactly two alpha-points: for  $j < 0$  the disk  $D_j$  intersects  $\partial\mathbf{H}^0$  at  $\alpha(2^j)$  and  $\alpha(2^{j-1})$ , and for  $j \geq 0$  the disk  $D_j$  intersects  $\partial\mathbf{H}^0$  at  $\alpha(1 - 1/2^{j+1})$  and  $\alpha(1 - 1/2^{j+2})$ . Moreover, we can assume that  $D_j$  is disjoint from the postcritical set. Taking preimages, we obtain a systems of disks  $(D_\eta)_\eta$ ; every  $D_\eta$  still intersects  $\partial\mathbf{H}^0$  at exactly two alpha-points. By expansion §7.1.1, for every  $x \in \partial\mathbf{H}^i$  there is a sequence of disks  $D_{i,x} \ni x$  as above shrinking to  $x$ . This implies that  $\partial\mathbf{H}^0$  is a simple arc, [Na, Theorems 6.16 and 6.17].

Note that  $\overline{\mathbf{H}}^0$  is the non-escaping set of  $\mathbf{F}_\tau^{Q(\tau)}: \mathbf{W}^1 \rightarrow \mathbf{W}$ . Therefore, the escaping set intersects  $\partial\mathbf{H}^i$  at alpha-points. This implies that  $\mathbf{H}^i \cap \mathbf{R}^k \cap \mathbf{H}^j = \emptyset$  for all  $i \neq j$  and all  $k$ . Since  $\mathbf{H}^i$  and  $\mathbf{H}^j$  are in different puzzle pieces,  $\mathbf{H}^i \cap \mathbf{H}^j = \emptyset$  if  $i \neq j$ .  $\square$

We will show in Lemma 8.8 that every  $z \in \mathbb{C}$  is contained in some puzzle piece  $\mathbf{W}(i)$ .

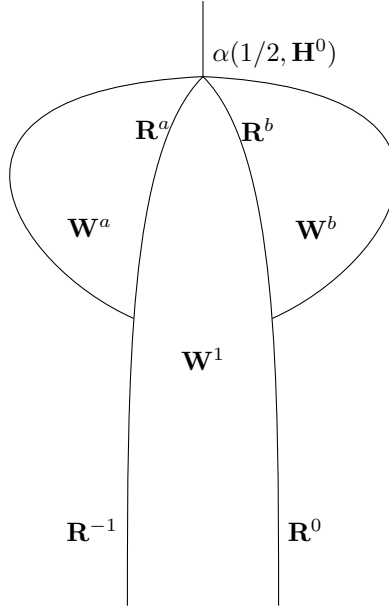

FIGURE 34. The decomposition of  $\mathbf{W} = \mathbf{W}^1 \cup \mathbf{W}^a \cup \mathbf{W}^b$ . The rays  $\mathbf{R}^a$  and  $\mathbf{R}^b$  land at  $\alpha(1/2, \mathbf{H}^0)$  and bound puzzle pieces  $\mathbf{W}^a$  and  $\mathbf{W}^b$ . Compare with Figure 32.

## 7.2. Properties of $\mathbf{W}(i)$ .

**Lemma 7.3** (Decomposition  $\mathbf{W} = \mathbf{W}^1 \cup \mathbf{W}^a \cup \mathbf{W}^b$ ). *The puzzle piece  $\mathbf{W}^1$  is bounded by 4 external rays; two of them are  $\mathbf{R}^{-1}$  and  $\mathbf{R}^0$ , we denote the other two by  $\mathbf{R}^a$  and  $\mathbf{R}^b$ , see Figure 34. The ray  $\mathbf{R}^a$  lands at  $\alpha(1/2, \mathbf{H}^0) \in \mathbf{R}^a$  and surrounds a puzzle piece  $\mathbf{W}^a$ . Similarly,  $\mathbf{R}^b$  lands at  $\alpha(1/2, \mathbf{H}^0) \in \mathbf{R}^b$  and surrounds a puzzle piece  $\mathbf{W}^b$ . The puzzle pieces  $\mathbf{W}^1, \mathbf{W}^a, \mathbf{W}^b$  have pairwise disjoint interiors, and we have  $\mathbf{W} = \mathbf{W}^1 \cup \mathbf{W}^a \cup \mathbf{W}^b$ . The map  $\mathbf{F}_\tau^{Q(\tau)}$  maps univalently  $\text{int } \mathbf{W}^a$  and  $\text{int } \mathbf{W}^b$  to two different connected components of  $\mathbb{C} \setminus (\mathbf{W} \cup \mathbf{R}^0)$ .*

*Proof.* Since  $\mathbf{F}_\tau^{Q(\tau)}: \mathbf{W}^1 \rightarrow \mathbf{W}$  is two-to-one, the puzzle piece  $\mathbf{W}^1$  is bounded by 4 rays  $\mathbf{R}^{-1}, \mathbf{R}^a, \mathbf{R}^b, \mathbf{R}^0$ , where  $\mathbf{R}^{-1}, \mathbf{R}^b$  are preimages of  $\mathbf{R}^{-1}$  while  $\mathbf{R}^a, \mathbf{R}^0$  are preimages of  $\mathbf{R}^0$ . Since  $\mathbf{R}^{-1}, \mathbf{R}^0$  land at  $\alpha$ , we obtain that  $\mathbf{R}^a$  and  $\mathbf{R}^b$  land at  $\alpha(1/2, \mathbf{H}^0)$ . As a consequence,  $\mathbf{R}^a$  and  $\mathbf{R}^b$  bound puzzle pieces  $\mathbf{W}^a$  and  $\mathbf{W}^b$ .

Observe that  $\mathbf{R}^{-1}$  and  $\mathbf{R}^a$  meet at  $\alpha(1/4, \mathbf{H}^0)$  while  $\mathbf{R}^0$  and  $\mathbf{R}^b$  meet at  $\alpha(3/4, \mathbf{H}^0)$ . This implies that  $\mathbf{W} = \mathbf{W}^1 \cup \mathbf{W}^a \cup \mathbf{W}^b$  and  $\mathbf{F}_\tau^{Q(\tau)}$  maps  $\text{int } \mathbf{W}^a \cup \text{int } \mathbf{W}^b$  to  $\mathbb{C} \setminus (\mathbf{W} \cup \mathbf{R}^0)$  as required.  $\square$

Fix an open neighborhood  $\mathcal{O} := \mathbb{D}(\eta)$  of  $\mathbf{F}_\star$  containing  $\mathbf{F}_\tau$ . Recall from §5.2 that  $c_s(\mathbf{F}_\star) \in \mathbf{F}_\star^{-S}(0)$  denotes the unique critical point in  $\partial \mathbf{Z}_\star$  of generation  $S$ . By Lemma 4.4,  $\mathbf{G}^P(0)$  does not collide with 0 for small  $P$  and for  $\mathbf{G} \in \mathcal{O}$ . Therefore, for small  $P$  the set  $\bigcup_{S \leq P} \mathbf{G}^{-S}(0)$  moves holomorphically with  $\mathbf{G} \in \mathcal{O}$ . For  $\mathbf{G} \in \mathcal{O}$ , we denote by  $c_S(\mathbf{G})$  the image of  $c_S(\mathbf{F}_\star)$  under the holomorphic motion.

For every  $S < Q(\tau)$ , there is a unique  $i = i(S)$  such that  $\mathbf{F}_\tau^{Q(\tau)-S}$  maps univalently  $\mathbf{W}$  onto  $\mathbf{W}(i)$ . We set  $\mathbf{W}^1(i) := \mathbf{F}_\tau^{Q(\tau)-S}(\mathbf{W}^1)$ . Then

$$(7.6) \quad \mathbf{F}_\tau^S: \mathbf{W}^1(i(S)) \rightarrow \mathbf{W}$$

is a two-to-one map.

**Lemma 7.4.** *For a small  $S > 0$ , the point  $c_S(\mathbf{F}_\tau)$  is the unique critical point of (7.6).*

*Proof.* The proof will be similar to the argument in Claim 1 of the proof of Theorem 7.2. Applying  $\mathcal{R}$ , we can assume that  $\mathbf{F}_\tau$  is in a small neighborhood  $\mathcal{O}$  of  $\mathbf{F}_*$ . For  $\mathbf{G} \in \mathcal{O}$ , denote by  $L_g$  the unique affine map mapping  $\alpha(f_*)$  and  $c_1(f_*)$  to  $\alpha(g)$  and  $c_1(g)$  respectively.

Let  $J(f_*) : (0, 1) \rightarrow Z_*$  be a simple arc connecting the critical value  $c_1(f_*)$  and  $\alpha$  (i.e.  $J$  lands at  $c_1$  and  $\alpha$ ) such that

- (1)  $L_{f_*}(J(f_*))$  intersected with a small neighborhood of  $\alpha(f_\tau)$  is within  $H^0$ ; and
- (2)  $J(f_*) \subset V \setminus \gamma_1$ , possibly up to a slight rotation of  $\gamma_1$ .

Let  $\mathbf{J}_0(\mathbf{F}_*)$  be the lift of  $J(f_*)$  via  $\mathbf{S} \simeq V \setminus \gamma_1$ . Then  $\mathbf{J}_0(\mathbf{F}_*)$  is an arc connecting from 0 and  $\alpha$  such that  $\mathbf{J}_0 \subset \mathbf{Z}_*$ . For  $g$  close to  $f_*$ , we set  $J(g) := L_g(J(f_*))$ . And we define  $\mathbf{J}_0(\mathbf{G})$  to be the lift of  $J(g)$  via  $\mathbf{S} \simeq V \setminus \gamma_1$ . We obtain a holomorphic motion of  $\mathbf{J}_0(\mathbf{G})$  in  $\mathcal{O}$ . By (4.10),  $\mathbf{J}_0(\mathbf{G})$  does not collide with  $\text{CV}(\mathbf{G}^P)$  for a small  $P$ . Therefore, we also have a holomorphic motion of

$$\tilde{\mathbf{J}}(\mathbf{G}) := \bigcup_{S \leq P} \mathbf{G}^{-S}(\mathbf{J}_0(\mathbf{G})).$$

By Lemma 5.12, there is a unique lift  $\mathbf{J}_S(\mathbf{F}_*) \subset \tilde{\mathbf{J}}$  of  $\mathbf{J}_0(\mathbf{F}_*)$  under  $\mathbf{F}_*^S$  such that  $\mathbf{J}_S$  ends at  $\alpha$ , where  $S$  is small. Moreover,  $\mathbf{J}_S(\mathbf{F}_*) \subset \mathbf{Z}_*$  and  $\mathbf{J}_S(\mathbf{F}_*)$  starts at  $c_S$ . Let  $\mathbf{J}_S(\mathbf{F}_\tau)$  be the image of  $\mathbf{J}_S(\mathbf{F}_*)$  under the holomorphic motion. We need to show that  $\mathbf{J}_S(\mathbf{F}_\tau)$  starts at the unique critical point of (7.6). This follows from the following claim (using the homotopy lifting property).

*Claim.* Let  $N$  be a small neighborhood of  $\alpha \cup \{0\}$ . For a small  $S > 0$  the arc  $\mathbf{J}_0(\mathbf{F}_\tau)$  is homotopic rel  $N \cup \text{CV}(\mathbf{F}_\tau^S)$  to a curve within  $\mathbf{W}$ .

*Proof of the Claim.* It follows from Condition (1) that  $\mathbf{J}_S(\mathbf{F}_\tau) \cap N \subset \mathbf{W}$  for a small neighborhood  $N$  of  $\alpha \cup \{0\}$ . Let  $\mathbf{J}'_S$  be a simple arc in  $\mathbf{W}$  such that  $\mathbf{J}'_S \cap N = \mathbf{J}_S \cap N$ . For a small  $S$ , the set  $\text{CV}(\mathbf{F}_\tau^S) \setminus \{0\}$  is far from 0, thus  $\mathbf{J}_S$  is homotopic to  $\mathbf{J}'_S$  as required.  $\square$

$\square$

**7.3. Secondary parabolic prepacman  $\mathbf{F}_{\tau, s}$ .** Since  $f_\tau$  has  $q$  attracting petals at  $\alpha$ , there is a small neighborhood  $\mathcal{U}$  of  $f_\tau$  such that  $\alpha(f_\tau)$  splits into the fixed point  $\alpha(g)$  and a  $q$ -periodic cycle  $\gamma(g)$  for  $g \in \mathcal{U} \setminus \{f_\tau\}$ . Moreover, we can assume that the multiplier of  $\gamma(g)$  parametrizes  $\mathcal{U}$ , possibly by shrinking  $\mathcal{U}$ . We also denote by

$$\mathcal{U} := \{\mathbf{G} \mid g \in \mathcal{U}\} \subset \mathcal{W}^u$$

the corresponding neighborhood of  $\mathbf{F}_\tau$ .

For  $\mathbf{G} \in \mathcal{U}$  we denote by  $\gamma(\mathbf{G})$  the full lift of  $\gamma(g)$  to the dynamical plane of  $\mathbf{G}$ . More precisely, choose a point  $\gamma_0$  in  $\gamma(g)$  and let  $\gamma_0(\mathbf{G})$  be the lift of  $\gamma_0(g)$  to  $\mathbf{S} \simeq V \setminus \gamma_1$ . Then  $\gamma(\mathbf{G})$  is the full orbit of  $\gamma_0$ . Every point in  $\gamma(\mathbf{G})$  is  $Q(\tau)$ -periodic.

Let us consider a path  $g_t \in \mathcal{U}$  with  $t \geq 0$  emerging from  $f_\tau = g_0$  such that  $\gamma(g_t)$  is attracting and  $\alpha(g_t)$  is on the boundary of the immediate attracting basin of  $\gamma(g_t)$  for  $t > 0$ . All  $\mathbf{G}_t$  with  $t > 0$  are conjugate by qc maps that are conformal on the Julia sets. We denote by  $\Delta_\tau$  the set of  $\mathbf{G} \in \mathcal{W}^u$  obtained by a qc deformation of  $\mathbf{G}_t$  changing the multiplier of  $\gamma$ , see §4.10. We say that  $\Delta_\tau$  is the *primary satellite hyperbolic component attached to  $\mathbf{F}_\tau$* .

By appropriately shrinking  $\mathcal{U}$  (and respectively  $\mathcal{U}$ ) we can assume that the set of pacmen  $g \in \mathcal{U}$  with non-repelling  $\gamma(g)$  is connected. In particular, every  $g \in \mathcal{U}$  with attracting  $\gamma(g)$  is contained in  $\Delta_\tau$ .

Consider a rational number  $\mathfrak{s} = \mathfrak{p}_\mathfrak{s}/\mathfrak{q}_\mathfrak{s} > 0$ . If  $\mathfrak{s}$  is close to 0, then there is a unique parabolic prepacman  $\mathbf{F}_{\tau,\mathfrak{s}} \in \mathcal{U} \cap \partial\Delta_\tau$  such that the multiplier of  $\gamma(f_{\tau,\mathfrak{s}})$  is  $\mathbf{e}(\mathfrak{s})$ .

Consider a point  $\gamma_0$  in the periodic cycle  $\gamma(\mathbf{F}_{\tau,\mathfrak{s}})$ . An *attracting flower* at  $\gamma_0$  is an open set  $\Upsilon_0$  such that

- $\Upsilon_0 \cup \{\gamma_0\}$  is connected;
- $\mathbf{F}_{\tau,\mathfrak{s}}^{Q(\tau)}(\Upsilon_0) \subset \Upsilon_0$ ; and
- all points in  $\Upsilon_0$  are attracted by  $\gamma_0$  under the iterations of  $\mathbf{F}_{\tau,\mathfrak{s}}^{Q(\tau)}$ .

A connected component of  $\Upsilon_0$  is called a *petal*. Petals are permuted by  $\mathbf{F}_{\tau,\mathfrak{s}}^{Q(\tau)}$  and every petal is  $Q(\tau, \mathfrak{s}) := \mathfrak{q}_\mathfrak{s}Q(\tau)$  periodic. The flower  $\Upsilon_0$  contains  $m\mathfrak{q}_\mathfrak{s}$  petals; we will show in Lemma 7.5 that  $m = 1$ .

We denote by  $\mathbf{H}$  the full orbit of  $\Upsilon_0$ . Clearly, every connected component of  $\mathbf{H}$  is a Fatou component, see Figure 35.

**Lemma 7.5.** *The set  $\mathbf{H}$  has a periodic component  $\mathbf{H}^0$  containing 0. Moreover,  $\mathbf{H}$  has a unique cycle of periodic components.*

*By re-enumerating points in  $\gamma$ , we assume that  $\mathbf{H}^0$  is attached to  $\gamma_0 \in \gamma$ . There are  $\mathfrak{q}_\mathfrak{s}$  components  $\mathbf{H}^0, \mathbf{H}^1, \dots, \mathbf{H}^{\mathfrak{q}_\mathfrak{s}-1}$  of  $\mathbf{H}$  such that  $\mathbf{H}^i$  are attached to  $\gamma_0$  counting counterclockwise. The components  $\mathbf{H}^i$  are cyclically  $\mathfrak{p}_\mathfrak{s}/\mathfrak{q}_\mathfrak{s}$ -permuted under  $\mathbf{F}_{\tau,\mathfrak{s}}^{Q(\tau)}$ .*

*Proof.* Follows from a classical argument. Let  $\mathbf{H}'$  be a periodic component of  $\mathbf{H}$ . If the forward orbit of  $\mathbf{H}'$  does not contain 0, then the local Fatou coordinates of  $\mathbf{H}'$  can be extended to a conformal map between  $\mathbf{H}'$  and  $\mathbb{C}$ . This contradicts to  $\mathbf{H}' \subsetneq \mathbb{C}$ .

As a consequence,  $\mathbf{H}$  has a unique cycle of periodic components. The second statement follows from the fact that  $\mathbf{e}(\mathfrak{s})$  is the multiplier of  $\gamma$ .  $\square$

#### 7.4. Landing of dynamic rays.

**Theorem 7.6.** *Suppose  $\mathbf{G} \in \mathcal{W}^u$  has a repelling or attracting periodic point  $x_0 \in \mathbb{C}$  and suppose that  $\alpha(g)$  is repelling. Then every rational ray of  $\mathbf{G}$  lands.*

*Proof.* Consider a rational ray  $\mathbf{R}$ . Let us first give a sketch of the argument. If  $\mathbf{R}$  does not go to infinity, then  $\mathbf{R}$  lands by the expansion of  $\mathbf{G}$ . The infinity in  $\mathbb{C} \setminus \Delta_0$  is blocked by another periodic ray cycle (the red cycle in Figure 36) that exists in a neighborhood of  $\mathbf{F}_*$ . Since  $(\mathbf{g}_-, \mathbf{g}_+) \mid \Delta_0$  is a pair of almost translations, if  $\mathbf{R}$  goes to infinity in  $\Delta_0$ , then  $\mathbf{R}$  tends to  $\alpha$ ; in this case  $\mathbf{R}$  lands at  $\alpha$ .

We assume that  $x_0$  is parabolic; the case when  $x_0$  is attracting is similar. Denote by  $\mathfrak{x}$  the periodic cycle of  $x_0$ . Let  $\mathbf{H}$  be the attracting basin of  $\mathfrak{x}$ . Since the Fatou coordinates in  $\mathbf{H}$  capture critical points of  $\mathbf{G}^{\geq 0}$ , there is a unique periodic

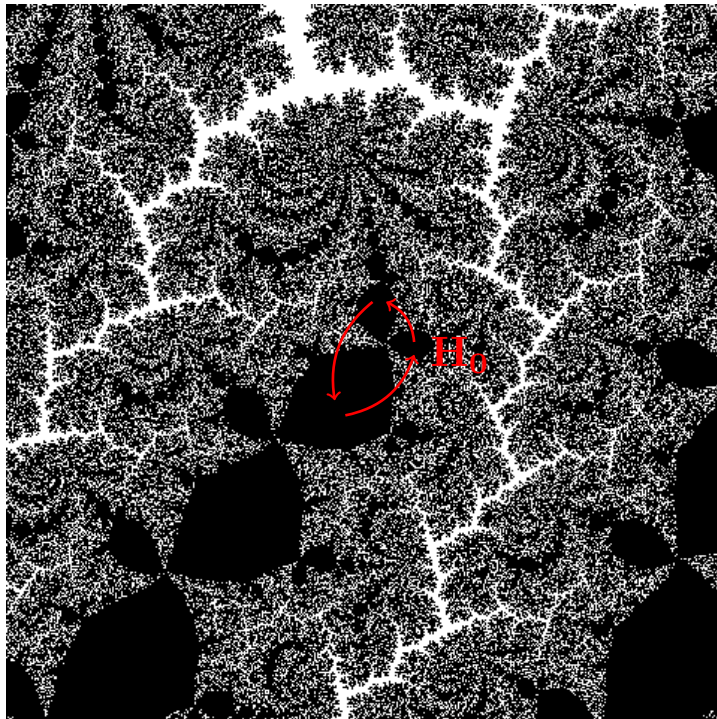
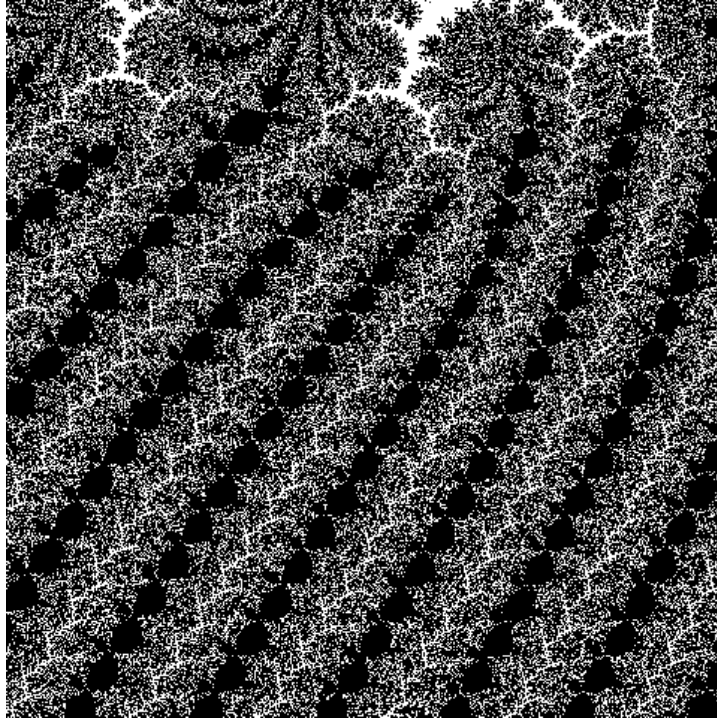

FIGURE 35. The Rabbit maximal prepacman. There are three Fatou components attached to  $\gamma_0$ . These components are cyclically permuted under the first return map. Note that there is a spiraling at the  $\alpha = "-\infty i"$ -fixed point.



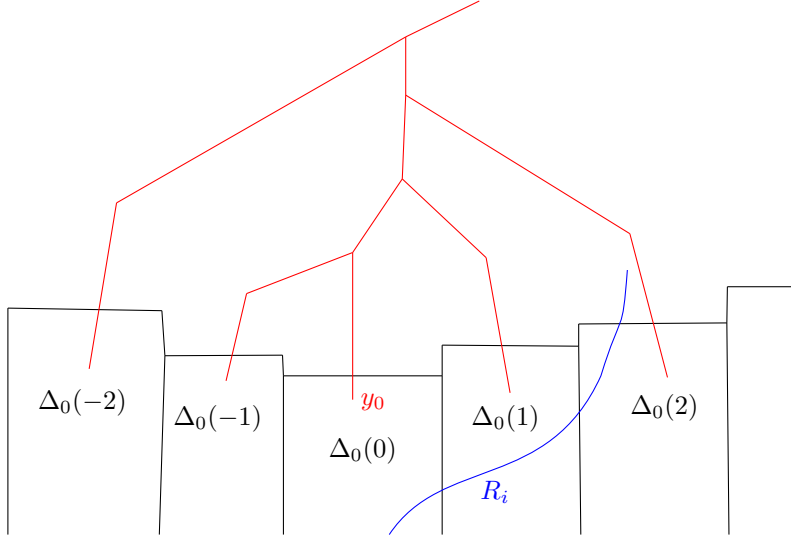

FIGURE 36. Illustration to the proof of Theorem 7.6. The cycle of periodic rays  $R_y$  (red) lands at a repelling periodic cycle  $y$  that is within the triangulation  $\Delta_0$ . The ray segment  $R_i$  (blue) does not intersect  $R_y$ . Either the hyperbolic diameter of  $R_i$  decreases, or  $R_i$  shrinks to the cycle  $y$ , or  $R_i$  tends to  $\alpha$ .

component  $\mathbf{H}^0$  of  $\mathbf{H}$  containing 0. By re-enumerating points in  $\mathfrak{x}$ , we can assume that  $\mathbf{H}^0$  is attached to  $x_0$ .

By Lemma 7.1, the first return map  $\mathbf{G}: \mathbf{H}^0 \rightarrow \mathbf{H}^0$  is conformally conjugate to  $p_{1/4}: \mathbb{P} \rightarrow \mathbb{P}$ , say via  $\mathbf{h}_0: \mathbf{H}^0 \rightarrow \mathbb{P}$  (compare with §7.1), where  $p_{1/4}(z) = z^2 + 1/4$  and  $\mathbb{P}$  is the attracting basin of  $\alpha(p_{1/4})$ . As in §7.1.1, let  $B \subset \mathbb{P}$  be a forward invariant open topological disk containing  $[1/4, 1/2)$  such that  $\overline{B}$  is a closed topological disk with

$$\partial B \cap p_c(\overline{B}) = \alpha(p_{1/4}) = \overline{B} \cap \partial \mathbb{P}.$$

Set  $\mathbb{B}^0 := \mathbf{h}_0^{-1}(B)$ ; spreading around  $\overline{\mathbb{B}^0}$ , we obtain

$$\mathbb{B} := \bigcup_{P \geq 0} \mathbf{G}^P(\overline{\mathbb{B}^0}) \subset \mathbf{H} \cup \mathfrak{x}.$$

Consider the hyperbolic surface  $\mathbf{X} := \mathbb{C} \setminus \mathbb{B}$ . Since  $\mathbb{B}$  contains the postcritical set  $\mathfrak{P}(\mathbf{G})$ , we have  $\mathbf{G}^{-T}(\mathbf{X}) \subsetneq \mathbf{X}$  and

$$\mathbf{G}^T: \mathbf{G}^{-T}(\mathbf{X}) \rightarrow \mathbf{X}$$

expands the hyperbolic metric of  $\mathbf{X}$  for all  $T \in \mathbb{T}_{>0}$ .

Let assume that the rational ray  $\mathbf{R}$  is periodic with period  $N \in \mathbb{T}$ ; the preperiodic case follows from the periodic case. Let us decompose  $\mathbf{R}$  as a concatenation of ray segments

$$\cdots \cup \mathbf{R}_2 \cup \mathbf{R}_1 \cup \mathbf{R}_0$$

such that  $\mathbf{G}^N$  maps  $\mathbf{R}_{i-1}$  to  $\mathbf{R}_i$ .

Consider a renormalization triangulation  $\Delta_0(\mathbf{F}_\star)$  and choose a periodic repelling point  $y_0 \in \Delta_0(0, 1)$  such that  $y_0$  does not escape  $\Delta_0(0, 1)$  under

$$\mathbf{F}_\star^{A_0} : \Delta_0(0) \rightarrow \mathbf{S}, \quad \mathbf{F}_\star^{B_0} : \Delta_0(1) \rightarrow \mathbf{S}.$$

(To existence of  $y_0$  follows from the existence of a periodic point  $y'_0$  in the dynamical plane of  $f_\star$ , see §3.2.5; then  $y_0$  is the lift of  $y'_0$ .) Let  $\mathfrak{y}(\mathbf{F}_\star) := \bigcup_{P \geq 0} \mathbf{F}_\star^P \{y_0\}$  be the periodic cycle of  $y_0$ . By Corollary 5.35, there is a cycle of periodic rays  $\mathbf{R}_\mathfrak{y}$  landing at  $\mathfrak{y}(\mathbf{F}_\star)$ , see Figure 36.

Since the landing of a periodic ray at a repelling periodic point is stable, there is a neighborhood  $\mathcal{Y}$  of  $\mathbf{F}_\star$  such that

- $\overline{\mathbf{R}_\mathfrak{y}}(\mathbf{G})$  exists and depends continuously on  $\mathbf{G} \in \mathcal{Y}$ ; and
- $\mathfrak{y} \in \Delta_0(\mathbf{G})$  for all  $\mathbf{G} \in \mathcal{Y}$  we have.

By replacing  $\mathbf{G}$  with its antirenormalization, we can assume that  $\mathbf{G} \in \mathcal{Y}$ .

Choose a sufficiently big  $n \gg 0$  such that  $\mathbf{R}_n$  is disjoint from  $\mathbf{R}_\mathfrak{y}$ . (If  $\mathbf{R}_n$  intersects  $\mathbf{R}_\mathfrak{y}$  for all  $n$ , then  $\mathbf{R} \subset \mathbf{R}_\mathfrak{y}$  and the claim is trivial.) Let  $\mathbf{R}'_n$  be a rectifiable curve in  $\mathbf{X} \setminus \mathbf{R}_\mathfrak{y}$  connecting the endpoints of  $\mathbf{R}_n$  such that  $\mathbf{R}'_n$  is homotopic (in  $\mathbf{X} \setminus \mathbf{R}_\mathfrak{y}$ ) to  $\mathbf{R}_n$  rel the endpoints. For  $j \geq 0$  we define  $\mathbf{R}'_{n+j}$  to be the lift of  $\mathbf{R}'_n$  under  $\mathbf{G}^{jN}$  such that  $\mathbf{R}'_{n+j}$  connects the endpoints of  $\mathbf{R}_{n+j}$ . Clearly,  $|\mathbf{R}'_i| \leq |\mathbf{R}'_{i-1}|$ , where “ $|\cdot|$ ” denotes the hyperbolic length rel  $\mathbf{X}$ .

**Claim 1.** *There is a neighborhood  $\mathcal{O}$  of  $\alpha$  with the following property. If  $\mathbf{R}'_n \subset \mathcal{O}$  for some  $n$ , then  $\mathbf{R}$  lands at  $\alpha$ .*

*Proof.* Recall from §4.7 that  $\mathbb{C} \sqcup \{\alpha\}$  is endowed with the wall topology, where a neighborhood  $\mathcal{O}$  of  $\alpha(\mathbf{G})$  is the full lift of a neighborhood  $O$  of  $\alpha(f)$ . Since  $\alpha(f)$  is repelling, we can choose a small open disk  $O$  around  $\alpha(f)$  such that

- $\partial O$  intersects  $\gamma_0 \cup \gamma_1$  at two points; and
- $O_2 := f(O) \ni O$  and  $O_2$  also intersects  $\gamma_0 \cup \gamma_1$  at two points,

see Figure 37. The pair  $\gamma_0 \cup \gamma_1$  cuts  $O$  into two sectors. Lifting these sectors to the dynamical plane of  $\mathbf{G}$  and spreading the lifts around, we obtain a neighborhood  $\mathcal{O}$  of  $\alpha(\mathbf{G})$  such that  $\mathcal{O}$  is backward invariant. If  $\mathbf{R}'_n \subset \mathcal{O}$ , then  $\mathbf{R}'_{n+i} \subset \mathcal{O}$  for all  $i$ , and, moreover,  $\mathbf{R}'_m$  tends to  $\alpha$  as  $m \rightarrow +\infty$ .  $\square$

**Claim 2.** *Let  $\mathbf{M}$  be a sufficiently small neighborhood of  $\mathfrak{x} \cup \{\alpha\}$ . Then there is an  $\varepsilon > 0$  such that the following holds. If  $\mathbf{R}'_i$  intersects  $\Delta_0 \setminus \mathbf{M}$ , then*

$$|\mathbf{R}'_i| \leq \max \left\{ |\mathbf{R}'_{i-1}| - \varepsilon, \frac{|\mathbf{R}'_{i-1}|}{1 + \varepsilon} \right\}.$$

*Proof.* By increasing  $N$ , we can assume that  $N \geq 2 \max\{A_0, B_0\}$ . Choose a point  $z \in (\Delta_0 \setminus \mathbf{M}) \cap \mathbf{R}'_i$ . Let  $A \leq \max\{A_0, B_0\}$  be the first moment such that  $\mathbf{G}^A(z) \in \mathbf{S}$ .

If  $\mathbf{G}^A(z) \in \Delta_0(0, 1)$ , then either

$$\mathbf{f}_+ : \Delta_0(0) \rightarrow \mathbf{S} \quad \text{or} \quad \mathbf{f}_- : \Delta_0(1) \rightarrow \mathbf{S}$$

expands the hyperbolic length of  $\mathbf{G}^A(\mathbf{R}'_i)$ .

If  $\mathbf{G}^A(z) \in \mathbf{S} \setminus \Delta_0(0, 1)$ , then  $\mathbf{S} \setminus \Delta_0(0, 1) \subset \Delta_{-1}(0, 1)$  (see (4.9)), and either

$$\mathbf{f}_{-1,+}^\# : \Delta_{-1}(0) \rightarrow \mathbf{S}_{-1}^\# \quad \text{or} \quad \mathbf{f}_{-1,-}^\# : \Delta_{-1}(1) \rightarrow \mathbf{S}_{-1}^\#$$

expands the hyperbolic length of  $\mathbf{G}^A(\mathbf{R}'_i)$ .  $\square$

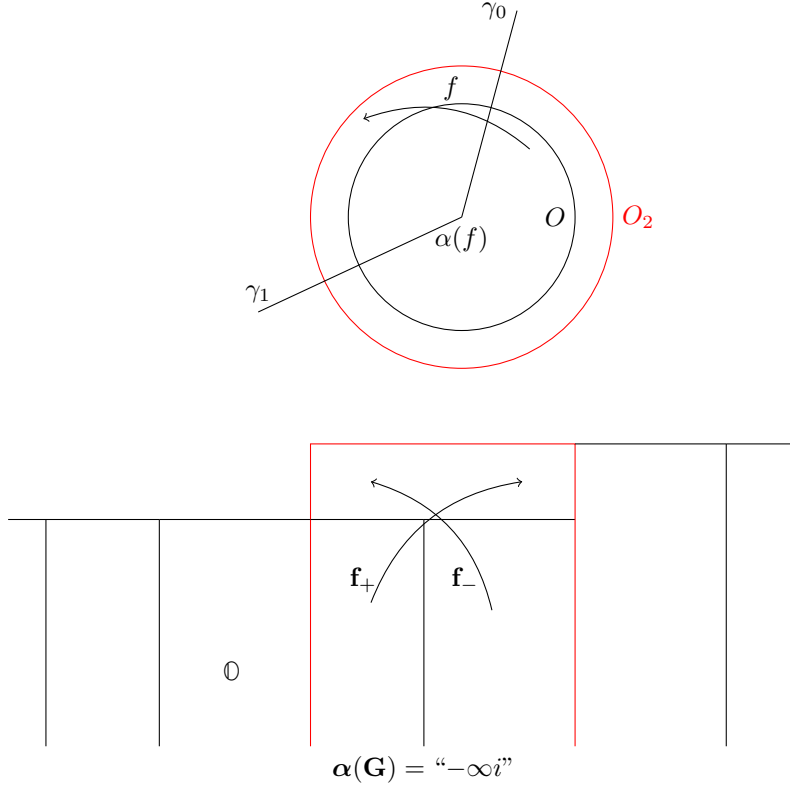

FIGURE 37. Top: a neighborhood  $O$  of  $\alpha(f)$  and its image  $O_2 := f(O)$ . Bottom: the neighborhood  $\mathcal{O}$  of  $\alpha(f)$  is obtained by lifting and spreading around  $O(f)$ . Note that the points in  $\mathcal{O}$  stay in  $\mathcal{O}$  under the backward iteration of the cascade  $\mathbf{G}^{\geq 0}$ .

As a consequence of Claim 2, either the diameters of the  $\mathbf{R}'_i$  shrink, or the  $\mathbf{R}'_i$  are eventually in  $\mathbb{C} \setminus (\Delta_0 \setminus \mathbf{M})$ . Suppose  $\mathbf{R}'_i \subset \mathbb{C} \setminus (\Delta_0 \setminus \mathbf{M})$  for all  $i \geq n$ . If  $\mathbf{R}'_n$  is in a small neighborhood of  $\alpha$ , then  $\mathbf{R}$  lands at  $\alpha$  by Claim 1. If  $\mathbf{R}'_n$  is in a small neighborhood of  $x$ , then  $\mathbf{R}$  lands at  $x$ . The remaining case is when all  $\mathbf{R}'_i$  are in some connected component of  $\mathbb{C} \setminus (\Delta_0 \cup \mathbf{R}_y)$  for all  $i \gg 0$ . Every connected component of  $\mathbb{C} \setminus (\Delta_0 \cup \mathbf{R}_y)$  is bounded; by hyperbolic contraction, the hyperbolic diameters of the  $\mathbf{R}'_i$  tend to 0.  $\square$

**Corollary 7.7.** *The primary renormalization map (7.4)*

$$(7.7) \quad \mathbf{G}^{Q(\mathbf{r})}: \mathbf{W}^1 \rightarrow \mathbf{W}.$$

*exists for all  $\mathbf{G}$  close to  $\mathbf{F}_{\mathbf{r},\mathbf{s}}$ . In particular,  $\mathbf{R}^{-1}(\mathbf{G})$  and  $\mathbf{R}^0(\mathbf{G})$  land at  $\alpha$ .*

*Proof.* In the dynamical plane of  $\mathbf{F}_{\mathbf{r},\mathbf{s}}$ , let us consider the cycle of rays from Theorem 7.2. By Theorem 7.6 the cycle  $(\mathbf{R}_i)$  lands at a periodic cycle of points  $\delta$ . We need to show that  $\delta = \alpha$ .

Observe that  $\delta \neq \gamma$  because the period  $Q(\mathbf{r},\mathbf{s})$  of repelling petals at  $\gamma$  is greater than the period  $Q(\mathbf{r})$  of  $(\mathbf{R}_i)_{i \in \mathbb{Z}}$ . Therefore,  $\delta$  is repelling. Since the landing at a repelling periodic cycle is stable under a small perturbation,  $(\mathbf{R}_i(\mathbf{G}))_{i \in \mathbb{Z}}$  lands

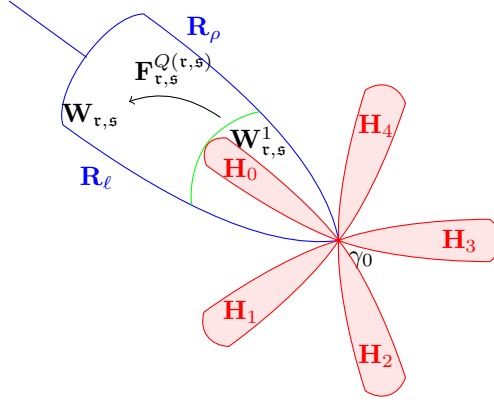

FIGURE 38. The secondary renormalization map  $\mathbf{F}_{\tau, s}^{Q(\tau, s)}: \mathbf{W}_{\tau, s}^1 \rightarrow \mathbf{W}_{\tau, s}$  in the dynamical plane of  $\mathbf{F} = \mathbf{F}_{\tau, s}$ . Petals in the attracting flower ( $\mathbf{H}_i$ ) around  $\gamma_0$  are enumerated counterclockwise so that  $\mathbf{H}_0 \ni 0$ . The puzzle piece  $\mathbf{W}_{\tau, s} \supset \mathbf{H}^0$  is bounded by the characteristic ray pair  $\mathbf{R}_\ell, \mathbf{R}_\rho$ . The puzzle piece  $\mathbf{W}_{\tau, s}^1$  is bounded by  $\mathbf{R}_\ell, \mathbf{R}_\rho$  and their preimages (marked green). When  $\gamma_0$  becomes repelling (for example if  $\mathbf{F} \in \Delta_{\tau, s}$ ), the secondary renormalization map can be thickened to a quadratic-like map.

at  $\delta(\mathbf{G})$  for  $\mathbf{G}$  in a small neighborhood of  $\mathbf{F}_{\tau, s}$ . We obtain that  $\delta(\mathbf{G}) = \alpha(\mathbf{G})$  for  $\mathbf{G} \in \Delta_\tau$ . Therefore,  $\delta(\mathbf{G}) = \alpha(\mathbf{G})$  for all  $\mathbf{G}$  close to  $\mathbf{F}_{\tau, s}$ , and (7.4) exists for all  $\mathbf{G}$  close to  $\mathbf{F}_{\tau, s}$ .  $\square$

Recall from Lemma 7.5 that  $\mathbf{H}^0$  denotes the periodic Fatou component of  $\mathbf{F}_{\tau, s}$  containing 0, and recall that  $\mathbf{H}^0$  is attached to  $\gamma_0$ , see Figure 38.

**Lemma 7.8.** *In the dynamical plane of  $\mathbf{F}_{\tau, s}$  there is a characteristic pair  $\mathbf{R}_\ell, \mathbf{R}_\rho$  of periodic rays landing at  $\gamma_0$ : it is the unique ray pair such that  $\overline{\mathbf{R}_\ell \cup \mathbf{R}_\rho}$  separates  $\mathbf{H}^0$  from all  $\mathbf{H}^i$  with  $i \neq 0$ .*

*Proof.* The parabolic point  $\gamma_0$  has exactly  $q_s$  local repelling petals, and we need to show that there is a periodic ray landing at every repelling petal of  $\gamma_0$ . Recall from Corollary 7.7 that the first renormalization map

$$(7.8) \quad \mathbf{F}_{\tau, s}^{Q(\tau)}: \mathbf{W}^1 \rightarrow \mathbf{W}$$

exists.

Denote by  $\mathfrak{X}$  the non-escaping set of (7.8), and note that  $\mathfrak{X}$  contains  $\gamma_0$ ,  $\mathbf{H}^0$ , and 0. Define inductively  $\mathbf{W}^{n+1}$  to be the unique degree two preimage of  $\mathbf{W}^n$  under (7.8). By induction (the case  $n = 1$  is in Lemma 7.3),  $\mathbf{W}^n \setminus \mathbf{W}^{n-1}$  consists of  $2^n$  connected components,  $\mathbf{W}^{n+1} \subset \mathbf{W}^n$ , and  $\bigcap_{n \geq 0} \mathbf{W}^n = \mathfrak{X}$ . Note that the

components of  $\mathbf{W} \setminus \mathbf{W}^1$  have bounded diameters with respect to the hyperbolic metric of  $\mathbb{C} \setminus \overline{\mathfrak{P}}(\mathbf{F}_{\tau, s})$ , see Figure 34. Since  $\mathbf{F}_{\tau, s}^{Q(\tau)}$  expands the hyperbolic metric of  $\mathbb{C} \setminus \overline{\mathfrak{P}}(\mathbf{F}_{\tau, s})$ , the spherical diameter of the components of  $\mathbf{W}^{n+1} \setminus \mathbf{W}^n$  tends to 0. Therefore, for every local repelling petal  $P$  of  $\gamma_0$ , there is a sequence  $\mathbf{T}_k \subset P$ ,  $k \gg 0$  shrinking to  $\gamma_0$  such that  $\mathbf{T}_k$  is a component of  $\mathbf{W}^k \setminus \mathbf{W}^{k-1}$  and  $\mathbf{F}_{\tau, s}^{Q(\tau, s)}$  maps

$\mathbf{T}_{k+1}$  to  $\mathbf{T}_k$ . This implies that there is a unique geodesic  $\mathbf{R}$  in the escaping set  $\mathbf{Esc}(\mathbf{F}_{\tau,s})$  intersecting every  $\mathbf{T}_k$ ; thus  $\mathbf{R}$  is a periodic ray landing in  $P$  and  $Q(\tau, s)$  is the minimal period of  $\mathbf{R}$ .  $\square$

We denote by  $\mathbf{W}_{\tau,s}$  the puzzle piece bounded by  $\mathbf{R}_\ell \cup \mathbf{R}_\rho$  and containing  $\mathbf{H}^0$ . Let  $\mathbf{W}_{\tau,s}^1 \subset \mathbf{W}_{\tau,s}$  be the two-to-one pullback of  $\mathbf{W}_{\tau,s}$  along  $\mathbf{F}_{\tau,s}^{Q(\tau,s)}: \mathbf{H}^0 \rightarrow \mathbf{H}^0$ . We call

$$(7.9) \quad \mathbf{F}_{\tau,t}^{Q(\tau,t)}: \mathbf{W}_{\tau,s}^1 \rightarrow \mathbf{W}_{\tau,s}$$

a *secondary renormalization map*.

**7.5. Secondary parabolic bifurcation.** Since  $\mathbf{F}_{\tau,s}$  has  $q_s$  attracting petals at every point of  $\gamma$ , there is a small neighborhood  $\mathcal{V}$  of  $\mathbf{F}_{\tau,s}$  such that  $\gamma(\mathbf{F}_{\tau,s})$  splits into the  $Q(\tau)$ -periodic cycle  $\gamma(\mathbf{G})$  and a  $Q(\tau, s)$ -periodic cycle  $\delta(\mathbf{G})$  for  $\mathbf{G} \in \mathcal{V} \setminus \{\mathbf{F}_{\tau,s}\}$ . By shrinking  $\mathcal{V}$ , we can assume that

- the multiplier of  $\delta(\mathbf{G})$  parametrizes  $\mathcal{V}$ ;
- the primary renormalization map (7.4) exists for all  $\mathbf{G} \in \mathcal{V}$  (by Corollary 7.7).

Moreover, there is a small path  $\mathbf{G}_t$ ,  $t \in [0, 1]$  emerging from  $\mathbf{F}_{\tau,s} = \mathbf{G}_0$  such that  $\delta(\mathbf{G}_t)$  is attracting and  $\gamma(\mathbf{G}_t)$  is on the boundary of an immediate attracting basin of  $\delta(\mathbf{G}_t)$  for all  $t \in (0, 1]$ . Moreover, we can assume that the characteristic ray pair  $\mathbf{R}_\ell(\mathbf{G}_t), \mathbf{R}_\rho(\mathbf{G}_t)$  lands at  $\gamma_0$  for all  $t > 0$ .

Since the escaping set  $\mathbf{Esc}(\mathbf{G})$  moves holomorphically for all  $\mathbf{G}$  in a small neighborhood of  $\{\mathbf{G}_t \mid t > 0\}$ , we obtain that all  $\mathbf{G}_t$  with  $t > 0$  are qc conjugate. We denote by  $\Delta_{\tau,s} \supset \{\mathbf{G}_t \mid t > 0\}$  the set of  $\mathbf{G} \in \mathcal{V}$  obtained through a qc-deformation changing the multiplier of  $\delta$ , see §4.10. By appropriately shrinking  $\mathcal{V}$ , we can also assume that  $\Delta_{\tau,s} \cap \mathcal{V}$  has a single connected component attached to  $\mathbf{F}_{\tau,s}$ , and:

$$(7.10) \quad \Delta_{\tau,s} \cap \mathcal{V} = \{\mathbf{G} \in \mathcal{V} : \delta(\mathbf{G}) \text{ is attracting}\}.$$

Since the rays  $\mathbf{R}_\ell$  and  $\mathbf{R}_\rho$  land at  $\gamma_0$  for all  $\mathbf{G} \in \Delta_{\tau,s}$ , the secondary renormalization (7.9)

$$(7.11) \quad \mathbf{G}^{Q(\tau,s)}: \mathbf{W}_{\tau,s}^1 \rightarrow \mathbf{W}_{\tau,s}$$

exists for  $\mathbf{G} \in \Delta_{\tau,s}$ .

**7.6. A ternary small copy  $\mathcal{M}_0$ .** Choose a rational number  $f = p_f/q_f$  close to 0 and let  $\mathbf{F}_{\tau,s,f} \in \partial\Delta_{\tau,s}$  be a parabolic prepacman such that the multiplier of  $\delta(\mathbf{F}_{\tau,s,f})$  is  $e(p_f/q_f)$ . By Theorem 7.6, rational rays land in the dynamical plane of  $\mathbf{F}_{\tau,s,f}$ . The same argument as in Corollary 7.7 shows that the secondary renormalization (7.11) exists in a small neighborhood  $\mathcal{W}$  of  $\mathbf{F}_{\tau,s,f}$ .

Observe that the secondary renormalization (7.11) can be slightly thickened to a quadratic-like map. Let  $\rho$  be the Douady-Hubbard straightening map associated with (7.11) ( $\rho$  is  $\chi$  from §3.1.1 appropriately restricted). Then  $\rho$  is a homeomorphism in a small neighborhood of  $\mathbf{F}_{\tau,s,f}$ . Observe that  $p_f := \rho(\mathbf{F}_{\tau,s,f})$  is the quadratic polynomial whose  $\alpha$ -fixed point has multiplier  $e(f)$ .

Choose  $\mathfrak{k} \in \mathbb{Q}$  close to  $f$ . By the Yoccoz inequality, the primary satellite small copy  $\mathcal{M}_{\mathfrak{k}}$  (see notations in §3.1.2) is in a small neighborhood of  $p_f$ . We obtain that  $\mathcal{M}_{\tau,s,\mathfrak{k}} := \rho^{-1}(\mathcal{M}_{\mathfrak{k}})$  is a small copy of the Mandelbrot set:

**Theorem 7.9.** *In a small neighborhood of  $\mathbf{F}_{\tau,s,f}$  there is a ternary satellite copy  $\mathcal{M}_0 = \mathcal{M}_{\tau,s,\mathfrak{k}}$  of the Mandelbrot set.*  $\square$

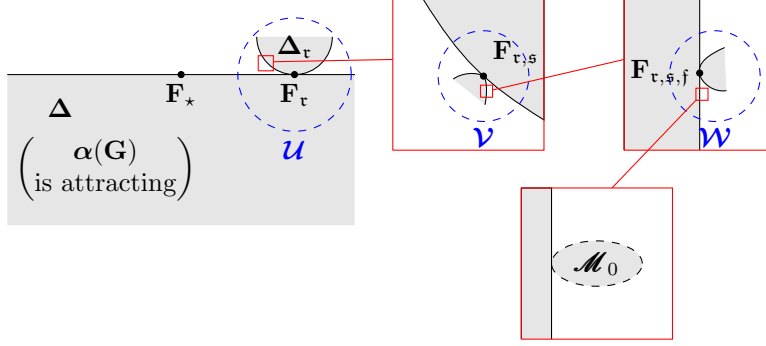

FIGURE 39. Recognizing a small copy on the unstable manifold. A parabolic prepacman  $\mathbf{F}_\tau$  has a small neighborhood  $\mathcal{U}$  parametrized by the multiplier of  $\gamma$ . A secondary parabolic prepacman  $\mathbf{F}_{\tau,s}$  has a small neighborhood  $\mathcal{V} \subset \mathcal{U}$  where the primary renormalization map (1.5) exists. A ternary parabolic prepacman  $\mathbf{F}_{\tau,s,f}$  has a neighborhood  $\mathcal{W} \subset \mathcal{V}$  where the secondary renormalization map (7.11) exists. The set  $\mathcal{W}$  contains a ternary small copy  $\mathcal{M}_0$ .

We say that  $\mathbf{F}_\tau$  is the *root of the limb containing*  $\mathcal{M}_0$ .

**Remark 7.10.** *The fact that  $\mathcal{M}_{\tau,s,t}$  is a bounded subset of  $\mathcal{W}^u$  follows from that Yoccoz inequality. Note that we use the Yoccoz inequality indirectly; i.e. via the straightening map associated with the secondary renormalization (7.11). (The primary renormalization (7.7) is a pinched quadratic-like map.)*

*By applying the Yoccoz inequality directly in  $\mathcal{W}^u$  (after slight thickening of external rays), it is possible to construct a secondary satellite copy  $\mathcal{M}_{\tau,t}$  of the Mandelbrot set in a small neighborhood of  $\mathbf{F}_{\tau,s}$ .*

## 8. THE VALUABLE FLOWER THEOREM

Let us fix a copy  $\mathcal{M}_0 \subset \mathcal{W}^u$  from Theorem 7.9. We set  $\mathcal{M}_n := \mathcal{R}^n(\mathcal{M}_0)$ .

**8.1. Valuable flowers of prepacmen.** Consider a pacman  $\mathbf{G} \in \mathcal{M}_0$ . We denote by  $\mathfrak{X}^0(\mathbf{G})$  the non-escaping set (the “little Julia set”) of the primary renormalization map (7.7). Similarly, let  $\mathfrak{Y}_0$  be the non-escaping set of the secondary renormalization map (7.11). We say that  $\mathfrak{Y}_0$  is a *secondary small filled-in Julia set* (recall that (7.11) can be thickened to a quadratic-like map). Applying  $\mathbf{G}^{Q(\tau)}$  to  $\mathfrak{Y}_0$ , we obtain a periodic cycle  $(\mathfrak{Y}_i)_i$  of small filled-in Julia sets, see Figure 40. By construction, all  $\mathfrak{Y}_i$  are attached to  $\gamma_0$  (which is the  $\beta$ -fixed point of  $\mathfrak{Y}_i$ ); we enumerate  $\mathfrak{Y}_i$  counterclockwise around  $\gamma_0$ .

Choose an index  $j$  such that the following holds. Let  $\mathbf{R}_-, \mathbf{R}_+$  be two external rays landing at  $\gamma_0$  and separating  $\mathfrak{Y}_j$  from all remaining  $\mathfrak{Y}_i$ , see Figure 40. Then  $\mathfrak{Y}_j$  and  $\alpha$  are on the same side of  $\overline{\mathbf{R}_- \cup \mathbf{R}_+}$ : the rays  $\overline{\mathbf{R}_- \cup \mathbf{R}_+}$  bound a closed topological disk containing  $\bigcup_{i \neq j} \mathfrak{Y}_i$ . Let  $\mathfrak{Z}_1$  be the unique preimage of  $\mathfrak{Y}_j$  under

$\mathbf{G}^{Q(\tau)}$  intersecting  $\mathfrak{Y}_j$ ; and similarly, let  $\mathfrak{Z}_{i+1}$  be the unique preimage of  $\mathfrak{Z}_i$  under  $\mathbf{G}^{Q(\tau)}$  intersecting  $\mathfrak{Z}_i$ .

**Lemma 8.1.** *The sets  $\mathfrak{Z}_i$  converge to  $\alpha$ .*

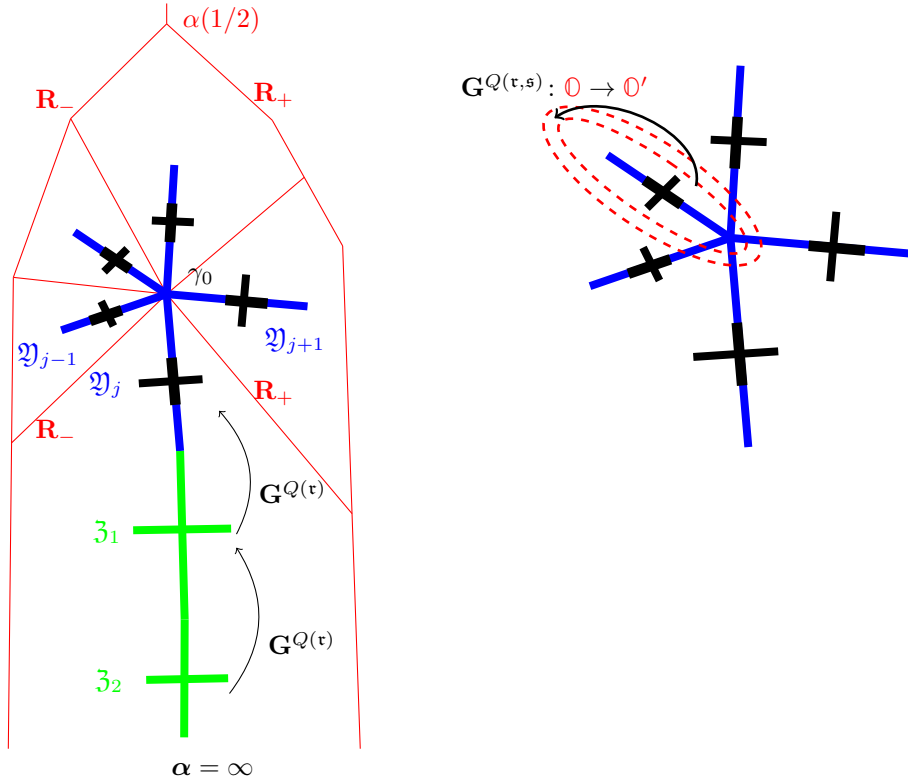

FIGURE 40. Left: the valuable petal  $\mathbf{X}^0(\mathbf{G})$  consists of a periodic cycle of secondary small filled-in Julia sets  $\mathfrak{Y}_i$  (blue) and secondary preperiodic small filled-in Julia sets  $\mathfrak{Z}_i$  (green) converging to  $\alpha$ . The ternary Julia sets are marked black. External rays landing at  $\gamma_0$  and  $\alpha$  are marked red. The rays  $\mathbf{R}_-, \mathbf{R}_+$  surround a disk containing  $\bigcup_{i \neq j} \mathfrak{Y}_i$ , and  $\alpha(1/2)$  is the meeting point of  $\mathbf{R}_-, \mathbf{R}_+$ . Right: the quadratic-like map (8.2), realizing the secondary renormalization.

*Proof.* Recall from Corollary 7.7 that the first renormalization map is written as  $\mathbf{G}^{Q(\tau)}: \mathbf{W}^1 \rightarrow \mathbf{W}$ . Let  $\mathbf{W}'$  be the closure of the connected component of  $\mathbf{W} \setminus \overline{\mathbf{R}_- \cup \mathbf{R}_+}$  containing all  $\mathfrak{Z}_i$ . There is a unique connected component  $\mathbf{W}''$  of  $\mathbf{G}^{-Q(\tau)}(\mathbf{W}')$  such that  $\mathbf{W}'' \subset \mathbf{W}'$ . The map

$$(8.1) \quad \mathbf{G}^{Q(\tau)}: \mathbf{W}'' \rightarrow \mathbf{W}'$$

is univalent, and  $\alpha$  is the only point in  $\partial \mathbf{W}'$  that does not escape under the iterations of (8.1). Therefore,  $\alpha$  is the Denjoy–Wolff fixed point of the inverse of (8.1): under the backward iterations of (8.1) every point in  $\mathbf{W}'$  converges to  $\alpha$ ; the convergence is with respect to the wall topology because  $\partial \mathbf{W} \subset \mathbf{R}^{-1} \cup \mathbf{R}^0$  and the rays  $\mathbf{R}^{-1}, \mathbf{R}^0$  land at  $\alpha$ , see Corollary 7.7.  $\square$

The *valuable petal*  $\mathbf{X}^0(\mathbf{G}) \subset \mathfrak{X}^0(\mathbf{G})$  is the union  $\bigcup_i \mathfrak{Y}_i \cup \bigcup_{i \geq 1} \mathfrak{Z}_i$ . The *upper part* of  $\mathbf{X}^0(\mathbf{G})$  is  $\mathbf{X}_{\text{up}}^0(\mathbf{G}) := \bigcup_i \mathfrak{Y}_i$ . By construction, both  $\mathbf{X}^0(\mathbf{G})$  and  $\mathbf{X}_{\text{up}}^0(\mathbf{G})$  are  $\mathbf{G}^{Q(\tau)}$ -invariant.

Spreading around  $\mathbf{X}^0(\mathbf{G})$ , we obtain the *valuable flower*:

$$\mathbf{X}(\mathbf{G}) := \bigcup_{P < Q(\tau)} \mathbf{G}^P(\mathbf{X}^0(\mathbf{G})).$$

Similarly,  $\mathbf{X}_{\text{up}} \subset \mathbf{X}(\mathbf{G})$  is obtained by spreading around  $\mathbf{X}_{\text{up}}^0$ . We enumerate petals of  $\mathbf{X}(\mathbf{G})$  from left-to-right as  $\mathbf{X}^i$  so that  $\mathbf{X}^i \subset \mathbf{W}(i, \mathbf{G})$ , where  $\mathbf{W}(i)$  are puzzle pieces from Theorem 7.2.

Recall that the secondary renormalization (7.11) admits a thickening to a quadratic-like map. For every  $\mathbf{G} \in \mathcal{M}_0$ , the quadratic-like germ of (7.11) can be presented as a quadratic-like map

$$(8.2) \quad \mathbf{F}^{Q(\tau, s)} : \mathbb{O} \rightarrow \mathbb{O}'$$

such that

- $\mathbb{O}' \Subset \mathbf{W}$ ;
- $\overline{\mathbb{O}'} \setminus \text{int } \mathbf{W}_{\tau, s}$  is in a small neighborhood of  $\gamma_0$ ,
- $\mathbb{O}'$  depends continuously on  $\mathbf{G} \in \mathcal{M}_0$ ; and
- the *unbranched condition* holds:

$$(8.3) \quad \mathfrak{P}(\mathbf{F}) \cap \mathbb{O}' \subset \mathfrak{Y}^0.$$

(For the unbranched condition, observe that  $\mathfrak{P}(\mathbf{F})$  is within the cycle of ternary filled-in Julia sets; these sets are disjoint from  $\gamma_0$ .)

The *enlarged valuable flower* is

$$\tilde{\mathbf{X}}(\mathbf{G}) := \mathbf{X}(\mathbf{G}) \cup \bigcup_{P \leq Q(\tau, s)} \mathbf{G}^P(\mathbb{O}).$$

Since different sets in  $(\mathbf{G}^P(\mathbb{O}))_{P \leq Q(\tau, s)}$  intersect only in small neighborhood of  $\gamma$ , different petals of  $\mathbf{X}(\mathbf{G})$  are in different petals of  $\tilde{\mathbf{X}}(\mathbf{G})$ . Petals in  $\tilde{\mathbf{X}}$  are enumerated as  $\tilde{\mathbf{X}}^i, i \in \mathbb{Z}$ , so that  $\mathbf{X}^i \subset \tilde{\mathbf{X}}^i \subset \mathbf{W}(i)$ . Similarly, we set

$$\tilde{\mathbf{X}}_{\text{up}} := \mathbf{X}_{\text{up}}(\mathbf{G}) \cup \bigcup_{P \leq Q(\tau, s)} \mathbf{G}^P(\mathbb{O}) \quad \text{and} \quad \tilde{\mathbf{X}}_{\text{up}}^i := \tilde{\mathbf{X}}_{\text{up}} \cap \tilde{\mathbf{X}}^i.$$

For  $\mathbf{G}_n := \mathcal{R}^n(\mathbf{G}) \in \mathcal{M}_n$  we define  $\mathbf{X}(\mathbf{G}_n)$  and  $\tilde{\mathbf{X}}(\mathbf{G}_n)$  to be the  $A_*^{-n}$ -images of  $\mathbf{X}(\mathbf{G})$  and  $\tilde{\mathbf{X}}(\mathbf{G})$ . Since  $\mathbb{O}'(\mathbf{G}_n)$  and  $\mathbb{O}(\mathbf{G}_n)$  are rescalings of  $\mathbb{O}'(\mathbf{G})$  and  $\mathbb{O}(\mathbf{G})$ , there is an  $\varepsilon > 0$  such that

$$\text{mod}(\mathbb{O}'(\mathbf{G}_n) \setminus \mathbb{O}(\mathbf{G}_n)) \geq \varepsilon > 0$$

for all  $n$  and  $\mathbf{G}_n \in \mathcal{M}_n$ . The upper parts  $\mathbf{X}_{\text{up}}(\mathbf{F})$  and  $\tilde{\mathbf{X}}_{\text{up}}(\mathbf{F})$  are defined accordingly.



**8.2. Valuable flowers of pacmen.** Consider a pacman  $f \in \mathcal{B}$ . By a *flower* we mean a connected set  $T \ni \alpha$  such that  $T \setminus \{\alpha\}$  has finitely many connected components, called *petals*. We say that the flower  $T$  is *nice* if  $f$  has a Siegel triangulation  $\Delta$  (see §3.2.12) such that different petals of  $T$  are in different triangles of  $\Delta$ . As a consequence if  $f = \mathcal{R}f_{-1}$  (or more generally,  $f = \mathcal{R}_{\text{Sieg}}f_{-1}$  for operator  $\mathcal{R}_{\text{Sieg}}$  as in §3.2.8), then the flower  $T$  admits a full lift  $T_{-1}$  to the dynamical plane of  $f_{-1}$ , see Lemma 3.2.

**Theorem 8.2.** *Consider the dynamical plane of  $f_*$  and fix a small open neighborhood  $N_*$  of  $\bar{Z}_*$ . For  $n \ll 0$  and every  $\mathbf{G}_n \in \mathcal{M}_n$  the flowers  $\tilde{\mathbf{X}}(\mathbf{G}_n)$  and  $\mathbf{X}(\mathbf{G}_n)$  projects to the dynamical plane of  $g_n$ . Moreover, these projections  $\tilde{X}(g_n)$  and  $X(g_n)$  are nice flowers within  $N_*$ .*

*More precisely,  $\mathbf{G}_n$  has a fundamental domain  $\mathbf{S}^{\text{new}}$  such that if a petal  $\tilde{\mathbf{X}}^i$  intersects  $\mathbf{S}^{\text{new}}$ , then  $\tilde{\mathbf{X}}^i \subset \mathbf{S}^{\text{new}}$ . The projection  $\tilde{X}$  of  $\tilde{\mathbf{X}} \cap \mathbf{S}^{\text{new}}$  is within the Siegel triangulation  $\Delta(g_n) \subset N_*$  of  $g_n$ , and the projection  $\tilde{X}_{\text{up}}$  of  $\tilde{\mathbf{X}}_{\text{up}}$  is within the wall  $\mathbb{P}(g_n)$  of  $\Delta(g_n)$ .*

**Remark 8.3.** *The valuable flower  $X(g_n)$  is a forward invariant set containing the postcritical set of  $g_n$ . The purpose of  $X(g_n)$  is to encode the hybrid class of  $g_n$ , i.e. the combinatorial rotation numbers of dividing periodic cycles, as well as hybrid classes of secondary small filled-in Julia sets.*

*Proof.* Let us first give an outline of the proof. We also slightly simplify the notations in the outline. In the actual proof,  $\mathbf{Z}_*$  is replaced by the renormalization triangulation  $\Delta_{-n}(\mathbf{G}_n)$ .

In the dynamical plane of  $\mathbf{G} \in \mathcal{M}_0$ , we re-enumerate the puzzle pieces  $\mathbf{W}(i, \mathbf{G})$ ,  $i \in \mathbb{Z}$ , from Theorem 7.2 by the “landing time.” Namely, for every  $\mathbf{W}(i)$  there is a unique minimal  $P(i) \in \mathbb{T}$  such that  $\mathbf{G}^{P(i)}(\mathbf{W}(i)) \supset \mathbf{W}(0)$ , see details in §8.2.2. We write

$$(8.4) \quad \mathbf{W}_{P(i)} := \mathbf{W}(i) \quad \text{and} \quad i(P(i)) := i.$$

For  $n \in \mathbb{Z}$ , we define  $\mathbf{W}_P^\#(\mathbf{G}_n) := A_*^{-n} \mathbf{W}_{P(i)}(\mathbf{G})$ . Recall from §5.10 that  $\mathbf{W}_P(\mathbf{F}_*)$  denotes the primary wake of generation  $P$ . In Lemma 8.6, we will show that  $\mathbf{W}_P^\#(\mathbf{G}_n) \setminus \mathbf{Z}_*$  converges to  $\mathbf{W}_P(\mathbf{F}_*)$  for every fixed  $P > 0$ . Combing with Lemma 5.29, we obtain that if  $P$  is sufficiently big, then  $\mathbf{W}_P^\#(\mathbf{G}_n) \setminus \mathbf{Z}_*$  is small in the spherical metric of  $\hat{\mathbb{C}}$ .

The main step is to show that  $\tilde{\mathbf{X}}^i \setminus \mathbf{Z}_*$  is uniformly small. If  $P(i)$  is big, then  $\tilde{\mathbf{X}}^i \setminus \mathbf{Z}_*$  is small because  $\mathbf{W}_{P(i)} \setminus \mathbf{Z}_*$  is small. If  $P(i)$  is bounded but  $\mathbf{W}_{P(i)}$  is far from 0 in  $\mathbb{C}$ , then  $\tilde{\mathbf{X}}^i \subset \mathbf{W}_{P(i)}$  is small in the spherical metric of  $\hat{\mathbb{C}}$  (in fact, this case can be ignored). There are finitely many  $i$  in the remaining case; i.e. when  $P(i)$  is bounded and  $\mathbf{W}_{P(i)}$  is not far from 0 in  $\mathbb{C}$ . Let us fix such  $i$ . For  $n \ll 0$ , we have  $\tilde{\mathbf{X}}_{\text{up}}^i(\mathbf{G}_n) \ni c_{P(i)}(\mathbf{G}_n)$ , where  $c_{P(i)}(\mathbf{F}_*) \in \partial \mathbf{Z}_*$  is the unique critical point of  $\mathbf{F}_*^{\geq 0}$  in  $\partial \mathbf{Z}_*$  of generation  $S$ . We have a map

$$\mathbf{G}_n^{P(i)}: \tilde{\mathbf{X}}_{\text{up}}^i \rightarrow \tilde{\mathbf{X}}_{\text{up}}^0 \ni 0.$$

Since  $\tilde{\mathbf{X}}_{\text{up}}^0(\mathbf{G}_n) = A_*^{-n}(\tilde{\mathbf{X}}_{\text{up}}^0(\mathbf{G}_0))$  shrinks to 0 as  $n \rightarrow -\infty$ , we obtain that  $\tilde{\mathbf{X}}_{\text{up}}^i(\mathbf{G}_n)$  shrinks to  $c_{P(i)}$ . This allows to deduce that  $\tilde{\mathbf{X}}^i \setminus \mathbf{Z}_*$  is small because the remaining part of  $\tilde{\mathbf{X}}^i$  is “below”  $\tilde{\mathbf{X}}_{\text{up}}^i$ , compare with Figure 41.

Recall that the parabolic prepacman  $\mathbf{F}_\tau$  is the root of the limb containing  $\mathcal{M}_0$ , see Figure 39. For  $n \leq 0$ , the parabolic pacman

$$(8.5) \quad f_{\tau_n} := \mathcal{R}^n f_\tau$$

has rotation number  $\tau_n = \mathfrak{p}_n/\mathfrak{q}_n \in \mathbb{Q}$  satisfying  $R_{\text{prm}}^{-n\mathfrak{m}}(\tau_n) = \tau$ , see Lemma 3.1. Then  $\mathbf{F}_{\tau_n}$  is the root of the limb containing  $\mathcal{M}_n$  and  $\tau_n$  is the combinatorial rotation number of  $g_n$ . Since  $\tilde{\mathbf{X}}^i \setminus \mathbf{Z}_*$  is small for every  $i$ , we can adjust the fundamental domain  $\mathbf{S}(\mathbf{G}_n)$  (see §4.8) so that the new  $\mathbf{S}^{\text{new}}(\mathbf{G}_n)$  contains the petals  $\tilde{\mathbf{X}}^i$  for  $i \in \{-\mathfrak{p}_n + 1, \mathfrak{p}_n + 2, \dots, \mathfrak{q}_n - \mathfrak{p}_n\}$ . By Theorem 4.7,  $\tilde{\mathbf{X}}$  projects to the dynamical plane of  $g_n$ .

Let us now provide the details.

8.2.1. *The escaping set.* Up to replacing  $\mathcal{M}_0$  with its antirenormalization, we can assume that  $\mathcal{M}_0 \subset \mathcal{W}_{\text{loc}}^u$ . In particular, every  $\mathbf{G} \in \mathcal{M}_0$  has a renormalization triangulation  $\Delta_0(\mathbf{G})$  with the wall  $\mathbb{P}_0(\mathbf{G})$  that bounds  $\mathbf{Q}_0 = \Delta_0 \setminus \mathbb{P}_0$ , see §4.6.

Fix a big  $T \in \mathbb{T}$ . For  $n \ll 0$  sufficiently big, the holomorphic motion  $\tau$  from Lemma 6.7 induces an equivariant map

$$(8.6) \quad h_n: \mathbf{Esc}_T(\mathbf{G}_n) \rightarrow \mathbf{Esc}_T(\mathbf{F}_*) .$$

Applying the  $\lambda$ -lemma, we obtain:

**Lemma 8.4.** *For  $n \ll 0$  sufficiently big (depending on  $T$ ), (8.6) is close to the identity with respect to the spherical distance.  $\square$*

8.2.2. *Decomposition*  $\mathbf{W}_P = \mathbf{W}_P^a \cup \mathbf{W}_P^1 \cup \mathbf{W}_P^b$ . Recall from Theorem 7.2 that  $\mathbf{W}(i, \mathbf{F}_\tau)$  denotes the puzzle piece bounded by  $\mathbf{R}^{i-1}$  and  $\mathbf{R}^i$ . Since  $\mathcal{M}_0 \subset \mathcal{V}$  (see Figure 39), the puzzle pieces  $\mathbf{W}(i, \mathbf{G})$  exist (in the sense of §6.4) in the dynamical plane of  $\mathbf{G} \in \mathcal{M}_0$ . Let us first discuss the combinatorics of  $\mathbf{W}(i, \mathbf{G})$ . For  $i \neq 0$ , the *generation of  $\mathbf{W}(i, \mathbf{G}_0)$*  is the unique ‘‘landing time’’  $P(i) < Q(\tau)$  such that

$$(8.7) \quad \mathbf{G}^{Q(\tau)-P(i)}: \mathbf{W}(0) \rightarrow \mathbf{W}(i)$$

is a univalent map. Let us re-label the puzzle pieces by their landing time:

$$\mathbf{W}_{P(i)}(\mathbf{G}) := \mathbf{W}(i, \mathbf{G}) \quad \text{and} \quad \mathbf{W}_0(\mathbf{G}) := \mathbf{W}(0, \mathbf{G}).$$

Then (8.7) takes the form

$$(8.8) \quad \mathbf{G}^{Q(\tau)-P}: \mathbf{W}_0 \rightarrow \mathbf{W}_P.$$

Recall from Lemma 7.3 that  $\mathbf{W} = \mathbf{W}^1 \cup \mathbf{W}^a \cup \mathbf{W}^b$ . Let  $\mathbf{W}_P^1$ ,  $\mathbf{W}_P^a$ , and  $\mathbf{W}_P^b$  be the images of  $\mathbf{W}^1$ ,  $\mathbf{W}^a$ , and  $\mathbf{W}^b$  under (8.8) respectively. We have a two-to-one map

$$(8.9) \quad \mathbf{G}^P: \mathbf{W}_P^1 \rightarrow \mathbf{W}_0,$$

while  $\mathbf{G}^P$  maps univalently into  $\mathbf{W}_P^a$  and into  $\mathbf{W}_P^b$  to two different components of  $\mathbb{C} \setminus (\mathbf{W} \cup \mathbf{R}^0)$ , see Figure 41.

8.2.3. *Decomposition*  $\mathbf{W}_P^1 = \mathbf{W}_P^+ \cup \mathbf{W}_P^\bullet \cup \mathbf{W}_P^-$ . We still consider the dynamical plane of  $\mathbf{G} \in \mathcal{M}_0$ . Choose an auxiliary univalent 2-wall  $\mathbb{A} \subset \mathbf{Q}$ , see §4.6. We denote by  $\mathbf{Q}'$  the connected component of  $\mathbf{Q} \setminus \mathbb{A}$  attached to  $\alpha$ . Let us fix a closed topological disk  $\mathbf{W}_0^\bullet$  in  $\mathbf{W}_0$  such that

- (A)  $\mathbf{W}_0 \setminus \mathbf{Q}' \subset \mathbf{W}_0^\bullet$ ;
- (B)  $\mathbf{W}_0 \supset \mathbf{X}_{\text{up}}^0$  (recall that  $\mathbf{X}_{\text{up}}^0 = \bigcup_i \mathfrak{Y}_i$ ).

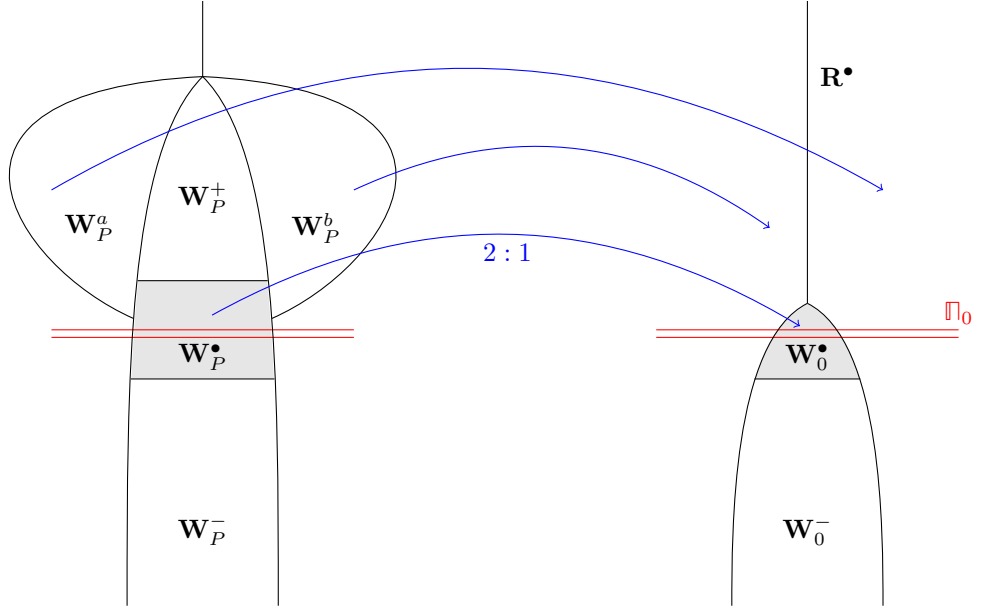

FIGURE 41. The decomposition of  $\mathbf{W}_P$ , see also Figure 34. The regions  $\mathbf{W}_P^\bullet$  and  $\mathbf{W}_P^- \cup \mathbf{W}_P^+$  are the preimages of  $\mathbf{W}_0^\bullet$  and  $\mathbf{W}_0^-$  under  $\mathbf{G}^P: \mathbf{W}_P \rightarrow \mathbf{W}_0$  respectively. The region  $\text{int}(\mathbf{W}_P^a \cup \mathbf{W}_P^b)$  is the preimages of  $\mathbb{C} \setminus (\mathbf{W}_0 \cup \mathbf{R}^\bullet)$  under  $\mathbf{G}^P: \mathbf{W}_P \rightarrow \mathbb{C}$ . We define  $\mathbf{W}_P^{\text{out}} := \mathbf{W}_P^\bullet \cup \mathbf{W}_P^+ \cup \mathbf{W}_P^a \cup \mathbf{W}_P^b$ .

We set  $\mathbf{W}_0^- := \mathbf{W}_0 \setminus \mathbf{W}_0^\bullet$ .

Since  $\mathbf{W}_0^\bullet$  contains the unique critical value of (8.9), the preimage of  $\mathbf{W}_0^\bullet$  under (8.9) consists of a single connected component, call it  $\mathbf{W}_P^\bullet$ . On the other hand, the preimage of  $\mathbf{W}_0^-$  under (8.9) consists of two connected components, we denote them by  $\mathbf{W}_P^-$  and  $\mathbf{W}_P^+$  specified so that  $\mathbf{W}_P^-$  is attached to  $\alpha$ , see Figure 41.

Finally, we define  $\mathbf{W}_0^{\text{out}} := \mathbf{W}_0^\bullet$  and

$$\mathbf{W}_P^{\text{out}} := \mathbf{W}_P^\bullet \cup \mathbf{W}_P^+ \cup \mathbf{W}_P^a \cup \mathbf{W}_P^b.$$

For  $n \in \mathbb{Z}$  and  $P < Q(\tau)$ , we define:

$$(8.10) \quad \mathbf{W}_P = \mathbf{W}_P^\#(\mathbf{G}_n) := A_\star^{-n} \mathbf{W}_{\tau^n P}(\mathbf{G});$$

we omit “ $\#$ ” below, to simplify notations. The regions

$$\mathbf{W}_P^1(\mathbf{G}_n), \mathbf{W}_P^\bullet(\mathbf{G}_n), \mathbf{W}_P^a(\mathbf{G}_n), \mathbf{W}_P^b(\mathbf{G}_n), \mathbf{W}_P^-(\mathbf{G}_n), \mathbf{W}_P^+(\mathbf{G}_n), \mathbf{W}_P^{\text{out}}(\mathbf{G}_n)$$

are defined accordingly using (8.10).

As in §4.6,  $\mathbf{Q}_{-n}(\mathbf{G}_n)$  is the rescaling of  $\mathbf{Q}(\mathbf{G})$ . It follows from the Condition (A) that

$$\mathbf{W}_P(\mathbf{G}_n) \setminus \mathbf{Q}_{-n} \subset \mathbf{W}_P^{\text{out}}(\mathbf{G}_n) \quad \text{and} \quad \mathbf{W}_P^-(\mathbf{G}_n) \subset \mathbf{Q}_{-n}(\mathbf{G}_n).$$

Condition (B) implies

$$(8.11) \quad \tilde{\mathbf{X}}^i(\mathbf{G}_n) \subset \mathbf{W}_{P(i)}^\bullet \cup \mathbf{W}_{P(i)}^-(\mathbf{G}_n) \quad \text{and} \quad \tilde{\mathbf{X}}_{\text{up}}^i(\mathbf{G}_n) \subset \mathbf{W}_{P(i)}^\bullet(\mathbf{G}_n).$$

8.2.4.  $\mathbf{R}^\bullet(\mathbf{G}_n)$  converges to  $\mathbf{R}^\bullet(\mathbf{F}_\star)$ . We say that arcs  $\beta, \gamma \subset \widehat{\mathbb{C}}$  are  $C^0$ -close if, up to re-parameterization, the functions  $\beta, \gamma: [0, 1] \rightarrow \mathbb{C}$  are close with respect to the sphere metric of  $\widehat{\mathbb{C}}$ . The  $C^0$ -closeness for closed curves is defined in the same way.

Two topological closed disks  $D_1, D_2 \subset \widehat{\mathbb{C}}$  are  $C^0$ -close if  $\partial D_1, \partial D_2$  are  $C^0$ -close closed curves. Equivalently, viewing  $D_1, D_2$  as injective functions  $D_1, D_2: \overline{\mathbb{D}} \rightarrow \widehat{\mathbb{C}}$ , the disks  $D_1, D_2$  are  $C^0$ -close if, up to re-parameterization, the corresponding functions are close with respect to the sphere metric of  $\widehat{\mathbb{C}}$ .

Let us write:

$$\mathbf{R}^\bullet := \mathbf{R}^{-1} \cap \mathbf{R}^0 \quad \text{and} \quad \mathbf{R}^\bullet(\mathbf{G}_n) := A_\star^{-n} \mathbf{R}^\bullet(\mathbf{G}_0).$$

Recall that  $\mathbf{R}^\bullet(\mathbf{F}_\star)$  is the ray landing at 0, see §5.9.

**Lemma 8.5.** *If  $n \ll 0$  is sufficiently big, then  $\mathbf{R}^\bullet(\mathbf{G}_n)$  is close to  $\mathbf{R}^\bullet(\mathbf{F}_\star)$  with respect to the  $C^0$ -distance.*

*Proof.* Fix a small  $\varepsilon > 0$ . We will show that  $\mathbf{R}^\bullet(\mathbf{G}_n)$  is  $\varepsilon$ -close to  $\mathbf{R}^\bullet(\mathbf{F}_\star)$  for  $n \ll 0$ .

Recall from (5.9) that  $\mathbf{R}^\bullet(\mathbf{F}_\star)$  decomposes as a concatenation  $\bigcup_{j \in \mathbb{Z}} \mathbf{I}_j$ , where  $\mathbf{I}_j$  is a ray segment in the closure of  $\mathbf{Esc}_{\iota^j P} \setminus \mathbf{Esc}_{\iota^{j-1} P}(\mathbf{F}_\star)$  such that  $A_\star \mathbf{I}_j = \mathbf{I}_{j+1}$ .

By Corollary 5.27, every two rays eventually meet at an alpha-point. Suppose that  $\mathbf{R}^\bullet(\mathbf{G}_n)$  meets  $\mathbf{R}^\bullet(\mathbf{G}_n)$  at  $\alpha_n$ , where  $\mathbf{R}^\bullet(\mathbf{G}_n)$  is the counterpart of  $\mathbf{R}^\bullet(\mathbf{F}_\star)$ . Then  $\alpha_n = A_\star \alpha_{n+1}$  and the  $\alpha_n$  tends to 0 as  $n \rightarrow -\infty$ .

Choose first a big  $k \gg 0$ , then a sufficiently big  $T > 0$ . For a sufficiently big  $n \ll 0$ , we can decompose

$$\mathbf{R}^\bullet(\mathbf{G}_n) = \mathbf{L}^n \cup \bigcup_{j \leq k} \mathbf{I}_j(\mathbf{G}_n)$$

such that  $\bigcup_{j \leq k} \mathbf{I}_j \subset \mathbf{Esc}_T(\mathbf{G}_n)$ . By Lemma 8.4,  $\mathbf{I}_j(\mathbf{G}_n)$  is  $\varepsilon$ -close to  $\mathbf{I}_j(\mathbf{F}_\star)$  with respect to the spherical metric for all  $j \leq k$ .

Applying  $A_\star$ , we obtain the decomposition

$$\mathbf{R}^\bullet(\mathbf{G}_{n-1}) = \mathbf{L}^{n-1} \cup \bigcup_{j \leq k+1} \mathbf{I}_j(\mathbf{G}_{n-1})$$

where

$$\mathbf{L}^{n-1}(\mathbf{G}_{n-1}) = A_\star \mathbf{L}^n(\mathbf{G}_n) \quad \text{and} \quad \mathbf{I}_{k+1}(\mathbf{G}_{n-1}) = A_\star \mathbf{I}_k(\mathbf{G}_n).$$

The ray segment  $\mathbf{I}_k(\mathbf{G}_n)$  is  $\varepsilon$ -close to  $\mathbf{I}_k(\mathbf{F}_\star)$  which is close to 0 because  $k \gg 0$ . Since  $A_\star$  contracts the spherical metric in a neighborhood of 0, we see that  $\mathbf{I}_{k+1}(\mathbf{G}_{n-1})$  is  $\varepsilon$ -close to  $\mathbf{I}_{k+1}(\mathbf{F}_\star)$ .

Continuing the process, we obtain the decomposition

$$\mathbf{R}^\bullet(\mathbf{G}_m) = \mathbf{L}^m \cup \bigcup_{j \leq k+n-m} \mathbf{I}_j(\mathbf{G}_m)$$

for  $m \leq n$ , where  $\bigcup_{j \leq k+n-m} \mathbf{I}_j(\mathbf{G}_m)$  is  $\varepsilon$ -close to  $\bigcup_{j \leq k+n-m} \mathbf{I}_j(\mathbf{F}_\star)$ . Since  $\mathbf{L}^m(\mathbf{G}_m) = A_\star^{n-m} \mathbf{L}^n(\mathbf{G}_n)$ , the chain  $\mathbf{L}^m(\mathbf{G}_m)$  is eventually in a small neighborhood of 0, and the claim follows.  $\square$

8.2.5.  $\mathbf{W}_P^{\text{out}}(\mathbf{G}_n)$  approximates  $\mathbf{W}_P(\mathbf{F}_\star)$ . Clearly,  $\mathbf{W}_0^\bullet(\mathbf{G}_n) = A_\star^{-n} \mathbf{W}_0^\bullet(\mathbf{G}_0)$  shrinks to 0 as  $n \rightarrow -\infty$ . Recall that  $c_S(\mathbf{F}_\star)$  denotes the unique critical point in  $\partial Z_\star$  of generation  $S$ , see §5.2.

**Lemma 8.6.** *For every  $\varepsilon > 0$  and  $P \in \mathbb{T}$  the following holds. If  $n \ll 0$  is sufficiently big, then  $\mathbf{W}_S^{\text{out}}(\mathbf{G}_n)$  is  $\varepsilon$ -close to  $\mathbf{W}_S(\mathbf{F}_\star)$  with respect to  $C^0$ -metric for every  $S \leq P$ . Moreover,  $\mathbf{W}_S^\bullet$  is in the  $\varepsilon$ -neighborhood of  $c_S(\mathbf{F}_\star)$ .*

*Proof.* By Lemma 4.4, we can choose a sufficiently small disk  $D_0 := \overline{\mathbb{D}}(\zeta)$  around 0 and a sufficiently small neighborhood  $\mathcal{O}$  of  $\mathbf{F}_\star$  such that  $D_0$  is disjoint from  $\text{CV}(\mathbf{G}^S) \cup \mathbf{G}^S(D_0)$  for all  $S \leq P$ . In particular,

$$\tilde{D}(\mathbf{G}) := \bigcup_{S \leq P} \mathbf{G}^{-S}(D_0)$$

depends holomorphically on  $\mathbf{G} \in \mathcal{O}$  and every connected component of  $\tilde{D}(\mathbf{G})$  is a degree two preimage of  $D_0$ .

For  $S \leq P$ , let  $D_S(\mathbf{F}_\star)$  be the lift of  $D_0$  along  $\mathbf{F}_\star^S: c_S \mapsto 0$ . For  $\mathbf{F} \in \mathcal{O}$ , we define  $D_S(\mathbf{F})$  to be the lift of  $D_0$  under  $\mathbf{F}^S$  such that  $D_S(\mathbf{F})$  depends holomorphically on  $\mathbf{F}$ . Let  $c_S(\mathbf{F})$  be the unique preimage of 0 under  $\mathbf{F}^S: D_S \rightarrow D_0$ . We claim that for a sufficiently big  $n \ll 0$ , the point  $c_S(\mathbf{G}_n)$  is the unique critical point of  $\mathbf{G}_n^S: \mathbf{W}_S^1 \rightarrow \mathbf{W}_0$  for all  $S \leq P$ . Indeed, Lemma 7.4 asserts such statement for  $\mathbf{F}_\tau$  and for sufficiently small  $S$ ; perturbing  $\mathbf{F}_\tau$  to  $\mathbf{G} \in \mathcal{M}_0$  and passing to the antirenormalization, we obtain the required claim.

Choose a sufficiently big  $T \gg P$  such that

$$\mathbf{R}^\bullet(\mathbf{G}_n) \setminus \text{Esc}_{T-P}(\mathbf{G}_n) \subset D_0$$

for all  $n \ll 0$ .

Consider  $\mathbf{W}_S^{\text{out}}(\mathbf{G}_n)$  for  $S \leq P$ . We can decompose  $\partial \mathbf{W}_S^{\text{out}} = \beta_1 \cup \beta_2$ , where  $\beta_1$  and  $\beta_2$  are simple arcs satisfying

$$\beta_2 := \partial \mathbf{W}_S^{\text{out}} \cap \text{Esc}_T(\mathbf{G}_n) \quad \text{and} \quad \beta_1 \subset D_S(\mathbf{G}_n).$$

By Lemma 8.4,  $\beta_2(\mathbf{G}_n)$  is close to

$$\beta_2(\mathbf{F}_\star) = h_n(\beta_2(\mathbf{G}_n)) \subset \mathbf{W}_S(\mathbf{F}_\star).$$

Since

$$\beta_1(\mathbf{F}_\star) := \partial \mathbf{W}_S(\mathbf{F}_\star) \setminus \beta_2(\mathbf{F}_\star) \subset D_S(\mathbf{F}_\star)$$

and since  $D_S(\mathbf{G}_n)$  is close to  $D_S(\mathbf{F}_\star)$ , we obtain that  $\mathbf{W}_S^{\text{out}}(\mathbf{G}_n)$  is close to  $\mathbf{W}_S(\mathbf{F}_\star)$ .  $\square$

Combining with Corollary 5.32, we obtain:

**Corollary 8.7.** *Fix a small  $\varepsilon > 0$  and then a sufficiently big  $n \ll 0$ . Then the set  $\mathbf{W}_S^\bullet(\mathbf{G}_n) \setminus \mathbf{Q}_{-n}(\mathbf{G}_n)$  is within the spherical  $\varepsilon$ -neighborhood of  $c_S(\mathbf{F}_\star)$  for every  $S \in \mathbb{T}$ .*

Since  $\tilde{\mathbf{X}}^i \setminus \mathbf{Q}_{-n}(\mathbf{G}_n) \subset \mathbf{W}_S^\bullet(\mathbf{G}_n) \setminus \mathbf{Q}_{-n}(\mathbf{G}_n)$  (see (8.11)), the set  $\tilde{\mathbf{X}}^i \setminus \mathbf{Q}_{-n}(\mathbf{G}_n)$  is also in a small neighborhood of  $c_S(\mathbf{F}_\star)$ .

*Proof.* Choose a sufficiently big  $P \gg 0$ . By Lemma 8.6,  $\mathbf{W}_S^\bullet(\mathbf{G}_n) \setminus \mathbf{Q}_{-n}(\mathbf{G}_n)$  is within a small neighborhood of  $c_S(\mathbf{F}_\star)$  for every  $S \leq P$  and every sufficiently big  $n \ll 0$ .

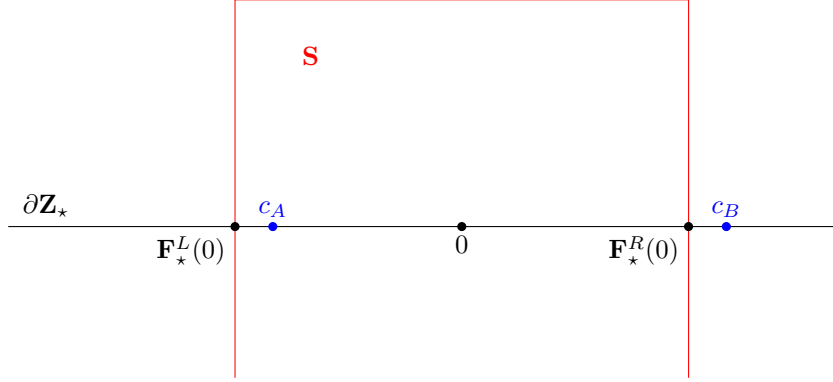

FIGURE 42. The critical points  $c_A$  and  $c_B$  are near  $\mathbf{F}_*^R(0)$  and  $\mathbf{F}_*^L(0)$  respectively.

By Corollary 5.32 and Lemma 8.6, every connected component of

$$(8.12) \quad \mathbb{C} \setminus \left( \mathbf{Q}_{-n}(\mathbf{G}_n) \cup \bigcup_{S \leq P} \mathbf{W}_S^{\text{out}}(\mathbf{G}_n) \right)$$

is  $\varepsilon$ -small. Note that for  $S > P$  and  $T_1, T_2 \leq S$ , the puzzle  $\mathbf{W}_S(\mathbf{G}_n)$  is between  $\mathbf{W}_{T_1}(\mathbf{G}_n)$  and  $\mathbf{W}_{T_2}(\mathbf{G}_n)$  with respect to the left-right order if and only if  $c_S(\mathbf{F}_*)$  is between  $c_{T_1}$  and  $c_{T_2}$  with respect to  $\partial \mathbf{Z}_*$ . Therefore, for  $S > P$ , the sets  $\mathbf{W}_S(\mathbf{G}_n) \setminus \mathbf{Q}_{-n}$  and  $\mathbf{W}_S(\mathbf{F}_*)$  are in the closures of  $\varepsilon/2$ -close components of (8.12) and (5.16) respectively. This proves the corollary for  $S > P$ .  $\square$

As a byproduct, we also obtain:

**Lemma 8.8.** *For every  $\mathbf{G} \in \mathcal{M}_0$ , the puzzle pieces  $(\mathbf{W}(i, \mathbf{G}))_{i \in \mathbb{Z}}$  form a partition of  $\mathbb{C}$ : every  $z \in \mathbb{C}$  belongs to some  $\mathbf{W}(i)$ .*

*Proof.* Recall that the rays  $\mathbf{R}^i$  land at  $\alpha$ , and the union  $\bigcup_{i \in \mathbb{Z}} \mathbf{R}^i$  is a tree in  $\mathbb{C}$  (follows from Lemma 6.12 and Theorem 7.2). For  $i < j$ , let  $\mathbf{W}_{i,j}$  be the unique component of  $\mathbb{C} \setminus (\mathbf{R}^i \cup \mathbf{R}^j)$  attached to  $\alpha$  in the following sense:  $\mathbf{W}_{i,j}$  without a small neighborhood of  $\alpha$  is precompact in  $\mathbb{C}$ . Since

$$\overline{\mathbf{W}_{i,j}} = \bigcup_{i < k \leq j} \mathbf{W}(k),$$

it is sufficient to show that  $\bigcup_{i < j} \mathbf{W}_{i,j} = \mathbb{C}$ .

The case  $z \in \mathbf{Q}$  is straightforward. For  $z \notin \mathbf{Q}$ , we can surround  $A_*^{-n}z$  by  $\mathbf{Q}_{-n} \cup \mathbf{W}_S^{\text{out}} \cup \mathbf{W}_T^{\text{out}}(\mathbf{G}_n)$ , where  $S, T$  are certain fixed power-triples and  $n \ll 0$ .  $\square$

**8.2.6. Fundamental domain.** Using Corollary 8.7, we can now construct a fundamental domain  $\mathbf{S}^{\text{new}}$  as required. Write  $L = (0, 1, 0)$ ,  $R = (0, 0, 1)$ , and note that  $\mathbf{S}(\mathbf{F}_*) \cap \partial \mathbf{Z}_*$  is the arc  $J := [\mathbf{F}_*^L(0), \mathbf{F}_*^R(0)] \subset \partial \mathbf{Z}_*$ . Choose  $c_A$  and  $c_B$  close to  $\mathbf{F}_*^L(0)$  and  $\mathbf{F}_*^R(0)$  respectively such that  $A + R = B + L$ , see Figure 42. We can assume that  $c_A \in J$  while  $c_B \notin J$ .

Since  $\tilde{\mathbf{X}}^i \setminus \mathbf{Q}_{-n}(\mathbf{G}_n)$  is in a small neighborhood of  $c_{P(i)}(\mathbf{F}_\star)$  (using notations from (8.4)), we can adjust  $\mathbf{S}(\mathbf{G}_n)$  such that the new fundamental domain  $\mathbf{S}^{\text{new}}(\mathbf{G}_n)$  (see §4.8) contains  $\tilde{\mathbf{X}}^i$  for all  $i \in \{i(A), i(A) + 1, \dots, i(B) - 1\} =: I$  and  $\mathbf{S}^{\text{new}}(\mathbf{G}_n)$  is disjoint from  $\tilde{\mathbf{X}}^i$  for all  $i \notin I$ . (To satisfy Conditions (2) and (3) in §4.8, we can assume that  $\lambda(\mathbf{S}^{\text{new}})$  follows the ray  $\mathbf{R}^{i(A)}$  and  $\rho(\mathbf{S}^{\text{new}})$  follows the ray  $\mathbf{R}^{i(B)-1}$ .) We also have

$$\tilde{\mathbf{X}}_{\text{up}}^i(\mathbf{G}_n) \subset \bigcup_P \mathbf{W}_P^\bullet(\mathbf{G}_n) \subset \mathbb{P}_0(\mathbf{G}_n).$$

□

## 9. PROOF OF THE MAIN RESULTS

By Theorem 7.9, the unstable manifold  $\mathcal{W}^u$  of  $\mathbf{F}_\star$  contains a sequence  $(\mathcal{M}_n)_{n \leq 0}$  of copies of the Mandelbrot sets such that  $\mathcal{R}\mathcal{M}_{n-1} = \mathcal{M}_n$ . Every  $\mathcal{M}_n$  naturally corresponds to a small copy  $\mathcal{M}_n \subset \mathcal{M}$ , see (9.4). Then  $(\mathcal{M}_n)_{n \leq m}$  for  $m \ll 0$  will be a sequence satisfying Theorem 1.1.

**9.1. Stable lamination.** For  $n \ll 0$ , we define  $\mathcal{M}_n$  to be the set of pacmen  $g_n \in \mathcal{W}^u$  with  $\mathbf{G}_n \in \mathcal{M}_n$ . By Theorem 8.2, every  $g_n \in \mathcal{M}_n$  has a nice valuable flower  $X(g_n)$  and a nice extended valuable flower  $\tilde{X}(g_n)$  in a small neighborhood of  $\bar{Z}_\star$ . Since flowers are nice,  $\tilde{X}(g_{n-1})$  is a full lift of  $\tilde{X}(g_n)$ .

For  $g_n \in \mathcal{M}_n$ , we denote by  $\mathfrak{Y}^0(g_n)$  and  $O(g_n)$  the projections of  $\mathfrak{Y}^0(\mathbf{G}_n)$  and  $O(\mathbf{G}_n)$ . Then  $\mathfrak{Y}^0(g_n)$  is the non-escaping set of the quadratic-like map

$$(9.1) \quad g_n^{\mathfrak{a}_n} : O \rightarrow g_n^{\mathfrak{a}_n}(O) = O',$$

where  $\mathfrak{r}_n = \mathfrak{p}_n/\mathfrak{q}_n$  is the combinatorial rotation number of  $\alpha(g)$  and  $\mathfrak{a}_n := \mathfrak{q}_n\mathfrak{q}_s$ . By construction,  $g_n^i(O) \subset \tilde{X}(g)$  for  $i \leq \mathfrak{a}_n$ . Since  $\tilde{X}(g_n)$  is the projection of  $\tilde{\mathbf{X}}(\mathbf{G}_n)$ , the unbranched condition (8.3) implies to the unbranched condition for (9.1):

$$(9.2) \quad \mathfrak{P}(g_n) \cap O' \subset \mathfrak{Y}^0(g_n).$$

By Lemma 3.1,

$$(9.3) \quad R_{\text{prm}}^m(\mathfrak{r}_{n-1}) = \mathfrak{r}_n.$$

Recall §3.1.2 that  $\mathcal{M}_{\mathfrak{r}(n), \mathfrak{s}, \mathfrak{t}}$  denotes the ternary satellite copy of  $\mathcal{M}$  with rotation parameters  $\mathfrak{r}(n), \mathfrak{s}, \mathfrak{t}$ . Let us consider the canonical homeomorphism

$$\chi_{\text{Pacm}} : \mathcal{M}_n \rightarrow \mathcal{M}_{\mathfrak{r}(n), \mathfrak{s}, \mathfrak{t}} =: \mathcal{M}_n$$

between two copies of the Mandelbrot sets. Then

$$(9.4) \quad \mathbf{R}_{\text{prm}}^m \circ \chi_{\text{Pacm}}(g) = \chi_{\text{Pacm}} \circ \mathcal{R}(g), \quad g \in \bigcup_{n \ll 0} \mathcal{M}_n,$$

where  $\mathbf{R}_{\text{prm}}$  is the molecule map, see §3.2.15. We write  $\mathbf{R} := \mathbf{R}_{\text{prm}}^m$ ; then  $\chi_{\text{Pacm}}$  semi-conjugates  $\mathcal{R}$  to  $\mathbf{R}$ .

**Remark 9.1.** We believe that  $\chi_{\text{Pacm}}$  on  $\bigcup_{n \ll 0} \mathcal{M}_n$  can be extended to a “pacman straightening map” defined on the connectedness locus of the space of pacmen.

9.1.1. *Lamination  $\mathcal{F}_n$ .* Fix a big  $n \ll 0$  and consider  $g \in \mathcal{M}_n$ . For a pacman  $f \in \mathcal{B}$  close to  $g$ , we set  $O'(f) := O'(g)$  and we set  $O(f)$  to be the lift of  $O'(f)$  under  $f^{\text{an}}$  along the orbit of  $g^{\text{an}}: \mathfrak{Y}^0(g) \rightarrow \mathfrak{Y}^0(g)$ ; this is well defined because  $f$  is close to  $g$ . We obtain a quadratic-like map

$$(9.5) \quad \mathcal{R}_{\text{QL}}^{\bullet 2}(f) := f^{\text{an}}: O(f) \rightarrow O'(f).$$

We view  $\mathcal{R}_{\text{QL}}^{\bullet 2}$  as an analytic operator  $\mathcal{R}_{\text{QL}}^{\bullet 2}: \mathcal{B} \dashrightarrow \mathcal{QL}$  defined on a small neighborhood of  $\mathcal{M}_n$ , where  $\mathcal{QL}$  is the space of quadratic-like germs, see §3.1.1.

We denote by  $\mathfrak{Y}^0(f)$  the non-escaping set of (9.5). Slightly shrinking, if necessary, we can assume that the unbranched condition holds for (9.5), because the unbranched condition holds for (9.1).

**Remark 9.2.** *The operator  $\mathcal{R}_{\text{QL}}^{\bullet 2}$  should be viewed as the composition  $\mathcal{R}_{\text{QL}} \circ \mathcal{R}_{\text{QL}}^{\bullet}$ , where  $\mathcal{R}_{\text{QL}}^{\bullet} f$  is a degenerate quadratic-like map associated with the first renormalization map (7.7). It follows that*

$$(9.6) \quad \mathcal{R}_{\text{QL}}^2 \circ \chi_{\text{Pacm}}(g) = \chi \circ \mathcal{R}_{\text{QL}}^{\bullet 2}(g) \in \mathcal{M}_t, \quad g \in \mathcal{M}_n$$

where  $\chi$  is the quadratic-like straightening map, see §3.1.1.

Recall that we will often identify a lamination with its support.

**Lemma 9.3.** *For  $g \in \mathcal{M}_n$  and  $p := \chi_{\text{Pacm}}(g)$ , define  $\mathcal{F}_p$  to be the set of  $f$  close to  $g$  such that (9.5) is hybrid equivalent to (9.1). The set*

$$\mathcal{F}_n := \{\mathcal{F}_p\}_{p \in \mathcal{M}_n}$$

*forms a codimension-one lamination with complex-analytic leaves in a small neighborhood of  $\mathcal{M}_n$ .*

*Proof.* Recall from §3.1.1 that the hybrid classes form a codimension-one lamination  $\mathcal{F}_{\text{QL}}$  of the connectedness locus  $\mathfrak{M}$  with complex codimension-one analytic leaves. We need to show that the pullback  $\mathcal{F}_n = (\mathcal{R}_{\text{QL}}^{\bullet 2})^*(\mathcal{F}_{\text{QL}})$  is again a lamination of the same type. We will use an argument from [ALM, Theorem 4.9].

Consider a local leaf  $\mathcal{F}'$  of  $\mathcal{F}_{\text{QL}}$  intersecting  $\mathcal{R}_{\text{QL}}^{\bullet 2}(\mathcal{M}_n)$ . In a small neighborhood of  $\mathcal{R}_{\text{QL}}^{\bullet 2}(\mathcal{M}_n)$ , the leaf  $\mathcal{F}'$  is the zero set of some analytic function  $\phi: \mathcal{QL} \dashrightarrow \mathbb{C}$ . Note that  $\mathcal{F}'$  intersects  $\mathcal{R}_{\text{QL}}^{\bullet 2}(\mathcal{M}_n)$  at a single point. By the inverse function theorem,

$$(\mathcal{R}_{\text{QL}}^{\bullet 2})^{-1}(\mathcal{F}') = (\phi \circ \mathcal{R}_{\text{QL}}^{\bullet 2})^{-1}(0)$$

is a codimension-one analytic manifold in a small neighborhood of  $\mathcal{M}_n$ . Therefore,  $\mathcal{F}_n = (\chi \circ \mathcal{R}_{\text{QL}}^{\bullet 2})^{-1}(\mathcal{M})$  forms a desired lamination.  $\square$

Since the local dynamics is structurally stable at  $\alpha(g)$ , by shrinking a neighborhood of  $\mathcal{M}_n$ , we can assume that the flower  $X(f)$  exists and depends holomorphically on  $f \in \mathcal{F}_p$ ; i.e. certain preimages of  $\mathfrak{Y}^0(f)$  assemble into the flower  $X(f)$  in the same pattern as certain preimage of  $\mathfrak{Y}^0(g)$  assemble into the flower  $X(g)$ . Indeed, by continuity, every preimage  $\mathfrak{Z}' \subset X(g)$  of  $\mathfrak{Y}^0(g)$  of bounded generation has the corresponding preimage  $\mathfrak{Z}'(f)$  of  $\mathfrak{Y}^0(f)$  such that  $\mathfrak{Z}'(f)$  is close to  $\mathfrak{Z}'(g)$ . Since the linear coordinate at  $\alpha$  is structurally stable, every preimage of  $\mathfrak{Z}' \subset X(g)$  of  $\mathfrak{Y}^0(g)$  has a counterpart  $\mathfrak{Z}'(f)$  if  $\mathfrak{Z}'$  is close to  $\alpha$ .

The *extended flower*  $\tilde{X}(f)$  is  $X(f) \cup \bigcup_{i=0}^{\text{an}} f^i(O)$ . Since  $f$  is close to  $g$ , the flower  $\tilde{X}(f)$  is also in a small neighborhood of  $\bar{Z}_*$ .



9.1.2. *Lamination  $\mathcal{F}$ .* For a fixed  $\mathbf{n} \ll 0$ , we defined the lamination  $\mathcal{F}_{\mathbf{n}}$  in Lemma 9.3. For  $m \leq \mathbf{n}$  and  $p \in \mathcal{M}_m$ , we define

$$\mathcal{F}_p := \{f \in \mathcal{B} \mid \mathcal{R}^{\mathbf{n}-m}(f) \in \mathcal{F}_{\mathcal{R}^{\mathbf{n}-m}(p)}\}.$$

Since  $\mathcal{R}$  is hyperbolic,

$$(9.7) \quad \mathcal{F}_m := \{\mathcal{F}_p \mid p \in \mathcal{M}_m\} \quad \text{and} \quad \mathcal{F} := \{\mathcal{W}^s\} \cup \bigcup_{m \leq \mathbf{n}} \mathcal{F}_m$$

form codimension-one stable laminations in a neighborhood of  $f_*$ . A pacman  $f \in \mathcal{F}_p$  with  $p \in \mathcal{M}_m$  has nice flowers  $X(f)$  and  $\tilde{X}(f)$  that are the full lifts of  $X(\mathcal{R}^{\mathbf{n}-m}f)$  and  $\tilde{X}(\mathcal{R}^{\mathbf{n}-m}f)$  respectively. The flowers  $X(f)$  and  $\tilde{X}(f)$  satisfy the same conditions as  $X(\mathcal{R}^{\mathbf{n}-m}f)$  and  $\tilde{X}(\mathcal{R}^{\mathbf{n}-m}f)$ . In particular,  $X(f)$  and  $\tilde{X}(f)$  are in a small neighborhood of  $\tilde{Z}_*$ ; and all pacmen in  $\mathcal{F}_p$  are hybrid conjugate in neighborhoods of their valuable flowers.

Let us write

$$p_* = p_{c(\theta_*)} =: \mathcal{X}_{\text{Pacm}}(f_*) \quad \text{and} \quad \mathcal{F}_{p_*} = \mathcal{F}_* := \mathcal{W}^s.$$

We obtain the parameterization of leaves of  $\mathcal{F}$  by

$$\mathcal{M}' := \{p_*\} \cup \bigcup_{m \leq \mathbf{n}} \mathcal{M}_m$$

such that

$$(9.8) \quad \mathcal{R}(\mathcal{F}_p) \subset \mathcal{F}_{\mathcal{R}^m(p)}, \quad p \in \mathcal{M}'.$$

*Proof of the **scaling** theorem (the first part of Theorem 1.1).* Since  $p_*$  and  $f_*$  are hybrid conjugate in neighborhoods of their Siegel disks, there is a compact analytic renormalization operator  $\mathcal{R}_2: \mathcal{U} \dashrightarrow \mathcal{B}$  from a small neighborhood of  $p_*$  in the space of quadratic polynomials to a small neighborhood of  $f_*$ , see §3.2.8. Since maps in a small neighborhood of  $p_*$  have different multipliers at their  $\alpha$ -fixed points, the image of the slice  $\mathcal{U}$  is transverse to the lamination  $\mathcal{F}$  in a small neighborhood of  $f_*$ .

The operator  $\mathcal{R}_2$  acts on the rotation angles of indifferent maps as  $R_{\text{prm}}^{\mathbf{k}m}$  for some  $k \in \mathbb{N}$ . We claim that for every  $p$ ,  $\tilde{p} := \mathbf{R}_{\text{prm}}^{\mathbf{k}m}(p) \in \mathcal{M}'$ , we have  $\mathcal{R}_2(p) \in \mathcal{F}_{\tilde{p}}$ . Indeed, let us define  $g_p$  to be the unique intersection of  $\mathcal{F}_p$  with  $\mathcal{R}_2(\mathcal{U})$ . We define  $\tilde{p} \in \mathcal{U}$  to be the preimage of  $g_p$  via  $\mathcal{R}_2$ . The nice flower  $\tilde{X}(g_p)$  lifts to the dynamical plane of  $\tilde{p}$ ; we denote the lift by  $\tilde{X}(\tilde{p})$ . Since  $\tilde{p}$  is a quadratic polynomial, the valuable flower  $\tilde{X}(\tilde{p})$  uniquely determines  $\tilde{p}$ . Comparing the combinatorial rotation numbers at the  $\alpha$ -fixed points, we obtain  $\tilde{p} = \mathbf{R}^{-\mathbf{k}m}(p)$ .

Since the holonomy along  $\mathcal{F}$  is asymptotically conformal [L3, Appendix 2, The  $\lambda$ -lemma (quasi-conformality)], the hyperbolicity of  $\mathcal{R}$  and the holonomy along  $\mathcal{F}$  imply the scaling result.  $\square$

9.2. **Homoclinic configuration.** Recall that the operator  $\mathcal{R}_{\text{QL}}^{\bullet 2}$  on  $\mathcal{F}_{\mathbf{n}}$  is defined by (9.5). Set

- $\mathcal{R}_{\text{QL}}^{\bullet 2}(g) := \mathcal{R}_{\text{QL}}^{\bullet 2} \circ \mathcal{R}^{\mathbf{n}-m}(g)$  for  $g \in \mathcal{F}_m$  with  $m \leq \mathbf{n}$ ;
- $\mathfrak{R} = \mathcal{R}_{\text{QL}}^{\bullet 3} := \mathcal{R}_{\text{QL}} \circ \mathcal{R}_{\text{QL}}^{\bullet 2}$ , and
- $\mathcal{M} \setminus \{\text{cusp}\} := \mathcal{R}_{\text{QL}}^{\bullet 3}(\mathcal{M}_{\mathbf{n}} \setminus \{\text{cusp}\}) = \mathcal{R}_{\text{QL}}^{\bullet 3}(\mathcal{M}_m \setminus \{\text{cusp}\})$ ,

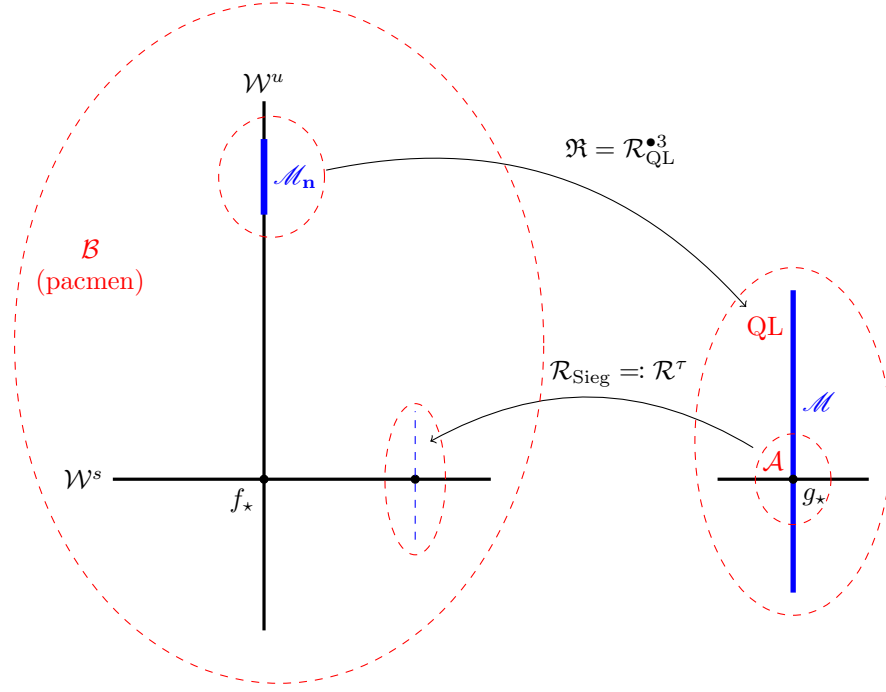

FIGURE 43. The space of pacmen  $\mathcal{B}$ , the quadratic-like renormalization operator  $\mathcal{R}_{\text{QL}}^{\bullet 3}: \mathcal{B} \dashrightarrow \text{QL}$  defined on a neighborhood of  $\mathcal{M}_n \setminus \{\text{cusp}\}$ , and a Siegel renormalization operator  $\mathcal{R}_{\text{Sieg}}: \mathcal{A} \rightarrow \mathcal{B}$  defined on a neighborhood  $\mathcal{A}$  of  $g_*$ .

where  $\mathcal{R}_{\text{QL}}$  is the quadratic-like operator, see §3.1.1. By Theorem 7.9,  $\mathcal{M}$  is a copy of the Mandelbrot set, and  $\chi: \mathcal{M} \rightarrow \mathcal{M}$  is the canonical straightening homeomorphism. Note that the renormalization change of variables of  $\mathcal{R}_{\text{QL}}^{\bullet 3} | \mathcal{F}_n$  is linear, but the renormalization change of variables of  $\mathcal{R}_{\text{QL}}^{\bullet 3} | \mathcal{F}_m$  is non-linear for  $m < n$ .

By construction and (9.6),

$$(9.9) \quad \chi_{\text{Pacm}} \circ \mathcal{R}_{\text{QL}}^{\bullet 3}(g) = \mathcal{R}_{\text{QL}}^3 \circ \chi_{\text{Pacm}}(g), \quad g \in \mathcal{F}.$$

9.2.1. *Extension of  $\mathcal{F}$ .* Denote by  $g_* \in \mathcal{M}$  the unique Siegel map on the main hyperbolic component of  $\mathcal{M}$  such that  $g_*$  is hybrid equivalent to  $f_*$ . Equivalently,  $\chi(g_*) = p_* = \chi_{\text{Pacm}}(f_*)$ . By §3.2.8, there is a compact analytic renormalization operator  $\mathcal{R}_{\text{Sieg}}: \mathcal{A} \rightarrow \mathcal{B}$ , where  $\mathcal{A}$  is a Banach neighborhood of  $g_*$ , see Figure 43.

**Lemma 9.4.** *The stable lamination  $\mathcal{F}$  admits a pullback via  $\mathcal{R}_{\text{Sieg}}$ . For all sufficiently big  $m < 0$ , all leaves of the lamination  $\mathcal{R}_{\text{Sieg}}^*(\mathcal{F}_m)$  transversally intersect  $\mathcal{M}$ .*

*Proof.* By the same argument as in Lemma 9.3,  $\mathcal{R}_{\text{Sieg}}^*(\mathcal{F})$  is a lamination with complex-analytic leaves.

Let  $W'$  be a small neighborhood of  $g_*$  in  $\mathcal{R}_{\text{QL}}^{\bullet 3}(\mathcal{W}^u)$ . Then  $W^s$  transversally intersects  $\mathcal{R}_{\text{Sieg}}(W')$  at  $\mathcal{R}_{\text{Sieg}}(g_*)$ . Since  $\mathcal{F}$  forms a lamination, all the leaves of  $\mathcal{F}_m$  transversally intersect  $\mathcal{R}_{\text{Sieg}}(W')$  for  $m \ll n$ . Taking the pullback, we obtain

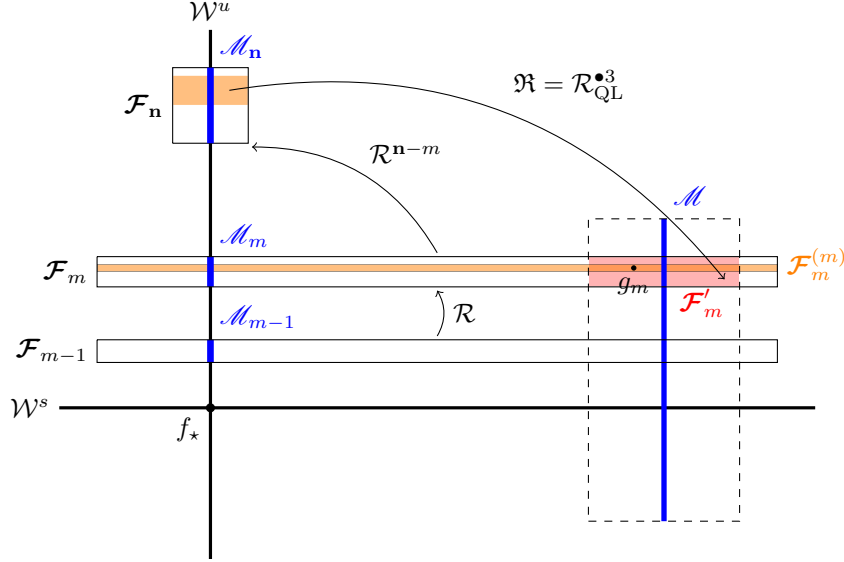

FIGURE 44. Homoclinic dynamics: the operator  $\mathfrak{R}$  has a unique hyperbolic fixed point  $g_m \in \mathcal{F}_m$ . (Note that we slightly simplified the picture and made leaves in  $\mathcal{F}$  connected, see (9.10).)

that the leaves of  $\mathcal{R}_{\text{Sieg}}^*(\mathcal{F}_m)$  transversally intersect  $W'$ . Clearly, all the points in the intersections are within the non-escaping set  $\mathcal{M}$ .  $\square$

Let us extend the lamination  $\mathcal{F}$  by adding  $\mathcal{R}_{\text{Sieg}}^*\mathcal{F}$  to  $\mathcal{F}$ . The operator  $\mathcal{R}_{\text{Sieg}}$  acts on the rotation numbers of indifferent pacmen as  $R_{\text{prm}}^{m\tau}$  for some  $\tau \geq 1$ . Let us view  $\mathcal{R}_{\text{Sieg}}$  as  $\mathcal{R}^\tau$ . Namely, we factorize  $\mathcal{R}_{\text{Sieg}}$  as a composition of  $\tau$  operators, each operator acts on the rotation numbers of indifferent maps as  $R_{\text{prm}}^m$ . With this convention, the lamination  $\mathcal{F}$  naturally extends to  $\mathcal{A}$ . Namely, for every  $\mathcal{F}_p$  in  $\mathcal{F}_m$  with  $m \leq n - \tau$ , we define  $\mathcal{F}'_p$  to be the preimage of  $\mathcal{F}_{R_{\text{prm}}^{m\tau}(p)}$  under  $\mathcal{R}_{\text{Sieg}}$ , and we set

$$(9.10) \quad \mathcal{F}_p := \mathcal{F}_p \cup \mathcal{F}'_p.$$

Similarly,  $\mathcal{F}$  is extended to  $\mathcal{R}^i(\mathcal{A})$  for  $i < \tau$ . The new extended lamination  $\mathcal{F}$  is still  $\mathcal{R}$ -invariant.

**9.2.2. Hyperbolic horseshoe.** Let  $p$  be a hyperbolic fixed point of a  $C^2$ -smooth diffeomorphism. If the stable and unstable manifolds  $W^s$  and  $W^u$  of  $p$  intersect, then any point  $q \in W^s \cap W^u$  is called *homoclinic* to  $p$ . If the intersection is transversal, then there is a hyperbolic set in a neighborhood of the orbit of  $q$  union  $p$ , see [PT, Chapter 1, Theorem 1] for reference. We will now adopt this principle to show that there is a hyperbolic renormalization horseshoe of  $\mathfrak{R}$  near  $g_* \in W^s \cap \mathfrak{R}(W^u)$ , where  $\mathfrak{R}(W^u)$  can be viewed as an extension of  $W^u$ .

Let  $\mathcal{F}'_m$  be  $\mathcal{F}_m$  intersected with a small neighborhood of  $\mathcal{M}$ , see Figure 44. We define  $\mathcal{F}_n^{(m)}$  to be the preimage of  $\mathcal{F}'_m$  under  $\mathfrak{R} | \mathcal{F}_n$ , and we define  $\mathcal{F}_k^{(m)} \subset \mathcal{F}_k$  to be the preimage of  $\mathcal{F}_n^{(m)}$  under  $\mathcal{R}^{n-k}$  (extended to a neighborhood of  $g_*$  as above).

**Lemma 9.5** (The second part of Theorem 1.1: **rigidity**). *For  $\mathbf{k} \ll \mathbf{n}$  the operator*

$$(9.11) \quad \mathfrak{R}: \bigcup_{m, k \leq \mathbf{k}} \mathcal{F}_m^{(k)} \rightarrow \bigcup_{m \leq \mathbf{k}} \mathcal{F}'_m$$

*is uniformly hyperbolic.*

*Let  $\mathcal{H}$  be the hyperbolic set of (9.11); i.e. the set of points with bi-infinite orbit, and let  $\mathbf{H}$  be the non-escaping set of*

$$\mathbf{R}_{QL}^3: \bigcup_{t \leq \mathbf{k}} \mathcal{M}_t \rightarrow \bigcup_{t \leq \mathbf{k}} \mathcal{M}_t.$$

*Then*

- *every connected component of  $\mathbf{H}$  is a singleton; and*
- *$\mathfrak{R}: \mathcal{H} \rightarrow \mathcal{H}$  is parametrized by the natural extension of  $\mathbf{R}_{QL}^3: \mathbf{H} \rightarrow \mathbf{H}$  via  $\chi_{\text{Pacm}}$ .*

In particular,  $\mathfrak{R}: \mathcal{F}_m^{(m)} \rightarrow \mathcal{F}'_m$  has a unique hyperbolic fixed point  $g_m \in \mathcal{F}_m^{(m)} \cap \mathcal{F}'_m$ , see Figure 44.

*Proof.* Fix big  $t \gg 0$  and  $\mathbf{k} \ll \mathbf{n} - 2t$ . Consider  $g \in \mathcal{F}_m^{(k)}$  with  $m, k \leq \mathbf{k}$ . Then for  $i \in \{t, t+1, \dots, -m + \mathbf{n} - t\}$  all the parameters  $\mathcal{R}^i(g)$  are close to  $f_*$ , see Figure 45. Using standard cone-field arguments, the operator  $\mathcal{R}^{-m+\mathbf{n}-2t}$  is hyperbolic at  $\mathcal{R}^t(g)$  with expanding and contracting rates  $\gtrsim \sigma^{-m+\mathbf{n}-2t}$  and  $\lesssim \delta^{-m+\mathbf{n}-2t}$  respectively, where  $\sigma > 1 > \delta$ . Postcomposing and precomposing with finitely many iterates, we obtain the required hyperbolicity of  $\mathfrak{R} = \mathcal{R}^{-m+\mathbf{n}}$  at  $g$  with big expanding and contracting rates.

We have a natural surjective semi-conjugacy  $\pi$  from  $\mathfrak{R}: \mathcal{H} \rightarrow \mathcal{H}$  to the natural extension of  $\mathbf{R}_{QL}^3: \mathbf{H} \rightarrow \mathbf{H}$ . Since  $\varepsilon$ -close orbits for a hyperbolic map coincide,  $\pi$  is a homeomorphism and every connected component of  $\mathbf{H}$  is a singleton.  $\square$

*Theorem 1.1: proof of JLC.* Local connectivity of every map in  $\mathcal{H}$  follows (see §3.1.3) from unbranched *a priori* bounds:

**Lemma 9.6.** *Every map in  $\mathcal{H}$  has unbranched a priori bounds.*

*Proof.* For  $f \in \mathcal{H}$  set  $f_{3n} := (\mathfrak{R})^n(f)$  and consider its secondary quadratic-like renormalization

$$(9.12) \quad \mathcal{R}_{QL}^{\bullet 2}(f_{3n}): O(f_{3n}) \rightarrow O'(f_{3n}),$$

see (9.5). Since  $f_{3n} \in \mathcal{H}$ , the modulus  $\text{mod}(O'(f_{3n}) \setminus O(f_{3n}))$  is uniformly bounded from below.

Recall that the unbranched condition holds for (9.5). Since the renormalization change of variables is conformal, (9.12) lifts to the dynamical plane of  $f$ . The lift is the quadratic-like map  $\mathcal{R}_{QL}^{3n+2}f$  with a definite modulus satisfying the unbranched condition.  $\square$

$\square$

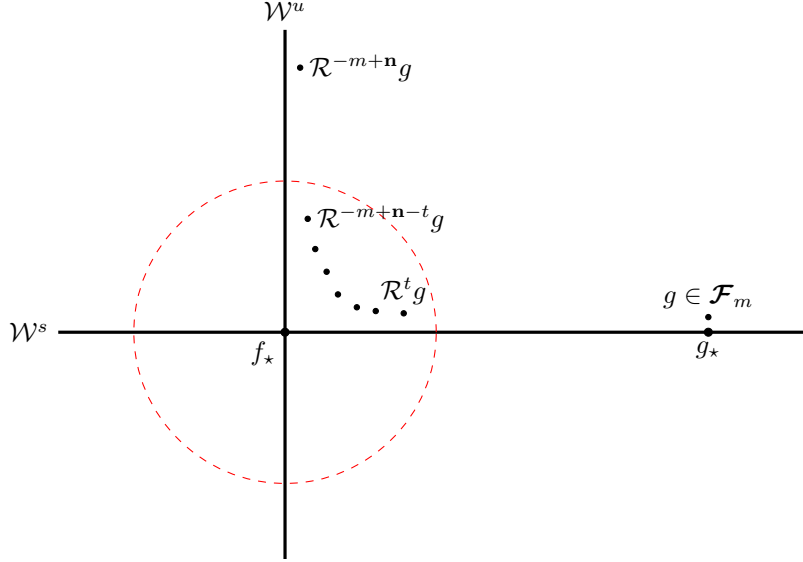

FIGURE 45. The orbit of  $g \in \mathcal{F}_m$  stays within a small neighborhood of  $f_*$  for many iterates.

9.2.3. *Upper semi-continuity of the valuable flower.* Along the lines, we also obtained a geometric control of the postcritical sets of maps in  $\mathcal{F}$ . Let us write  $X(f) := \overline{Z}_f$  for a Siegel map  $f \in \mathcal{W}^s$ . Then  $X(f)$  depends upper semi-continuously on  $f \in \mathcal{F}$ . Moreover, if a sequence  $f_n \in \mathcal{F}_n$  tends to  $f \in \mathcal{W}^s$  as  $n \rightarrow -\infty$ , then  $\mathfrak{P}(f_n)$  and  $\tilde{X}_{\text{up}}(f_n)$  tend to  $\partial Z_f = \mathfrak{P}(f)$ . Indeed, by Theorem 8.2, the valuable flower  $\tilde{X}(f_n)$  is within a certain Siegel triangulation  $\Delta(f_n)$ . And the wall  $\mathbb{I}(f_n)$  of  $\Delta(f_n)$  contains  $\tilde{X}_{\text{up}}(f_n)$  – the cycle of secondary small Julia sets. Since  $\Delta(f_n)$  is a full lift of  $\Delta(f_{n+1})$ , Lemma 3.2 implies that  $\Delta(f_n)$  tends to  $\overline{Z}_f$  while  $\mathbb{I}(f_n)$  tends to  $\partial Z_f$ .

The upper semi-continuity can easily be transferred to a parameter neighborhood of any Siegel map. Indeed, if  $g$  is Siegel map, then there is a hyperbolic renormalization operator  $\mathcal{R}$  around a fixed pacman  $f_*$  as above such that a certain renormalization operator  $\mathcal{R}_{\text{Sieg}}$  maps a neighborhood of  $g$  to a neighborhood of  $f_*$ . Pulling back the lamination  $\mathcal{F}$  under  $\mathcal{R}_{\text{Sieg}}$ , we obtain the upper semi-continuity of  $X(f)$  for  $f \in \mathcal{R}_{\text{Sieg}}^*(\mathcal{F})$ . In [DLS, Appendix C] a much stronger conjecture was stated that  $\mathcal{F}$  can be extended to a lamination parametrized by a subset of the Mandelbrot set containing the main molecule of the Mandelbrot set.

9.3. **Positive measure.** In this section we show that for  $m \ll \mathbf{k}$ , the Julia set of  $g := g_m$  has positive measure. We will show that  $g$  contains  $\mathbf{s} \gg 0$  trapping disks (see Figures 46 and 47), then, following the lines of [AL2, Section 6], we will deduce that  $\mathfrak{J}(g)$  inherits a positive measure from  $\mathfrak{R}(g_*)$ .

**Remark 9.7.** *We can re-state the positive-area argument as follows. Once a full copy of the Mandelbrot set  $\mathcal{M}_0$  is recognized on the unstable manifold, methods of [AL2] imply that the Julia set has positive measure for the parameter associated with a sufficient pacman antirenormalization of  $\mathcal{M}_0$ . In [AL2], a full primitive copy*

is constructed by following a certain periodic point whose orbit is close to the Siegel disk. In this paper we use puzzle techniques to recognize a full satellite copy of the Mandelbrot set. (Potentially, puzzle techniques may allow one to recognize all the existing copies on the unstable manifold.)

9.3.1. *Notations.* By saying that a set  $K$  is *well inside* a domain  $D \Subset \mathbb{C}$  we mean that  $K \Subset D$  with a definite  $\text{mod}(D \setminus K)$ . The meaning of expressions *bounded*, *comparable*, etc. is similar.

Given a pointed domain  $(D, \beta)$ , we say that  $\beta$  lies in the *middle* of  $D$ , or equivalently, that  $D$  has a *bounded shape* around  $\beta$  if

$$\max_{\zeta \in \partial D} |\beta - \zeta| \leq C \min_{\zeta \in \partial D} |\beta - \zeta|.$$

We set

- $g := g_m: U \rightarrow V$ ;
- $\mathfrak{J} := \mathfrak{J}(g)$ ;
- $g_\bullet = g^{t(m)}: U_\bullet \rightarrow V_\bullet$  to be the  $\mathcal{R}_{\text{QL}}^3$ -pre-renormalization of  $g$  normalized so that  $g_\bullet: U_\bullet \rightarrow V_\bullet$  is conformally conjugate to  $g: U \rightarrow V$  (this is possible because  $g = \mathfrak{R}(g)$ ; note that the conjugacy is not affine);
- $Z$  is the Siegel disk of  $g_\star$  and  $Z'$  is its prefixed Siegel disk of  $g_\star$ ;
- $\mathfrak{J}_\bullet := \mathfrak{J}(g_\bullet) \subset \mathfrak{J}$ ;
- “diam” and “dist” denote the Euclidean diameter and distance.

By a *hyperbolic metric*, we mean the metric of  $V \setminus \overline{\mathfrak{P}}(g)$ , unless specified otherwise. Since

$$g: U \setminus g^{-1}(\overline{\mathfrak{P}}(g)) \rightarrow V \setminus \overline{\mathfrak{P}}(g)$$

is a covering map, while

$$U \setminus g^{-1}(\overline{\mathfrak{P}}(g)) \hookrightarrow V \setminus \overline{\mathfrak{P}}(g)$$

is an inclusion,  $g$  expands (non-uniformly) the hyperbolic metric.

9.3.2. *Parameters  $\eta$  and  $\xi$ .* Let us recall from [AL1] a condition ensuring that the Julia set  $\mathfrak{J}$  of  $g = g_m$  has positive area. Define

- $\eta$  to be the probability for an orbit starting in  $U$  (the domain of  $g$ ) to enter  $U_\bullet$  (the domain of  $g_\bullet$ ),
- $\xi$  to be the probability that an orbit starting in  $V_\bullet \setminus U_\bullet$  will never come back to  $U_\bullet$ .

There is a constant  $C > 0$  independent of  $m$  such that if  $\eta/\xi > C$ , then the Julia set of  $g = g_m$  has positive area. The constant  $C$  depends on geometric bounds (like  $\text{mod}(V \setminus U)$ , see [AL1, §2.7]) that are uniform over  $m \ll \mathbf{k}$ .

9.3.3. *Trapping disks.* Consider the dynamical plane of  $f_\star$ . Below we recall main properties of *trapping disks*; see [AL2, § 4.4.4.] for a detailed discussion. There is an annulus  $A \subset \mathbb{C} \setminus \overline{Z}_\star$  in a small neighborhood of  $\overline{Z}_\star$  and a trapping disk  $D \subset \mathbb{C} \setminus \overline{Z}_\star$  such that (see Figure 46)

- if  $z$  is in the bounded component  $O$  of  $\mathbb{C} \setminus A$ , then  $f(z) \subset O \cup A$ ;
- if  $z \in A$ , then  $f^i(z) \in D$  with  $i \leq q$ , where  $q$  depends on the renormalization scale of  $D$ ;
- a definite portion of  $D$  are in  $\overline{Z}'_\star$ .

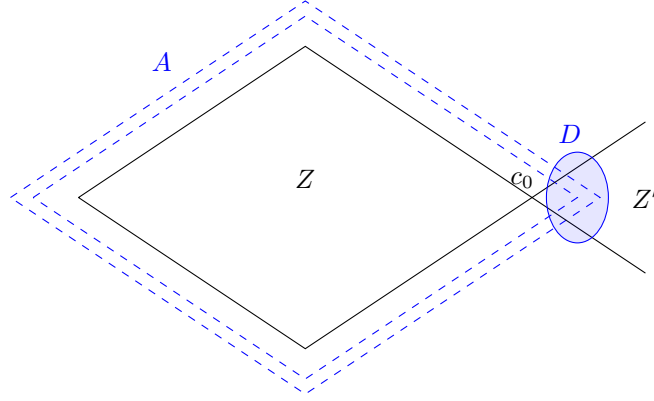

FIGURE 46. A trapping disk  $D \subset \mathbb{C} \setminus \bar{Z}$ : every orbit escaping from the domain surrounded by  $A$  passes through  $D$ . (The annulus  $A$  is close to  $\partial Z$  while  $D$  is close to the critical point  $c_0$ ).

Moreover, all the properties still hold under small shrinking of  $A$  and  $D$ . Therefore, by continuity, the trapping disk  $D$  exist in the dynamical plane of a near by map.

Consider the orbit of  $g$  under the pacman renormalization  $\mathcal{R}$  and note that  $\mathcal{R}^i g$  is close to  $f_*$  if  $i \in \{t, t+1, \dots, -m + \mathbf{n} - t\}$  with  $-m + \mathbf{n} - t \gg t$ , see Figure 45. For such  $i$ , consider the dynamical plane of  $\bar{g} := \mathcal{R}^i g$ . By continuity,  $D$  is a trapping disk for  $\bar{g}$ . Since  $\tilde{X}(\bar{g})$  is in a small neighborhood of  $\bar{Z}_*$  (by §9.2.3),  $A$  surrounds  $\tilde{X}(\bar{g})$ . Let  $\psi_0$  be the renormalization change of variables from the dynamical plane of  $\bar{g}$  to the dynamical plane of  $g$  normalized so that  $\psi_0(c_0(\bar{g})) = c_0(g)$ , see §3.2.13. Then  $D' := \psi_0(D)$  is a trapping disk for  $g$  with the property that every escaping orbit starting in  $\tilde{X}(g)$  passes through  $D'$ . Since  $i$  can be chosen between  $t$  and  $-m + \mathbf{n} - t$ , we can construct pairwise disjoint trapping disks

$$D_0, D_1, \dots, D_s$$

in the dynamical plane of  $g$ , where  $s$  is sufficiently big (if  $m \leq \mathbf{k} \ll \mathbf{n}$  is sufficiently big), see Figure 47. We assume that  $D_0$  is the lift of  $D(\mathcal{R}^t g)$ .

We have the following properties:

**Property 9.8.** *All trapping disks  $D_i$  are within  $\mathbb{C} \setminus \mathfrak{F}$ . For every  $i \leq s$ , a definite portion of  $D_i$  maps to  $\bar{Z}(g_*)$  under one iteration.*  $\square$

Recall that we choose the pre-renormalization domains  $U_\bullet$  and  $V_\bullet$  around the critical value. Since  $D_0$  is the lift of  $D(\mathcal{R}^t g)$  (where  $t$  is independent of  $m$ ), we have:

**Property 9.9.** *There are degree two iterated preimages  $U'_\bullet, V'_\bullet \subset D_0$  of  $U_\bullet$  and  $V_\bullet$  such that  $U_\bullet$  and  $V_\bullet$  occupy a definite portion (i.e. independent of  $m$ .) of  $D_0$ .*  $\square$

9.3.4. *Estimating  $\eta$ .* (Compare with [AL2, Proposition 6.22].) As a consequence of Property 9.9, for any point  $z$  whose orbit passes through the first trapping disk  $D_0$  under the iterates of  $g$ , there exist quasidisks  $U_\bullet(z) \subset V_\bullet(z)$  with bounded dilatation whose size is comparable with  $\text{dist}(z, V(z))$ , and such that

$$f^n(U_\bullet(z)) \subset U_\bullet \text{ and } f^n(V_\bullet(z)) \subset V_\bullet \text{ for some } n = n(z).$$

As a corollary, the landing probability  $\eta$  is bounded below uniformly on  $m$ . Indeed, it is known that almost every point in  $\mathfrak{J}$  lands in  $\mathfrak{J}_\bullet$ , [L1]. Since the Siegel disk  $Z(g_\star)$  occupies a certain area, it is sufficient to check that a definite portion of points  $z \in Z(g_\star) \setminus \mathfrak{J}$  land in  $U_\bullet$ . But any point  $z \in Z(g_\star) \setminus \mathfrak{J}$  on its way from  $Z(g_\star)$  to  $V \setminus U$  must pass through the first trapping disk  $D_0$ . Since  $U_\bullet(z)$  occupies a definite portion of some neighborhood of  $z$ , the statement follows.

9.3.5. *Expansion of  $g \mid (D_i \setminus g^{-1}(\mathfrak{P}))$ .* In this subsection we will verify the following properties:

**Property 9.10** (compare with [AL2, (6.9)]). *The hyperbolic diameter of  $D_i$  is uniformly (on  $i$  and  $m$ ) bounded.*

**Property 9.11** (Compare with [AL2, §6.2.2.]). *The map  $g \mid (D_i \setminus g^{-1}(\overline{\mathfrak{P}}))$  is uniformly expanding with respect to the hyperbolic metric of  $\mathbb{C} \setminus \overline{\mathfrak{P}}(g)$ .*

Property 9.11 has the following explanation. Consider the dynamical plane of the Siegel map  $g_\star$ . Let  $x \notin \overline{Z} \cup \overline{Z}'$  be a point close to  $c_0$ . It was shown by McMullen [McM2] that if

$$\text{dist}(x, \overline{Z}') \leq C \text{dist}(x, \overline{Z}),$$

then  $g_\star$  expands the hyperbolic metric of  $\mathbb{C} \setminus \overline{Z}$  by a factor  $\lambda > 1$  depending only on the constant  $C$ . Recall from §9.2.3 that for a big  $m \ll \mathbf{k}$ , the postcritical set  $\mathfrak{P}(g_m)$  approximates  $\mathfrak{P}(g_\star)$ . Suppose  $x$  belongs to the self-similarity scale  $t$ ; i.e.  $\text{dist}(x, c_0) \asymp \mu_\star^t$ . One can show that if  $-t - m \gg 0$  is sufficiently big, then  $\mathfrak{P}(g_m)$  is sufficiently close to  $\partial Z$  (relative to  $\mu_\star^t$ ) and  $g = g_m$  has a definite expansion at  $x$ . Let us now proceed with the proof of Property 9.11. We need the following fact:

**Property 9.12.** *There is a function  $\tau: \mathbb{R}_{>2} \rightarrow \mathbb{R}_{>1}$  such that*

$$\tau(r) \rightarrow 1 \quad \text{as} \quad r \rightarrow +\infty,$$

*and such that the following property holds. Let  $S_1, S_2$  be two closed connected subsets of  $\mathbb{C}$  such that*

- $1 \in S_1 \cap S_2$  but  $0 \notin S_1 \cup S_2$ ; and
- $S_1 \cap \overline{\mathbb{D}}(tr) = S_2 \cap \overline{\mathbb{D}}(tr)$  for some  $t > 1$  and  $r > 2$ .

*Let  $\rho_1$  and  $\rho_2$  be the hyperbolic densities of  $\mathbb{C} \setminus S_1$  and  $\mathbb{C} \setminus S_2$  with respect to the Euclidean metric. Then*

$$\frac{1}{\tau(r)} \leq \frac{\rho_1(z)}{\rho_2(z)} \leq \tau(r) \quad \text{for } z \in \mathbb{D}(t).$$

□

Consider now a trapping disk  $D_i$ . Recall from §9.3.3 that  $D_i = \psi_0(D)$ , where  $D$  is the trapping disk in the dynamical plane of  $\bar{g} := \mathcal{R}^{n(i)}g$  and  $\psi_0$  is the renormalization change of variables specified so that  $\psi_0(c_0(\bar{g})) = c_0(g)$ .

**Property 9.13.** *Assuming that the trapping disk  $D$  from §9.3.3 is sufficiently close to  $c_0(f_\star)$  and  $\bar{g}$  is sufficiently close to  $f_\star$ , we have:*

- (1)  $\psi_0 \mid D$  is almost an isometry with respect to the hyperbolic metrics of  $\mathbb{C} \setminus \overline{\mathfrak{P}}(\bar{g})$  and  $\mathbb{C} \setminus \overline{\mathfrak{P}}(g)$ ;
- (2)  $\psi_0 \mid D$  is almost an isometry with respect to the hyperbolic metrics of  $\mathbb{C} \setminus \bar{g}^{-1}(\overline{\mathfrak{P}}(\bar{g}))$  and  $\mathbb{C} \setminus g^{-1}(\overline{\mathfrak{P}}(g))$ ;



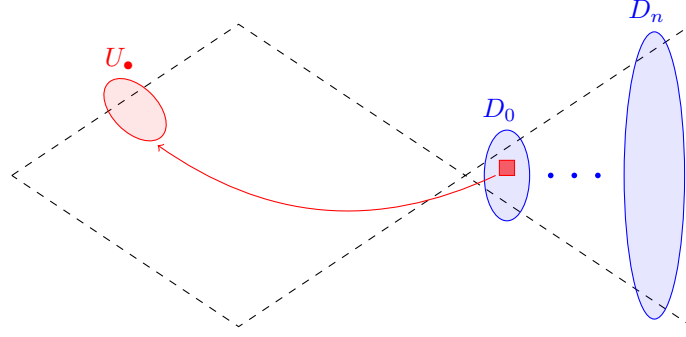

FIGURE 47. Trapping disks at different scales. A definite portion of the first trapping disk  $D_0$  returns to  $U_\bullet$ .

- (3) on  $D$  the hyperbolic metric of  $\mathbb{C} \setminus \overline{\mathfrak{P}}(\bar{g})$  is almost the same as the hyperbolic metric of  $\mathbb{C} \setminus \overline{\mathfrak{P}}(f_\star)$ ;
- (4) on  $D$  the hyperbolic metric of  $\mathbb{C} \setminus \bar{g}^{-1}(\overline{\mathfrak{P}}(\bar{g}))$  is almost the same as the hyperbolic metric of  $\mathbb{C} \setminus f_\star^{-1}(\overline{\mathfrak{P}}(f_\star))$ ; and
- (5) on  $D$  the hyperbolic density of  $\mathbb{C} \setminus f_\star^{-1}(\overline{\mathfrak{P}}(f_\star))$  is by  $\lambda > 1$  smaller than the hyperbolic density of  $\mathbb{C} \setminus \overline{\mathfrak{P}}(f_\star)$ .

*Proof.* Claims 1 and 2 follow from Property 9.12: since  $D$  and  $c_0 \in \mathfrak{P}(\bar{g})$  are deep in  $\text{Dom } \psi_0$  and since  $\psi_0$  respects the postcritical sets,  $\psi_0$  is almost an isometry.

Claims 3 and 4 follow from  $\mathfrak{P}(\bar{g}) \rightarrow \mathfrak{P}(f_\star)$  as  $\bar{g} \rightarrow f_\star$ , see §9.2.3.

Claim 5 is equivalent to a strict expansion of  $f_\star | D \setminus (f_\star^{-1}(\overline{Z}'_\star))$  with respect to the hyperbolic metric of  $\mathbb{C} \setminus \overline{\mathfrak{P}}(f_\star)$ . It can be proven in the same way as Lemma 5.33.  $\square$

*Proof of Properties 9.10 and 9.11 .* Property 9.10 follows from Claim 1 of Property 9.13.

Applying Property 9.13, we obtain that the hyperbolic metric of  $\mathbb{C} \setminus g_\star^{-1}(\overline{\mathfrak{P}}(g))$  is in  $(\lambda - \varepsilon) > 1$  smaller than the hyperbolic metric of  $\mathbb{C} \setminus \overline{\mathfrak{P}}(g)$  uniformly on  $D_i$ . This implies Property 9.11.  $\square$

9.3.6. *Porosity.* A *gap* of radius  $r$  in a set  $S$  is a round disk of radius  $r$  disjoint from  $S$ . The following lemma asserts that if a set  $S$  has density less than  $1 - \varepsilon$  in many scales, then it has small area.

**Lemma 9.14** ([AL2, Lemma 6.23]). *For any  $\rho \in (0, 1), C > 1$  and  $\varepsilon > 0$  there exist  $\sigma \in (0, 1)$  and  $C_1 > 0$  with the following property. Assume that a measurable set  $S \in \overline{\mathbb{D}}(r)$  has the property that for any  $z \in S$  there are  $n$  disks  $\overline{\mathbb{D}}(z, r_k)$  with radii*

$$C^{-1} \rho^{\ell_k} \leq r_k / r \leq C \rho^{\ell_k}, \quad \ell_k \in \mathbb{N}, \quad \ell_1 < \ell_2 < \dots < \ell_n,$$

*containing gaps in  $S$  of radii  $er_k$ . Then  $\text{area } S \leq C_1 \sigma^n r^2$ .*

9.3.7. *Estimating  $\xi$ : outline.* A point in  $V_\bullet \setminus U_\bullet$  escaping  $U$  travels through each trapping disk  $D_i$ . Every  $D_i$  has a definite portion returning to  $Z$  (Property 9.8). Therefore, with high probability, a point in  $V_\bullet \setminus U_\bullet$  escaping  $U$  travels through  $D_0$  many times. Since a definite portion of  $D_0$  returns to  $U_\bullet$  (Property 9.9), a point in  $V_\bullet \setminus U_\bullet$  returns to  $U_\bullet$  with high probability.

We will use the following ingredients. Since almost every point in the Julia set is eventually in a small Julia set, it is sufficient to estimate  $\xi$  for points escaping  $U$ . By expansion, different passages through  $D_i$  create gaps in different scales (Lemma 9.17), thus Lemma 9.14 is applicable. Using area estimates, we obtain that points travel through  $D_0$  many times with high probability (Lemma 9.20).

9.3.8. *Landing branches.* For any point  $z$ , let

$$0 \leq r_1(z) < r_2(z) < \dots < r_n(z) < \dots$$

be all the landing times of orb  $z$  at  $D_i$ , i.e. the moments at which  $g^{r_n(z)}(z) \in D_i$ .

Let  $P^n(z)$  be the pullback of  $D_i$  along  $g^{r(n)}: z \mapsto g^{r(n)}(z) \in D$ . The map

$$T_{P^n(z)} = T^n := g^{r(n)}: P^n(z) \rightarrow D_i$$

is univalent. Let  $\mathcal{P}^n(D_i)$  be the family of all domains  $P = P^n(z)$ .

Combing the Koebe Distortion Theorem and Property 9.9, we obtain:

**Property 9.15** ([AL2, Lemma 6.24]). *The following properties hold.*

- *Landing branches  $T_P: P \rightarrow D_i$  with  $P \in \mathcal{P}(D_i)$  have uniformly (on  $P$  and  $D_i$ ) bounded distortion. The domains  $P \in \mathcal{P}(D_i)$  have a bounded shape and are well inside  $\mathbb{C} \setminus \overline{\mathfrak{F}}(g)$ .*
- *Each domain  $P \in \mathcal{P}^n(D_0)$  contains a pullback of  $V_\bullet$  of comparable size.*

Combining expansion with the fact that the hyperbolic density near  $D_i$  is bounded below, we obtain:

**Property 9.16** ([AL2, Lemma 6.25]). *There is a constant  $C_0$  such that the following holds. If  $P \in \mathcal{P}(D_i)$  intersects  $D_j$ , then*

$$\text{diam } P \leq C_0 \text{diam } D_j.$$

The following lemma asserts that the intersecting pullbacks of  $(D_i)_i$  belong to different scales. The lemma follows from the uniform expansion of  $g \mid D_i$  (Property 9.11) combined with the uniform boundedness of  $D_i$  (Property 9.10) and the fact that the hyperbolic density near  $D_i$  is bounded below.

**Lemma 9.17** ([AL2, Lemma 6.26]). *For any  $\sigma \in (0, 1)$  there is a  $\nu \in \mathbb{N}$  with the following property. Consider a point  $z$  landing at the  $D_{i(t)}$  at moments  $r_t$ , where*

$$t \in \{0, 1, \dots, \nu\} \quad \text{and} \quad 0 \leq r_1 < r_2 < \dots < r_\nu,$$

*and let  $P^t \ni z$  be the corresponding pullback of the  $D_{i(t)}$ . Then*

$$\text{diam } P^\nu < \sigma \text{diam } P^1.$$

9.3.9. *Truncated Poincaré series.* We need to understand how disks in  $\mathcal{P}(D_0)$  intersect. Let  $\mathcal{P}$  be the set of  $P \in \mathcal{P}(D_0)$  that intersect  $D_0$ . Similarly,  $\mathcal{P}^n$  is the set of  $P \in \mathcal{P}^n(D_0)$  that intersect  $D_0$ .

The *truncated Poincaré series* is:

$$\phi_n(\xi) := \sum_{P \in \mathcal{P}^n} \frac{1}{|T'_P(\xi_P)|^2}, \quad \text{where } \xi_P \in P \text{ and } T_P(\xi_P) = P.$$

The following lemma follows from the Koebe Distortion Theorem, Property 9.16, and the observation that the family  $\mathcal{P}^n$  has the intersection multiplicity at most  $n$ ; the proof uses area estimates.

**Lemma 9.18** ([AL2, Lemma 6.28]). *There is a constant  $C > 0$  such that  $\phi_n(\xi) \leq Cn$  for all  $\xi \in D_0$ .*

9.3.10. *Few returns to the base.* Let  $\Sigma$  be the set of points in  $D_0 \setminus \mathfrak{J}$  that under the iterates of  $g$  never return back to  $D_0$ .

**Lemma 9.19** ([AL2, Lemma 6.30]). *For any  $\sigma \in (0, 1)$  and for any natural  $\tau \in \mathbb{N}$ , if  $m \ll \mathbf{k}$  is sufficiently big, then*

$$\text{area } \Sigma \leq C\sigma^\tau \text{area } D_0$$

*Proof.* Since the orbit of  $z$  escapes, it passes through all trapping disks  $D_1, \dots, D_{\mathbf{s}}$ . Each  $D_i$  contains a disk  $W_i$  of bounded shape that maps to the Siegel disk  $Z(g_*)$ . The pullbacks of  $W_i$  create gaps of definite size (distortion theorem) and in different scales (Lemma 9.17). By Lemma 9.14, the area of  $\Sigma$  is small.  $\square$

Set

$$\Sigma_n := \bigcup_{P \in \mathcal{P}^n} T_P^{-1}(\Sigma).$$

As a consequence of Lemmas 9.19 and 9.18, we have:

**Lemma 9.20** ([AL2, Lemma 6.31]). *Under the assumption of Lemma 9.19, there is a constant  $C > 0$  such that for any  $n \in \mathbb{N}$  we have*

$$\text{area } \Sigma_n \leq Cn\sigma^\tau \text{area } D_0.$$

9.3.11. *Many returns to the base.* Set

$$\mathbb{S}^n := \bigcup_{P \in \mathcal{P} \setminus \mathcal{P}^n} P.$$

**Lemma 9.21** ([AL2, Lemma 6.32]). *There exist  $C > 0$  and  $\sigma \in (0, 1)$  such that for any  $n \in \mathbb{N}$  the area of the set of points of  $\mathbb{S}^n$  that never land in  $V_\bullet$  is at most  $C\sigma^n \text{area } D_0$ .*

*Proof.* Each time the orbit of  $z$  passes through  $D_0$ , we have a gap of points of definite size that eventually maps to  $U_\bullet$  (Property 9.9). The gaps are in different scales (Lemma 9.17). By Lemma 9.14, the area of all such  $z$  is small.  $\square$

9.3.12. *Estimating  $\xi$ .*

**Proposition 9.22** ([AL2, Proposition 6.33]). *For any  $\epsilon > 0$ , if  $m \ll \mathbf{k}$  is sufficiently big, then  $\xi < \epsilon$ .*

*Proof.* Let  $Y$  be the set of point in  $D_0$  that never land at  $V_\star$ . There are 3 cases:

- by [L1],  $\text{area}(Y \cap \mathfrak{J}) = 0$  (because almost every point in  $\mathfrak{J}$  is eventually in small Julia sets);
- $\text{area}(Y \cap \mathbb{S}^n)$  is small by Lemma 9.21;
- the area of remaining points in  $Y$  is small by Lemma 9.20.

We can now transfer the escaping density estimate for  $D_0$  to the escaping density estimate for  $V_\bullet \setminus U_\bullet$ , see the argument in [AL2, Proposition 6.33].  $\square$

## REFERENCES

- [AL1] A. Avila and M. Lyubich. Hausdorff dimension and conformal measures of Feigenbaum Julia sets. J. of the AMS, 21 (2008), 305–383.
- [AL2] A. Avila and M. Lyubich. Lebesgue measure of Feigenbaum Julia sets. arXiv:1504.02986.
- [ALM] A. Avila, M. Lyubich, and W. de Melo. Regular or stochastic dynamics in real analytic families of unimodal maps. Invent. math. v 154 (2003), 451–550.

- [BC] X. Buff and A. Cheritat. Quadratic Julia sets of positive area. *Annals Math.*, v. 176 (2012), 673–746.
- [BD] B. Branner and A. Douady. *Surgery on complex polynomials*. Holomorphic dynamics, Mexico, 1986.
- [BR] A. M. Benini and L. Rempe-Gillen. A landing theorem for entire functions with bounded post-singular sets. arXiv:1711.10780.
- [BL] A. M. Benini and M. Lyubich. Repelling periodic points and landing of rays for post-singularly bounded exponential maps, *Annales de l'Institut Fourier* 64 (2014), no. 4, 1493–1520.
- [Ch] D. Cheraghi. Topology of irrationally indifferent attractors. arXiv:1706.02678.
- [CS] D. Cheraghi and M. Shishikura. Satellite renormalization of quadratic polynomials. arXiv:1509.07843.
- [DH1] Étude dynamique des polynômes complexes. *Publication Mathématiques d'Orsay*, 84-02 and 85-04.
- [DH2] A. Douady and J. H. Hubbard. On the dynamics of polynomial-like maps. *Ann. Sc. Éc. Norm. Sup.*, v. 18 (1985), 287 – 343.
- [DK] R. Devaney and M. Krych. Dynamics of  $\exp(z)$ . *Ergodic Theory Dynam. Systems* 4 (1984), no. 1, 35–52.
- [DLS] D. Dudko, M. Lyubich, and N. Selinger. Pacman renormalization and self-similarity of the Mandelbrot set near Siegel parameters. arXiv:1703.01206.
- [DS] A. Dudko and S. Sutherland. On the Lebesgue measure of the Feigenbaum Julia set. arXiv:1712.08638.
- [H] J. H. Hubbard. Local connectivity of Julia sets and bifurcation loci: three theorems of J.-C. Yoccoz. *Topological Methods in Modern Mathematics*, Proceedings of a Symposium in Honor of John Milnor's Sixtieth Birthday, Publish or Perish, Houston, TX, 1993.
- [E] A. Eremenko. On the iteration of entire functions. *Dynamical systems and ergodic theory* (Warsaw, 1986), Banach Center Publ., vol. 23, PWN, Warsaw, 1989, pp. 339–345.
- [EL] A. Eremenko and M. Lyubich. Dynamical properties of some classes of entire functions, *Ann. Inst. Fourier (Grenoble)* 42 (1992), no. 4, 989–1020.
- [RRRS] G. Rottenfuer, J. Rückert, L. Rempe, and D. Schleicher, Dynamic rays of bounded-type entire functions, *Ann. of Math. (2)* 173 (2011), no. 1, 77–125.
- [IS] H. Inou and M. Shishikura. The renormalization for parabolic fixed points and their perturbations. Manuscript 2008.
- [K] J. Kahn. A priori bounds for some infinitely renormalizable quadratics: I. Bounded primitive combinatorics. Preprint Stony Brook, # 5 (2006).
- [J] Y. Jiang. Infinitely renormalizable quadratic Julia sets. Preprint, 1993.
- [KL1] J. Kahn and M. Lyubich. A priori bounds for some infinitely renormalizable quadratics: II. Decorations. *Annals Sci. Ecole Norm. Sup.*, v. 41 (2008), 57–84.
- [KL2] J. Kahn and M. Lyubich. A priori bounds for some infinitely renormalizable quadratics, III. Molecules. In: “Complex Dynamics: Families and Friends”. Proceeding of the conference dedicated to Hubbard's 60th birthday (ed.: D. Schleicher ). Peters, A K, Limited, 2009.
- [L1] M. Lyubich. Typical behaviour of trajectories of a rational mapping of the sphere. *Dokl. Akad. Nauk SSSR*, v. 268 (1982), 29 - 32.
- [L2] M. Lyubich. Dynamics of quadratic polynomials, I-II. *Acta Math.*, v. 178 (1997), 185-297.
- [L3] M. Lyubich. Feigenbaum-Coulet-Tresser Universality and Milnor's Hairiness Conjecture. *Ann. Math.*, v. 149 (1999), 319 - 420.
- [L4] M. Lyubich. *Conformal Geometry and Dynamics of Quadratic Polynomials*. Book in preparation, [www.math.sunysb.edu/~mlyubich/book.pdf](http://www.math.sunysb.edu/~mlyubich/book.pdf).
- [McM1] C. McMullen. *Renormalization and three manifolds which fiber over the circle*. Princeton University Press, 1996.
- [McM2] C. McMullen. Self-similarity of Siegel disks and Hausdorff dimension of Julia sets. *Acta Math.*, v. 180 (1998), 247–292.
- [Mi] J. Milnor. *John Local connectivity of Julia sets: expository lectures*. The Mandelbrot set, theme and variations, 67–116, London Math. Soc. Lecture Note Ser., 274, Cambridge Univ. Press, Cambridge, 2000.
- [Na] S. B. Nadler, Jr. *Continuum Theory. An introduction*. Monographs and Textbooks in Pure and Applied Mathematics, 158, Marcel Dekker, New York, 1992.

- [PT] J. Palis and F. Takens. Hyperbolicity and sensitive chaotic dynamics at homoclinic bifurcations. Cambridge Studies in Advanced Mathematics, Vol 35. Fractal dimensions and infinitely many attractors. 1993.
- [Pe] C. Petersen. Local connectivity of some Julia sets containing a circle with an irrational rotation, Acta. Math.,177, 1996, 163-224.
- [Re] L. Rempe. Rigidity of escaping dynamics for transcendental entire functions. Acta Math. 203 (2009), no 2, 235 –267.
- [SZ] D. Schleicher and J. Zimmer. Escaping points of exponential maps, J. London Math. Soc. (2) 67 (2003), no. 2, 380–400.
- [SY] M. Shishikura and F. Yang. The high type quadratic Siegel disks are Jordan domains. arXiv:1608.04106.
- [Y] B. Yarrington. Local connectivity and Lebesgue measure of polynomial Julia sets. Thesis, Stony Brook, 1995.