

On lexicographic representatives in braid monoids

Ramón Flores, Juan González-Meneses*

August, 2018

Abstract

The language of maximal lexicographic representatives of elements in the positive braid monoid A_n with n generators is a regular language. We describe with great detail the smallest Finite State Automaton accepting such language, and study the proportion of elements of length k whose maximal lexicographic representative finishes with the first generator. This proportion tends to some number $P_{n,1}$, as k tends to infinity, and we show that $P_{n,1} \geq \frac{1}{8}$ for every $n \geq 1$. We also provide an explicit formula, based on the Fibonacci numbers, for the number of states of the automaton.

1 Introduction

The positive braid monoid with n generators, A_n , also known as the spherical type Artin-Tits monoid of type A_n , or as the positive braid monoid on $n + 1$ strands \mathcal{B}_{n+1} , is the monoid with the following presentation:

$$A_n = \left\langle a_1, \dots, a_n \mid \begin{array}{ll} a_i a_j = a_j a_i & \text{if } |j - i| > 1 \\ a_i a_j a_i = a_j a_i a_j & \text{if } |j - i| = 1 \end{array} \right\rangle$$

Since the appearance of the seminal survey included in [1], which in turn reunited different notions that have circulated some years around the group-theoretic community, there has been a growing interest in the role of Finite State Automata in Group Theory. In particular, in the context of Artin groups and monoids, different automata have been proposed, see for example [2] or [6].

In the present paper, we deeply analyze a Finite State Automaton proposed by the second author and V. Gebhardt in [4]. In that paper, a polynomial algorithm is given to select a random element of A_n , among all elements of given length, with uniform probability. The difficulty of this task comes from the fact that a given positive braid β may admit many different words in the generators a_1, \dots, a_n representing it (although all representatives have the same length, as the relations in A_n are homogeneous). In order to be able to count the elements in A_n of length k , one can choose a unique representative for each element. For instance, one can order lexicographically the (finite set of) words representing β , setting $a_1 < a_2 < \dots < a_n$, and choose the smallest element. With this ordering, it is shown in [4] that the language L_n of smallest lexicographic representatives of elements of A_n is a regular language (a fact that was previously known), and the mentioned Finite State Automaton Γ_n accepting this language is defined. It is proved in the mentioned paper that Γ_n is the smallest (in terms of number of states) Deterministic Finite State Automaton accepting L_n . Actually, in [4], the language and the automaton for A_n are denoted L_{n+1} and Γ_{n+1} , respectively, as the index indicates the number of strands instead of the number of generators, but in the present paper we prefer to shift the indices to simplify the notations.

Our immediate motivation to study the mentioned Finite State Automaton comes from our paper [3]. One of our interests there is to determine the limit of the growth rates of the monoids A_n , as n tends

*Both authors partially supported by Spanish Project MTM2016-76453-C2-1-P and FEDER.

to infinity, a computation that in particular builds new and exciting bridges between Group Theory and Combinatorics in one side, and Real Analysis and Modular Forms theory on the other, via the partial theta functions. In our computation, it turns out to be necessary to describe the proportion of lexicographic representatives in the monoid A_n that finish with a given generator. According to the convention in [3], we will consider the *biggest* lexicographic representatives instead of the smallest (as in [4]), and call \mathcal{L}_n the corresponding language. It is easy to see that the smallest Finite State Automaton Γ_n accepting \mathcal{L}_n , studied in [4], coincides with the smallest Finite State Automaton accepting \mathcal{L}_n , just replacing each a_i with a_{n+1-i} in all transitions. More information in Section 2 below.

From now on, Γ_n will denote the smallest Deterministic Finite State Automaton accepting the language of *biggest* lexicographic representatives in A_n , with $a_1 < a_2 < \dots < a_n$. It will be the detailed description of this automaton Γ_n which will allow us to compute the desired proportion, following a reasoning that we briefly sketch now.

The proportion of elements in the language \mathcal{L}_n finishing with a given generator has a sense only if we fix the length of the words, so let $\mathcal{L}_{n,k}$ be the (finite) set of words in \mathcal{L}_n having length k . We see that $\mathcal{L}_{n,0} = \{\epsilon\}$ (the empty word) and $\mathcal{L}_{n,1} = \{a_1, \dots, a_n\}$. Also,

$$\mathcal{L}_{n,2} = \{a_1a_1, a_1a_2\} \cup \{a_2a_1, a_2a_2, a_2a_3\} \cup \dots \cup \{a_na_1, a_na_2, \dots, a_na_n\}.$$

Notice that the words $a_i a_j$ with $j \geq i+2$ do not appear, as in that case $a_i a_j = a_j a_i$ in A_n , and the latter is the biggest lexicographic representative. The case of $\mathcal{L}_{n,3}$ is more involved, as we must also take into account the relations $a_i a_{i+1} a_i = a_{i+1} a_i a_{i+1}$.

Recall that \mathcal{L}_n is a regular language. This implies that, when k tends to infinity, the proportion of words in $\mathcal{L}_{n,k}$ which end at a given state s of the automaton tends to a well defined limit $0 \leq p_s < 1$. The set of numbers p_s for all states s in Γ_n is called the stationary distribution of Γ_n . We can understand p_s as the probability that a very long word in \mathcal{L}_n finishes at the state s (considering all words of given length in \mathcal{L}_n with uniform probability).

We will see that all words in \mathcal{L}_n which end at a given state in Γ_n finish with the same letter. That is, if we see Γ_n as a directed graph, whose arrows are labeled by the generators a_1, \dots, a_n , all the incoming arrows of a given state s have the same label. It follows that, when k tends to infinity, the proportion of words of length k finishing with a_i , tends to the sum of the numbers p_s for all states s whose incoming arrows are labeled by a_i . This limit is thus well defined, and it is the probability that a very long word in \mathcal{L}_n finishes with a_i . Let us denote it by $P_{n,i}$.

It seems natural that for each $n > 2$, the proportion $P_{n,1}$ is greater than $P_{n,i}$ for $i \geq 1$. The question arises about how far is this proportion from the uniform distribution $\frac{1}{n}$. It turns out that the lexicographic representatives ending with a_1 are much more abundant than one could think, since the proportion $P_{n,1}$ has a uniform lower bound, independent of n . We can show the following:

Theorem 5.4. *Let $P_{n,1}$ be the limit, when k tends to infinity, of the proportion of maximal lexicographic representatives of length k in A_n finishing with a_1 . Then $P_{n,1} > \frac{1}{8}$ for every $n \geq 1$.*

Our exhaustive description of the automaton Γ_n also permits to compute in an exact way the number of states, by means of a formula which surprisingly depends on the Fibonacci numbers.

Theorem 4.2 *Let F_n be the n -th Fibonacci number ($F_0 = 0$, $F_1 = 1$, $F_{i+1} = F_i + F_{i-1}$). Let s_n be the number of states of the Finite State Automaton Γ_n accepting the language of maximal (or minimal) lexicographic representatives of elements in the positive braid monoid A_n . Then*

$$s_n = \sum_{i=1}^n \left(\binom{n+1-i}{2} + 1 \right) \cdot F_{2i}$$

Note that it is shown in [4, Corollary 4.17] that Γ_n has at least 2^{n-1} states, but no upper bound for the number of states is given there.

We finish the Introduction by briefly explaining the contents of the paper. In [Section 2](#) we present the automaton and describe some easy properties of it, while in [Section 3](#), the core of the paper, a complete analysis of it is undertaken. [Section 4](#) is devoted to the computation of the number of states of the automaton; and [Section 5](#), which concludes the paper, makes use of the previous results in the paper and some linear algebra from Perron-Frobenius theory, to obtain asymptotic properties of the braid monoids, and in particular the desired results concerning proportions. We end the paper with an appendix showing how to compute the incidence matrix of the automaton Γ_n , and providing the numerical results of our computations.

2 The automaton

A standard reference about finite state automata in group theory is [\[1\]](#), and a modern approach can be found in [\[5\]](#).

In this paper, a finite state automaton Γ will be given as a directed graph, whose vertices will be called *states*, and whose arrows, called *transitions*, are labeled by letters from a finite alphabet $\{a_1, \dots, a_n\}$. There will be one special vertex called the *initial state*. Γ is a Deterministic Finite State Automaton (DFSA) if for every state s and every $i \in \{1, \dots, n\}$, there is at most one arrow starting at s and labeled a_i . All states in Γ will be considered to be *accepted*.

A *path* α in Γ is a sequence of arrows $\alpha_1, \dots, \alpha_t$ such that the target of α_i equals the source of α_{i+1} , for $i = 1, \dots, t-1$. The source of the path α is the source of α_1 , and the target of α is the target of α_t . The word associated to α is the concatenation of the labels of $\alpha_1, \alpha_2, \dots, \alpha_t$. A word w in the alphabet $\{a_1, \dots, a_n\}$ is *accepted* by Γ if there is a path in Γ whose source is the initial state, and whose associated word is w . The set of accepted words form the *language* accepted by Γ .

Given the way in which we are going to deal with the natural inclusions $A_1 \subset A_2 \subset A_3 \subset \dots$ and the notation of [\[3\]](#), it will be convenient for us to consider the *biggest* lexicographic representatives, instead of the smallest as in [\[4\]](#). This is not a big issue, as the map ρ sending a_i to a_{n+1-i} is a monoid automorphism of A_n (as it can be immediately deduced from the monoid presentation) and, applied to words, it sends the smallest lexicographic representative of a braid β to the biggest lexicographic representative of $\rho(\beta)$, and vice-versa. In other words, the language of biggest representatives \mathcal{L}_n for elements in A_n with $a_1 < a_2 < \dots < a_n$ corresponds (via ρ) to the language of smallest representatives, also with $a_1 < a_2 < \dots < a_n$. So, for every $n \geq 1$, we will use the definition of the DFSA in [\[4\]](#) to describe a DFSA Γ_n , with alphabet $\{a_1, \dots, a_n\}$, whose accepted language is the set \mathcal{L}_n of biggest lexicographic representatives of elements of A_n .

Recall that A_n is the monoid of positive braids with n generators. In this monoid we say that β_1 is a prefix of β , and we write $\beta_1 \preceq \beta$, if there exists $\beta_2 \in A_n$ such that $\beta = \beta_1\beta_2$. Given a braid $\beta \in A_n$, we denote by $\omega(\beta) \in \mathcal{L}_n$ its biggest lexicographic representative. Conversely, given a word w in the alphabet $\{a_1, \dots, a_n\}$, we will denote by $\overline{w} \in A_n$ the braid it represents. It is clear that $\overline{\omega(\beta)} = \beta$ for every $\beta \in A_n$, and that $\omega(\overline{w}) = w$ if and only if $w \in \mathcal{L}_n$.

Given a word w in the alphabet $\{a_1, \dots, a_n\}$, we define the *support* of w , denoted $\text{supp}(w)$, as the set of letters which appear in w . Notice that applying a relation from the presentation of A_n does not change the support of a word. It follows that all words representing a given braid β have the same support, so we can talk about the *support* of β , denoted $\text{supp}(\beta)$, as the support of any of its representatives. Also, applying a relation from the presentation of A_n does not change the length of a word, so all representatives of a braid have the same length, and we can talk about the *length* $|\beta|$ of a braid β , as the length of any of its representatives.

Given $\beta \in A_n$, we say that a decomposition $\beta = \beta_1\beta_2$ is *permitted* if $\omega(\beta) = \omega(\beta_1)\omega(\beta_2)$, and is *forbidden* otherwise. Notice that, if $|\beta| = k$, there is exactly one permitted decomposition of β for each number $k_1 = 0, \dots, k$. Indeed, the word $w = \omega(\beta)$ has a unique prefix w_1 of length k_1 . Hence, if we write

$w = w_1 w_2$, we have that $\beta = \overline{w_1} \overline{w_2}$ is the only permitted decomposition whose left factor has length k_1 .

For example, if we consider the braid $\beta = a_1 a_2 a_1 \in A_n$, the decomposition given by $\beta_1 = a_1$ and $\beta_2 = a_2 a_1$ is forbidden, because $\omega(\beta_1) = a_1$, $\omega(\beta_2) = a_2 a_1$, but $\omega(\beta) = a_2 a_1 a_2$, which is not the same word as $\omega(\beta_1)\omega(\beta_2) = a_1 a_2 a_1$. The only permitted decompositions of β are those obtained from prefixes of its lexicographic representative $a_2 a_1 a_2$.

Notice that the biggest lexicographic representative of a braid β is determined by its permitted decompositions. Hence, it is also determined by its forbidden decompositions.

If a decomposition $\beta = \beta_1 \beta_2$ is forbidden, we say that β_2 is *forbidden after* β_1 . It is important to notice that if β_2 is forbidden after β_1 , then $\beta_2 \beta_3$ is also forbidden after β_1 , for every $\beta_3 \in A_n$. Therefore, in order to determine all braids which are forbidden after β_1 , it suffices to know those which are *minimal* with respect to the prefix order. This justifies the following definition.

Definition 2.1. [4] Given a braid $\beta_1 \in A_n$, the set of *minimal forbidden prefixes* after β_1 is:

$$F_n(\beta_1) = \min_{\preceq} \{\beta_2 \in A_n; \omega(\beta_1 \beta_2) \neq \omega(\beta_1)\omega(\beta_2)\}.$$

As we mentioned before, $F_n(\beta_1)$ determines the whole set of forbidden braids after β_1 , which in turn determines the set of words in \mathcal{L}_n that start with $\omega(\beta_1)$. The advantage of this notion is that there is only a finite number of sets of the form $F_n(\beta_1)$, as we will see. Therefore, we can construct a DFSA which accepts the language \mathcal{L}_n in the following way:

Definition 2.2. [4] The automaton Γ_n is a directed graph defined as follows.

- The vertices of Γ_n correspond to the sets of the form $F_n(\beta_1)$ for $\beta_1 \in A_n$.
- Whenever $a_j \notin F_n(\beta_1)$, there is an arrow labeled a_j whose source is $F_n(\beta_1)$ and whose target is $F_n(\beta_1 a_j)$.

Theorem 2.3. [4] Γ_n is a well defined DFSA, whose accepted language is \mathcal{L}_n . Moreover, it is the smallest DFSA (in terms of number of states) accepting \mathcal{L}_n .

We have an immediate consequence of the above result:

Corollary 2.4. Let $\beta_1, \beta'_1, \beta_2 \in A_n$. If $\beta_1 \beta_2$ is a permitted decomposition, and $F_n(\beta_1) = F_n(\beta'_1)$, then $\beta'_1 \beta_2$ is a permitted decomposition and $F_n(\beta'_1 \beta_2) = F_n(\beta_1 \beta_2)$.

Proof. Let $\beta = \beta_1 \beta_2$, $w = \omega(\beta)$, $w_1 = \omega(\beta_1)$ and $w_2 = \omega(\beta_2)$. Since the decomposition $\beta = \beta_1 \beta_2$ is permitted, we have $w = w_1 w_2$. We can then read the word $w_1 w_2$ in the automaton Γ_n , starting at the initial state. After reading w_1 , we are placed at the state $F_n(\beta_1)$. The final state ($F_n(\beta)$) only depends on the current state $F_n(\beta_1)$, and the remaining part of the word, w_2 .

Now let $w'_1 = \omega(\beta'_1)$. Since $F_n(\beta_1) = F_n(\beta'_1)$, it follows that there is a path in Γ_n labeled by w'_1 , starting at the initial state and finishing at $F_n(\beta_1)$. If we continue reading the word w_2 , we will finish at the state $F_n(\beta)$. Hence, there is a path in Γ_n labeled by $w'_1 w_2$, starting at the initial state and finishing at $F_n(\beta)$. This implies that $w'_1 w_2 \in \mathcal{L}_n$, that $\beta'_1 \beta_2$ is permitted, and that $F_n(\beta'_1 \beta_2) = F_n(\beta) = F_n(\beta_1 \beta_2)$. \square

3 Description of the automaton

We want to describe the automaton Γ_n in detail. Hence, we will describe the states $F_n(\beta_1)$, and the transitions $F_n(\beta_1) \xrightarrow{a_j} F_n(\beta_1 a_j)$.

First of all, it is clear that $F_n(1) = \emptyset$. Then, one can compute all possible sets of minimal forbidden prefixes, with the help of the following crucial result:

Proposition 3.1. [4] Let $\beta_1 \in A_n$, and suppose that $a_j \notin F_n(\beta_1)$, so there is an arrow $F_n(\beta_1) \xrightarrow{a_j} F_n(\beta_1 a_j)$ in the automaton Γ_n . One has:

1. If $a_i \in F_n(\beta_1)$ for some $i < j - 1$, then $a_i \in F_n(\beta_1 a_j)$.
2. If $a_i a_{i+1} \cdots a_{j-1} \in F_n(\beta_1)$ for some $i < j$, then $a_i a_{i+1} \cdots a_j \in F_n(\beta_1 a_j)$.
3. If $a_i a_{i+1} \cdots a_k \in F_n(\beta_1)$, with $i < j \leq k$, then $a_i a_{i+1} \cdots a_k \in F_n(\beta_1 a_j)$.
4. If $a_j a_{j-1} \in F_n(\beta_1)$, then $a_{j-1} \in F_n(\beta_1 a_j)$.
5. If $a_j a_{j+1} \cdots a_k \in F_n(\beta_1)$, with $j < k$, then $a_{j+1} \cdots a_k \in F_n(\beta_1 a_j)$.
6. If $a_j a_{j+1} \notin F_n(\beta_1)$, then $a_{j+1} a_j \in F_n(\beta_1 a_j)$ (provided $j \leq n - 1$).
7. $a_{j+2}, a_{j+3}, \dots, a_n \in F_n(\beta_1 a_j)$ (provided $j \leq n - 2$).

Moreover, all elements of $F_n(\beta_1 a_j)$ are obtained in this way.

Let us think about the conditions in [Proposition 3.1](#). First of all, they imply that all elements in $F(\beta_1 a_j)$ are of the form $a_i a_{i+1} \cdots a_k$ for some $i \leq k$, with the only possible exception of the braid $a_{j+1} a_j$. Therefore, as these braids can only be written in a unique way, it makes sense to talk about *the starting letter* of such a braid. Conditions 1 to 4 tell us which elements in $F(\beta_1 a_j)$ start with a letter smaller than a_j . Such an element is either a single letter or an increasing sequence of consecutive letters whose final letter is at least a_j . Conditions 5 and 6 produce the elements in $F_n(\beta_1 a_j)$ starting with a_{j+1} . Actually, Condition 6 tells us that $a_{j+1} a_j$ is a minimal forbidden prefix, except when $j = n$ or when Condition 5 produces a single letter: in this case a_{j+1} is forbidden and hence $a_{j+1} a_j$ is not minimal. Finally, Condition 7 tells us that the letters $a_{j+2}, a_{j+3}, \dots, a_n$ always belong to $F_n(\beta_1 a_j)$, provided they exist.

Let us deduce an important property from [Proposition 3.1](#), i.e. that all arrows in Γ_n whose target is a given state have the same label. We can show that the final letter of a word $\omega(\beta)$ depends only on the set $F_n(\beta)$, and not on β itself:

Proposition 3.2. Let $F = F_n(\beta)$ be the set of minimal forbidden prefixes after some nontrivial $\beta \in A_n$. Let t be the biggest index such that there is no element in F starting with a_t . Then a_t is the final letter of $\omega(\beta)$.

Proof. Let $w = \omega(\beta)$. Since β is not trivial, we can write $w = w_1 a_j$ for some $w_1 \in \mathcal{L}_n$. We need to show that $j = t$.

Let $\beta_1 = \overline{w_1}$. Since $w_1, w \in \mathcal{L}_n$, it follows that a_j is not forbidden after β_1 , and there is an arrow labeled a_j from $F_n(\beta_1)$ to $F_n(\beta)$. From [Proposition 3.1](#), $F_n(\beta)$ contains all letters a_{j+2}, \dots, a_n (provided $j \leq n - 2$). Also, it contains either a_{j+1} or $a_{j+1} a_j$ (provided $j \leq n - 1$). And it contains no element starting with a_j . Therefore, j is the biggest index such that there is no element in $F_n(\beta)$ starting with a_j . \square

We can then talk about the *final letter* of a state s in Γ_n , meaning the final letter of any word in \mathcal{L}_n ending at s , or the label of any arrow in Γ_n whose target is s . We can also talk about the *final letter* of a set $F_n(\beta)$ of minimal forbidden prefixes, as the final letter of $\omega(\beta)$.

We will now see that we can describe every set of the form $F_n(\beta)$ by a collection of data, that we will call a *segment configuration*.

Definition 3.3. A *segment configuration* for A_n is a 4-tuple (i, j, k, S) where i, j, k are integers, $1 \leq i \leq j \leq k \leq n$, and

$$S = \{[i_1, j_1], [i_2, j_2], \dots, [i_t, j_t]\}$$

is a (possibly empty) collection of “nested” segments with integer endpoints, where

$$i \leq i_1 < i_2 < \cdots < i_t < j \leq k \leq j_{t-1} \leq \cdots \leq j_2 \leq j_1 \leq n,$$

and either $j_t = j$ or $k \leq j_t \leq j_{t-1}$.

Each segment configuration determines a set of braids:

Definition 3.4. Let \mathcal{S}_n be the set of segments configurations for A_n . We define a map

$$\psi_n : \mathcal{S}_n \longrightarrow \mathcal{P}(A_n)$$

as follows: given $(i, j, k, S) \in \mathcal{S}_n$ with $S = \{[i_1, j_1], [i_2, j_2], \dots, [i_t, j_t]\}$, we set

$$\begin{aligned} \psi_n((i, j, k, S)) &= \{a_{i_r} a_{i_r+1} \cdots a_{j_r}; \quad r = 1, \dots, t\} \\ &\cup \{a_r; \quad i \leq r \leq n, \quad r \neq i_1, \dots, i_t, j, j+1\} \\ &\cup U_{j,k}, \end{aligned}$$

where

$$U_{j,k} = \begin{cases} \emptyset & \text{if } k = j = n, \\ \{a_{j+1} a_j\} & \text{if } k = j < n, \\ \{a_{j+1}\} & \text{if } k = j + 1, \\ \{a_{j+1} a_j, a_{j+1} a_{j+2} \cdots a_k\} & \text{if } k > j + 1. \end{cases}$$

As said in the introduction, one of the main goals of this paper is a detailed study of the automaton Γ_n . This goal will be achieved by identifying segment configurations with sets of minimal forbidden prefixes after positive braids. More precisely, we will describe the map ψ_n just defined, following the next steps:

- ψ_n is injective, and hence different segment configurations give rise to different sets of braids ([Lemma 3.5](#)).
- Every set of the form $F_n(\beta)$ is in the image of ψ_n ([Proposition 3.6](#)).
- Every set in the image of ψ_n is equal to $F_n(\beta)$ for some braid β ([Proposition 3.8](#)).

This precise knowledge of ψ_n is essentially equivalent to a deep understanding of the structure of the automaton, as we will see in the proof of [Proposition 3.8](#). From now, we will undertake the previous program.

Lemma 3.5. *The map ψ_n is injective.*

Proof. Suppose that $\psi_n((i, j, k, S)) = \psi_n((i', j', k', S')) = F$.

Assume first that $F = \emptyset$. Then $U_{j,k} = \emptyset$, so $j = k = n$. Also, if $i < j$ there would be an element in F starting with a_i , hence $i = j = k = n$. Now every segment $[i_r, j_r] \in S$ must satisfy $i \leq i_r < j$, which is not possible if $i = j$. Hence $(i, j, k, S) = (n, n, n, \emptyset)$. In the same way $(i', j', k', S') = (n, n, n, \emptyset)$, so the empty set has a unique preimage under ψ_n .

Assume now that $F \neq \emptyset$. By construction, all elements in F have the form $a_p a_{p+1} \cdots a_q$ for some $p \leq q$, or $a_{p+1} a_p$. Hence it makes sense to talk about the *starting letter* of an element in F .

We see that $j = j'$ as it is the biggest index p for which there is no element in F starting with a_p .

Let p be the smallest index for which there is an element in F starting with a_p . Notice that $p \leq j + 1$ and $p \neq j$. If $p < j$, it follows from the definition of ψ_n that $i < j$ and that $i = p$. On the other hand, if $p = j + 1$, it follows that $i = j$. Applying the same arguments to i' , we see that if $p < j$ we have $i' = p$, and if $p = j + 1$ we have $i' = j$. In any case, $i = i'$.

It is also true that $k = k'$, as this value is determined by the elements in F starting with a_{j+1} .

We finish by observing that $S = S'$, as their segments correspond to the elements in F , longer than one letter, that start with letters smaller than a_j . \square



$\beta = a_2$ $F_5(\beta) = \{a_3a_2, a_4, a_5\}$  $(2, 2, 2, \emptyset)$	$\beta = a_1a_2a_3a_3a_4a_5a_2$ $F_5(\beta) = \{a_1a_2, a_3a_2, a_3a_4a_5, a_4, a_5\}$  $(1, 2, 5, \{[1, 2]\})$
$\beta = a_1a_2a_2a_3a_4a_4a_3$ $F_5(\beta) = \{a_1a_2a_3a_4, a_2a_3, a_4, a_5\}$  $(1, 3, 4, \{[1, 4], [2, 3]\})$	$\beta = a_1a_2a_3a_3a_4a_4a_5a_5a_4a_4$ $F_5(\beta) = \{a_1, a_2a_3a_4a_5, a_3a_4a_5, a_5a_4\}$  $(1, 4, 4, \{[2, 5], [3, 5]\})$

Figure 1: Examples of braids in A_5 , their sets of minimal forbidden prefixes, their diagrams, and their segment configurations.

Proposition 3.6. [4] *Let $F = F_n(\beta)$ be the set of minimal forbidden prefixes after some nontrivial $\beta \in A_n$. Then $F = \psi_n((i, j, k, S))$ for some segment configuration $(i, j, k, S) \in \mathcal{S}_n$. Moreover, j is the final letter of F .*

Proof. This result is a direct consequence of [4, Corollary 4.12]. It can also be shown directly from Proposition 3.1 starting with $F_n(1) = \emptyset$, by showing that if a set $F_n(\beta_1)$ can be defined by a segment configuration, and a_m is not forbidden after β_1 , then $F_n(\beta_1a_m)$ can also be defined by a segment configuration. \square

The above result states that every set of minimal forbidden prefixes can be determined by a segment configuration. That is, $\mathcal{F}_n \subset \text{Im}(\psi_n)$, where $\mathcal{F}_n = \{F_n(\beta); \beta \in A_n\}$. As ψ_n is injective, this defines an injective map: $\varphi_n : \mathcal{F}_n \rightarrow \mathcal{S}_n$, which, as we will see, will yield the desired bijection between the sets of forbidden prefixes and their corresponding segment configurations.

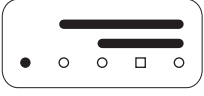
We will represent a segment configuration using a diagram, as in Figure 1. Given a segment configuration (i, j, k, S) , and its corresponding set of braids $F = \psi_n((i, j, k, S))$, the diagram will contain the following: a little white square at position j ; a black circle at position r for each $a_r \in F$; a segment from p to q ($p < q$) for every $a_p a_{p+1} \cdots a_q$ in F ; white circles at all positions where there are no black circles and no white square.

In Figure 1 we can see several examples of diagrams for segment configurations corresponding to sets of forbidden prefixes $F_n(\beta)$. Notice that a letter a_r is permitted after β if and only if there is no black circle at position r .

We will make extensive use of Proposition 3.1, in order to describe the graph Γ_n . All the arguments will become simpler if we work with diagrams instead of with sets of braids. Therefore, we will translate Proposition 3.1 to the language of diagrams. More precisely, we will describe transitions between diagrams in such a way that, if the source diagram corresponds to a set of forbidden prefixes, the transition corresponds to the one described in Proposition 3.1. In the following pictures, a small dot means that

we do not care about the actual symbol in that position (white or black circle, or white square).

Definition 3.7. Let (a, b, c, S) be a segment configuration, represented by a diagram D . Suppose that there is no black circle at position j in D . Then we define a transition

$$(a, b, c, S) \xrightarrow{a_j} (p, j, q, S'),$$

where (p, j, q, S') , represented by a diagram D' , is defined the following way:

1. D' has a square at position j .
2. If D has a black circle at $i < j - 1$, then D' has a black circle at i .

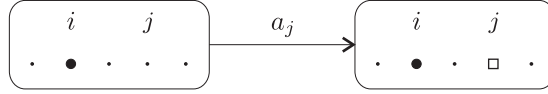

3. If D has a segment $[i, j - 1]$, then D' has a segment $[i, j]$.

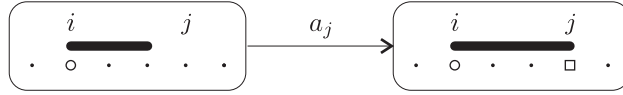

4. If D has a segment $[i, k]$ with $i < j \leq k$, then D' has a segment $[i, k]$.

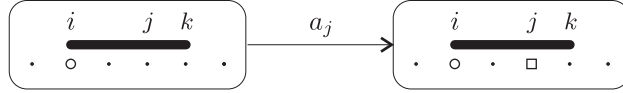

5. If D has a square at $j - 1$, then D' has a black circle at $j - 1$.

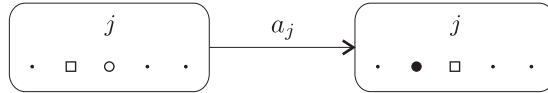

6. If D has a segment $[j, k]$, then D' has either a segment $[j + 1, k]$ (if $j + 1 < k$) or a black circle at k (if $j + 1 = k$).

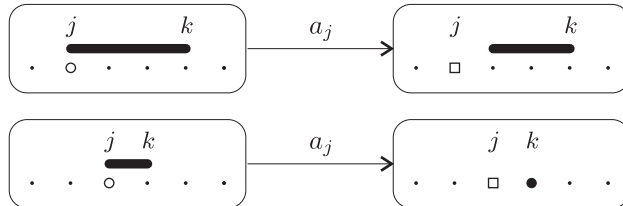

7. D' has black circles at positions $j + 2, j + 3, \dots, n$.

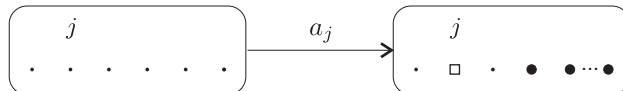

8. D' has a white circle at every position in which there is no square and no black circle.

We can now show that there are as many sets of minimal forbidden prefixes as segment configurations.

Proposition 3.8. *The map $\varphi_n : \mathcal{F}_n \rightarrow \mathcal{S}_n$ is bijective.*

Proof. We have already seen that φ_n is a well defined injective map. It just remains to show that φ_n is surjective.

Recall that $F_n(1) = \emptyset$ corresponds to the initial state of Γ_n . [Proposition 3.1](#) explains how to connect states of Γ_n by transitions. For every state $F \in \mathcal{F}_n$, and every permitted letter a_r (that is, $a_r \notin F$), [Proposition 3.1](#) describes the target state F' , so we have the transition $F \xrightarrow{a_r} F'$. If $F = F_n(\beta)$, we have $F' = F_n(\beta a_r)$. All elements of \mathcal{F}_n are obtained starting at \emptyset , and applying a sequence of transitions. We say that all states in Γ_n are *accessible* from the initial state \emptyset .

On the other hand, in [Definition 3.7](#) we explained a way to connect segment configurations. This defines a directed graph $\tilde{\Gamma}_n$, whose vertices are the elements in \mathcal{S}_n , and whose arrows are given by letters a_r .

Suppose that we have a transition $(i, j, k, S) \xrightarrow{a_r} (i', j', k', S')$ in $\tilde{\Gamma}_n$. If $(i, j, k, S) = \varphi_n(F_n(\beta))$ for some braid β , we know, by construction, that $(i', j', k', S') = \varphi_n(F_n(\beta a_r))$. It follows that Γ_n can be seen (via φ_n) as a subgraph of $\tilde{\Gamma}_n$. More precisely, Γ_n can be seen as the subgraph of $\tilde{\Gamma}_n$ formed by the vertices which are accessible from the initial state $\varphi_n(\emptyset) = (n, n, n, \emptyset)$, whose diagram is as follows:



We will then compute the whole graph $\tilde{\Gamma}_n$, and we will show that all its vertices are accessible from the initial state, so $\tilde{\Gamma}_n$ actually coincides with Γ_n . This will finish the proof.

Suppose that $n = 1$. The only possible segment configuration for A_1 is $(1, 1, 1, \emptyset)$. Then $\tilde{\Gamma}_1$ has a single vertex, which by [Proposition 3.1](#) has an arrow labeled a_1 starting at ending at it. Since this vertex is the initial state of Γ_1 , it follows that $\Gamma_1 = \tilde{\Gamma}_1$, so the result holds for $n = 1$.

For every $n \geq 1$, let $\tilde{\Gamma}_n^*$ be the subgraph of $\tilde{\Gamma}_n$ whose vertices have the form $(1, j, k, S)$. Then we formulate the following

Induction hypothesis:

1. Every vertex in $\tilde{\Gamma}_n$ is accessible from the initial state.
2. Every vertex in $\tilde{\Gamma}_n^*$ is accessible from any other vertex in $\tilde{\Gamma}_n^*$.
3. Every vertex $(1, j, k, S) \in \tilde{\Gamma}_n^*$ with either $j = k$ or $S \neq \emptyset$ is accessible from the vertex $(1, 1, 1, \emptyset)$ by a path which does not include the label a_1 .

Observe that these assumptions are clearly true for $n = 1$. Let us then suppose that $n > 1$, and that the induction hypothesis holds for smaller values of n .

In order to describe the whole graph $\tilde{\Gamma}_n$, let us distinguish distinct subsets of \mathcal{S}_n :

- Configurations (i, j, k, S) , $i > 1$.
- Configurations $(1, 1, k, \emptyset)$.
- Configurations $(1, j, k, S)$, $1 < j$ and no segment $[1, j_1]$ in S .
- Configurations $(1, j, k, \{[1, j]\})$, where $1 < j < k$.

- Configurations $(1, j, k, S)$ with $[1, j_1] \in S$ and $j_1 \geq k$.

Observe that all these sets of configurations are disjoint, and hence by [Definition 3.4](#) form a partition of \mathcal{S}_n . So let us start our case-by-case analysis.

Configurations (i, j, k, S) with $i > 1$.

These correspond to the diagrams with a white circle at position 1.

Let us consider the shifting homomorphism $sh : A_{n-1} \rightarrow A_n$ and the shifting map $sh : \mathcal{L}_{n-1} \rightarrow \mathcal{L}_n$ determined by $sh(a_t) = a_{t+1}$ for all t . We can also define a shifting map $sh : \mathcal{S}_{n-1} \rightarrow \mathcal{S}_n$ which increases by 1 all indices in a segment configuration. In terms of diagrams, the shifting just adds a white circle to the left of the diagram. In this picture, we have $sh(C') = C$:

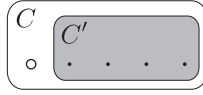

Notice that for every arrow $C'_1 \xrightarrow{a_r} C'_2$ in $\tilde{\Gamma}_{n-1}$, there is an arrow $sh(C'_1) \xrightarrow{a_{r+1}} sh(C'_2)$ in $\tilde{\Gamma}_n$. This covers all arrows starting at vertices of the form $sh(C')$, of index greater than 1. Therefore, all the states (i, j, k, S) with $i > 1$ form a complete copy of $\tilde{\Gamma}_{n-1} = \Gamma_{n-1}$, but with the labels of the arrows shifted (their indices are increased by one). We will denote this copy $sh(\Gamma_{n-1})$.

Each diagram corresponding to a state of $sh(\Gamma_{n-1})$ has an isolated white circle at position 1. This means that it accepts an outgoing arrow labeled a_1 . Its target is $(1, 1, 1, \emptyset)$. So we have a complete copy of Γ_{n-1} , with inner arrows labeled $\{a_2, \dots, a_n\}$, all of whose states have an arrow labeled a_1 and pointing to $(1, 1, 1, \emptyset)$. We have then described all arrows starting at elements of $sh(\Gamma_{n-1})$.

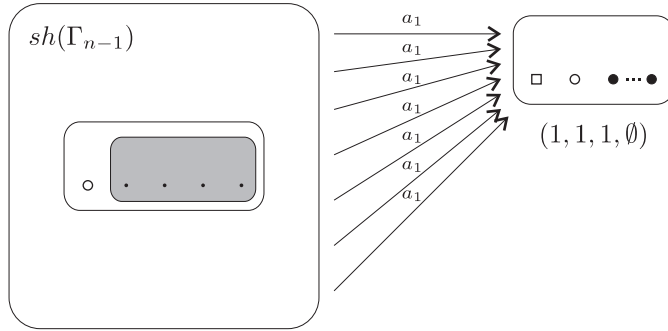

Configurations $(1, 1, k, \emptyset)$.

These correspond to the diagrams with a square at position 1. We will denote $T_{1,n} = \{(1, 1, k, \emptyset); k = 1, \dots, n\} \subset \mathcal{S}_n$ the subset containing these configurations.

The only permitted arrows starting at such states are a_1 and a_2 (in the latter case, only if $k \neq 2$).

We see that an arrow labeled a_1 starting at any $(1, 1, k, \emptyset)$ ends at $(1, 1, 1, \emptyset)$. On the other hand, an arrow labeled a_2 starting at $(1, 1, k, \emptyset)$ (for $k \neq 2$) ends at $(1, 2, k, \emptyset)$. This ends the description of the arrows starting at elements in $T_{1,n}$.

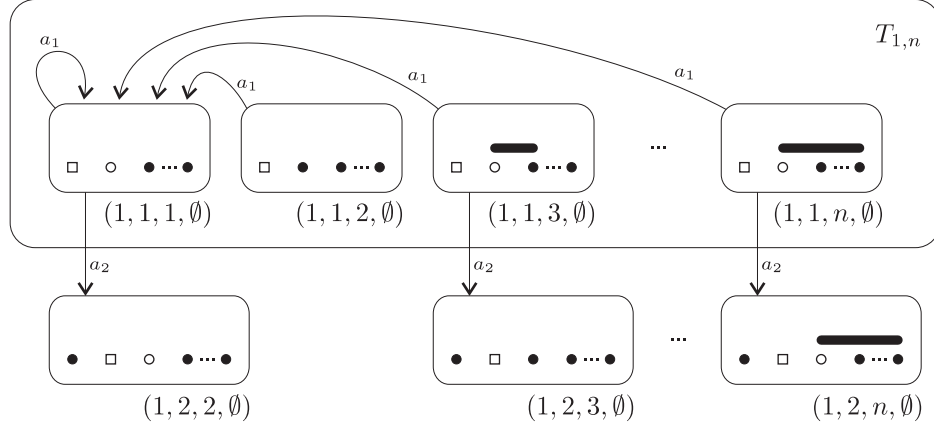

Configurations $(1, j, k, S)$ with $1 < j$ and no segment $[1, j_1]$ in S .

These correspond to the diagrams with a black circle at position 1.

Let \mathcal{S}_{n-1}^* be the segment configurations in \mathcal{S}_{n-1} not having an isolated white circle at position 1. That is, those of the form $(1, j', k', S')$. Recall that $\tilde{\Gamma}_{n-1}^*$ is the subgraph of $\tilde{\Gamma}_{n-1}$ whose vertices belong to \mathcal{S}_{n-1}^* . We know by induction that we can identify $\tilde{\Gamma}_{n-1}$ and Γ_{n-1} , so we will just denote $\Gamma_{n-1}^* = \tilde{\Gamma}_{n-1}^*$. Given $C' = (1, j', k', S') \in \mathcal{S}_{n-1}^*$, we have $sh(C') = (2, j, k, S)$, and we define $sh_\bullet(C') = (1, j, k, S)$. Every configuration whose diagram has a black circle at position 1 can be obtained in this way. Hence, the subgraph of $\tilde{\Gamma}_{n-1}$ containing these vertices will be denoted $sh_\bullet(\Gamma_{n-1}^*)$.

The graph $sh_\bullet(\Gamma_{n-1}^*)$ is quite similar to Γ_{n-1}^* : It has the same number of vertices and, for every arrow $C'_1 \xrightarrow{a_r} C'_2$ in Γ_{n-1}^* , with $r \geq 2$, there is an arrow $sh_\bullet(C'_1) \xrightarrow{a_{r+1}} sh_\bullet(C'_2)$ in $\tilde{\Gamma}_n$, as the arrow a_{r+1} does not affect the black circle at position 1. The difference comes from the arrows labeled a_2 starting at states of $sh_\bullet(\Gamma_{n-1}^*)$.

Suppose that a state from $sh_\bullet(\Gamma_{n-1}^*)$ admits an outgoing arrow labeled a_2 . In this case, in the diagram corresponding to this state, there is either a square at position 2 or a segment starting at position 2 and ending at some position $k \in \{3, \dots, n\}$. And we know that there is a black circle at position 1. Therefore, at the target of the arrow a_2 we have the segment configuration $(1, 2, k, \{[1, 2]\})$, for some $k = 2, \dots, n$. Hence, there are exactly $n - 1$ states which receive the outgoing arrows a_2 from $sh_\bullet(\Gamma_{n-1}^*)$.

Since every state in $sh_\bullet(\Gamma_{n-1}^*)$ has a black circle at position 1, the letter a_1 is forbidden after any such state, so there is no arrow labeled a_1 starting at any such state. We have then described all arrows

starting at elements in $sh_{\bullet}(\Gamma_{n-1}^*)$.

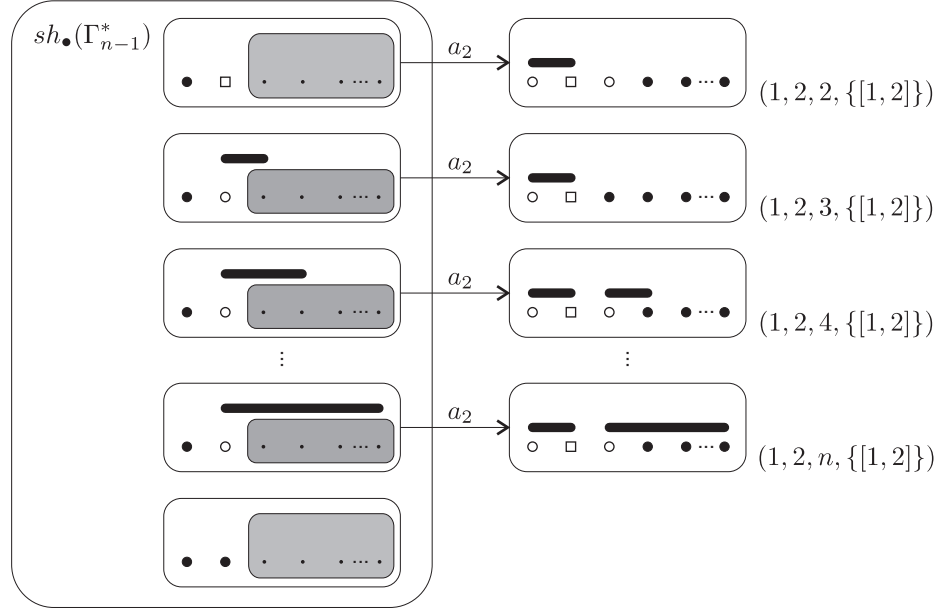

The states $(1, j, k, \{[1, j]\})$, where $1 < j < k$.

These correspond to diagrams with a segment $[1, j]$ (j is the position of the square), and either a black circle at $j+1$ or a segment $[j+1, k]$. For every $j = 2, \dots, n-1$, we will denote $T_{j,n} = \{(1, j, k, \{[1, j]\}); k = j+1, \dots, n\} \subset \mathcal{S}_n$ the subset containing such configurations.

The arrows starting at such a state are labeled a_1 , a_j and a_{j+1} , the latter case only if $k > j+1$. In the latter case, we have the arrow:

$$(1, j, k, \{[1, j]\}) \xrightarrow{a_{j+1}} (1, j+1, k, \{[1, j+1]\}).$$

So, for every $k > 1$ we have a chain:

$$(1, 2, k, \{[1, 2]\}) \xrightarrow{a_3} (1, 3, k, \{[1, 3]\}) \xrightarrow{a_4} \dots \xrightarrow{a_{k-1}} (1, k-1, k, \{[1, k-1]\}).$$

Now, from every state $(1, j, k, \{[1, j]\})$ with $1 < j < k$, there is an arrow labeled a_1 going to $(1, 1, j, \emptyset)$.

Finally, from every state $(1, j, k, \{[1, j]\})$ with $1 < j < k$, there is an arrow labeled a_j going to $(1, j, j, \{[1, j], [j-1, j]\})$.

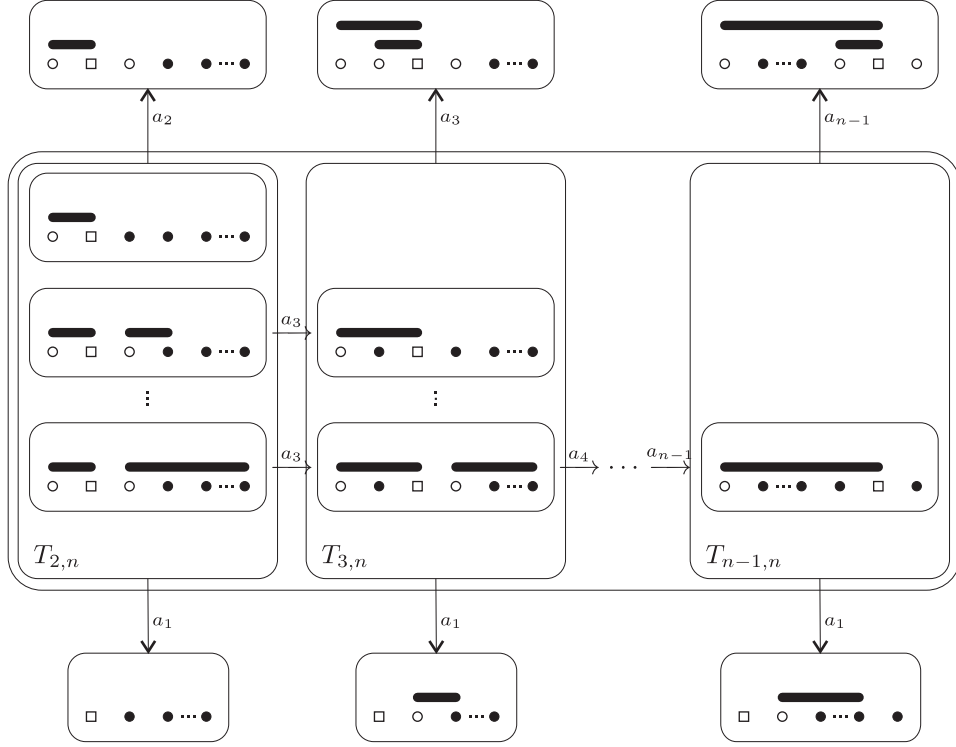

The states $(1, j, k, S)$ with $[1, j_1] \in S$ and $j_1 \geq k$.

These are the remaining configurations in \mathcal{S}_n . They have a segment from 1 to j_1 . To the right of the segment they have only black circles, unless $j = j_1 < n$: in that case they have a white circle at position $j_1 + 1$.

The permitted labels for arrows starting at such configurations are a_1 and maybe some letters in $\{a_2, \dots, a_{j+1}\}$.

The target of an arrow labeled a_1 is $(1, 1, j_1, \emptyset)$, in any case.

Fix $j_1 \in \{2, \dots, n\}$. If we remove the segment $[1, j_1]$ from the configuration $C_1 = (1, j, k, S)$, we obtain the configuration $C_1^* = (2, j, k, S^*)$, which only involves the numbers $\{2, \dots, j_1\}$. We can consider this configuration as a state of $sh(\Gamma_{j_1-1}^*)$. Every arrow $C_1^* \xrightarrow{a_r} C_2^*$ in $sh(\Gamma_{j_1-1}^*)$, with $r \in \{2, \dots, j_1\}$, corresponds to an arrow $C_1 \xrightarrow{a_r} C_2$, where C_i is obtained from C_i^* by adding the segment $[1, j_1]$. This means that the elements containing the segment $[1, j_1]$ form a complete copy of the graph $sh(\Gamma_{j_1-1}^*)$. We will denote this subgraph $\overline{sh(\Gamma_{j_1-1}^*)}$.

There is still another possible arrow starting at such kind of configuration, but it can only happen if $j = k = j_1 < n$. In this case, $a_{j+1} = a_{j+1}$ is a permitted arrow. Also, in this case, all segments in S must end at j , so we have $S = \{[1, j], [i_2, j], \dots, [i_t, j]\}$. Then, denoting $S' = \{[1, j+1], [i_2, j+1], \dots, [i_t, j+1]\}$, the target of the arrow a_{j+1} starting at $(1, j, k, S) = (1, j, j, S)$ is the configuration $(1, j+1, j+1, S')$.

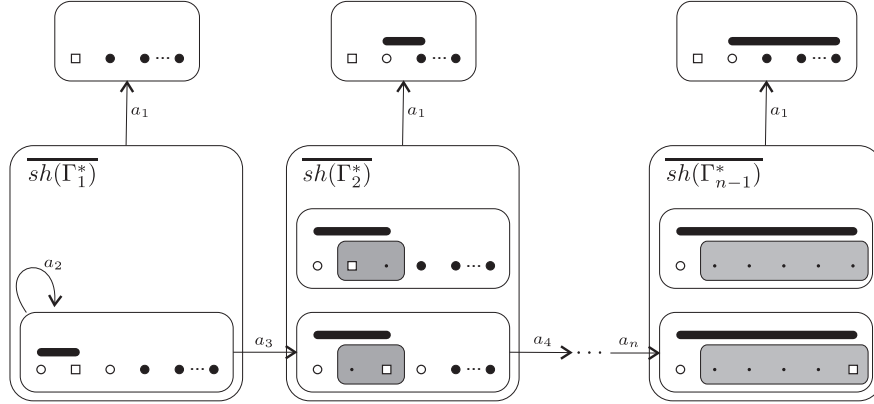

There are no other possible arrows starting at these configurations, so we have described all possible transitions between the distinct configurations in \mathcal{S}_n .

Joining all the pieces, we have a complete picture of the graph $\tilde{\Gamma}_n$, in [Figure 2](#).

Now let us see that $\tilde{\Gamma}_n = \Gamma_n$, and that the induction hypothesis stated at the beginning of this proof is satisfied. We first need to see that every vertex of Γ_n is accessible from the initial vertex (n, n, n, \emptyset) .

First, we see that $(n, n, n, \emptyset) \in sh(\Gamma_{n-1})$. Moreover, it is the shift of $(n-1, n-1, n-1, \emptyset)$, which is the initial state of Γ_{n-1} . By induction hypothesis we know that every vertex of Γ_{n-1} is accessible from the initial state, hence every vertex of $sh(\Gamma_{n-1})$ is accessible from (n, n, n, \emptyset) .

Recall that every vertex in $sh(\Gamma_{n-1})$ has an arrow pointing to $(1, 1, 1, \emptyset) \in \mathcal{S}_n$. Hence, this vertex is accessible. Now we can apply the transition a_2 , to obtain $(1, 2, 2, \emptyset)$, which is a vertex in $sh_\bullet(\Gamma_{n-1}^*)$.

By induction hypothesis, all vertices in Γ_{n-1}^* of the form $(1, j, k, S)$, with either $j = k$ or $S \neq \emptyset$, are accessible from $(1, 1, 1, \emptyset)$ by a path not involving the label a_1 . Therefore, as the arrows in $sh_\bullet(\Gamma_{n-1}^*)$ with labels in $\{a_3, \dots, a_n\}$ coincide (with shifted indices) with the arrows in Γ_{n-1}^* with labels in $\{a_2, \dots, a_{n-1}\}$, we obtain that every vertex in $sh_\bullet(\Gamma_{n-1}^*)$ not having the form $(1, j, k, \emptyset)$ ($j < k$), is accessible from $(1, 2, 2, \emptyset) = sh_\bullet((1, 1, 1, \emptyset))$.

Now we can access all vertices in $T_{j,n}$ for $j = 2, \dots, n-1$, starting at suitable (accessible) vertices in $sh_\bullet(\Gamma_{n-1}^*)$, for instance $(1, j, j, \{[2, j]\})$ for $j = 2, \dots, n$, and applying the transitions a_2, a_3, \dots, a_{n-1} .

Given $j \in \{2, \dots, n-1\}$, we can apply the transition a_j to any vertex in $T_{j,n}$, to obtain the vertex $(1, j, j, \{[1, j]\})$. This is, hence, an accessible vertex in $\overline{sh(\Gamma_{j-1}^*)}$. Since $\overline{sh(\Gamma_{j-1}^*)}$ is a complete copy of Γ_{j-1}^* , with the indices shifted, it follows that all vertices in $\overline{sh(\Gamma_{j-1}^*)}$ are accessible from any other. This holds for $j = 2, \dots, n-1$.

Now we can access $\overline{sh(\Gamma_{n-1}^*)}$ from $\overline{sh(\Gamma_{n-2}^*)}$, since there is an arrow labeled a_n , for instance, from $(1, n-1, n-1, \{[1, n-1]\})$ to $(1, n, n, \{[1, n]\})$. It follows that all vertices in $\overline{sh(\Gamma_{n-1}^*)}$ are also accessible.

Notice that we have already accessed, from $(1, 1, 1, \emptyset)$, all elements in $\tilde{\Gamma}_n$ of the form $(1, j, k, S)$ except those of the form $(1, j, k, \emptyset)$ with $j < k$, by a path which does not involve the label a_1 .

Finally, from any vertex in $\overline{sh(\Gamma_{k-1}^*)}$ (for $k = 2, \dots, n$), there is a transition a_1 to the vertex $(1, 1, k, \emptyset)$. And from this one, we have a sequence of transitions a_2, a_3, \dots, a_{k-1} , which lead successively to $(1, 2, k, \emptyset)$, $(1, 3, k, \emptyset)$, \dots , $(1, k-1, k, \emptyset)$. This covers all the remaining vertices of $\tilde{\Gamma}_n$.

Therefore, all vertices of $\tilde{\Gamma}_n$ are accessible from the initial vertex (n, n, n, \emptyset) . This implies that $\tilde{\Gamma}_n = \Gamma_n$. Moreover, it follows by construction that all elements in Γ_n of the form $(1, j, k, S)$ except those of the form $(1, j, k, \emptyset)$ with $j < k$, are accessible from $(1, 1, 1, \emptyset)$ by a path which does not involve the label a_1 . Finally, we can easily check that from every vertex in Γ_n^* we can access $(1, 1, 1, \emptyset)$ (following the transitions explained in the paragraphs above, and noticing that $(1, 1, 1, \emptyset)$ can be accessed from $(1, 1, k, \emptyset)$ by a

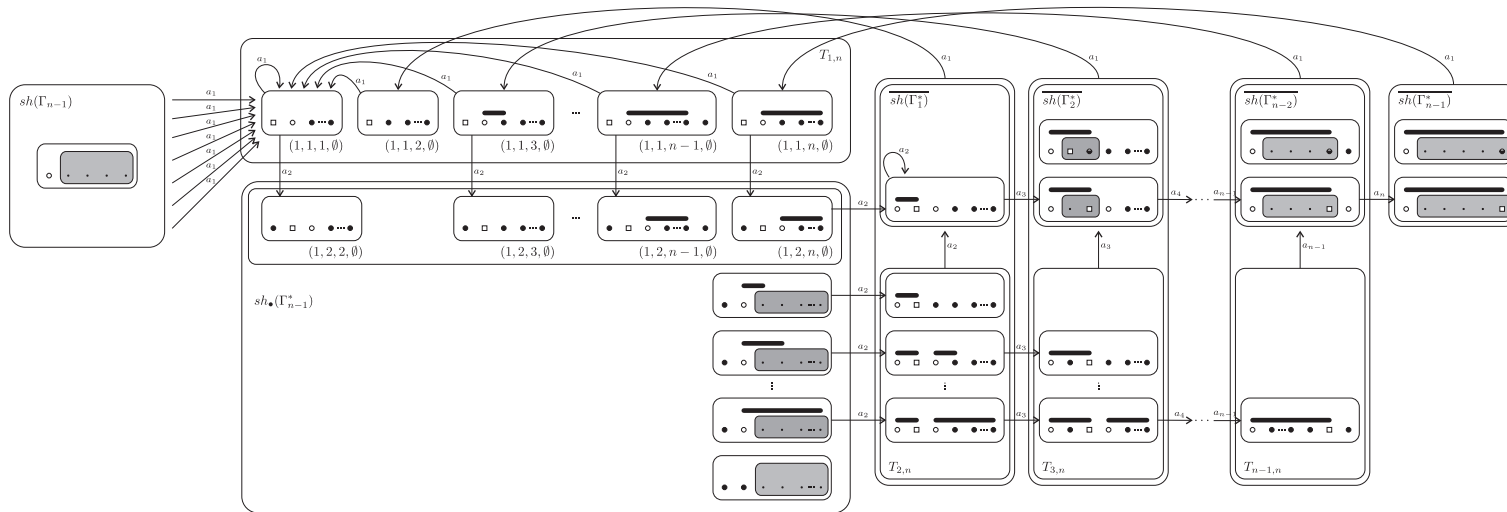

Figure 2: Structure of the automaton Γ_n

transition a_1). Therefore, we can go from any vertex in Γ_n^* to any other, passing through $(1, 1, 1, \emptyset)$.

This shows the induction step, and finishes the proof. So we have described the whole automaton Γ_n . \square

4 Size of the automaton

One nice consequence of [Proposition 3.8](#) is that we can count the number of states of the automaton Γ_n , as they are in bijection with the number of segments configurations for A_n .

Instead of counting directly the number of segment configurations, we will derive a recurrence relation between the number of segment configurations for A_n and the number of segment configurations for A_m , with $m < n$. From that recurrence relation we will obtain the final formula for the number of states of Γ_n , which surprisingly depends on the Fibonacci numbers.

Proposition 4.1. *For $n \geq 0$, let s_n be the number of states in Γ_n , which coincides with the number of segment configurations for A_n (we are considering $\Gamma_0 = \emptyset$). We have $s_0 = 0$, $s_1 = 1$, and the following recurrence relation:*

$$s_n = 3 s_{n-1} - s_{n-2} + \binom{n}{2} + 1.$$

Proof. By definition, $s_0 = 0$. If $n = 1$, the only segment configuration is $(1, 1, 1, \emptyset)$, so $s_1 = 1$. Let us assume that $n > 1$. In order to count the elements in \mathcal{S}_n , we will consider the parts of the automaton Γ_n that were described in [Theorem 2.3](#).

First, the vertices of $sh(\Gamma_{n-1})$ are in bijection with the vertices in Γ_{n-1} , so there are s_{n-1} .

Next, the vertices in $sh_\bullet(\Gamma_{n-1}^*)$ are in bijection with the vertices in Γ_{n-1}^* , which are the vertices in Γ_{n-1} which do not belong to Γ_{n-2} . There are exactly $s_{n-1} - s_{n-2}$.

Now consider the vertices in $T_{1,n}, T_{2,n}, \dots, T_{n-1,n}$. The number of vertices in $T_{j,n}$ is $n - j$, except in the case of $T_{1,n}$, which has n vertices. Therefore, there are $n + (n - 2) + (n - 3) + \dots + 1$ vertices, which is precisely $\binom{n}{2} + 1$.

Finally, the set of vertices in $\overline{sh(\Gamma_j^*)}$, for $j \in \{1, \dots, n-1\}$, is in bijection with Γ_j^* , that is, it has $s_j - s_{j-1}$ vertices. Adding up the number of vertices of these sets, for $j = 1, \dots, n-1$, we have:

$$(s_{n-1} - s_{n-2}) + (s_{n-2} + s_{n-3}) + \dots + (s_1 - s_0) = s_{n-1} - s_0 = s_{n-1}.$$

So there are s_{n-1} such vertices.

The disjoint union of all considered sets of vertices forms \mathcal{S}_n , so the number of elements in \mathcal{S}_n is exactly:

$$\begin{aligned} s_n &= s_{n-1} + (s_{n-1} - s_{n-2}) + \binom{n}{2} + 1 + (s_{n-1} + 1) \\ &= 3 s_{n-1} - s_{n-2} + \binom{n}{2} + 1. \end{aligned}$$

\square

Theorem 4.2. *Let F_n be the n -th Fibonacci number ($F_0 = 0$, $F_1 = 1$, $F_{i+1} = F_i + F_{i-1}$). Let s_n be the number of states of the Finite State Automaton Γ_n accepting the language of maximal (or minimal) lexicographic representatives of elements in the positive braid monoid A_n . Then*

$$s_n = \sum_{i=1}^n \left(\binom{n+1-i}{2} + 1 \right) \cdot F_{2i}$$

Proof. For $n = 0$ and $n = 1$ the result is clear, as $s_0 = 0$ and $s_1 = 1 \cdot F_2 = 1$. Let us suppose that $n > 1$ and that the result holds for smaller values of n . We know by [Proposition 4.1](#) that

$$s_n = 3 s_{n-1} - s_{n-2} + \binom{n}{2} + 1.$$

By induction hypothesis:

$$\begin{aligned} s_n &= 3 \left(\sum_{i=1}^{n-1} \left(\binom{n-i}{2} + 1 \right) \cdot F_{2i} \right) - \left(\sum_{i=1}^{n-2} \left(\binom{n-1-i}{2} + 1 \right) \cdot F_{2i} \right) + \binom{n}{2} + 1 \\ &= 3 \left(\sum_{i=2}^n \left(\binom{n+1-i}{2} + 1 \right) \cdot F_{2i-2} \right) - \left(\sum_{i=3}^n \left(\binom{n+1-i}{2} + 1 \right) \cdot F_{2i-4} \right) + \binom{n}{2} + 1 \\ &= \left(\sum_{i=2}^n \left(\binom{n+1-i}{2} + 1 \right) \cdot (3 F_{2i-2} - F_{2i-4}) \right) + \left(\binom{n}{2} + 1 \right) \cdot F_2. \end{aligned}$$

Now we just need to see that

$$F_{2i} + F_{2i-4} = F_{2i-1} + F_{2i-2} + F_{2i-4} = 2F_{2i-2} + F_{2i-3} + F_{2i-4} = 3F_{2i-2}.$$

Hence $3 F_{2i-2} - F_{2i-4} = F_{2i}$, and we finally have:

$$\begin{aligned} s_n &= \left(\sum_{i=2}^n \left(\binom{n+1-i}{2} + 1 \right) \cdot F_{2i} \right) + \left(\binom{n}{2} + 1 \right) \cdot F_2 \\ &= \sum_{i=1}^n \left(\binom{n+1-i}{2} + 1 \right) \cdot F_{2i}, \end{aligned}$$

as we wanted to show. □

We finish the section by explicitly computing the first terms of the sequence $\{s_n\}$.

$$\begin{array}{rcl} s_1 & = & 1 \cdot 1 & = & 1 \\ s_2 & = & 2 \cdot 1 + 1 \cdot 3 & = & 5 \\ s_3 & = & 4 \cdot 1 + 2 \cdot 3 + 1 \cdot 8 & = & 18 \\ s_4 & = & 7 \cdot 1 + 4 \cdot 3 + 2 \cdot 8 + 1 \cdot 21 & = & 56 \\ s_5 & = & 11 \cdot 1 + 7 \cdot 3 + 4 \cdot 8 + 2 \cdot 21 + 1 \cdot 55 & = & 161 \end{array}$$

These numbers were computed in [\[4\]](#) for $n = 1, \dots, 19$, without the knowledge of the above formula. Just to understand the size of the numbers involved, one has $s_{19} = 126\,491\,780$.

5 Asymptotic properties

We will now use our knowledge of the structure of the DFSA Γ_n , to determine asymptotic properties of braid monoids A_n . A good reference to the linear algebra used and Perron-Frobenius theory in this section is the book [\[7\]](#).

Consider the *incidence matrix* M_n of the DFSA Γ_n . This is a $s_n \times s_n$ matrix (where s_n is the number of states of Γ_n), where each row (resp. each column) corresponds to a state of Γ_n . The entry $m_{i,j}$ of M_n equals 1 if there is a transition from the state i to the state j in Γ_n , and equals 0 otherwise.

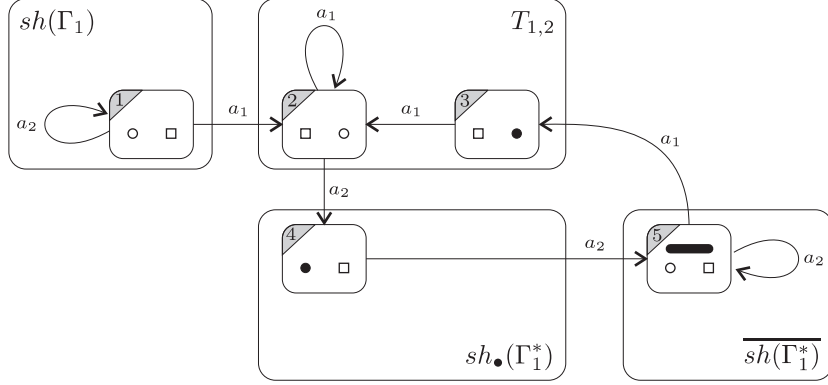

Figure 3: The DFSA Γ_2 .

For instance, in [Figure 3](#) we can see the DFSA Γ_2 , whose incidence matrix is the following:

$$M_2 = \begin{pmatrix} 1 & 1 & 0 & 0 & 0 \\ 0 & 1 & 0 & 1 & 0 \\ 0 & 1 & 0 & 0 & 0 \\ 0 & 0 & 0 & 0 & 1 \\ 0 & 0 & 1 & 0 & 1 \end{pmatrix}$$

Taking powers of the matrix M_n , one obtains information about the number of paths from one state to another. The entry (i, j) of $(M_n)^k$ is precisely the number of paths of length k from the state i to the state j . Recall that the elements in \mathcal{L}_n (which are in bijection with the elements in A_n) correspond to the paths in Γ_n starting at the initial state (state 1). Therefore, the entries of the first row of $(M_n)^k$ determine the proportion of elements of length k in \mathcal{L}_n ending at each state.

For instance, if we compute the 50th power of the matrix M_2 above, we obtain:

$$(M_2)^{50} = \begin{pmatrix} 1 & 16475640050 & 10182505536 & 10182505537 & 16475640048 \\ 0 & 10182505537 & 6293134512 & 6293134513 & 10182505537 \\ 0 & 6293134513 & 3889371024 & 3889371025 & 6293134512 \\ 0 & 6293134512 & 3889371025 & 3889371024 & 6293134513 \\ 0 & 10182505537 & 6293134513 & 6293134512 & 10182505537 \end{pmatrix}$$

It seems clear that the probability of ending at the initial state tends to 0 as k tends to infinity, since there is only one possible path $(a_2 a_2 a_2 \cdots a_2)$ ending at the initial state, and this is negligible compared to the number of paths of length k ending at any other state. We slightly abuse language, by calling “probability of ending at a state” the proportion of accepted paths ending at that state as k tends to infinity. Following the analogy, the nomenclature of the next paragraph is inspired by the terminology of Markov chains.

In the previous section we have shown two important properties of Γ_n . First, the states in $sh(\Gamma_{n-1})$ are *transient*: once the process reaches the subgraph Γ_n^* , it will never go back to $sh(\Gamma_{n-1})$. This is why the probability of ending at a state in $sh(\Gamma_{n-1})$ tends to 0 as k tends to infinity. On the other hand, the states in Γ_n^* (all the remaining states in Γ_n) are *recurrent*: for every ordered pair (v_1, v_2) of states in Γ_n^* , there is always a path going from v_1 to v_2 . This means that the probability of ending at such a state will tend to a positive number.

It is then clear that, if we want to study the proportion of accepted paths ending at a given state (when k tends to infinity), we can restrict our attention to the recurrent states, and forget the transient ones. We

will then consider the incidence matrix R_n whose rows (resp. columns) correspond to recurrent states. In the above example ($n = 2$), we just need to remove the first row and column, and we obtain the matrix:

$$R_2 = \begin{pmatrix} 1 & 0 & 1 & 0 \\ 1 & 0 & 0 & 0 \\ 0 & 0 & 0 & 1 \\ 0 & 1 & 0 & 1 \end{pmatrix}$$

Since R_n is the incidence matrix of the recurrent states, all entries of some power of R_n (and all successive powers after it) will be positive integers. This means that R_n is a *primitive* matrix. The Perron-Frobenius eigenvalue of R_n is the eigenvalue λ_n of biggest modulus (which turns out to be a positive real number), and the Perron-Frobenius eigenvector is the only row vector v (up to scalar multiplication) with positive entries, such that $vR_n = \lambda_n v$. The proportions between the entries of this vector are precisely the limits, when k tends to infinity, of the proportions between the entries of any row of $(R_n)^k$. In our case, they are the proportions of ‘very long’ elements in \mathcal{L}_n ending at each recurrent state.

In the particular case $n = 2$, the Perron-Frobenius eigenvalue is the golden ratio $\varphi = \frac{1+\sqrt{5}}{2} = 1.618033\dots$, and the Perron-Frobenius eigenvector is $v = (\varphi, 1, 1, \varphi)$. This means that, among the elements in \mathcal{L}_2 of length $k \gg 1$, it is φ times more likely to end at states 2 or 5 than to end at states 3 or 4. We can already guess this proportion in the matrix $(M_2)^{50}$ showed above.

We also see in [Figure 3](#) that the final letter of states 2 and 3 is a_1 , and the final letter of states 4 and 5 is a_2 . This implies that, when k tends to infinity, the proportion of lexicographic representatives ending with a_1 equals 1/2: there are as many representatives finishing with a_1 as representatives finishing with a_2 .

One could think that, when $n > 2$, the proportion of long representatives finishing with any given a_j is not far from $1/n$. But this is not the case. The lexicographic representatives finishing with a_1 become more abundant. Actually, we will show that this proportion is bounded below by $\frac{1}{8}$, no matter how big is n .

It is well known that the eigenvalue λ_n associated to Γ_n measures the growth of the entries of $(R_n)^k$. Hence, λ_n is the growth rate of the monoid A_n (with respect to the standard generators a_1, \dots, a_n). Fortunately, it is already known how these growth rates relate to each other, for distinct values of n :

Theorem 5.1. [[6](#), Proposition 7.98] *The sequence $\{\lambda_n\}_{n \geq 1}$ of Perron-Frobenius eigenvalues (growth rates) for the braid monoids A_n , is a strictly increasing sequence of positive real numbers. Its limit λ_∞ as n tends to infinity satisfies $2.5 < \lambda_\infty < 4$.*

We remark that, as we have seen, Γ_{n-1}^* is a proper complete subgraph of Γ_n^* . This implies immediately that $\lambda_{n-1} < \lambda_n$. So the study of the automaton Γ_n in this paper also shows that the sequence $\{\lambda_n\}$ is increasing.

We are going to use the following technical lemma, which is well-known. Recall that the *spectral radius* of a square matrix is the largest absolute value of its eigenvalues.

Lemma 5.2. *Let R be a square matrix whose elements are nonnegative, and let λ be a positive real number, strictly bigger than the spectral radius of R . Then all entries of $(\lambda I - R)^{-1}$ are nonnegative. If R is primitive, then all entries of $(\lambda I - R)^{-1}$ are positive.*

Proof. Since λ is bigger than the spectral radius of R , the spectral radius of $\lambda^{-1}R$ is smaller than 1. In this case, we have the convergent sum:

$$(I - \lambda^{-1}R)^{-1} = I + (\lambda^{-1}R) + (\lambda^{-1}R)^2 + (\lambda^{-1}R)^3 + \dots$$

Multiplying by λ^{-1} , we have:

$$(\lambda I - R)^{-1} = \lambda^{-1}I + \lambda^{-2}R + \lambda^{-3}R^2 + \lambda^{-4}R^3 + \dots$$

Since all entries of R are nonnegative, the above (convergent) infinite sum is made of matrices with nonnegative entries, hence all entries of $(\lambda I - R)^{-1}$ are nonnegative. If furthermore R is primitive, then some power of R has all entries positive, so all entries of $(\lambda I - R)^{-1}$ are positive. \square

In order to study the Perron-Frobenius eigenvector v of the incidence matrix R_n , we will interpret it as follows: The vector $v = (v_1, v_2, \dots, v_m)$ is an assignment of a positive real number v_i to each recurrent state S_i of Γ_n^* . Recall that $vR_n = \lambda_n v$. This means that, for every state S_j , if we denote $\text{Pred}(S_j) = \{S_{i_1}, \dots, S_{i_k}\}$ the states of Γ_n^* for which there is a transition $S_{i_r} \rightarrow S_j$, which are called the *direct predecessors* of S_j , then we must have

$$v_{i_1} + \dots + v_{i_k} = \lambda_n v_j.$$

Moreover, the vector v satisfying this property is unique, up to scalar multiplication. So we can normalize it in such a way that $v_1 + \dots + v_m = 1$. In this way, the value v_i is the probability that a ‘very long’ lexicographic representative ends at the state S_i .

Let us introduce some notation. Suppose that Γ is a DFSA all of whose states are recurrent. Hence its incidence matrix R is primitive and has a Perron-Frobenius eigenvalue λ . Let $\mathcal{I} = \{i_1, \dots, i_t\}$ be a proper subset of vertices of Γ , and let $\Gamma_{\mathcal{I}}$ be the complete subgraph of Γ determined by these vertices. Let $R_{\mathcal{I}}$ be the incidence matrix of $\Gamma_{\mathcal{I}}$. As $R_{\mathcal{I}}$ can be seen as a submatrix of R , it is known that its spectral radius is smaller than λ .

Let $v = (v_1, \dots, v_m)$ be the normalized Perron-Frobenius eigenvector associated to Γ . Given a state S_i of $\Gamma_{\mathcal{I}}$, we will be interested in the direct predecessors of S_i which do not belong to $\Gamma_{\mathcal{I}}$, as they are the states which, informally speaking, ‘introduce probability’ in $\Gamma_{\mathcal{I}}$. So we denote, for every $i \in \mathcal{I}$:

$$P_{i,\mathcal{I}} = \text{Pred}(S_i) \setminus \Gamma_{\mathcal{I}}.$$

We will measure the ‘incoming probability’ at the state S_i with the following number:

$$p_{i,\mathcal{I}} = \sum_{j \in P_{i,\mathcal{I}}} v_j.$$

And the total ‘incoming probability’ of the subset \mathcal{I} will be determined by a vector

$$p_{\mathcal{I}} = (p_{i_1,\mathcal{I}}, p_{i_2,\mathcal{I}}, \dots, p_{i_t,\mathcal{I}}).$$

As usual, we will compare vectors $u = (u_1, \dots, u_t)$ and $w = (w_1, \dots, w_t)$ of the same length, by saying that $u \leq w$ if $u_i \leq w_i$ for $i = 1, \dots, t$.

Let us see that, under some conditions, the coordinates of $p_{\mathcal{I}}$ may give some information about the coordinates of the eigenvector v inside \mathcal{I} .

Proposition 5.3. *Let Γ be a DFSA whose vertices are all recurrent, so its incident matrix R is primitive. Let λ be its Perron-Frobenius eigenvalue, and $v = (v_1, \dots, v_m)$ its normalized Perron-Frobenius eigenvector. Let $\mathcal{I} = \{i_1, \dots, i_t\}$ and $\mathcal{J} = \{j_1, \dots, j_t\}$ be two proper subsets of vertices of Γ , such that the subgraphs $\Gamma_{\mathcal{I}}$ and $\Gamma_{\mathcal{J}}$ are isomorphic (by the map sending i_k to j_k for $k = 1, \dots, t$). If $p_{\mathcal{I}} \geq \alpha p_{\mathcal{J}}$ for some positive real number α , then:*

$$(v_{i_1}, \dots, v_{i_t}) \geq \alpha (v_{j_1}, \dots, v_{j_t}).$$

Moreover, if the incidence matrix for \mathcal{I} is primitive, and $p_{\mathcal{I}} > \alpha p_{\mathcal{J}}$, then

$$(v_{i_1}, \dots, v_{i_t}) > \alpha (v_{j_1}, \dots, v_{j_t}).$$

Proof. We know that, for every $i \in \mathcal{I}$, the sum of all v_k with $S_k \in \text{Pred}(S_i)$ equals λv_i . This sum can be split in two: on one side we can take the states which belong to $\Gamma_{\mathcal{I}}$, which are determined by the

matrix $R_{\mathcal{I}}$, and on the other side we can take the states which do not belong to $\Gamma_{\mathcal{I}}$, which determine the ‘incoming probability’ $p_{i,\mathcal{I}}$. Collecting this information for all $i \in \mathcal{I}$, we have the following:

$$(v_{i_1} \cdots v_{i_t})R_{\mathcal{I}} + p_{\mathcal{I}} = \lambda(v_{i_1} \cdots v_{i_t}).$$

Hence:

$$(v_{i_1} \cdots v_{i_t})(\lambda I - R_{\mathcal{I}}) = p_{\mathcal{I}}.$$

Since λ is bigger than the greatest eigenvalue of $R_{\mathcal{I}}$, the matrix $(\lambda I - R_{\mathcal{I}})$ is invertible. So we have:

$$(v_{i_1} \cdots v_{i_t}) = p_{\mathcal{I}} (\lambda I - R_{\mathcal{I}})^{-1}$$

In the same way, we have:

$$(v_{j_1} \cdots v_{j_t}) = p_{\mathcal{J}} (\lambda I - R_{\mathcal{J}})^{-1}$$

Now we just need to recall that $R_{\mathcal{I}} = R_{\mathcal{J}}$, and to notice that, as λ is greater than the spectral radius of $R_{\mathcal{I}}$, [Lemma 5.2](#) ensures that all entries of $(\lambda I - R_{\mathcal{I}})^{-1}$ are nonnegative. Therefore:

$$\begin{aligned} (v_{i_1} \cdots v_{i_t}) &= p_{\mathcal{I}} (\lambda I - R_{\mathcal{I}})^{-1} \geq \alpha p_{\mathcal{J}} (\lambda I - R_{\mathcal{I}})^{-1} \\ &= \alpha p_{\mathcal{J}} (\lambda I - R_{\mathcal{J}})^{-1} = \alpha (v_{j_1} \cdots v_{j_t}), \end{aligned}$$

as we wanted to show.

If the matrix $R_{\mathcal{I}}$ is primitive, then by [Lemma 5.2](#) $(\lambda I - R_{\mathcal{I}})^{-1}$ has positive entries. Hence, if $p_{\mathcal{I}} > \alpha p_{\mathcal{J}}$, we have:

$$\begin{aligned} (v_{i_1} \cdots v_{i_t}) &= p_{\mathcal{I}} (\lambda I - R_{\mathcal{I}})^{-1} > \alpha p_{\mathcal{J}} (\lambda I - R_{\mathcal{I}})^{-1} \\ &= \alpha p_{\mathcal{J}} (\lambda I - R_{\mathcal{J}})^{-1} = \alpha (v_{j_1} \cdots v_{j_t}), \end{aligned}$$

□

Now we can finally use the above results to show that lexicographic representatives in A_n that finish with a_1 do not become negligible as n tends to infinity.

Theorem 5.4. *Let $P_{n,1}$ be the limit, when k tends to infinity, of the proportion of maximal lexicographic representatives of length k in A_n finishing with a_1 . Then $P_{n,1} > \frac{1}{8}$ for every $n \geq 1$.*

Proof. It is clear that $P_{1,1} = 1$, and we already saw that $P_{2,1} = \frac{1}{2}$. So we can assume that $n \geq 3$.

In [Theorem 2.3](#) we unveiled the structure of the automaton Γ_n , and hence of $\Gamma_n^* = \Gamma_n \setminus sh(\Gamma_{n-1})$. Recall from there that we denote $T_{1,n} = \{(1, 1, k, \emptyset); k = 1, \dots, n\} \subset \mathcal{S}_n$. From the structure of Γ_n we see that the only states in Γ_n^* with incoming arrows labeled a_1 are those in $T_{1,n}$. Hence, a lexicographic representative finishing with a_1 must end at a state in $T_{1,n}$.

Given a subgraph Γ of Γ_n^* , we will denote $v(\Gamma)$ the sum of the coordinates of v corresponding to the states of Γ , where v is the normalized Perron-Frobenius eigenvector for Γ_n^* . Notice that $P_{n,1} = v(T_{1,n})$. Hence, we must show that $v(T_{1,n}) > \frac{1}{8}$.

We will distinguish several subgraphs of Γ_n^* , and we will describe isomorphisms between some of them. Recall that if $w = (1, j, k, S)$ is a state of Γ_n^* not involving the number n , we defined $sh_{\bullet}(w) = (1, j', k', S')$, where i', j' and S' are obtained from i, j and S by increasing one unit all the numbers involved. We can keep applying sh_{\bullet} as long as the numbers involved are smaller than n . To simplify the notation, for every state w we will write $w^{(r)} = sh_{\bullet}^r(w)$ whenever this makes sense, that is, when the numbers involved in $w = (1, j, k, S)$ are at most $n - r$.

We already mentioned the subset of states $T_{1,n} = \{(1, 1, k, \emptyset); k = 1, \dots, n\}$. We will denote $t_{1,k} = (1, 1, k, \emptyset)$, for $k = 1, \dots, n$. Whenever $k + r \leq n$, we can consider the state $t_{1,k}^{(r)} = (1, 1 + r, k + r, \emptyset)$. Let us see which arrows in Γ_n^* end at these states.

The elements in $T_{1,n}$ have many incoming arrows, all labeled a_1 (see [Figure 2](#)). On the other hand, a state $t_{1,k}^{(1)}$ has all incoming arrows labeled a_2 , and it belongs to $sh_{\bullet}(\Gamma_{n-1}^*)$, which is almost identical to Γ_{n-1}^* : the inner arrows in $sh_{\bullet}(\Gamma_{n-1}^*)$ are precisely the inner arrows in Γ_{n-1}^* (shifted one unit), except those labeled a_1 . It follows that $sh_{\bullet}(\Gamma_{n-1}^*)$ has no inner arrow labeled a_2 . So there are no inner arrows in $sh_{\bullet}(\Gamma_{n-1}^*)$ ending at a state $t_{1,k}^{(1)}$. Hence, the arrows ending at $t_{1,k}^{(1)}$ in Γ_n^* must come from outside $sh_{\bullet}(\Gamma_{n-1}^*)$. By [Theorem 2.3](#) we see that the only incoming arrows are either

$$t_{1,1} \xrightarrow{a_2} t_{1,1}^{(1)}$$

or

$$t_{1,k+1} \xrightarrow{a_2} t_{1,k}^{(1)}$$

for $k = 2, \dots, n-1$. See [Figure 4](#), in which we have sketched the case $n = 5$.

If $r > 1$, as every arrow ending at $t_{1,k}^{(r)}$ is labeled a_{r+1} (and this is neither a_1 nor a_2), it must be the image under sh_{\bullet} of an arrow in Γ_{n-1}^* . It follows that the only such arrows are:

$$t_{1,1}^{(r-1)} \xrightarrow{a_{r+1}} t_{1,1}^{(r)}$$

and

$$t_{1,k+1}^{(r-1)} \xrightarrow{a_{r+1}} t_{1,k}^{(r)}$$

for $k = 2, \dots, n-r$. See [Figure 4](#).

We then have $\text{Pred}(t_{1,1}^{(r)}) = \{t_{1,1}^{(r-1)}\}$ and $\text{Pred}(t_{1,k}^{(r)}) = \{t_{1,k+1}^{(r-1)}\}$, for all $r = 1, \dots, n-1$ and $k = 2, \dots, n-r$. This shows a relation between the coordinates of the Perron-Frobenius eigenvector v , associated to these states:

$$v(t_{1,1}^{(r-1)}) = \lambda_n v(t_{1,1}^{(r)}), \quad v(t_{1,k+1}^{(r-1)}) = \lambda_n v(t_{1,k}^{(r)}).$$

We can collect these states, denoting (by abuse of notation) $T_{1,n}^{(r)} = \{t_{1,k}^{(r)}; k = 1, \dots, n-r\}$, for $i = 0, \dots, n-1$. All the direct predecessors of the states in $T_{1,n}^{(r)}$ belong to $T_{1,n}^{(r-1)}$, but there is one extra state in $T_{1,n}^{(r-1)}$, namely $t_{1,2}^{(r-1)}$, which is not one of these predecessors, but whose Perron-Frobenius coordinate is nonzero. Therefore:

$$v(T_{1,n}^{(r-1)}) > \lambda_n v(T_{1,n}^{(r)}),$$

for $r = 1, \dots, n-1$.

Now consider the states in Γ_n^* which belong to neither $T_{1,n}$ nor $sh_{\bullet}(\Gamma_{n-1}^*)$. By [Theorem 2.3](#), these states form the subgraphs $T_{2,n}, \dots, T_{n-1,n}$ and $\overline{sh(\Gamma_1^*)}, \dots, \overline{sh(\Gamma_{n-1}^*)}$. In order to simplify the notation, we will just denote Γ_m^* the subgraph $\overline{sh(\Gamma_m^*)}$, for $m = 1, \dots, n-1$ (see [Figure 4](#)).

Recall that, for $j \geq 2$, we have $T_{j,n} = \{(1, j, k, \{[1, j]\}); k = j+1, \dots, n\}$. Let us denote $t_{j,k} = (1, j, k, \{[1, j]\})$, for $2 \leq j < k \leq n$. We have already seen in [Theorem 2.3](#) that the arrows starting at such a state are precisely the following ones:

$$t_{j,k} \xrightarrow{a_{j+1}} t_{j+1,k}$$

if $k > j+1$, and

$$t_{j,k} \xrightarrow{a_j} (1, j, j, \{[1, j], [j-1, j]\}) \in \Gamma_{j-1}^*, \quad t_{j,k} \xrightarrow{a_1} (1, 1, j, \emptyset) \in T_{1,n}.$$

These arrows are represented in [Figure 4](#).

We also know that these states have no other incoming arrow, except when $j = 2$. The state $t_{2,k}$ (with $k > 2$), as we saw in [Theorem 2.3](#), has an incoming arrow labeled a_2 from every state in $sh_{\bullet}(\Gamma_{n-1}^*)$ whose diagram has a segment $[2, k]$ (and of course a black circle at position 1). These states are precisely the

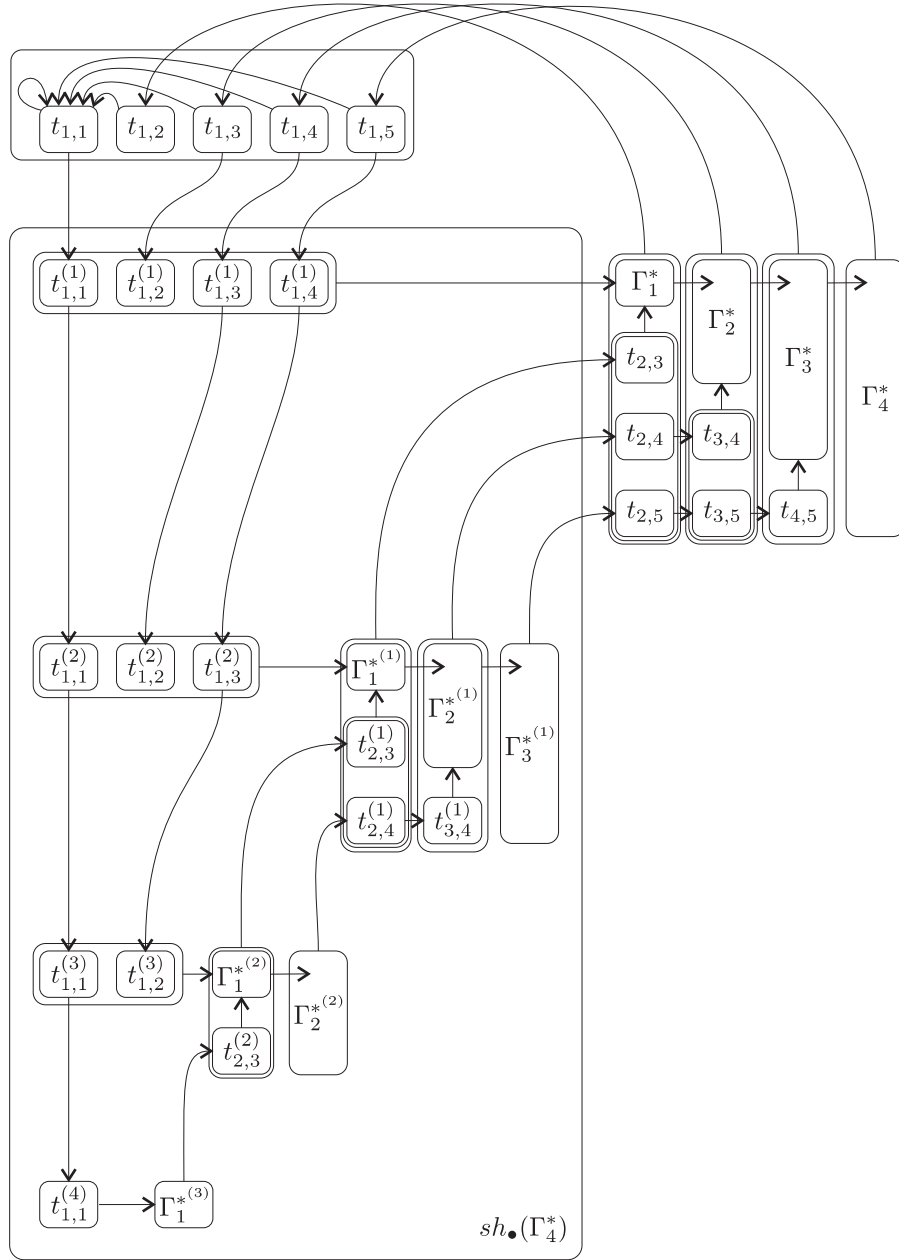

Figure 4: Outline of Γ_5^* , highlighting the transitions which repeat at different parts of the graph.

image under sh_\bullet of the states in Γ_{k-2}^* , and of the states $t_{k-1,l}$, for $l = k, \dots, n-1$. We will denote $\Gamma_m^{*(1)}$ the image under sh_\bullet of Γ_m^* , for $m = 1, \dots, n-2$ (for $m = n-1$ the shifting is not possible), and we will denote $t_{j,k}^{(1)} = sh_\bullet(t_{j,k})$, where $k < n$ (for $k = n$ the shifting is not possible). We have then seen that the arrows arriving to $t_{2,k}$ come from every state in $\Gamma_{k-2}^{*(1)}$ and from every state $t_{k-1,l}^{(1)}$, for $l = k, \dots, n-1$. See [Figure 4](#).

We are now interested in the arrows starting or finishing at some Γ_m^* , which are not inner arrows. This information can also be obtained from [Theorem 2.3](#). There is an arrow labeled a_2 from every state $t_{1,k}^{(1)}$ ($k = 1, \dots, n-1$), to the only state $(1, 2, 2, \{[1, 2]\}) \in \Gamma_1^*$. And there is an arrow labeled a_{m+2} from every arrow in Γ_m^* whose diagram has a square at position $m+1$, to a state in Γ_{m+1}^* whose diagram has square at position $m+2$. Also, there is an arrow labeled a_1 from every state in Γ_m^* to $t_{1,m+1}$.

We have then the whole picture of the arrows connecting the states in $\Gamma_1^*, \dots, \Gamma_{n-1}^*$ and the states $t_{j,k}$ with $2 \leq j < k \leq n$.

The important observation now is that every state in $sh_\bullet(\Gamma_{n-1}^*)$ which is not of the form $t_{1,k}^{(r)}$, is the image under a power of sh_\bullet of some of the states described in the previous paragraph. Indeed, the diagram of any element in $sh_\bullet(\Gamma_{n-1}^*)$ starts with a black circle. Suppose that it has black circles at positions $1, \dots, r$ but not at $r+1$. If it has a square at position $r+1$, then it is one of the states of the form $t_{1,k}^{(r)}$. Otherwise, it has a segment of the form $[r+1, r+m]$. But then it is equal to $w^{(r)}$, for some state w which either belongs to Γ_{m-1}^* , or has the form $t_{m,k}$.

Since applying sh_\bullet respects the transitions not labeled a_1 and increases the indices by 1, it follows that we can describe all transitions between the states in $sh_\bullet(\Gamma_{n-1}^*)$. They are precisely as described in [Figure 4](#).

In particular, this description allows us to notice that there are several isomorphic subgraphs in Γ_n^* : Every $\Gamma_m^{*(r)}$ is isomorphic, via sh_\bullet to $\Gamma_m^{*(r+1)}$, for every $r = 0, \dots, n-m-2$. We have now all the needed information to compare the values of the coordinates of v corresponding to the different subgraphs of Γ_n^* .

We claim that, for $r = 1, \dots, n-2$:

$$v(\Gamma_m^{*(r-1)}) > \lambda_n v(\Gamma_m^{*(r)})$$

and

$$v(t_{j,k}^{(r-1)}) > \lambda_n v(t_{j,k}^{(r)}).$$

In order to show this claim, we will define a partial order on the set of subgraphs

$$\mathcal{B} = \left\{ \Gamma_m^{*(r)} \right\}_{\substack{r=1, \dots, n-2 \\ m=1, \dots, n-r-1}} \cup \left\{ t_{j,k}^{(r)} \right\}_{\substack{r=1, \dots, n-3 \\ 2 \leq j < k \leq n-r}},$$

by saying that Γ is smaller than Δ if there is an arrow from a state of Γ to a state of Δ , and taking the transitive closure of this relation. We see in [Figure 4](#) that there is a unique minimal subgraph with respect to this partial order, namely $\Gamma_1^{*(n-2)}$. We will start by showing the claim for this one.

The subgraph $\Gamma_1^{*(n-2)}$ consists of a single state (with an arrow starting at ending at it). The incoming probability of this subgraph is $p_{\mathcal{J}} = (v(t_{1,1}^{(n-1)}))$. On the other hand, $\Gamma_1^{*(n-3)}$ is isomorphic to $\Gamma_1^{*(n-2)}$, and its incoming probability is $p_{\mathcal{I}} = (v(t_{1,1}^{(n-2)}) + v(t_{1,2}^{(n-2)}) + v(t_{2,3}^{(n-3)}))$.

We already know that $v(t_{1,1}^{(n-2)}) = \lambda_n v(t_{1,1}^{(n-1)})$. Hence $p_{\mathcal{I}} > \lambda_n p_{\mathcal{J}}$. Therefore, by [Proposition 5.3](#):

$$v(\Gamma_1^{*(n-3)}) > \lambda_n v(\Gamma_1^{*(n-2)}).$$

Now take a subgraph Γ in \mathcal{B} , and assume that the claim holds for smaller subgraphs (with respect to the described partial order). We know that there exists a subgraph Δ of Γ_n^* such that $\Gamma = sh_\bullet(\Delta)$, where sh_\bullet induces a subgraph isomorphism. Moreover, the arrows with target in Γ come either from subgraphs of \mathcal{B} which are smaller than Γ , or from $T_{1,n}^{(r)}$ for some $r > 1$. Hence, for every arrow $w \xrightarrow{a_i} w'$ with $w \notin \Gamma$

and $w' \in \Gamma$, there exists an arrow $u \xrightarrow{a_{i-1}} u'$ with $u \notin \Delta$ and $u' \in \Delta$, where $sh_\bullet(u) = w$ and $sh_\bullet(u') = w'$. Therefore, the ‘incoming probability’ for the graphs Γ and Δ satisfies

$$p_\Delta > \lambda_n p_\Gamma.$$

Now notice that if Γ is a single state (with no arrow starting and finishing at it), it is immediate that $v(\Delta) > \lambda_n v(\Gamma)$. Otherwise, Γ is isomorphic to Γ_m^* for some $m < n - 1$. Hence, its incidence matrix is primitive. Therefore, by [Proposition 5.3](#), we have

$$v(\Delta) > \lambda_n v(\Gamma),$$

showing the claim.

We can now collect all the information as follows. For $r = 0, \dots, n - 2$, denote

$$B_r = \left(\bigcup_{i=1}^{n-r-1} \Gamma_i^{*(r)} \right) \cup \left(\bigcup_{k=3}^{n-r} \bigcup_{j=2}^{k-1} t_{j,k}^{(r)} \right)$$

These are the subgraphs which are grouped together in [Figure 4](#). By the above arguments, we have shown that

$$v(B_0) > \lambda_n^r v(B_r)$$

for $r = 1, \dots, n - 2$. Hence:

$$\begin{aligned} v(B_1 \sqcup \dots \sqcup B_{n-2}) &= v(B_1) + \dots + v(B_{n-2}) \\ &< \left(\lambda_n^{-1} + \lambda_n^{-2} + \dots + \lambda_n^{-(n-2)} \right) v(B_0) < v(B_0). \end{aligned}$$

Recall that the sequence $\{\lambda_n\}$ is increasing and, as we will see in [Table 1](#), $\lambda_3 = 2.086 \dots$. Hence, assuming $n > 2$, we have $\lambda_n > 2$ and the last inequality holds.

On the other hand, we already showed that

$$v(T_{1,n}) > \lambda_n^r v(T_{1,n}^{(r)})$$

for $r = 1, \dots, n - 1$. Therefore

$$\begin{aligned} v(T_{1,n}^{(1)} \sqcup \dots \sqcup T_{1,n}^{(n-1)}) &= v(T_{1,n}^{(1)}) + \dots + v(T_{1,n}^{(n-1)}) \\ &< \left(\lambda_n^{-1} + \lambda_n^{-2} + \dots + \lambda_n^{-(n-1)} \right) v(T_{1,n}) < v(T_{1,n}). \end{aligned}$$

But we know that $sh_\bullet(\Gamma_{n-1}^*) = (B_1 \sqcup \dots \sqcup B_{n-2} \sqcup T_{1,n}^{(1)} \sqcup \dots \sqcup T_{1,n}^{(n-1)})$. Hence:

$$v(sh_\bullet(\Gamma_{n-1}^*)) < v(B_0) + v(T_{1,n}).$$

The three subgraphs in the above formula are disjoint, and cover the whole graph Γ_n^* . Hence:

$$v(sh_\bullet(\Gamma_{n-1}^*)) + v(B_0) + v(T_{1,n}) = v(\Gamma_n^*) = 1.$$

Therefore:

$$v(B_0) + v(T_{1,n}) > \frac{1}{2}.$$

Finally, we see that $\text{Pred}(T_{1,n}) = B_0 \sqcup T_{1,n}$. And there is a single arrow (labeled a_1), from each state in $B_0 \sqcup T_{1,n}$ to a state in $T_{1,n}$. This implies that

$$v(B_0) + v(T_{1,n}) = v(B_0 \sqcup T_{1,n}) = \lambda_n v(T_{1,n}).$$

Hence, as $\lambda_n < 4$ ([Theorem 5.1](#)):

$$v(T_{1,n}) > \frac{1}{2\lambda_n} > \frac{1}{8}.$$

□

Corollary 5.5. *Let P_{n,a_1} be the limit, when k tends to infinity, of the proportion of braids $\beta \in A_n$ of length k , such that $F_n(\beta) = F_n(a_1)$. Then $P_{n,a_1} > \frac{1}{32}$ for every $n \geq 1$.*

Proof. The number P_{n,a_1} is the limit, when k tends to infinity, of the proportion of lexicographic representatives finishing at the state $F_n(a_1)$, that is, at $t_{1,1}$. In other words, $P_{n,a_1} = v(t_{1,1})$.

Now it suffices to notice that $\text{Pred}(t_{1,1}) = T_{1,n}$. Hence, by [Theorem 5.4](#):

$$v(t_{1,1}) = \lambda_n^{-1} v(T_{1,n}) > \lambda_n^{-1} \frac{1}{8} > \frac{1}{32}.$$

□

Appendix: an algorithm to generate transition matrices.

In this paper we have described in detail the automaton Γ_n which accepts the language of maximal lexicographic representatives for the braid monoid A_n . Thanks to this analysis, we have been able to develop a computer program that generates the primitive transition matrix R_n corresponding to the subgraph Γ_n^* , from which the automaton Γ_n can be easily obtained: just recall that $\Gamma_1 = \Gamma_1^*$, and that Γ_n consists of a copy of Γ_{n-1} (that we denoted $sh(\Gamma_{n-1})$) and a copy of Γ_n^* , together with an arrow (labeled a_1) starting at each vertex of $sh(\Gamma_{n-1})$ and pointing to the first vertex of Γ_n^* . If one is interested in computing the actual automaton, the only information missing will be the labels of the arrows. These labels can be obtained from the proof of [Proposition 3.8](#).

Our main goal here is the computation of the matrix R_n , as its Perron-Frobenius eigenvalue corresponds to the growth rate of A_n , and its Perron-Frobenius left-eigenvector shows the proportion of maximal lexicographic representatives finishing at each state.

Recall (see [Figure 4](#)) that the automaton Γ_n^* is very similar to the automaton $sh_\bullet(\Gamma_n^*)$, the only difference being that the arrows labeled a_1 in Γ_n^* point to the states $t_{1,i}$, and the arrows labeled a_2 in $sh_\bullet(\Gamma_n^*)$ point to either Γ_1^* or to the states $t_{2,i}$. We will then use the same algorithm in both cases, with a flag (named ‘closed’) indicating whether we are computing Γ_n^* ($closed = 1$) or $sh_\bullet(\Gamma_n^*)$ ($closed = 0$).

We will order the rows of R_n (that is, the states of Γ_n^*) in a systematic way. See [Figure 4](#). The first n rows will correspond to the states $t_{1,1}, \dots, t_{1,n}$. The next rows will correspond to $sh_\bullet(\Gamma_{n-1}^*)$. And the final rows are ordered as they appear in [Figure 4](#), by columns: first $\Gamma_1^*, t_{2,3}, t_{2,4}, \dots, t_{2,n}$, then the states in $\Gamma_2^*, t_{3,4}, \dots, t_{3,n}$, and so on, until the final rows which correspond to the states of Γ_{n-1}^* . Inside $sh_\bullet(\Gamma_{n-1}^*)$ (whose states correspond to those of Γ_{n-1}^*), and inside each copy of Γ_i^* for $i = 1, \dots, n-1$, the states will be ordered in the same way, by recurrence.

Notice that we can easily compute the position of any state in [Figure 4](#) thanks to [Theorem 4.2](#), as the number of states of Γ_n^* is precisely $s_n - s_{n-1}$. We then need to pre-compute the numbers s_1, \dots, s_n , where s_i is the number of states in Γ_i . We will not write this explicitly, as it follows from the single formula in [Theorem 4.2](#). Or, even better, from the formula in [Proposition 4.1](#). For $i = 1, \dots, n$, let $s_i^* = s_i - s_{i-1}$ be the number of states in Γ_i^* . We can assume we have computed all these numbers, for $i = 1, \dots, n$.

We will define a procedure `Submatrix($R, j, H, s, closed$)`, that will take a sparse matrix R (that will eventually become R_n) and will compute the submatrix corresponding to either Γ_j^* (if $closed = 1$) or $sh_\bullet(\Gamma_j^*)$ (if $closed = 0$). It will place that submatrix starting at position $(1 + s, 1 + s)$ of R (s is just the shifting indicating where to place the submatrix). The input H is a vector that should be pre-computed, and contains the exact positions of the source states of the horizontal arrows in [Figure 4](#) going from Γ_i^* to Γ_{i+1}^* , for $i = 1, \dots, j-2$.

The numbers in H are very particular, and the same numbers can be used for $i = 1, \dots, j-2$. That is why they can be pre-computed. By the proof of [Proposition 3.8](#) we know that the mentioned arrows go from the segment configuration $(1, i+1, i+1, S)$ to the segment configuration $(1, i+2, i+2, S')$, where

$S = \{[1, i+1], [i_2, i+1], \dots, [i_t, i+1]\}$ and $S' = \{[1, i+2], [i_2, i+2], \dots, [i_t, i+2]\}$. There are exactly 2^{i-1} such arrows (the set $\{i_2, \dots, i_t\}$ can be any subset of $\{2, \dots, i\}$). It turns out that the source states of these arrows correspond to the following (we will use the whole diagram in [Figure 4](#) as a picture of Γ_i^*): first, the state appearing at the bottom-left of [Figure 4](#) ($t_{1,1}^{(i-1)}$); then the only state of $\Gamma_1^{*(i-2)}$; then the same two described states, but inside $\Gamma_2^{*(i-3)}$; then the same four described states, but inside $\Gamma_3^{*(i-4)}$; and so on. These positions configure the numbers in H . On the other hand, the target states of the arrows from Γ_{i-1}^* to Γ_i^* are actually a subset of the source states from Γ_i^* to Γ_{i+1}^* ; namely, they correspond to the entries of H placed in odd positions.

Therefore, since the exact positions can be computed from the structure revealed in [Figure 4](#) and the knowledge of the numbers s_i^* , the vector H can be determined as follows:

Algorithm 1 Computing the vector H used in the computation of R_j

Input: Integer $j \geq 2$.

Output: A vector H of length 2^{j-1} containing the positions in Γ_j^* of the source states of the horizontal arrows in [Figure 4](#)

```

1:  $H := [1]$ 
2: for  $i := 2$  to  $j$  do
3:    $x := s_i^* - s_{i-1}^* - i$ 
4:   If  $H = [h_1, \dots, h_r]$ , set  $H' := [h_1 + x, \dots, h_r + x]$ 
5:    $H :=$ concatenation of  $H$  and  $H'$ .
6: return  $H$ 

```

As an example, if $j = 4$, the algorithm will produce $H = [0, 1, 6, 7, 21, 22, 27, 28]$. In Γ_5^* (see [Figure 4](#)), if we consider that the position 0 corresponds to the bottom state $t_{1,1}^{(4)}$, then these positions correspond respectively to the state $t_{1,1}^{(4)}$, the only state in $\Gamma_1^{*(3)}$, the two bottom states in $\Gamma_2^{*(2)}$, and the four states repeating the same pattern in $\Gamma_3^{*(1)}$. Notice that for $j = 3$ we have $H = [0, 1, 6, 7]$. So having computed H for some j , we have computed it for all smaller indices.

Inside each Γ_i^* , one needs to locate the bottom state (corresponding to 0). But this is easy, as it is the state number $\binom{i+1}{2}$ in Γ_i^* . This means that in any automaton in which we have horizontal arrows from Γ_3^* to Γ_4^* , the arrows will start at positions $[0 + \binom{4}{2}, 1 + \binom{4}{2}, 6 + \binom{4}{2}, 7 + \binom{4}{2}] = [6, 7, 12, 13]$ (inside Γ_3^*), and will finish at positions $[0 + \binom{5}{2}, 6 + \binom{5}{2}, 21 + \binom{5}{2}, 27 + \binom{5}{2}] = [10, 16, 31, 37]$ (inside Γ_4^*).

With this information, and following the pattern of [Figure 4](#), we provide in [Algorithm 2](#) the routine that allows to compute R_n .

Therefore, in order to compute the transition matrix R_n , one just needs to do the following:

1. Compute s_1^*, \dots, s_n^* , using [Proposition 4.1](#) (where $s_i^* = s_i - s_{i-1}$).
2. Compute H using [Algorithm 1](#), taking $j = n - 1$.
3. Initialize R as a $s_n^* \times s_n^*$ sparse zero matrix.
4. Call `Submatrix($R, n, H, 0, 1$)`.

We know that the number of rows of R_n grows exponentially with respect to n , so we cannot compute these matrices for big values of n ; however, we can provide the computations for $n = 2, \dots, 9$. We compute in this case the matrix R_n , the Perron-Frobenius eigenvalue λ_n (which is the growth rate of A_n), the first entry of the Perron-Frobenius eigenvector whose coordinates add up to 1 (which is equal to P_{n,a_1}), and the sum of the first n entries of the same eigenvector (which is equal to $P_{n,1}$). The results of this computation are shown in [Table 1](#).

It can be checked that the values of λ_n coincide with the inverses of the smallest real roots of the polynomials $H_n(x)$ which determine the growth series $\frac{1}{H_n(x)}$ of the monoid A_n (see [\[3\]](#)). In other words,

Algorithm 2 $\text{Submatrix}(R, j, H, s, \text{closed})$.

Input: Sparse matrix R , integer $j \geq 1$, vector of integers H , integer $s \geq 0$, bit $\text{closed} \in \{0, 1\}$

Output: Transforms the matrix R , inserting 1's in the submatrix of size $s_j^* \times s_j^*$ whose upper left corner is $(1 + s, 1 + s)$, at the positions corresponding either to the arrows of Γ_j^* (if $\text{closed} = 1$), or to the arrows starting at $s_\bullet(\Gamma_j^*)$ (if $\text{closed} = 0$).

```

1: if  $\text{closed} = 1$  then
2:   for  $i := 1$  to  $j$  do
3:      $R[i + s, 1 + s] := 1$  (Arrows from  $t_{1,i}$  to  $t_{1,1}$ )
4:   else
5:     for  $i := 1$  to  $j$  do
6:        $R[i + s, 1 + s_j^* + s] := 1$  (Arrows from  $t_{1,i}^{(1)}$  to  $\Gamma_1^*$ )
7:     if  $j > 1$  then
8:        $R[1 + s, j + 1 + s] := 1$  (Arrow from  $t_{1,1}$  to  $t_{1,1}^{(1)}$ )
9:     for  $i := 3$  to  $j$  do
10:       $R[i + s, j + i - 1 + s] := 1$  (Arrows from  $t_{1,i}$  to  $t_{1,i}^{(1)}$ )
11:    Call  $\text{Submatrix}(R, j - 1, H, s + j, 0)$  (Arrows starting at  $sh_\bullet(\Gamma_{j-1}^*)$ )
12:     $s' := s + j + s_{j-1}^*$  ( $s' + 1 = \text{position of } \Gamma_1^*$ )
13:    for  $i := 1$  to  $j - 1$  do
14:      Call  $\text{Submatrix}(R, i, H, s', 1)$  (Arrows in  $\Gamma_i^*$ )
15:      if  $i = 1$  then
16:        for  $k := 1$  to  $j - 2$  do
17:           $R[s' + 1 + k, s' + 1] := 1$  (Arrows from  $t_{2,k+2}$  to  $\Gamma_1^*$ )
18:        else
19:          for  $k := 1$  to  $j - i - 1$  do
20:             $R[s' + s_i^* + k, s' + \binom{i+1}{2} + 1] := 1$  (Arrows from  $t_{i+1,i+k+1}$  to  $\Gamma_i^*$ )
21:          for  $k := 2$  to  $j - i - 1$  do
22:             $R[s' + s_i^* + k, s' + s_i^* + k + s_{i+1}^* + j - i - 2] := 1$  (Arrows from  $t_{i+1,i+k+1}$  to  $t_{i+2,i+k+1}$ )
23:          if  $\text{closed} = 1$  then
24:            for  $k := s' + 1$  to  $s' + s_i^* + j - i - 1$  do
25:               $R[k, s + i + 1] := 1$  (Arrows from all states of  $\Gamma_i^*$  and  $t_{i+1,r}$  to  $t_{1,i+1}$ )
26:            else
27:              for  $k := s' + 1$  to  $s' + s_i^* + j - i - 1$  do
28:                 $R[k, s + s_j^* + i + 1] := 1$  (Arrows from all states of  $\Gamma_i^*$  and  $t_{i+1,r}^{(1)}$  to  $t_{2,i+2}$ )
29:            if  $i < j - 1$  then
30:              for  $k := 1$  to  $2^{i-1}$  do
31:                 $R[s' + \binom{i+1}{2} + H[k], s' + s_i^* + j - i - 1 + \binom{i+2}{2} + H[2k - 1]] := 1$  (Arrows from  $\Gamma_i^*$  to  $\Gamma_{i+1}^*$ )
32:               $s' := s' + s_i^* + j - i - 1$ 

```

	λ_n	P_{n,a_1}	$P_{n,1}$	
2	1.61803398874989535	0.309016994387306732	0.5	
3	2.08679122278138296	0.179072361848063216	0.3736866329	
4	2.39485036123379746	0.134155252415486176	0.3212817547	
n	5	2.59937733237127854	0.113418385255364101	0.2948171798
	6	2.73962959897194480	0.102094618000846169	0.2797014374
	7	2.83910705543066832	0.095188754079773799	0.2702510632
	8	2.91185367833772002	0.090638078480376610	0.2639248222
	9	2.96648976449784296	0.087464812090583224	0.2594634699

Table 1: Growth rates for A_n , the proportion of lexicographic representatives in A_n finishing at the initial state of Γ_n^* , and the proportion of lexicographic representatives finishing with a_1 .

the computed values λ_n correspond, as they should, to the radius of convergence of the growth series of A_n .

On the other hand, one can see that the values of P_{n,a_1} are decreasing, and greater than $1/32 = 0.03125$ (as stated in [Corollary 5.5](#)), and that the values of $P_{n,1}$ are also decreasing, and greater than $1/8 = 0.125$ (as stated in [Theorem 5.4](#)). Notice that, as expected, the values in the third column of [Table 1](#) are precisely the product of the values in the first two columns. That is, $P_{n,1} = \lambda_n P_{n,a_1}$.

Remark. In [\[3\]](#) we show, using the results in this paper, that the sequence $\{\lambda_n\}_{n \geq 1}$ tends to $3.233636\dots$. Therefore, we have $\lambda_n < 3.233637$. This allows to improve our lower bounds, replacing 4 by 3.233637 , and obtaining:

$$P_{n,a_1} > 0.0478 \quad P_{n,1} > 0.1546$$

References

- [1] J. Cannon, D. Epstein, D. Holt, S. Levy, M. Paterson and W. Thurston, *Word processing in groups*. Jones and Bartlett Publishers, Boston, MA, 1992.
- [2] R. Charney, *Artin groups of finite type are biautomatic*. Math. Ann., 292 (1992), 671–683.
- [3] R. Flores and J. González-Meneses, *On the growth of Artin–Tits monoids and the partial theta function*, arXiv:1808.03066
- [4] V. Gebhardt and J. González-Meneses, *Generating random braids*. J. Comb. Th. A 120 (1), 2013, 111–128.
- [5] D. Holt, S. Rees and C. Röver, *Groups, languages and automata*. London Mathematical Society Student Texts, 88. Cambridge University Press, Cambridge, 2017.
- [6] V. Jugé, *Combinatorics of braids*, PhD Thesis, 2016.
<http://www-igm.univ-mlv.fr/~juge/papers/PhD-Thesis.pdf>
- [7] E. Seneta, *Non-negative Matrices and Markov Chains*, Springer, 1981.

Ramón Flores.

ramonjflores@us.es

Depto. de Geometría y Topología. Instituto de Matemáticas (IMUS).
Universidad de Sevilla. Av. Reina Mercedes s/n, 41012 Sevilla (Spain).

Juan González-Meneses.

meneses@us.es

Depto. de Álgebra. Instituto de Matemáticas (IMUS).
Universidad de Sevilla. Av. Reina Mercedes s/n, 41012 Sevilla (Spain).