

Lower- and higher-order nonclassical properties of photon added and subtracted displaced Fock states

Priya Malpani[†], Nasir Alam[‡], Kishore Thapliyal[‡], Anirban Pathak[‡], V. Narayanan[†],
Subhashish Banerjee[†]

[†]Indian Institute of Technology Jodhpur, Jodhpur 342011, India

[‡]Jaypee Institute of Information Technology, A-10, Sector-62, Noida, UP-201307, India

August 7, 2018

Abstract

Nonclassical properties of photon added and subtracted displaced Fock states have been studied using various witnesses of lower- and higher-order nonclassicality. Compact analytic expressions are obtained for the nonclassicality witnesses. Using those expressions, it is established that these states and the states that can be obtained as their limiting cases (except coherent states) are highly nonclassical as they show the existence of lower- and higher-order antibunching and sub-Poissonian photon statistics, in addition to the nonclassical features revealed through the Mandel Q_M parameter, zeros of Q function, Klyshko's criterion, and Agarwal-Tara criterion. Further, some comparison between the nonclassicality of photon added and subtracted displaced Fock states have been performed using witnesses of nonclassicality. This has established that between the two types of non-Gaussianity inducing operations (i.e., photon addition and subtraction) used here, photon addition influences the nonclassical properties more strongly. Further, optical designs for the generation of photon added and subtracted displaced Fock states from squeezed vacuum state have also been proposed.

1 Introduction

With the advent of quantum state engineering [1–4] and quantum information processing ([5] and references therein), the study of nonclassical properties of engineered quantum states have become a very important field. This is so because the presence of nonclassical features in a quantum state can only provide quantum supremacy. In the recent past, various techniques for quantum state engineering have been developed [1–4, 6, 7]. If we restrict ourselves to optics, these techniques are primarily based on the clever use of beam splitters and detectors, measurements with post selection, etc. Such techniques are useful in creating holes in the photon number distribution [8] and in generating finite dimensional quantum states [3], both of which are nonclassical [9]. The above said techniques are also useful in realizing non-Gaussianity inducing operations, like photon addition and subtraction [10, 11]. Keeping this in mind, in what follows, we aim to study the nonclassical properties of a set of engineered quantum states (both photon added and subtracted) which can be produced by using the above mentioned techniques. The work is further motivated by the fact that recently several applications of nonclassical states have been reported. Specifically, squeezed states have played an important role in the studies related to phase diffusion [12, 13], the detection of gravitational waves in LIGO experiments [14–16], teleportation of coherent states [17], and continuous variable quantum cryptography [18]. The rising demand for a single photon source can be fulfilled by an antibunched light source [19]. The study of quantum correlations is important both from the perspective of pure and mixed states [20–23]. Entangled states are found to be useful in both secure [24] and insecure [25, 26] quantum communication schemes. Stronger quantum correlation present in the steerable states are used to ensure the security against all the side-channel attacks on devices used in one-side (i.e., either preparation or detector side) for quantum cryptography [27]. Quantum supremacy in computation is established due to quantum algorithms for unsorted database search [28], factorization and discrete logarithm problems [29], and machine learning [30] using essentially nonclassical states.

It is well-known that a state having a negative P -function is referred to as a nonclassical state. Such a state cannot be expressed as a mixture of coherent states and does not possess a classical analogue. In contrast to these states, coherent states are classical, but neither their finite dimensional versions [3, 31] nor their generalized versions are classical [12], [32–34]. Here, we would like to focus on photon added and subtracted versions of a particular type of generalized coherent state, which is also referred to as the displaced Fock state (DFS). To be precise, state of the form $|\psi\rangle = D(\alpha)|n\rangle$, where $D(\alpha)$ is the displacement operator with Fock state $|n\rangle$, is referred to as generalized coherent state (cf. Ref. [32]), as this state is reduced to a coherent state in the limit $n = 0$. However, from the structure of the state it seems more appropriate to call this state

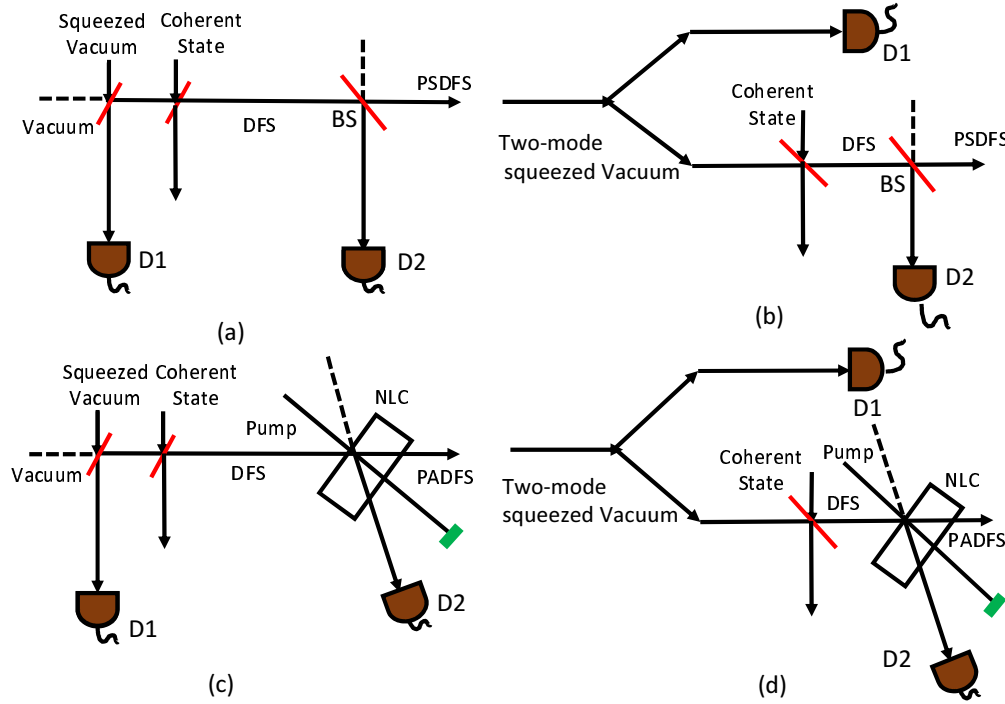

Figure 1: (Color online) A schematic diagram for the generation of PSDFS (in (a) and (b)) and PADFS (in (c) and (d)). In (a) and (c) ((b) and (d)), single-mode (two-mode) squeezed vacuum is used for generation of the desired state. Here, NLC corresponds to nonlinear crystal, BS is a beamsplitter, and D1 and D2 are photon number resolving detectors.

as the DFS, and this seems to be the nomenclature usually adopted in the literature [35–38], this state has been referred to as the DFS. In some other works, it is referred to as displaced number state [39–41], but all these names are equivalent; and in what follows, we will refer to it as DFS. This is an extremely interesting quantum state for various reasons. Specifically, its relevance in various areas of quantum optics is known. For example, in the context of cavity QED, it constitutes the eigenstates of the Jaynes-Cummings systems with coherently driven atoms [42]. Naturally, various lower-order nonclassical properties and a set of other quantum features of DFS have already been studied. Specifically, quasiprobability distributions of DFS were studied in [36], phase fluctuations of DFS was investigated in [43], decoherence of superposition of DFS was discussed in [41], Q function, Wigner function and probability distribution of DFS were studied in [44], Pancharatnam phase of DFS has been studied in [45]. Further, in the context of non-optical DFS, various possibilities of generating DFS from Fock states by using a general driven time-dependent oscillator has been discussed in [46]; and in the trapped-ion system, quantum interference effects have been studied for the superposition of DFS [4]. Thus, DFS seems to be a well studied quantum state, but it may be noted that a little effort has yet been made to study higher-order nonclassical properties of DFS. It is a relevant observation as in the recent past, it has been observed that higher-order nonclassicality has various applications [47–50], and it can be used to detect the existence of weak nonclassical characters [51–59]. Further, various higher-order nonclassical features have been experimentally detected [60–63]. However, we do not want to restrict to DFS, rather we wish to focus on lower- and higher-order nonclassical properties of a set of even more general states, namely photon added DFS (PADFS) and photon subtracted DFS (PSDFS). The general nature of these states can be visualized easily, as in the special case that no photon is added (subtracted) PADFS (PSDFS) would reduce to DFS. Further, for $n = 0$, PADFS would reduce to photon added coherent state which has been widely studied ([6, 54, 64] and references therein) and experimentally realized [10, 65]. Here it is worth noting that DFS has also been generated experimentally by superposing a Fock state with a coherent state on a beam splitter [66]. Further, an alternative method for the generation of DFS has been proposed by Oliveira et al. [67]. From the fact that photon added coherent state and DFS have already been generated experimentally, and the fact that the photon added states can be prepared via conditional measurement on a beam splitter, it appears that PADFS and PSDFS can also be built in the lab. In fact, inspired by these experiments, we have proposed a schematic diagram for generating the PADFS and PSDFS in Fig. 1 using single-mode and two-mode squeezed vacuum states. Specifically, using three (two) highly transmitting beamsplitters, a conditional measurement of single photons at both detectors D1 and D2 in Fig. 1 (a) (Fig. 1 (b)) would result in single photon subtracted DFS as output from a single-mode (two-mode) squeezed vacuum state. Similarly, to generate PADFS conditional subtraction of photon is replaced by photon addition, using a nonlinear crystal and heralding one

output mode for a successful measurement of a single photon to ensure generation of single photon added DFS. This fact, their general nature, and the fact that nonclassical properties of PADFS and PSDFS have not yet been accorded sufficient attention, has motivated us to perform this study.

Motivated by the above facts, in what follows, we investigate the possibilities of observing lower- and higher-order sub-Poissonian photon statistics, antibunching and squeezing in PADFS and PSDFS. We have studied nonclassical properties of these states through a set of other witnesses of nonclassicality, e.g., zeros of Q function, Mandel Q_M parameter, Klyshko's criterion, and Agarwal-Tara parameter. These witnesses of nonclassicality successfully establish that both PADFS and PSDFS (along with most of the states to which these two states reduce at different limits) are highly nonclassical. Thus, making use of the analytical expressions of moments of creation and annihilation operators, discussed below, facilitates an analytical understanding for most of the nonclassical witnesses.

The rest of the paper is organized as follows. In Section 2, quantum states of our interest (i.e., PADFS and PSDFS) have been introduced in detail. In Section 3, we describe various witnesses and measures of nonclassicality and report analytic expressions of most of them for the quantum states of our interest. Further, the existence of various lower- and higher-order nonclassical features in PADFS and PSDFS are shown through a set of plots. Finally, we conclude in Section 4.

2 Quantum states of our interest

We have already mentioned that we are interested in PADFS and PSDFS. Before mathematically defining these states, we may note that in the Fock state basis, a DFS may be described as follows

$$|\phi(n, \alpha)\rangle = D(\alpha)|n\rangle = \frac{1}{\sqrt{n!}} \sum_{p=0}^n \binom{n}{p} (-\alpha^*)^{(n-p)} \exp\left[-\frac{|\alpha|^2}{2}\right] \sum_{m=0}^{\infty} \frac{\alpha^m}{m!} \sqrt{(m+p)!} |m+p\rangle. \quad (1)$$

Using this state, we can define a u photon added DFS (i.e., a PADFS) as

$$|\psi_+(u, n, \alpha)\rangle = N_+ \hat{a}^{\dagger u} |\phi(n, \alpha)\rangle = \frac{1}{\sqrt{n!}} \sum_{p=0}^n \binom{n}{p} (-\alpha^*)^{(n-p)} \exp\left(-\frac{|\alpha|^2}{2}\right) \sum_{m=0}^{\infty} \frac{\alpha^m}{m!} \sqrt{(m+p+u)!} |m+p+u\rangle. \quad (2)$$

Similarly, a v photon subtracted DFS (i.e., a PSDFS) can be expressed as

$$|\psi_-(v, n, \alpha)\rangle = N_- \hat{a}^v |\phi(n, \alpha)\rangle = \frac{1}{\sqrt{n!}} \sum_{p=0}^n \binom{n}{p} (-\alpha^*)^{(n-p)} \exp\left(-\frac{|\alpha|^2}{2}\right) \sum_{m=0}^{\infty} \frac{\alpha^m}{m!} \frac{(m+p)!}{\sqrt{(m+p-v)!}} |m+p-v\rangle, \quad (3)$$

where m and p are the real integers. Here,

$$N_+ = \left[\frac{1}{n!} \sum_{p,p'=0}^n \binom{n}{p} \binom{n}{p'} (-\alpha^*)^{(n-p)} (-\alpha)^{(n-p')} \exp[-|\alpha|^2] \sum_{m=0}^{\infty} \frac{\alpha^m (\alpha^*)^{m+p-p'} (m+p+u)!}{m! (m+p-p')!} \right]^{-\frac{1}{2}}, \quad (4)$$

and

$$N_- = \left[\frac{1}{n!} \sum_{p,p'=0}^n \binom{n}{p} \binom{n}{p'} (\alpha^*)^{(n-p)} (-\alpha)^{(n-p')} \exp[-|\alpha|^2] \sum_{m=0}^{\infty} \frac{\alpha^m (\alpha^*)^{m+p-p'} (m+p)!}{m! (m+p-p')! (m+p-v)!} \right]^{-\frac{1}{2}} \quad (5)$$

are the normalization constants, and subscripts $+$ and $-$ correspond to photon addition and subtraction. Thus, $|\psi_+(u, n, \alpha)\rangle$ and $|\psi_-(v, n, \alpha)\rangle$ represent u photon added DFS and v photon subtracted DFS, respectively, for the DFS which has been produced by displacing the Fock state $|n\rangle$ by a displacement operator $D(\alpha)$ characterized by the complex parameter α . Clearly, the addition and the subtraction of photons on the DFS can be mathematically viewed as application of the creation and annihilation operators from the left on the Eq. (1). Here it may be noted that different well-known states can be obtained as special cases of these two states. For example, using the notation introduced above to define PADFS and PSDFS, we can describe a coherent state $|\alpha\rangle$ as $|\alpha\rangle = |\psi_+(0, \alpha, 0)\rangle = |\psi_-(0, \alpha, 0)\rangle$, naturally, coherent state can be viewed as a special case of both PADFS and PSDFS. Similarly, we can describe a single photon added coherent state as $|\psi\rangle_{\text{PACS}} = |\psi_+(1, \alpha, 0)\rangle$, a Fock state as $|n\rangle = |\psi_+(0, 0, n)\rangle$ and a DFS as $|\psi\rangle_{\text{DFS}} = |\psi_+(0, \alpha, n)\rangle = |\psi_-(0, \alpha, n)\rangle$.

In what follows, we will see that various experimentally measurable nonclassicality witnesses can be expressed as the moments of annihilation and creation operators [60–63, 68]. To utilize those witnesses to identify the signatures of nonclassicality, we will compute an analytic expression for the most general moment, $\langle \hat{a}^{\dagger q} \hat{a}^r \rangle$, with q and r being non-negative integers. This is the most general moment in the sense that any other moment can be obtained as a special case of it. For example, if we need $\langle a^2 \rangle$, we would just require to consider $q = 2$ and $r = 0$. Thus, an analytic expression for $\langle \hat{a}^{\dagger q} \hat{a}^r \rangle$ would essentially help us to obtain analytic expression for any moment-based witness of nonclassicality. Further, the analytic expressions of moment obtained for PADFS and PSDFS would also help us to obtain nonclassical features in the set of states obtained in the limiting cases, like Fock state, DFS, photon added coherent state. Keeping this in mind, we have computed $\langle \psi_+(u, n, \alpha) | \hat{a}^{\dagger q} \hat{a}^r | \psi_+(u, n, \alpha) \rangle$ and $\langle \psi_-(v, n, \alpha) | \hat{a}^{\dagger q} \hat{a}^r | \psi_-(v, n, \alpha) \rangle$, and provide the final analytic expressions of these moments without going into the mathematical details to maintain the flow of the paper. The obtained expressions for the above mentioned moments for PADFS and PSDFS are

$$\begin{aligned} \langle \hat{a}^{\dagger q} \hat{a}^r \rangle_{\text{PADFS}} = \langle \psi_+(u, n, \alpha) | \hat{a}^{\dagger q} \hat{a}^r | \psi_+(u, n, \alpha) \rangle &= \frac{N_+^2}{n!} \sum_{p, p'=0}^n \binom{n}{p} \binom{n}{p'} (-\alpha^*)^{(n-p)} (-\alpha)^{(n-p')} \exp[-|\alpha|^2] \\ &\times \sum_{m=0}^{\infty} \frac{\alpha^m (\alpha^*)^{m+p-p'-r+q} (m+p+u)! (m+p+u-r+q)!}{m! (m+p-p'-r+q)! (m+p+u-r)!}, \end{aligned} \quad (6)$$

and

$$\begin{aligned} \langle \hat{a}^{\dagger q} \hat{a}^r \rangle_{\text{PSDFS}} = \langle \psi_-(v, n, \alpha) | \hat{a}^{\dagger q} \hat{a}^r | \psi_-(v, n, \alpha) \rangle &= \frac{N_-^2}{n!} \sum_{p, p'=0}^n \binom{n}{p} \binom{n}{p'} (-\alpha^*)^{(n-p)} (-\alpha)^{(n-p')} \exp[-|\alpha|^2] \\ &\times \sum_{m=0}^{\infty} \frac{\alpha^m (\alpha^*)^{m+p-p'-r+q} (m+p)! (m+p-r+q)!}{m! (m+p-p'-r+q)! (m+p-v-r)!}, \end{aligned} \quad (7)$$

respectively. The values of normalization constants for PADFS and PSDFS are already given in Eqs. (4) and (5), respectively. In the following section, we shall investigate the possibilities of observing various types lower- and higher-order nonclassical features in PADFS and PSDFS by using Eqs. (6) and (7).

3 Nonclassical features of PADFS and PSDFS

The moments of number operators for PADFS and PSDFS states obtained in the previous section enable us to study nonclassical properties of these states using a set of moments-based criteria of nonclassicality [68] [69]. In the recent past, an infinite set of these moments-based criteria is shown to be equivalent to the P function-based criterion, i.e., it becomes both necessary and sufficient [70, 71]. However, in this section, we will use a subset of this infinite set as witnesses of nonclassicality to investigate various nonclassical properties of the PADFS and PSDFS. Specifically, nonclassicality will be witnessed through Mandel Q_M parameter, criteria of lower- and higher-order antibunching, Agarwal-Tara criterion, Klyshko's criterion, criteria of higher-order sub-Poissonian photon statistics, etc. We will further discuss a quasiprobability distribution, namely Q function, which is also a witness of nonclassicality. Specifically, zeros of Q function are signatures of nonclassicality.

3.1 Mandel Q_M Parameter

The Mandel Q_M parameter [72] illustrates the nonclassicality through photon number distribution in a quantum state. The Mandel Q_M parameter is defined as

$$Q_M = \frac{\langle (\hat{a}^{\dagger} \hat{a})^2 \rangle - \langle \hat{a}^{\dagger} \hat{a} \rangle^2 - \langle \hat{a}^{\dagger} \hat{a} \rangle}{\langle \hat{a}^{\dagger} \hat{a} \rangle}. \quad (8)$$

The negative values of Q_M parameter essentially indicate the negativity for P function and so it gives a witness for nonclassicality which can be calculated using Eqs. (6) and (7). For the Poissonian statistics it becomes 0, while for the sub-Poissonian (super-Poissonian) photon statistics it has negative (positive) values.

In Fig. 2, the dependence of Q_M on the state parameter α and non-Gaussianity inducing parameters is shown. Specifically, variation of Q_M parameter for PADFS and PSDFS is shown with state parameter α , where the effect of the number of photons added/subtracted and the initial Fock state is also established. For $\alpha = 0$, the PADFS with an arbitrary number of photon addition has Q_M parameter -1, which can be attributed to the fact that final state, which reduces to the Fock state ($|1\rangle$ chosen to be displaced in this case) is the most nonclassical state (cf. Fig. 2 (a)). With increase in the number of photons added to the DFS, the depth of nonclassicality witness Q_M increases. However, the witness of nonclassicality tends towards the positive side for higher values of the displacement parameter. In contrast to the photon addition, with the subtraction of photons from

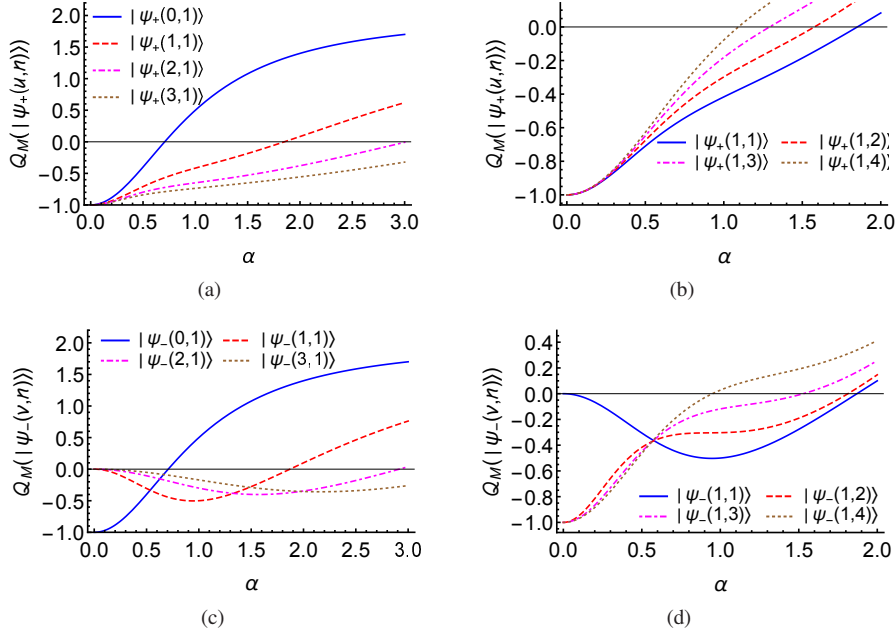

Figure 2: (Color online) Variation of Mandel Q_M parameter for PADFS (in (a) and (b)) and PSDFS (in (c) and (d)) is shown with displacement parameter α . In (a) and (c), the value of number of photons added/subtracted (i.e., u or v) is changed for the same initial Fock state $|1\rangle$. Different initial Fock states $|n\rangle$ are chosen to be displaced in (b) and (d) for the single photon addition/subtraction.

the DFS the Q_M parameter becomes almost zero for the smaller values of displacement parameter α in DFS as shown in Fig. 2 (c). This behavior can be attributed to the fact that photon subtraction from $D(\alpha)|1\rangle$ for small values of α will most likely yield vacuum state. Also, with the increase in the displacement parameter the witness of nonclassicality becomes more negative as with a higher average number of photons in DFS photon subtraction becomes more effective. However, for the larger values of displacement parameter the nonclassicality disappears analogous to the PADFS.

As Fock states are known to be nonclassical, and photon addition and subtraction are established as nonclassicality inducing operations, it would be worth comparing the effect of these two independent factors responsible for the observed nonclassical features in the present case. To perform this study, we have shown the variation of the single photon added (subtracted) DFS with different initial Fock states in Fig. 2 (b) (Fig. 2 (d)). Specifically, the nonclassicality present in PADFS decays faster for the higher values of the Fock states with increasing displacement parameter (cf. Fig. 2 (b)). However, such nature was not present in PSDFS shown in Fig. 2 (d). Note that variation of Q_M parameter with α starts from 0 (-1) iff $u \leq n$ ($u > n$). For instance, if $u = n = 1$, i.e., corresponding to state $\hat{a}D(\alpha)|1\rangle$, nonclassicality witness is zero for $\alpha = 0$ as it corresponds to vacuum state. Therefore, the present study reveals that photon addition is a stronger factor for the nonclassicality present in the state when compared to the initial Fock state chosen to be displaced. Whereas photon subtraction is a preferred choice for large values of displacement parameter in contrast to the higher values of Fock states to displace with small α . Among photon addition and subtraction, addition is a preferred choice for the smaller values of displacement parameter, while the choice between addition and subtraction becomes immaterial for large α .

3.2 Lower- and higher-order antibunching

In this section, we study lower- and higher-order antibunching. To do so, we use the following criterion of $(l - 1)$ th order antibunching ([73] and references therein)

$$d(l - 1) = \langle \hat{a}^{\dagger l} \hat{a}^l \rangle - \langle \hat{a}^\dagger \hat{a} \rangle^l < 0. \quad (9)$$

This nonclassicality feature characterizes suitability of the quantum state to be used as single photon source as the negative values of $d(l - 1)$ parameter shows that the probability of photons coming bunched is less compared to that of coming independently. The signature of lower-order antibunching can be obtained as a special case of Eq. (9) for $l = 2$, and that for $l \geq 3$, the negative values of $d(l - 1)$ correspond to higher-order antibunching of $(l - 1)$ th order. The nonclassicality reflected by the lower-order antibunching criterion obtained here is the same as Mandel Q_M parameter illustrated in Fig. 2. Therefore, we will rather discuss here the possibility of observing higher-order antibunching in the quantum states of our interest using

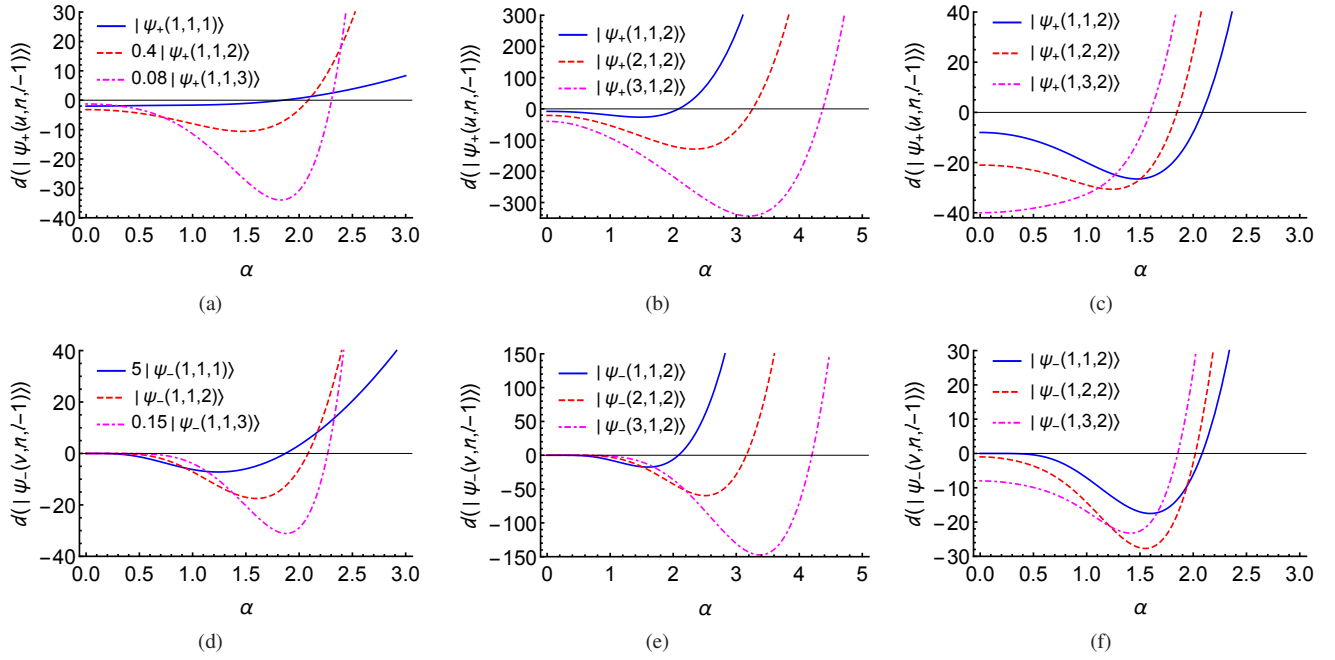

Figure 3: (Color online) The presence of higher-order antibunching is shown as a function of α for PADS (in (a)-(c)) and PSDFS ((d)-(f)). Specifically, (a) and (d) illustrate comparison between lower- and higher-order antibunching. It should be noted that some of the curves are multiplied by a scaling factor in order to present them in one figure. Figures (b) and (e) show the effect of photon addition/subtraction, and (c) and (f) establish the effect of Fock state chosen to displace in PADS and PSDFS, respectively.

Eqs. (6) and (7) in Eq. (9). Specifically, the depth of nonclassicality witness can be observed to increase with order for both PADS and PSDFS as depicted in Fig. 3 (a) and (d). This fact is consistent with the earlier observations ([51, 52, 54, 57, 74] and references therein) that higher-order nonclassicality criteria are useful in detecting weaker nonclassicality. On top of that the higher-order antibunching can be observed for larger values of displacement parameter α , when lower-order antibunching is not present. The presence of higher-order nonclassicality in the absence of its lower-order counterpart establishes the relevance of the present study.

The depth of nonclassicality parameter was observed to decrease with an increase in the number of photons subtracted from DFS for small values of α in Fig. 2 (c). A similar nature is observed in Fig. 3 (e), which shows that for the higher values of displacement parameter, the depth of higher-order nonclassicality witness increases with the number of photon subtraction. Therefore, not only the depth of nonclassicality but the range of displacement parameter for the presence of higher-order antibunching also increases with photon addition/subtraction (cf. Fig. 3 (b) and (e)). With the increase in the value of Fock state parameter n , the depth of higher-order nonclassicality witness increases (decreases) for smaller (larger) values of displacement parameter in both PADS and PSDFS as shown in Fig. 3 (c) and (f), respectively. Thus, we have observed that the range of α with the presence of nonclassicality increases (decreases) with photon addition/subtraction (Fock state) in DFS.

3.3 Higher-order sub-Poissonian photon statistics

The lower-order counterparts of antibunching and sub-Poissonian photon statistics are closely associated as the presence of latter ensures the possibility of observing former (see [51, 54] for a detailed discussion). However, these two nonclassical features were shown to be independent phenomena in the past ([51, 54] and references therein). Higher-order counterpart of sub-Poissonian photon statistics can be introduced as

$$\mathcal{D}_h(l-1) = \sum_{e=0}^l \sum_{f=1}^e S_2(e, f) {}^l C_e (-1)^e d(f-1) \langle N \rangle^{l-e} < 0, \quad (10)$$

where $S_2(e, f)$ is the Stirling number of second kind, and ${}^l C_e$ is the usual binomial coefficient. This allows us to study higher-order sub-Poissonian photon statistics using Eqs. (6) and (7) in Eq. (10).

The presence of higher-order sub-Poissonian photon statistics (as can be seen in Fig. 4 (a) and (d) for PADS and PSDFS, respectively) is dependent on the order of nonclassicality unlike higher-order antibunching, which is observed for all

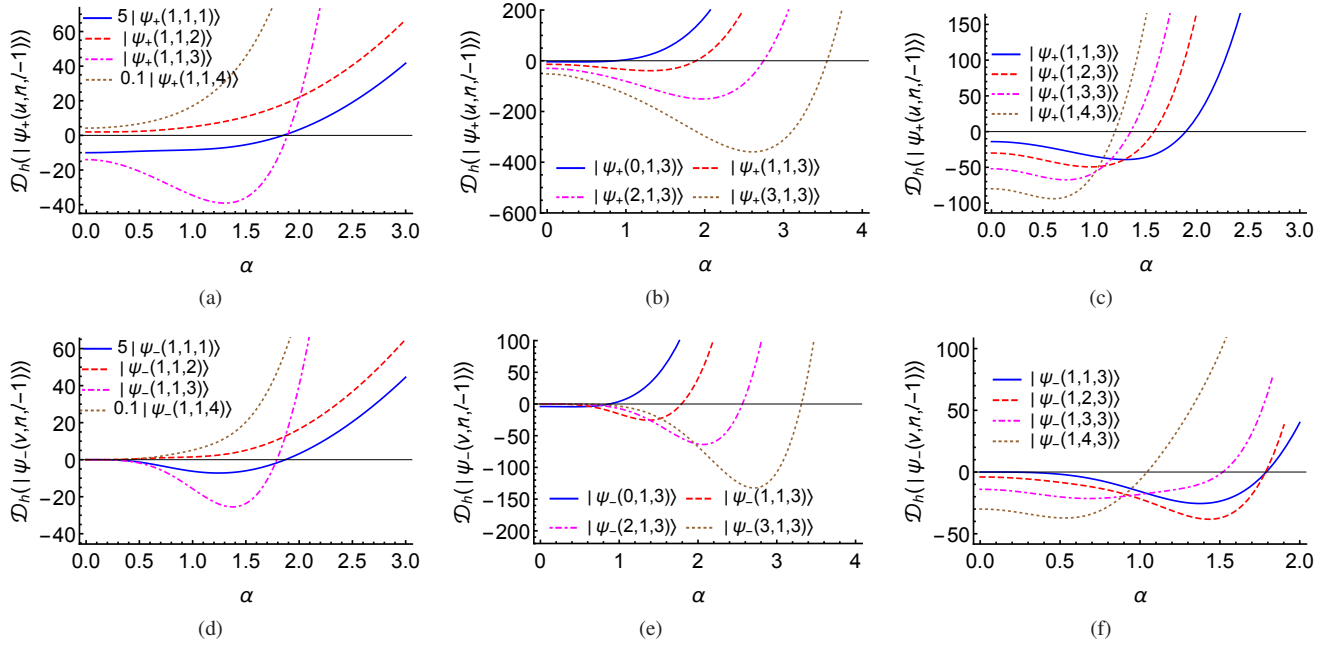

Figure 4: (Color online) Dependence of higher-order sub-Poissonian photon statistics on α for PADFS (in (a)-(c)) and PSDFS (d)-(f) is illustrated here. Specifically, (a) and (d) show the increase in depth of nonclassicality witness with order, (b) and (e) depict the effect of photon addition and subtraction, respectively, and (c) and (f) establish the effect of choice of Fock state to be displaced in PADFS and PSDFS, respectively.

orders. Specifically, the nonclassical feature was observed only for odd orders, which is consistent with some of our earlier observations [54], where nonclassicality in those cases could be induced due to squeezing. Along the same line, we expect to observe the nonclassicality in such cases with appropriate use of squeezing as a useful quantum resource, which will be discussed elsewhere. In case of photon addition/subtraction in DFS, a behavior analogous to that observed for higher-order antibunching is observed, i.e., the depth of nonclassicality increases with the photon addition while it decreases (increases) for small (large) values of α (cf. Fig. 4 (b) and (e)). Similar to the previous case, nonclassicality can be observed to be present for larger values of displacement parameter with photon addition/subtraction, while increase in the value of Fock parameter has an opposite effect.

3.4 Higher-order squeezing

The squeezing of quadrature is defined in terms of variance in the measured values of the quadrature (say, position or momentum) below the corresponding value for the coherent state, i.e., minimum uncertainty state. The higher-order counterpart of squeezing is studied in two ways, namely Hong-Mandel and Hillery type squeezing [75–77]. Specifically, the idea of the higher-order squeezing originated from the pioneering work of Hong and Mandel [75, 76], who generalized the lower-order squeezing using the higher-order moment. According to the Hong-Mandel criterion, the l th order squeezing can be observed if the l th moment (for $l > 2$) of a field quadrature operator is less than the corresponding coherent state value. The condition of Hong-Mandel type higher-order squeezing is given as follows [75, 76]

$$S(l) = \frac{\langle (\Delta X)^l \rangle - \left(\frac{1}{2}\right)^{\frac{l}{2}}}{\left(\frac{1}{2}\right)^{\frac{l}{2}}} < 0, \quad (11)$$

where $(x)_l$ is conventional Pochhammer symbol. The inequality in Eq. (11) can also be rewritten as

$$\langle (\Delta X)^l \rangle < \left(\frac{1}{2}\right)^{\frac{l}{2}} = \frac{1}{2^{\frac{l}{2}}}(l-1)!! \quad (12)$$

with

$$\langle (\Delta X)^l \rangle = \sum_{r=0}^l \sum_{i=0}^{\frac{r}{2}} \sum_{k=0}^{r-2i} (-1)^r \frac{1}{2^{\frac{l}{2}}} (2i-1)!^{2i} C_k^l C_r^r C_{2i} \langle \hat{a}^\dagger + \hat{a} \rangle^{l-r} \langle \hat{a}^{\dagger k} \hat{a}^{r-2i-k} \rangle, \quad (13)$$

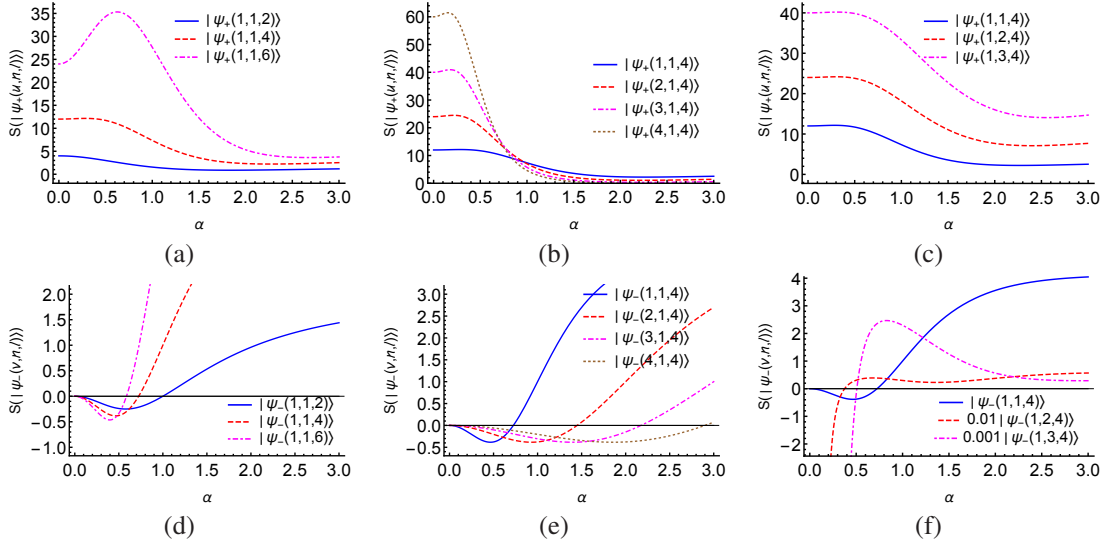

Figure 5: Illustration of the higher-order squeezing using Hong-Mandel criterion as the function of displacement parameter. In (a) and (d), dependence of the observed nonclassicality on different orders (l) is shown for PADFS and PSDFS, respectively; while in (b) and (e), the effect of variation in the number of photon added/subtracted is shown in case of PADFS and PSDFS, respectively. In (c) and (f), the variation due to change in the initial Fock state chosen to be displaced is shown for PADFS and PSDFS, respectively.

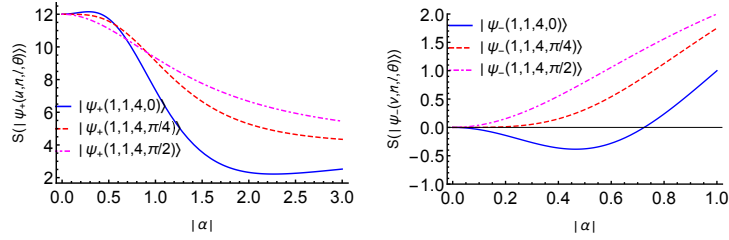

Figure 6: Hong-Mandel type higher-order squeezing for PADFS and PSDFS is shown dependent on the phase of the displacement parameter $\alpha = |\alpha| \exp(i\theta)$ in (a) and (b), respectively.

where l is an even number, and the quadrature variable is defined as $X = \frac{1}{\sqrt{2}}(a + a^\dagger)$. The analytical expressions of the nonclassicality witness of the Hong-Mandel type higher-order squeezing criterion for PADFS and PSDFS can be obtained with the help of Eqs. (6), (7), and (11)-(13). We investigate the higher-order squeezing and depict the result in Fig. 5 assuming α to be real. Incidentally, we could not establish the presence of higher-order squeezing phenomena in PADFS state Fig. 5 (a)-(c). However, the depth of the higher-order squeezing witness increases with order for small values of α as shown in Fig. 5 (a), while for the higher values of the displacement parameter, higher-order squeezing disappear much quicker (cf. Fig. 5 (d)). With increase in the number of photons subtracted, the presence of this nonclassicality feature can be maintained for the higher values of displacement parameter as well (cf. Fig. 5 (e)). In general, photon subtraction is a preferred mode for nonclassicality enhancement as far as this nonclassicality feature is concerned. The choice of the initial Fock state is also observed to be relevant as the depth of squeezing parameter can be seen increasing with value of the Fock parameter for PSDFS in the small displacement parameter region (shown in Fig. 5 (f)), where this nonclassical behavior is also shown to succumb to the higher values of Fock and displacement parameters. Unlike the other nonclassicalities discussed so far, the observed squeezing also depends on phase θ of the displacement parameter $\alpha = |\alpha| \exp(i\theta)$ due to the second last term in Eq. (13). We failed to observe this nonclassicality behavior in PADFS even by controlling the value of the phase parameter (also shown in Fig. 6 (a)). For PSDFS, the squeezing disappears for some particular values of the phase parameter, while the observed squeezing is maximum for $\theta = n\pi$ (see Fig. 6 (b)). It thus establishes the phase parameter of the displacement operator as one more controlling factor for nonclassicality in these engineered quantum states.

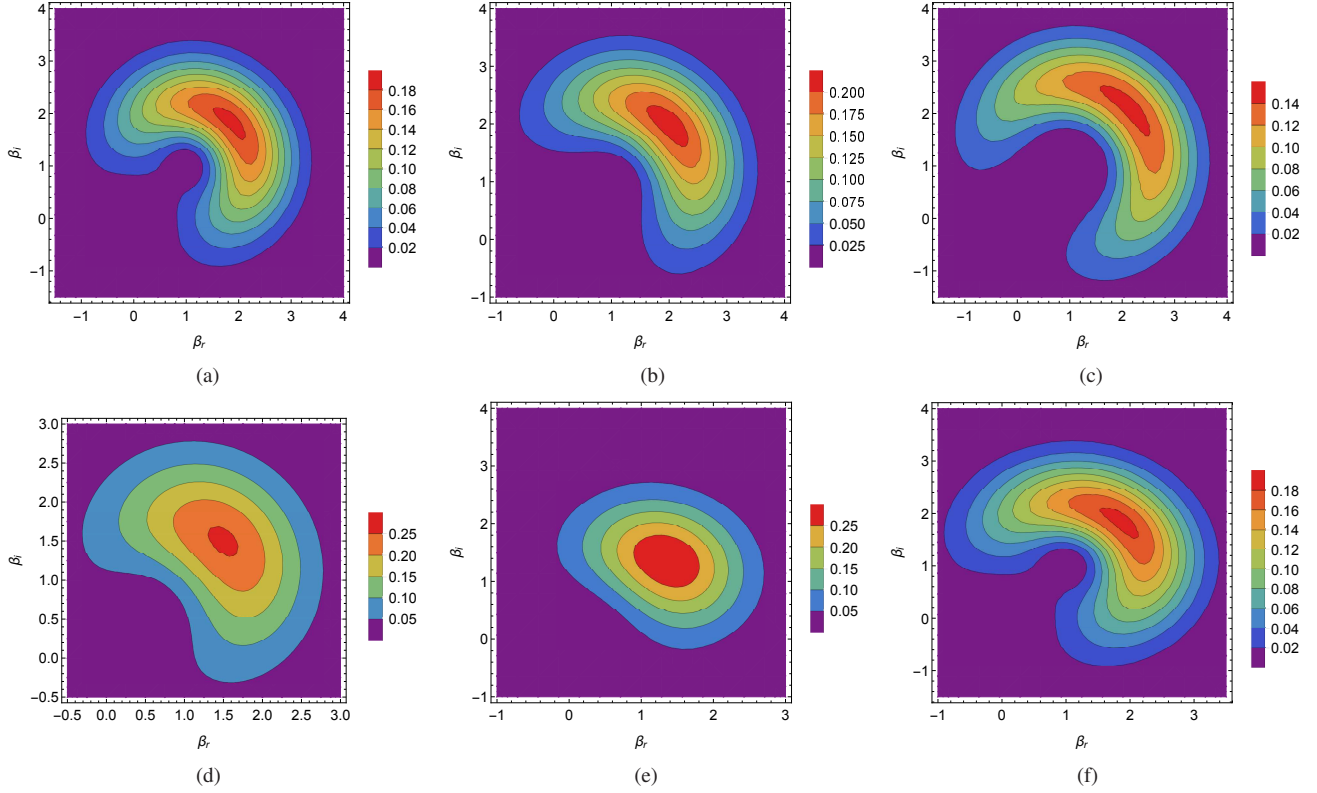

Figure 7: (Color online) Contour plots of the Q function for (a) single photon added displaced Fock $|1\rangle$ state, (b) two photon added displaced Fock $|1\rangle$ state, (c) single photon added displaced Fock $|2\rangle$ state, (d) single photon subtracted displaced Fock $|1\rangle$ state, (e) two photon subtracted displaced Fock $|1\rangle$ state, (f) single photon subtracted displaced Fock $|2\rangle$ state. In all cases, $\alpha = \sqrt{2} \exp\left(\frac{i\pi}{4}\right)$ is chosen.

3.5 Q function

Inability to give a phase space description of quantum mechanics is exploited in terms of quasiprobability distributions ([34] and references therein) to use them as witnesses of nonclassicality. These real and normalized quasiprobability distributions allow to calculate the expectation value of an operator as any classical probability distribution. One such quasiprobability distributions is Q function [78], and zeros of this function are signature of nonclassicality. Q function [78] is defined as

$$Q = \frac{1}{\pi} \langle \beta | \rho | \beta \rangle, \quad (14)$$

where $|\beta\rangle$ is the coherent state. Using Eqs. (2) and (3) in (14), we obtain the analytic expressions for the Husimi Q function for PADFS and PSDFS as

$$Q_+ = \frac{N_+^2 \exp[-|\beta|^2]}{\pi n!} \sum_{p,p'=0}^n \binom{n}{p} \binom{n}{p'} (-\alpha^*)^{(n-p)} (-\alpha)^{(n-p')} \exp[-|\alpha|^2] \sum_{m,m'=0}^{\infty} \frac{\alpha^m (\alpha^*)^{m'} \beta^{(m'+p'+u)} (\beta^*)^{(m+p+u)}}{m! m'!} \quad (15)$$

and

$$Q_- = \frac{N_-^2 \exp[-|\beta|^2]}{\pi n!} \sum_{p,p'=0}^n \binom{n}{p} \binom{n}{p'} (-\alpha^*)^{(n-p)} (-\alpha)^{(n-p')} \exp[-|\alpha|^2] \times \sum_{m,m'=0}^{\infty} \frac{\alpha^m (\alpha^*)^{m'} \beta^{(m'+p'-v)} (\beta^*)^{(m+p-v)} (m+p)! (m'+p')!}{m! m'! (m+p-v)! (m'+p'-v)!}, \quad (16)$$

respectively. We failed to observe the nonclassical features reflected beyond moments based nonclassicality criteria through a quasiprobability distribution, i.e., zeros of the Q function. We have shown the Q function in Fig. 7, where the effect of photon addition/subtraction and the value of Fock parameter on the phase space distribution is shown. Specifically, it is observed that the value of Fock parameter affects the quasidistribution function more compared to the photon addition/subtraction.

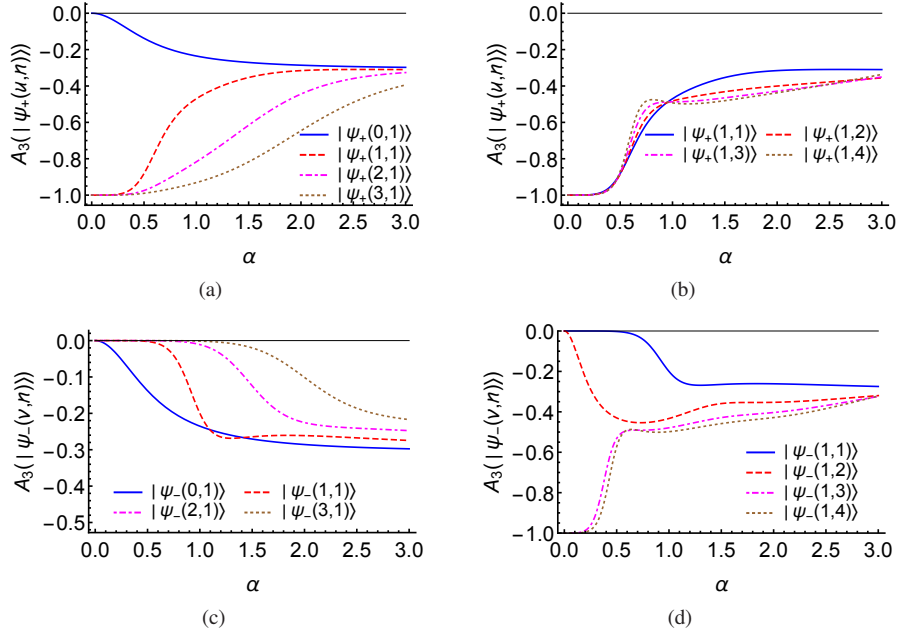

Figure 8: (Color online) Variation of Agarwal-Tara parameter with α for PADFS and PSDFS is shown in (a)-(b) and (c)-(d), respectively. Specifically, the effect of photon addition/subtraction (in (a) and (c)) and the choice of Fock state ((b) and (d)) on the presence of nonclassicality in PADFS and PSDFS is illustrated.

3.6 Agarwal-Tara criterion

We will further discuss one more moments based criteria of nonclassicality. This particular criterion was introduced by Agarwal and Tara [79], and it can be written in a matrix form. The criterion is defined as

$$A_3 = \frac{\det m^{(3)}}{\det \mu^{(3)} - \det m^{(3)}} < 0, \quad (17)$$

where

$$m^{(3)} = \begin{bmatrix} 1 & m_1 & m_2 \\ m_1 & m_2 & m_3 \\ m_2 & m_3 & m_4 \end{bmatrix}$$

and

$$\mu^{(3)} = \begin{bmatrix} 1 & \mu_1 & \mu_2 \\ \mu_1 & \mu_2 & \mu_3 \\ \mu_2 & \mu_3 & \mu_4 \end{bmatrix}.$$

The matrix elements are defined as $m_i = \langle \hat{a}^{\dagger i} \hat{a}^i \rangle$ and $\mu_j = (\langle \hat{a}^{\dagger} \hat{a} \rangle)^j = (m_1)^j$.

The analytic expression of A_3 parameter defined in Eq. (17) can be obtained for PADFS and PSDFS using Eqs. (6) and (7). The nonclassical properties of the PADFS and PSDFS using Agarwal-Tara criterion are investigated, and the corresponding results are depicted in Fig. 8, which shows highly nonclassical behavior of the states generated by engineering. Specifically, the negative part of the curves, which is bounded by -1, ensures the existence of the nonclassicality. From Fig. 8, it is clear that A_3 is 0 (-1) for the displacement parameter $\alpha = 0$ because then DFS, PADFS, and PSDFS reduce to Fock state, and $A_3 = 0$ (-1) for the Fock state parameter $n = 0, 1$ ($n > 1$). Nonclassicality reflected through A_3 parameter increases (decreases) with photon addition (subtraction) (shown in Fig. 8 (a) and (c)). In contrast, the Fock parameter has a completely opposite effect that it leads to decrease (increase) in the observed nonclassicality for PADFS (PSDFS), which can be seen in Fig. 8 (b) and (d). However, for larger values of displacement parameter, the depth of nonclassicality illustrated through this parameter can again be seen to increase (cf. Fig. 8 (b)).

3.7 Klyshko's Criterion

Klyshko introduced a criterion [80] to investigate the nonclassical property using only three successive photon-number probabilities. In terms of the photon-number probability $p_m = \langle m | \rho | m \rangle$ of the state with density matrix ρ , the Klyshko's criterion

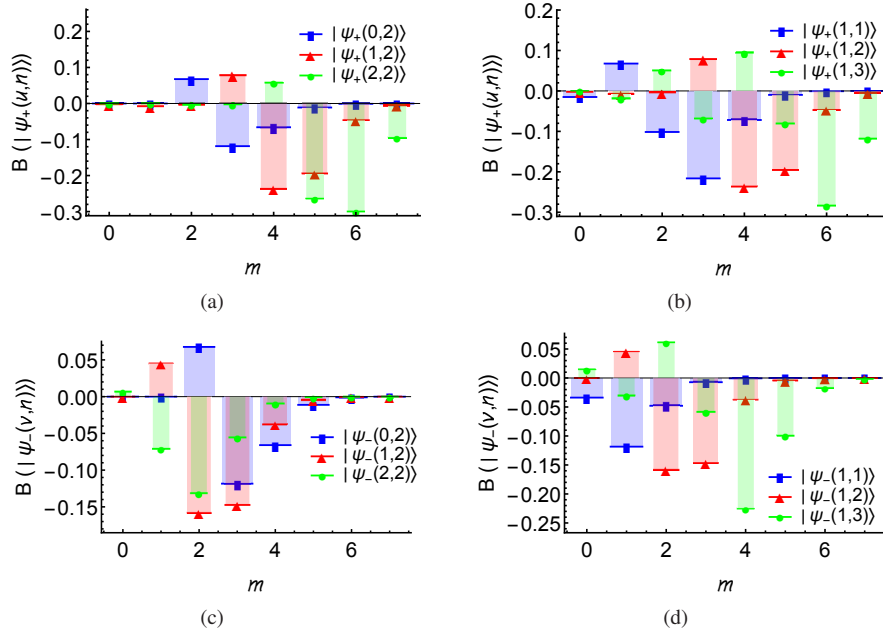

Figure 9: (Color online) Illustration of the Klyshko's criterion. Variation of $B(m)$ with respect to m (a) and (c) for different values of the number of the photon addition/subtraction for PADS and PSDFS, respectively; (b) and (d) for different values of the number of the Fock state parameter for PADS and PSDFS, respectively. Here, we have chosen $\alpha = 1$ in all cases.

in the form of an inequality can be written as

$$B(m) = (m + 2)p_m p_{m+2} - (m + 1)(p_{m+1})^2 < 0. \quad (18)$$

The analytic expression for the m th photon-number distribution for PADS and PSDFS can be calculated (using $q = r = 1$) from Eqs. (6) and (7), respectively.

The advantage of the Klyshko's criterion over any other existing moments based criteria is that a very small amount of information is required. Specifically, probability of only three successive photon numbers is sufficient to investigate the nonclassical property. The negative values of $B(m)$ serve as the witness of nonclassicality. Klyshko's criterion in Eq. (18) is derived analytically and the corresponding nonclassical properties for both PADS and PSDFS are investigated (cf. Fig. 9). Specifically, the negative values of $B(m)$ are observed for different values of m in case of photon addition and subtraction (cf. Fig. 9 (a) and (c)) being the signature of nonclassicality induced via independent operations. Additionally, one can also visualize that due to the photon addition (subtraction) the negative peaks in the values of $B(m)$ shift to higher (lower) photon number regime. A similar observation is obtained for different values of the Fock state parameter for the PADS and PSDFS, where the negative values of the witness of nonclassicality get amplified towards higher photon number regime and becomes more negative, and the corresponding results are shown in Fig. 9 (b) and (d), respectively. This further establishes the relevance of operations, like photon addition, subtraction, and starting with Fock states in inducing nonclassicality in the engineered quantum states.

4 Conclusions

The only Fock state that does not show any nonclassical feature is the vacuum state [81], and displacement operator preserves its classicality. All the rest of the Fock states are maximally nonclassical and they are shown to remain nonclassical even after application of a displacement operator. Here, we set ourselves a task: What happens when the displacement operator applied on a Fock state is followed by addition or subtraction of photon(s)? Independently, photon addition and subtraction are already established as nonclassicality inducing operations in case of displaced vacuum state (i.e., coherent state). We have established that photon addition/subtraction is not only nonclassicality inducing operation, it can also enhance the nonclassicality present in the DFS. It's expected that these operations would increase the amount of nonclassicality (more precisely, the depth of the nonclassicality witnessing parameter) present in other nonclassical states, too. There is one more advantage of studying the nonclassical features of PADS and PSDFS. These states can be reduced to a class of quantum states, most of which are already experimentally realized and found useful in several applications. Inspired from the available experimental results, we have also proposed optical designs for generation of PADS and PSDFS from squeezed vacuum state.

To analyze the nonclassical features of the engineered final states, i.e., PADFS and PSDFS, we have used a set of moments based criteria, namely Mandel Q_M parameter, Agarwal-Tara A_3 parameter, criteria for higher-order antibunching, sub-Poissonian photon statistics, and squeezing. In addition, the nonclassical features have been investigated through Klyshko's criterion and a quasiprobability distribution- Q function. The states of interest are found to show a large variety of nonclassical features as all the nonclassicality witnesses used here (except Q function) are found to detect the nonclassicality.

This study has revealed that the amount of nonclassicality in PADFS and PSDFS states can be controlled by the Fock state parameter, displacement parameter, the number of photons added or subtracted. In general, the amount of nonclassicality with respect to the witness used here is found to increase with the number of photons added/subtracted, while smaller values of Fock state and displacement parameters are observed to be preferable for the presence of various nonclassical features. On some occasions, nonclassicality has also been observed to increase with the Fock state parameter, while larger values of displacement parameter always affect the nonclassicality adversely. Most of the nonclassicality criteria used here, being moments-based criteria, could not demonstrate the effect of phase parameter of the displacement parameter. Here, higher-order squeezing witness and Q function are found dependent on the phase of the displacement parameter. However, only higher-order squeezing criterion was able to detect nonclassicality, and thus established that this phase parameter can also be used to control the amount of nonclassicality.

Further, in the past, it has been established that higher-order nonclassicality criteria have an advantage in detecting weaker nonclassicality. We have also shown that the depth of nonclassicality witness increases with order of nonclassicality thus providing an advantage in the experimental characterization of the observed nonclassical behavior. Finally, we feel that this study can be extended to investigate the non-Gaussianity of the studied state and hope that the observed nonclassicality in these states would find applications in quantum information processing tasks.

Acknowledgment: A.P. and N.A. thank the Department of Science and Technology (DST), India, for support provided through the DST project No. EMR/2015/000393. S.B and V. N. thank CSIR, New Delhi for support through the project No. 03(1369)/16/EMR-II.

References

- [1] K. Vogel, V. Akulin, W. Schleich, Quantum state engineering of the radiation field, *Physical Review Letters* 71 (12) (1993) 1816.
- [2] J. Sperling, W. Vogel, G. Agarwal, Quantum state engineering by click counting, *Physical Review A* 89 (4) (2014) 043829.
- [3] A. Miranowicz, W. Leoński, Dissipation in systems of linear and nonlinear quantum scissors, *Journal of Optics B: Quantum and Semiclassical Optics* 6 (3) (2004) S43.
- [4] M. A. Marchioli, W. D. José, Engineering superpositions of displaced number states of a trapped ion, *Physica A: Statistical Mechanics and its Applications* 337 (1-2) (2004) 89–108.
- [5] A. Pathak, *Elements of Quantum Computation and Quantum Communication*, Taylor & Francis, 2013.
- [6] G. Agarwal, K. Tara, Nonclassical properties of states generated by the excitations on a coherent state, *Physical Review A* 43 (1) (1991) 492.
- [7] S.-Y. Lee, H. Nha, Quantum state engineering by a coherent superposition of photon subtraction and addition, *Physical Review A* 82 (5) (2010) 053812.
- [8] B. Escher, A. Avelar, T. da Rocha Filho, B. Baseia, Controlled hole burning in the fock space via conditional measurements on beam splitters, *Physical Review A* 70 (2) (2004) 025801.
- [9] A. Pathak, A. Ghatak, Classical light vs. nonclassical light: characterizations and interesting applications, *Journal of Electromagnetic Waves and Applications* 32 (2) (2018) 229–264.
- [10] A. Zavatta, S. Viciani, M. Bellini, Quantum-to-classical transition with single-photon-added coherent states of light, *science* 306 (5696) (2004) 660–662.
- [11] S. A. Podoshvedov, Extraction of displaced number states, *JOSA B* 31 (10) (2014) 2491–2503.
- [12] S. Banerjee, R. Srikanth, Phase diffusion in quantum dissipative systems, *Physical Review A* 76 (6) (2007) 062109.
- [13] S. Banerjee, J. Ghosh, R. Ghosh, Phase-diffusion pattern in quantum-nondemolition systems, *Physical Review A* 75 (6) (2007) 062106.

- [14] M. R. Abbasi, M. M. Golshan, Thermal entanglement of a two-level atom and bimodal photons in a Kerr nonlinear coupler, *Physica A: Statistical Mechanics and its Applications* 392 (23) (2013) 6161–6167.
- [15] B. P. Abbott, R. Abbott, T. D. Abbott, M. R. Abernathy, F. Acernese, K. Ackley, C. Adams, T. Adams, P. Addesso, R. X. Adhikari, et al., Gw151226: observation of gravitational waves from a 22-solar-mass binary black hole coalescence, *Physical Review Letters* 116 (24) (2016) 241103.
- [16] B. P. Abbott, R. Abbott, T. D. Abbott, M. R. Abernathy, F. Acernese, K. Ackley, C. Adams, T. Adams, P. Addesso, R. Adhikari, et al., Observation of gravitational waves from a binary black hole merger, *Physical Review Letters* 116 (6) (2016) 061102.
- [17] A. Furusawa, J. L. Sørensen, S. L. Braunstein, C. A. Fuchs, H. J. Kimble, E. S. Polzik, Unconditional quantum teleportation, *Science* 282 (5389) (1998) 706–709.
- [18] M. Hillery, Quantum cryptography with squeezed states, *Physical Review A* 61 (2) (2000) 022309.
- [19] Z. Yuan, B. E. Kardynal, R. M. Stevenson, A. J. Shields, C. J. Lobo, K. Cooper, N. S. Beattie, D. A. Ritchie, M. Pepper, Electrically driven single-photon source, *Science* 295 (5552) (2002) 102–105.
- [20] I. Chakrabarty, S. Banerjee, N. Siddharth, A study of quantum correlations in open quantum systems, *Quant. Info and Comp* 11 (2011) 541.
- [21] H. S. Dhar, S. Banerjee, A. Chatterjee, R. Ghosh, Controllable quantum correlations of two-photon states generated using classically driven three-level atoms, *Annals of Physics* 331 (2013) 97–109.
- [22] S. Banerjee, V. Ravishankar, R. Srikanth, Dynamics of entanglement in two-qubit open system interacting with a squeezed thermal bath via dissipative interaction, *Annals of Physics* 325 (4) (2010) 816–834.
- [23] S. Banerjee, V. Ravishankar, R. Srikanth, Entanglement dynamics in two-qubit open system interacting with a squeezed thermal bath via quantum nondemolition interaction, *The European Physical Journal D-Atomic, Molecular, Optical and Plasma Physics* 56 (2) (2010) 277–290.
- [24] A. K. Ekert, Quantum cryptography based on Bell’s theorem, *Physical Review Letters* 67 (6) (1991) 661.
- [25] C. H. Bennett, S. J. Wiesner, Communication via one-and two-particle operators on Einstein-Podolsky-Rosen states, *Physical Review Letters* 69 (20) (1992) 2881.
- [26] C. H. Bennett, G. Brassard, C. Crépeau, R. Jozsa, A. Peres, W. K. Wootters, Teleporting an unknown quantum state via dual classical and Einstein-Podolsky-Rosen channels, *Physical Review Letters* 70 (13) (1993) 1895.
- [27] C. Branciard, E. G. Cavalcanti, S. P. Walborn, V. Scarani, H. M. Wiseman, One-sided device-independent quantum key distribution: security, feasibility, and the connection with steering, *Physical Review A* 85 (1) (2012) 010301.
- [28] L. K. Grover, Quantum mechanics helps in searching for a needle in a haystack, *Physical Review Letters* 79 (2) (1997) 325.
- [29] P. W. Shor, Polynomial-time algorithms for prime factorization and discrete logarithms on a quantum computer, *SIAM (Society for Industrial and Applied Mathematics) Review* 41 (2) (1999) 303–332.
- [30] J. Biamonte, P. Wittek, N. Pancotti, P. Rebentrost, N. Wiebe, S. Lloyd, Quantum machine learning, *Nature* 549 (2017) 195–202.
- [31] N. Alam, A. Verma, A. Pathak, Higher-order nonclassicalities of finite dimensional coherent states: A comparative study, *Physics Letters A* 382 (28) (2018) 1842–1851.
- [32] M. V. Satyanarayana, Generalized coherent states and generalized squeezed coherent states, *Physical Review D* 32 (2) (1985) 400.
- [33] K. Thapliyal, S. Banerjee, A. Pathak, Tomograms for open quantum systems: in (finite) dimensional optical and spin systems, *Annals of Physics* 366 (2016) 148–167.
- [34] K. Thapliyal, S. Banerjee, A. Pathak, S. Omkar, V. Ravishankar, Quasiprobability distributions in open quantum systems: spin-qubit systems, *Annals of Physics* 362 (2015) 261–286.

- [35] R. Keil, A. Perez-Leija, F. Dreisow, M. Heinrich, H. Moya-Cessa, S. Nolte, D. N. Christodoulides, A. Szameit, Classical analogue of displaced fock states and quantum correlations in glauber-fock photonic lattices, *Physical Review Letters* 107 (10) (2011) 103601.
- [36] A. Wunsche, Displaced fock states and their connection to quasiprobabilities, *Quantum Optics: Journal of the European Optical Society Part B* 3 (6) (1991) 359.
- [37] M. Blažek, High energy hadronic multiplicity distributions in presence of noisy squeezing and noisy displaced fock states, *Czechoslovak Journal of Physics* 44 (9) (1994) 809–826.
- [38] H. Moya-Cessa, Generation and properties of superpositions of displaced fock states, *Journal of Modern Optics* 42 (8) (1995) 1741–1754.
- [39] F. Ziesel, T. Ruster, A. Walther, H. Kaufmann, S. Dawkins, K. Singer, F. Schmidt-Kaler, U. Poschinger, Experimental creation and analysis of displaced number states, *Journal of Physics B: Atomic, Molecular and Optical Physics* 46 (10) (2013) 104008.
- [40] G. C. De Oliveira, A. L. Do Vale, C. M. Dantas, Nonlinear even and odd displaced number state, *Modern Physics Letters B* 20 (18) (2006) 1135–1146.
- [41] V. Dodonov, L. De Souza, Decoherence of superpositions of displaced number states, *Journal of Optics B: Quantum and Semiclassical Optics* 7 (12) (2005) S490.
- [42] P. Alsing, D.-S. Guo, H. Carmichael, Dynamic stark effect for the jaynes-cummings system, *Physical Review A* 45 (7) (1992) 5135.
- [43] H. Zheng-Feng, Fluctuation of phase in the displaced number states, *Journal of Modern Optics* 39 (6) (1992) 1381–1397.
- [44] F. De Oliveira, M. Kim, P. L. Knight, V. Buek, Properties of displaced number states, *Physical Review A* 41 (5) (1990) 2645.
- [45] I. Mendas, D. Popovic, Pancharatnam phase for displaced number states, *Journal of Physics A: Mathematical and General* 26 (13) (1993) 3313.
- [46] C. Lo, Generating displaced and squeezed number states by a general driven time-dependent oscillator, *Physical Review A* 43 (1) (1991) 404.
- [47] M. Hillery, V. Bužek, A. Berthiaume, Quantum secret sharing, *Physical Review A* 59 (3) (1999) 1829.
- [48] A. Banerjee, K. Thapliyal, C. Shukla, A. Pathak, Quantum conference, *Quantum Information Processing* 17 (2018) 161.
- [49] R. D. Sharma, K. Thapliyal, A. Pathak, Quantum sealed-bid auction using a modified scheme for multiparty circular quantum key agreement, *Quantum Information Processing* 16 (7) (2017) 169.
- [50] K. Thapliyal, R. D. Sharma, A. Pathak, Protocols for quantum binary voting, *International Journal of Quantum Information* 15 (2017) 1750007.
- [51] K. Thapliyal, A. Pathak, B. Sen, J. Peřina, Higher-order nonclassicalities in a codirectional nonlinear optical coupler: quantum entanglement, squeezing, and antibunching, *Physical Review A* 90 (1) (2014) 013808.
- [52] K. Thapliyal, A. Pathak, B. Sen, J. Peřina, Nonclassical properties of a contradirectional nonlinear optical coupler, *Physics Letters A* 378 (46) (2014) 3431–3440.
- [53] A. Verma, A. Pathak, Generalized structure of higher order nonclassicality, *Physics Letters A* 374 (8) (2010) 1009–1020.
- [54] K. Thapliyal, N. L. Samantray, J. Banerji, A. Pathak, Comparison of lower- and higher-order nonclassicality in photon added and subtracted squeezed coherent states, *Physics Letters A* 381 (37) (2017) 3178 – 3187.
- [55] N. Alam, S. Mandal, Nonclassical properties of coherent light in a pair of coupled anharmonic oscillators, *Optics Communications* 359 (2016) 221–233.
- [56] N. Alam, S. Mandal, P. Öhberg, Approximate analytical solutions of a pair of coupled anharmonic oscillators, *Journal of Physics B: Atomic, Molecular and Optical Physics* 48 (4) (2015) 045503.

- [57] K. Thapliyal, A. Pathak, B. Sen, J. Perina, Nonclassicality in non-degenerate hyper-Raman processes, arXiv preprint arXiv:1710.04456.
- [58] H. Prakash, D. K. Mishra, Higher order sub-Poissonian photon statistics and their use in detection of Hong and Mandel squeezing and amplitude-squared squeezing, *Journal of Physics B: Atomic, Molecular and Optical Physics* 39 (9) (2006) 2291.
- [59] H. Prakash, P. Kumar, D. K. Mishra, Detection of amplitude-squared squeezing via homodyne method, *International Journal of Modern Physics B* 24 (28) (2010) 5547–5551.
- [60] A. Allevi, S. Olivares, M. Bondani, Measuring high-order photon-number correlations in experiments with multimode pulsed quantum states, *Physical Review A* 85 (6) (2012) 063835.
- [61] A. Allevi, S. Olivares, M. Bondani, High-order photon-number correlations: a resource for characterization and applications of quantum states, *International Journal of Quantum Information* 10 (08) (2012) 1241003.
- [62] M. Avenhaus, K. Laiho, M. V. Chekhova, C. Silberhorn, Accessing higher order correlations in quantum optical states by time multiplexing, *Physical Review Letters* 104 (6) (2010) 063602.
- [63] J. Peřina Jr, V. Michálek, O. Haderka, Higher-order sub-Poissonian-like nonclassical fields: Theoretical and experimental comparison, *Physical Review A* 96 (3) (2017) 033852.
- [64] A. Verma, N. K. Sharma, A. Pathak, Higher order antibunching in intermediate states, *Physics Letters A* 372 (34) (2008) 5542–5551.
- [65] A. Zavatta, S. Viciani, M. Bellini, Single-photon excitation of a coherent state: catching the elementary step of stimulated light emission, *Physical Review A* 72 (2) (2005) 023820.
- [66] A. Lvovsky, S. Babichev, Synthesis and tomographic characterization of the displaced Fock state of light, *Physical Review A* 66 (1) (2002) 011801.
- [67] G. C. de Oliveira, A. R. de Almeida, I. P. de Queirós, A. M. Moraes, C. M. Dantas, Alternative proposal for the generation of the displaced number state, *Physica A: Statistical Mechanics and its Applications* 351 (2-4) (2005) 251–259.
- [68] A. Miranowicz, M. Bartkowiak, X. Wang, Y.-x. Liu, F. Nori, Testing nonclassicality in multimode fields: a unified derivation of classical inequalities, *Physical Review A* 82 (1) (2010) 013824.
- [69] J. Naikoo, K. Thapliyal, A. Pathak, S. Banerjee, Probing nonclassicality in an optically driven cavity with two atomic ensembles, *Physical Review A* 97 (6) (2018) 063840.
- [70] T. Richter, W. Vogel, Nonclassicality of quantum states: a hierarchy of observable conditions, *Physical Review Letters* 89 (28) (2002) 283601.
- [71] E. V. Shchukin, W. Vogel, Nonclassical moments and their measurement, *Physical Review A* 72 (4) (2005) 043808.
- [72] L. Mandel, Sub-Poissonian photon statistics in resonance fluorescence, *Optics Letters* 4 (7) (1979) 205–207.
- [73] A. Pathak, M. E. Garcia, Control of higher order antibunching, *Applied Physics B* 84 (3) (2006) 479–484.
- [74] N. Alam, K. Thapliyal, A. Pathak, B. Sen, A. Verma, S. Mandal, Lower- and higher-order nonclassicality in a Bose-condensed optomechanical-like system and a Fabry-Perot cavity with one movable mirror: squeezing, antibunching and entanglement, arXiv preprint arXiv:1708.03967.
- [75] C. K. Hong, L. Mandel, Higher-order squeezing of a quantum field, *Physical Review Letters* 54 (4) (1985) 323.
- [76] C. K. Hong, L. Mandel, Generation of higher-order squeezing of quantum electromagnetic fields, *Physical Review A* 32 (2) (1985) 974.
- [77] M. Hillery, Amplitude-squared squeezing of the electromagnetic field, *Physical Review A* 36 (8) (1987) 3796.
- [78] K. Husimi, Some formal properties of the density matrix, *Proceedings of the Physico-Mathematical Society of Japan [Nippon Sugaku-Buturiggakkwai Kizi Dai 3 Ki]* 22 (4) (1940) 264–314.
- [79] G. S. Agarwal, K. Tara, Nonclassical character of states exhibiting no squeezing or sub-Poissonian statistics, *Physical Review A* 46 (1) (1992) 485.

- [80] D. N. Klyshko, Observable signs of nonclassical light, *Physics Letters A* 213 (1-2) (1996) 7–15.
- [81] A. Miranowicz, K. Bartkiewicz, A. Pathak, J. Peřina Jr., Y.-N. Chen, F. Nori, Statistical mixtures of states can be more quantum than their superpositions: comparison of nonclassicality measures for single-qubit states, *Physical Review A* 91 (4) (2015) 042309.