

STRINGY E -FUNCTIONS OF CANONICAL TORIC FANO THREEFOLDS AND THEIR APPLICATIONS

VICTOR BATYREV AND KARIN SCHALLER

ABSTRACT. Let Δ be a 3-dimensional lattice polytope containing exactly one interior lattice point. We give a simple combinatorial formula for computing the stringy E -function of the 3-dimensional canonical toric Fano variety X_Δ associated with the polytope Δ . Using the stringy Libgober-Wood identity and our formula, we generalize the well-known combinatorial identity $\sum_{\substack{\theta \preceq \Delta \\ \dim(\theta)=1}} v(\theta) \cdot v(\theta^*) = 24$ holding in the case of 3-dimensional reflexive polytopes Δ .

INTRODUCTION

Let N be a free abelian group of rank d . A d -dimensional convex polytope $\Delta \subseteq N_{\mathbb{R}} := N \otimes \mathbb{R}$ having vertices in N (i.e., $\Delta = \text{conv}(\Delta \cap N)$) is called *lattice polytope*. A lattice polytope Δ is called *canonical Fano* if the origin $0 \in N$ is the only lattice point in its interior Δ° , i.e., $\Delta^\circ \cap N = \{0\}$. Let X_Δ be the toric variety given by the *spanning fan* of a canonical Fano polytope Δ , i.e., X_Δ is defined by the fan $\Sigma_\Delta := \{\sigma_\theta \mid \theta \preceq \Delta\}$ whose cones $\sigma_\theta := \mathbb{R}_{\geq 0}\theta$ are spanned by all faces θ of Δ . It is known that the toric variety X_Δ has at worst canonical singularities [Rei83] and the anticanonical divisor $-K_{X_\Delta}$ of X_Δ is an ample \mathbb{Q} -Cartier divisor [Dan78], i.e., X_Δ is a *canonical toric Fano variety*. One can show that any d -dimensional canonical toric Fano variety can be obtained from a d -dimensional canonical Fano polytope Δ as above and that there is a bijection between d -dimensional canonical toric Fano varieties up to isomorphism and d -dimensional canonical Fano polytopes $\Delta \subseteq N_{\mathbb{R}}$ considered up to an isomorphism of the lattice N [Kas10]. The classification of d -dimensional canonical toric Fano varieties is known only for $d \leq 3$.

Let $M := \text{Hom}(N, \mathbb{Z})$ be the dual lattice and $M_{\mathbb{R}}$ the corresponding real vector space together with the natural pairing $\langle \cdot, \cdot \rangle : M_{\mathbb{R}} \times N_{\mathbb{R}} \rightarrow \mathbb{R}$. For any d -dimensional convex polytope $\Delta \subseteq N_{\mathbb{R}}$ containing $0 \in N$ in its interior, we consider the *dual polytope*

$$\Delta^* := \{y \in M_{\mathbb{R}} \mid \langle y, x \rangle \geq -1 \ \forall x \in \Delta\} \subseteq M_{\mathbb{R}}.$$

There exists a natural bijection (duality) between k -dimensional faces $\theta \preceq \Delta$ of Δ and $(d - k - 1)$ -dimensional *dual faces* $\theta^* \preceq \Delta^*$ of the dual polytope Δ^* defined as

$$\theta^* := \{y \in \Delta^* \mid \langle y, x \rangle = -1 \ \forall x \in \theta\}.$$

A d -dimensional lattice polytope $\Delta \subseteq N_{\mathbb{R}}$ containing $0 \in N$ in its interior is called *reflexive* if all vertices of the dual polytope Δ^* belong to the dual lattice M , i.e., if Δ^* is also a lattice polytope [Bat94]. If Δ is reflexive, then Δ^* is also reflexive and

$(\Delta^*)^* = \Delta$. Any facet $\theta \preceq \Delta$ of a reflexive polytope Δ is defined by an equation $\langle m, x \rangle = -1$ for some lattice vertex $m \in M$ of the dual reflexive polytope Δ^* . This means that each facet θ of a reflexive polytope Δ has lattice distance 1 to the origin $0 \in N$ and the origin is the only interior lattice point of Δ . In particular, every reflexive polytope is a canonical Fano polytope. The converse is not true. If Δ is a canonical Fano polytope, then the *lattice distance* n_θ from a $(d-1)$ -dimensional face $\theta \preceq \Delta$ to the origin can be larger than 1, i.e., the facet θ is defined by an equation $-\langle m, x \rangle = n_\theta > 1$ for some primitive lattice point $m \in M$. One can show that any canonical Fano polytope of dimension $d \leq 2$ is always reflexive, but the latter is not true if $d \geq 3$. There exist exactly 4,319 isomorphism classes of 3-dimensional reflexive polytopes classified by Kreuzer and Skarke [KS98]. However, there exist much more (exactly 674,688) isomorphism classes of 3-dimensional canonical Fano polytopes classified by Kasprzyk [Kas10].

If $\Delta \subseteq N_{\mathbb{R}}$ is an arbitrary d -dimensional lattice polytope, then we define $v(\Delta)$ to be the *normalized volume*, i.e., the positive integer $d! \cdot \text{vol}_d(\Delta)$, where $\text{vol}_d(\Delta)$ denotes the d -dimensional volume of Δ with respect to the lattice N . Similarly, we define the positive integer $v(\theta) := k! \cdot \text{vol}_k(\theta)$ for a k -dimensional face $\theta \preceq \Delta$, where $\text{vol}_k(\theta)$ denotes the k -dimensional volume of θ with respect to the sublattice $\text{span}(\theta) \cap N$. If $\Delta \subseteq N_{\mathbb{R}}$ is a d -dimensional polytope having vertices in $N_{\mathbb{Q}} := N \otimes \mathbb{Q}$, i.e., Δ is a rational polytope, then we can similarly define the positive rational number $v(\theta)$ for any k -dimensional face $\theta \preceq \Delta$. For this purpose, we consider an integer l such that $l\Delta$ is a lattice polytope and define for a k -dimensional face $\theta \preceq \Delta$ its volume as $v(\theta) := \frac{1}{l^k} v(l\theta)$.

For any 3-dimensional reflexive polytope Δ one has the well-known combinatorial identity

$$(\star) \quad 24 = \sum_{\substack{\theta \preceq \Delta \\ \dim(\theta)=1}} v(\theta) \cdot v(\theta^*)$$

[BCF⁺05, Theorem 4.3] (Corollary 1.8). A possible proof of this identity can be obtained from the fact that the Euler number of a smooth $K3$ -surface equals 24. In addition, one considers a generic affine hypersurface $Z_\Delta \subseteq (\mathbb{C}^*)^3$ defined by a Laurent polynomial $g_\Delta \in \mathbb{C}[x_1^{\pm 1}, x_2^{\pm 1}, x_3^{\pm 1}]$ with the reflexive Newton polytope Δ in the 3-dimensional torus $(\mathbb{C}^*)^3 \subseteq X_{\Delta^*}$ and applies the following two statements:

- The projective closure $\overline{Z_\Delta} \subseteq X_{\Delta^*}$ of Z_Δ is a $K3$ -surface with at worst canonical singularities [Bat94, Theorem 4.1.9];
- The number

$$\sum_{\substack{\theta \preceq \Delta \\ \dim(\theta)=1}} v(\theta) \cdot v(\theta^*)$$

equals the stringy Euler number of $\overline{Z_\Delta}$ [BD96, Corollary 7.10].

One of our results is a generalization of the combinatorial identity (\star) for arbitrary 3-dimensional canonical Fano polytopes Δ . First, we consider a 3-dimensional lattice

polytope $\Delta \subseteq N_{\mathbb{R}}$ such that a generic affine hypersurface $Z_{\Delta} \subseteq (\mathbb{C}^*)^3$ defined by a Laurent polynomial $f_{\Delta} \in \mathbb{C}[x_1^{\pm 1}, x_2^{\pm 1}, x_3^{\pm 1}]$ with the Newton polytope Δ is birational to a smooth $K3$ -surface. Such a lattice polytope Δ must be a 3-dimensional canonical Fano polytope, because the number of interior lattice points in Δ equals the geometric genus of the affine surface $Z_{\Delta} \subseteq (\mathbb{C}^*)^3$ [Kho78] and it equals 1 for a smooth $K3$ -surface. Moreover, one can show that the above condition on Δ is satisfied if and only if Δ is contained in some reflexive polytope Δ' . Those 3-dimensional canonical Fano polytopes are called *almost reflexive*. There exist many equivalent characterizations of 3-dimensional almost reflexive polytopes Δ [Bat17], e.g., $\Delta \subseteq N_{\mathbb{R}}$ is almost reflexive if and only if the convex hull $[\Delta^*] := \text{conv}(\Delta^* \cap M)$ of all lattice points in the dual polytope $\Delta^* \subseteq M_{\mathbb{R}}$ is a reflexive polytope. Using the list of all 3-dimensional canonical Fano polytopes [Kas10], Kasprzyk showed that among all 674,688 3-dimensional canonical Fano polytopes there exist exactly 9,089 lattice polytopes Δ which are not almost reflexive. In other words, there exist exactly 665,599 almost reflexive polytopes of dimension 3. Any almost reflexive polytope Δ allows us to construct a family of smooth $K3$ -surfaces using the toric variety X^{Δ} associated with the normal fan Σ^{Δ} of Δ . We recall that the *normal fan* $\Sigma^{\Delta} := \{\sigma^{\theta} \mid \theta \preceq \Delta\}$ consists of cones $\sigma^{\theta} := \mathbb{R}_{\geq 0}\theta^*$ corresponding to faces $\theta \preceq \Delta$, where σ^{θ} is the cone generated by the dual face $\theta^* \preceq \Delta^*$ of the dual polytope Δ^* and $\dim(\sigma^{\theta}) = \dim(\theta^*) + 1 = d - \dim(\theta)$.

A generalization of the combinatorial formula (\star) for an arbitrary 3-dimensional almost reflexive polytope Δ is the following statement:

Theorem A. *Let $\Delta \subseteq N_{\mathbb{R}}$ be an arbitrary 3-dimensional almost reflexive polytope. Then*

$$24 = v(\Delta) - \sum_{\substack{\theta \preceq \Delta \\ \dim(\theta)=2}} \frac{1}{n_{\theta}} \cdot v(\theta) + \sum_{\substack{\theta \preceq \Delta \\ \dim(\theta)=1}} v(\theta) \cdot v(\theta^*).$$

The proof of this new combinatorial formula is built around the more general combinatorial formula

$$e_{\text{str}}(Y) = \sum_{\substack{\theta \preceq \Delta \\ \dim(\theta) \geq 1}} (-1)^{\dim(\theta)-1} v(\theta) \cdot v(\sigma^{\theta} \cap \Delta^*)$$

[Bat17, Theorem 4.11] (Theorem 1.7) computing the stringy Euler number $e_{\text{str}}(Y)$ of a $(d-1)$ -dimensional Calabi-Yau variety Y with at worst canonical singularities which is birational to a generic $(d-1)$ -dimensional affine hypersurface $Z_{\Delta} \subseteq (\mathbb{C}^*)^d$ defined by a generic Laurent polynomial $f_{\Delta} \in \mathbb{C}[x_1^{\pm 1}, \dots, x_d^{\pm 1}]$ with the Newton polytope Δ . If $d = 3$, as we mentioned, such a $(d-1)$ -dimensional Calabi-Yau variety Y exists if and only if Δ is a 3-dimensional almost reflexive polytope.

It is remarkable that the same identity holds for all 9,089 lattice polytopes Δ which are not almost reflexive, i.e., it holds for all 674,688 3-dimensional canonical Fano polytopes Δ .

Theorem B. *Let $\Delta \subseteq N_{\mathbb{R}}$ be an arbitrary 3-dimensional canonical Fano polytope. Then*

$$24 = v(\Delta) - \sum_{\substack{\theta \preceq \Delta \\ \dim(\theta)=2}} \frac{1}{n_{\theta}} \cdot v(\theta) + \sum_{\substack{\theta \preceq \Delta \\ \dim(\theta)=1}} v(\theta) \cdot v(\theta^*).$$

The proof of this more general statement uses a combinatorial formula for computing the stringy E -function $E_{\text{str}}(X_{\Delta}; u, v)$ of a 3-dimensional canonical toric Fano variety X_{Δ} .

Theorem C. *Let X_{Δ} be a 3-dimensional canonical toric Fano variety defined by a 3-dimensional canonical Fano polytope $\Delta \subseteq N_{\mathbb{R}}$. Then the stringy E -function of X_{Δ} can be computed as*

$$E_{\text{str}}(X_{\Delta}; u, v) = ((uv)^3 + 1) + r \cdot ((uv)^2 + (uv)) + \sum_{\substack{\theta \preceq \Delta \\ \dim(\theta)=2, n_{\theta}>1}} v(\theta) \cdot \left(\sum_{k=1}^{n_{\theta}-1} (uv)^{\frac{k}{n_{\theta}}+1} \right),$$

where $r := |\Delta \cap N| - 4$.

In order to prove Theorem B, we combine the above formula for the stringy E -function $E_{\text{str}}(X_{\Delta}; u, v)$ with our combinatorial version of the stringy Libgober-Wood identity in terms of generalized stringy Hodge numbers and intersection products of stringy Chern classes [BS17, Theorem 4.3].

Organisation of the paper. In Section 1, we launch remaining and necessary definitions as well as explain important relationships focused on almost reflexive polytopes. In addition, we prove Theorem A.

In Section 2, we investigate the stringy E -function of arbitrary 3-dimensional toric Fano varieties with at worst canonical singularities and prove Theorem C.

In Section 3, we apply Theorem C in order to prove Theorem B using in addition a combinatorial version of the stringy Libgober-Wood identity.

Acknowledgments. We would like to thank Tom Coates, Alessio Corti, Alexander Kasprzyk, and Hannah Markwig for inspiring discussions.

1. STRINGY EULER NUMBERS AND CALABI-YAU HYPERSURFACES

The orbifold or stringy Euler number has been introduced by Dixon, Harvey, Vafa, and Witten [DHVW85] as a natural topological invariant motivated by string theory for singular Calabi-Yau varieties. Further investigations of mirror symmetry for singular Calabi-Yau varieties led to the notion of stringy E -functions [Bat98]. We recall their definition below.

Let X be a d -dimensional normal projective \mathbb{Q} -Gorenstein variety with at worst *log-terminal singularities*, i.e., the canonical divisor K_X of X is a \mathbb{Q} -Cartier divisor and for some desingularization $\rho : X' \rightarrow X$ of X , whose exceptional locus is a union of smooth irreducible divisors D_1, \dots, D_s with only normal crossings, one has $K_{X'} = \rho^* K_X + \sum_{i=1}^s a_i D_i$ for some rational numbers $a_i > -1$ for all $1 \leq i \leq s$. Moreover, we

define D_J to be the intersection $\bigcap_{j \in J} D_j$ for any nonempty subset $J \subseteq I := \{1, \dots, s\}$ and set $D_\emptyset := X'$. We remark that the subvariety $D_J \subseteq X'$ is either empty or a smooth projective subvariety of X' of codimension $|J|$. The *stringy E -function* of X is a rational algebraic function in two variables u, v defined as

$$E_{\text{str}}(X; u, v) := \sum_{\emptyset \subsetneq J \subsetneq I} E(D_J; u, v) \prod_{j \in J} \left(\frac{uv - 1}{(uv)^{a_j + 1} - 1} - 1 \right)$$

[Bat98, Definition 2.1], where $E(D_J; u, v) = \sum_{0 \leq p, q \leq d - |J|} (-1)^{p+q} h^{p,q}(D_J) u^p v^q$ is the generating polynomial for the Hodge numbers $h^{p,q}(D_J)$ of the smooth projective variety D_J . The *stringy Euler number* of X is defined as

$$e_{\text{str}}(X) := \lim_{u, v \rightarrow 1} E_{\text{str}}(X; u, v) = \sum_{\emptyset \subsetneq J \subsetneq I} c_{d-|J|}(D_J) \prod_{j \in J} \left(\frac{-a_j}{a_j + 1} \right).$$

The restriction on the singularities of X is used to prove the independence of $E_{\text{str}}(X; u, v)$ on the choice of the desingularization ρ [Bat98, Theorem 3.4]. As a special case, this formula implies the equality $E_{\text{str}}(X; u, v) = E(X; u, v)$ if X is smooth and the equality $E_{\text{str}}(X; u, v) = E(X'; u, v)$ if $\rho : X' \rightarrow X$ is a crepant desingularization of X , i.e., if all rational numbers a_i are zero.

It is very convenient to consider stringy invariants while investigating singular varieties X that appear in birational geometry and the minimal model program. It is known that a minimal model X' of a projective algebraic variety X with at worst log-terminal singularities is not uniquely determined, because sometimes there exists another minimal model X'' of X , which is obtained from X' by a sequence of flops. Nevertheless, the stringy E -functions of X' and X'' are the same, i.e., $E_{\text{str}}(X'; u, v) = E_{\text{str}}(X''; u, v)$. The same equality $E_{\text{str}}(X'; u, v) = E_{\text{str}}(X''; u, v)$ holds if the minimal model X' admits a crepant birational morphism $X' \rightarrow X''$ to a projective variety X'' with at worst canonical \mathbb{Q} -Gorenstein singularities. In particular, the stringy E -function of a minimal birational model of X and the stringy E -function of a canonical model of X are the same, i.e., they are independent of the choice of these birational models.

In this section, we are interested in the stringy Euler numbers $e_{\text{str}}(Y)$ of minimal and canonical models of algebraic varieties Y that are birational to a generic affine hypersurface $Z_\Delta \subseteq (\mathbb{C}^*)^d$ defined by a generic Laurent polynomial $f_\Delta \in \mathbb{C}[x_1^{\pm 1}, \dots, x_d^{\pm 1}]$ whose Newton polytope is a given d -dimensional lattice polytope $\Delta \subseteq N_{\mathbb{R}}$. In this case, the stringy Euler number $e_{\text{str}}(Y)$ is uniquely determined by the lattice polytope Δ and it can be computed by a combinatorial formula. The generic open condition on the coefficients of the Laurent polynomial f_Δ can be formulated in a more precise form:

Definition 1.1. Let $\Delta \subseteq N_{\mathbb{R}}$ be a d -dimensional lattice polytope and $Z_\Delta \subseteq \mathbb{T}_d \cong (\mathbb{C}^*)^d$ an affine hypersurface, which is the zero set of a Laurent polynomial

$$f_\Delta(x) = \sum_{n \in \Delta \cap \mathbb{Z}^d} a_n x^n \in \mathbb{C}[x_1^{\pm 1}, \dots, x_d^{\pm 1}]$$

with the Newton polytope Δ and some sufficiently general coefficients $a_n \in \mathbb{C}$. The Laurent polynomial f_Δ and the affine hypersurface Z_Δ are called Δ -*nondegenerate* if for every face $\theta \preceq \Delta$ the zero locus $Z_\theta := \{x \in \mathbb{T}_d \mid f_\theta(x) = 0\}$ of the θ -part of f_Δ is empty or a smooth affine hypersurface in the d -dimensional algebraic torus \mathbb{T}_d .

Definition 1.2. Let $\Delta \subseteq N_{\mathbb{R}}$ be a d -dimensional lattice polytope containing the origin $0 \in N$ in its interior. The lattice polytope Δ is called *almost pseudoreflexive* if the convex hull $[\Delta^*] = \text{conv}(\Delta^* \cap M)$ of all lattice points in the dual polytope Δ^* also contains the origin $0 \in M$ in its interior. An almost pseudoreflexive polytope Δ is called *pseudoreflexive* if $\Delta = [[\Delta^*]^*]$. If Δ is an almost pseudoreflexive polytope, then $[\Delta^*]$ is always a pseudoreflexive polytope. We call an almost pseudoreflexive polytope Δ *almost reflexive* if $[\Delta^*]$ is a reflexive polytope.

Using a result of Skarke [Ska96], one obtains that every pseudoreflexive polytope Δ of dimension $d \leq 4$ is reflexive. In particular, every almost pseudoreflexive polytope of dimension $d \leq 4$ is almost reflexive. There exists an equivalent description of almost reflexive polytopes Δ of dimension $d \leq 4$: Δ is almost pseudoreflexive if and only if Δ contains $0 \in N$ in its interior and is contained in some reflexive polytope Δ' [Bat17, Proposition 3.4 and Theorem 3.12].

The above classes of lattice polytopes Δ are related to some (singular) Calabi-Yau varieties:

Definition 1.3. Let Y be a $(d-1)$ -dimensional normal irreducible projective algebraic variety with trivial canonical divisor K_Y . We call Y a *Calabi-Yau variety* if Y has at worst canonical Gorenstein singularities and $H^i(Y, \mathcal{O}_Y) = 0$ ($0 < i < d-1$).

Almost pseudoreflexive polytopes Δ of dimension d are in the following sense closely related to Calabi-Yau varieties:

Proposition 1.4 ([Bat17, Theorem 2.23]). *Let $\Delta \subseteq N_{\mathbb{R}}$ be a d -dimensional lattice polytope containing the origin $0 \in N$ in its interior. A Δ -nondegenerate affine hypersurface $Z_\Delta \subseteq \mathbb{T}^d$ is birational to a $(d-1)$ -dimensional Calabi-Yau variety Y if and only if the polytope Δ is almost pseudoreflexive. In particular, in the case $d=3$ a Δ -nondegenerated affine surface $Z_\Delta \subseteq \mathbb{T}^3$ is birational to a K3-surface if and only if Δ is an almost reflexive polytope.*

In this paper, we consider the following three running examples of 3-dimensional canonical Fano polytopes Δ_1 , Δ_2 , and Δ_3 :

Example 1.5. Set $\Delta_1 := \text{conv}(e_1, e_2, e_3, -e_1 - e_2 - e_3)$, $\Delta_2 := \text{conv}(e_1, e_2, e_3, -e_1 - e_2 - 2e_3)$, and $\Delta_3 := \text{conv}(e_1, e_2, e_3, -5e_1 - 6e_2 - 8e_3)$ (Figure 1). All these polytopes contain the origin $0 \in \mathbb{Z}^3$ as a unique interior lattice point. The canonical Fano polytope Δ_1 is reflexive, but the canonical Fano polytopes Δ_2 and Δ_3 are not reflexive. One can check that the lattice polytope $[\Delta_i^*] = \text{conv}(\Delta_i^* \cap N)$ contains the origin in its interior (Figure 2, 3, and 8) if and only if $i \in \{1, 2\}$. So the lattice simplices Δ_1 , Δ_2 are almost reflexive, but the lattice simplex Δ_3 is not almost reflexive.

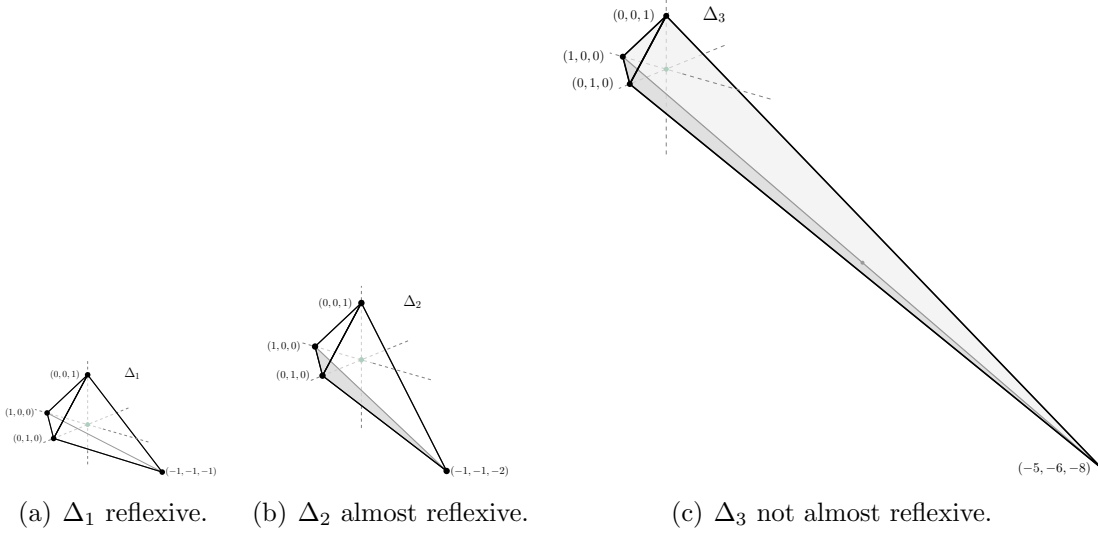

FIGURE 1. Three types of canonical Fano polytopes in dimension 3.

Now we formulate a main result of [Bat17]:

Theorem 1.6 ([Bat17, Theorem 4.11]). *Let $\Delta \subseteq N_{\mathbb{R}}$ be an arbitrary d -dimensional almost pseudoreflexive polytope. Denote by Y a canonical Calabi-Yau model of a Δ -nondegenerate affine hypersurface $Z_{\Delta} \subseteq \mathbb{T}_d$. Then the stringy Euler number of Y can be computed by the combinatorial formula*

$$e_{\text{str}}(Y) = \sum_{\substack{\theta \preceq \Delta \\ \dim(\theta) \geq 1}} (-1)^{\dim(\theta)-1} v(\theta) \cdot v(\sigma^{\theta} \cap \Delta^*),$$

where $\sigma^{\theta} = \mathbb{R}_{\geq 0}\theta^*$ is the cone in the normal fan Σ^{Δ} of Δ corresponding to the dual face $\theta^* \preceq \Delta^*$ of the dual polytope $\Delta^* \subseteq M_{\mathbb{R}}$.

The combinatorial formula for the stringy Euler number in Theorem 1.6 can be rewritten in the following equivalent form:

Theorem 1.7. *Let $\Delta \subseteq N_{\mathbb{R}}$ be an arbitrary d -dimensional almost pseudoreflexive polytope. Denote by Y a canonical Calabi-Yau model of a Δ -nondegenerated affine hypersurface $Z_{\Delta} \subseteq \mathbb{T}_d$. Then the stringy Euler number of Y can be computed by the combinatorial formula*

$$e_{\text{str}}(Y) = v(\Delta) - \sum_{\substack{\theta \preceq \Delta \\ \dim(\theta) = d-1}} \frac{1}{n_{\theta}} \cdot v(\theta) + \sum_{\substack{\theta \preceq \Delta \\ 1 \leq \dim(\theta) \leq d-2}} (-1)^{\dim(\theta)-1} v(\theta) \cdot v(\theta^*).$$

Proof. Let $\theta \preceq \Delta$ be a face of Δ . If $\theta = \Delta$, then $\sigma^{\theta} \cap \Delta^* = \{0\}$ and $v(\sigma^{\theta} \cap \Delta^*) = 1$. If θ is a $(d-1)$ -dimensional face of Δ and u_{θ} denotes the primitive inward-pointing facet normal of θ , then $\sigma^{\theta} \cap \Delta^* = \text{conv}(0, 1/n_{\theta} \cdot u_{\theta})$ and $v(\sigma^{\theta} \cap \Delta^*) = 1/n_{\theta}$. If $\theta \preceq \Delta$ is face of Δ of dimension k ($1 \leq k \leq d-2$), then $\sigma^{\theta} \cap \Delta^*$ is a $(d-k)$ -dimensional pyramid with vertex $0 \in M$ over the $(d-k-1)$ -dimensional dual face θ^* . By definition of

the dual polytope Δ^* , the lattice distance between 0 and θ^* equals 1. So we get $v(\sigma^\theta \cap \Delta^*) = v(\theta^*)$. Now it remains to apply the formula of Theorem 1.6. \square

We apply this theorem in the case $d = 3$ to get a new combinatorial identity for the Euler number 24:

Theorem A. *Let $\Delta \subseteq N_{\mathbb{R}}$ be an arbitrary 3-dimensional almost reflexive polytope. Then*

$$24 = v(\Delta) - \sum_{\substack{\theta \preceq \Delta \\ \dim(\theta)=2}} \frac{1}{n_\theta} \cdot v(\theta) + \sum_{\substack{\theta \preceq \Delta \\ \dim(\theta)=1}} v(\theta) \cdot v(\theta^*).$$

Proof. A canonical Calabi-Yau model Y of a Δ -nondegenerate affine hypersurface $Z_\Delta \subseteq \mathbb{T}_3$ is a $K3$ -surface with at worst canonical singularities (Proposition 1.4). Its minimal crepant desingularization \tilde{Y} is a smooth $K3$ -surface and by Noether's Theorem

$$2 = \chi(\tilde{Y}, \mathcal{O}_{\tilde{Y}}) = \frac{1}{12}(c_1(\tilde{Y})^2 + c_2(\tilde{Y}))$$

the stringy Euler number $e_{\text{str}}(Y)$ equals $c_2(\tilde{Y}) = 24$. Using the formula for $e_{\text{str}}(Y)$ from Theorem 1.7, we get the required identity. \square

The statement of Theorem A specializes to the well-known formula for reflexive polytopes in dimension 3 [BCF⁺05, Theorem 4.3] (Equation (\star)):

Corollary 1.8. *Let $\Delta \subseteq N_{\mathbb{R}}$ be a 3-dimensional reflexive polytope. Then*

$$24 = \sum_{\substack{\theta \preceq \Delta \\ \dim(\theta)=1}} v(\theta) \cdot v(\theta^*).$$

Proof. We apply Theorem A and get

$$24 = v(\Delta) - \sum_{\substack{\theta \preceq \Delta \\ \dim(\theta)=2}} \frac{1}{n_\theta} \cdot v(\theta) + \sum_{\substack{\theta \preceq \Delta \\ \dim(\theta)=1}} v(\theta) \cdot v(\theta^*).$$

Since Δ is reflexive, we have $n_\theta = 1$ for all facets $\theta \preceq \Delta$ and

$$v(\Delta) - \sum_{\substack{\theta \preceq \Delta \\ \dim(\theta)=2}} \frac{1}{n_\theta} \cdot v(\theta) = v(\Delta) - \sum_{\substack{\theta \preceq \Delta \\ \dim(\theta)=2}} v(\theta) = 0.$$

The equation from above simplifies to

$$24 = \sum_{\substack{\theta \preceq \Delta \\ \dim(\theta)=1}} v(\theta) \cdot v(\theta^*).$$

\square

Example 1.9. For the reflexive polytope $\Delta_1 = \text{conv}(e_1, e_2, e_3, -e_1 - e_2 - e_3)$ (Figure 2(a) and 1(a)) we get the identity

$$\sum_{\substack{\theta \preceq \Delta_1 \\ \dim(\theta)=1}} v(\theta) \cdot v(\theta^*) = 6 \cdot (1! \cdot 1) \cdot (1! \cdot 4) = 24,$$

because the dual polytope equals

$$\Delta_1^* = \text{conv}((3, -1, -1), (-1, 3, -1), (-1, -1, 3), (-1, -1, -1))$$

and $\dim(\theta^*) = 1$ with $v(\theta^*) = 1! \cdot 4 = 4$ for every 1-dimensional face $\theta \preceq \Delta_1$.

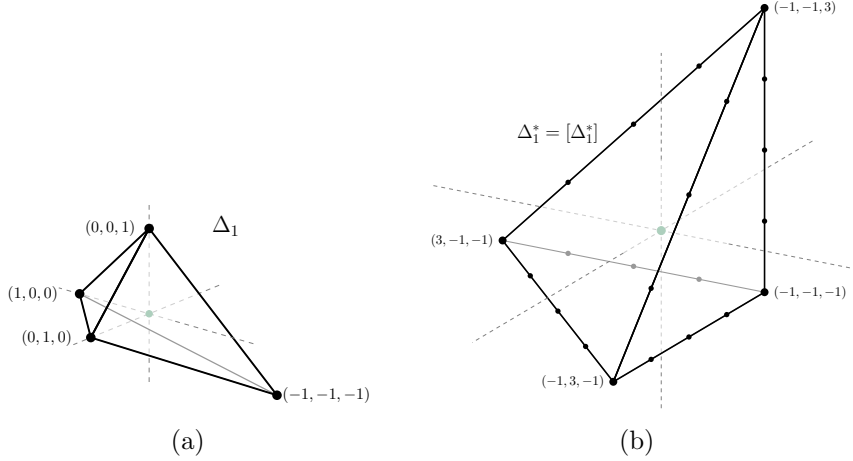

FIGURE 2. Illustration of a reflexive polytope.

Example 1.10. Consider the almost reflexive polytope $\Delta_2 = \text{conv}(e_1, e_2, e_3, -e_1 - e_2 - 2e_3)$ (Figure 3(a) and 1(b)). Its dual polytope Δ_2^* is rational:

$$\Delta_2^* = \text{conv}((4, -1, -1), (-1, 4, -1), (-1, -1, 3/2), (-1, -1, -1)).$$

There exists exactly one 2-dimensional face (highlighted in gray in Figure 3(a)) of Δ_2 having lattice distance $2 > 1$ to the origin. The combinatorial identity from Theorem A holds, because

$$\begin{aligned} v(\Delta_2) - \sum_{\substack{\theta \preceq \Delta_2 \\ \dim(\theta)=2}} \frac{1}{n_\theta} \cdot v(\theta) + \sum_{\substack{\theta \preceq \Delta_2 \\ \dim(\theta)=1}} v(\theta) \cdot v(\theta^*) \\ = 5 - \left(\frac{1}{2} \cdot 1 + 1 \cdot 1 + 1 \cdot 1 + 1 \cdot 1\right) + \left(1 \cdot \frac{5}{2} + 1 \cdot \frac{5}{2} + 1 \cdot \frac{5}{2} + 1 \cdot 5 + 1 \cdot 5 + 1 \cdot 5\right) \\ = 5 - 3.5 + 22.5 = 24. \end{aligned}$$

2. STRINGY E -FUNCTIONS OF CANONICAL TORIC FANO THREEFOLDS

Let X be a d -dimensional projective \mathbb{Q} -Gorenstein toric variety associated with a fan Σ of rational polyhedral cones in $N_{\mathbb{R}}$. We denote by $\Sigma(k)$ the set of all k -dimensional cones in Σ . We choose Σ' to be a simplicial subdivision of the fan Σ such that $\Sigma'(1) \subseteq \Sigma(1)$ and define κ_Σ to be the Σ -piecewise linear function corresponding to the anticanonical divisor $-K_X$ of X (i.e., κ_Σ has value -1 on every primitive ray generator of a 1-dimensional cone $\rho \in \Sigma(1)$). Moreover, we define $\square_\sigma^\circ := \sigma^\circ \cap \square_\sigma$ for any cone $\sigma \in \Sigma'$, where σ° denotes the relative interior of σ and \square_σ the parallelepiped spanned by the primitive ray generators of the cone σ .

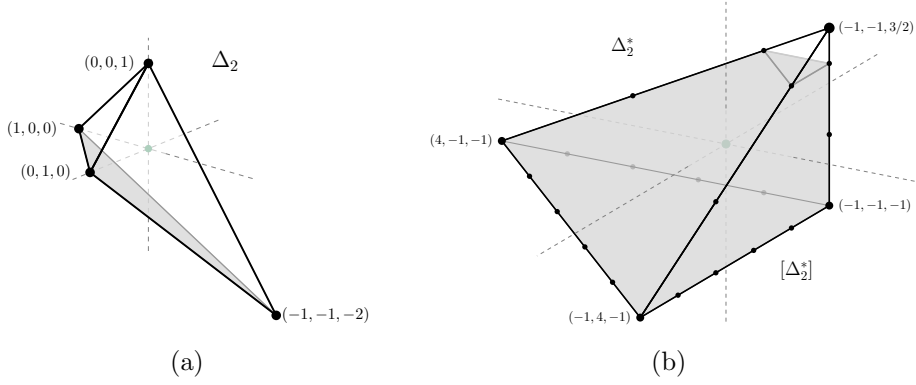

FIGURE 3. Illustration of an almost reflexive polytope.

There is a general formula for the stringy E -function $E_{\text{str}}(X; u, v)$ of the d -dimensional projective \mathbb{Q} -Gorenstein toric variety X :

Proposition 2.1 ([BS17, Proposition 4.1]). *Let X be a d -dimensional projective \mathbb{Q} -Gorenstein toric variety associated with a fan Σ . Then the stringy E -function of X can be computed as the finite sum*

$$E_{\text{str}}(X; u, v) = \sum_{\sigma \in \Sigma'} (uv - 1)^{d - \dim(\sigma)} \sum_{n \in \square_{\sigma}^{\circ} \cap N} (uv)^{\dim(\sigma) + \kappa_{\Sigma}(n)}.$$

In particular,

$$E_{\text{str}}(X; u, v) = \sum_{\alpha} \psi_{\alpha}(\Sigma) (uv)^{\alpha}$$

for some nonnegative integers $\psi_{\alpha}(\Sigma)$ and some nonnegative rational numbers α .

A much more precise computation of the stringy E -function $E_{\text{str}}(X; u, v)$ has been obtained if X is a *toric log del Pezzo surface*, i.e., a normal projective toric surface with at worst log-terminal singularities and an ample anticanonical \mathbb{Q} -Cartier divisor $-K_X$ [KKN10]. Such a toric surface is defined by a *LDP-polygon* $\Delta \subseteq N_{\mathbb{R}}$, i.e., a 2-dimensional lattice polytope containing the origin $0 \in N$ in its interior such that all vertices of Δ are primitive lattice points in N . In this case, $\Sigma = \Sigma_{\Delta}$ is the spanning fan in the 2-dimensional space $N_{\mathbb{R}}$ consisting of cones over faces of the LDP-polygon Δ . Using Proposition 2.1, we got

Theorem 2.2 ([BS17, Corollary 4.5]). *Let X be a toric log del Pezzo surface defined by a LDP-polygon $\Delta \subseteq N_{\mathbb{R}}$. Then the stringy E -function of X can be computed as*

$$E_{\text{str}}(X; u, v) = ((uv)^2 + 1) + r \cdot (uv) + \sum_{n \in \Delta^{\circ} \setminus \{0\}} ((uv)^{2 + \kappa_{\Delta}(n)} + (uv)^{-\kappa_{\Delta}(n)}),$$

where $r := |\partial\Delta \cap N| - 2$ and κ_{Δ} is the Σ_{Δ} -piecewise linear function corresponding to the anticanonical divisor $-K_X$ of X with value -1 on the whole boundary $\partial\Delta$ of Δ .

Example 2.3. Set $\Delta := \text{conv}(e_1, e_2, -e_1 - e_2)$ and $\Delta_m := \text{conv}(e_1, e_2, -e_1 - me_2)$ for an integer $m \in \mathbb{N}$ (Figure 4(a) and 4(b)), i.e., Δ is a reflexive polygon and Δ_m a

LDP -polygon. Therefore, $X_\Delta = \mathbb{P}_2$ and X_{Δ_m} are toric log del Pezzo surfaces with

$$E_{\text{str}}(X_\Delta; u, v) = (uv)^2 + (uv) + 1$$

and

$$E_{\text{str}}(X_{\Delta_3}; u, v) = ((uv)^2 + 1) + (uv) + ((uv)^{\frac{4}{3}} + (uv)^{\frac{2}{3}})$$

by using Theorem 2.2, because $\sum_{0 < n \leq \frac{3}{2}} ((uv)^{2 - \frac{2}{3}n} + (uv)^{\frac{2}{3}n}) = (uv)^{\frac{4}{3}} + (uv)^{\frac{2}{3}}$.

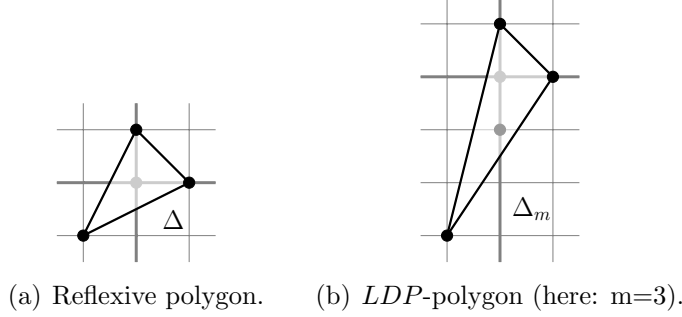

FIGURE 4. Reflexive polygons and LDP -polygons.

Let $\Delta \subseteq N_{\mathbb{R}}$ be a 3-dimensional canonical Fano polytope, Σ_Δ the associated spanning fan of Δ , and $X := X_\Delta$ the corresponding toric Fano threefold with at worst canonical singularities. We are interested in a similar combinatorial formula to compute the stringy E -function $E_{\text{str}}(X; u, v)$ of such a toric Fano threefold X by making sole use of information about the lattice polytope Δ that yields the appearing coefficients $\psi_\alpha(\Sigma_\Delta)$ and rational powers of $(uv)^\alpha$ in $E_{\text{str}}(X; u, v)$ in a direct way. To be precise, the following formula depends primarily on the volumes $v(\theta)$ and lattice distances n_θ to the origin of 2-dimensional faces $\theta \preceq \Delta$:

Theorem C. *Let $\Delta \subseteq N_{\mathbb{R}}$ be a 3-dimensional canonical Fano polytope. Then the stringy E -function of the corresponding canonical toric Fano threefold $X := X_\Delta$ can be computed as*

$$E_{\text{str}}(X; u, v) = ((uv)^3 + 1) + r \cdot ((uv)^2 + (uv)) + \sum_{\substack{\theta \preceq \Delta \\ \dim(\theta)=2, n_\theta > 1}} v(\theta) \cdot \left(\sum_{k=1}^{n_\theta-1} (uv)^{\frac{k}{n_\theta} + 1} \right)$$

with $r := |\Delta \cap N| - 4$.

Proof. Applying Proposition 2.1, we know that the stringy E -function of X is given as

$$E_{\text{str}}(X; u, v) = \sum_{\sigma \in \Sigma'_\Delta} (uv - 1)^{3 - \dim(\sigma)} \sum_{n \in \square_\sigma^\circ \cap N} (uv)^{\dim(\sigma) + \kappa_\Delta(n)},$$

where Σ'_Δ is a simplicial subdivision of the fan Σ_Δ such that $\Sigma_\Delta(1) \subseteq \Sigma'_\Delta(1)$ with $|\Sigma'_\Delta(1)| = |\Delta \cap N| - 1$, where the fan Σ'_Δ is obtained by a triangulation of all 2-dimensional faces $\theta \preceq \Delta$ of Δ and $\square_\sigma^\circ = \sigma^\circ \cap \square_\sigma$ for a cone $\sigma \in \Sigma'_\Delta$.

In each 1-dimensional cone $\rho \in \Sigma'_\Delta(1)$, there exists exactly one lattice point $n \in \square_\rho^\circ \cap N$ with $\kappa_\Delta(n) = -1$, because n is a boundary lattice point of Δ . Each 2-dimensional cone $\tau \in \Sigma'_\Delta(2)$ contains also exactly one lattice point $n \in \square_\tau^\circ \cap N$ with $\kappa_\Delta(n) = -2$, because the minimal lattice generators $u_{\rho'}$ and $u_{\rho''}$ of τ are linearly independent over \mathbb{R} with $n = u_{\rho'} + u_{\rho''}$. These two facts yield

$$(1) \quad E_{\text{str}}(X; u, v) = (uv - 1)^3 + \sum_{\rho \in \Sigma'_\Delta(1)} (uv - 1)^2 + \sum_{\tau \in \Sigma'_\Delta(2)} (uv - 1) \\ + \sum_{\sigma \in \Sigma'_\Delta(3)} \left(1 + \sum_{\substack{n \in \square_\sigma^\circ \cap N \\ \kappa_\Delta(n) \in \mathbb{Q} \setminus \mathbb{Z}}} (uv)^{3+\kappa_\Delta(n)} \right),$$

because each 3-dimensional cone $\sigma \in \Sigma'_\Delta(3)$ has also exactly one lattice point $n \in \square_\sigma^\circ \cap N$ with $\kappa_\Delta(n) = -3$. The intersections of all cones $\sigma \in \Sigma'_\Delta$ with the 2-dimensional sphere S^2 defines a triangulation of S^2 . Therefore, we have $|\Sigma'_\Delta(3)| = 2 \cdot |\Sigma'_\Delta(1)| - 4$ and $|\Sigma'_\Delta(2)| = 3 \cdot |\Sigma'_\Delta(1)| - 6$. Using $|\Sigma'_\Delta(1)| = |\Delta \cap N| - 1$, we get

$$(2) \quad E_{\text{str}}(X; u, v) = (uv - 1)^3 + (|\Delta \cap N| - 1)(uv - 1)^2 + \sum_{\sigma \in \Sigma'_\Delta(2)} (uv - 1) + T + \sum_{\sigma \in \Sigma'_\Delta(3)} 1 \\ = ((uv)^3 + 1) + (|\Delta \cap N| - 4)((uv)^2 + (uv)) + T,$$

where

$$T := \sum_{\sigma \in \Sigma'_\Delta(3)} T_\sigma \quad \text{and} \quad T_\sigma := \sum_{\substack{n \in \square_\sigma^\circ \cap N \\ \kappa_\Delta(n) \in \mathbb{Q} \setminus \mathbb{Z}}} (uv)^{3+\kappa_\Delta(n)} \quad \text{for } \sigma \in \Sigma'_\Delta(3).$$

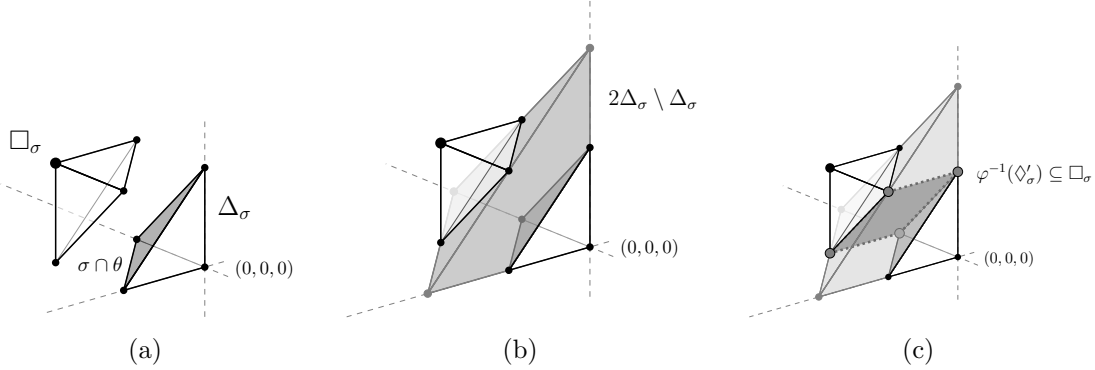

FIGURE 5. Illustration to detect $n \in \square_\sigma^\circ \cap N$ with $\kappa_\Delta(n) \in \mathbb{Q} \setminus \mathbb{Z}$.

Let $\sigma \in \Sigma'_\Delta(3)$ be a 3-dimensional cone. Then $\sigma \cap \theta$ is a 2-dimensional simplex with $v(\sigma \cap \theta) = 1$ contained in a 2-dimensional face $\theta \preceq \Delta$ of Δ . The only lattice points of the 3-dimensional lattice simplex $\Delta_\sigma := \sigma \cap \Delta$ are the origin $0 \in N$ and the three vertices ν_1, ν_2 , and ν_3 of the triangle $\sigma \cap \theta$ (Figure 5(a)), because Δ is a canonical Fano polytope. Therefore, we get $v(\Delta_\sigma) = v(\sigma \cap \theta) \cdot n_\theta = n_\theta$.

If $n_\theta = 1$, then $v(\Delta_\sigma) = 1$ and σ is generated by a basis of N , i.e., $T_\sigma = 0$. For the following considerations, let n_θ be greater than 1. A lattice point $n \in \square_\sigma^\circ \cap N$

can not be contained in Δ_σ and $-\Delta_\sigma + (\nu_1 + \nu_2 + \nu_3)$ (Figure 5(a)) as well as not in one of the three simplices $\Delta_\sigma + \nu_1$, $\Delta_\sigma + \nu_2$, and $\Delta_\sigma + \nu_3$ (Figure 5(b)). Therefore, n belongs to $(2\Delta_\sigma)^\circ \cap N$, i.e.,

$$(3) \quad T_\sigma = \sum_{\substack{n \in \square_\sigma^\circ \cap N \\ \kappa_\Delta(n) \in \mathbb{Q} \setminus \mathbb{Z}}} (uv)^{3+\kappa_\Delta(n)} = \sum_{n \in (2\Delta_\sigma)^\circ \cap N} (uv)^{3+\kappa_\Delta(n)}.$$

To compute T_σ , we apply the Theorem of White [Whi64], which claims that Δ_σ is affine unimodular isomorphic to a lattice simplex $\Delta'_\sigma := \text{conv}(\nu'_1, \nu'_2, \nu'_3, \nu'_4)$ such that $\nu'_1 := (0, 0, 0)$, $\nu'_2 := (1, 0, 0)$, $\nu'_3 := (0, 0, 1)$, and $\nu'_4 := (a, n_\theta, 1)$ for some integer a with $\gcd(a, n_\theta) = 1$ (Figure 6(a)). In particular, Δ'_σ is contained between the two planes $\{z = 0\}$ and $\{z = 1\}$. The affine isomorphism $\varphi : \Delta_\sigma \rightarrow \Delta'_\sigma$ of White maps the vertex $0 \in \Delta_\sigma$ to the vertex $\nu'_4 \in \Delta'_\sigma$ and transforms the linear function κ_Δ on σ into the affine linear function $-1 + \frac{y}{n_\theta}$ on a cone with origin ν'_4 and generators $\nu'_i - \nu'_4$ ($1 \leq i \leq 3$).

The double simplex $2\Delta'_\sigma$ is contained between the two planes $\{z = 0\}$ and $\{z = 2\}$. Therefore, an interior lattice point $n \in (2\Delta'_\sigma)^\circ$ belongs to an interior point of $\diamond'_\sigma := 2\Delta'_\sigma \cap \{z = 1\}$, which is a parallelogram spanned by the vectors $(0, 1, 1)$ and $(a, n_\theta, 1)$ (Figure 6(b)). We remark that the isomorphism of White maps \diamond'_σ into a subset of \square_σ (Figure 5(c)).

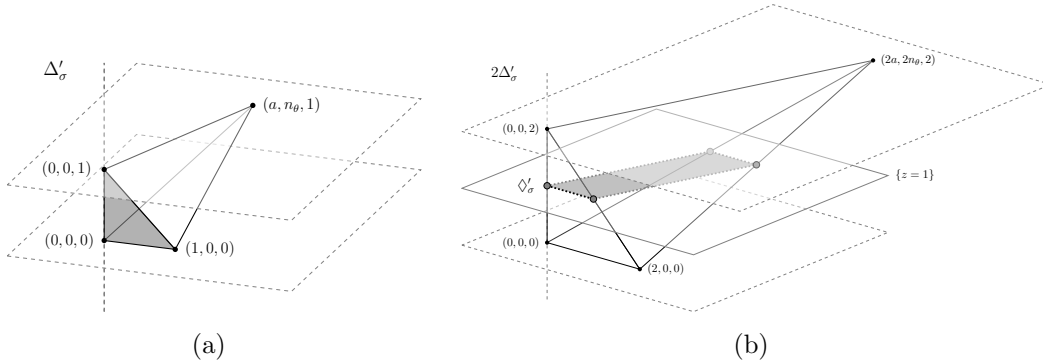

FIGURE 6. Theorem of White (here: $a = 1$ and $n_\theta = 3$).

The volume of the parallelogram \diamond'_σ equals n_θ and it has exactly 4 boundary lattice points. By Pick's Theorem, there exist exactly $n_\theta - 1$ lattice points in the interior of \diamond'_σ . We claim that the affine linear function $-1 + \frac{y}{n_\theta}$ takes $n_\theta - 1$ different values on these lattice points (Figure 7). Assume that there exist two lattice points $P = (P_x, P_y)$ and $P' = (P'_x, P'_y)$ with $P'_x \geq P_x$ in the interior of \diamond'_σ with the same affine linear function values, i.e., $P_y = P'_y$ and $v(\text{conv}(P, P')) \geq 1$. Set $E := \text{conv}((0, 0), (1, 0))$, then $P' - P \in E^\circ \cap N = \emptyset$. Contradiction.

Therefore, we get the set equality

$$\{\kappa_\Delta(n) \in \mathbb{Q} \setminus \mathbb{Z} \mid n \in \square_\sigma^\circ \cap N\} = \left\{ -1 - \frac{l}{n_\theta} \mid l \in \{1, \dots, n_\theta - 1\} \right\}$$

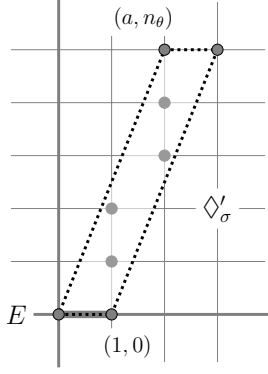

FIGURE 7. Illustration of \diamond'_σ (here: $a = 2$ and $n_\theta = 5$).

and Equation (3) can be rewritten in the form

$$T_\sigma = \sum_{\substack{n \in \square_\sigma^\circ \cap N \\ \kappa_\Delta(n) \in \mathbb{Q} \setminus \mathbb{Z}}} (uv)^{3+\kappa_\Delta(n)} = \sum_{l=1}^{n_\theta-1} (uv)^{2-\frac{l}{n_\theta}} = \sum_{k=1}^{n_\theta-1} (uv)^{1+\frac{k}{n_\theta}}.$$

Using this, the remaining last term in Equation (1) can be computed as

$$(4) \quad T = \sum_{\sigma \in \Sigma'_\Delta(3)} \sum_{\substack{n \in \square_\sigma^\circ \cap N \\ \kappa_\Delta(n) \in \mathbb{Q} \setminus \mathbb{Z}}} (uv)^{3+\kappa_\Delta(n)} = \sum_{\substack{\theta \preceq \Delta \\ \dim(\theta)=2, n_\theta > 1}} v(\theta) \cdot \left(\sum_{k=1}^{n_\theta-1} (uv)^{\frac{k}{n_\theta}+1} \right),$$

because $\sum_{\sigma \cap \theta \subseteq \theta} v(\sigma \cap \theta) = \sum_{\sigma \cap \theta \subseteq \theta} 1 = v(\theta)$.

A combination of Equation (1), (2), and (4) yields the desired result

$$E_{\text{str}}(X; u, v) = ((uv)^3 + 1) + r \cdot ((uv)^2 + (uv)) + \sum_{\substack{\theta \preceq \Delta \\ \dim(\theta)=2, n_\theta > 1}} v(\theta) \cdot \left(\sum_{k=1}^{n_\theta-1} (uv)^{\frac{k}{n_\theta}+1} \right)$$

with $r = |\Delta \cap N| - 4$. □

Example 2.4. Consider $\Delta_1 = \text{conv}(e_1, e_2, e_3, -e_1 - e_2 - e_3)$, $\Delta_2 = \text{conv}(e_1, e_2, e_3, -e_1 - e_2 - 2e_3)$, and $\Delta_3 = \text{conv}(e_1, e_2, e_3, -5e_1 - 6e_2 - 8e_3)$ (Figure 1) with $\Delta_i^\circ \cap N = \{0\}$ ($1 \leq i \leq 3$). Therefore, X_{Δ_i} ($1 \leq i \leq 3$) are toric Fano threefolds with at worst canonical singularities with $X_{\Delta_1} = \mathbb{P}(1, 1, 1, 1) = \mathbb{P}_3$, $X_{\Delta_2} = \mathbb{P}(1, 1, 1, 2)$, and $X_{\Delta_3} = \mathbb{P}(1, 5, 6, 8)$. By using Theorem C the associated stringy E -functions are given as

$$E_{\text{str}}(X_{\Delta_1}; u, v) = (uv)^3 + (uv)^2 + (uv) + 1,$$

$$E_{\text{str}}(X_{\Delta_2}; u, v) = (uv)^3 + (uv)^2 + (uv)^{\frac{3}{2}} + (uv) + 1,$$

and

$$E_{\text{str}}(X_{\Delta_3}; u, v) = (uv)^3 + 5 \cdot (uv)^2 + 2 \cdot (uv)^{\frac{5}{3}} + 4 \cdot (uv)^{\frac{3}{2}} + 2 \cdot (uv)^{\frac{4}{3}} + 5 \cdot (uv) + 1.$$

3. THE NUMBER 24 AND 3-DIMENSIONAL CANONICAL FANO POLYTOPES

The lattice simplex $\Delta_3 = \text{conv}(e_1, e_2, e_3, -5e_1 - 6e_2 - 8e_3)$ (Figure 8(a) and 1(c)) is one of the simplest examples of a 3-dimensional canonical Fano polytope, which is not almost reflexive. The canonical Fano polytope Δ_3 corresponds to the canonical toric Fano threefold X_{Δ_3} , which is the weighted projective space $\mathbb{P}(1, 5, 6, 8)$. It was observed by Corti and Golyshev [CG11] that an affine hypersurface $Z_{\Delta_3} \subseteq (\mathbb{C}^*)^3$ defined by a general Laurent polynomial $f_{\Delta_3} \in \mathbb{C}[x_1^{\pm 1}, x_2^{\pm 1}, x_3^{\pm 1}]$ with the Newton polytope Δ_3 is birational to an elliptic surface of Kodaira dimension one. In particular, Z_{Δ_3} is not birational to a $K3$ -surface. The dual polytope Δ_3^* (Figure 8(b)) is the rational simplex

$$\text{conv}((3, -1, -1), (-1, 7/3, -1), (-1, -1, 3/2), (-1, -1, -1)).$$

The two rational vertices of Δ_3^* are dual to two 2-dimensional faces of Δ_3 (highlighted in gray and lightgray in Figure 8(a)) having lattice distance 2 and 3 to the origin, so that one gets

$$\sum_{\substack{\theta \preceq \Delta_3 \\ \dim(\theta)=2}} \frac{1}{n_\theta} \cdot v(\theta) = \frac{1}{2} \cdot 4 + \frac{1}{3} \cdot 2 + 1 \cdot 1 + 1 \cdot 5 = \frac{26}{3}$$

and

$$\sum_{\substack{\theta \preceq \Delta_3 \\ \dim(\theta)=1}} v(\theta) \cdot v(\theta^*) = 2 \cdot \frac{5}{6} + 1 \cdot \frac{5}{2} + 1 \cdot \frac{1}{2} + 1 \cdot \frac{10}{3} + 1 \cdot \frac{2}{3} + 1 \cdot 4 = \frac{38}{3}.$$

Therefore, we obtain the equality

$$v(\Delta_3) - \sum_{\substack{\theta \preceq \Delta_3 \\ \dim(\theta)=2}} \frac{1}{n_\theta} \cdot v(\theta) + \sum_{\substack{\theta \preceq \Delta_3 \\ \dim(\theta)=1}} v(\theta) \cdot v(\theta^*) = 24,$$

because $v(\Delta_3) = 20$.

As we have already mentioned, there exist exactly 9,089 canonical Fano polytopes in dimension 3, which are not almost reflexive. Our purpose is now to show that these polytopes also satisfy the identity of Theorem A, so that one gets the further generalization stated in

Theorem B. *Let $\Delta \subseteq N_{\mathbb{R}}$ be an arbitrary 3-dimensional canonical Fano polytope. Then*

$$24 = v(\Delta) - \sum_{\substack{\theta \preceq \Delta \\ \dim(\theta)=2}} \frac{1}{n_\theta} \cdot v(\theta) + \sum_{\substack{\theta \preceq \Delta \\ \dim(\theta)=1}} v(\theta) \cdot v(\theta^*).$$

To proof this statement, we can not use the ideas of Section 1, because there exist 9,089 canonical Fano polytopes Δ of dimension 3, that are not related to $K3$ -surfaces. In contrast, we use a completely different idea based on the stringy Libgober-Wood identity and its combinatorial interpretation for toric varieties containing generalized stringy Hodge numbers and intersection products of stringy Chern classes.

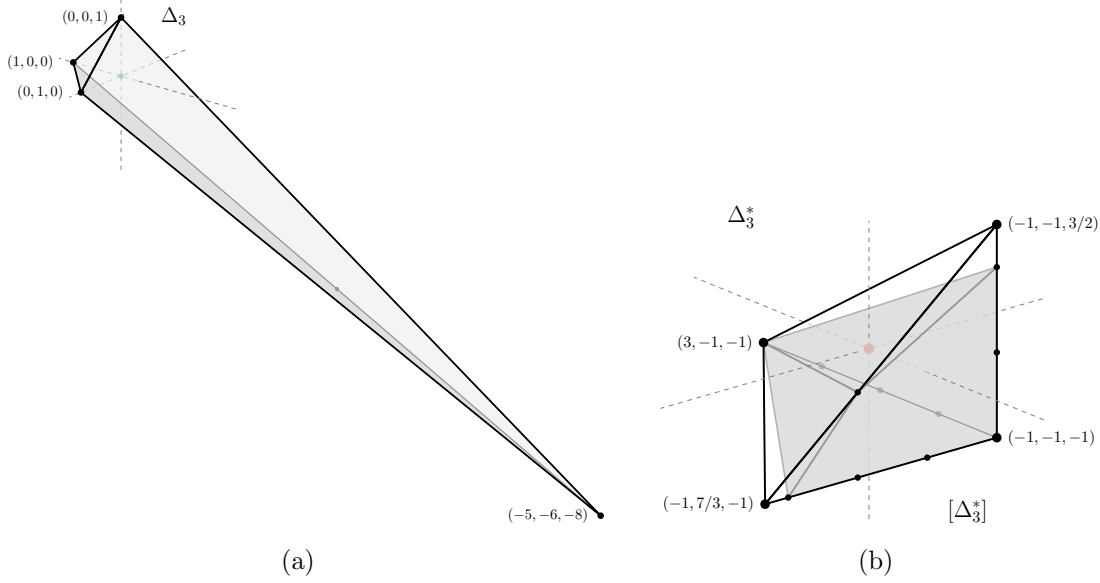

FIGURE 8. Illustration of a not almost reflexive polytope.

The original Libgober-Wood identity for smooth projective varieties has appeared in [LW90] and it has been generalized to the stringy Libgober-Wood identity

$$\frac{d^2}{du^2} E_{\text{str}}(X; u, 1) \Big|_{u=1} = \frac{3d^2 - 5d}{12} c_d^{\text{str}}(X) + \frac{1}{6} c_1(X) \cdot c_{d-1}^{\text{str}}(X)$$

for a d -dimensional projective variety X with at worst log-terminal singularities [Bat00, Theorem 3.8], where $c_k^{\text{str}}(X) \in A^k(X)_{\mathbb{Q}}$ denotes the k -th stringy Chern class of X [BS17, Section 1].

If $X = X_{\Sigma}$ is a d -dimensional \mathbb{Q} -Gorenstein projective toric variety of Gorenstein index q_X associated with a d -dimensional fan Σ of rational polyhedral cones in $N_{\mathbb{R}}$ and $-K_X$ an ample \mathbb{Q} -Cartier divisor, then the stringy E -function of X can be written as a finite sum

$$E_{\text{str}}(X_{\Sigma}; u, v) = \sum_{\alpha \in [0, d] \cap \frac{1}{q_X} \mathbb{Z}} \psi_{\alpha}(\Sigma) (uv)^{\alpha}$$

[BS17, Proposition 4.1], where the coefficients $\psi_{\alpha}(\Sigma)$ are nonnegative integers (*generalized stringy Hodge numbers*) satisfying the conditions $\psi_0(\Sigma) = \psi_d(\Sigma) = 1$ and $\psi_{\alpha}(\Sigma) = \psi_{d-\alpha}(\Sigma)$ for all $\alpha \in [0, d] \cap \frac{1}{q_X} \mathbb{Z}$ and the *Gorenstein index* q_X is the smallest positive integer such that $q_X K_X$ is a Cartier divisor. Moreover, $\Delta_{-K_X} \subseteq M_{\mathbb{R}}$ denotes the d -dimensional rational polytope corresponding to the anticanonical divisor $-K_X$ of X defined as

$$\Delta_{-K_X} := \{y \in M_{\mathbb{R}} \mid \langle y, u_{\rho} \rangle \geq -1 \ \forall \rho \in \Sigma_{\Delta}(1)\} \subseteq M_{\mathbb{R}}$$

and $\Delta_{-K_X}^\sigma \preceq \Delta_{-K_X}$ a k -dimensional face of Δ_{-K_X} corresponding to a cone $\sigma \in \Sigma(d-k)$ defined as

$$\Delta_{-K_X}^\sigma := \{y \in \Delta_{-K_X} \mid \langle y, u_\rho \rangle = -1 \forall \rho \in \Sigma_\Delta(1) \text{ with } \rho \in \sigma\}$$

[BS17, Theorem 3.5], where $u_\rho \in N$ denotes the primitive ray generator of a 1-dimensional cone $\rho \in \Sigma_\Delta(1)$.

In this setting, the stringy Libgober-Wood identity is equivalent to the combinatorial identity stated in

Proposition 3.1 ([BS17, Theorem 4.3]). *Let $X := X_\Sigma$ be a d -dimensional \mathbb{Q} -Gorenstein projective toric variety of Gorenstein index q_X associated with a fan Σ of rational polyhedral cones in $N_{\mathbb{R}}$ and $-K_X$ an ample \mathbb{Q} -Cartier divisor. Then*

$$\sum_{\alpha \in [0, d] \cap \frac{1}{q_X} \mathbb{Z}} \psi_\alpha(\Sigma) \left(\alpha - \frac{d}{2} \right)^2 = \frac{d}{12} v(\Sigma) + \frac{1}{6} \sum_{\sigma \in \Sigma(d-1)} v(\sigma) \cdot v(\Delta_{-K_X}^\sigma),$$

where $v(\Sigma) := \sum_{\sigma \in \Sigma(d)} v(\sigma)$ denotes the normalized volume of a fan Σ and $v(\sigma)$ the normalized volume of a cone σ defined as the normalized volume of the polytope obtained as the convex hull of the origin and all primitive ray generators of the cone $\sigma \in \Sigma$.

Proof of Theorem B. We apply Proposition 3.1 to the canonical toric Fano threefold $X := X_\Delta$ with at worst canonical singularities corresponding to the canonical Fano polytope Δ of dimension 3. In this case, the associated fan Σ_Δ is the spanning fan of Δ , i.e., it consists of cones $\sigma_\theta = \mathbb{R}_{\geq 0}\theta$, where $\theta \preceq \Delta$ runs over all faces θ of Δ .

By construction of the fan Σ_Δ , it is easy to show that $v(\Sigma_\Delta) = v(\Delta)$. Moreover,

$$v(\sigma_\theta) = v(\theta)$$

for any 1-dimensional face $\theta \preceq \Delta$, because $v(\sigma_\theta) = v(\text{conv}(0, \theta)) = v(h_\theta) \cdot v(\theta)$, where h_θ denotes the height of the lattice triangle $\text{conv}(0, \theta)$ with base θ and $v(h_\theta) = 1$, because all nonzero lattice points of the lattice triangle $\text{conv}(0, \theta)$ are contained in its side θ .

By definition of the dual polytope Δ^* , every 1-dimensional face θ^* of Δ^* has lattice distance 1 to the origin. So one has $\Delta_{-K_X} = \Delta^*$ and $\Delta_{-K_X}^{\sigma_\theta} = \theta^*$ yielding

$$v(\Delta_{-K_X}^{\sigma_\theta}) = v(\theta^*).$$

Therefore, the right hand side of the stringy Libgober-Wood identity in Proposition 3.1 equals

$$\frac{3}{12} v(\Delta) + \frac{1}{6} \sum_{\substack{\theta \preceq \Delta \\ \dim(\theta)=1}} v(\theta) \cdot v(\theta^*)$$

and the number $v(\Delta)$ equals

$$E_{\text{str}}(X; 1, 1) = 2 + 2 \cdot (|\Delta \cap N| - 4) + \sum_{\substack{\theta \preceq \Delta \\ \dim(\theta)=2, n_\theta > 1}} v(\theta) \cdot \sum_{k=1}^{n_\theta-1} 1$$

[Bat98, Proposition 4.10]. The left hand side of the stringy Libgober-Wood identity in Proposition 3.1 can be computed by Theorem C as

$$2 \cdot 1 \left(\frac{3}{2}\right)^2 + 2 \cdot (|\Delta \cap N| - 4) \left(1 - \frac{3}{2}\right)^2 + \sum_{\substack{\theta \preceq \Delta \\ \dim(\theta)=2, n_\theta > 1}} v(\theta) \cdot \sum_{k=1}^{n_\theta-1} 1 \cdot \left(\frac{k}{n_\theta} - \frac{1}{2}\right)^2.$$

Comparing right and left hand sides, a short calculation yields

$$24 = 6 \cdot \sum_{\substack{\theta \preceq \Delta \\ \dim(\theta)=2, n_\theta > 1}} v(\theta) \cdot \sum_{k=1}^{n_\theta-1} \left(\frac{1}{4} - \left(\frac{k}{n_\theta} - \frac{1}{2}\right)^2\right) + \sum_{\substack{\theta \preceq \Delta \\ \dim(\theta)=1}} v(\theta) \cdot v(\theta^*)$$

and using Lemma 3.2 from below adds up to

$$\begin{aligned} 24 &= \sum_{\substack{\theta \preceq \Delta \\ \dim(\theta)=2, n_\theta > 1}} v(\theta) \left(n_\theta - \frac{1}{n_\theta}\right) + \sum_{\substack{\theta \preceq \Delta \\ \dim(\theta)=1}} v(\theta) \cdot v(\theta^*) \\ \Leftrightarrow 24 &= v(\Delta) - \sum_{\substack{\theta \preceq \Delta \\ \dim(\theta)=2}} \frac{1}{n_\theta} \cdot v(\theta) + \sum_{\substack{\theta \preceq \Delta \\ \dim(\theta)=1}} v(\theta) \cdot v(\theta^*), \end{aligned}$$

because $v(\Delta) = \sum_{\substack{\theta \preceq \Delta \\ \dim(\theta)=2}} v(\theta) \cdot n_\theta$. □

Lemma 3.2. *Let n be a positive integer. Then*

$$6 \cdot \sum_{k=1}^{n-1} \left(\frac{1}{4} - \left(\frac{k}{n} - \frac{1}{2}\right)^2\right) = n - \frac{1}{n}.$$

Proof. Applying the well-known formulas for $\sum_{k=1}^{n-1} k$ and $\sum_{k=1}^{n-1} k^2$, we get

$$\begin{aligned} 6 \cdot \sum_{k=1}^{n-1} \left(\frac{1}{4} - \left(\frac{k}{n} - \frac{1}{2}\right)^2\right) &= 6 \cdot \sum_{k=1}^{n-1} \left(\frac{1}{4} - \frac{k^2}{n^2} + \frac{k}{n} - \frac{1}{4}\right) = -\frac{6}{n^2} \cdot \sum_{k=1}^{n-1} k^2 + \frac{6}{n} \sum_{k=1}^{n-1} k \\ &= -\frac{1}{n^2} [(n-1)n(2(n-1)+1)] + \frac{3}{n} [(n-1)n] = n - \frac{1}{n}. \end{aligned}$$

□

REFERENCES

- [Bat94] Victor V. Batyrev, *Dual Polyhedra and Mirror Symmetry for Calabi-Yau Hypersurfaces in Toric Varieties*, Journal of Algebraic Geometry **3** (1994), no. 3, 493–535. [1](#), [2](#)
- [Bat98] ———, *Stringy Hodge numbers of varieties with Gorenstein canonical singularities*, Integrable systems and algebraic geometry (Kobe/Kyoto 1997) (1998), 1–31, World Sci. Publ., River Edge, NJ. [4](#), [5](#), [18](#)
- [Bat00] ———, *Stringy Hodge Numbers and Virasoro Algebra*, Mathematical Research Letters **7** (2000), no. 1-2, 155–164. [16](#)
- [Bat17] ———, *The stringy Euler number of Calabi-Yau hypersurfaces in toric varieties and the Mavlyutov duality*, arXiv:1707.02602v2. [3](#), [6](#), [7](#)
- [BCF⁺05] Matthias Beck, Beifang Chen, Lenny Fukshansky, Christian Haase, Allen Knutson, Bruce Reznick, Sinai Robins, and Achill Schürmann, *Problems from the Cottonwood Room*, Integer points in polyhedra – geometry, number theory, algebra, optimization, Contemp. Math., vol. 374, Amer. Math. Soc., Providence, RI, 2005, pp. 179–191. [2](#), [8](#)

- [BD96] Victor V. Batyrev and Dimitrios I. Dais, *Strong McKay correspondende, string-theoretic Hodge numbers and mirror symmetry*, *Topology* **35** (1996), no. 4, 901–929. 2
- [BS17] Victor V. Batyrev and Karin Schaller, *Stringy Chern classes of singular toric varieties and their applications*, *Communications in Number Theory and Physics* **11** (2017), 1–40. 4, 10, 16, 17
- [CG11] Alessio Corti and Vasily Golyshev, *Hypergeometric Equations and Weighted Projective Spaces*, *Science China Mathematics* **54** (2011), no. 8, 1577–1590. 15
- [Dan78] Vladimir I. Danilov, *The geometry of toric varieties*, *Uspekhi Mat. Nauk* **33** (1978), no. 2(200), 85–134, 247. 1
- [DHVW85] Lance J. Dixon, Jeffrey A. Harvey, Cumrun Vafa, and Edward Witten, *Strings on orbifolds*, *Nuclear Physics B* **261** (1985), 678–686. 4
- [Kas10] Alexander M. Kasprzyk, *Canonical toric Fano threefolds*, *Canadian Journal of Mathematics* **62** (2010), no. 6, 1293–1309. 1, 2, 3
- [Kho78] Askold G. Khovanskii, *Newton polyhedra and the genus of complete intersections*, *Funktsional. Anal. i Prilozhen.* **12** (1978), no. 1, 51–61. 3
- [KKN10] Alexander M. Kasprzyk, Maximilian Kreuzer, and Benjamin Nill, *On the combinatorial classification of toric log del Pezzo surfaces*, *LMS J. Comput. Math.* **13** (2010), 33–46. 10
- [KS98] Maximilian Kreuzer and Harald Skarke, *Classification of Reflexive Polyhedra in Three Dimensions*, *Advances in Theoretical and Mathematical Physics* **2** (1998), no. 4, 853–871. 2
- [LW90] Anatoly S. Libgober and John W. Wood, *Uniqueness of the complex structure on Kähler manifolds of certain homotopy types*, *Journal of Differential Geometry* **32** (1990), 139–154. 16
- [Rei83] Miles Reid, *Minimal models of canonical 3-folds*, *Algebraic varieties and analytic varieties* (Tokyo, 1981), *Adv. Stud. Pure Math.*, vol. 1, North-Holland, Amsterdam, 1983, pp. 131–180. 1
- [Ska96] Harald Skarke, *Weight systems for toric Calabi-Yau varieties and reflexivity of Newton polyhedra*, *Modern Phys. Lett. A* **11** (1996), no. 20, 1637–1652. 6
- [Whi64] George K. White, *Lattice tetrahedra*, *Canad. J. Math.* **16** (1964), 389–396. 13

MATHEMATISCHES INSTITUT, UNIVERSITÄT TÜBINGEN, AUF DER MORGENSTELLE 10, 72076 TÜBINGEN, GERMANY

E-mail address: victor.batyrev@uni-tuebingen.de

MATHEMATISCHES INSTITUT, UNIVERSITÄT TÜBINGEN, AUF DER MORGENSTELLE 10, 72076 TÜBINGEN, GERMANY

E-mail address: karin.schaller@uni-tuebingen.de