

# A short proof that sweeping is always possible for a spatial discretization with regular triangles and no hanging nodes

Thomas Camminady\*, Martin Frank  
 Karlsruhe Institute of Technology

May 13, 2022

## Abstract

Sweeping is a commonly used procedure to explicitly solve the discrete ordinates equation, which itself is a common approximation of the neutron transport equation. To sweep through the computational domain, an ordering of the spatial cells is required that obeys the flow of information. We show that this ordering can always be found, assuming a discretization of the spatial domain with regular triangles with no hanging nodes.

## 1 Introduction

Iterative methods for the numerical solution of transport processes often make use of sweeping to invert the streaming operator [1]. Sweeping requires to march through all spatial cells in a way that obeys the flow of information, prescribed by a direction  $\Omega$ . By that, a dependency between cells is induced which implies a dependency graph  $G$ . Here, two nodes  $i'$  and  $i$  share a directed edge, pointing from  $i'$  to  $i$ , if spatial cell  $C_i$  does depend on spatial cell  $C_{i'}$ . To be more precise:  $C_i$  depends on  $C_{i'}$ , if and only if they share an edge  $e_{i',i}$  and the inward pointing normal  $n_i$  (inward pointing with respect to cell  $C_i$ ) onto edge  $e_{i',i}$  satisfies  $\langle n_i, \Omega \rangle > 0$ . Fig. 1 shows a triangulation with labeled cells. For two different directions  $\Omega$ , Fig. 2 and 3 show the induced dependency for  $\Omega$  downward pointing and  $\Omega$  upward pointing, respectively. The inward and outward pointing normal vectors are sketched for a cell  $C_i$  in Fig. 4.

Every directed acyclic graph has a unique topological sorting [6]. This allows to march through the cells in a proper way, i.e. visiting cell  $C_i$  after visiting all cells that it depends on. We will show that the dependency graph  $G$  is indeed acyclic for a triangulation of regular triangles and no hanging nodes and sweeping is therefore always possible.

While a lot of research has focused onto the development of fast sweeping strategies, especially for parallel architectures [2, 3, 4, 5], the authors are not aware of a rigorous proof that sweeping is always possible under certain conditions.

---

\*Corresponding author: camminady@kit.edu

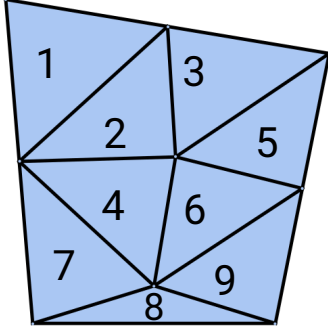

Figure 1: Triangulation of the computational domain with labels.

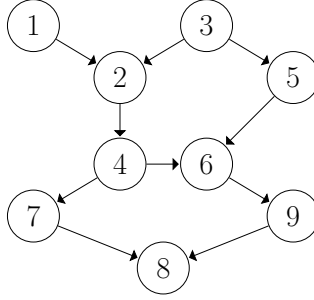

Figure 2: Induced dependency graph for  $\Omega = (0, -1)^T$ .

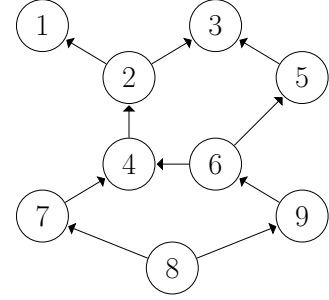

Figure 3: Induced dependency graph for  $\Omega = (0, +1)^T$ .

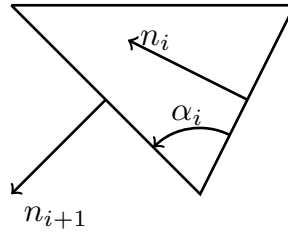

Figure 4: Incoming and outgoing normal vector for cell  $C_i$  and the corresponding angle  $\alpha_i$ .

## 2 Main Result

**Theorem 1.** Consider a domain that is discretized by a set of cells  $\{C_i\}_{i=1,\dots,I}$  where each cell  $C_i$  is a triangle and we do not allow for hanging nodes, shown in Fig. 5. Furthermore, we have a fixed direction  $\Omega$  that prescribes the flow of information. Under these conditions, sweeping is possible.

*Proof.* We know that sweeping is possible, if and only if the induced dependency graph  $G$  is acyclic. Now assume the dependency graph is not acyclic and provoke a contradiction.

If the dependency graph  $G$  is not acyclic, there exists a sequence of cells  $\{C_{i_1}, C_{i_2}, \dots, C_{i_M}, C_{i_1}\}$ , such that two consecutive cells share an edge  $e_{i_j, i_{j+1}}$  and  $\langle n_{i_j}, \Omega_k \rangle > 0, \forall j = 1, \dots, M$ . Without loss of generality, let  $i_j = j$  and assume that we pass through the cells in a counterclockwise manner as shown in Fig 6.

Now label the angles between  $n_i$  and  $n_{i+1}$  by  $\alpha_i$  as shown in Fig.4. A counterclockwise turn corresponds to  $\alpha_i > 0$  and a clockwise turn to  $\alpha_i < 0$ . We know that  $-\pi < \alpha_i < \pi$  as we consider regular triangles. Since we perform a full counterclockwise turn,  $\sum_{i=1}^M \alpha_i = 2\pi$ . Denote the angle between  $n_1$  and  $\Omega^\perp$  by  $\theta$  as sketched in Fig. 7, with  $0 < \theta < \pi$  and  $\Omega^\perp$  the vector normal to  $\Omega$ . Let  $R_{\alpha_i}$  be the rotation matrix that

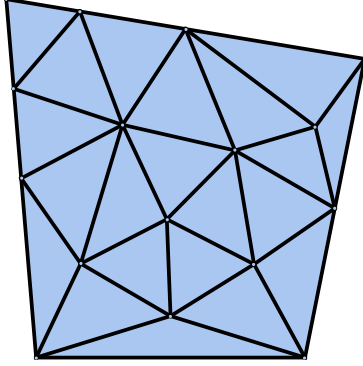

Figure 5: Triangulation of an arbitrary domain.

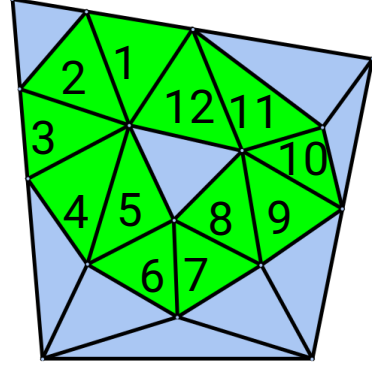

Figure 6: A cycle within the given triangulation.

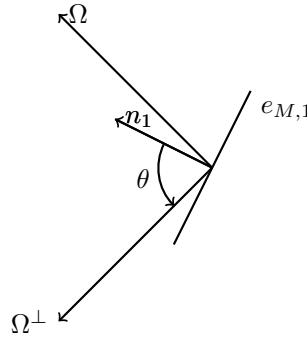

Figure 7: The normal  $n_1$ , with  $\Omega$  and  $\Omega^\perp$ , as well as the angle  $\theta$  between  $n_1$  and  $\Omega^\perp$ .

encodes rotating with magnitude  $\alpha_i$  around the  $z$ -axis. Then

$$n_{i+1} = R_{\alpha_i} n_i = \prod_{k=1}^i R_{\alpha_k} n_1 = R_{\sum_{k=1}^i \alpha_k} n_1.$$

If we turn  $n_1$  (counterclockwise) by more than  $\theta$  but less than  $\theta + \pi$ , then  $\langle n_1, \Omega \rangle < 0$ . However, there exist  $i^*$  such that  $\sum_{k=1}^{i^*-1} \alpha_k \leq \theta$ , but  $\theta < \sum_{k=1}^{i^*} \alpha_k < \theta + \pi < 2\pi$ , as  $-\pi < \alpha_{i^*} < \pi$ . Then  $n_{i^*+1}$  is  $n_1$  turned (counterclockwise) by more than  $\theta$ , but less than  $\theta + \pi$ . Therefore  $\langle n_{i^*+1}, \Omega \rangle < 0$  which contradicts the assumption and finishes the proof.  $\square$

### 3 The three dimensional case

The analogue setup for the three dimensional case would be a triangulation with tetrahedra, again with no hanging nodes. In general, allowing arbitrary convex quadrilaterals for the triangulation of a computational domain does not imply the absence of circular dependencies. This is sketched in Fig. 8. Quadrilaterals can be arranged in

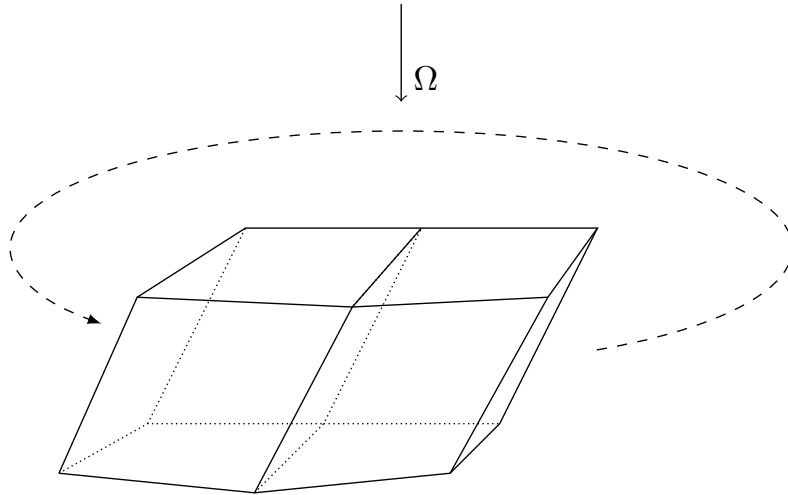

Figure 8: Quadrilaterals can be arranged in a circle such that no topological ordering can be obtained for  $\Omega = (0, 0, -1)^T$ .

a plane, perpendicular to the  $z$ -axis such that they form a circular dependency for a direction of flow along the  $z$ -axis.

For tetrahedra however, the authors assume the analogue result to hold as for the two dimensional case. In the absence of hanging nodes, sweeping should be possible. Turning the previous proof into a three dimensional version appears difficult, as rotation matrices no longer rotate around the same axis. Therefore different techniques have to be investigated to proof this claim.

## References

- [1] Marvin L Adams and Edward W Larsen. Fast iterative methods for discrete-ordinates particle transport calculations. *Progress in nuclear energy*, 40(1):3–159, 2002.
- [2] Teresa S Bailey and Robert D Falgout. Analysis of massively parallel discrete-ordinates transport sweep algorithms with collisions. Technical report, Lawrence Livermore National Laboratory (LLNL), Livermore, CA, 2008.
- [3] Randal S Baker and Kenneth R Koch. An sn algorithm for the massively parallel cm-200 computer. *Nuclear Science and Engineering*, 128(3):312–320, 1998.
- [4] Kenneth R Koch, Randal S Baker, and Raymond E Alcouffe. A parallel algorithm for 3d sn transport sweeps. *Technical Report*, 1992.
- [5] Kenneth R Koch, Randal S Baker, and Raymond E Alcouffe. Solution of the first-order form of the 3-d discrete ordinates equation on a massively parallel processor. *Transactions of the American Nuclear Society*, 65(108):198–199, 1992.
- [6] Steven S Skiena. Section 15.2: Topological sorting. *The Algorithm Design Manual (2nd ed.)*, Springer-Verlag, London, pages 481–483, 2008.