

QUASISYMMETRIC RIGIDITY IN ONE-DIMENSIONAL DYNAMICS

March 25, 2022

TREVOR CLARK AND SEBASTIAN VAN STRIEN

ABSTRACT. In the late 1980's Sullivan initiated a programme to prove quasimetric rigidity in one-dimensional dynamics: interval or circle maps that are topologically conjugate are quasimetrically conjugate (provided some obvious necessary assumptions are satisfied). The aim of this paper is to conclude this programme in a natural class of C^3 mappings. Examples of such rigidity were established previously, but not, for example, for real polynomials with non-real critical points.

Our results are also new for analytic mappings. The main new ingredients of the proof in the real analytic case are (i) the existence of infinitely many (complex) domains associated to its complex analytic extension so that these domains and their ranges are compatible, (ii) a methodology for showing that combinatorially equivalent complex box mappings are qc conjugate, (iii) a methodology for constructing qc conjugacies in the presence of parabolic periodic points.

For a C^3 mapping, the dilatation of a high iterate of any complex extension of the real map will in general be unbounded. To deal with this, we introduce dynamically defined *qc\bg partitions*, where the appropriate mapping has bounded quasiconformal dilatation, except on sets with 'bounded geometry'. To obtain such a partition we prove that we have very good geometric control for infinitely many dynamically defined domains. Some of these results are new even for real polynomials, and in fact an important sequence of domains turn out to be quasidisks. This technology also gives a new method for dealing with the infinitely renormalizable case.

We will briefly also discuss why quasimetric rigidity is such a useful property in one-dimensional dynamics.

CONTENTS

1. Introduction and statements of main results	2
1.1. Previous results	4
1.2. Applications of quasimetric rigidity	8
1.3. Necessity of assumptions	11
1.4. Statement of the main theorems	11
2. Ingredients of the paper and a sketch of the proof	17
2.1. Old and new ingredients of this paper	17
2.2. The QC Criterion and qc\bg mappings.	22
2.3. Sketch of the proof and organization of the paper	23
2.4. A guide to the paper	27

Date: March 25, 2022.

1991 *Mathematics Subject Classification.* Primary 37E05; Secondary 30D05.

The authors were supported by ERC AdG RGDD No 339523. Trevor Clark was supported in part by NSF EMSW21-RTG 1045119. The authors thank Lasse Rempe-Gillen, Daniel Smania and Davoud Cheraghi for several helpful comments, and would like to express their gratitude to Weixiao Shen for his many insightful remarks.

3.	Preliminary definitions, remarks and some tools	28
3.1.	Basic definitions and terminology	28
3.2.	Quasiconformal and quasisymmetric maps	30
3.3.	Asymptotically holomorphic mappings	31
3.4.	Poincaré disks	33
4.	Real dynamics	36
4.1.	A real partition	39
4.2.	Renormalizable maps	41
4.3.	A starting partition	42
4.4.	A decomposition of the set of critical points	43
4.5.	Real bounds, old and new	44
5.	Compatible complex box mappings and complex bounds	50
5.1.	Compatible complex box mappings and bounds at persistently recurrent points	51
5.2.	Compatible complex box mappings and bounds at reluctantly recurrent points	55
5.3.	Complex bounds for central cascades	57
5.4.	Chains without long central cascades	66
5.5.	The good nest and complex bounds	73
6.	Dynamics away from critical points: Touching box mappings	76
6.1.	Touching box mappings and petals at (possibly parabolic) periodic points	77
6.2.	Angle control in the presence of parabolic points	81
6.3.	Global touching box mappings	84
7.	Combinatorial equivalence and external conjugacies	87
7.1.	Existence of external conjugacies	88
7.2.	Rigidity of non-renormalizable analytic complex box mappings	89
7.3.	Restricting the puzzle to control dilatation	90
7.4.	Statement of the QC\BG Partition of a Central Cascade	92
7.5.	A Real Spreading Principle	94
7.6.	Central cascades, the proof of a QC\BG Partition of a Central Cascade	102
8.	Quasisymmetric rigidity	121
8.1.	The immediate basin of attraction of a periodic attractor	122
8.2.	The infinitely renormalizable, analytic case	124
8.3.	The infinitely renormalizable, C^3 case	126
8.4.	The persistently recurrent, finitely renormalizable case	136
8.5.	The reluctantly recurrent case	137
8.6.	Conclusion	138
9.	Table of notation and terminology	139
	References	139

1. INTRODUCTION AND STATEMENTS OF MAIN RESULTS

In this paper, we conclude a programme which was initiated by Sullivan in the late 1980's, see for example [Su1], [Su2] and [McM], namely that one has quasisymmetric rigidity in real one-dimensional dynamics. Around the same time, Herman asked a similar question for critical circle maps [He2]. Indeed we will prove that topologically conjugate smooth

mappings satisfying certain hypotheses are quasisymmetrically conjugate, see Theorem A in Section 1.4. For real-analytic maps this result implies the following.

Theorem 1.1 (QS-rigidity of real-analytic maps). *Let M be either $[0, 1]$ or S^1 and suppose that $f, \tilde{f}: M \rightarrow M$ are real-analytic, have at least one critical point or periodic point, and are topologically conjugate. Moreover, assume that the topological conjugacy is a bijection between*

- *the sets of parabolic periodic points,*
- *the sets of critical points,*

and that the orders of corresponding critical points are the same. Then f and \tilde{f} are quasisymmetrically conjugate.

In our approach to extending this result to C^3 mappings $f, \tilde{f}: M \rightarrow M$, where M is either $[0, 1]$ or S^1 , we will make use of complex tools. For these to be applicable, it is essential to assume that at each critical point c of f , $f(x) = \pm(\phi(x))^\ell + f(c)$, where ϕ is a local C^3 diffeomorphism, $\phi(c) = 0$, and $\ell \geq 2$ is an integer, and likewise at each critical point of \tilde{f} . Under these hypotheses, we have the following.

Theorem 1.2 (QS-rigidity of C^3 maps with no parabolic cycles). *Suppose that f and \tilde{f} are C^3 topologically conjugate mappings, as above, with no parabolic cycles. Assume that f and \tilde{f} each has at least one critical point or periodic point, that the conjugacy is a bijection between the sets of critical points of f and \tilde{f} , and that corresponding critical points have the same orders. Then f and \tilde{f} are quasisymmetrically conjugate.*

Remark 1.1. The assumption in Theorem 1.2 that neither f nor \tilde{f} has parabolic cycles can be removed under some weak additional smoothness and genericity assumptions, see Theorem A.

Remark 1.2. If $f, \tilde{f}: M \rightarrow M$ have periodic points, then we do not require that they have critical points. In particular, our theorems hold for interval maps and for covering maps of the circle of degree $\neq 1$. They also hold for maps $f, \tilde{f}: [0, 1] \rightarrow \mathbb{R}$, which are topologically conjugate on the non-escaping parts of their dynamics. For example, if $f: \mathbb{R} \rightarrow \mathbb{R}$ satisfies $|f(x)|/|x| \rightarrow \infty$ as $|x| \rightarrow \infty$, then there exists an interval $[a, b]$ so that $f(\{a, b\}) \subset \{a, b\}$ and $\lim_{n \rightarrow \infty} |f^n(x)| \rightarrow \infty$ for each $x \notin [a, b]$. Our theorems imply qs-rigidity of the non-escaping part of the dynamics.

Remark 1.3. Note that the parabolic multiplicity of corresponding parabolic points, that is, the order of contact at the parabolic points, does **not** need to be the same for the two maps.

Remark 1.4. For both analytic and smooth mappings, we obtain the quasisymmetric conjugacy as restriction of a quasiconformal mapping of the plane. In the analytic case, the qc mapping is a conjugacy on a necklace neighbourhood of the real line; however, for smooth mappings this is not the case.

Remark 1.5. Quasisymmetric mappings are Hölder, but they are not necessarily Lipschitz or even absolutely continuous. Indeed one can give examples of topologically conjugate mappings as in Theorem 1.1 for which no conjugacy satisfies these properties, see for example [BJ]. Moreover, it was proved in [MdM] that if two mappings with neither solenoidal nor wild attractors are conjugate by an absolutely continuous mapping, then they are C^2 conjugate, so that any conjugacy which fails to preserve multipliers is singular with respect

to Lebesgue measure. The condition that the mappings have neither solenoidal nor wild attractors is necessary. In [MoSm] it was proved that two Feigenbaum mappings with critical points of the same even order are always conjugate by an absolutely continuous mapping, and that provided that the degree is sufficiently high, the same is true for two Fibonacci mappings.

The above theorems are essentially optimal: in Subsection 1.3 we will show that the conditions in these theorems are all necessary in general. In particular, if f is a map of the circle, then rigidity in full generality, that is, of all maps, requires that f has at least one critical point.

1.1. Previous results. There has been substantial work on quasimetric rigidity over the past three decades.

1.1.1. *A summary of past results.* Let us briefly summarize the previous results on qs-rigidity:

- For polynomials, rigidity was, in general, only known for real polynomials with all critical points real.
- For analytic mappings, rigidity was only known in some special cases, and often the results were semi-local.
- For smooth mappings, rigidity was only known in a few very special cases.

Let us review these results.

1.1.2. *For polynomial maps,* the most general result which is known about qs-rigidity is the following:

Theorem 1.3 (Kozlovski-Shen-van Strien [KSvS1]). *Let f and \tilde{f} be real polynomials of degree d with only real critical points, which are all of even order. If f and \tilde{f} are topologically conjugate (as dynamical systems acting on the real line) and corresponding critical points have the same order, then they are quasiconformally conjugate on the complex plane (by a mapping preserving the real line).*

In [KSvS1], the assumption that all critical points are real is crucial. This assumption also implies that all attracting petals of parabolic periodic points lie along the real line (in fact, in [KSvS1] no details are given how to deal with parabolic points).

Prior to that paper, Yoccoz proved rigidity for all non-renormalizable quadratic polynomials, see [Hu]. Lyubich [Ly2] and Graczyk-Świątek [GS2] and [GS3], proved rigidity for all real quadratic polynomials. For an extension to the case of real-analytic unimodal maps with a quadratic critical point see the Appendix A of [ALdM].

The results of [Ly2], [GS2] and [GS3], rely on “decay of geometry,” a geometric feature of at most finitely renormalizable quadratic maps that does not hold even in the case of real polynomials of the form $z \mapsto z^d + c$ whenever $d > 2$. However, the Quasi-Additivity Law and Covering Lemma of [KL] made it possible to bring the theory of non-renormalizable unicritical mappings in the higher degree case up to the same level of development as in the quadratic case. Rigidity for unicritical, finitely renormalizable maps was proved in [AKLS], for general finitely renormalizable (not necessarily real) multicritical polynomials it was proved in [KvS], and for real infinitely renormalizable unicritical mappings it was proved in [C].

Let \mathbf{M}^d denote the set of parameters c such that the Julia set of the mapping $z \mapsto z^d + c$ is connected. The set \mathbf{M}^2 is the Mandelbrot set, and the set \mathbf{M}^d is often referred

to as a *Multibrot set*. In the families $z \mapsto z^d + c$, qc-rigidity is equivalent to the local connectivity of \mathbf{M}^d at the parameter c . This is due to an open-closed argument going back to Douady-Hubbard and Sullivan, and ideas of Yoccoz (see [Hu]). Local connectivity of \mathbf{M}^d remains unknown even in the case $d = 2$. However, progress on this problem for infinitely renormalizable quadratic maps $z \mapsto z^2 + c$, with c not necessarily real, has been made in two complementary settings: when there is a combinatorial condition on the renormalizations that make it possible to prove *a priori* bounds for the induced polynomial-like maps, see [K], [KL2], [KL3], [C], and when the (satellite) renormalizations satisfy certain combinatorial growth conditions, see [L1], [L2], [CSh]. It is shown in [DH1] that the conjecture that the boundary of the Mandelbrot set is locally connected implies density of hyperbolicity in the family $z \mapsto z^2 + c$. See [Sc] for the extension to the higher degree case.

The main theorem of our paper shows that the assumptions in Theorem 1.3 that all critical points are real, and that all critical points have even order, are both unnecessary to obtain a qs conjugacy on the non-escaping part of the dynamics on the real line. When there are complex critical points, it is not clear how to use the usual Yoccoz puzzle for a polynomial map, however, our methods make it possible to construct a complexified Markov partition for the real part of the dynamics. We should emphasise that, nevertheless, our result depends heavily on many techniques from [KSvS1].

1.1.3. *Semi-local results.* For real-analytic maps which are not polynomials, most previous results only assert the existence of a qs homeomorphism which is a conjugacy restricted to the post-critical set. One such result is due to Shen:

Theorem 1.4. [S2, Theorem 2] *Let f, \tilde{f} be real-analytic, topologically conjugate maps with only hyperbolic repelling periodic points, non-degenerate (quadratic) critical points and with essentially bounded geometry. Then there exists a qs homeomorphism which is a conjugacy restricted to the post-critical set of f and \tilde{f} .*

A map f is said to have *essentially bounded geometry* if there exists a constant C such that for any recurrent critical point c of f and any nice interval I containing c , $|I|/|\mathcal{L}_c(I)| \leq C$, where $\mathcal{L}_c(I)$ is the first return domain to I that contains c . See page 29 for the definitions of nice and $\mathcal{L}_c(I)$.

A similar result was proved jointly by Levin and the second author, namely that if f, \tilde{f} are real-analytic covering maps of the circle (of degree $d \geq 2$) with at most one critical point, then there exists a qs homeomorphism of S^1 which is a conjugacy restricted to the post-critical sets of f and \tilde{f} . If f, \tilde{f} have no parabolic or attracting periodic points, then in fact f, \tilde{f} are qs conjugate. For precise statements of these results see Theorem 1.12 in Section 1.1.6. We show that, in fact, all of these qs conjugacies on the post-critical sets extend to globally quasimetric conjugacies.

1.1.4. *Critical circle maps.* For real-analytic circle homeomorphisms with precisely one critical point, the first result about quasimetric rigidity was proved in the late 1980's by Herman, building on estimates due to Świątek, see [He2], [Swi] and also [P2]:

Theorem 1.5 (Herman-Świątek). *A real-analytic unicritical circle mapping with an irrational rotation number of bounded type, is quasimetrically conjugate to a rigid rotation of the circle.*

In the late 1990's this result was extended to

Theorem 1.6 ([dFdM1] Corollary 4.6). *Suppose that $h: S^1 \rightarrow S^1$ is a topological conjugacy between two real-analytic critical circle homeomorphisms f and \tilde{f} , each with precisely one critical point, c , \tilde{c} respectively, and $h(c) = \tilde{c}$. Then h is quasimetric.*

In an early version of this paper, we proposed an approach using our methods to treat critical circle maps with several critical points. Since then, a purely real argument has been found which solves this problem, so we do not develop this idea further here.

Theorem 1.7. [EdF] *Let f, \tilde{f} be two C^r ($r \geq 3$) multicritical circle homeomorphisms with the same irrational rotation number and the same number of non-flat critical points. Let $h: S^1 \rightarrow S^1$ be a homeomorphism of S^1 conjugating f and \tilde{f} , which maps critical points of f to critical points of \tilde{f} . Then h is quasimetric.*

Remark 1.6. As mentioned, the presence of at least one critical point is necessary in the previous theorem, because for circle diffeomorphisms the analogous statement is false. Indeed, one can construct diffeomorphisms for which some sequence of iterates has ‘almost a saddle-node fixed point’, resulting in larger and larger passing times near these points. This phenomenon is also referred to as ‘a sequence of saddle-cascades’. It was used by Arnol’d and Herman to construct examples of diffeomorphisms of the circle which are conjugate to irrational rotations, but where the conjugacy is not absolutely continuous, not qs and for which the map has no σ -finite measures, see for example Section I.5 in [dMvS] and Herman’s thesis, [He], Chapters VI and XII. In the diffeomorphic case, to get that the conjugacy is quasimetric or C^1 , one needs assumptions on the rotation number (to avoid these sequences of longer and longer saddle-cascades).

1.1.5. *Renormalization, universality and C^1 -rigidity.* Of course our result is related to the famous Feigenbaum-Couillet-Tresser renormalization conjectures, which were proved in increasing generality by Sullivan [Su2], McMullen [McM], Lyubich [Ly3], Avila-Lyubich [AL]. The specific version of this conjecture we are referring to is:

Theorem 1.8. *Let f, \tilde{f} be unimodal real-analytic maps which are infinitely renormalizable and of bounded type. Assume that f, \tilde{f} are topologically conjugate. Then there exists a $C^{1+\alpha}$ map which is a conjugacy restricted to the post-critical set of f and \tilde{f} .*

Smania has generalised this theorem to real-analytic, infinitely renormalizable mappings with bounded combinatorics, see [Sm1].

The previous theorem shows that the conjugacies between maps are even better than quasimetric along the post-critical set. We believe that a weaker version of the above C^1 -rigidity should also hold in the general case:

Conjecture 1.9. *In the setting of the main theorems, whenever $\omega(c)$ is minimal and has ‘bounded geometry’, the conjugacy is differentiable at each critical point c .*

Without the assumption of bounded geometry, the conjugacy is in general not differentiable: smooth unimodal Fibonacci maps with a critical point of order two need not be smoothly conjugate at the critical point, see [LM].

In fact, in the case of critical circle homeomorphisms with exactly one critical point, a stronger result is known. It was proved for analytic mappings by Khanin and Teplinsky [KT] and later extended to the smooth category by Guarino and de Melo [GdM].

Theorem 1.10 (Khanin-Teplinsky, Guarino-de Melo). *For critical circle mappings with one critical point we have the following:*

- [KT] *Let f and \tilde{f} be two analytic unicritical circle maps with the same order of critical points and the same irrational rotation number. Then f and \tilde{f} are C^1 -smoothly conjugate to each other.*
- [GdM] *Any two C^3 circle homeomorphisms f and \tilde{f} with the same irrational rotation number of bounded type and each with precisely one critical point, both of the same odd order, are $C^{1+\alpha}$ -smoothly conjugate, where $\alpha > 0$ is a universal constant.*

For C^4 mappings the following is known:

Theorem 1.11 ([GdMM]). *Let f and \tilde{f} be two C^4 unicritical circle maps with the same order of critical points and the same irrational rotation number. Let h be the unique topological conjugacy between f and \tilde{f} that maps the critical point of f to the critical point of \tilde{f} . Then:*

- *h is a C^1 diffeomorphism.*
- *h is $C^{1+\alpha}$ at the critical point, for a universal $\alpha > 0$.*
- *For a full Lebesgue measure set of rotation numbers, h is $C^{1+\alpha}$.*

By [A] even for analytic maps the theorem of [GdM] cannot be extended to circle maps with rotation number of unbounded type. We should note that these theorems build on earlier work of de Faria, de Melo and Yampolsky on renormalization of critical circle maps.

For general interval maps, one cannot expect conjugacies to be C^1 , because having a C^1 conjugacy implies that corresponding periodic orbits have the same multiplier. Moreover, suppose that f and \tilde{f} are C^3 maps of the interval with all periodic points hyperbolic repelling and no Cantor attractors. If the multipliers of corresponding periodic points of f and \tilde{f} are the same, then we have that f and \tilde{f} are C^3 conjugate, see [LiS1] and also [MdM].

1.1.6. *Covering maps of the circle.* For the case of covering maps of the circle one has the following theorem:

Theorem 1.12 (Levin-van Strien [LvS2]). *Assume that $f, \tilde{f}: S^1 \rightarrow S^1$ are topologically conjugate real-analytic covering maps of the circle (positively oriented) each with exactly one critical point of the same odd order and the conjugacy maps the critical orbit to the critical orbit. Then the following hold:*

- *if $\omega(c)$ is minimal, there exists a qs homeomorphism which is a conjugacy on the post critical set (and maps the critical point to the critical point);*
- *if f, \tilde{f} have only repelling periodic orbits, then the conjugacy is quasimetric.*

The main theorem in our paper shows that the assumption that there exists at most one critical point can be dropped, and we prove that there the conjugacy is a global quasimetric conjugacy even when there are parabolic points.

Note that in our main theorem (see Theorem A or Theorems 1.1, 1.2 above) we ask for the maps f and \tilde{f} to have the same number of critical points. Therefore, the set-up is different from the one in the following “linearization result” by Carsten Petersen [P3]:

Theorem 1.13 (Petersen). *Assume that $f: S^1 \rightarrow S^1$ is a degree $d \geq 2$ map which is a restriction of a Blaschke product, then f is qs conjugate to $z \mapsto z^d$ if*

- (1) *$\omega(c) \cap S^1 = \emptyset$ for each recurrent critical point, and*
- (2) *any periodic point in S^1 is repelling.*

Somewhat weaker results were derived in [dMvS, Exercise 6.2] and also in the Cornell thesis of L.K.H. Ma (1994). The assumption that $\omega(c) \cap S^1 = \emptyset$ for any recurrent critical point c ensures that f has no ‘almost saddle-nodes’ on the circle. Perhaps one could replace this assumption by a kind of ‘diophantine’ condition on the itinerary of the critical points of f (so that one does not need to have a globally defined rational map f in this theorem). But in any case, as was remarked in [LvS2], see Section 1.3, in general a real-analytic covering map of the circle of degree d (with critical points) is *not* qs conjugate to $z \mapsto z^d$ (on the circle $\{z \in \mathbb{C}; |z| = 1\}$). To see this, we can use Theorem C in [LvS2] to see that within any family, near every map without periodic attractors, there exists another map with a parabolic periodic point. Then use the argument given in Section I.5 in [dMvS].

If a real-analytic covering map of the circle with degree at least two has no critical points, then either it has periodic attractors (or parabolic periodic orbits) or some iterate of the map is expanding. This follows from a theorem of Mañé, for a simplified proof see [vS] or Section III.5 in [dMvS]. From this it is easy to see that any such map which has no attracting or parabolic periodic orbits is qs conjugate to $z \mapsto z^d$. The Main Theorem describes a more general setting in which covering maps of the circle can be qs conjugate, even when there are parabolic periodic points. A special case in the analytic setting was considered in [LPS].

1.1.7. *Quasisymmetric rigidity for smooth maps.* For unimodal Misiurewicz mappings and more generally for geometrically finite mappings under various conditions, for example negative Schwarzian derivative or absence of parabolic points, it was proved in [J], [Ji] and [dMvS, Exercise 6.2].

To tackle the problem of smooth mappings with more general combinatorics we use asymptotically holomorphic extensions of smooth mappings. The specific extension that we use was constructed in [GSS]. Asymptotically holomorphic extensions were previously used in [Ly1] to prove rigidity of smooth mappings with Fibonacci combinatorics and a quadratic critical point using exponential decay of geometry. They were also used in [JS] to show quasisymmetric rigidity for certain unimodal maps “close to the Chebyshev polynomial at all levels”.

Using entirely real methods, Pałuba proved a Lipschitz rigidity result for Feigenbaum maps [Pa].

Remark 1.7. As a historical comment, Jiang [Ji] refers to lecture notes from 1987 where Sullivan discusses the problem of quasisymmetric rigidity in one-dimensional dynamics. Sullivan always had in mind to use qs-rigidity of smooth maps to analyze the structure of smooth dynamical systems. In this paper we make a key step in this endeavor, see the next subsection.

1.2. Applications of quasisymmetric rigidity. The main motivation for proving quasisymmetric rigidity stems from the fact that this property allows one to use tools from complex analysis, such as the Measurable Riemann Mapping Theorem to study the dynamics of real-analytic maps. For example, it turned to be a crucial step towards proving the following types of results:

1.2.1. *Quasiconformal surgery.* Theorem 1.5 allows one to use quasiconformal surgery to prove the existence of quadratic Siegel polynomials for which the Julia set is locally connected. See the work of Ghys, Shishikura, Herman and others, see for example [P1] and [BF].

1.2.2. *Density of hyperbolicity.* Quasisymmetric rigidity is one of the key tools for proving density of hyperbolic dynamics in dimension-one. Hyperbolicity is dense within the space of smooth maps. For the unimodal case see [GS2], [GS3], [Ly2], [Ko], and for the general (real) multimodal case see [KSvS1] and [KSvS2]. Density of hyperbolicity is also known within certain spaces of real transcendental maps and in the Arnol'd family, see [RvS1] and [RvS2].

1.2.3. *Monotonicity of entropy.* Using quasisymmetric rigidity, monotonicity of entropy for real polynomials with only real critical points was proved in [BvS]. In the quadratic case this was shown by quite a few people, see [D], [DH1] [MT], [T] and [dMvS, II. 10], for the cubic case see [MTr]. Monotonicity of topological entropy in certain families of transcendental maps, such as $[0, 1] \ni x \mapsto a \sin(\pi x)$ was proved in [RvS2].

1.2.4. *Hyperbolicity of renormalization.* Quasisymmetric rigidity plays an important role in the proof of hyperbolicity of renormalization. Rigidity is a key ingredient in understanding the structure of the renormalization horseshoe and the stable leaves of the renormalization operator, see [Su2], [McM3], [Ly3] and [AL]. Moreover, in the proof of hyperbolicity of renormalization, quasiconformal rigidity is used in conjunction with the Small Orbits Theorem to prove that renormalization is exponentially expanding in the direction transverse to the hybrid class of an infinitely renormalizable unimodal mapping, [Ly3] and [Ly4]. This argument requires knowing quasiconformal rigidity of complex mappings, and is also used in [Sm2] to prove hyperbolicity of the Fibonacci renormalization. An infinitesimal version of this argument, which only requires rigidity for real mappings, is used in [Sm4] to prove hyperbolicity of renormalization for multimodal mappings with bounded combinatorics.

1.2.5. *Connectedness of conjugacy classes.* One of the main goals of dynamical systems is to classify and understand the conjugacy classes of dynamical systems. It is natural to ask whether conjugacy classes of mappings are connected. This is proved in certain families of polynomials in [BvS] and [CS].

Using the Measurable Riemann Mapping Theorem, one can prove that the hybrid classes in the space of polynomial-like germs are connected, [Ly3]. Using quasiconformal rigidity one can show that the topological conjugacy classes coincide with the hybrid conjugacy classes, and thus obtain that topological conjugacy classes of polynomial-like germs are connected. Using the same argument, this result also holds for the germs of non-renormalizable persistently recurrent complex box mappings, [Sm2, KvS]. For real analytic mappings, it is proved in [ALdM] that the conjugacy class of a non-renormalizable mapping with a quadratic critical point is connected. This result exploits the “decay of geometry” for non-renormalizable quadratic mappings.

The rigidity result of this paper can be used to prove that the topological conjugacy class of a real analytic mapping of the interval with no parabolic cycle is connected. The proof of this and related results will be given in a forthcoming paper.

1.2.6. *Conjugacy classes are manifolds.* Sullivan conjectured the following:

Conjecture. Conjugacy classes of analytic (smooth) mappings with all periodic orbits hyperbolic on the interval are analytic (smooth) connected manifolds.

We expect that our results will be an essential ingredient in the proof.

Using transversality results, it is known that the set of rational (non-Lattès) mappings satisfying critical relations of the form $f^{k_i}(c_i) = f^{k_j}(c_j)$ are manifolds, [Ep],[LSvS1]. Going

beyond rational mappings, this result is proved for certain interval mappings with a flat critical point in [LSvS2]. These results imply that the topological conjugacy classes of critically finite rational maps are analytic manifolds, namely points. But in the space of rational maps, critically finite (non-Lattès) mappings are singletons by Thurston Rigidity [DH2], so the fact that these are manifolds is rather trivial.

To prove similar results in more general settings rigidity is vital. For a real quadratic-like mapping it is shown in [DH1], that the conjugacy class of a real quadratic-like mapping is an infinite dimensional, complex analytic manifold, and moreover, it has co-dimension one in the space of quadratic-like mappings [Ly3]. The proof that it is an analytic manifold uses the identification of the hybrid class of a polynomial-like mapping with the space of analytic expanding circle mappings. Because of rigidity, the hybrid class is the same as the topological conjugacy class.

Going beyond polynomial-like mappings, in [ALdM] it is proved that the topological conjugacy class of certain analytic unimodal mappings with a non-degenerate critical point is an analytic manifold; additionally one needs to assume either that the mappings are quasi-quadratic that they have all periodic orbits hyperbolic, see [AM2]. This result is extended to the higher degree case in [Cl]. For smooth mappings, using the fact that topological conjugacy classes are stable manifolds of the renormalization operator, in [dFdMP] it is proved that the topological conjugacy classes of unimodal C^4 mappings that are infinitely renormalizable of bounded type are C^1 manifolds.

The previous results rely heavily on complex analytic machinery, so for smooth mappings, the strategy of any proof of Sullivan's Conjecture would require substantial modifications. Indeed, if two smooth mappings on the interval are topologically conjugate, but one has a repelling periodic point off the real line where the mapping is conformal and the other mapping is not conformal at the corresponding point, then the two mappings cannot be qc-conjugate in a complex neighbourhood of the interval that contains the repelling point. (Nevertheless, they are qs-conjugate on the interval.)

Sullivan had another rationale for asking the question about quasiconformal or quasisymmetric rigidity, as this fits in his famous Sullivan dictionary, relating results in complex dynamics, with results about Kleinian groups and three manifolds, see for example [McM2]. Sullivan's point of view is that conjugacy classes of dynamical systems can be treated as infinite dimensional Teichmüller spaces. The Teichmüller pseudometric on a conjugacy class of an interval mapping is defined as

$$\text{dist}(f, \tilde{f}) = \inf \|\mu_h\|_\infty,$$

where μ_h denotes the dilatation of a qc mapping h and the infimum is taken over all quasiconformal extensions to the plane of qs conjugacies between f and \tilde{f} .

1.2.7. Palis conjecture. The Palis conjecture is a far reaching conjecture about the typical dynamics, from the measurable point of view, that occur in dynamical systems. The Palis Conjecture has been proved in dimension-one for analytic unimodal mappings. It was first proved in the celebrated result of Lyubich: almost every real quadratic mapping is regular or stochastic [Ly4]. This result was generalized to families of analytic quadratic mappings in [ALdM]. For higher degree mappings in [BSvS] it is proved that in a one-parameter family of real unimodal polynomials, almost every mapping has a unique physical measure that is supported on the real line. The regular or stochastic theorems were generalized to higher degree unimodal mappings in [ALS] and [Cl]. These results can be improved to obtain

that almost every mapping in a generic analytic family of unimodal mappings, is regular or Collet-Eckmann, [AM1],[AM2], and it can be shown that various other good properties hold for almost every such mapping [AM3]. Quasisymmetric rigidity plays a crucial role in the proofs of these results. As we already mentioned, it is used in the proof of hyperbolicity of renormalization, which is the key ingredient in the proof that infinitely renormalizable mappings have measure zero in generic analytic families of unimodal mappings. Moreover, it plays an important role in the proof that the conjugacy classes of analytic unimodal mappings are complex analytic Banach manifolds. This result is used to transfer metric information (*a priori* bounds) from the dynamical plane to the parameter plane, where it is used in parameter-exclusion arguments.

1.3. Necessity of assumptions. In general, all the assumptions in the theorem are necessary to have a quasisymmetric, or indeed even a Hölder, conjugacy between f and \tilde{f} .

(i) To see that we cannot drop the assumption that the critical points should have the same order, consider two maps $f(z) = z^2 + c$ and $\tilde{f}(z) = z^a + c'$ with $a \geq 4$ and parameters c and c' chosen so that f and \tilde{f} both have the same, Fibonacci, combinatorics. (So that the close return times of the critical point to itself occur at the Fibonacci numbers; these are the fastest possible returns when there are no central returns.) Iterates of the critical point of f and \tilde{f} accumulate to 0 at different rates. Indeed, let S_n be the Fibonacci sequence $1, 2, 3, 5, 8, \dots$, then $f^{S_n}(0)$ converges to 0 at a geometric rate, and $\tilde{f}^{S_n}(0)$ at a polynomial rate, see [BKNvS]. So f and \tilde{f} are topologically conjugate, but not qs conjugate. Note that it is not known whether two Fibonacci maps of the form $f(z) = z^d + c$ and $\tilde{f}(z) = z^{d'} + c'$ with $d \neq d'$ both large are qs-conjugate.

(ii) Critical points of *odd order* are *invisible* from a 'real' point of view; however, they can have rather important consequences for the rate of recurrence. For example, there exist f, \tilde{f} degree 2 covering maps of the circle, f with an odd critical point, and \tilde{f} everywhere expanding, that are necessarily topologically conjugate (because neither of them has wandering intervals), but that are not qs conjugate: one can construct the map f , real-analytic, with a critical point so that it has longer and longer saddle-cascades.

(iii) It is necessary to assume that the topological conjugacy maps parabolic periodic points to parabolic periodic points, since the local escape rate near a hyperbolic periodic point is completely different from the rate near a parabolic periodic point (the former is geometric, the latter is polynomial).

(iv) As mentioned, it is necessary to assume in the case of circle homeomorphisms, that the maps have at least one critical point. In fact, if $f: S^1 \rightarrow S^1$ is non-monotone, then it automatically has periodic orbits, see Proposition 4.7.

(v) Although we have no proof that qs-rigidity does not hold for C^2 maps, we believe that it should be possible to construct counter examples to our Main Theorem when one has longer and longer saddle-cascades (in the C^2 case, one has much weaker distortion and cross-ratio control).

1.4. Statement of the main theorems.

1.4.1. *The class of maps.* We let $\mathcal{C} = \mathcal{C}(M)$ denote the set of maps $f: M \rightarrow M$ with the following properties:

- (1) f is C^3 on (a neighbourhood of) M ;

- (2) f has finitely many critical points all with **integer orders**; that is, if c_i is a critical point of f , then we can express

$$f(x) = \pm(\phi_i(x))^{d_i} + f(c_i),$$

where ϕ_i is a local diffeomorphism near c_i of class C^3 , $\phi_i(c_i) = 0$, and $d_i \in \{2, 3, \dots\}$;

- (3) if p is a periodic point of period n and multiplier $\lambda = \pm 1$, then the Taylor expansion of f^n at p is given by

$$f^n(x) = p + \lambda(x - p) + a(x - p)^{d+1} + R(|x - p|),$$

in a real neighbourhood of p and $a \in \mathbb{R}$, where $R = o(|x - p|^{d+1})$, and as usual $o(t)/t \rightarrow 0$ as $t \rightarrow 0$. We call d the *parabolic multiplicity* of the parabolic periodic point.

The set \mathcal{C} includes all C^3 maps without parabolic periodic points, all C^3 maps with parabolic points which all have parabolic multiplicity 2, and all analytic maps. Notice that condition (3) implies that f can have at most finitely many parabolic cycles.

1.4.2. Statement of the main theorem.

Theorem A. *Suppose that $f, \tilde{f}: [0, 1] \rightarrow [0, 1]$, or alternatively that $f, \tilde{f}: S^1 \rightarrow S^1$, each has at least one periodic point, are in \mathcal{C} . Suppose that f and \tilde{f} are topologically conjugate and moreover, assume that the topological conjugacy is a bijection between*

- *the sets of critical points,*
- *the set of parabolic periodic points,*

and the orders of corresponding critical points are the same. Then f and \tilde{f} are quasimetrically conjugate.

As we observed in Theorem 1.7 this theorem holds for critical circle maps without periodic points. Because of [EdF], we do not give an independent proof of this fact.

This result implies Theorem 3.8 of [RvS2], where it was stated for analytic mappings of the interval $[a, b]$ such that $f(\{a, b\}) \subset \{a, b\}$.

A straightforward application of the techniques in this paper implies the following result that is useful in applications: Suppose that $f, \tilde{f}: M \rightarrow M$ are mappings of class \mathcal{C} as in the statement of Theorem A. Suppose that N is a union of intervals in M and that N' is a union of intervals $J' \subset N$ such that for each interval J' , there exists $k_{J'} \geq 1$ such that $f^{k_{J'}}(J') \subset N$ and that $f^{k_{J'}}$ does not have a critical point on $\partial J'$. Suppose that we have the same objects for the mapping marked with a tilde. Define $F: N' \rightarrow N$ by $F|_{J'} = f^{k_{J'}}|_{J'}$ and $\tilde{F}: \tilde{N}' \rightarrow \tilde{N}$ by $\tilde{F}|_{\tilde{J}'} = \tilde{f}^{k_{\tilde{J}'}}|_{\tilde{J}'}$.

Theorem A'. *If $F: N' \rightarrow N$ and $\tilde{F}: \tilde{N}' \rightarrow \tilde{N}$ are topologically conjugate by a mapping $h: M \rightarrow M$ that is order preserving on M and the conjugacy is a bijection between the sets of parabolic periodic points, and the sets of critical points and corresponding critical points have the same order, then F and \tilde{F} are qs-conjugate.*

We believe that the techniques that we develop will be useful in other contexts, so even though some of these theorems are quite technical, we state them here.

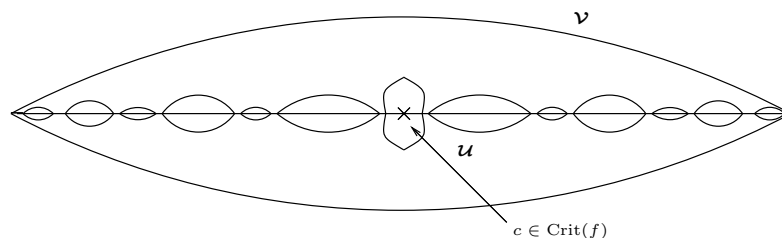

FIGURE 1. A complex extension of the real return mapping where the range is a Poincaré lens domain.

1.4.3. *Complex bounds theorems: the general case.* To prove Theorem A, we make use of various complex extensions of f . Close to a critical point of f , we use usual *complex box mappings*, see page 50 for the definition. These were constructed for asymptotically holomorphic extensions of smooth mappings at persistently recurrent critical points in [CvST], and at reluctantly recurrent critical points for analytic mappings with only even critical points in [KSvS2]. See page 51 for the definitions of the gap and extension properties.

In the *persistently recurrent* case we build on [CvST], we prove the following, see Theorem 5.2:

Theorem B. *Suppose that c_0 is a persistently recurrent critical point of f , at which f is at most finitely renormalizable, and let Ω_1 denote the set of critical points in $\omega(c_0)$. Then there exist arbitrarily small, combinatorially defined real neighbourhoods \mathcal{I} of Ω and $m \in \mathbb{N}$, such that the return mapping $R_{\mathcal{I}}^m: \text{Dom}^*(\mathcal{I}) \rightarrow \mathcal{I}$ extends to a complex box mapping*

$$F_{it}: \mathcal{U}_{it} \rightarrow \mathcal{V}_{it}$$

such that \mathcal{V}_{it} is a union of Poincaré lense domains, $(\mathcal{V} \setminus \mathcal{U}) \cap \mathbb{H}^+$ is a quasidisk and this complex box mapping satisfies the gap and extension properties.

Let us point out that in this theorem, the box mapping has infinitely many branches, since we do not restrict to components of the domain that intersect the post-critical set, and the range is a Poincaré lens domain, see Figure 1.

In the *reluctantly recurrent* case, building on [KSvS2] we construct complex box mappings about reluctantly recurrent critical points. This result is new even in the analytic case, since we allow for odd critical points. Let us give a rough statement of the theorem here, see Theorem 5.3 for a precise statement.

Theorem C. *Let Ω_r denote the set of reluctantly recurrent critical points of f . Then there exist arbitrarily small combinatorially defined real neighbourhoods \mathcal{I} of Ω_r such that the return mapping to \mathcal{I} extends to a complex box mapping $F: \mathcal{U} \rightarrow \mathcal{V}$ where \mathcal{V} is a union of Poincaré lens domains, $(\mathcal{V} \setminus \mathcal{U}) \cap \mathbb{H}^+$ is a quasidisk and this complex box mapping satisfies the gap and extension properties.*

The key results used in the proof of this theorem are the real bounds at reluctantly recurrent critical points, Proposition 4.14.

This result, together with the complex bounds of [CvST], implies Theorem 3.9 of [RvS2].

1.4.4. *Touching box mappings.* The previous two theorems provide us with control near the critical points of f , but we need a tool that will make it possible to construct a qs conjugacy

on all of $M = [0, 1]$ or S^1 . To do this, we make use of *touching box mappings*, see page 84 for the definition. Figure 2 depicts a touching box mapping.

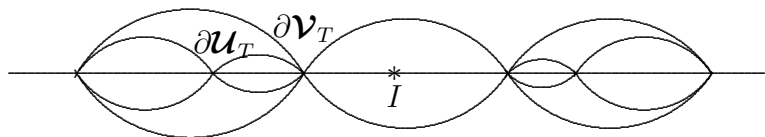

FIGURE 2. A touching box mapping $F_T: \mathcal{U}_T \rightarrow \mathcal{V}_T$: the domain does not contain critical points of f (marked with the symbol $*$).

Informally a touching box mapping is a complex box mapping $F_T: \mathcal{U}_T \rightarrow \mathcal{V}_T$ such that F_T is a diffeomorphism on each component of its domain, \mathcal{V}_T is a union of finitely many Poincaré lens domains that form a necklace neighbourhood of M , \mathcal{U}_T has finitely many components, $\mathcal{U}_T \subset \mathcal{V}_T$, but not compactly, and the intersection points of $\partial\mathcal{U}_T$ and $\partial\mathcal{V}_T$ are only along the real line at points where components of \mathcal{U}_T and \mathcal{V}_T meet tangentially. If the mapping has a parabolic periodic point, then we choose \mathcal{V}_T so that it contains the parabolic cycle in its boundary. This makes it possible to use a local analysis near the parabolic points to construct a conjugacy there. We construct touching box mappings in Theorem 6.6.

One consequence of this Theorem is rigidity away from critical points, see Corollary 6.7.

Theorem D. *Suppose that f and \tilde{f} are of class \mathcal{C} and that h is a topological conjugacy between f and \tilde{f} as in Theorem A. Let \mathcal{I} , a union of intervals, be a combinatorially defined neighbourhood of $\text{Crit} f$ and let $\tilde{\mathcal{I}}$ be the corresponding neighbourhood for \tilde{f} . Let $E(\mathcal{I})$ denote the set of points whose orbits avoid \mathcal{I} . Then $h|_{E(\mathcal{I})}$ is quasimetric.*

This Theorem immediately implies qs-rigidity for mappings with periodic points and no critical points, for example, topologically expanding maps of the circle with degree at least 2; here $E(\mathcal{I})$ may contain parabolic cycles.

Remark 1.8. After proving that we can construct an initial external conjugacy between f and \tilde{f} for the complex box mappings near the critical points, see Theorem 7.1, we can almost argue as in [KSvS1] to prove Theorem 1.1, qs-rigidity, in the analytic case.

1.4.5. *Quasidisks.* Long cascades of central returns are one of the main reasons why the argument from the analytic case does not go through for smooth mappings. One step towards dealing with this issue is proving that certain puzzle pieces are quasidisks; these puzzle pieces are obtained by a modification of the construction of the enhanced nest, [KSvS1]. See Section 5.3 and Proposition 5.12 for the details. We also prove that puzzle pieces from the enhanced nest are quasidisks, something that was neither proved nor needed in [KSvS1].

Theorem E. *There exists $\delta > 0$ such that the following holds.*

- *Suppose that*

$$\mathbf{V}^m \supset \mathbf{V}^{m+1} \supset \dots \supset \mathbf{V}^{m+n+1}$$

is long, maximal, cascade of central returns for a complex box mapping $F: \mathcal{U} \rightarrow \mathcal{V}$. Then there exists a puzzle piece \mathbf{E} such that $\mathbf{V}^{m+2} \subset \mathbf{E} \subset \mathbf{V}^m$ and \mathbf{E} is a \mathbf{E} is δ -nice and a $1 + 1/\delta$ -quasidisk.

- *If \mathbf{E} is a puzzle piece from the enhanced nest, then \mathbf{E} is a $1 + 1/\delta$ -quasidisk.*

See page 51 for the definition of δ -nice.

1.4.6. *QC control along real pullbacks.* Since we work with asymptotically holomorphic extensions of smooth mappings, we need a tool to the dilatation. Let us give informal statements of our results here. We control the dilatation of pullbacks along the real line that do not pass through long cascades of central returns, see Propositions 5.16 and 7.4. Here we build on the work of [LiS3], and we use the real bounds of [vSV1] as we pullback from one non-central return to the next. Roughly Proposition 5.16 can be stated as:

Theorem F. *Suppose that $F: \mathcal{U} \rightarrow \mathcal{V}$ is a complex box mapping. Suppose that $\{\mathbf{G}_j\}_{j=0}^s$ is a chain of puzzle pieces that does not contain a long cascade of central returns, then*

$$\sum_{j=0}^s \text{diam}(\mathbf{G}_j)^2 < C,$$

and $C \rightarrow 0$ as $\max_{\mathbf{V} \subset \mathcal{V}} \text{diam}(\mathbf{V}) \rightarrow 0$, where the maximum is taken over connected components \mathbf{V} of \mathcal{V} .

A central return in a chain of puzzle pieces occurs when there exists a critical point c of f such that $c \in \mathbf{G}_{i_2} \subset \mathbf{G}_{i_1} \subset \mathbf{G}_{i_0}$, \mathbf{G}_{i_2} is a first return domain to \mathbf{G}_{i_1} , \mathbf{G}_{i_1} is a first return domain to \mathbf{G}_{i_0} and $R_{\mathbf{G}_{i_0}}|_{\mathbf{G}_{i_1}}(c) \in \mathbf{G}_{i_1}$. In other words, the return time of \mathbf{G}_{i_2} to \mathbf{G}_{i_1} is the same as the return time of \mathbf{G}_{i_1} to \mathbf{G}_{i_0} .

Assume that $V^m \supset V^{m+1} \supset \dots \supset V^{m+n+1}$ is a central cascade of intervals. Suppose that (a_0, b_0) is a component of $\text{int}(V^m \setminus V^{m+1})$, and let $(a_k, b_k), k \leq n$ be a component of $\text{int}(V^{m+k} \setminus V^{m+k+1})$, such that $R_{V^m}^k: (a_k, b_k) \rightarrow (a_0, b_0)$ is a diffeomorphism. An important step in the proof of Theorem F is controlling the sum $\sum_{j=0}^k \text{diam}(\mathbf{G}_j)^2$ when $\mathbf{G}_0 \cap (a_k, b_k) \neq \emptyset$ and k is arbitrarily large. To do this we use Theorem E, which implies that \mathbf{G}_k is contained in a Poincaré disk $D_\theta(a_0, b_0)$ with θ bounded away from zero, and then the bound on $\sum_{j=0}^k \text{diam}(\mathbf{G}_j)^2$ follows.

1.4.7. *The good nest.* We adapt the construction of good nest of puzzle pieces [AKLS] to the multicritical setting and prove complex bounds for this nest of puzzle pieces, see the definition on page 73, Proposition 5.18, Corollary 5.19 and Proposition 5.22. The next theorem, which summarizes these results, gives complex bounds on a much finer nest of puzzle pieces than the enhanced nest.

Theorem G. *There exists $\delta > 0$ such that the following holds. Suppose that $F: \mathcal{U} \rightarrow \mathcal{V}$ is a complex box mapping. Let*

$$\mathbf{V}^0 \supset \mathbf{W}^0 \supset \mathbf{V}^1 \supset \mathbf{W}^1 \supset \mathbf{V}^2 \supset \dots$$

be the good nest of puzzle pieces about $\text{Crit}F$. Then for each $n \geq 0$ and each critical point c of F the following hold:

- $\text{mod}(\mathbf{V}_c^n \setminus \mathbf{W}_c^n) \geq \delta$,
- \mathbf{V}_c^n has bounded geometry at the critical point,
- \mathbf{W}^n is δ -nice.

See page 29 for the definition of δ -bounded geometry and page 51 for the definition of δ -nice.

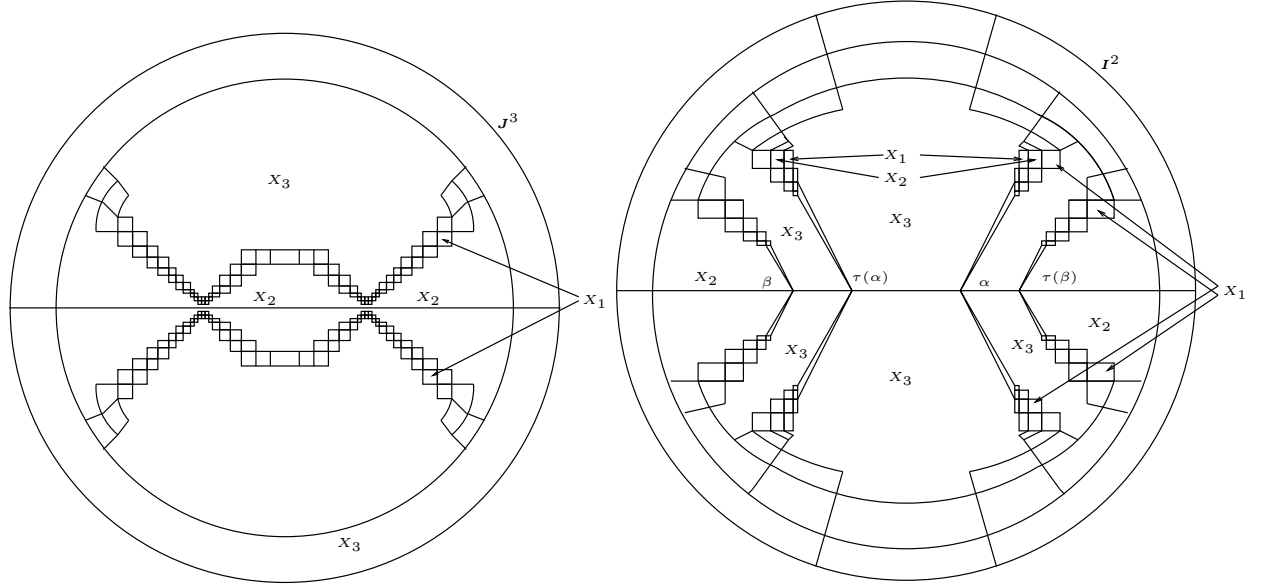

(A) A qc\bg partition of a saddle-node cascade. (B) A qc\bg partition after a renormalization, $F: \mathbf{V}^1 \rightarrow \mathbf{V}^0$.

FIGURE 3. X_1 are pieces with bounded geometry, X_2 are pieces where the qc mapping is defined dynamically and X_3 are pieces that are K_1 -quasidisks. The thin triangles in (B) are built from small topological squares, but we do not show that level of detail. In (B), we can avoid using the set X_1 since we can show that the boundary maps are uniformly quasiasymmetric

1.4.8. *QC\BG partitions.* Motivated by the QC Criterion of [KSvS1], we say that a mapping is (K, δ) -qc\bg if it is K -qc except on a set where one has *bg* (bounded geometry, depending on δ). See page 23 for the precise definition.

Theorem E is an important step in the proof of a QC\BG Partition of a central cascade. Let us give an informal statement here. See Theorem 7.5 for a precise statement and Figure 3 for an illustration. A similar partition is also used to glue together conjugacies that are made between renormalization levels of an infinitely renormalizable mapping, see Lemmas 8.12 and 8.13.

Theorem H (QC\BG Partition of a Central Cascade). *There exist $K_1, K \geq 1$ and $\delta > 0$ such that the following holds: Let $\mathbf{E} \ni c_0$ be a puzzle piece given by Theorem E, and let $\tilde{\mathbf{E}}$ be the corresponding piece for \tilde{f} . There exists a (K, δ) -qc\bg mapping $H: \mathbf{E} \rightarrow \tilde{\mathbf{E}}$ and a partition of \mathbf{E} into subsets $X_0 \cup X_1 \cup X_2 \cup X_3 \cup \mathcal{O}$, and similarly for the objects marked with a tilde, such that the following holds:*

- $H(X_i) = \tilde{X}_i$ for $i = 0, 1, 2, 3$, and $H(\mathcal{O}) = \tilde{\mathcal{O}}$.
- \mathcal{O} is a neighbourhood of the set of critical points of $R_{\mathbf{E}}|_{\mathcal{L}_{c_0}(\mathbf{E})}$, and $H|_{\mathcal{O}}$ is K -qc.
- X_0 has measure 0 and (2.1) holds at each $x \in X_0$.
- If \mathbf{P} is a connected component of X_1 and $\tilde{\mathbf{P}} = H(\mathbf{P})$ then both \mathbf{P} and $\tilde{\mathbf{P}}$ have δ -bounded geometry and

$$\text{mod}(\mathbf{E} \cap \mathbb{H}^+ \setminus \mathbf{P}) \geq \delta \quad \text{and} \quad \text{mod}(\tilde{\mathbf{E}} \cap \mathbb{H}^+ \setminus \tilde{\mathbf{P}}) \geq \delta.$$

- $H|_{X_2}$ is K -quasiconformal, $H \circ F(z) = \tilde{F} \circ H(z)$ for $z \in X_2$, and X_2 contains $E = \mathbf{E} \cap \mathbb{R} \setminus \mathcal{O}$.
- Each component \mathbf{W} of X_3 is a K_1 -quasidisk and there exists a K -qc mapping from \mathbf{W} onto $\tilde{\mathbf{W}}$.

1.4.9. *A real, qc/bg, spreading principle.* Since we cannot control the dilatation of high iterates of the complex extension of f , we are unable to use the usual Spreading Principle, see [KSvS1], to glue together qc mappings defined near the post-critical set into global qc mappings. Instead, we start with a K_0 -qc external conjugacy, see page 87, $H_0: \mathbb{C} \rightarrow \mathbb{C}$ that conjugates $F: \mathcal{U} \rightarrow \mathcal{V}$ and $\tilde{F}: \tilde{\mathcal{U}} \rightarrow \tilde{\mathcal{V}}$ on $\partial\mathcal{U}$ and refine it by pulling back. In order to pull H_0 back, we have to “move” the points $H_0(F(c)), c \in \text{Crit}(F)$ so they match $\tilde{F}(\tilde{c})$. When we do this, the dilatation of resulting map could be arbitrarily large. However, by the complex bounds for the good nest proved in Section 5.5, we can show that the region where the dilatation is uncontrolled has bounded geometry and moduli bounds. This is done in the proof of Proposition 7.6, which we summarize now:

Theorem I (A Real Spreading Principle). *There exist arbitrarily small nice open complex neighbourhoods \mathcal{O} of $\text{Crit}(F)$ and a mapping $H_{\mathcal{O}}: \mathbb{C} \rightarrow \mathbb{C}$ such that*

- $H_{\mathcal{O}}(\mathcal{O}) = \tilde{\mathcal{O}}$;
- $H_{\mathcal{O}}$ agrees with the boundary marking on $\partial\mathcal{O}$;
- $H_{\mathcal{O}}(\text{Dom}'(\mathcal{O})) = \text{Dom}'(\tilde{\mathcal{O}})$;
- for each component \mathbf{U} of $\text{Dom}'(\mathcal{O})$, $H_{\mathcal{O}} \circ F(z) = \tilde{F} \circ H_{\mathcal{O}}(z)$ for $z \in \partial\mathbf{U}$.

Moreover, $H_{\mathcal{O}}: \mathbb{H}^+ \rightarrow \mathbb{H}^+$ is a (K, δ) -qc/bg mapping.

By the QC Criterion, see Theorem 2.1, Theorem I, implies that there exists a $K' = K'(K, \delta)$ -qc mapping of the plane whose restriction to the real line agrees with $H_{\mathcal{O}}|_{\mathbb{R}}$.

2. INGREDIENTS OF THE PAPER AND A SKETCH OF THE PROOF

Before we get into the details, let us point out that in Section 2.4 we give a short guide to the paper for the reader interested in specific results.

2.1. Old and new ingredients of this paper. Our paper not only builds on earlier work on rigidity of polynomials, [KSvS1], [KSvS2] and [Ko], but also relies heavily on ideas from [LvS2] and uses that one has complex and real bounds in the generality required in this paper, see the recent paper [CvST]. Let us list the issues that were not present in earlier works on this topic for which we will need to develop new tools to obtain our results.

2.1.1. *New challenges in the polynomial case.*

- (1) *Odd critical points.* Lack of dynamical symmetry around an odd critical point complicates the construction of complex box mappings, even near a reluctantly recurrent critical point; we treat this situation in this paper. In the persistently recurrent case, we rely on the complex bounds proved in [CvST], which also deals with odd critical points.
- (2) *Polynomials with non-real critical points.* Even if the maps are real polynomials with non-real critical points, qs-rigidity on the real line was not known for infinitely renormalizable maps. In this case, it is not known (without using complex bounds) if it is possible to find critical puzzle pieces that contain only real critical points, see [KvS]. Even in the non-renormalizable case the maps f and \tilde{f} will, in general, not be conjugate on the

Polynomials	Analytic mappings	Smooth mappings
Böttcher Coordinate	Touching box mappings	
Yoccoz puzzle pieces	Complex box mappings	
The enhanced nest		The good nest to prove a spreading principle, and the enhanced nest over a long central cascade
Puzzle pieces in the enhanced nest have complex bounds		Puzzle pieces in the good nest have complex bounds
		Puzzle pieces in the enhanced nest over a long central cascade have complex bounds and they are quasidisks
The Spreading Principle		A Real Spreading Principle, and a $QC \setminus BG$ Partition of a central cascade
A $QC \setminus BG$ Partition for a (quasiregular) polynomial-like mapping		

TABLE 1. This table indicates the changes to the proof of rigidity for polynomials in [KSvS1] to prove rigidity for analytic and smooth mappings.

complex plane, and therefore the proof of [KvS] does not immediately apply. However, we prove qs-rigidity of the real part of dynamics.

2.1.2. *New challenges in the analytic case.*

- (1) *No Böttcher Coordinate.* If the maps are real-analytic, but not polynomial, then there are no Böttcher coordinates, and therefore we cannot use the usual construction of the Yoccoz puzzle. In the analytic case, the strategy of the proof is to combine the proof of qc-rigidity of [KSvS1] and the complex bounds of [CvST] with the proof of rigidity for maps with a non-minimal post-critical set of [LvS2] to provide topologically conjugate maps f and \tilde{f} with compatible “external structures.” We use touching box mappings, see Section 6.3, to play the role of the Böttcher coordinates and complex box mappings to play the role of the Yoccoz puzzles in our setting. Gluing local information together is more difficult, since the puzzle pieces given by complex box mappings do not globally have the same Markov properties as Yoccoz puzzle pieces. In particular, we need to construct complex box mappings whose ranges are Poincaré lens domains to make it possible to transfer the global information given by a touching box mapping close to a critical point.
- (2) *Yoccoz puzzle pieces are automatically nested or disjoint; this is not the case for puzzle pieces constructed by hand.* For polynomials, the case when one critical point c accumulates on another critical point c' , for example on a persistently recurrent critical point,

does not cause difficulties. While here, we need to consider complex box mappings containing all, possibly infinitely many, components of the domain of the first entry map to a puzzle piece containing c' . To deal with this, we need to control the geometry of infinitely many puzzle pieces near c' at a given level.

- (3) *Parabolic points.* To construct qc-conjugacies near parabolic points, we need to consider touching box mappings where the domain and range touch tangentially, see Section 6.3. If we did not consider maps with parabolic points, we could use regions that are quasi-circles to play the role of Böttcher coordinates as in [LvS2]. Here, we will have to use a precise local analysis near parabolic points to ensure that we obtain a qc-conjugacy, respecting the puzzle pieces, near a parabolic point.

2.1.3. New challenges in the C^3 case.

- (1) *The usual spreading principle fails.* For maps that are C^3 , but not analytic, we make use of asymptotically holomorphic extensions on the real-line. Under high iterations, these mappings are far from holomorphic. One consequence of this is that we cannot use the usual Spreading Principle, Proposition 7.2. We use Propositions 5.16 and 7.4 to control the dilatation of f along certain chains, and we use Theorem 7.5, to treat long cascades of central returns. Even when there are no long cascades of central returns, we cannot proceed as in [KSvS1], since we can only the dilatation of f through real pullbacks.
- (2) *The good nest.* Without the usual Spreading Principle, it is difficult to “glue together” conjugacies defined on the landing domain to a neighbourhood of the critical points into a global qc mapping. We develop the good nest for multicritical mappings. It was introduced for unicritical mappings in [AKLS]. We are able to use this nest to prove a Real Spreading Principle for smooth mappings, see Theorem I, since between any two levels of the good nest, there can be at most one central cascade. We prove complex bounds for the good nest in Section 5.5.

Even when there are no long cascades of central returns, the mapping (a pseudo-conjugacy) that we construct will have unbounded dilatation. However, the set where the dilatation cannot be controlled will have good geometric properties - it is contained in a union of puzzle pieces with bounded geometry and appropriate moduli bounds. In particular, such puzzle pieces which do not intersect the real line are well-inside the upper half plane, but this is not the case for every puzzle piece, see Figure 4.

- (3) *Long cascades of central returns.* Let us describe the problem caused by long cascades of central returns. Suppose that $\mathbf{V}^0 \supset \mathbf{V}^1 \ni c_0$ and $R_{\mathbf{V}^0}: \mathbf{V}^1 \rightarrow \mathbf{V}^0$ has a long saddle-node cascade. Let $\mathbf{V}^{i+1} = \text{Comp}_{c_0} R_{\mathbf{V}^0}^{-1}(\mathbf{V}^i)$ be the central puzzle pieces in the principal nest about c_0 . Then there are no fixed points of $R_{\mathbf{V}^0}$ on the real line, and $R_{\mathbf{V}^0}(c_0) \in \mathbf{V}^N$ for some N large. We have that $R_{\mathbf{V}^0}$ has periodic orbits that are far from the real line. It is useful to think of $z \mapsto z^2 + 1/4 + \varepsilon$, see Figure 5. Because of these periodic points, the diameters of the \mathbf{V}^i are bounded from below, and so the dilatation of the mapping $R_{\mathbf{V}^0}^i: (\mathbf{V}^i \setminus \mathbf{V}^{i+1}) \rightarrow \mathbf{V}^0 \setminus \mathbf{V}^1$, $0 \leq i < N$ can diverge for large i and N . If we are in the situation (which may arise infinitely many times in the proof of rigidity) that $H: \mathbb{C} \rightarrow \mathbb{C}$, with $H(\mathbf{V}^0) = \tilde{\mathbf{V}}^0$, and $H(\text{Dom}^*(\mathbf{V}^0)) = \text{Dom}^*(\tilde{\mathbf{V}}^0)$ is a K -qc mapping. If we define $\hat{H}: \mathbf{V}^i \setminus \mathbf{V}^{i+1} \rightarrow \tilde{\mathbf{V}}^i \setminus \tilde{\mathbf{V}}^{i+1}$ for $0 \leq i \leq N$ by the formula $H \circ R^i(z) = \tilde{R}^i \circ \hat{H}(z)$, $z \in \mathbf{V}^i \setminus \mathbf{V}^{i+1}$, then the dilatation of \hat{H} could diverge as $N \rightarrow \infty$. This means that we cannot construct a qc conjugacies between f and \tilde{f} by “pulling back” (even if we knew that the external conjugacy was a conjugacy on the post-critical set). Because of this,

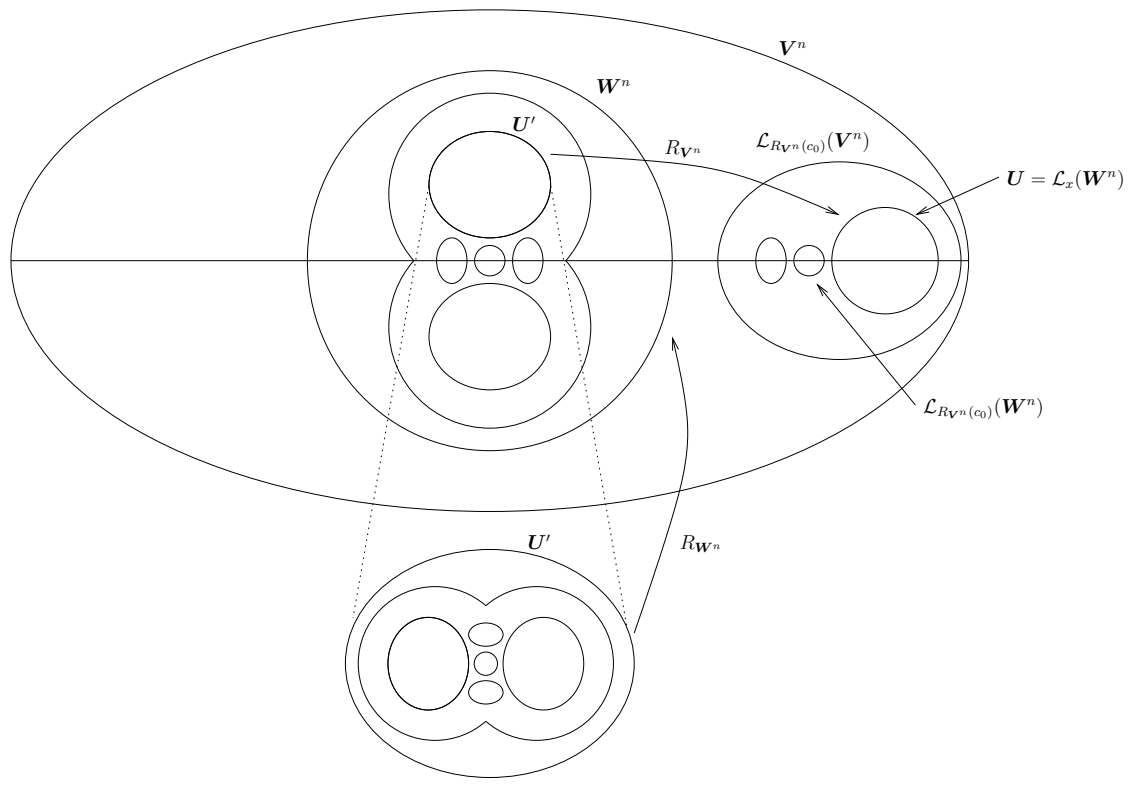

FIGURE 4. The domain $U' = (R_{V^n}|_{W^n})^{-1}(U)$ need not be well-inside \mathbb{H}^+ ; however, the components of $(R_{W^n}|_{U'})^{-1}(\text{Dom}(W^n))$ are well-inside U' , since W^n is δ -nice.

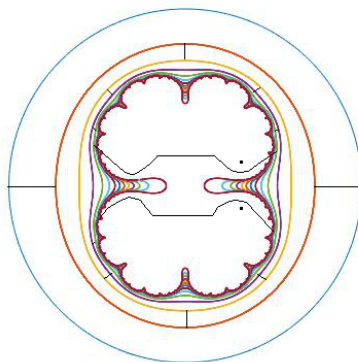

FIGURE 5. Pullbacks of a disk by a qr mapping that is close to $z \mapsto z^2 + 1/4 + \varepsilon$. The return mapping is non-conformal at the complex fixed points, and this non-conformality will blow up under high iterates. The fixed points in the complex plane and the boundaries of the components of X_3 are indicated, compare Figure 3.

a new strategy for proving rigidity in the smooth case is required. We use a geometric construction of a qc mapping, see Theorem 7.5.

2.1.4. *Different nests of puzzle pieces.* For analytic mappings our proof builds on the proof of qc rigidity of real polynomials, [KSvS1]. In that paper, the authors introduced the enhanced nest. The enhanced nest is defined for return mappings $F : \mathcal{U} \rightarrow \mathcal{V}$ defined in a neighbourhood of $\text{Crit}(f) \cap \omega(c_0)$ where c_0 is a persistently recurrent critical point. The enhanced nest goes to deep levels very efficiently, and a puzzle piece I_n in the enhanced nest has the property of being δ -free: there exist $\delta > 0$, an annulus A^+ with inner boundary ∂I_n and an annulus A^- with outer boundary ∂I_n such that $\text{mod}(A^+), \text{mod}(A^-) \geq \delta$, and $\overline{A^+ \cup A^-} \cap \text{PC}(F) = \emptyset$. This control on the post-critical set makes it possible to prove complex bounds for the nest of puzzle pieces, [KSvS1, CvST]. Moreover, it makes it possible to prove that the puzzle pieces in the enhanced nest are quasidisks, Proposition 5.12. It is easier to deal with critical points that are reluctantly recurrent, that is, not persistently recurrent. If f is reluctantly recurrent at c_0 , then there are arbitrarily small neighbourhoods of c_0 , which are mapped up to some definite scale with bounded degree. As in [KSvS1] using these two nests of puzzle pieces about the critical points of f , we prove rigidity for analytic mappings.

For smooth mappings it seems to be difficult to use the enhanced nest to prove rigidity. Between any two levels of the enhanced nest there can be many distinct cascades (different return mappings), and the geometry of these intermediate puzzle pieces can not be controlled. The control we have for the enhanced nest is eventually lost, since the degree of the mapping from a pullback of I_n nested between I_n and I_{n+1} could be arbitrarily large. To deal with this we introduce the good nest for multicritical mappings, see [AKLS] for the unimodal case, and prove complex bounds for this nest. This nest goes to deeper levels much more slowly than the enhanced nest. Indeed there can be at most one central cascade between any two levels of the good nest.

It does not seem to be possible for us to use the good nest alone. In order to prove *a priori* bounds for the good nest, we need to be able to control the dilatation of the mapping from an arbitrarily deep puzzle piece in the good nest up to the top level. We are able to prove such a statement for the enhanced nest since they are controlled by Poincaré disks: there exist $\theta \in (0, \pi/2)$ and $\delta > 0$ so that $I_n \subset D_\theta((1 + 2\delta)I_n)$. Before proving moduli bounds, this is the only tool that we have to control the dilatation of high iterates of f . Since critical values of f can be arbitrarily close to the boundaries of puzzle pieces in the good nest construction, puzzle pieces in the good nest may not be contained in such Poincaré disks. In order to overcome this, we prove Proposition 5.16 which gives us the control on the dilatation that we need. Proposition 5.16 relies on knowing that we can control the dilatation of arbitrarily long pullbacks through a real branch of a central cascade, and to do this we need to be able to control puzzle pieces at the top of a central cascade with Poincaré disks. This is given by Proposition 5.13. The puzzle piece given by Proposition 5.13 comes from a nest that is closely related to the enhanced nest, which we refer to as the *enhanced nest over a central cascade*. These puzzle pieces have similar geometric properties to the puzzle pieces in the enhanced nest; for example, they are also K -quasidisks. We also use Proposition 5.13 to carry out a geometric construction of a qc mapping between a puzzle piece at the top of central cascade of f and the corresponding puzzle piece for \tilde{f} , see Theorem 7.5. In this construction it is important that the puzzle piece at the top of the central cascade is a K -quasidisk.

	δ -nice and δ -bounded geometry	δ -free	K -quasidisk	Notes
Enhanced Nest	✓	✓	✓	Goes to deep levels efficiently. Used to prove qc rigidity for analytic complex box mappings at a persistently recurrent critical point.
Nest about reluctantly recurrent critical points	✓	✗	✓	Used to prove rigidity for analytic complex box mappings at a reluctantly recurrent critical point.
Good Nest	✓	✗	✗	Goes to deep levels slowly. Used to prove a spreading principle for C^3 mappings.
Enhanced nest over a central cascade	✓	✗	✓	Used for C^3 mappings to control dilatation of pull-backs along a real branch of a long central cascade and in the construction of a qc\bg partition of a central cascade.

TABLE 2. Properties of the different nests of puzzle pieces.

2.1.5. *Gluing in the infinitely renormalizable case.* The gluing argument in [KSvS1] Section 7 takes a significant amount of effort beyond what is needed in the finitely renormalizable case. Our method of dealing with the infinitely renormalizable case is an extension of our qc\bg technique for dealing with long central cascades. Figure 3b indicates how this is done.

2.2. **The QC Criterion and qc\bg mappings.** We recall the following result from [KSvS1]:

Theorem 2.1 (QC Criterion [KSvS1] Lemma 12.1). *For any constants $K \geq 1$ and $\varepsilon > 0$, there exists a constant $K' \geq 1$ with the following property. Let $\phi: \Omega \rightarrow \tilde{\Omega}$ be a homeomorphism between two Jordan domains, which extends continuously to the boundary. Assume that $X_0 \cup X_1 \cup X_2$ and $\tilde{X}_0 \cup \tilde{X}_1 \cup \tilde{X}_2$ are partitions of Ω and $\tilde{\Omega}$, respectively, such that the following hold:*

- (1) $\phi(X_i) = \tilde{X}_i$ for $i = 0, 1, 2$.
- (2) If \mathbf{P} is a component of X_1 , then both \mathbf{P} and $\phi(\mathbf{P})$ have ε -bounded geometry, and moreover

$$\text{mod}(\Omega \setminus \mathbf{P}) \geq \varepsilon, \text{mod}(\tilde{\Omega} \setminus \phi(\mathbf{P})) \geq \varepsilon.$$

(3) X_0 has zero measure and for each $x \in X_0$,

$$(2.1) \quad \liminf_{r \rightarrow 0} \frac{\sup_{|y-x|=r} |\phi(y) - \phi(x)|}{\inf_{|y-x|=r} |\phi(y) - \phi(x)|} < \infty.$$

(4) For every $x \in X_2$

$$(2.2) \quad \liminf_{r \rightarrow 0} \frac{\sup_{|y-x|=r} |\phi(y) - \phi(x)|}{\inf_{|y-x|=r} |\phi(y) - \phi(x)|} \leq K$$

Then there exists a K' -qc map $\psi: \Omega \rightarrow \tilde{\Omega}$ such that $\psi = \phi$ on $\partial\Omega$.

Remark 2.1. We refer to [KSvS1] Lemma 12.1 as the QC Criterion.

With the QC Criterion as motivation, we say that a mapping $\phi: \Omega \rightarrow \tilde{\Omega}$ is a (K, ε) -qc\bg mapping if there is a partition, as in Figure 3, of Ω into sets X_0, X_1, X_2 , and a partition of $\tilde{\Omega}$ into sets $\tilde{X}_0, \tilde{X}_1, \tilde{X}_2$, such that

- $\phi(X_i) = \tilde{X}_i$ for $i = 0, 1, 2$,
- X_0 has measure zero, and satisfies (2.1) on X_0 .
- X_1 can be partitioned into open sets \mathbf{P} such that both \mathbf{P} and $\phi(\mathbf{P})$ have ε -bounded geometry, and moreover

$$\text{mod}(\Omega \setminus \mathbf{P}) \geq \varepsilon, \quad \text{mod}(\tilde{\Omega} \setminus \phi(\mathbf{P})) \geq \varepsilon.$$

- ϕ satisfies (2.2) on X_2 .

We refer to such a partition as a qc\bg partition. We believe that qc\bg mappings will be a useful idea in other settings. We will say that Suppose that $\Omega' \subset \Omega$. We say that $\phi: \Omega \rightarrow \tilde{\Omega}$ is a qc\bg mapping with moduli bounds in Ω' if it is a qc\bg mapping and $\text{mod}(\Omega' \setminus \mathbf{P}) \geq \varepsilon$ and $\text{mod}(\phi(\Omega') \setminus \phi(\mathbf{P})) \geq \varepsilon$ for each component \mathbf{P} of X_1 which is contained in Ω' .

One may read the name qc\bg as *quasiconformal except on a set with bounded geometry*. The QC Criterion implies that if $\phi: \Omega \rightarrow \tilde{\Omega}$ is a (K, ε) -qc\bg mapping, then there exists a K' -qc mapping $\phi': \Omega \rightarrow \tilde{\Omega}$ that has the same boundary values as ϕ . To prove Theorem A for smooth mappings we are going to construct a sequence of (K, ε) -qc\bg mappings on the upper half-plane, whose extensions to the real line converge to a conjugacy between f and \tilde{f} . The qc\bg mappings we construct will not be defined dynamically everywhere in their domains. Up to sets of measure zero, their domains will consist of a set where the mappings are dynamically defined, a set that can be decomposed into quasidisks, and a set separating these two sets whose components have bounded geometry and moduli bounds. This level of flexibility makes it possible for us to deal with central cascades. We will describe this in the next subsection.

2.3. Sketch of the proof and organization of the paper. Let us now outline the structure of the paper, and give more detail about some of the aspects of the proof.

2.3.1. Developing the required tools, Sections 3 and 4. In Section 3 we give some background definitions. Specifically we discuss quasiconformal and quasisymmetric mappings, asymptotically holomorphic extensions of C^3 maps, and Poincaré disks and their pullbacks by asymptotically holomorphic mappings. In Section 4 we deal with the necessary real dynamics. In Subsection 4.4 we give a hierarchical decomposition of the set of critical points of a map f and describe a nice real neighbourhood of the set of critical points. We will use

these often. Finally, we present the real bounds that we will need to construct complex box mappings.

2.3.2. *Compatible complex box mappings, Section 5.* A few types of complex box mappings play vital roles in the proof. When combined, they perform the same function as the Yoccoz puzzle for polynomial mappings. Using the hierarchical decomposition of the critical points and a chosen nice real neighbourhood \mathcal{I} of the critical set of f , see Section 4.4, we build complex box mappings about certain critical points. The complex box mapping at each critical point needs to be compatible with the box mappings around other critical points. This compatibility is obtained using touching box mappings, see below.

We will make use of the usual complex box mappings which are complex extensions of the real return maps to neighbourhoods of the set of critical points of f . These were constructed in [CvST] about critical points c_0 with the property that f is persistently recurrent on $\omega(c_0)$. In the reluctantly recurrent case, we construct complex box mappings in Subsection 5.2. This was done for analytic maps with all critical points of even order in [KSvS2], and here we allow for odd critical points. In the reluctantly recurrent case, the complex bounds are obtained from the real bounds at reluctantly recurrent critical points, and the fact that we can go from any small scale up to a fixed scale by a mapping of bounded degree, see Proposition 4.14 and Theorem 5.3. In the persistently recurrent case, the necessary bounds were proved in [CvST], see Theorem 5.1 and Theorem 5.2.

Complex box mappings are very useful for pulling back qc-conjugacies; however, on their own, they do not show that the conjugacies glue together to give a global conjugacy. For this we need:

2.3.3. *Touching box mappings, Section 6.* To obtain a global conjugacy, we construct in Subsection 6.3 “global touching box mappings.” These mappings are the analogue of Böttcher coordinates in our setting. Here the presence of parabolic points causes some additional difficulties.

Some care is needed to make sure that the ranges of the complex box mappings are compatible with with ranges of the touching box mappings. In the reluctantly recurrent case the real bounds (see Proposition 4.14) imply, among other things, that the return domains to certain small intervals I about a critical point are very deep inside of I . Such bounds make it possible to extend the return map to I to a complex box mapping whose range is a Poincaré lens domain. In general, we do not have this sort of geometric control in the persistently recurrent case. Nevertheless, in Theorem 5.2, for maps that are at most finitely renormalizable, we construct a complex box mapping associated to an iterate of a return map whose range is a Poincaré lens domain.

Consider two global touching box mappings $F_T: \mathcal{U}_T \rightarrow \mathcal{V}_T, \tilde{F}_T: \tilde{\mathcal{U}}_T \rightarrow \tilde{\mathcal{V}}_T$, associated to f and \tilde{f} . These are mappings whose range is a finite “necklace neighbourhood” of the interval, each component of the range is a Poincaré lens domain, and each component of the domain is mapped diffeomorphically onto a component of the range (we omit a neighbourhood of the critical points from the domain of a touching box mapping). In Subsection 6.3 we show that it is possible to construct a qc-conjugacy between F_T and \tilde{F}_T , and pull it back. This yields a qs-conjugacy between f and \tilde{f} on the set of points that avoid a real neighbourhood of $\text{Crit}(f)$ and the attracting basins. Constructing the conjugacy in attracting basins is not hard since the local dynamics near attracting cycles is well understood for maps in class \mathcal{C} .



FIGURE 6. Scheme for proving rigidity: the vertical dashed arrows indicate the order in which we prove rigidity (starting at the top and “pulling back”), and the solid arrows indicate key steps in the proof.

We explain how this is done in Section 8.1. In the remaining part of the paper, we focus on how to extend the conjugacy to the real neighbourhood \mathcal{I} of $\text{Crit}(f)$.

2.3.4. *Rigidity of non-renormalizable complex box mappings, Section 7.1- Section 7.6.* Let us start with critical points at which f is at most finitely renormalizable. To prove rigidity of complex analytic box mappings (on their real traces), we use complex bounds together with the Spreading Principle, Proposition 7.2, and the QC Criterion of [KSvS1], see Theorem 2.1. The nice geometric properties of the complex box mappings allow us to construct qc external conjugacies, see Theorem 7.1, between two topologically conjugate complex box mappings. The external conjugacy replaces the conjugacy given by the Böttcher coordinate for polynomials. With these tools in hand, it is possible to repeat the proof of qc-rigidity for non-renormalizable mappings in [KSvS1] to prove rigidity for analytic complex box mappings.

In the smooth case, since it is impossible to control the dilatation of all pullbacks of puzzle pieces in the Yoccoz puzzle, we cannot proceed exactly as in the analytic case. In particular the usual Spreading Principle cannot be applied, and we need to use a different strategy to show that we obtain a qc mapping of the plane with bounded dilatation at each stage of our construction. If we ignore controlling the dilatation of the conjugacy, then our construction is reminiscent of the one used in [Ly1, Ly2]. We start with the external conjugacy, see

page 87, conjugating the dynamics of $F: \mathcal{U} \rightarrow \mathcal{V}$ and $\tilde{F}: \tilde{\mathcal{U}} \rightarrow \tilde{\mathcal{V}}$ on $\partial\mathcal{U}$, and pullback, modifying the mapping before we pullback through critical branches so that it maps critical values to corresponding critical values. However, because we do not have growth of moduli, the dilatation of the resulting mapping can be arbitrarily large. To deal with this, we prove complex bounds for the good nest, see Section 5.5. These results make it possible to confine the region where the dilatation of the mapping that we obtain is uncontrolled to a union of puzzle pieces with bounded geometry and *a priori* bounds. When there are no long central cascades, after applying the QC Criterion to the puzzle pieces in $\text{Dom}'(\mathbf{W}^n)$, this gives us the following: There exists $K_1 \geq 1$ and $\delta_1 > 0$, such that for any $n \geq 0$, there exists a (K_1, δ_1) -qc\bg mapping $H_n: \mathbb{H}^+ \rightarrow \mathbb{H}^+$ such that for any component \mathcal{U} of $\text{Dom}'(\mathbf{W}^n)$, $z \in \partial\mathcal{U}$, we have that $H_n \circ F(z) = \tilde{F} \circ H_n(z)$. Quasisymmetric rigidity of complex box mappings on their real traces follows from this together with the QC Criterion, applied on the upper half-plane, and the compactness of K -qc mappings.

To prove the complex bounds, we prove, roughly, that if a chain $\{\mathbf{G}_j\}_{j=0}^s$ of puzzle pieces such that \mathbf{G}_0 intersects the real line does not contain a long central cascade, then $\sum_{j=0}^s \text{diam}(\mathbf{G}_j)^2$ is bounded, see Proposition 7.4 for more general statement. This estimate gives us that there are exactly two cases where we cannot control the dilatation along a chain: along pullbacks of puzzle pieces that are disjoint from the real line and nested inside of puzzle pieces that are disjoint from the real line, and along long central cascades. By not refining the conjugacy inside of complex puzzle pieces that do not intersect the real line, our complex bounds for the good nest give us a solution to the first problem. Our solution to the second problem requires us to find a puzzle piece near the “top” of a long central cascade that is a quasidisk, see Proposition 5.13. Using this together with a careful analysis of central cascades, we construct a QC\BG Partition of a central cascade, see Theorem 7.5, which allows us to avoid the problem of the dilatation blowing up through long central cascades.

2.3.5. *Application of qc\bg mappings to central cascades, Section 7.6.* Suppose that we are in the situation described above where $R_{\mathbf{E}^0}: \mathbf{E}^1 \rightarrow \mathbf{E}^0$ has a long central cascade and \mathbf{E}^0 is a $(1 + 1/\delta)$ -quasidisk and δ -nice, see Figure 3(A). Using that \mathbf{E}^0 is a quasidisk and our complex bounds, we can decompose \mathbf{E}^0 into combinatorially defined, artificial puzzle pieces each with either good dynamical or geometric properties. The set with good dynamical properties is X_2 and the sets with good geometric properties are X_1 and X_3 .

Very roughly, we use a “real” argument to show that if we start with a K -quasiconformal mapping $H_0: \mathbf{E}^0 \rightarrow \tilde{\mathbf{E}}^0$ that maps the domain of the return mapping to \mathbf{E}^0 to the domain of the return mapping to $\tilde{\mathbf{E}}^0$ and conjugates F and \tilde{F} on the boundaries of these puzzle pieces, then we can pull H_0 back along the real branches of $R: \mathbf{E}^1 \rightarrow \mathbf{E}^0$ and $\tilde{R}: \tilde{\mathbf{E}}^1 \rightarrow \tilde{\mathbf{E}}^0$ with the loss of dilatation controlled by $\text{diam}(\mathbf{E}^0)$. This gives us, at least, a necklace neighbourhood of \mathbf{E}^0 contained in X_2 where H is defined. However, this neighbourhood could be very pinched near the “middle” of the cascade; this is the case when there is a long saddle-node cascade, and in the high return case, it is a “necklace neighbourhood” (as opposed to an open) neighbourhood of the interval.

The complement of $X_2 \cup X_0$, where X_0 is the measure zero set in the definition of a qc\bg mapping, is decomposed into two types of regions:

- The first type, corresponding to X_3 , has geometry that we understand very well because of the Yoccoz Lemma or the linear behaviour near a repelling periodic point.

We will show that if \mathbf{W} is a connected component of this type for R and $\tilde{\mathbf{W}}$ is a the

corresponding component for \tilde{R} , then \mathbf{W} and $\tilde{\mathbf{W}}$ are K_1 -quasidisks, and we construct a \hat{K} -qc mapping from \mathbf{W} to $\tilde{\mathbf{W}}$ that respects some minimal dynamical information of their boundaries.

- The remainder of \mathbf{E}^0 is X_1 . We will show that that this subset, and its image under H , have the property that their connected components have bounded geometry and moduli bounds in both \mathbf{E}^0 and $\mathbf{E}^0 \cap \mathbb{H}^+$.

This allows us to apply the QC Criterion. Let us point out that we use the QC Criterion in two ways: in the way that is familiar from [KSvS1] to obtain a qc mapping on a puzzle piece that agrees with the boundary marking on the puzzle piece, and on the upper half-plane to obtain a qc mapping on the upper half-plane that agrees with the mapping that conjugates the dynamics on the real line outside of a neighbourhood of the critical points.

2.3.6. *Proving quasimetric rigidity, Section 8.* Figure 6 indicates how we proceed.

We start by constructing a conjugacy on immediate basins of attraction at infinitely renormalizable critical points, and then we spread the conjugacy around to critical points c at which f is at most finitely renormalizable and so that f is persistently recurrent on $\omega(c)$, and finally to reluctantly recurrent critical points.

For real analytic infinitely renormalizable mappings we refer to the argument of [KSvS1] to construct a qs conjugacy in a real neighbourhood of each critical point at which f is infinitely renormalizable, and use the touching box mappings to show that this conjugacy is compatible with the conjugacies constructed around other critical points. The argument of [KSvS1] makes use of a lengthy real “gluing” argument, which we can avoid rather neatly by using qc\bg partitions, see Section 8.3.

For a smooth mapping $f \in \mathcal{C}$, we have that a sufficiently high renormalization of f extends to a quasiregular polynomial-like mapping $F: \mathbf{U} \rightarrow \mathbf{V}$ (we define these on page 50). From the original mapping $F: \mathbf{U} \rightarrow \mathbf{V}$ it is impossible to construct arbitrarily small puzzle pieces. Using a method of [LP] we construct rays for $F: \mathbf{U} \rightarrow \mathbf{V}$. By doing this for each subsequent renormalization of F , we obtain arbitrarily small puzzle pieces. (For analytic polynomial-like mappings this can be done using the Douady-Hubbard Straightening Theorem, but in general, a smooth mapping may not be topologically conjugate to a polynomial.) Using these puzzle pieces and complex bounds we construct qc\bg partitions in the infinitely renormalizable setting, see Lemmas 8.12 and 8.13. Thus obtaining a qc\bg mapping, with moduli bounds in the upper half-plane, on a neighbourhood of the real line, which is a conjugacy on the real line.

2.4. **A guide to the paper.** Sections 3 and 4 contain definitions, background material, and results in real dynamics. The reader can refer to these sections as needed.

- Whether a reader is interested in the analytic or the class \mathcal{C} case, the following sections are relevant:
 - Sections 4.5.1, 4.5.2 and 4.5.3 for the real bounds for persistently recurrent mappings, infinitely renormalizable mappings, and reluctantly recurrent mappings, respectively.
 - Sections 5.1 and 5.2 for the complex bounds.
 - Section 6 where we construct touching box mappings.
 - Section 7.1 where we construct an external conjugacy between complex box mappings.

- A reader who is interested in the case of analytic non-renormalizable mappings should refer to Section 7.2 where we prove rigidity for analytic box mappings.

In Section 8, these results are combined to show that f and \tilde{f} are qs-conjugate. A reader who is only interested in the non-renormalizable analytic case could start reading that section at Section 8.4.

- A reader who is additionally interested in the analytic, infinitely renormalizable case, should see
 - Section 5.1 for the complex bounds.
 - Section 8.2 where these critical points are included in the proof of rigidity.
- A reader who is focussing on the case of smooth non-renormalizable mappings without long cascades of central returns (*i.e.* Fibonacci mappings) should go on to read the following:
 - Section 5.4 where we prove that we can control dilatation as long as we do not pull back through long central cascades, note that this is easier when there are no long cascades of central returns whatsoever.
 - Section 5.5 where we prove complex bounds for the good nest of puzzle pieces.
 - Section 7.5 for a real spreading principle. When there are no long cascades of central returns, the reader needs only read steps one through five of the proof.
- A reader who is interested in general smooth mappings should additionally read:
 - Section 5.3 where we prove that we can find puzzle pieces which are quasidisks at the start of long central cascades.
 - Section 5.4, with the case of long central cascades in mind.
 - Section 7.5 for a real spreading principle. We treat long central cascades in Step 6 of the proof.
 - Section 7.6 for the proof of Theorem H, a qc\bg partition of a central cascade.
 - Section 8.3 where we treat the case of infinitely renormalizable smooth mappings.

3. PRELIMINARY DEFINITIONS, REMARKS AND SOME TOOLS

3.1. Basic definitions and terminology. When it will not cause confusion, we let M denote $[0, 1]$ or S^1 . We let \mathbb{N} , \mathbb{R} , \mathbb{R}^2 and \mathbb{C} denote the natural numbers ($\{1, 2, 3, \dots\}$), the real line, the real plane and the complex plane, respectively. As usual, we will consider S^1 as $\mathbb{R} \bmod 1$. Let \mathbb{H}^+ and \mathbb{H}^- denote the upper and lower half-planes in \mathbb{C} . Let $B(a, r)$ denote the ball of radius r centered at a in \mathbb{C} . Let $\mathbb{D}_r = B(0, r)$ and $\mathbb{D} = \mathbb{D}_1$. An annulus is a doubly connected domain in \mathbb{C} . Any annulus A is uniquely uniformized by a round annulus $\mathbb{D}_R \setminus \overline{\mathbb{D}}$, $R > 1$, where $R = \infty$ is allowed (this case corresponds to the punctured disk). We define $\text{mod}(A) = \log R$, when R is finite, and in the case of the punctured disk, set $\text{mod}(A) = \infty$.

If X, Y are sets in \mathbb{R} or \mathbb{C} , we will let $\text{diam}(X)$ denote the diameter of X measured in the Euclidean metric, and

$$\text{dist}(X, Y) = \inf_{x \in X, y \in Y} |x - y|,$$

denote the distance between X and Y measured in the Euclidean metric.

For $k = 0, 1, 2, \dots$, $C^k(I)$ denotes continuous functions that are k -times differentiable on I with $f^{(k)} \in C^0(I)$.

We will adopt the convention that if a complex domain, say \mathbf{P} , is named with a bold symbol, then $P = \mathbf{P} \cap \mathbb{R}$.

We shall denote the connected component that contains x of a set P by $P(x)$ or by $\text{Comp}_x P$ when it improves clarity.

We shall say that a set $U \subset \mathbb{C}$ is *real-symmetric* if it is symmetric with respect to the real line. A mapping $F: U \rightarrow V$ is *real-symmetric* if U and V are both real-symmetric and if F commutes with $z \mapsto \bar{z}$. Unless otherwise stated, all constructions in the complex plane are carried out real-symmetrically.

If I is a union of disjoint intervals, $|I|$ denotes the sum of their lengths. If $I = (a-x, a+x)$ is any interval and $c > 0$ we define $cI = (a-cx, a+cx)$. If we say that I is *well-inside* of I' , we mean that $I' \supset (1+2\delta)I$ for a universal $\delta > 0$; that is, δ does not depend of I, I' .

If $U \subset V$ are domains in \mathbb{C} we say that U is *well-inside* V if $\text{mod}(V \setminus U) > \delta$, again with $\delta > 0$ universal. If U is a topological disk in \mathbb{C} and $\delta > 0$, we say that U has *δ -bounded geometry at x* if $B(x, \delta \cdot \text{diam}(U)) \subset U$. We say that U has *δ -bounded geometry* if for some $x \in U$ it has δ -bounded geometry at x .

If f is differentiable, we let $\text{Crit}(f)$ denote the set of critical points of f and $\text{PC}(f)$ denotes the set of strict forward images of $\text{Crit}(f)$. For a critical point c , we let $\text{Forward}(c)$ denote all critical points in the closure of $\{f^n(c)\}_{n=0}^\infty$, and we let $\text{Back}(c)$ denote the set of all critical points c' such that $c \in \text{Forward}(c')$. Critical points of even order will be called *folding points*.

By the *forward orbit of a point x* , we mean the set of points $f^n(x)$ for $n \geq 0$. As usual, we let $\omega(x)$ denote the *omega-limit set of x* . We say that $\omega(x)$ is *minimal*, if the orbit of every $x' \in \omega(x)$ is dense in $\omega(x)$.

We say that a real mapping f is *renormalizable* at a non-periodic point x if there exists an interval $K \ni x$ and $s \geq 2$ so that $K, \dots, f^{s-1}(K)$ have disjoint interiors and $f^s(K) \subset K$. In this case, we call K a *properly periodic interval* of period s . We say that f is *infinitely renormalizable* at some non-periodic point x if there exist properly periodic intervals containing x of arbitrarily high period. This implies that there exists a sequence of *renormalization intervals* around x with periods $s_n \rightarrow \infty$, i.e. intervals $K_n \ni x$ and integers $s_n \rightarrow \infty$ so that $K_n, \dots, f^{s_n-1}(K_n)$ have disjoint interiors, $f^{s_n}(K_n) \subset K_n$ and $f^{s_n}(\partial K_n) \subset \partial K_n$. If f is infinitely renormalizable at c , then $\omega(c)$ is a minimal set.

We say that a set P is *nice* if for each $x \in \partial P$, $f^n(x) \notin \text{int}P$ for all $n > 0$. It is easy to see that pullbacks of nice open intervals are nested or disjoint.

Given a set P , let

$$\text{Dom}(P) = \{x: \exists k > 0 \text{ so that } f^k(x) \in P\}.$$

Observe that $\text{Dom}(P)$ is collection of *all* landing domains to P together with first return domains to P ; it is not restricted to those that intersect $\omega(c)$ for some critical point c . We will refer to $\text{Dom}(P)$ as the *domain of the first entry mapping to P* . If P is nice, then the boundary of a component of $\text{Dom}(P)$ is mapped into the boundary of P . If $\Omega \subset \text{Crit}(f)$, we let $\text{Dom}_\Omega(P)$ denote the components of $\text{Dom}(P)$ that intersect $\cup_{c \in \Omega} \omega(c)$.

If $x \in \text{Dom}(P)$ the smallest $k > 0$ such that $f^k(x) \in P$ is called the *entry time of x to P* . In this case we define $\mathcal{L}_x(P) = \text{Comp}_x f^{-k}(P) = \text{Comp}_x \text{Dom}(P)$. We define

$$\hat{\mathcal{L}}_x(P) = \begin{cases} P, & \text{if } x \in P, \\ \mathcal{L}_x(P) & \text{if } x \notin P. \end{cases}$$

The first entry mapping restricted to $\text{Dom}^*(P) := P \cap \text{Dom}(P)$ is the *first return mapping to P*; the *first landing mapping to P* is defined on $\text{Dom}'(P) := \text{Dom}(P) \cup P$ and is given by the first entry mapping to P on $\text{Dom}(P) \setminus P$ and the identity on P .

A set X is *invariant* if $f^{-1}(X) = X$ and *forward invariant* if $f(X) \subset X$. If I is a union of intervals we let $E(I)$ denote the set of all points whose forward orbits never enter I .

If I is an interval and J is a pullback of I , we define the *chain*, $\{G_j\}_{j=0}^s$ associated to the pullback by setting $G_s = I$ and $G_j = \text{Comp}_{f^j(J)} f^{-(s-j)} G_s$ for $j = 0, \dots, s-1$. The *order* of chain $\{G_j\}_{j=0}^s$ is the number of intervals G_j , $j = 0, \dots, s-1$ that contain critical points. We define chains and the order of a chain for complex puzzle pieces (defined on page 51) in the same way.

Suppose that $\Omega \subset \text{Crit}(f)$. We say that a real neighbourhood \mathcal{I} of Ω is *admissible* if

- \mathcal{I} has exactly $\#\Omega$ components, each containing an element of Ω ; and
- for each connected component J of $\text{Dom}(\mathcal{I})$, either J is a component of \mathcal{I} or J is compactly contained in a component of \mathcal{I} .

Suppose that \mathcal{I} is a union of nice open intervals and that \mathcal{J} is a union of intervals such that for each connected component J of \mathcal{J} , there exists k_J such that $f^{k_J}(J) \in \mathcal{I}$ and $f^{k_J}(\partial J)$ is contained in the boundary of a component of \mathcal{I} . Define $g: \mathcal{J} \rightarrow \mathcal{I}$ by $g(x) = f^{k_J}(x)$ whenever x is in the connected component J of \mathcal{J} . We say that a complex box mapping (see page 50) $G: \mathcal{U} \rightarrow \mathcal{V}$ *extends* $g: \mathcal{J} \rightarrow \mathcal{I}$ if

- the critical points of g and G are the same,
- for each component J of \mathcal{J} , there exists a component U of \mathcal{U} that contains J and $g|_J = G|_U$,
- each component of \mathcal{U} contains a unique component of \mathcal{J} and each component of \mathcal{V} contains a unique component of \mathcal{I} .

3.2. Quasiconformal and quasisymmetric maps. We say that a homeomorphism $h: [0, 1] \rightarrow [0, 1]$ is κ -*quasisymmetric* (abbreviated κ -*qs*), if

$$\frac{1}{\kappa} \leq \frac{h(x+t) - h(x)}{h(x) - h(x-t)} \leq \kappa$$

whenever we have both $x-t, x+t \in [0, 1]$. The analogous definition holds for a homeomorphism $h: S^1 \rightarrow S^1$. A homeomorphism is called *quasisymmetric* if it is κ -quasisymmetric for some $\kappa \geq 1$. If $X \subset M$, we say that $h: X \rightarrow M$ is κ -qs if it has an extension to a κ -qs map $h: M \rightarrow M$.

Let $\mathbf{U} \subset \mathbb{C}$ be a domain. A mapping $h: \mathbf{U} \rightarrow \mathbb{C}$ is K -*quasiconformal* (K -*qc*) if it is a homeomorphism onto its image, and if for any annulus $\mathbf{A} \subset \mathbf{U}$,

$$\frac{1}{K} \text{mod}(\mathbf{A}) \leq \text{mod}(h(\mathbf{A})) \leq K \text{mod}(\mathbf{A}).$$

The minimum such K is called the *dilatation* of h . Suppose that $X \subset [0, 1]$. Any κ -quasisymmetric mapping $h: X \rightarrow [0, 1]$ has an extension to a $K(\kappa)$ -quasiconformal mapping $h: \mathbb{C} \rightarrow \mathbb{C}$.

We say that a Jordan disk is a (K) -*quasidisk*, if it is the image of \mathbb{D} under a (K) -qc mapping $h: \mathbb{C} \rightarrow \mathbb{C}$. We say that a Jordan curve is a (K) -*quasicircle*, if it is the boundary of

a (K -)quasidisk. We will use the Ahlfors-Beurling Criterion to prove that certain topological disks are quasidisks:

Lemma 3.1 (Ahlfors-Beurling Criterion). *For any $C > 0$ there exists a constant $K = K(C) > 1$, such that the following holds. Suppose that T is a Jordan curve such that for any two points $z_1, z_2 \in T$, there exists an arc $\gamma \subset T$ containing z_1 and z_2 such that $\text{diam}(\gamma) \leq C \text{dist}(z_1, z_2)$. Then T is a K -quasicircle.*

Let us collect some useful results about quasisymmetric mappings on the real line. Suppose that $X \subset \mathbb{R}$. We say that a mapping $h: X \rightarrow h(X)$ is (C, p) -quasisymmetric, if there exists a constant $C > 0$ and $p \in \mathbb{N}$, if whenever $x, a, b \in X$ we have

$$\frac{|h(x) - h(a)|}{|h(x) - h(b)|} < C \max\left\{\left(\frac{|x - a|}{|x - b|}\right)^p, \left(\frac{|x - a|}{|x - b|}\right)^{1/p}\right\}.$$

In this definition, we allow X to be any, even a totally disconnected, subset of \mathbb{R} .

Lemma 3.2. [V, Lemma 2.3] *For any $C \geq 0, p \geq 1, \kappa \geq 1$ and $\delta > 0$ there exists $\hat{\kappa} \geq 1$ such that the following holds. Let I be a bounded interval. Suppose that $h: \mathbb{R} \setminus I \rightarrow \mathbb{R}$ is (C, p) -quasisymmetric, $h_I: (1 + 2\delta)I$ is κ -quasisymmetric and that for each $h|_{(1+2\delta)I_i \setminus I_i} = h_I|_{(1+2\delta)I_i \setminus I_i}$. Then*

$$\hat{H}(z) = \begin{cases} H(z), & z \in \mathbb{R} \setminus I \\ h(z), & z \in I \end{cases}$$

is $\hat{\kappa}$ -quasisymmetric.

For any $M \geq 1$, we say that a set S is M -relatively connected if for any $x \in S, r > 0$ such that $\overline{B(x, r)} \neq S$ we have that either $\overline{B(x, r)} = \{x\}$ or that $\overline{B(x, r)} \setminus B(x, r/M) \neq \emptyset$. It follows from the definitions that for any $M, \kappa \geq 1$ there exists $M' \geq 1$ such that if S is M -relatively connected and h is κ -qs, then $h(S)$ is M' -relatively connected.

Proposition 3.3. [V, Theorem 1.2] *For any $M, \kappa \geq 1$ there exists $\kappa' \geq 1$ such that the following holds. If S is an M relatively connected subset of $\partial\mathbb{D}$ and $h: S \rightarrow \partial\mathbb{D}$ is κ -quasisymmetric mapping, then h extends to a κ' -qs mapping $\hat{h}: \partial\mathbb{D} \rightarrow \partial\mathbb{D}$.*

3.3. Asymptotically holomorphic mappings. The asymptotically holomorphic extensions of smooth maps that we use were constructed in [GSS], and we refer the reader to that paper for the background on these extensions.

Recall that

$$\frac{\partial}{\partial \bar{z}} = \frac{1}{2} \left(\frac{\partial}{\partial x} + i \frac{\partial}{\partial y} \right).$$

Let $K \neq \emptyset$ be a compact subset of \mathbb{R}^2 , \mathbf{U} an open neighbourhood of K in the plane and $H: \mathbf{U} \rightarrow \mathbb{C}$ a C^1 map. We say that H is *asymptotically holomorphic* of order $t, t \geq 1$, on $K \subset \mathbb{R}^2$ if for every $(x, y) \in K$

$$\frac{\partial}{\partial \bar{z}} H(x, y) = 0,$$

and

$$\frac{\frac{\partial}{\partial \bar{z}} H(x, y)}{d((x, y), K)^{t-1}} \rightarrow 0$$

uniformly as $(x, y) \rightarrow K$ for $(x, y) \in \mathbf{U} \setminus K$.

In our applications of asymptotically conformal extension, K will be an interval contained in the real line, and

$$\mu(z) \equiv \frac{\bar{\partial}H}{\partial H} = o(|y|^{t-1})$$

A C^n function H is *asymptotically holomorphic* of order n at a point $z_0 = x_0 + iy_0$ is equivalent to H having a complex Taylor expansion at z_0 of order n :

$$H(z) = H(z_0) + \sum_{k=1}^n \frac{\partial^k H}{\partial x^k}(z_0) \frac{(z - z_0)^k}{k!} + R(x, y),$$

where $z = (x, y)$, the remainder $R(x, y)$ is C^n and $D^j R(x_0, y_0) = 0$ for $j = 0, \dots, n$, and $R(x, y) = o(\|(x, y) - (x_0, y_0)\|^n)$.

Lemma 3.4. [GSS, Lemma 2.1] *Let $I \subset \mathbb{R}$ be a compact interval with non-empty interior and $h: I \rightarrow \mathbb{C}$ a C^n function ($n \in \mathbb{Z}^+$). Then there exists a C^n extension H of h to the complex plane that is asymptotically holomorphic on I of order n . The mapping from h to H is linear and continuous in the C^n topology (for H we use the C^n topology on compact subsets of the complex plane) and commutes with affine rescaling.*

Lemma 3.5. [GSS, Lemma 2.2] *Let $h: I \rightarrow \mathbb{R}$ be a C^1 diffeomorphism onto its image, where $I \subset \mathbb{R}$ is compact and has non-empty interior. If H is any C^1 extension of h to a neighbourhood of I in the complex plane which is asymptotically holomorphic on I of order 1, then H is an orientation preserving diffeomorphism on some (possibly smaller) complex neighbourhood of I .*

It will be useful to observe the following. Let $K \neq \emptyset$ be a compact subset of \mathbb{C} and H a C^1 complex-valued function defined in a open neighbourhood of K in the complex plane. If H is asymptotically holomorphic of order t , ($t \geq 1$) on K , then

- (1) if ϕ is a holomorphic function defined in a neighbourhood of $H(K)$, then $\phi \circ H$ is asymptotically holomorphic of order t on K ;
- (2) if H is a diffeomorphism onto its image, then H^{-1} is asymptotically conformal of order t on $H(K)$.

The local dynamics near an attracting fixed point for an asymptotically holomorphic mapping can be studied in the same way as for a holomorphic mapping:

Proposition 3.6. *Suppose that $f \in C^3$ and that 0 is a fixed point of f . Let $\lambda = f'(0)$ and suppose $|\lambda| < 1$. Let F denote the asymptotically holomorphic extension of f of order 3.*

- (1) *If $0 < |\lambda|$, then there exists $r_0 > 0$, so that for any $r \in (0, r_0)$, F is conjugate to $z \mapsto \lambda z$ in the neighbourhood $\mathbb{D}_r = \{z : |z| < r\}$ of zero by a $K(r)$ -quasiconformal mapping and $K(r) \rightarrow 1$ as $r \rightarrow 0$.*
- (2) *If $|\lambda| = 0$, then there exists $r_0 > 0$, so that for any $r \in (0, r_0)$, F is conjugate to $z \mapsto z^d$ at 0, where d is the order of the critical point, in the neighbourhood \mathbb{D}_r by a $K(r)$ -quasiconformal mapping and $K(r) \rightarrow 1$ as $r \rightarrow 0$.*

Proof. The proof is the same as for holomorphic maps (see [M]). First suppose that $\lambda \neq 0$. Let c be so that $c^2 < |\lambda| < c$. Then by Taylor's Theorem, there exists a neighbourhood \mathbb{D}_{r_0} of the origin so that $|F(z)| < c|z|$ for all $z \in \mathbb{D}_{r_0}$, and fixing any $0 < r < r_0$, there exists $k > 0$ so that $|F(z) - \lambda z| < k|z|^2$ for all $z \in \mathbb{D}_r$. Then given any starting point $z_0 \in \mathbb{D}_r$, the

orbit of z_0 , z_0, z_1, \dots , satisfies $|z_n| < rc^n$, so that $|z_{n+1} - z_n| < kr^2c^{2n}$. Then the sequence of points $w_n = z_n/\lambda^n$ satisfies

$$|w_{n+1} - w_n| \leq \frac{kr^2}{|\lambda|} \left(\frac{c^2}{|\lambda|} \right)^n.$$

Thus $|w_{n+1} - w_n|$ converges geometrically to 0. Hence the sequence of functions $z_0 \mapsto w_n(z_0)$ converges uniformly in \mathbb{D}_r . Let $\phi: [-r, r] \rightarrow [-r, r]$ denote the limit of this sequence. It fixes the end points of the interval and 0. Arguing as we just did, there exists a constant $k' > 0$ such that $|\phi(z) - z| < k'|z|^2$, so ϕ is a local diffeomorphism. Moreover, there exists $K' \geq 1$ (independent of n) so that the mapping $z_0 \mapsto F^n(z_0)/\lambda^n$ is K' -qc. Hence, by compactness of K' -qc mappings, the mapping ϕ is K' -qc. That ϕ satisfies $\phi \circ F(z) = \lambda\phi(z)$ is automatic. \square

3.4. Poincaré disks. Let I be an open interval and fix $\theta \in (0, \pi)$. Let \mathbf{D} denote a round disk intersecting the real line with $\mathbf{D} \cap \mathbb{R} = I$ with the property that $\mathbf{D}^+ = \mathbf{D} \cap \mathbb{H}^+$ intersects the real line with external angle θ . Let \mathbf{D}^- denote the reflection of \mathbf{D}^+ about the real line. Let $D_\theta(I) = \mathbf{D}^+ \cup \mathbf{D}^- \cup I$; $D_\theta(I)$ is the *Poincaré disk with angle θ* based on I . We will refer to Poincaré disks with angle θ close to π as *lens domains*.

Proposition 3.7 ([GSS] Proposition 2). *Let $h: I \rightarrow \mathbb{R}$ be a C^3 diffeomorphism from a compact interval I with non-empty interior into the real line. Let H be a C^3 extension of h to a complex neighbourhood of I , with H asymptotically holomorphic of order 3 on I . Then there exist $K > 0$ and $\delta > 0$ such that if $a, c \in I$ are distinct, $0 < \alpha < \pi$ and $\text{diam}(D_\alpha(a, c)) < \delta$, then*

$$H(D_\alpha(a, c)) \subset D_{\tilde{\alpha}}(h(a), h(c)),$$

where $\tilde{\alpha} = \alpha - K|c - a|\text{diam}(D_\alpha(a, c))$. Moreover, $\tilde{\alpha} < \pi$.

This proposition implies a version of the Almost Schwarz Inclusion Lemma from [dFdM2] when F is analytic:

Lemma 3.8 (Almost Schwarz Inclusion [dFdM2]). *There exist $K < \infty$, $a_0 > 0$ and a function $\theta: (0, a_0) \rightarrow (0, \infty)$ satisfying $\theta(a) \rightarrow 0$ and $a/\theta(a) \rightarrow 0$ as $a \rightarrow 0$ such that the following holds. Let $F: \mathbb{D} \rightarrow \mathbb{C}$ be univalent and real-symmetric, and assume that $I \subset \mathbb{R}$ is an interval containing 0 and $|I| < a \in (0, a_0)$. Let $I' = F(I)$. Then*

(a) *for all $\theta \geq \theta(|I|)$, we have*

$$F(D_\theta(I)) \subset D_{(1-K|I|^{1+\delta})\theta}(I'),$$

where $0 < \delta < 1$ is a universal constant;

(b) *for all $\theta \in (\pi/2, \pi)$ we have*

$$F(D_{\pi-\theta}(I)) \subset D_{\pi-K|I|\theta}(I').$$

Lemma 3.9 ([CvST], Lemma 4.2). *Let $\ell \geq 2$ be a natural number and let $\theta \in (0, \pi)$. Let $P(z) = z^\ell$.*

- *Suppose ℓ is even and let $K \geq 1$. Then there exists $\lambda = \lambda(K, \ell) \in (0, 1)$ such that*

$$P^{-1}(D_\theta(-K, 1)) \subset D_{\lambda\theta}(-1, 1).$$

- *Suppose that ℓ is an odd integer. Let $K > 0$. Then there exists $\lambda = \lambda(\ell) \in (0, 1)$ such that*

$$P^{-1}(D_\theta(-K^\ell, 1)) \subset D_{\lambda\theta}((-K, 1)).$$

Lemma 3.10. *Let $\ell \in \mathbb{N}$ and let $P(z) = z^\ell$. For any $A > 0$ and any $\theta \in (0, \pi)$, there exists $\theta' \in (0, \pi)$ such that*

- *If $\ell \geq 2$ is even, then*

$$P^{-1}(D_\theta((-A, 1))) \supset D_{\theta'}((-1, 1)).$$

- *If $\ell \geq 3$ is odd,*

$$P^{-1}(D_\theta((-A^\ell, 1))) \supset D_{\theta'}((-A, 1)).$$

Lemma 3.11. *Let $\ell \in \mathbb{N}$ and let $P(z) = z^\ell$.*

- *Suppose that ℓ is even. For any $K \geq 1$, there exists $\theta_0 \in (0, \pi/2)$ and $C = C(K, \ell)$ such that for any $\theta \in (0, \theta_0)$ we have that*

$$P^{-1}(D_\theta(-K, 1)) \subset D_\theta(-1, 1) \cup D_{\pi/2}(-C, C).$$

- *Suppose that ℓ is odd. There exists $\theta_0 \in (0, \pi/2)$ and $C = C(\ell)$ such that for any $\theta \in (0, \theta_0)$ we have that*

$$P^{-1}(D_\theta(-K^\ell, 1)) \subset D_\theta(-K, 1) \cup D_{\pi/2}(C \cdot (-K, 1)).$$

In the even case, this lemma follows from:

Lemma 3.12. [LvS1, Appendix] *Let $P_\ell(z) = z^\ell$. Let $K > 1$. There exists $\theta_0 = \theta_0(K) \in (0, \pi)$ such that, for all $\theta \in (0, \theta_0)$, the boundaries of $P_\ell D_\theta((-1, 1))$ and $D_\theta(-K, 1)$ intersect each other at a point $Z(K, \theta)$ and its complex conjugate. Furthermore,*

$$Z(K, \theta) \rightarrow K^2 \in \mathbb{R}, \text{ as } \theta \rightarrow 0.$$

Hence, the difference

$$\Delta_\ell(K, \theta) := D_\theta((-K, 1)) \setminus P_\ell D_\theta((-1, 1))$$

tends to the interval $[1, K^2]$, as $\theta \rightarrow 0$.

Proof. Compare the proof of Lemma 3.9, see [CvST]. Suppose that $z \in \partial P^{-1}(D_\theta(-K^\ell, 1)) \cap \partial D_\theta(-K, 1)$. Then since $z \in \partial D_\theta(-K, 1)$, we have

$$\arg \frac{z-1}{z+K} = \theta,$$

and since $z^\ell \in \partial D_\theta(-K^\ell, 1)$, we have that

$$\arg \frac{z^\ell - 1}{z^\ell + K^\ell} = \theta.$$

But now expressing $z = re^{i\theta}$, we have

$$\frac{r(K+1)\sin t}{r^2 + r(K-1)\cos t - K} = \tan \theta \quad \text{and} \quad \frac{r^\ell(K^\ell + 1)\sin \ell t}{r^{2\ell} + r^\ell(K^\ell - 1)\cos \ell t - K^\ell} = \tan \theta.$$

Dividing these expressions we have that

$$\frac{r^\ell \sin \ell t (K^\ell + 1) (r^2 + r(K-1)\cos t - K)}{(r^{2\ell} + r^\ell(K^\ell - 1)\cos \ell t - K^\ell) r \sin t (K+1)} = 1,$$

Expanding this and setting $RK = r$, we have

$$\begin{aligned}
 1 &= \frac{\sin \ell t}{\sin t} \cdot \frac{r^{\ell-1}(K^\ell + 1)(r^2 + rK \cos t - r \cos t - K)}{(K + 1)(r^{2\ell} + r^\ell K^\ell \cos \ell t - r^\ell \cos \ell t - K^\ell)} \\
 &= \frac{\sin \ell t}{\sin t} \cdot \frac{r^{\ell+1}K^\ell + r^\ell K^{\ell+1} \cos t - r^\ell K^\ell \cos t - r^{\ell-1}K^{\ell+1} + r^{\ell+1} + r^\ell K \cos t - r^\ell \cos t - K r^{\ell-1}}{r^{2\ell}K + r^\ell K^{\ell+1} \cos \ell t - r^\ell K \cos \ell t - K^{\ell+1} + r^{2\ell} + r^\ell K^\ell \cos \ell t - r^\ell \cos \ell t - K^\ell} \\
 &= \frac{\sin \ell t}{\sin t} \cdot \frac{\frac{r^{\ell+1}}{K^{\ell+1}} + \frac{r^\ell}{K^\ell} \cos t - \frac{r^\ell}{K^{\ell+1}} \cos t - \frac{r^{\ell-1}}{K^\ell} + \frac{r^{\ell+1}}{K^{2\ell+1}} + \frac{r^\ell}{K^{2\ell}} \cos t - \frac{r^\ell}{K^{2\ell+1}} \cos t - \frac{r^{\ell-1}}{K^{2\ell}}}{\frac{r^{2\ell}}{K^{2\ell}} + \frac{r^\ell}{K^\ell} \cos \ell t - \frac{r^\ell}{K^{2\ell}} \cos \ell t - \frac{1}{K^\ell} + \frac{r^{2\ell}}{K^{2\ell+1}} + \frac{r^\ell}{K^{\ell+1}} \cos \ell t - \frac{r^\ell}{K^{2\ell+1}} \cos \ell t - \frac{1}{K^{\ell+1}}} \\
 &= \frac{\sin \ell t}{\sin t} \cdot \frac{R^{\ell+1} + R^\ell \cos t - R^\ell \frac{\cos t}{K} - R^{\ell-1} \frac{1}{K} + R^{\ell+1} \frac{1}{K^\ell} + R^\ell \frac{\cos t}{K^\ell} - R^\ell \frac{\cos t}{K^{\ell+1}} - R^{\ell-1} \frac{1}{K^{\ell+1}}}{R^{2\ell} + R^\ell \cos \ell t - R^\ell \frac{\cos \ell t}{K^\ell} - \frac{1}{K^\ell} + R^{2\ell} \frac{1}{K} + R^\ell \frac{\cos \ell t}{K} - R^\ell \frac{\cos \ell t}{K^{\ell+1}} - \frac{1}{K^{\ell+1}}}
 \end{aligned}$$

For large K , the last term is dominated by

$$\frac{\sin \ell t}{\sin t} \cdot \frac{R^{\ell+1} + R^\ell \cos t}{R^{2\ell} + R^\ell \cos \ell t}.$$

So either R is bounded, in which case we are done, or R is large, which implies that $\frac{R^{\ell+1} + R^\ell \cos t}{R^{2\ell} + R^\ell \cos \ell t}$ is very small, and $\frac{\sin \ell t}{\sin t}$ is very large, but $\frac{\sin \ell t}{\sin t}$ is bounded from above. So we can assume that K is bounded, but then we have that

$$1 \asymp \frac{\sin \ell t}{\sin t} \cdot \frac{R_n^{\ell+1} + R_n^\ell \cos t_n - \frac{R_n^\ell}{K} \cos t_n - \frac{R_n^{\ell-1}}{K}}{R_n^{2\ell} + R_n^\ell \cos \ell t_n - \frac{R_n^\ell}{K^\ell} \cos \ell t_n - \frac{1}{K^\ell}},$$

and again we have that either R is bounded, in which case we are done or we have that R is very large, in which case

$$\frac{R_n^{\ell+1} + R_n^\ell \cos t_n - \frac{R_n^\ell}{K} \cos t_n - \frac{R_n^{\ell-1}}{K}}{R_n^{2\ell} + R_n^\ell \cos \ell t_n - \frac{R_n^\ell}{K^\ell} \cos \ell t_n - \frac{1}{K^\ell}}$$

is very small, but then we would need to have

$$\frac{\sin \ell t}{\sin t}$$

large, which is impossible. □

Lemma 3.13 ([CvST], Lemma 5.10). *Suppose that $f: M \rightarrow M$ is C^3 and let f also denote an asymptotically holomorphic extension of order three of f . Then for any $\delta > 0$, $N \in \mathbb{N} \cup \{0\}$ and $\theta \in (0, \pi/2)$, there exist $\varepsilon > 0$, $\eta > 0$, and $\tilde{\theta} \in (0, \pi/2)$ such that the following holds. Suppose that J_s is a nice interval with $|J_s| < \varepsilon$, which does not contain a parabolic periodic point in its boundary, and that $\{J_j\}_{j=0}^s$ is a chain with order bounded by N . Assume that $J_j \setminus (1+2\delta)^{-1}J_j$ does not contain an even critical point for $j = 0, 1, \dots, s-1$. Let $\mathbf{U}_s = D_\theta(J_s)$, and set*

$$\mathbf{U}_j = \text{Comp}_{J_j}(f^{-(s-j)}(\mathbf{U}_s)).$$

Then $\mathbf{U}_0 \subset D_{\tilde{\theta}}(J_0)$ and $f^s: \mathbf{U}_0 \rightarrow \mathbf{U}_s$ is $(1 + \eta|\mu(J_s)|^{1/2})$ -quasiregular.

When we apply this lemma, we will use Lemmas 4.4 and 4.5 to obtain the estimate on the sum of the lengths of intervals in the chain.

The following corollary follows easily:

Corollary 3.14. *For each $\delta > 0$, there exist $\delta' > 0$ and $\lambda \in (0, 1)$ such that the following holds for all sufficiently small $\varepsilon > 0$. Let I be a nice interval with $|I| < \varepsilon$, J a domain of the first entry mapping to I , and $s \geq 1$ the minimal number so that $f^s(J) \subset I$. Let $\{H_j\}_{j=0}^s$ be a chain with $(1 + 2\delta)H_s \subset I$ and $H_0 \subset J$, then there exists an interval H' with $H_0 \subset H' \subset (1 + 2\delta')H' \subset J$ so that*

$$\text{Comp}_{H_0} f^{-s} D_\theta(H_s) \subset D_{\lambda\theta}(H').$$

To treat diffeomorphic pullbacks of lens domains, we have

Lemma 3.15. *For any $\theta \in (0, \pi/2)$, there exists $\varepsilon_0 > 0$ and $\theta' \in (0, \pi/2)$ such that the following holds. Suppose that H_s is a nice interval with $|H_s| < \varepsilon_0$ that does not have a parabolic periodic point in its boundary and that H_0 is diffeomorphic pullback of H_s by f^s . Then*

$$\text{Comp}_{H_0} f^{-s}(D_{\pi-\theta}(H_s)) \subset D_{\pi-\theta'}(H_0).$$

Moreover as $|H_s| \rightarrow 0$, $|\theta' - \theta| \rightarrow 0$.

Proof. By Lemma 4.5, there exists $\eta > 0$, such that

$$(3.1) \quad \sum_{j=0}^s |H_j|^{3/2} < \eta, \text{ so that } \sum_{j=0}^s |H_j|^2 \leq \frac{|H_s|^{1/2}}{C} \eta.$$

Let K be the constant from Proposition 3.7. For $\theta \in (0, \pi/2)$, $\text{diam}(D_{\pi-\theta}(H_j)) = |H_j|$, so that by Proposition 3.7

$$\text{Comp}_{H_{s-1}} f^{-1}(D_{\pi-\theta}(H_s) \subset D_{\pi-\theta-K|H_s|^2}(H_{s-1}).$$

Repeating this s times, we have that

$$\text{Comp}_{H_0} f^{-s}(D_{\pi-\theta}(H_s)) \subset D_{\pi-\theta-K\sum_{j=0}^s |H_j|^2}(H_0).$$

Estimate (3.1) shows that the quantity $K\theta\sum_{j=0}^s |H_j|^2$ can be made as small as we like by taking $|H_s|$ small. \square

4. REAL DYNAMICS

We refer to [dMvS] for background in real dynamics. Let M be either the interval or the circle, and suppose that $f: M \rightarrow M$ is a mapping in \mathcal{C} . Let us remark that since f has no flat critical points, by Theorem A of Chapter IV of [dMvS], f does not possess wandering intervals; and by Theorem B of that chapter, f has at most finitely many non-repelling cycles. We also have by Mañé's Theorem that the set of points that avoids a (real) neighbourhood of the critical points of f has measure zero.

Suppose that p is a periodic point p of period s . Let $\lambda = Df^s(p)$ be the *multiplier* of the periodic orbit. A periodic orbit is called *attracting*, if $|\lambda| < 1$; *parabolic*, if $|\lambda| = 1$, and *repelling*, if $|\lambda| > 1$. An attracting periodic point is called *super-attracting*, if $\lambda = 0$, and in this case the periodic cycle contains a critical point of f .

Lemma 4.1. [vSV1, Theorem C] *Suppose that f is a C^3 mapping of either the interval or the circle with at most finitely many critical points c_i , $0 \leq i \leq b - 1$, and that at each c_i we can express*

$$f(x) = \pm(\phi(x))^{d_i} + f(c_i),$$

where ϕ is C^3 , $\phi(c_i) = 0$, and $d_i > 1$. Then one has the following properties:

(1) *Improved Koebe Principle.* For each $S > 0$, $\delta > 0$ and $\xi > 0$, there exists $K > 0$ such that the following holds. Suppose $J \subset T$ are intervals with $f^n|_T$ a diffeomorphism, $f^n(J)$ ξ -well-inside $f^n(T)$ and either

(a) $\sum_{i=0}^{n-1} |f^i(J)| \leq S$ or

(b) $f^n(T) \cap B_0(f) = \emptyset$ and $\text{dist}(f^i(T), \text{Par}(f)) \geq \delta, i = 0, \dots, n - 1$.

Then $f^n|_J$ has bounded distortion, i.e. for any $x, y \in J$,

$$\frac{|Df^n(x)|}{|Df^n(y)|} \leq K.$$

Here $B_0(f)$ is the union of immediate basins of periodic (possibly parabolic) attractors and $\text{Par}(f)$ is the set of parabolic periodic points of f .

(2) *Negative Schwarzian derivative.* For each critical point c that is not in the basin of a periodic attractor, there exists a (real) neighbourhood U of c such that whenever $f^n(x) \in U$ for some $x \in I$ and $n \geq 0$, the Schwarzian derivative of f^{n+1} at x is negative.

Lemma 4.2 (Improved Macroscopic Koebe Principle). *Let f be as in Lemma 4.1.*

(1) For each $\xi > 0$ there exists $\xi' > 0$ so that if $(1 + 2\xi)J \subset I$ where J and I are both nice intervals, then for any x and any k with $f^k(x) \in J$,

$$(1 + 2\xi')\text{Comp}_x f^{-k}(J) \subset \mathcal{L}_x(I).$$

(2) For each $\xi > 0$ there exists $\xi' > 0$ so that if $(1 + 2\xi)J_s \subset G_s$ and $J_s \supset \mathcal{L}_x(G_s)$ for some $x \in J_s$, the following holds. Let $J_i \subset G_i$ be pullbacks of $J_s \subset G_s$. Then $(1 + 2\xi')J_0 \subset G_0$. Here $\xi'(\xi) \rightarrow \infty$ when $\xi \rightarrow \infty$.

Proof. [Proof of Lemma 4.2] Statement (1) of this lemma is Theorem C(1) of [vSV1], see also [vSV2]. The second part of this lemma is a special case of [CvST] Lemma 3.12 \square

As in [dMvS], for intervals $J \subset T$ so that L, R are the components of $T \setminus J$ define

$$C(T, J) = \frac{|T||J|}{|L||R|} \text{ and } C(f, T, J) = \frac{C(f(T), f(J))}{C(T, J)}.$$

Lemma 4.3 (Cross-ratio inequalities). *Assume that f is C^3 (weaker assumptions are sufficient, see [dMvS]). Then for each $K < \infty$ there exists $C < \infty$ and $\kappa > 1$ such that the following hold:*

(1) If $J \subset T$ are sufficiently small intervals as above with $f^s|_T$ a diffeomorphism and $T, \dots, f^{s-1}(T)$ have intersection multiplicity $\leq K$ (this means that each point is contained in at most K of these intervals), then

$$C(f^s, T, J) \geq 1 - C \max_{i=0, \dots, s-1} |f^i(T)|.$$

(2) If f has no parabolic periodic orbits, then above statement holds even without the assumption that $T, \dots, f^{s-1}(T)$ have intersection multiplicity $\leq K$.

(3) If $J \subset T$ are sufficiently small intervals as above satisfying $|T| \geq (1/K)\text{dist}(T, c)$ where c is a critical point of f , and $|L|, |R| \geq |T|/K$, then

$$C(f, T, J) \geq \kappa > 1.$$

Proof. See Sections IV.1 and IV.2 of [dMvS]. The proof of (3) is the same as the proof of the Second Expansion Principle, [dMvS, Chapter IV, Theorem 2.2]. Note that in the proof of Theorem 2.2 the assumption that $|L|, |R| \geq |T|/K$ is used (and should have been assumed) rather than $T \supset (1 + 2\tau)J$. \square

We will use the following lemmas to control the sums of squares of the lengths of intervals.

Lemma 4.4 (Theorem B [LiS3]). *Let f be C^3 with all periodic orbits hyperbolic repelling. Then for any α there exists $C = C(\alpha)$ such that for any interval T and any $s \in \mathbb{N}$, if $f^s: T \rightarrow f^s(T)$ is a diffeomorphism, then*

$$\sum_{i=0}^s |f^i(T)|^{1+\alpha} < C.$$

Under more restrictive conditions, we can remove the condition that f have no parabolic points.

Lemma 4.5. *Let $f \in \mathcal{C}$ and let $N \in \mathbb{N} \cup \{0\}$. Let \mathcal{P}' be a partition of M given by Lemma 4.9. Let T' be a component of $f^{-N}(\mathcal{P}')$ that does not contain a parabolic periodic point in its boundary. Then for any α there exists $C = C(\alpha)$ such that for any interval T and any $s \in \mathbb{N}$, if $f^s: T \rightarrow f^s(T) = T'$ is a diffeomorphism, and $f^i(T)$ avoids the immediate basins of periodic attractors of f , then*

$$\sum_{i=0}^s |f^i(T)|^{1+\alpha} < C.$$

Proof. We will explain how to adjust the proof of Lemma 4.4 in this situation. In the proof of Proposition 2 of [LiS3] in Subcase 1.1 on page 1490, using the notation of that paper, we replace their estimate

$$|J_n| \leq C\lambda^{-n}|I|$$

by

$$\sum_{i=0}^q |f^{ir}(T)|^{1+\alpha} \leq \max_{0 \leq i < q} |f^{ir}(T)|^\alpha \sum_{n=0}^q |f^{ir}(T)| \leq \frac{|J_0|^\alpha}{C} |I| \leq \frac{|I|^{1+\alpha}}{C},$$

where the first inequality is trivial, the second follows from the fact that each interval $f^{ir}(T)$ is contained in $J_0 = J$ and the fact that $f^{ir}(T) \cap f^{jr}(T) = \emptyset$ for $i \neq j$, and the third from the fact that $J_0 \subset I$. It is worth remarking that in Subcase 1.1 of [LiS3] we assume that the monotone mapping $f^r|_K$ has no fixed point. The remaining parts of the proof are not affected by the presence of parabolic cycles.

Let us briefly comment on the remaining ingredients of the proof. Proposition 1 is Theorem C(1) from [vSV1], and does not require that f not have parabolic points. Proposition 3 gives an estimate in the case when a return domain J to a nice interval I has length comparable to I . It is Proposition 5.2 of [LiS2], and follows from [vSV1] Lemmas 2 and 3, and [ST] Theorems 1 and 2, all of which hold for C^3 maps with no flat critical points. Proposition 4 is Theorem A from [vSV1], which does not depend on f not having parabolic points. The final ingredient is the Yoccoz Lemma, which does not require that f have no parabolic cycles. \square

For maps $f \in \mathcal{C}$, we will need to allow for the boundaries of the domains to contain parabolic points. This will be important in Section 6. To handle this we will use the following estimate.

Lemma 4.6. *Let $f \in \mathcal{C}$. Suppose that 0 is a parabolic periodic point with multiplier 1 and repelling side $[0, x)$. Suppose that x_0 is so small that f is a diffeomorphism on $[0, x_0] = T$ and we can approximate f by*

$$f(x) = x + ax^{d+1} + o(x^{d+1})$$

in T . For any $\alpha > 0$, there exists a constant $C = C(d, \alpha)$ such that

$$\sum_{i=0}^{\infty} |f^i(T)|^{d+\alpha} < C.$$

The exponent on the left is among the key reasons that we require higher regularity near parabolic periodic points.

Proof. We may assume $a = 1$. Approximate f by $x + x^{d+1} + o(x^{d+1})$ near 0. Let $x_0 > 0$ be a boundary point of T , define a sequence by $x_n = x_{n+1} + x_{n+1}^{d+1} + o(x_{n+1}^{d+1})$. Then

$$x_{n+1} - x_n = -x_n^{d+1} - o(x_n^{d+1}).$$

So we can approximate x_n by the solution of the differential equation:

$$y'(t) = -y(t)^{d+1} - o(y(t)^{d+1}), y(0) = x_0.$$

Since $y''(t) = -(d+1)y'(t)^d = -(d+1)(-y(t)^{d+1} - o(y(t)^{d+1}))^d > 0$, for $y(t) > 0$ sufficiently small, we have that the time one mapping eventually satisfies $y(t+1) \leq y(t) - ay(t)^{d+1}$, for some $\eta \in (0, \infty)$. Solving the differential equation

$$\phi'(t) = -\eta\phi(t)^{d+1}, \phi(0) = x_0$$

gives

$$\phi(t) = \left(\frac{1}{\frac{1}{x_0^d} + \eta dt} \right)^{1/d},$$

so that

$$y(t) \leq \left(\frac{1}{\frac{1}{x_0^d} + \eta dt} \right)^{1/d},$$

and we have

$$\sum_{i=0}^{\infty} |f^i(T)|^{d+\alpha} \leq \sum_{i=0}^{\infty} \left(\frac{1}{\frac{1}{|x_0|^d} + \eta di} \right)^{\frac{d+\alpha}{d}} < C.$$

□

4.1. A real partition. Suppose that either $f: [0, 1] \rightarrow [0, 1]$ or the $f: S^1 \rightarrow S^1$ is not a homeomorphism. In the latter case f has periodic orbits, in view of the following proposition (which, surprisingly, we could not find in the literature).

Proposition 4.7 (Non-monotone circle maps have periodic orbits). *If $f: S^1 \rightarrow S^1$ is of class \mathcal{C} and has no periodic points, then f is an orientation preserving homeomorphism.*

Proof. If the degree of f is not equal to 1, then f has a fixed point. So assume that $\deg(f) = 1$. Let $S^1 = \mathbb{R} \bmod 1$ and define $\pi: \mathbb{R} \rightarrow S^1$ by $\pi(x) = x \bmod 1$. Let $F: \mathbb{R} \rightarrow \mathbb{R}$ be the the lift of f (i.e. $\pi \circ F = f \circ \pi$). Let $\rho(f, z)$ equal to the set of limit points of the sequence $\frac{F^n(x) - x}{n}$ where $\pi(x) = z$. It is well-known that $\rho(f) = \{\rho: \rho = \rho(f, z) \text{ for some } z \in S^1\}$ is a connected set, called the rotation interval of f . In the classical case when f is a homeomorphism $\rho(f)$ is

a singleton. If the interval $\rho(f)$ contains a rational number p/q , then f has a periodic point of period q . So we are done unless $\rho(f)$ is equal to an irrational number. It is also well known that the rotation interval is equal to the interval $[\rho(f_-), \rho(f_+)]$ where $F_-(x) = \inf_{y \geq x} F(y)$ and $F_+(x) = \sup_{y \leq x} F(y)$ are the lower and upper maps associated to F , and f_- and f_+ are the corresponding circle maps. Moreover, let $F_t: \mathbb{R} \rightarrow \mathbb{R}$, $t \in [0, 1]$ be a family of maps depending continuously on t with $F_0 = F_-$, $F_1 = F_+$, $F_- \leq F_t \leq F_+$ and so that $F_t = F$ except on some intervals on which F_t is constant. Choose F_t so that it is increasing in t , and let f_t be the corresponding circle map, see Figure 7.

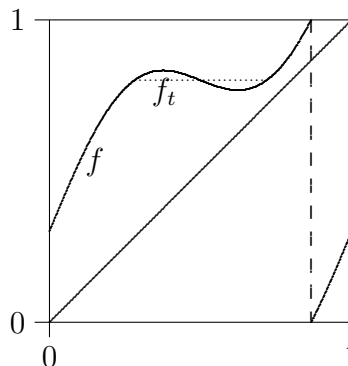

FIGURE 7. A map $f: S^1 \rightarrow S^1$ of degree one which is not monotone, and the corresponding monotone maps f_t with plateaus.

If f is not a homeomorphism, then it has local extrema, and then $F_+ \geq F_-$ with strict inequality in some places.

Claim: If $\rho(f_-)$ is irrational, then $\rho(f_+) > \rho(f_-)$ and there exists $t > 0$ arbitrarily close to 0 so that f_t has a periodic point.

To prove this claim, we first observe that the maps f_t do not have wandering intervals. Indeed, in [MdMvS] monotone degree one circle maps $g: S^1 \rightarrow S^1$ were considered with the following additional property: (i) g is smooth outside a finite number of points, (ii) g has a finite number of plateaus and critical points, and (iii) near each of these points x_i the mapping g is (up to smooth coordinates) of one of the following forms

$$x \mapsto \begin{cases} -|x - x_i|^{\alpha_i}, & x \leq x_i \\ 0 & x \geq x_i \end{cases} \quad \text{or} \quad x \mapsto \begin{cases} 0 & x \leq x_i \\ |x - x_i|^{\alpha_i}, & x \geq x_i \end{cases}$$

where $\alpha_i \geq 1$. It is shown in [MdMvS] that such a mapping has no wandering intervals, i.e. for each interval J so that $g^n(J)$, $n = 0, 1, 2, \dots$ are disjoint there exists $n \geq 0$ so that $g^n(J) \subset \text{Plat}(g)$. Here $\text{Plat}(g)$ is the union of the plateaus of g . In particular, f_t has no wandering intervals for each $t \in [0, 1]$.

Take a plateau K of F_- which is not eventually mapped into any other plateau and let \hat{x} be the left endpoint of K . Since $\rho(f_-)$ is irrational and f_- has no wandering intervals, there exist iterates $n_i \rightarrow \infty$ so that $(f_-)^{n_i}(K)$ accumulates from the left to \hat{x} . Therefore there exists a sequence p_i of positive integers such that $(F_-)^{n_i}(\hat{x}) < \hat{x} + p_i$ for all i and $(F_-)^{n_i}(\hat{x}) - \hat{x} - p_i \rightarrow 0$ as $i \rightarrow \infty$. Notice that for each $t > 0$ there exist $\alpha(t) > 0$ and $N(t)$ so that $(F_t)^n(x) \geq (F_-)^n(x) + \alpha(t)$ for all $n \geq N(t)$ and all $x \in \mathbb{R}$. Indeed, there exists $\epsilon(t) > 0$ and an open set $U_t \subset \text{Plat}(f_t) \setminus \text{Plat}(f_-)$ so that $F_t(x) > F_-(x) + \epsilon(t)$ for all $x \in U_t$. Since U_t is not contained in a plateau of F_- and $\rho(f_-)$ is irrational, there

exists $N(t)$ so that for each $x \in \mathbb{R}$ there exists $0 \leq k < N(t)$ so that $(F_-)^k(x) \in U_t \bmod 1$. It follows that $(F_t)^{k+1}(x) \geq (F_-)^{k+1}(x) + \epsilon(t)$. Moreover, there exists $\tau(t) > 0$ so that $(F_t)^m(y + \epsilon(t)) \geq (F_-)^m(y) + \tau(t)$ for each $0 \leq m \leq N(t)$ and each $y \in \mathbb{R}$. It follows that for $\alpha(t) = \min(\epsilon(t), \tau(t)) > 0$ so that $(F_t)^n(x) \geq (F_-)^n(x) + \alpha(t)$ for $n \geq N(t)$ and all $x \in \mathbb{R}$. This, $(F_-)^{n_i}(\hat{x}) - \hat{x} - p_i \rightarrow 0$ and the Intermediate Value Theorem implies that there exists $t' \in (0, t)$, so that $(F_{t'})^{n_i}(\hat{x}) - \hat{x} - p_i = 0$. Hence \hat{x} is a periodic point of $f_{t'}$. \square

With this lemma in hand, we will assume that f has periodic orbits.

Suppose that f is a C^1 mapping of M with $b < \infty$ critical points. We say that an f -forward invariant set $Z \subset I$ is *admissible with respect to f* if it is a finite set that is disjoint from $\text{PC}(f)$. From now on Z will always denote an admissible set. Observe that if Z is an admissible set, and $\Omega \subset \text{Crit}(f)$, then the union of the components of $M \setminus Z$ that intersect Ω is an admissible neighbourhood of Ω . We call an interval I a (*real*) *puzzle piece with respect to Z* if it is a component of $f^{-n}(Y)$ where Y is a component of $[-1, 1] \setminus Z$. In this case we define the *depth* of the puzzle piece to be n . We will use the notation $Y_n^Z(x)$ to denote the puzzle piece with respect to Z of depth n that contains x . We will let \mathcal{Y}_n^Z denote the union of puzzle pieces of level n . When it will not be confusing, we will omit the Z in the notation. We call a puzzle piece *critical* if it contains a critical point.

If P and Q are critical puzzle pieces, we say that Q is a *child* of P , if it is a unicritical pullback of P ; that is, for some n , Q is a component of $f^{-n}(P)$ and the mapping $f^{n-1}: f(Q) \rightarrow P$ maps a neighbourhood of $f(Q)$ diffeomorphically onto its image. Notice that we do not require that Q be contained in P . Let $c_0 \in \text{Crit}(f)$. A mapping f is called *persistently recurrent on $\omega(c)$* if each critical point in $\omega(c)$ is non-periodic and each $\omega(c)$ -critical puzzle piece has only finitely many children. Under these circumstances we will also say that f is *persistently recurrent at c* . If f is persistently recurrent on $\omega(c)$, then $\omega(c)$ is a minimal set. We say that f is *reluctantly recurrent at c* if c is recurrent and there exists an $\omega(c)$ -critical puzzle piece with infinitely many children.

Let c be a critical point of f and let Z be an admissible set for f . We say that f is Z -recurrent at c if for any $n \geq 0$, there exists some $k \geq 1$ such that $f^k(c) \in Y_n^Z(c)$. We say that f is Z -renormalizable at c , or that c is Z -renormalizable if there exists a positive integer s , such that $f^s(c) \in Y_n^Z(c)$ for any $n \geq 0$, and the minimal positive integer s with this property is called the Z -renormalization period of c .

We will specify a choice of starting partition in Lemma 4.9.

Lemma 4.8 ([KSvS1], Fact 6.1). *Let Z be an admissible set. Then for each $c \in \text{Crit}(f)$, if f is Z -recurrent, but not Z -renormalizable at c , then $|Y_n^Z(c)| \rightarrow 0$ as $n \rightarrow \infty$.*

Let $\text{Crit}_{\text{trival}}(f)$ denote the subset of $\text{Crit}(f)$ which are either contained in an attracting basin or that have a finite forward orbit. We will call a mapping f *trivial* if $\text{Crit}_{\text{trival}}(f) = \text{Crit}(f)$.

4.2. Renormalizable maps. If c is Z -renormalizable, we define

$$A^Z(c) = \bigcap_{n=0}^{\infty} \bigcup_{i=0}^{s-1} Y_n^Z(f^i(c)) \cap \text{Crit}(f),$$

where s stands for the Z -renormalization period of c . The set $\bigcap_{n=0}^{\infty} \bigcup_{i=0}^{s-1} Y_n^Z(f^i(c))$ is a union of intervals I , which contains $\omega(c)$, and such that for each such I , $f^s(I) \subset I$ and $f^s(\partial I) \subset \partial I$; that is, it is the union of periodic intervals of period s , containing $\omega(c)$. Note that any critical point $c' \in A^Z(c)$ is also renormalizable with period s and that $A^Z(c) = A^Z(c')$.

If I is a nice interval containing a critical point c , we define the *principle nest* with $I^0 = I$ at c by

$$I = I^0 \supset I^1 \supset I^2 \supset \dots,$$

where $I^{i+1} = \mathcal{L}_c(I^i)$. We say that an interval I is *terminating* if for each critical point c of $R|_{I^1}: I^1 \rightarrow I$, $R^i(c) \in I^i$ for all $i \in \mathbb{N}$. Otherwise we say that I is *non-terminating*. If I is terminating, then $R_I: I^1 \rightarrow I$ is renormalizable and $I^\infty = \bigcap_i I^i$ is a periodic interval.

If f is renormalizable (that is Z -renormalizable) at a critical point c , then there is an even critical point $c_0 \in \omega(c)$. Fix such a c_0 . There exists an interval T and an involution $\tau: T \rightarrow T$, such that $f \circ \tau = f$ holds on T . Let $B_1 \supset B_2 \supset B_3 \supset \dots$ be all the symmetric (with respect to τ) properly periodic intervals that contain c_0 , and let $1 \leq s_1 < s_2 < s_3 < \dots$ be the corresponding periods. Define β_n by $B_n = (\beta_n, \tau(\beta_n))$. Let α_n be the orientation reversing fixed point of f^{s_n} closest to c_0 , and set $A_n = (\alpha_n, \tau(\alpha_n))$.

4.3. A starting partition.

Lemma 4.9 (Choice of a starting partition on the real line). *Assume that f is of class \mathcal{C} and $f: [0, 1] \rightarrow \mathbb{R}$ or $f: S^1 \rightarrow S^1$, and that f has periodic orbits. Then there exists a finite, non-empty, forward invariant set Z so that the partition \mathcal{P} induced by Z has the following properties:*

- (1) *The boundary points of B_0 are contained in the set Z . Here B_0 is the immediate basin of periodic attractors (possibly one-sided).*
- (2) *Z contains all parabolic periodic orbits.*
- (3) *If f is not infinitely renormalizable at a critical point c , then $\mathcal{P}(c)$ is the smallest periodic interval containing c .*
- (4) *If f is infinitely renormalizable at a critical point c , then $\mathcal{P}(c)$ is a renormalization interval and each critical point c' which is contained in the orbit of $\mathcal{P}(c)$ has the same ω -limit set.*
- (5) *Suppose that x is not a boundary point of $[0, 1]$. If x is not eventually mapped into the interior of a renormalization interval I of period s for which $f^s: I \rightarrow I$ is infinitely renormalizable and also is not eventually mapped into $\text{Cl}(B_0)$, then there exists a sequence of points $y_n, z_n \in f^{-n}(Z)$ with $y_n \downarrow x$ and $z_n \uparrow x$ as $n \rightarrow \infty$.*
- (6) *Suppose that $f: [0, 1] \rightarrow \mathbb{R}$. Then there exists an extension of f to a neighbourhood W of $[0, 1]$. In this case (5) holds for $x \in \{0, 1\}$ for the extension of f to W , provided that the orbit of x is not contained in $\{0, 1\}$. If the orbit of $x \in \{0, 1\}$ is contained in $\{0, 1\}$, $x \in Z$.*

Proof. This lemma is the analogue of Lemma 6.1 in [KSvS1]. Take Z_a to be the set of boundary points of immediate basins of periodic attractors, and Z_{par} be the set of parabolic periodic orbits of f . Note that f has only a finite number of periodic attractors, see [MdmvS] and also [dMvS, Theorem B, Chapter IV]. These finite sets consist of periodic and pre-periodic points. Next for each critical point c at which f is not infinitely renormalizable, let I_c be the smallest periodic interval (i.e. $f^s(I) = I$ and $f^s(\partial I) \subset \partial I$) containing c . Let Z_{nr} be the set of boundary points of such intervals I_c . For each critical point at which f is infinitely renormalizable, take a periodic interval $I \ni c$ which is so small that for each critical point c' in the orbit of I one has $\omega(c) = \omega(c')$. This can be done since f has only a finite number of critical points. Finally, in order to ensure that Z is non-empty, let Z_f be the set of all fixed points of f together with any $x \in \{0, 1\}$ such that the orbit of x is contained in $\{0, 1\}$ in the interval case and the set of all periodic points of period N in the circle case (where N is the

minimal period of a periodic point of f). The set $Z = Z_a \cup Z_{par} \cup Z_{nr} \cup Z_{ir} \cup Z_f$ is non-empty and has the required properties. Finally, whenever I is a smallest renormalization interval, include in Z a periodic point which lies in the interior of I . Properties 5 and 6 claimed in the lemma follow from the following fact:

Fact: Assume that f is of class \mathcal{C} and has a fixed point. Moreover, assume that x is a point which is not contained in a renormalization interval and that x is not eventually mapped into $\text{Cl}(B_0)$. Then there are backward iterates of some fixed point a which accumulate to x from the left (and also backward iterates which accumulate to x from the right).

Proof of fact: Take x and a closed one-sided neighbourhood J of x . Assume by contradiction that no point in J eventually is mapped into any fixed point. The mapping f is of class \mathcal{C} , and therefore has no wandering intervals. Since J is not contained in the basin of a periodic attractor, it follows that there exists $n < n'$ so that $g^n(J) \cap g^{n'}(J) \neq \emptyset$. Hence $\hat{J} = \cup_{k \geq 0} f^{k(n'-n)}(J)$ is connected. Since \hat{J} does not contain any fixed points of f , it cannot be equal to S^1 and so \hat{J} is an interval. The interval \hat{J} has the property that $f^{n'-n}(\hat{J}) \subset \hat{J}$. If $n' - n > 1$, then \hat{J} is a renormalization interval for f , so since x is not eventually mapped into a renormalization interval, it follows that $f(\hat{J}) \subset \hat{J}$ and so \hat{J} contains a fixed point of f , a contradiction. \square

4.4. A decomposition of the set of critical points. Let us define a partial ordering on the set of critical points as follows. We say that $c_1 \geq c_0$ if $c_0 \in \omega(c_1)$ or if $c_0 \in \text{Forward}(c_1)$. We define $[c] = \{c\}$ if c is non-recurrent and otherwise define $[c]$ to be the set of critical points c' with $\omega(c) = \omega(c')$. If $c_1 \geq c_0$, then $\omega(c_1) \supset \omega(c_0)$. This implies that if $c_1 \geq c_0$, c_1 is recurrent and c_0 is reluctantly recurrent, then c_1 is reluctantly recurrent too. We associate to the partial ordering a graph whose vertices are the critical points and where there is a directed edge from c to c' if $c' \leq c$. Let Ω be any connected component of this graph. We decompose Ω as follows. Let Ω_0 be the set of critical points at which f is infinitely renormalizable or which tend to a periodic, possibly parabolic, attracting cycle. For $c' \in \Omega_0$ let $I(c')$ be the component of the basin of the periodic attractor that contains c' or a periodic interval that contains c' of period high enough that for any critical point $c \in \text{Crit}(f)$ such that either $c' \notin \omega(c)$ or $c' \neq f^j(c)$ for any $j \in \mathbb{N}$, we have that $f^k(c) \notin I(c')$ for all $k = 0, 1, 2, \dots$. In certain circumstances, when f is infinitely renormalizable at c' , we may ask that $I(c')$ be selected smaller, but this is always possible by real *a priori* bounds (see for instance Theorem 3.1 of [CvST]).

Let $\Omega_1 \subset \Omega$ be the set of critical points c such that $\omega(c)$ is persistently recurrent, and f is not infinitely renormalizable at c . Choose a smallest subset $\Omega'_1 \subset \Omega_1$ such that

$$\cup_{c \in \Omega'_1} \omega(c) = \cup_{c \in \Omega_1} \omega(c).$$

Then each $\omega(c)$ contains exactly one critical point in Ω'_1 .

Let $\Omega' \neq \Omega$ be any other connected component of the graph. Observe that since Ω' is a connected component of the graph, for each critical point $c \in \Omega$ we can, and will, choose a nice real neighbourhood $I(c)$ so that all iterates of critical points in Ω' remain outside $I(c)$. First, choose a nice neighbourhood I'_1 of Ω'_1 and let

$$I_1 = \cup_{c \in \Omega_1 \setminus \Omega'_1} \mathcal{L}_c(I'_1) \cup I'_1.$$

Let $\Omega_2 = \Omega \setminus (\Omega_0 \cup \Omega_1)$; it is a set of critical points $c \in \Omega$ such that f is reluctantly recurrent at c or such that c is nonrecurrent. Let $\Omega'_2 \subset \Omega_2$ be the set of critical points $c \in \Omega_2$ such that $\mathcal{L}_c(I(c_0))$ is empty for each $c_0 \in \Omega_1 \cup \Omega_0$. If $c \in \Omega_2 \setminus \Omega'_2$, then we take $I(c) = \mathcal{L}_c(I(c_0))$ where

$c_0 \in \Omega_0 \cup \Omega_1$ and $I(c_0)$ is the first neighbourhood of such a critical point that the orbit of c enters. For $c \in \Omega'_2$, we take $I(c)$ to be some arbitrary nice interval about c that is so small that no critical point in Ω_1 enters it. We define

$$I_2 = \bigcup_{c \in \Omega_2} I(c).$$

Note that we can choose I'_1 so small that each critical point $c' \notin I'_1$ that eventually enters I'_1 is contained in Ω_2 . Since the real puzzle pieces shrink, we can choose I so that it is a nice set.

4.5. Real bounds, old and new. Suppose that f is a C^3 mapping of the interval with at most b critical points of finite order. That is, for each critical point c_i of f there exists $\ell_i < \infty$, so that near c_i we can write $f(x) = \pm(\phi(x))^{\ell_i} + f(c_i)$, where ϕ is a local C^3 diffeomorphism and $\phi(0) = 0$. We will denote this set of maps by \mathcal{A}_b^3 , where $\underline{b} = (\ell_1, \dots, \ell_b)$. We say that a mapping of $f: I \rightarrow I$ in \mathcal{A}_b^3 is τ -extendible, if it extends to mapping $\tilde{f}: (1 + \tau)I \rightarrow \mathbb{R}$ with $\tilde{f} \in \mathcal{A}_b^3$, i.e., so that \tilde{f} has no additional critical points.

A nice interval I is called

- ρ -nice if for each $x \in I \cap \omega(c_0)$, $(1 + 2\rho)\mathcal{L}_x(I) \subset I$,
- ρ -externally free if there exists a nice interval $J \supset (1 + 2\rho)I$ so that $J \supset I$ is a nice pair and $J \cap \omega(c_0) \subset I$,
- ρ -internally-free if there exists a nice interval $J' \subset (1 + 2\rho)^{-1}I$ so that $I \supset J'$ is a nice pair and $I \cap \omega(c_0) \subset J'$,
- ρ -free if $((1 + 2\rho)I \setminus (1 + 2\rho)^{-1}I) \cap \omega(c_0) = \emptyset$.

4.5.1. Real bounds in the persistently recurrent, finitely renormalizable case. The following is Part (a) of Theorem 3.1 of [CvST]. It asserts that we have certain real bounds for arbitrarily small nice intervals about critical points at which f is at most finitely renormalizable and persistently recurrent. These intervals are given by the enhanced nest, see Section 2 of [CvST] or Section 8 of [KSvS1] for the definition of this sequence of real puzzle pieces.

Proposition 4.10 (Real geometry of the enhanced nest, [CvST] Theorem 3.1). *Suppose that $f \in \mathcal{A}_b^3$. There exists $\varepsilon_f > 0$ such that the following holds. Assume that c_0 is a critical point at which f is persistently recurrent, and that either c_0 has even order or that every critical point in $\omega(c_0)$ has odd order. Suppose that $I_0 \ni c_0$ is a nice interval with $|I_0| < \varepsilon_f$. Let $I_0 \supset I_1 \supset \dots$ be the enhanced nest for f at c_0 . Then there exists $\rho > 0$ such that if I_n is non-terminating, then I_n is ρ -nice. In addition, if I_{n-1} is non-terminating then I_n is ρ -externally and ρ -internally free, where the externally free space is given by an interval $J \supset (1 + 2\rho)I_n$ and the internal free space is given by an interval $J' \subset (1 + 2\rho)^{-1}I_n$. Moreover, if c_0 is even $|J'| \geq \rho|I_n|$; if c_0 is odd then for each $\nu > 0$ there exists $\rho' > 0$ so that if $|I_{n-1}|/|I_n| < \nu$ then $|J'| \geq \rho'|I_n|$.*

4.5.2. Real bounds in the infinitely renormalizable case.

Proposition 4.11 (Real bounds in the infinitely renormalizable case). *For each D , there exist $\kappa > 1$ and $\delta > 0$ with the following properties. Let f be infinitely renormalizable with D critical points. Assume that K is a renormalization interval for f of period s with s sufficiently large. Then there exists \hat{K}', \hat{K} so that for $\hat{K}' \supset \hat{K} \supset K$ the following holds. Let $\hat{K}'_i \supset \hat{K}_i \supset f^i(K)$ are the pullbacks of $\hat{K}'_s = \hat{K}'$ and $\hat{K}_s = \hat{K}$. Also let J_s^\pm be the components of $\hat{K}'_s \setminus \hat{K}_s$ and let $J_i \subset \hat{K}'_i$ be its pullback. Then*

- (1) the intersection multiplicity of $\hat{K}'_s, \dots, \hat{K}'_0$ is at most 6.
- (2) f^s is a diffeomorphism on J_0^+ and on J_0^- .
- (3) $|J_s^+| = |J_s^-| \geq \kappa |J_0^+|$ and $|J_s^+| = |J_s^-| \geq \kappa |J_0^-|$.
- (4) $|\hat{K}'_s| \geq \kappa |\hat{K}'_0|$.
- (5) each component of $\hat{K}'_s - \hat{K}'_0$ has length $\delta |K|$ where $\delta \in (0, 1)$.

Proof. This follows from the so-called ‘smallest interval argument’, see for example [dMvS, Lemma VI.2.1] and Lemmas 2 and 3 of [vSV1]. Indeed, choose $m \in \{0, \dots, s-1\}$ so that $f^m(K)$ is the smallest interval among the intervals $K, \dots, f^{s-1}(K)$. We can take s so large that there exists an interval $M_m \subset [0, 1]$ which is a 0.9-scaled neighbourhood of $f^m(K)$ (and which therefore does not (strictly) contain any other interval from the collection $K, \dots, f^{s-1}(K)$ other than $f^m(K)$). Moreover, if s is large enough, then each $f^i(K)$, $i = 0, \dots, s-1$ contains at most one critical point. Now pull back M_m to a neighbourhood M_0 of K . By the real Koebe Lemma, there exists δ (which does not depend on K and s) so that M_0 contains a δ -neighbourhood of K (the pull back has intersection multiplicity ≤ 6). Let $T_s := M_0 \supset K \supset f^s(K)$. Then T_s does not contain any other interval from the collection $K, \dots, f^{s-1}(K)$ other than K . Let $T_i \supset f^i(K)$ be the pullback of T_s . Again, by construction, T_0, \dots, T_s has intersection multiplicity ≤ 6 , and so T_0 contains a δ' -neighbourhood of K (where again δ does not depend on K and s).

In fact, f^s is monotone on T_0^+ and on T_0^- where T_0^\pm are the components of $T_0 \setminus K$. Indeed, otherwise there exists $j < s$ so that $f^j(T_0^\pm)$ contains a turning point, and then $f^{j+1}(T_0^\pm)$ contains $f^{j+1}(K)$ which implies that $T_s \setminus K$ contains one of the intervals $f^i(K)$, $i = 1, \dots, s-1$, a contradiction. If f has no critical points of odd order then we are done. Simply take $\hat{K}' = T_s$, $\hat{K} = K$ and $J_s = T_s \setminus K$. A simple argument then shows all the required properties are satisfied. Since we need to deal with the general case anyway, we will not give the details here.

So let us allow for the possibility that f has critical points of odd order (which cannot be ‘seen’ when f is considered as a mapping on the real line). Then we cannot expect the previous argument to prove that f^s is a diffeomorphism on each component of T_0^+ or T_0^- . However, $f^s|_{T_0^+}$ and $f^s|_{T_0^-}$ has at most D critical points (all of odd order), where D is the number of critical points of f of odd order. (In fact, one can easily show that if the orbit of K contains all critical points of f , that $f^s|_{T_0^+}$ and $f^s|_{T_0^-}$ each contain at most one inflection point, but this observation does not significantly simplify the arguments below, so we shall not use this observation.) To complete the proof of the proposition and choose $\hat{K}_s \supset \hat{K}_s^* \supset K$ with the required properties, we will need the following two lemmas.

Lemma 4.12. *For each $c > 1$ there exist $\lambda \in (1, \infty)$ and $\kappa > 1$ so that the following holds. Assume that $g: [0, 1] \rightarrow \mathbb{R}$ is monotone increasing with $g(0) = 0$, $g(1) > 1$ and with no fixed point in $(0, 1)$. Assume that $t = (x, y)$ with $0 \leq x < y < 1$ is so that both of the following assumptions are satisfied*

- (a) either $x' = 0$ or $|y' - x'|/|x'| \geq \lambda$ where $x' = g(x)$ and $y' = g(y)$;
- (b) whenever $l, j, r \subset t$ are adjacent intervals (ordered from left to right) so that $l' = g(l)$, $j' = g(j)$ and $r' = g(r)$ all have length $|g(t)|/3$, then $(|g(t)|/|t|)(|g(j)|/|j|) \geq c \cdot (|g(l)|/|l|)(|g(r)|/|r|)$.

Then there exists an interval $m = (a, b) \subset t$ with $0 < a < b$ and

$$|g(m)|/|m| \geq \kappa \text{ and } |g(m)| \geq |g(t)|/3 \text{ and } g(b)/b \geq \kappa.$$

Proof. Take $m \subset t$ with $|g(m)| \geq |g(t)|/3$, and let α be the component of $[0, 1] \setminus m$ which contains 0. Write $m' = g(m)$ and $\alpha' = g(\alpha)$. Note that $|\alpha| \leq |\alpha'|$ because $g|_\alpha$ has no fixed points other than 0. Also $|\alpha'| \leq 5|m'|$ (since $|y' - x'|/|x'| \geq \lambda > 1$ and since $|m'| \geq |g(t)|/3$). Hence $|m'|/|m| \geq \kappa$ implies $|\alpha' \cup m'|/|\alpha \cup m| \geq |\alpha' \cup m'|/|\alpha' \cup m| \geq (5|m'| + |m'|)/(5|m'| + |m|) \geq (6|m'|)/(5|m'| + (1/\kappa)|m'|) = 6/(5 + 1/\kappa) > 1$. So the lemma follows if there exists an interval $m \subset t$ with $|g(m)| \geq |g(t)|/3$ and $|m'|/|m| \geq \kappa$.

In this paragraph we show that such an interval m always exists. Let $l, j, r \subset t$ be as in assumption (b) of the lemma. By the previous paragraph we may assume that $|j'| \leq \kappa|j|$ and $|t'| \leq \kappa|t|$. Since $(|g(t)|/|t|)(|g(j)|/|j|) \geq c \cdot (|g(l)|/|l|)(|g(r)|/|r|)$, it follows that either $|l'|/|l| \leq \kappa/\sqrt{c}$ or $|r'|/|r| \leq \kappa/\sqrt{c}$. Let us show that neither is possible when λ is large and $\kappa > 1$ is close to 1. Let α be the component of $[0, 1] \setminus t$ containing 0 and let $\alpha' = g(\alpha)$. If $|l'|/|l| \leq \kappa/\sqrt{c}$ then (by assumption (a)), $|\alpha' \cup l'|/|\alpha \cup l| \leq |\alpha' \cup l'|/|l| \leq (|\alpha' \cup l'|/|l'|)(\kappa/\sqrt{c}) \leq ((3/\lambda) + 1)(\kappa/\sqrt{c}) < 1$, where, using assumption (b) when $\alpha' \neq 0$, the last inequality holds if λ is large enough and $\kappa > 1$ sufficiently close to 1. Hence g has a fixed point in $\alpha \cup l$, a contradiction. If $|r'|/|r| \leq \kappa/\sqrt{c}$ then (by assumption (a) and because by the previous paragraph we can assume $|l'| \leq \kappa|l|$, $|j'| \leq \kappa|j|$), $|\alpha' \cup l' \cup j' \cup r'|/|\alpha \cup l \cup j \cup r| \leq |\alpha' \cup l' \cup j' \cup r'|/|l \cup j \cup r| \leq (1+1/\lambda)(|l' \cup j' \cup r'|/|l \cup j \cup r|) \leq (1+1/\lambda)(3/(1/\kappa+1/\kappa+\sqrt{c}/\kappa)) < 1$, provided λ is large enough and $\kappa > 1$ sufficiently close to 1. Hence g has a fixed point in $\alpha \cup l \cup j \cup r$, a contradiction. \square

Lemma 4.13. *There exists $c > 1$ and for each $\delta > 0$ there exists $c(\delta) > 1$ with the following properties: Assume that $j \subset t$ are sufficiently small intervals and denote the components of $t \setminus j$ by l and r . Write $l' = f^s(l)$, $j' = f^s(j)$ and $r' = f^s(r)$ and assume that $|l'| = |j'| = |r'|$. Moreover assume that $f^s|_t$ is a diffeomorphism and that there exists an interval $\hat{t} \supset t$ so that $\hat{t}, \dots, f^s(\hat{t})$ has intersection multiplicity ≤ 6 and so that $f^s(\hat{t})$ contains a 1-scaled neighbourhood of $f^s(t)$. Then the following properties hold.*

- (a) *If $f^s|_t$ has a critical point in its boundary, then one has the following cross-ratio inequality $(|f^s(t)|/|t|)(|f^s(j)|/|j|) \geq c \cdot (|f^s(l)|/|l|)(|f^s(r)|/|r|)$.*
- (b) *if the interval t is so that $|t| \geq \delta \text{dist}(t, c)$ for some critical point c of f , then one has $(|f^s(t)|/|t|)(|f^s(j)|/|j|) \geq c(\delta) \cdot (|f^s(l)|/|l|)(|f^s(r)|/|r|)$.*

Proof. Let l_i, j_i, r_i be the pullbacks of l', j, r' contained in $f^i(t)$. By assumption of statement (b) and the real Koebe lemma, it follows that there exists a universal constant $K < \infty$ (which does not depend on the interval t) so that $1/K \leq |l_i|/|j_i|, |r_i|/|j_i| \leq K$. If t is so that $|t| \geq \delta \text{dist}(t, c)$, then the result follows immediately from Lemma 4.3. Alternatively there exists i so that t_i has a critical point in its boundary, and then again $(|f(t_i)|/|t_i|)(|f(j_i)|/|j_i|) \geq c \cdot (|f(l_i)|/|l_i|)(|f(r_i)|/|r_i|)$ and $(|f^s(t)|/|t|)(|f^s(j)|/|j|) \geq \cdot (|f^s(l)|/|l|)(|f^s(r)|/|r|)$ follow from Lemma 4.3. \square

Let us now continue with the proof of Proposition 4.11. Let T_0^\pm denote the components of $T_0 \setminus K$. Let u be the fixed point of f^s in ∂K and take T_0^+ to be the component of $T_0 \setminus K$ containing u in its boundary. There is no loss in generality in assuming that u is the right endpoint of ∂K and that $f^s|_{T_0^+}$ is increasing. Take t be the interval in T_0^+ containing u so that $|f^s(t)| = (1/2)|f^s(T_0^+)|$. Note that since T_s contains a δ -neighbourhood of K , we have $|f^s(t)| \geq (\delta/2)|K|$. By Koebe, there exists $\delta' > 0$ so that $|t| \geq \delta'|K|$ and therefore $|t| \geq \delta' \text{dist}(t, c)$ for some critical point c of f .

Divide t into intervals t_0, \dots, t_m so that u is in the closure of t_0 , so that t_i is closer to u than t_{i+1} and so that the common boundary points of t_i and t_{i+1} are critical points of f^s (so

m is at most the number of critical points of odd order of f). Let $t'_i = f^s(t_i)$ be the image of these intervals in $T_s \setminus K$. So $|t'_0 \cup \dots \cup t'_s| \geq (\delta/2)|K|$. Moreover, let t_{-i} be the corresponding intervals in the other component of $T_0 \setminus K$ with $f(t_{-i}) = f(t_i)$. Since K contains a critical point of even order, $|t_i|/|t_{-i}|$ is approximately equal to one, and $f^s(t_{-i}) = f^s(t_i) = t'_i$.

Now take the universal constant $c > 1$ as in Lemma 4.13. Next take the universal constants $\lambda > 1$ and $\kappa > 1$ associated to $c > 1$ as in Lemma 4.12. Next take $i \in \{0, 1, \dots, m\}$ minimal so that $|t'_i| \geq \lambda|t'_0 \cup \dots \cup t'_{i-1}| + \epsilon$ where $\epsilon := (1 + \lambda)^{-(m-1)}(\delta/4)|K|$. If no such i exists then we get by induction that $|t'_0 \cup \dots \cup t'_i| \leq (1 + \lambda)^i|t'_0| + (1 + \lambda)^{i-1}\epsilon$ for each $i = 1, \dots, m$ and then $|t'_0| \geq (1 + \lambda)^{-m}|t'_0 \cup \dots \cup t'_m| - (1 + \lambda)^{-1}\epsilon \geq (1 + \lambda)^{-m}(\delta/4)|K|$. Hence, according to Lemma 4.13, there exists a universal constant $c(\hat{\delta}) > 1$ (corresponding to $\hat{\delta} = (1 + \lambda)^{-m}(\delta/4)|K|$) so that the corresponding cross-ratio inequality holds. This means that we can apply Lemma 4.12 taking for x, y in the left resp. the right endpoint of t_0 (so $x = u$). Hence there exist a universal constant $\kappa > 1$ and an interval $j = (a, b) \subset t_0$ with $|g(j)|/|j| \geq \kappa$, $|g(j)| \geq \hat{\delta}/3$ and $g(b)/b \geq \kappa$. This means that in this case we can take $\hat{K} = (a_-, a)$ and $\hat{K}' = (b_-, b)$, where a_-, b_- are in T_0^- with $f(a_-) = f(a)$ and $f(b_-) = f(b)$. Note that if c is the turning point in K then $|a_- - c|/|a - c|$ and $|b_- - c|/|c - b|$ are close to one, when s is large (and therefore T_0 is small). By redefining κ the required properties in Proposition 4.11 hold.

On the other hand, if there exists i with $|t'_i| \geq \lambda|t'_0 \cup \dots \cup t'_{i-1}| + \epsilon$ then, because $|t'_i| \geq \lambda|t'_0 \cup \dots \cup t'_{i-1}|$ we can apply the first part of Lemma 4.13 and Lemma 4.12 to obtain again an interval $j_i = (a, b) \subset t_i$ with $|j'_i|/|j_i| \geq \kappa$, $|j'_i| \geq |t'_i|/3$ and $|f^s(b) - u|/|b - u| \geq \kappa$ where b is the right endpoint of j_i . Note that $|t'_i| \geq \epsilon$ and so $|j'_i| \geq \epsilon/3$. So we can take in this case $\hat{K} = (a_-, a)$ and $\hat{K}' = (b_-, b)$, where as before a_-, b_- are in T_0^- with $f(a_-) = f(a)$ and $f(b_-) = f(b)$. Again by redefining κ the required properties in Proposition 4.11 hold. \square

4.5.3. Real bounds in the reluctantly recurrent case. A subset $\Omega \subset \text{Crit}(f)$ is called a *block* if it is contained in a connected component of the graph of critical points, as defined in Subsection 4.4 and if $\text{Back}(c) \subset \Omega$ for all $c \in \Omega$. A block of critical points is called *non-trivial* if it is disjoint from the basins of periodic attractors and there exists $c \in \Omega$ with infinite forward orbit. Let Ω_r be a non-trivial block of critical points such that each recurrent critical point in Ω_r is reluctantly recurrent, and if Ω' is the component of the graph of critical points that contains Ω_r , then f is not infinitely renormalizable at any $c' \in \Omega'$.

Let $\text{Dom}_{\Omega_r}(I)$ denote the union of the components of the domain of the return mapping to I which intersect the orbit of c for some $c \in \Omega_r$. Let $\text{Dom}'_{\Omega_r}(I) = \text{Dom}_{\Omega_r}(I) \cup I$ and $\text{Dom}^*_{\Omega_r}(I) = \text{Dom}_{\Omega_r}(I) \cap I$. We let $R_I: \text{Dom}^*_{\Omega_r}(I) \rightarrow I$ denote the first return mapping to I restricted to $\text{Dom}^*_{\Omega_r}(I) \rightarrow I$. Let I be a real neighbourhood of Ω_r such that each component of I contains exactly one critical point in Ω_r and for each component J of $\text{Dom}_{\Omega_r}(I)$ either J is a component of I or J is compactly contained in a component of I .

Let

$$C_1(\Omega_r) = \Omega_r \setminus \text{Dom}_{\Omega_r}(I) \text{ and } C_2(\Omega_r) = \{c' \in \Omega_r : I(c') \subset \text{Dom}_{\Omega_r}(I)\}.$$

For intervals $J \subset T$, we let L and R denote the components of $T \setminus J$ and define

$$\text{Gap}(L, R) = \frac{1}{\text{Space}(T, J)} := \frac{|T||J|}{|L||R|}.$$

We define $\text{Gap}(I)$ by

$$\text{Gap}(I) = \inf_{(J_1, J_2)} \text{Gap}(J_1, J_2),$$

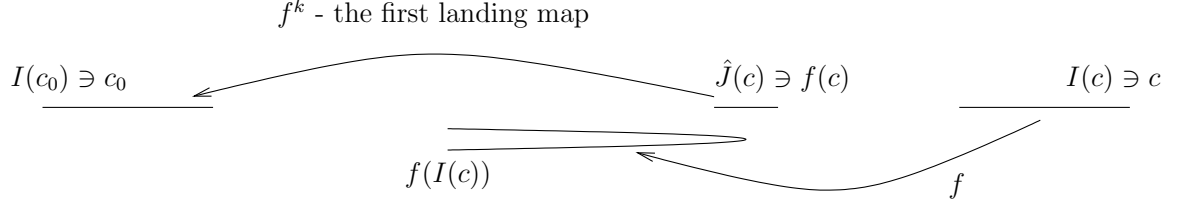
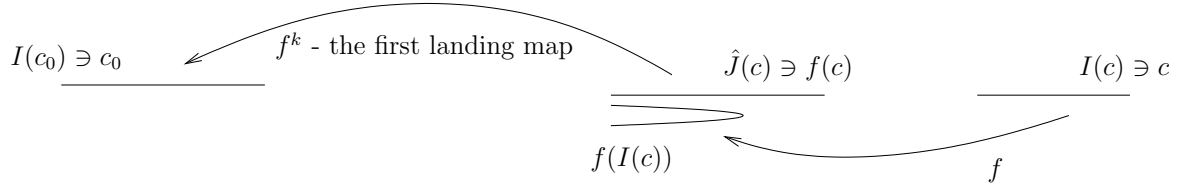
 FIGURE 8. When $\text{Cen}_1(I)$ is small.

 FIGURE 9. When $\text{Cen}_2(I)$ is small.

where (J_1, J_2) runs over all distinct pairs of intervals in $\text{Dom}'_{\Omega_r}(I)$.

Let

$$I^* = \cup_{c' \in C_2(I)} I(c'), \quad I^\# = I \setminus I^*.$$

We define $\text{Space}(I)$ by

$$\text{Space}(I) = \inf_J \text{Space}(\text{Comp}_J I, J),$$

where the infimum is taken over all components J of $\text{Dom}^*_{\Omega_r}(I) \cap I^\#$.

Let $\Omega_{r, \text{even}}$ denote the even critical points in Ω_r . For any $c \in \Omega_r$, let $\hat{J}(c)$ be the component of $\text{Dom}'_{\Omega_r}(I)$ which contains $f(c)$ and define

$$\text{Cen}_1(I) = \max_{c \in \Omega_{r, \text{even}} \setminus C_2(I)} \frac{|\hat{J}(c)|}{|f(I(c))|},$$

$$\text{Cen}_2(I) = \max_{c \in C_2(I) \cap \Omega_{r, \text{even}}} \left(\left| \frac{|\hat{J}(c)|}{|f(I(c))|} - 2 \right| \right),$$

and $\text{Cen}(I) = \max(\text{Cen}_1(I), \text{Cen}_2(I))$. Figures 8 and 9 indicate the arrangement of intervals when these quantities are small. It is important to notice that in the definition of $\text{Cen}_1(I)$ and $\text{Cen}_2(I)$ we only take the max over the even critical points. For odd critical points, having $\text{Space}(I)$ big implies that $\text{Cen}_1(I)$ is small, and we do not require the bound on $\text{Cen}_2(I)$ to control the loss of angle when we pull back a Poincaré disk through an odd critical point, see Lemma 3.9.

We decompose Ω_r it into two parts:

- $\Omega_{r, e}$ is a set of critical points in Ω_r so that if $c \in \Omega_{r, e}$ has odd order, then there exists $c' \in \Omega_{r, e}$ with even order so that $c \geq c'$, where we use the ordering from Subsection 4.4.
- $\Omega_{r, o} = \Omega_r \setminus \Omega_{r, e}$.

Observe that $\Omega_{r, e}$ is not the same as $\Omega_{r, \text{even}}$. It follows from the definition that for each $c \in \Omega_{r, o}$ and each critical point $c' \in \omega(c)$ we have that either

- c' is a critical point of odd order,
- $\omega(c')$ is persistently recurrent,

- c' is in the basin of a periodic attractor or
- c' is eventually mapped into a periodic interval where the mapping is infinitely renormalizable.

Proposition 4.14 (Prop. 3 of [KSvS2]). *Let Ω be either $\Omega_{r,e}$ or $\Omega_{r,o}$. For any $\varepsilon > 0$ and $C > 0$, there exists an arbitrarily small admissible neighbourhood I of Ω such that $\text{Gap}(I) > C$, $\text{Space}(I) > C$ and $\text{Cen}(I) < \varepsilon$.*

Proof. We will only give an outline, and we will refer heavily to [KSvS2]. In the notation of [KSvS2], one should take as Ω either the set $\Omega_{r,e}$ or the set $\Omega_{r,o}$.

As we shall see below, the proof for the case that we take $\Omega_{r,o}$ is unchanged. Indeed critical points $c \in \Omega_{r,o}$ do not accumulate on other reluctantly recurrent critical points c' , such that c' has even order. Of course c can accumulate on a critical point c' for which $\omega(c')$ is persistently recurrent and which has even order, but these critical points c' will not cause troubles.

So let us concentrate the discussion on the case that $\Omega_{r,e}$ (and implicitly explain why the original proof goes through for $\Omega_{r,o}$). So define an admissible open set I of $\Omega_{r,e}$ as in [KSvS2]. By the definition of $\Omega_{r,e}$, each critical point of odd order in $\Omega_{r,e}$ is eventually mapped into I . So for each $c \in \Omega_{r,e}$ of odd degree we can define $\hat{I}_c = \mathcal{L}_c(I)$ (here \mathcal{L} is defined as in Section 3) and

$$(4.1) \quad \hat{I} = \bigcup_c \hat{I}_c \cup I,$$

where the union runs over all critical point of odd degree in $\Omega_{r,e}$. Note that \hat{I} is an admissible open neighbourhood of $\Omega_{r,e}$.

Note that in [KSvS2], Proposition 3, I is of the form $T_N = \mathcal{A}^N(T)$, see page 159 of [KSvS2], and that for each critical point c ,

$$(4.2) \quad T_N \text{ is well-inside } T_{N-1} \text{ and } T_N \supset \text{Comp}_c(\text{Dom}(T_N)),$$

see line 3, page 158 on [KSvS2]).

The proof of Proposition 4, given in [KSvS2] is for maps with a non-recurrent critical point. This goes through as before (since the results in [vSV1] work for critical points of all orders). So we suppose that c is reluctantly recurrent at a critical point c . We need to show that the following claim holds: for any $C > 0$ and any $c \in \Omega$, there exists an arbitrarily small C -nice interval. By Lemma 6.5 of [KSvS1], for every critical puzzle piece $I(c)$ there exist arbitrarily large positive integers m such that $f^m(c) \in I(c)$, and letting $I^m(c) = \text{Comp}_c f^{-m}(I(c))$, we have that the mapping $f^m : I^m(c) \rightarrow I(c)$ has bounded degree. Since f is at most finitely renormalizable at c , by Theorem A of [vSV1], we can assume that $I(c)$ is δ -nice for some $\delta > 0$, universal. Then by Lemma 3.11 of [CvST], there exists $\eta > 0$ so that if $(1 + 2\eta)I^m(c) \subset I(c)$, $I^m(c)$ is C -nice. Taking m sufficiently big finishes the proof.

In the definition of $\mathcal{A}(T)$ on 156-157 in [KSvS2] it is important that Ω only contains critical points of even order. Let us first explain why a change is needed. If the critical points are of even order, then one can ensure as in [KSvS2] that a nice interval I around a critical point is symmetric around c (in the sense that $f(\partial I)$ consists of one point). This means that if $\mathcal{A}(T)(c)$ is much smaller than $T(c)$, then $\mathcal{A}(T)(c)$ is roughly in the middle of $T(c)$ (and this will be why one can get $\text{Cen}_2(I)$ small). This is no longer true for a nice interval that is not symmetric around a critical point (which certainly can happen for critical points of odd order). Let us make some comments about the definition of $\mathcal{A}(T)(c)$. When

$c \in C_1(T)$, we should ensure that $\text{Space}(T(c), \mathcal{A}(T)(c))$ is large. Since we want $\mathcal{A}(T)$ to be a nice neighbourhood of Ω we do this by taking $\mathcal{A}(T)(c)$ so that its boundary points are also boundary points of domains of R_T . (This is possible since R_T has infinitely many domains which accumulate from both sides to c .) Note that this part of the construction is not combinatorially defined, but if two maps are conjugate, then one can make a choice a combinatorial choice which works for both maps. When $c \in C_2(T)$ then take $\mathcal{A}(T)(c)$ to be the maximal interval containing c such that $R_T^{k(c)}(\mathcal{A}(T)(c))$ is contained in a component of $\text{Dom}(T)$. (What was written here in [KSvS2] was a typo.)

Then Lemma 3 holds as before except that in statements (2) and (3) ‘diffeomorphically’ should be replaced by ‘homeomorphically’. Note that $k(c)$ is bounded by $\#\Omega$ because otherwise one of the components of I would be periodic, and also note that the pullback of T to $J(c)$ meets at most $\#\Omega$ of critical points (all of odd order). Then Lemma 4 goes through as before. As stated in [KSvS2], Lemma 5 is only valid for maps without parabolic periodic orbits (this is the context in which Theorem 3 in [KSvS2] was used in that paper). However, all we need is Lemma 4.2 of this paper which holds even for maps with parabolic periodic points. The proof of Lemma 6 goes through as before (note that not only $|\mathcal{A}(T)(c)|/|T(c)|$ but also $\text{Space}(T(c), \mathcal{A}(T))$ is large). Lemma 7 also goes through: in the final paragraph it is shown that $\text{Cen}_2(\mathcal{A}(T))$ is small, which holds because c' is a critical point of even order and so $\mathcal{A}^2(T(c'))$ and $\mathcal{A}(T)(c')$ are symmetric around c' . This allows us to argue as before: although the presence of critical points of odd order implies that $f^s: J \rightarrow f^s(J)$ extends merely to a homeomorphism onto $T(c')$, but as the order of the corresponding chain is still bounded by the number of critical points, we can use part (2) of Lemma 4.2 to pull back the space. \square

5. COMPATIBLE COMPLEX BOX MAPPINGS AND COMPLEX BOUNDS

Let \mathbf{U} and \mathbf{V} be open Jordan disks in \mathbb{C} . We say that a mapping $F: \mathbf{U} \rightarrow \mathbf{V}$ is a K -qr branched covering if it can be decomposed as $F = G \circ H$, where $H: \mathbf{U} \rightarrow \mathbf{U}$ is K -qr homeomorphism and $G: \mathbf{U} \rightarrow \mathbf{V}$ is a holomorphic branched covering.

A mapping $F: \mathbf{U} \rightarrow \mathbf{V}$ is a *holomorphic box mapping* if F is holomorphic and \mathbf{U} and \mathbf{V} are open subsets of the complex plane where

- \mathbf{V} is a union of finitely many pairwise disjoint Jordan disks;
- every connected component \mathbf{V} of \mathbf{V} is either a connected component of \mathbf{U} or $\mathbf{V} \cap \mathbf{U}$ is a union of Jordan disks with pairwise disjoint closures that are compactly contained in \mathbf{V} ;
- for each component \mathbf{U} of \mathbf{U} , $F(\mathbf{U})$ is a component of \mathbf{V} and $F|_{\mathbf{U}}$ is a proper mapping with at most one critical point;
- each connected component of \mathbf{V} contains at most one critical point of F ;
- each component of \mathbf{U} is either a component of \mathbf{V} or it is compactly contained in \mathbf{V} .

If F is as in the definition of holomorphic box mapping, except that F is not holomorphic, but instead there exists $K \geq 1$ such that for each component \mathbf{U} of \mathbf{U} , $F|_{\mathbf{U}}$ is a K -qr branched covering onto its image, a connected component of \mathbf{V} , we call F a K -qr box mapping. We will use the terminology *complex box mapping* to refer to both holomorphic box mappings and to K -qr box mappings, and unless otherwise stated, we assume that covering maps are quasiregular. A K -qr box-mapping whose domain has exactly one component is called a K -qr polynomial-like mapping. We define the *filled Julia set* of a K -qr box mapping (which

includes the case of a K -qc polynomial-like mapping) $F: \mathcal{U} \rightarrow \mathcal{V}$ to be

$$K(F) = \{z \in \mathcal{U} : f^n(z) \in \mathcal{U} \text{ for all } n = 0, 1, 2, \dots\},$$

and we define the *Julia set* of $F: \mathcal{U} \rightarrow \mathcal{V}$ to be $J(F) = \partial K(F)$. The filled Julia set of a complex box mapping is compactly contained in its domain.

We shall need to use the *gap condition* and the *extension condition*. The *gap condition* states that there exists $\delta > 0$ so that for each two components \mathbf{U}_i and \mathbf{U}_j of \mathcal{U} there exist $\mathbf{U}'_i \supset \mathbf{U}_i$ and $\mathbf{U}'_j \supset \mathbf{U}_j$ so that

- (1) $\text{mod}(\mathbf{U}'_i \setminus \mathbf{U}_i) \geq \delta$ and $\text{mod}(\mathbf{U}'_j \setminus \mathbf{U}_j) \geq \delta$ and
- (2) either $\mathbf{U}'_i \cap \mathbf{U}_j = \emptyset$ or $\mathbf{U}'_j \cap \mathbf{U}_i = \emptyset$;
- (3) in addition, if \mathbf{U}_i is contained in the component \mathbf{V}_i of \mathcal{V} , then either $\mathbf{V}_i = \mathbf{U}_i$ or $\text{mod}(\mathbf{V}_i \setminus \mathbf{U}_i) \geq \delta$.

The *extension condition* requires that there exist $\delta > 0$ and $\mathcal{V}' \supset \mathcal{V}$ so that for each component \mathbf{U}_i of \mathcal{U} there exists $\mathbf{U}'_i \supset \mathbf{U}_i$ so that

- (1) $\text{mod}(\mathbf{V}'_j \setminus \mathbf{V}_j) \geq \delta$ for each component \mathbf{V}'_j of \mathcal{V}' and with \mathbf{V}_j the component of \mathcal{V} contained in \mathbf{V}'_j , and
- (2) if $F(\mathbf{U}_i) = \mathbf{V}_j$ then there exists a K' -quasiregular extension of F to \mathbf{U}'_j so that $F: \mathbf{U}'_i \rightarrow \mathbf{V}'_j$ is a branched covering with the same degree as $F: \mathbf{U}_i \rightarrow \mathbf{V}_j$ (usually, $K' \leq 1 + \mu(\mathbf{V}'_j)$).

These conditions will enable us to control the shape of the domains \mathbf{U}_i , which helps us in constructing quasiconformal homeomorphisms on $\mathcal{V} \setminus \mathcal{U}$, see Theorem 7.1.

A component of $F^{-n}(\mathbf{V})$ of a component \mathbf{V} of the range \mathcal{V} will be called a *puzzle piece of level n* . It is important to observe that puzzle pieces are either nested or disjoint.

Definition 5.1 (Renormalizable box mapping). A box mapping $F: \mathcal{U} \rightarrow \mathcal{V}$ is called *renormalizable* at $c \in \text{Crit}(F)$ if there exists $s > 1$ (called the *period*) and a puzzle piece \mathbf{W} containing a critical point c of f such that $f^{ks}(c) \in \mathbf{W}$, $\forall k \geq 0$.

5.1. Compatible complex box mappings and bounds at persistently recurrent points. Suppose that $F: \mathcal{U} \rightarrow \mathcal{V}$ is a K -qr box mapping. Let $\rho > 0$. Let \mathbf{V} be a component of \mathcal{V} . We say that \mathbf{V} is ρ -nice, if for each $x \in \mathbf{V} \cap \omega(c_0)$, we have that $\text{mod}(\mathbf{V} \setminus \mathcal{L}_x(\mathbf{V})) > \rho$. We say that \mathbf{V} is ρ -free if there exist puzzle pieces \mathbf{P}^+ and \mathbf{P}^- such that $\mathbf{P}^- \subset \mathbf{V} \subset \mathbf{P}^+$, and both $\text{mod}(\mathbf{V} \setminus \mathbf{P}^-), \text{mod}(\mathbf{P}^+ \setminus \mathbf{V}) > \rho$. See page 29 for the definition of bounded geometry.

The following is the main theorem of [CvST].

Theorem 5.1 (Complex bounds at persistently recurrent critical points). *There exist $\rho > 0$ and $C > 0$, universal, such that for each n sufficiently large the following holds. Suppose that $f \in \mathcal{A}_b^3(M)$. Suppose that c_0 is a critical point such that f is persistently recurrent on $\omega(c_0)$.*

- (1) *If f is finitely renormalizable, there exists an arbitrarily small, combinatorially defined, nice real neighbourhood I of $\text{Crit}(f) \cap \omega(c_0)$ such that the first return mapping to I extends to a K_n -qr box mapping $F: \mathcal{U} \rightarrow \mathcal{V}$ with $\text{Crit}(F) = \text{Crit}(f) \cap \omega(c_0)$ that is ρ -extendible and such that the components of \mathcal{V} are ρ -nice, ρ -free, the components of \mathcal{U} and \mathcal{V} have ρ -bounded geometry, and there exists $\theta' \in (0, \pi)$ such that each component \mathbf{U} of \mathcal{U} or \mathcal{V} there exists an interval \tilde{U} such that \mathbf{U} is contained in $D_{\theta'}(\tilde{U})$, \mathbf{U} is well-inside \tilde{U} and $(\tilde{U} \setminus \mathbf{U}) \cap \omega(c_0) = \emptyset$.*

- (2) If f is infinitely renormalizable, then for all s sufficiently big, if J is a periodic interval for f of period s , then $f^s: J \rightarrow J$ extends to a $K(\mathbf{V})$ -qr polynomial-like mapping $F: \mathbf{U} \rightarrow \mathbf{V}$ with $\text{Crit}(F) = \text{Crit}(f)$, $\text{mod}(\mathbf{V} \setminus \mathbf{U}) > \rho$, \mathbf{U} has ρ -bounded geometry and $\text{diam}(\mathbf{U}) < C|J|$.

Here K_n and $K(\mathbf{V})$ are defined (up to a constant multiple) as follows. Let $\mu_n = \max \text{diam}(\mathbf{J})$, where the maximum is taken over all pullbacks \mathbf{J} of \mathbf{V} that intersect $\omega(c_0)$. Set $K_n = (1 + \mu_n)/(1 - \mu_n)$. Observe that μ_n is small when $|I_n|$ is small. Similarly, if $F: \mathbf{U} \rightarrow \mathbf{V}$ is a polynomial-like mapping that extends the return map $f^s: J \rightarrow J$, where J is a periodic interval, we define

$$\mu(\mathbf{V}) = \max_{1 \leq i \leq s} \text{diam}(\text{Comp}_{f^i(c_0)} f^{-(s-i)}(\mathbf{V})) \text{ and } K(\mathbf{V}) = (1 + \mu(\mathbf{V}))/ (1 - \mu(\mathbf{V})).$$

Again $\mu(\mathbf{V})$ is close to zero when \mathbf{V} is small.

In the finitely renormalizable (and persistently recurrent) case, the intervals $I(c_0)$ in the theorem are given by the enhanced nest about c_0 (see [KSvS1] and [CvST] where the infinitely renormalizable case was considered).

5.1.1. *Extending complex box mappings when $\omega(c)$ is persistently recurrent.* By Theorem 5.1, if c is a persistently recurrent critical point at which f is at most finitely renormalizable, we have that there exist arbitrarily small nice real neighbourhoods I_1 of $\text{Crit}(f) \cap \omega(c)$ for which there exists a complex box mapping that extends $R_{I_1}: \text{Dom}_{\omega(c)}(I_1) \rightarrow I_1$. In this subsection we will still assume that c is persistently recurrent, but want to consider also (infinitely many) branches of R_{I_1} which do *not* intersect $\omega(c)$. In fact, we need to treat different omega limit sets, $\omega(c)$, on which f is persistently recurrent simultaneously.

So let Ω be any connected component of the graph associated to the set of critical points. We proceed exactly as in Subsection 4.4: First, decompose $\Omega = \Omega_0 \cup \Omega_1 \cup \Omega_2$. Recall that Ω_0 are critical points that are either contained in a basin of attraction of f or at which f is infinitely renormalizable, Ω_1 are the critical points at which f is persistently recurrent and at most finitely renormalizable and Ω_2 are the critical points at which f is reluctantly recurrent or nonrecurrent. Now, identify a smallest subset Ω'_1 with

$$\cup_{c \in \Omega'_1} \omega(c) = \cup_{c \in \Omega_1} \omega(c).$$

Choose a neighbourhood I_1^{Ω} of Ω'_1 and choose neighbourhoods $I_0^{\Omega}, I_1^{\Omega}, I_2^{\Omega}$ of $\Omega_0, \Omega_1, \Omega_2$, respectively, as in Subsection 4.4. Let

$$\mathcal{I} = \bigcup_{\text{connected components } \Omega} (I_0^{\Omega} \cup I_1^{\Omega} \cup I_2^{\Omega}).$$

Recall that we choose the intervals around the critical points so that \mathcal{I} is a nice set. From now on, we will drop the superscript Ω from the notation.

Let

$$\text{Dom}_{\text{diff}}(I_1) \subset I'_1$$

be the union of the components J of $\text{Dom}(I_1)$ which are *inside* I'_1 and which

- (1) do *not* intersect $\bigcup_{c \in \Omega_1} \omega(c)$;
- (2) if s is the return time of J to I_1 , then $f^i(J) \cap \mathcal{I} = \emptyset$ for all $i = 0, 1, \dots, s - 1$.

So $f^s|_J$ is a diffeomorphism. It will be important to consider the first entry map to $I_1 \cup I_0$ restricted to the above sets because we will need to control orbits of critical points $c' \notin \Omega_1$ which linger for long periods near $\cup_{c \in \Omega_1} \omega(c)$. Let

$$R_{\hat{I}_1} : \text{Dom}_{\Omega_1}(I_1) \cup \text{Dom}_{\text{diff}}(I_1) \cup (\text{Dom}(I_0) \cap I'_1) \rightarrow I_1 \cup I_0.$$

(We write $R_{\hat{I}_1}$ for this first entry map because this mapping is not defined on I_0 .) The mapping $R_{\hat{I}_1}$ will be used to control the pieces of the orbit of c' during which c' remains close to $\omega(c)$. Note that this first return mapping can have infinitely many components

Theorem 5.2 (Complex box mappings in the persistently recurrent case with infinitely many branches included). *There exists $\theta' \in (0, \pi/2)$, such that for each $\theta \in (0, \theta')$, there exists an integer $m > 0$, $\delta > 0$ and a complex box mapping $F_{it} : \mathbf{U}_{it} \rightarrow \mathbf{V}_{it}$, which is an extension of the m -th iterate of $R_{\hat{I}_1}$. For each $c \in \Omega'_1 \cup \Omega_0$, the component $\mathbf{V}(c)$ of \mathbf{V}_{it} is a Poincaré lens domain based on $I(c)$, that is,*

$$\mathbf{V}(c) = D_{\pi-\theta}(I(c)).$$

Moreover, $F_{it} : \mathbf{U}_{it} \rightarrow \mathbf{V}_{it}$ satisfies the extension and gap properties, and if \mathbf{D} is any component of either \mathbf{U}_{it} or \mathbf{V}_{it} , then \mathbf{D} has δ -bounded geometry.

Proof. Let $F_{\Omega_1} : \mathbf{U}_{\Omega_1} \rightarrow \mathbf{V}_{\Omega_1}$ be the box mapping given by Theorem 5.1 which extends the real return mapping to I_1 . Note that we are free to choose I_1 so that this extension exists. First, observe that by Propositions 4.10 and 4.11, the following real analogues of the extension and gap properties hold for $R_{\hat{I}_1}$:

- (1) there exists a constant $\rho > 0$ such that if J is a component of $\text{Dom}(R_{\hat{I}_1})$, then either J is a component of I_1 , J is well-inside I_1 , or J is disjoint from $I_0 \cup I_1$ and $J \cap \left(\cup_{c \in \Omega_1} \omega(c) \right) \neq \emptyset$;
- (2) for any components J_1 and J_2 of $\text{Dom}(R_{\hat{I}_1})$, there exist $J'_i \supset J_i$ such that J_i is well-inside J'_i is for $i = 1, 2$;
- (3) either $J_1 \cap J'_2 = \emptyset$ or $J_2 \cap J'_1 = \emptyset$;
- (4) there exists a set I' with $I' \supset I_0 \cup I_1$ such that for each component $I(c)$ of $I_0 \cup I_1$, there exists a component $I'(c)$ of I' such that $I(c)$ is well-inside $I'(c)$;
- (5) for each component J of $\text{Dom}(R_{\hat{I}_1})$, there exists an interval $J' \supset J$ such that if $R_{\hat{I}_1} : J \rightarrow I(c)$, then $R_{\hat{I}_1}|_J$ extends to a mapping from J' to $I'(c)$ with the same degree as $R_{\hat{I}_1}|_J$, where $I'(c)$ is the interval from (4).

Let $c \in \Omega_0 \cup \Omega_1$. Notice that we cannot rule out that there are critical points $c' \in \Omega_2$ which enter $(1 + 2\delta)I(c)$, where $I(c)$ is the component of $I_0 \cup I_1$ that contains c . However, any first entry domain $J = \mathcal{L}_x((1 + 2\delta)I(c))$ with $x \in \omega(c)$, does not contain any critical point $c' \notin \omega(c)$ provided that $I(c)$ is sufficiently small: if $c' \notin \omega(c)$ was a critical point with $c' \in J$ then J is an interval that contains both c' and $x \in \omega(c)$, which is a first entry domain to $(1 + 2\delta)I(c)$. This is impossible by the absence of wandering intervals.

Let us now show that the required complex extension exists. Let $\theta_0, \theta_1 \in (0, \pi/2)$. Let $\theta = \max\{\theta_0, \theta_1\}$. For each $c \in \Omega_0$ let $\mathbf{V}(c) = D_{\pi-\theta_0}(I(c))$, and for each $c \in \Omega'_1$ let let $\mathbf{V}(c) = D_{\pi-\theta_1}(I(c))$. For each $c \in \Omega_1 \setminus \Omega'_1$ let $s_c > 0$ be smallest so that $f^{s_c}(c) \in I(c')$ for some $c' \in \Omega'_1 \cup \Omega_0$, and set $\mathbf{V}(c) = \text{Comp}_c f^{-s_c}(\mathbf{V}(c'))$. Provided that $I_0 \cup I_1$ is sufficiently small, the domains $\mathbf{V}(c)$, $\mathbf{V}(c')$, $c \neq c'$, are disjoint. Let $\mathbf{V} = \cup_{c \in \Omega_0 \cup \Omega_1} \mathbf{V}(c)$. Taking θ_0, θ_1 , smaller if necessary (see below), this will be the range of the complex box mapping we construct.

For each component J of $\text{Dom}_{\Omega_1}(I_1) \cup \text{Dom}_{\text{diff}}(I_1) \cup (\text{Dom}(I_0) \cup I'_1)$ Let $s_J > 0$ be minimal so that $f^{s_J}(J) \subset I_1 \cup I_0$, let c denote the critical point contained in the component of $I_0 \cup I_1$ containing $f^{s_J}(J)$, and set $\mathbf{U}'_J = \text{Comp}_J f^{-s_J}(\mathbf{V}(c))$. Define a complex extension of $R_{\hat{I}_1}$, $\hat{F}: \mathbf{U}' \rightarrow \mathbf{V}$ by $\hat{F}(\mathbf{U}'_J) = f^{s_J}(\mathbf{U}'_J)$. Note that $\hat{F}: \mathbf{U}' \rightarrow \mathbf{V}$ is not a box mapping, since we cannot ensure that the components of the domain are compactly contained in the range.

By [CvST], Corollary 10.2, there exist $\theta' \in (0, \pi)$ and an interval $\tilde{J} \supset J$ such that $\mathbf{U}_{\Omega_1}(J) \subset D_{\theta'}(\tilde{J})$. Moreover, J is well-inside \tilde{J} and $(\tilde{J} \setminus J) \cap \omega(c_0) = \emptyset$. This implies that the components of the complex pullbacks lie close to their real traces. Moreover, $R_{\hat{I}_1}$ is a diffeomorphism on each component of $\text{Dom}_{\text{diff}}(I_1) \cup (\text{Dom}(I_0) \cap I'_1)$, which implies by Lemma 3.15 that pulling back along these branches results in little loss of angle.

Claim 1: There exists m such that each component of $\hat{F}^{-m}(\mathbf{V})$ which intersects the real line is well-inside of \mathbf{V} .

Proof of Claim 1: First, consider the case when $\hat{F}^m(J) \cap I_0 = \emptyset$. Then \hat{F}^m corresponds to m iterations of \hat{F} . Assume that m is large and consider a component J of $R_{\hat{I}_1}^{-m}(I_1)$ and the corresponding domain $\mathbf{U}'_J = \text{Comp}_J f^{-m}(\mathbf{V})$. Let I_J be the component of I_1 that contains J . Let $0 \leq k \leq m$ be maximal so that $(R_{\hat{I}_1})^k(J)$ is contained in $\text{Dom}_{\text{diff}}(I_1)$. Then $(R_{\hat{I}_*})^{k+1}$ is a diffeomorphism on J . This holds because when $c \in \Omega_1$, then $\omega(c)$ does not intersect $\text{Dom}_{\text{diff}}(I_1)$, and, moreover, by the definition of the domain of $R_{\hat{I}_1}$, the iterates of J under $R_{\hat{I}_1}$ up to the $k+1$ -st, avoid critical points c in Ω_2 . Indeed, one can find an interval $J_k \supset J$ such that $(R_{\hat{I}_1})^{k+1}(J_k)$ is a component of I_1 and $(R_{\hat{I}_1})^{k+1}$ is a diffeomorphism on J_k . Since f has no wandering intervals, $|J_k|/|I_J|$ is small if k is large. Since each component of the domain of $R_{\hat{I}_1}$ is well-inside the component of I_1 that contains it, it follows that there exists a large constant C so that $(1+C)J_k \subset I_J$. Since $\hat{F}^{k+1}(\mathbf{U}'_J)$ is contained in some $\mathbf{U}'_{J'}$, a component of the domain of the first return mapping to \mathbf{V} , we can conclude that \mathbf{U}'_J is well-inside \mathbf{V} when k is large.

Now we consider the case when k is not large. Then $m-k$ is large. Then since the diameters of puzzle pieces tend to zero, each component of $\hat{F}^{-(m-k-1)}(\mathbf{V})$ (that is, each puzzle piece) has very small diameter compared to the component I of I_1 that intersects $\hat{F}^{-(m-k-1)}(\mathbf{V})$. So we can take an interval K with $|K|/|I|$ small and a $\theta' \in (0, \pi)$ that is independent of the choice of J , so that $\text{Comp}_{\mathbf{V}} \hat{F}^{-(m-k-1)}(\mathbf{V}) \subset D_{\theta'}(K)$, but then since J_k is well-inside I , we also get that $\mathbf{U}'_J = \text{Comp}_J \hat{F}^{-m}(\mathbf{V})$ is well-inside \mathbf{V} .

We now consider the remaining case that $\hat{F}^m(J) \subset I_0$. Notice that $I_0 \cap \text{Dom}(R_{\hat{I}_1}) = \emptyset$. Let $k \leq m$ be minimal so that $\hat{F}^k(J) \subset I_0$. Then since $\hat{F}^k|_J$ is a diffeomorphism (as critical points in Ω_1 are minimal), and components of \mathbf{V} with real trace, $I_{0,i}$ are of the form $D_{\pi-\theta_0}(I_{0,i})$, we can take θ_0 so small that $\text{Comp}_J \hat{F}^{-k}(\mathbf{V})$ is well-inside \mathbf{V} . This completes the proof of the claim. \checkmark

Taking $\mathbf{V}_{it} = \mathbf{V}$, chosen as above. For each component J of $R_{\hat{I}_1}^{-m}(I_0 \cup I_1)$, let \mathbf{V}_J be the component of \mathbf{V}_{it} that contains $R_{\hat{I}_1}^m(J)$, and let $\mathbf{U}_J = \text{Comp}_J R_{\hat{I}_1}^{-m}(\mathbf{V}_J)$. Let $\mathbf{U}_{it} = \cup \mathbf{U}_J$ where the union is taken over all components J of the domain of $R_{\hat{I}_1}^m$. Define the mapping

$$F_{it}: \mathbf{U}_{it} \rightarrow \mathbf{V}_{it}$$

by $F_{it}(\mathbf{U}_J) = R_{\hat{I}_1}^m(\mathbf{U}_J)$. Claim 1 implies that if m is chosen sufficiently large that F_{it} is a complex box mapping.

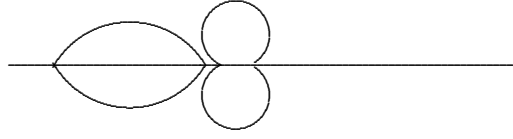

FIGURE 10. Controlling the geometry of F_{it} , see the proof of Theorem 5.2.

Claim 2: The gap and extension conditions hold for the map

$$F_{it}: \mathcal{U}_{it} \rightarrow \mathcal{V}_{it}.$$

Moreover, any component D of either \mathcal{U}_{it} or \mathcal{V}_{it} has δ -bounded geometry.

Proof of Claim 2: That F_{it} satisfies the extension condition follows from Claim 1 and the real bounds at persistently recurrent critical points and at infinitely renormalizable critical points. To see that gap condition holds. Suppose that U_1 and U_2 are two connected components of \mathcal{U}_{it} . If $F_{it}|_{U_1}$ and $F_{it}|_{U_2}$ are both diffeomorphisms, then U_1 and U_2 are both contained in Poincaré lens domains and the gap condition follows from the real bounds. Otherwise let $\{U_j^1\}_{j=0}^{s_1}$ and $\{U_j^2\}_{j=0}^{s_2}$ be the chains so that for $i = 1, 2$ we have that $U_0^i = U_i$ and $U_{s_i}^i$ is a component of \mathcal{V}_{it} . We can assume that $s_1 \leq s_2$. Then $F_{it}^{s_1}(U_0^1)$ is a component V of \mathcal{V}_{it} and $F_{it}^{s_1}(U_2)$ is disjoint from V . Evenmore, by the real bounds, there exists $\theta \in (0, \pi/2)$ so that $F_{it}^{s_1}(U_2) \subset D_\theta(\tilde{U}_2)$, where U_2 is well-inside \tilde{U}_2 . The gap condition follows.

Propositions 4.10 and Lemma 3.13 imply that D has δ -bounded geometry. \checkmark □

5.2. Compatible complex box mappings and bounds at reluctantly recurrent points. In this subsection, we will construct a complex box mapping associated to the set of reluctantly recurrent critical points of f . Note that this includes the case that c is recurrent and $\omega(c)$ is non-minimal.

Let us define Ω_r as on page 47. As before, this set can be decomposed into two parts:

- (1) $\Omega_{r,e}$ is a set of critical points so that if $c \in \Omega_{r,e}$ has odd order, then there exists $c' \in \Omega_{r,e}$ with even order so that $c \geq c'$ (here we use the ordering defined in Subsection 4.4), and
- (2) $\Omega_{r,o}$.

For each $c \in \Omega_{r,o}$, and each critical point $c' \in \omega(c)$ we have that c' is a critical point of odd order in $\Omega_{r,o}$, that f is persistently recurrent on $\omega(c')$, that c' is in the basin of a periodic attractor or that c' is eventually mapped into a renormalization interval (where the mapping is infinitely renormalizable).

Theorem 5.3 (Existence of complex box mappings in the reluctantly recurrent case). *Let $f: [0, 1] \rightarrow \mathbb{R}$ or $f: S^1 \rightarrow S^1$ with periodic orbits be in \mathcal{C} . Let Ω be either $\Omega_{r,e}$ or $\Omega_{r,o}$, as defined above. Then, for any $\theta \in (0, \pi/2)$ there exists arbitrarily small real neighbourhoods I of Ω , such that the first return map $R_I: \text{Dom}_\Omega^*(I) \rightarrow I$ extends to a complex box mapping $F: \mathcal{U} \rightarrow \mathcal{V}$ with the following properties:*

- For each $c \in \Omega$ the set $\mathcal{V}(c)$ is contained in $D_{\pi-\theta}(I(c))$.
- Let $\mathcal{V}(c)^\pm = \mathcal{V}(c) \cap \mathbb{H}^\pm$. Then $\mathcal{V}(c)^+ \setminus \mathcal{U}$ and $\mathcal{V}(c)^- \setminus \mathcal{U}$ are quasidisks.

- *This complex box mapping satisfies the extension and gap conditions defined on page 51.*

The proof of this theorem closely follows the proof of part II of Theorem 3 in [KSvS2, pages 150-159], and therefore we only discuss what changes we have to make in that proof (for the terminology used in the proof we also refer to [KSvS2]). The main difference is that we allow for the existence of critical points of odd order, but we also have to check that the presence of parabolic points does not cause difficulties.

Note that the last two assertions in Theorem 5.3 are new. They are needed because we will want to argue as in the proof of Theorem A' and B' of [LvS2].

This theorem follows immediately from the following proposition from [KSvS2], which holds for critical points of all orders without any essential changes to the proof, and the real bounds for reluctantly recurrent maps, Proposition 4.14. The construction given [KSvS2] was done in the non-minimal case; however, it depends only on certain real geometric conditions, which hold in the reluctantly recurrent case as well.

Proposition 5.4 ([KSvS2] Propostion 1). *There exists $\varepsilon_0 > 0$, $C_0 > 0$ and $\theta \in (0, \pi/2)$, with the following properties. Let I be an admissible neighbourhood of Ω such that $\text{Cen}(I) < \varepsilon_0$, $\text{Space}(I) > C_0$ and $\text{Gap}(I) > C_0$. Additionally, assume that $\max_{c \in \Omega} |I(c)|$ is sufficiently small. Then there exists a real-symmetric complex box mapping $F: \mathcal{U} \rightarrow \mathcal{V}$ whose real trace is a real box mapping R_I and for each critical point c , $\mathcal{V}(c)$ is contained in $D_{\pi-\theta}(I(c))$.*

Proof of Theorem 5.3. Let us make a few remarks. Throughout, we should take for Ω in the proof in [KSvS2], the set $\Omega_{r,e}$ or the set $\Omega_{r,o}$. It is enough to show that one can construct a box mapping $F: \mathcal{U} \rightarrow \mathcal{V}$ extending $R_I: \text{Dom}_\Omega^*(I) \rightarrow I$, because this can be easily extended to a box mapping extending $R_{\hat{I}}: \text{Dom}_\Omega^*(\hat{I}) \rightarrow \hat{I}$: just define for each critical point $c \in \Omega_{r,e}$ of odd order the sets $\mathcal{U}(c) = \mathcal{V}(c) = \mathcal{L}_c(\mathcal{V})$. In the statement of Theorem 5.3, I should then be taken as \hat{I} .

The only place where an assumption $\text{Cen}_2(I)$ is needed is in Lemma 2 (through the first part of the proof of Proposition 1 in [KSvS2]); there the argument goes through (even more easily, and without using any assumption on $\text{Cen}_2(I)$) each time the pullback passes through a critical point of odd order. We need the assumption that $\text{Cen}_2(I)$ is small for critical points of even order to ensure that when we pull back to through an even critical point, the size of the domain on the real line is not very small compared to the diameter of the part that pulls back to the complex plane. Note that the pullback is disjoint, so each critical point is only passed through at most once. The assumption that $\text{Cen}_1(I)$ is small (which means that the critical value $f(c)$ is roughly in the middle of $\hat{J}(c)$) is used in the proof of Proposition 1 of [KSvS2] is at the bottom of page 153 (only in the case of critical points of even order). So that we can choose for the range $\mathcal{V}(c)$ a lens-shaped set of the form $\mathcal{V}(c) = D_{\pi-\theta}(I)$, where $\theta \in (0, \pi/2)$ can be chosen small, but bounded away from zero. As in the statement of Theorem 3 in [KSvS2] we get control of the shape of each domain. In fact, because of (4.2) one has the following extension property. There exists $\delta > 0$ and, for each component \mathbf{V}_j of \mathcal{V} , there exists a neighbourhood $\hat{\mathbf{V}}_j \supset \mathbf{V}_j$, with $\text{mod}(\hat{\mathbf{V}}_j \setminus \mathbf{V}_j) \geq \delta$ such that the following hold:

- (1) If \mathbf{U}_i is a component of \mathcal{U} and $F|_{\mathbf{U}_i} = f^{s_i}$ so that \mathbf{U}_i maps onto \mathbf{V}_j , then there exists a neighbourhood $\hat{\mathbf{U}}_i$ of \mathbf{U}_i so that $f^{s_i}: \hat{\mathbf{U}}_i \rightarrow \hat{\mathbf{V}}_j$ has the same degree as $f^{s_i}: \mathbf{U}_i \rightarrow \mathbf{V}_j$.
- (2) If \mathbf{U}_i is compactly contained in \mathcal{V} , then $\hat{\mathbf{U}}_i$ is contained in \mathcal{V} .

Here one can take for \hat{V}_j a Poincaré disc based on the set \hat{T}_{N-1} defined in (4.2) (where \hat{T}_{N-1} is the set associated to T_N in (4.1). Because T_N is a return domain to T_{N-1} , and all critical points are contained in T_N the above property follows. From this we get that $\text{Comp}_{U_i} f^{-s_i}(\hat{V}_j)$ is a domain with real trace \hat{U} , and we can arrange it so that the above properties hold. All this implies in particular that each U_i has a smooth boundary without cusps and with controlled shape (they have bounded geometry and are 'roughly round').

To show that $A^+ := \mathcal{V}(c)^+ \setminus \mathcal{U}$ is a quasidisc we use the Ahlfors-Buerling Criterion in a similar way as was done on page 440 of [LvS2] This criterion says that ∂A^+ is a quasicircle provided there exists $L < \infty$ with the following property. For any two points z_1, z_2 in $\partial(A^+)$, take one of the two arc C in ∂A^+ connecting z_1 and z_2 is contained in a disc of diameter $L \cdot |z_1 - z_2|$. If z_1, z_2 are in one component of \mathcal{U} this follows from the control of U_i shown above. If z_i and z_2 are in two distinct domains U_i and U_j then this follows from the fact that z_1, z_2 are 'roughly round' and from the gap property of the admissible neighbourhood I : the gap between two domains of R_I in one component of I is large (i.e. the gap between two domains is much large than one of the two domains).

The last item in Theorem 5.3 follows then from Lemma 3(3) in [KSvS2]. □

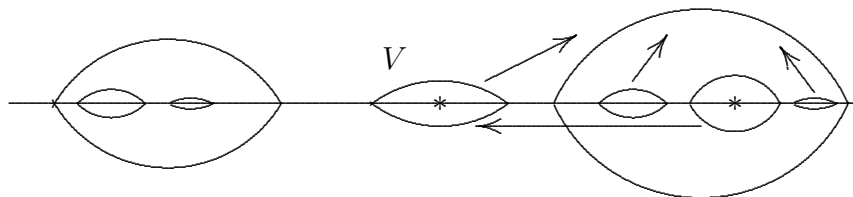

FIGURE 11. The box mapping associated to the non-minimal case has infinitely many components of its domain.

5.3. Complex bounds for central cascades. In this section, we will prove complex bounds for certain puzzle pieces near the top of central cascades. These results are only used in the proof quasisymmetric rigidity for smooth mappings; however, they are new even for polynomials, and are of independent interest. Suppose that $F: \mathcal{U} \rightarrow \mathcal{V}$ is a real-symmetric complex box mapping given by Theorem 5.1, Theorem 5.2 or Theorem 5.3 with $\text{diam}(\mathcal{V})$ sufficiently small.

We will use a nest of puzzle pieces whose construction is closely related to the construction of the enhanced nest. Recall that if F is renormalizable, and the first renormalization $F^s: J \rightarrow J$ of F is not of intersection type, then the enhanced nest construction gives a terminating puzzle piece \mathbf{V}' for F such that the first return mapping $F: \mathbf{U}' \rightarrow \mathbf{V}'$ is a polynomial-like mapping, $\text{mod}(\mathbf{V}' \setminus \mathbf{U}')$ is bounded away from zero and \mathbf{V}' has bounded geometry. We are going to modify the construction of the enhanced nest to produce a puzzle piece that has the same properties as \mathbf{V}' near the top of a sufficiently long central cascade. We can obtain complex bounds for this nest using the initial bounds for the box mapping $F: \mathcal{U} \rightarrow \mathcal{V}$ and the method of [CvST] or using the argument of [KvS]. We will explain how to use the argument of [KvS].

We will say that a puzzle piece is δ -excellent if it is δ -nice, has δ -bounded geometry and is a $(1 + 1/\delta)$ -quasidisk for some $\delta > 0$. Note that we exclude δ -free from this definition. From the complex bounds of [CvST], we have that every puzzle piece in the enhanced nest is δ -nice and has δ -bounded geometry. We will prove in this section that there exists $\delta > 0$,

depending on the geometry of \mathcal{V} , such that each puzzle piece in the enhanced nest is a $(1 + 1/\delta)$ -quasidisk.

Remark 5.1. Observe that for any $\delta > 0$, $d \in \mathbb{N}$ and $K \geq 1$, there exists $\delta' > 0$ such that the following holds. Suppose that \mathbf{I} is a δ -excellent puzzle piece, and that \mathbf{I}' is a pullback of \mathbf{I} with degree bounded by d and dilatation bounded by K . Assume there exist sets $\mathbf{I}^+, \mathbf{I}^-$ so that if we set $\mathbf{A}^+ = \mathbf{I}^+ \setminus \mathbf{I}$ and $\mathbf{A}^- = \mathbf{I} \setminus \mathbf{I}^-$ we have that $\text{mod}(\mathbf{A}^+), \text{mod}(\mathbf{A}^-) > \delta$ and that the mapping from \mathbf{I}' to \mathbf{I} extends to a mapping onto \mathbf{I}^+ with no critical values in $\mathbf{A}^+ \cup \mathbf{A}^-$. Then \mathbf{I}' is δ' -excellent.

Let us suppose now that the principal nest starting with $\mathbf{Z}^0 \ni c_0$:

$$\mathbf{Z}^0 \supset \mathbf{Z}^1 \supset \mathbf{Z}^2 \supset \dots \supset \mathbf{Z}^N \supset \mathbf{Z}^{N+1}$$

is a central cascade; that is, $\mathbf{Z}^1 = \mathcal{L}_{c_0}(\mathbf{Z}^0)$ and we have that every critical value of $R_{\mathbf{Z}^0}|_{\mathbf{Z}^1}$ is contained in \mathbf{Z}^N , and there exists a critical point, c of $R_{\mathbf{Z}^0}|_{\mathbf{Z}^1}$ such that

$$R_{\mathbf{Z}^0}|_{\mathbf{Z}^1}(c) \in \mathbf{Z}^N \setminus \mathbf{Z}^{N+1}.$$

Consider the principal nest starting with a puzzle piece $\mathbf{Z}^{-1} \ni c_0$:

$$\mathbf{Z}^{-1} \supset \mathbf{Z}^0 \supset \mathbf{Z}^1 \supset \mathbf{Z}^2 \supset \dots \supset \mathbf{Z}^N \supset \mathbf{Z}^{N+1},$$

where $\mathbf{Z}^0 \supset \mathbf{Z}^1 \supset \mathbf{Z}^2 \supset \dots \supset \mathbf{Z}^N \supset \mathbf{Z}^{N+1}$ is a central cascade. If the return time of \mathbf{Z}^0 to \mathbf{Z}^{-1} is strictly less than the return time of \mathbf{Z}^1 to \mathbf{Z}^0 , then we say that the central cascade $\mathbf{Z}^0 \supset \mathbf{Z}^1 \supset \mathbf{Z}^2 \supset \dots \supset \mathbf{Z}^N \supset \mathbf{Z}^{N+1}$ is *maximal*. Assume that $\mathbf{Z}^0 \supset \mathbf{Z}^1 \supset \mathbf{Z}^2 \supset \dots \supset \mathbf{Z}^N \supset \mathbf{Z}^{N+1}$ is a maximal central cascade. Let s be the return time of \mathbf{Z}^1 to \mathbf{Z}^0 under F and suppose that $N \geq 3$. In these circumstances, for $N \in \mathbb{N}$, we say that a puzzle piece \mathbf{J} is *combinatorially close to \mathbf{Z}^0* if $\mathbf{J} \supset \mathbf{Z}^2 \ni c_0$ and the return mapping from \mathbf{Z}^3 to \mathbf{Z}^2 extends to a mapping of the same degree onto \mathbf{J} .

5.3.1. Modifying the construction of the enhanced nest to produce puzzle pieces containing a central cascade. For each critical point $c \in \text{Crit}(F)$, let s_c be the first entry time of c to \mathbf{Z}^0 . We define

$$PC(\mathbf{Z}^0) = \bigcup_{c \in \text{Crit}(F)} \bigcup_{j=0}^{s_c} F^j(c).$$

Notice that we include the critical point in this set.

Suppose that $\mathbf{I} = \mathbf{I}^0 \ni c_0$ is a critical puzzle piece. Let k_{c_0} be such that $R_{\mathbf{I}^0}^{k_{c_0}}(c_0) \in \mathbf{I} \setminus \mathbf{I}^1$ we define

$$\hat{\mathcal{A}}(\mathbf{I}) = \text{Comp}_{c_0}(R_{\mathbf{I}^0}^{-k_{c_0}} \mathcal{L}_{R_{\mathbf{I}^0}^{k_{c_0}}(c_0)}(\mathbf{I})).$$

Lemma 5.5. *Assume that $\mathbf{Z}^0 \supset \mathbf{Z}^1 \supset \mathbf{Z}^2 \supset \dots \supset \mathbf{Z}^N \supset \mathbf{Z}^{N+1} \ni c_0$ is a maximal central cascade with $N \geq 2$. Suppose that the return time of \mathbf{Z}^1 to \mathbf{Z}^0 is strictly greater than the return time of \mathbf{I}^1 to \mathbf{I} and*

$$\mathbf{I} \supset \mathbf{Z}^0 \supset \hat{\mathcal{A}}(\mathbf{I}).$$

Then there exists a puzzle piece \mathbf{J} such that \mathbf{J} is a pullback of \mathbf{I} with order bounded by $2b$ and \mathbf{J} is combinatorially close to \mathbf{Z}^0 .

Proof. Suppose first that $\mathbf{Z}^0 \supset \mathbf{I}^1$. Then $\mathbf{I}^1 \supset \mathbf{Z}^1 \supset \mathbf{I}^2 \supset \mathbf{Z}^2$. It is immediate that \mathbf{I}^1 is combinatorially close to \mathbf{Z}^0 .

Now, assume that $\mathbf{I}^1 \supset \mathbf{Z}^0$. Suppose first that the return of \mathbf{I}^1 to \mathbf{I} has the property that $R_{\mathbf{I}^0}(c_0) \notin \mathbf{I}^1$. Then $R_{\mathbf{I}^0}(\mathbf{Z}^1)$ is contained in a non-central return domain to \mathbf{I} . By assumption,

the pullback, $\mathbf{J} = \hat{\mathbf{A}}(\mathbf{I})$, of this domain under $R_{\mathbf{I}}$ is contained in \mathbf{Z}^0 . So we have that $\mathbf{Z}^1 \subset \mathbf{J} \subset \mathbf{Z}^0$, and hence is combinatorially close to \mathbf{Z}^0 .

Now suppose that the return of \mathbf{I}^1 to \mathbf{I} is central for c_0 . Let

$$\mathbf{I}^1 \supset \mathbf{I}^2 \supset \mathbf{I}^3 \supset \dots$$

be the principal nest. Let $k > 0$ be minimal so that $R_{\mathbf{I}}(\mathbf{Z}^1) \subset \mathbf{I}^k \setminus \mathbf{I}^{k+1}$. Then $R_{\mathbf{I}}^{k+1}(\mathbf{Z}^1)$ is contained in a non-central component of the domain of the return mapping to \mathbf{I} . Setting

$$\mathbf{J} = \hat{\mathbf{A}}(\mathbf{I}) \subset \mathbf{Z}^0$$

we have that $\mathbf{Z}^1 \subset \mathbf{J} \subset \mathbf{Z}^0$, which again finishes the proof. \square

Proposition 5.6 (Compare [KSvS1], Lemma 8.2.). *Assume that $\mathbf{Z}^0 \supset \mathbf{Z}^1 \supset \dots \supset \mathbf{Z}^N \supset \mathbf{Z}^{N+1}$ is a maximal central cascade with $N \geq 8$. Suppose that $\mathbf{I} \supset \mathbf{Z}^0 \ni c_0$ is a pair of puzzle pieces such that $\hat{\mathbf{A}}(\mathbf{I}) \supset \mathbf{Z}^0$. Then there exists a sequence of combinatorially defined puzzle pieces*

$$\mathbf{I} = \mathbf{I}_0^{\mathbf{Z}^0} \supset \mathbf{I}_1^{\mathbf{Z}^0} \supset \dots \supset \mathbf{I}_n^{\mathbf{Z}^0} \supset \mathbf{Z}^2$$

such that the following holds:

- Each $\mathbf{I}_{i+1}^{\mathbf{Z}^0}$ is a pullback of $\mathbf{I}_i^{\mathbf{Z}^0}$ by F^{p_i} of bounded degree.
- There exist sets $\mathbf{I}_i^+, \mathbf{I}_i^-$ such that $\mathbf{I}_i^- \subset \mathbf{I}_i^{\mathbf{Z}^0} \subset \mathbf{I}_i^+$, and the critical values of $F^{p_i}|_{\mathbf{I}_{i+1}^{\mathbf{Z}^0}}$ are contained in \mathbf{I}_i^- .
- $\mathbf{Z}^2 \subset \mathbf{I}_n^{\mathbf{Z}^0} \subset \mathbf{Z}^0$.

Remark 5.2. In the course of the proof of this proposition, we will define the *enhanced nest* above a (maximal) central cascade.

Proof. Step 1. We are going to inductively construct a sequence of pairs of sets of puzzle pieces: $\mathbf{T}_n, \mathbf{J}_n$. This construction terminates either

- (1) when we obtain a puzzle piece \mathbf{U}_0 that is combinatorially close to \mathbf{Z}^0 or
- (2) when we find a collection of critical puzzle pieces $\mathbf{P}_c \ni \mathbf{P}'_c$ that contains $\text{Crit}(F)$ such that each \mathbf{P}_c is a pullback of \mathbf{I} with order bounded by $b^2 - b$, and for each $c \in \text{Crit}(F)$ and any $z \in PC(\mathbf{Z}^0) \cap (\mathbf{P}_c \setminus \mathbf{P}'_c)$ there exist a critical point \hat{c} and a puzzle piece $\mathbf{Z} \ni z$ such that the landing mapping from \mathbf{Z} to $\mathbf{P}_{\hat{c}}$ is a diffeomorphism.

Let $\mathbf{T}_0 = \mathbf{I}$ and $\mathbf{J}_0 = \mathcal{L}_{c_0}(\mathbf{T}_0)$. If the return time of \mathbf{Z}^1 to \mathbf{I} is the same as its return time to \mathbf{Z}^0 , then we set $\mathbf{U}_0 = \mathcal{L}_{c_0}(\mathbf{I})$, and we are done. So suppose that \mathbf{I} is not combinatorially close to \mathbf{Z}^0 . If for any critical point $c \in \text{Crit}(F)$, $c \neq c_0$ we have that $R_{\mathbf{I}}(c) \in \mathbf{J}_0$, set $\mathbf{P}_c = \hat{\mathcal{L}}_c(\mathbf{T}_0)$ and $\mathbf{P}'_c = \hat{\mathcal{L}}_c(\mathbf{J}_0)$. Otherwise, there exists a critical point $c_1 \in \text{Crit}(F)$ such that $R_{\mathbf{I}}(c_1) \in \mathbf{T}_0 \setminus \mathbf{J}_0$. Let $\mathbf{T}_1 = \mathbf{J}_0 \cup \text{Comp}_{c_1} R_{\mathbf{T}_0}^{-1}(\mathcal{L}_{R_{\mathbf{T}_0}(c_1)}(\mathbf{T}_0))$, and let $\mathbf{J}_1 = \mathcal{L}_{c_0}(\mathbf{T}_1) \cup \mathcal{L}_{c_1}(\mathbf{T}_1)$.

Suppose first that $\mathbf{Z}^0 \supset \mathbf{J}_1(c_0)$. Observe the either

- $\mathbf{J}_1(c_0) = \mathcal{L}_{c_0}(\mathbf{J}_0(c_0))$ or
- $\mathbf{J}_1(c_0) = \mathcal{L}_{c_0}(\text{Comp}_{c_1} R_{\mathbf{T}_0}^{-1}(\mathcal{L}_{R_{\mathbf{T}_0}(c_1)}(\mathbf{T}_0)))$,

In the first case we have that

$$\mathbf{J}_0 \supset \mathbf{Z}^0 \supset \mathbf{J}_1(c_0) \supset \mathcal{L}_{c_0}(\mathbf{Z}^0),$$

and $\mathbf{J}_1(c_0)$ is combinatorially close to \mathbf{Z}^0 . In the second case, since $\mathbf{J}_1(c_0)$ is a first entry domain to $\mathbf{T}_1(c_0)$ the orbit of c_0 enters $\text{Comp}_{c_1} R_{\mathbf{T}_0}^{-1}(\mathcal{L}_{R_{\mathbf{T}_0}(c_1)}(\mathbf{T}_0))$ before returning to $\mathbf{T}_1(c_0) =$

$\mathbf{J}_0(c_0)$. So the orbit of $\mathcal{L}_{c_0}(\mathbf{Z}^0)$ enters $\text{Comp}_{c_1} R_{\mathbf{T}_0}^{-1}(\mathcal{L}_{R_{\mathbf{T}_0}(c_1)}(\mathbf{T}_0))$ before returning to \mathbf{Z}^0 , pulling this back to c_0 , we have that

$$\mathcal{L}_{c_0}(\mathbf{Z}^0) \subset \mathcal{L}_{c_0}(\text{Comp}_{c_1} R_{\mathbf{T}_0}^{-1}(\mathcal{L}_{R_{\mathbf{T}_0}(c)}(\mathbf{T}_0))) \subset \mathbf{Z}^0$$

and we have that $\mathcal{L}_{c_0}(\text{Comp}_{c_1} R_{\mathbf{T}_0}^{-1}(\mathcal{L}_{R_{\mathbf{T}_0}(c)}(\mathbf{T}_0)))$ is combinatorially close to \mathbf{Z}^0 .

So let us suppose that $\mathbf{J}_1 \supset \mathbf{Z}^0$. If for any critical point $c \in \text{Crit}(F)$, $c \neq c_0, c_1$ we have that $R_{\mathbf{T}_1}(c) \in \mathbf{J}_1$, set $\mathbf{P}_c = \hat{\mathcal{L}}_c(\mathbf{T}_1)$ and $\mathbf{P}'_c = \hat{\mathcal{L}}_c(\mathbf{J}_1)$. Otherwise, there exists a critical point $c_2 \in \text{Crit}(F)$ such that $R_{\mathbf{T}_1}(c_2) \in \mathbf{T}_1 \setminus \mathbf{J}_1$. Let $\mathbf{T}_2 = \mathbf{J}_1 \cup \text{Comp}_{c_2} R_{\mathbf{T}_1}^{-1}(\mathcal{L}_{R_{\mathbf{T}_1}(c_2)}(\mathbf{T}_1))$, and let $\mathbf{J}_2 = \mathcal{L}_{c_0}(\mathbf{T}_2) \cup \mathcal{L}_{c_1}(\mathbf{T}_2) \cup \mathcal{L}_{c_2}(\mathbf{T}_2)$.

Suppose first that $\mathbf{Z}^0 \supset \mathbf{J}_2(c_0)$. There are three possibilities:

- (a) $\mathbf{J}_2(c_0) = \mathcal{L}_{c_0}(\mathbf{T}_2(c_0))$ and the orbit of c_0 enters $\mathbf{T}_2(c_0)$ before entering $\mathbf{T}_2(c_1) \cup \mathbf{T}_2(c_2)$,
 - (b) $\mathbf{J}_2(c_0) = \mathcal{L}_{c_0}(\mathbf{T}_2(c_1))$ and the orbit of c_0 enters $\mathbf{T}_2(c_1)$ before entering $\mathbf{T}_2(c_0) \cup \mathbf{T}_2(c_2)$
- or
- (c) $\mathbf{J}_2(c_0) = \mathcal{L}_{c_0}(\mathbf{T}_2(c_2))$ and the orbit of c_0 enters $\mathbf{T}_2(c_2)$ before entering $\mathbf{T}_2(c_0) \cup \mathbf{T}_2(c_1)$,

In the Case (a), we immediately have that

$$\mathbf{T}_2(c_0) \supset \mathbf{Z}^0 \supset \mathbf{J}_2(c_0) = \mathcal{L}_{c_0}(\mathbf{T}_2(c_0)) \supset \mathcal{L}_{c_0}(\mathbf{Z}^0).$$

In the Case (b), we have that

$$\mathbf{T}_2(c_1) = \mathbf{J}_1(c_1) = \mathcal{L}_{c_1}(\mathbf{T}_1) = \mathcal{L}_{c_1}(\mathbf{J}_0 \cup \text{Comp}_{c_1} R_{\mathbf{T}_0}^{-1}(\mathcal{L}_{R_{\mathbf{T}}(c_1)}(\mathbf{T}_0))).$$

So there are two possibilities, either $\mathbf{J}_2(c_0) = \mathcal{L}_{c_0} \mathcal{L}_{c_1}(\mathbf{J}_0)$, or

$$\mathbf{J}_2(c_0) = \mathcal{L}_{c_0} \mathcal{L}_{c_1}(\text{Comp}_{c_1} R_{\mathbf{T}_0}^{-1}(\mathcal{L}_{R_{\mathbf{T}_0}(c_1)}(\mathbf{T}_0))).$$

In the second case, it is important to observe that after entering $\mathcal{L}_{c_1}(\text{Comp}_{c_1} R_{\mathbf{T}_0}^{-1}(\mathcal{L}_{R_{\mathbf{T}_0}(c_1)}(\mathbf{T}_0)))$, the orbit of $\mathcal{L}_{c_0}(\mathbf{Z}^0)$ returns to $\text{Comp}_{c_1} R_{\mathbf{T}_0}^{-1}(\mathcal{L}_{R_{\mathbf{T}}(c_1)}(\mathbf{T}_0))$ before returning to \mathbf{J}_0 , so we have that

$$\mathbf{T}_2(c_0) \supset \mathbf{Z}^0 \supset \mathbf{J}_2(c_0) \supset \mathcal{L}_{c_0}(\mathbf{Z}^0).$$

In Case (c),

$$\mathbf{J}_2(c_0) = \mathcal{L}_{c_0}(\text{Comp}_{c_2} R_{\mathbf{T}_1}^{-1}(\mathcal{L}_{R_{\mathbf{T}_1}(c_2)}(\mathbf{T}_1))),$$

and the orbit of $\mathcal{L}_{c_0}(\mathbf{Z}^0)$ enters $\text{Comp}_{c_2} R_{\mathbf{T}_1}^{-1}(\mathcal{L}_{R_{\mathbf{T}_1}(c_2)}(\mathbf{T}_1))$ before returning to $\mathbf{T}_2(c_0)$. So again

$$\mathbf{T}_2(c_0) \supset \mathbf{Z}^0 \supset \mathbf{J}_2(c_0) \supset \mathcal{L}_{c_0}(\mathbf{Z}^0),$$

and we are done.

So we may assume that $\mathbf{Z}^0 \subset \mathbf{J}_2(c_0)$. Continuing in this fashion, we find that either

- A. There exists $\mathbf{U}_0 = \mathbf{T}_m$ that is combinatorially close to \mathbf{Z}^0 and is a pullback of \mathbf{I} of order bounded by $b^2 - b$ or
- B. (a) there is a collection \mathbf{T}_m , $m < b$ of puzzle pieces around some critical points, and this collection is strictly nice;
- (b) for any other critical point $c' \in \text{Crit}(F)$, $R_{\mathbf{T}_m}(c') \in \mathbf{J}_m$;
- (c) any puzzle piece of \mathbf{T}_m is a pullback of \mathbf{I} with order bounded by $b^2 - b$.

For each $c \in \text{Crit}_{\mathbf{Z}^0}(F)$, let $\mathbf{P}_c = \hat{\mathcal{L}}_c(\mathbf{T}_m)$ and $\mathbf{P}'_c = \hat{\mathcal{L}}_c(\mathbf{J}_m)$. By the construction, we immediately see that either (1) or (2) holds.

It will be useful later to make the following definition.

Definition 5.1. Given a pair of critical puzzle pieces $\mathbf{I} \supset \mathbf{Z}^0 \ni c_0$ we define

$$\mathcal{T}(\mathbf{I}) = \mathbf{T}_m(c_0).$$

Step 2. Let k be the maximal integer such that for some $c \in \text{Crit}_{\mathbf{Z}^0}(F)$ the set $F^{-k}(\mathbf{P}_c)$ has a component \mathbf{Q} such that

- \mathbf{Q} is a child of \mathbf{P}_c ; that is, \mathbf{Q} is a unicritical pullback of \mathbf{P}_c that contains a critical point, and
- $\hat{\mathcal{L}}_{c_0}(\mathbf{Q}) \supset \mathbf{Z}^0$.

Let $\mathbf{U}_0 = \hat{\mathcal{L}}_{c_0}(\mathbf{Q})$, and let ν be the positive integer such that $F^\nu(\mathbf{U}_0) = \mathbf{I}$. Let $k_1 \geq 0$ be so that $F^{k_1}(\mathbf{U}_0) = \mathbf{Q}$, and let $l \geq 0$ be the integer such that \mathbf{P}_c is a pullback of \mathbf{I} by F^l . Observe that since $\mathcal{L}_{F^\nu(c_0)}(\mathbf{I})$ is a first return domain to \mathbf{I} and $F^l(\mathbf{P}'_c) \cap \mathcal{L}_{F^\nu(c_0)}(\mathbf{I}) \neq \emptyset$, we have that $F^l(\mathbf{P}'_c) \subset \mathcal{L}_{F^\nu(c_0)}(\mathbf{I})$, which immediately implies $\mathbf{P}'_c \subset \text{Comp}_{F^{k+k_1}(c_0)}F^{-l}(\mathcal{L}_{F^\nu(c_0)}(\mathbf{I}))$. Thus to show that a point $x \in \text{Comp}_{c_0}F^{-\nu}(\mathcal{L}_{F^\nu(c_0)}(\mathbf{I}))$ it is sufficient to show that $F^{k_1+k}(x) \in \mathbf{P}'_c$.

Let $\{\mathbf{G}_j\}_{j=0}^s$ be the chain with $\mathbf{Z}^0 = \mathbf{G}_s$ to $\mathbf{Z}^1 = \mathbf{G}_0$. Suppose first that $x \in \text{PC}(\mathbf{Z}^0)$, and that $x \in \mathbf{G}_j$, for some $0 \leq j < s$. Suppose that $F^k(x) \in \mathbf{P}_c \setminus \mathbf{P}'_c$. Then by construction, there exists a puzzle piece $\mathbf{W} \ni F^k(x)$ and a critical point \hat{c} , so that \mathbf{W} is mapped diffeomorphically onto $\mathbf{P}_{\hat{c}}$. Since $F^k: \mathbf{Q} \rightarrow \mathbf{P}_c$ is unicritical, we have that $\mathbf{G}_{k+j} \subset \mathbf{W} \subset \mathbf{P}_c \setminus \mathbf{P}'_c$. This contradicts the maximality of k . If $\hat{\mathcal{A}}(\mathbf{U}_0) \subset \mathbf{Z}^0$, then by Lemma 5.5, we have that there is a pullback of \mathbf{U}_0 with order bounded by b that is combinatorially close to \mathbf{Z}^0 . So we can suppose that $\hat{\mathcal{A}}(\mathbf{U}_0) \supset \mathbf{Z}^0$. Let $\{\mathbf{H}_j\}_{j=0}^r$ denote the chain given by $\mathbf{H}_r = \mathbf{U}_0$ and $\mathbf{H}_0 = \mathcal{L}_{c_0}(\mathbf{U}_0)$, and let $\{\hat{\mathbf{H}}_j\}_{j=0}^{\hat{r}}$ be the chain with $\hat{\mathbf{H}}_{\hat{r}} = \mathbf{U}_0$ and $\hat{\mathbf{H}}_0 = \hat{\mathcal{A}}_{c_0}(\mathbf{U}_0)$. Let us show that neither of these two chains intersects x .

Suppose that $x \in \text{PC}(\mathbf{Z}^0) \cap \mathbf{Q}$ and $F^k(x) \in \mathbf{P}_c \setminus \mathbf{P}'_c$. Then there exists a puzzle piece $\mathbf{W} \ni F^k(x)$ and a critical point \hat{c} so that \mathbf{W} is mapped diffeomorphically onto $\mathbf{P}_{\hat{c}}$. If for some $j, 0 \leq j \leq r$, $\mathbf{H}_j \ni x$, then \mathbf{H}_{j+k} contains $F^k(x) \in \mathbf{P}_c \setminus \mathbf{P}'_c$ and $\mathbf{G}_{j'}$ for some $0 \leq j' \leq s$. Since $\mathbf{G}_{j'} \subset \mathbf{P}'_c$ and puzzle pieces are nested or disjoint, we have that $\mathbf{H}_{j+k} \supset \mathbf{P}'_c$. But this is impossible since $\hat{\mathcal{A}}_{c_0}(\mathbf{U}_0) \supset \mathbf{Z}^0$. Arguing identically, we have that the chain $\{\hat{\mathbf{H}}_j\}_{j=0}^{\hat{r}}$ does not intersect x .

Remark 5.3. Each critical puzzle piece \mathbf{I} such that $\mathcal{L}_{c_0}(\mathbf{I}) \supset \mathbf{Z}^0$ has a smallest successor that contains \mathbf{Z}^0 , whether c_0 is reluctantly or persistently recurrent.

Whenever \mathbf{U}_0 satisfies $\hat{\mathcal{A}}(\mathbf{U}_0) \supset \mathbf{Z}^0$, we let $\Gamma_{\mathbf{Z}^0}(\mathbf{U}_0)$ denote the successor of \mathbf{U}_0 with the following properties. Let $\{\mathbf{H}'_j\}_{j=0}^{r'}$ be the chain with $\mathbf{H}'_{r'} = \mathbf{U}_0$, $\mathbf{H}'_0 = \Gamma_{\mathbf{Z}^0}(\mathbf{U}_0)$. Assume that

- (1) for all j , \mathbf{H}'_j is disjoint from the set of all $x \in \mathbf{U}_0 \cap \text{PC}(\mathbf{Z}^0)$ with $F^{k+k_1}(x) \in \mathbf{P}_c \setminus \mathbf{P}'_c$,
- (2) $\mathbf{H}'_0 \supset \mathbf{Z}^1$,
- (3) r' is maximal over all chains satisfying (1) and (2).

Repeating this, we have that either $\hat{\mathcal{A}}(\Gamma_{\mathbf{Z}^0}(\mathbf{U}_0)) \subset \mathbf{Z}^0$ or $\Gamma_{\mathbf{Z}^0}(\mathbf{U}_0)$ has two successors with properties (1) and (2), and in this case, we set $\Gamma_{\mathbf{Z}^0}^2(\mathbf{U}_0)$ to be the last such successor.

Let $\mathbf{I} \supset \mathbf{Z}^0$ be a puzzle piece. Suppose that $\hat{\mathcal{A}}\mathcal{T}(\mathbf{I}) \supset \mathbf{Z}^1$. Define

$$\mathcal{A}_{\mathbf{Z}^0}(\mathbf{I}) = \text{Comp}_{c_0}(F^{-\nu}(\mathcal{L}_{F^\nu(c)}(\mathbf{I})))$$

$$\mathcal{B}_{\mathbf{Z}^0}(\mathbf{I}) = \text{Comp}_c(F^{-\nu}(\mathbf{I})).$$

Definition 5.2. We define the *enhanced above* \mathbf{Z}^0 as follows:

- If $\mathbf{E}^{\mathbf{Z}^0}$ is defined, then we stop the construction.
- Let $\mathbf{I}_0^{\mathbf{Z}^0} = \mathbf{I}$. Suppose that $\mathbf{I}_{n-1}^{\mathbf{Z}^0}$ has been constructed.
- If $\mathcal{T}(\mathbf{I}_{n-1}^{\mathbf{Z}^0}) = \mathcal{B}(\mathbf{I}_{n-1}^{\mathbf{Z}^0})$, set $\mathbf{E}^{\mathbf{Z}^0} = \mathcal{T}(\mathbf{I}_{n-1}^{\mathbf{Z}^0})$ (this occurs when we are in case (1) of Lemma 5.6).
- Otherwise, we can assume that (2) holds. If $\mathcal{T}\mathcal{A}_{\mathbf{Z}^0}(\mathbf{I}_{n-1}^{\mathbf{Z}^0}) = \mathcal{B}_{\mathbf{Z}^0}\mathcal{A}_{\mathbf{Z}^0}(\mathbf{I}_{n-1}^{\mathbf{Z}^0})$, set $\mathbf{E}^{\mathbf{Z}^0} = \mathbf{I}_n^{\mathbf{Z}^0} = \mathcal{T}\mathcal{A}(\mathbf{I}_{n-1}^{\mathbf{Z}^0})$. From now on, we can assume that

$$\mathbf{Z}^0 \subset \mathcal{B}_{\mathbf{Z}^0}\mathcal{A}_{\mathbf{Z}^0}(\mathbf{I}_{n-1}^{\mathbf{Z}^0}) \subset \mathcal{T}\mathcal{A}_{\mathbf{Z}^0}(\mathbf{I}_{n-1}^{\mathbf{Z}^0}).$$

- If $\hat{\mathcal{A}}\mathcal{B}_{\mathbf{Z}^0}\mathcal{A}_{\mathbf{Z}^0}(\mathbf{I}_{n-1}^{\mathbf{Z}^0}) \subset \mathbf{Z}^0$, set

$$\mathbf{E}^{\mathbf{Z}^0} = \mathbf{I}_n^{\mathbf{Z}^0}$$

to be the pullback of $\mathcal{B}_{\mathbf{Z}^0}\mathcal{A}_{\mathbf{Z}^0}(\mathbf{I}_{n-1}^{\mathbf{Z}^0})$ that is combinatorially close to \mathbf{Z}^0 that is given by Lemma 5.5.

- Otherwise, $\mathbf{Z}^0 \subset \hat{\mathcal{A}}\mathcal{B}_{\mathbf{Z}^0}\mathcal{A}_{\mathbf{Z}^0}(\mathbf{I}_{n-1}^{\mathbf{Z}^0})$. If for some $T, 0 \leq T < 5b$,

$$\hat{\mathcal{A}}\Gamma_{\mathbf{Z}^0}^T\mathcal{B}_{\mathbf{Z}^0}\mathcal{A}_{\mathbf{Z}^0}(\mathbf{I}_{n-1}^{\mathbf{Z}^0}) \subset \mathbf{Z}^0,$$

then let $T < 5b$ be minimal with this property, and let

$$\mathbf{I}_n^{\mathbf{Z}^0} = \mathbf{E}^{\mathbf{Z}^0}$$

be the pullback of $\Gamma_{\mathbf{Z}^0}^T\mathcal{B}_{\mathbf{Z}^0}\mathcal{A}_{\mathbf{Z}^0}(\mathbf{I}_{n-1}^{\mathbf{Z}^0})$ that is combinatorially close to \mathbf{Z}^0 that is given by Lemma 5.5.

- If no such T exists, set $T = 5b$, and define

$$\mathbf{I}_n^{\mathbf{Z}^0} = \Gamma_{\mathbf{Z}^0}^T\mathcal{B}_{\mathbf{Z}^0}\mathcal{A}_{\mathbf{Z}^0}(\mathbf{I}_{n-1}^{\mathbf{Z}^0}).$$

Notice that this last case, is the only one where $\mathbf{E}^{\mathbf{Z}^0}$ is not defined, and in this case, we continue on to define $\mathbf{I}_{n+1}^{\mathbf{Z}^0}$.

Concluding the proof, we set $\mathbf{I}_n^+ = \Gamma_{\mathbf{Z}^0}^{5b}\mathcal{B}_{\mathbf{Z}^0}\mathcal{B}_{\mathbf{Z}^0}(\mathbf{I}_{n-1}^{\mathbf{Z}^0})$ and $\mathbf{I}_n^- = \Gamma_{\mathbf{Z}^0}^{5b}\mathcal{A}_{\mathbf{Z}^0}\mathcal{A}_{\mathbf{Z}^0}(\mathbf{I}_{n-1}^{\mathbf{Z}^0})$. \square

Suppose that $\mathbf{I}_0^{\mathbf{Z}^0} \supset \mathbf{I}_1^{\mathbf{Z}^0} \supset \mathbf{I}_2^{\mathbf{Z}^0} \supset \cdots \supset \mathbf{I}_{n+1}^{\mathbf{Z}^0}$ are defined and that $\hat{\mathcal{A}}(\mathbf{I}_{n+1})$ contains \mathbf{Z}^0 . Let p_n be so that $F^{p_n}(\mathbf{I}_{n+1}^{\mathbf{Z}^0}) = \mathbf{I}_n^{\mathbf{Z}^0}$. If \mathbf{I} is a puzzle piece, we let $r(\mathbf{I})$ be the minimal return time of a point in \mathbf{I} to \mathbf{I} . Let $\mathbf{M}_{n,i} = \Gamma_{\mathbf{Z}^0}^i\mathcal{B}_{\mathbf{Z}^0}\mathcal{A}_{\mathbf{Z}^0}(\mathbf{I}_n)$. Let $q_{n,i}$ be so that $F^{q_{n,i}}(\mathbf{M}_{n,i}) = \mathbf{M}_{n,i-1}$.

Lemma 5.7 (See [KSvS1] Lemma 8.3, Transition and return time relations). *Suppose that $\mathbf{I}_0^{\mathbf{Z}^0} \supset \mathbf{I}_1^{\mathbf{Z}^0} \supset \mathbf{I}_2^{\mathbf{Z}^0} \supset \cdots \supset \mathbf{I}_{n+1}^{\mathbf{Z}^0}$ are defined and that $\hat{\mathcal{A}}(\mathbf{I}_{n+1}^{\mathbf{Z}^0})$ contains \mathbf{Z}^0 . Then*

- (1) $3r(\mathbf{I}_{n+1}^{\mathbf{Z}^0}) \geq p_n$,
- (2) $p_{n+1} \geq 2p_n$.

Proof. The proof follows the proof of [KSvS1] Lemma 8.3. The proofs of these inequalities follow from the first three inequalities of [KSvS1] Lemma 8.3. These are:

- $2b^2r(\mathcal{A}_{\mathbf{Z}^0}(\mathbf{I}_n)) \geq s_n \geq r(\mathbf{I}_n^{\mathbf{Z}^0})$,
- $b^2r(\mathcal{B}_{\mathbf{Z}^0}\mathcal{A}_{\mathbf{Z}^0}(\mathbf{I}_n^{\mathbf{Z}^0})) \geq t_n \geq r(\mathcal{A}_{\mathbf{Z}^0}(\mathbf{I}_n^{\mathbf{Z}^0}))$,
- $r(\mathbf{M}_{n,i}) \geq q_{n,i} \geq 2r(\mathbf{M}_{n,i})$,

where s_n and t_n are such that

$$\mathcal{A}_{\mathbf{Z}^0}(\mathbf{I}_n) = \text{Comp}_{c_0} F^{-s_n}(\mathbf{I}_n^{\mathbf{Z}^0})$$

and

$$\mathcal{B}_{\mathbf{Z}^0} \mathcal{A}_{\mathbf{Z}^0}(\mathbf{I}_n^{\mathbf{Z}^0}) = \text{Comp}_{c_0} F^{-t_n}(\mathcal{A}_{\mathbf{Z}^0}(\mathbf{I}_n^{\mathbf{Z}^0})).$$

The proofs of the first and second inequalities are unchanged from [KSvS1]. We need only comment on the proof of the third: Since F is non-renormalizable, each puzzle piece $\mathbf{M}_{n,i-1}$ has at least two children satisfying conditions (1) and (2) on page 61. Moreover, by construction, for each i , the second child of $\mathbf{M}_{n,i-1}$ contains \mathbf{Z}^0 , and hence also contains $\mathbf{M}_{n,i}$. Thus $R_{\mathbf{M}_{n,i-1}}(\mathbf{M}_{n,i}) \cap \mathbf{M}_{n,i} = \emptyset$, so $q_{n,i} \geq 2r(\mathbf{M}_{n,i-1})$. Finally observe that for $0 < j < q_{n,i}$, $F(\mathbf{M}_{n,i}) \not\ni c_0$, so $F(\mathbf{M}_{n,i}) \cap \mathbf{M}_{n,i} = \emptyset$. This implies that $r(\mathbf{M}_{n,i}) \geq q_{n,i}$. \square

Lemma 5.7 implies that there are at most six returns of c_0 to \mathbf{Z}^0 under $F^{p_n+p_{n-1}+\dots+p_i}$. Since we chose the central cascade to have length at least eight, this implies that for each i , the critical values of $F^{p_n+p_{n-1}+\dots+p_i}|_{\mathbf{I}_{n+1}^{\mathbf{Z}^0}}$ are contained in $\Gamma_{\mathbf{Z}^0}^{5b} \mathcal{A}_{\mathbf{Z}^0} \mathcal{A}_{\mathbf{Z}^0}(\mathbf{I}_{i-1}^{\mathbf{Z}^0})$.

5.3.2. *Complex bounds for the enhanced nest above a central cascade.* We will use the following lemma which give us “small distortion of thin annuli.”

Lemma 5.8 (Compare [KvS] Lemma 9.1). *For every $K \in (0, 1)$, $\delta > 0$, there exists $\kappa > 0$ such that the following holds. Suppose that $F: \mathbf{U} \rightarrow \mathbf{Z}$ is $(1+\delta)$ -quasiregular, real-symmetric, branched covering map, of degree D with all critical values real. Assume that $\mathbf{A} \subset \mathbf{U}$, $\mathbf{B} \subset \mathbf{Z}$ are simply connected domains, symmetric with respect to the real axis, and that the domain \mathbf{A} is the connected component of $F^{-1}(\mathbf{B})$ with respect to the real-line and the degree of $F|_{\mathbf{A}}$ is d . Moreover, suppose that F can be decomposed as a composition of mappings $f_1 \circ \dots \circ f_n$ with all maps f_i real and either a $(1+\delta_i)$ -quasiconformal diffeomorphism, or a $(1+\delta_i)$ -quasiregular branched covering map with a unique real critical point, where*

$$\prod_{i=1}^n (1 + \delta_i) \leq (1 + \delta),$$

then

$$\text{mod}(\mathbf{U} \setminus \mathbf{A}) \geq \frac{K^D}{2d(1 + \delta)} \min\{\kappa, \text{mod}(\mathbf{Z} \setminus \mathbf{B})\}.$$

The previous lemma is an adaptation of Lemma 9.1 in [KvS], where the mappings are assumed to be analytic, to the asymptotically holomorphic setting, and the proof can be repeated verbatim. In the real-analytic setting, it implies and sharpens the *Covering Lemma* of Kahn and Lyubich [KL].

With Lemma 5.8 in hand, one can repeat the arguments of [KvS] to prove complex bounds for complex bounds for the enhanced nest above \mathbf{Z}^0 :

Proposition 5.9 (see [KvS] Proposition 10.1). *For any $\varepsilon > 0$, there exists $\delta > 0$ such that the following holds. Suppose that F be a complex box mapping. If $\mathbf{I}_0^{\mathbf{Z}^0}$ is ε -nice, and $\mathbf{I}_0^{\mathbf{Z}^0} \supset \mathbf{I}_1^{\mathbf{Z}^0} \supset \mathbf{I}_2^{\mathbf{Z}^0} \supset \dots \supset \mathbf{I}_n^{\mathbf{Z}^0}$ is the enhanced nest above \mathbf{Z}^0 , and that $n \geq 8$. then all $\mathbf{I}_i^{\mathbf{Z}^0}$, $n = 0, 1, 2, \dots, n$ are δ -nice.*

Proof. The proof is a slight modification of the proof of Proposition 10.1 of [KvS]. Let us omit the \mathbf{Z}^0 in the notation. Suppose that $0 \leq j \leq n$. Let $\delta_j \geq 1$ be such that \mathbf{I}_j is δ_j -nice. Fix $M > 4$, to be chosen later, and suppose that $j > M + 1$. Let \mathbf{A} be any component of the domain of the first return mapping to \mathbf{I}_j and let r be its return time.

Remark 5.4. Let us remark that we do not require that \mathbf{A} intersect the post-critical set of F .

Let $P_{j,M} = p_{j-1} + p_{j-2} + \cdots + p_{j-M}$ and let $\mathbf{B} = F^{P_{j,M}}(\mathbf{A})$.

First, we show that $\mathbf{B} \subset \mathcal{L}_x(\mathbf{I}_{j-4})$. Observe that

$$r \geq r(\mathbf{I}_j) \geq \frac{1}{3}p_{j-1} \geq \frac{16}{3}p_{j-5} \geq p_{j-5} + p_{j-6} + \cdots \geq P_{j-4,M-4},$$

so $s = r - P_{j-4,M-4} \geq 0$. Since $F^r(\mathbf{A}) = \mathbf{I}_j = F^s \circ F^{P_{j-4,M-4}}(\mathbf{A})$, we have that

$$F^s(F^{P_{j,M}}(\mathbf{A})) = F^{p_{j-1}} \circ F^{p_{j-2}} \circ F^{p_{j-3}} \circ F^{p_{j-4}} \circ F^s \circ F^{P_{j-4,M-4}}(\mathbf{A}) = \mathbf{I}_{j-4}.$$

Thus $F^{P_{j,M}}(\mathbf{A})$ is contained in some $\mathcal{L}_x(\mathbf{I}_{j-4})$.

Let $\mathbf{I}_j^+ = \Gamma^T \mathcal{B}\mathcal{B}(\mathbf{I}_{j-1})$. Then $\mathbf{I}_j \subset \mathbf{I}_j^+ \subset \mathbf{I}_{j-1}$ and $\text{mod}(\mathbf{I}_j^+ \setminus \mathbf{I}_j) \geq K_1 \delta_{j-1}$.

For each \mathbf{I}_j^+ let $\mu_j = \mu(\mathbf{I}_j^+) = \max \text{diam}(\mathbf{U})$, where the maximum is taken over components of $\text{Dom}'(\mathbf{I}_j^+)$. Fix any $x \in F^{P_{j,M}}(\mathbf{A})$ and $k \in \{n-M, n-M+1, \dots, n-4\}$. Let ν be so that $F^\nu(x) = R_{\mathbf{I}_k}(x)$. Let \mathbf{A}_k denote the pullback of $\mathbf{I}_k^+ \setminus \mathbf{I}_k$ by F^ν that contains x in the bounded component of its complement. The degree of the mapping $F^\nu: \mathcal{L}_x(\mathbf{I}_k) \rightarrow \mathbf{I}_k$ is bounded from above by a universal constant depend only the critical points of F and their orders, and by Lemma 3.13, there exists a constant $C > 0$ so that the dilatation of $F^\nu|_{\mathbf{A}_k}$ is at most $C\mu_k$. By property (1) in the construction of $\Gamma_{\mathbf{Z}^0}$, see page 61, we have the same for $F^\nu: \text{Comp}_x F^{-\nu}(\mathbf{I}_k^+) \rightarrow \mathbf{I}_k^+$. Hence there exists a constant K_2 such that

$$\text{mod}(\mathbf{A}_k) \geq \frac{K_1}{K_2} \delta_{k-1}.$$

The annuli \mathbf{A}_k are nested and surround $F^{P_{j,M}}(\mathbf{A})$, which implies that

$$\text{mod}(\mathbf{I}_{n-M}, F^{P_{j,M}}(\mathbf{A})) \geq \frac{K_1}{K_2} (\delta_{n-M-1} + \delta_{n-M} + \cdots + \delta_{n-5}).$$

The degree of the mapping $F^{P_{j,M}}|_{\mathbf{A}}$ is bounded from above by a constant independent of M , and the degree of $F^{P_{j,M}}|_{\mathbf{I}_n}$ is bounded from above by a constant $K_4(M)$.

Let $\mathbf{V} = \mathbf{I}_{n-M}$, and let \mathbf{B} and \mathbf{B}' be the domains bounded by the inner and outer boundary of \mathbf{A}_{n-4} , respectively. Then

$$\text{mod}(\mathbf{V}, \mathbf{B}) \geq \frac{K_1}{K_2} (\delta_{n-M-1} + \delta_{n-M} + \cdots + \delta_{n-5}).$$

Let $\delta_{n-M-1, n-5} = \min_{n-M-1 \leq i \leq n-5} \{\delta_i\}$. We may assume that $K_1/K_2 < 1$. Take M to be the smallest integer greater than $4d(1+\delta)K_2/K_1$ and set $D = K_4(M)$ and take $K = (\frac{4d(1+\delta)K_2}{K_1M})^{1/D}$. Let $\kappa > 0$ be the number associated to K given by Lemma 5.8. By Lemma 5.8 we have that

$$\begin{aligned} \text{mod}(\mathbf{I}_n \setminus \mathbf{A}) &\geq \frac{K^D}{2d(1+\delta)} \min\{\kappa, \text{mod}(\mathbf{V} \setminus \mathbf{B})\} \\ &\geq \min\left\{\frac{K^D}{2d(1+\delta)}\kappa, \frac{K^D}{2d(1+\delta)} \frac{K_1}{K_2} M \delta_{n-M-1, n-5}\right\} \\ &\geq \min\left\{\kappa', \frac{4d(1+\delta)K_2}{2d(1+\delta)K_1M} \frac{K_1}{K_2} M \delta_{n-M-1, n-5}\right\} = \min\{\kappa', 2\delta_{n-M-1, n-5}\}, \end{aligned}$$

where $\kappa' = \frac{K^D}{2d(1+\delta)}\kappa$. We also have that there exists K so that $\delta_j \geq K\delta_{j-1}$. This completes the proof. \square

Using the construction of the enhanced nest above Z^0 we immediately deduce:

Proposition 5.10. *There exists $\delta > 0$ such that for all $j, 0 \leq j \leq n+1$,*

$$\text{mod}(\mathbf{I}_j^+ \setminus \mathbf{I}_j^{\mathbf{Z}^0}) \geq \delta, \quad \text{and} \quad \text{mod}(\mathbf{I}_j^{\mathbf{Z}^0} \setminus \mathbf{I}_j^-) \geq \delta.$$

Since for all $j \in \{0, \dots, n-1\}$ we have that the critical values of F^{P_j} are contained in \mathbf{I}_j^- , and $\text{mod}(\mathbf{I}_j^{\mathbf{Z}^0} \setminus \mathbf{I}_j^-)$ is bounded away from 0, independently of j , the same argument given in [KvS] implies:

Proposition 5.11 (See [KvS] Proposition 11.1). *For any $\varepsilon, \rho > 0$, there exists $\delta > 0$ such that the following holds. Let $F: \mathbf{U} \rightarrow \mathbf{V}$ be a real-symmetric complex box mapping and suppose that $\mathbf{I}_0^{\mathbf{Z}^0} \supset \mathbf{I}_1^{\mathbf{Z}^0} \supset \dots \supset \mathbf{I}_n^{\mathbf{Z}^0}$ is the enhanced nest above \mathbf{Z}^0 . Assume that $\mathbf{I}_0^{\mathbf{Z}^0}$ be ε -nice and that it has ρ -bounded geometry with respect to c_0 . Then all $\mathbf{I}_j^{\mathbf{Z}^0}, 0 \leq j \leq n$ have δ -bounded geometry.*

Now we are in a position to prove our new result, that the puzzle pieces in the enhanced nest or an enhanced nest over a central cascade are all quasidisks with bounded dilatation.

Proposition 5.12. *For any $K \geq 1$ there exists $K' \geq 1$ such that the following holds. Let $\mathbf{I} =: \mathbf{I}_0^{\mathbf{Z}^0} \supset \mathbf{Z}^0$ be puzzle pieces. Suppose that \mathbf{I} is a K -quasidisk. Then for all $j, 0 \leq j \leq n$, $\mathbf{I}_j^{\mathbf{Z}^0}$ is a K' -quasidisk.*

Remark 5.5. In our applications, $F: \mathbf{U} \rightarrow \mathbf{V}$ is the complex box mapping given by either Theorem 5.2 or Theorem 5.3, so that $\mathbf{I}_0^{\mathbf{Z}^0}$ is a Poincaré lense domain $D_\theta(I_0)$. In particular, it is a $K(\theta)$ -quasidisk.

Proof. We will give the proof for the enhanced nest. The proof for the enhanced nest above a long cascade of central returns is identical.

We will verify that the Ahlfors-Beurling Criterion, see Lemma 3.1), is satisfied for constant C that depends only on the geometry of $\mathbf{V} \setminus \mathbf{U}$ and the constant ρ from Theorem 5.1. By Theorem 5.1, there exists $\rho > 0$, such that for any $k > 0$, there exist puzzle pieces $\mathbf{P}_k^+ \supset \mathbf{I}_k \supset \mathbf{P}_k^-$ such that $\text{mod}(\mathbf{P}_k^+ \setminus \mathbf{I}_k)$ and $\text{mod}(\mathbf{I}_k \setminus \mathbf{P}_k^-) > \delta$, and such that each \mathbf{I}_n has ρ -bounded geometry at the critical point.

Claim: There exists a constant $\eta_0 = \eta_0(\delta) > 0$ such

$$\text{dist}(\partial \mathbf{I}_k, \mathbf{P}_k^-) \geq \eta_0 \cdot \text{diam}(\mathbf{I}_k) \quad \text{and} \quad \text{dist}(\partial \mathbf{P}_k^+, \mathbf{I}_k) \geq \eta_0 \cdot \text{diam}(\mathbf{P}_k^+).$$

Proof of claim: We will need the following:

Fact 1. For any $\delta > 0$, there exists a constant $c > 0$ such that if $\text{mod}(\mathbf{V} \setminus \mathbf{U}) > \delta$, then $\text{dist}(\partial \mathbf{V}, \mathbf{U}) > c \cdot \text{diam}(\mathbf{U})$.

Fact 2. There exists a constant $M_0 > 0$ such that if $\mathbf{U} \Subset \mathbf{V}$ are topological disks with $\text{mod}(\mathbf{V} \setminus \mathbf{U}) > M_0$, then for any $z_0 \in \mathbf{U}$, there exists a round annulus $\mathbf{A} = \{z : r < |z - z_0| < R\} \subset \mathbf{V} \setminus \mathbf{U}$ with $\text{mod}(\mathbf{A}) \geq \text{mod}(\mathbf{V} \setminus \mathbf{U}) - M_0$.

We will prove the first estimate in the claim, the second is similar. First suppose that $\text{mod}(\mathbf{I}_k \setminus \mathbf{P}_k^-) > 3M_0$. Then by the above fact, there exists a round annulus $\mathbf{A} = \{z : r < |z - c_0| < R\}$ contained in $\mathbf{I}_k \setminus \mathbf{P}_k^-$ with $\text{mod} \mathbf{A} \geq \text{mod}(\mathbf{I}_k \setminus \mathbf{P}_k^-) - M_0$. Since \mathbf{I}_k has δ -bounded geometry with respect to c_0 , we can assume that R is comparable to $\text{diam}(\mathbf{I}_k)$. But now since r is much smaller than R , $\text{dist}(\partial \mathbf{I}_k, \mathbf{P}_k^-)$ is comparable to $\text{diam}(\mathbf{I}_k)$.

Now suppose that $\text{mod}(\mathbf{I}_k \setminus \mathbf{P}_k^-) \leq 3M_0$, Then since \mathbf{I}_k has δ -bounded geometry at c_0 , there exists a constant c' , depending only on M_0 , such that $\text{diam}(\mathbf{P}_k^-) \geq c' \cdot \text{diam}(\mathbf{I}_k)$. Then since there exists a constant c such that $\text{dist}(\mathbf{P}_k^-, \partial \mathbf{I}_k) > c \cdot \text{diam}(\mathbf{P}_k^-)$ we have that $\text{dist}(\mathbf{P}_k^-, \partial \mathbf{I}_k) > cc' \cdot \text{diam}(\mathbf{I}_k)$. ✓

With the claim in hand, let \mathbf{I}_n be a critical puzzle piece in the enhanced nest, and choose points $x, y \in \partial \mathbf{I}_n$. For each $j \geq 0$, let p_j be defined so that $F^{p_j}|_{\mathbf{I}_{j+1}}$ maps \mathbf{I}_{j+1} onto \mathbf{I}_j as a quasi-regular branched covering mapping with bounded degree and bounded dilatation, and define $s_k = p_{n-1} + p_{n-2} + \dots + p_k$. Let $x_j = F^{s_j}(x)$ and $y_j = F^{s_j}(y)$. For each $j \leq n$, let γ_j be the shortest path in $\partial \mathbf{I}_j$ connecting x_j and y_j . Suppose that there exists $k \geq 0$, such that $|x_k - y_k| > (\eta_0/2)\text{diam}(\mathbf{I}_k)$, and let $0 \leq k_0 < n$ be maximal with this property. then $|x_{k_0} - y_{k_0}| > (\eta_0/2)\text{diam}(\gamma_{k_0})$. Pulling back by $F^{p_{k_0}}: \mathbf{I}_{k_0+1} \rightarrow \mathbf{I}_{k_0}$, we have that there exists a constant C such that $C|x_{k_0+1} - y_{k_0+1}| > \text{diam}(\gamma_{k_0+1})$, and $|x_{k_0+1} - y_{k_0+1}| < (\eta_0/2)\text{diam}(\mathbf{I}_{k_0+1})$. Since $|x_{k_0+1} - y_{k_0+1}| < (\eta_0/2)\text{diam}(\mathbf{I}_{k_0+1})$, by the claim, the line segment l_{k_0+1} connecting x_{k_0+1} and y_{k_0+1} is well-inside $\mathbf{P}_{k_0+1}^+ \setminus \mathbf{P}_{k_0+1}^-$, and $\text{dist}(\gamma_{k_0+1}, \partial \mathbf{P}_{k_0+1}^+ \cup \partial \mathbf{P}_{k_0+1}^-) \geq \eta_0 \cdot \text{diam}(\mathbf{I}_{k_0+1})$. By real-symmetry and since $\partial \mathbf{I}_{k_0+1}$ intersects the real line exactly twice, we can assume that γ_{k_0+1} intersects the real line at most once. So we can remove a real ray that does not intersect either l_{k_0+1} or γ_{k_0+1} and contains the post-critical set of F . Choosing the branch of $F^{s_{k_0+1}}: \mathbf{I}_n \rightarrow \mathbf{I}_{k_0+1}$ that maps x to x_{k_0+1} and y to y_{k_0+1} , and pulling back by this map, which has bounded dilatation, we have that there exists a constant $C > 0$, independent of n such that $C|x_n - y_n| \geq \text{diam}(\gamma_n)$. Suppose now that no such k exists. Then $|x_0 - y_0| < (\eta/2)\text{diam}(\mathbf{I}_0)$, and there exists a constant $C > 0$ such that $C|x_0 - y_0| > \text{diam}(\gamma_0)$, so we can argue as in the previous case. ✓ □

From the definition of the enhanced nest above \mathbf{Z}^0 we immediately have

Proposition 5.13 (Good geometry for central cascades). *There exists $\delta > 0$ such that if $\mathbf{Z}^0 \supset \mathbf{Z}^1 \supset \dots \supset \mathbf{Z}^{N+1}$ is a maximal central cascade, then there exists a δ -excellent puzzle piece \mathbf{G}^0 which is combinatorially close to \mathbf{P}^0 . See page 57 for the definition of δ -excellent.*

5.4. Chains without long central cascades. In this subsection, we will bound the sum of the squares of the diameters of the puzzle pieces in any chain of puzzle pieces that intersects the real-line and does not contain a long central cascade. These estimates are used to control the dilatation of certain restrictions of f^n . We will use the notation \mathbf{Y}^i to denote puzzle pieces in a principal nest.

5.4.1. Combinatorial depth. Let c be a critical point and suppose that $\mathbf{Y} \ni c$ is a critical puzzle piece. Let $\mathbf{Y} = \mathbf{Y}^0 \supset \mathbf{Y}^1 \supset \mathbf{Y}^2 \supset \dots$, where $\mathbf{Y}^{i+1} = \mathcal{L}_c(\mathbf{Y}^i)$, be the principal nest about c . Let $m > 0$, where we allow $m = \infty$, be minimal so that $R_{\mathbf{Y}^0}|_{\mathbf{Y}^1}(c) \in \mathbf{Y}^{m-1} \setminus \mathbf{Y}^m$. If m is finite, define $\mathcal{C}_c(\mathbf{Y}) = \mathbf{Y}^m$. If m is infinite, let $\mathcal{C}_c(\mathbf{Y}) = \mathbf{I}^\infty$.

If \mathbf{J} is a return domain to an arbitrary complex puzzle piece \mathbf{I} , and $\{\mathbf{G}_i\}_{i=0}^r$ is the chain with $\mathbf{G}_r = \mathbf{I}$ and $\mathbf{G}_0 = \mathbf{J}$ where r is the return time of \mathbf{J} to \mathbf{I} , we define

$$\text{Crit}(\mathbf{I}; \mathbf{J}) = \left(\bigcup_{i=0}^{r-1} \mathbf{G}_i \right) \cap \text{Crit}(F).$$

Similarly, if $\mathbb{G} = \{\mathbf{G}_j\}_{j=0}^s$ is an arbitrary chain such that the pullbacks of \mathbf{G}_s and \mathbf{I} are either nested or disjoint, $\mathbf{G}_0 \subset \mathbf{I}$ and $0 = n_0 < n_1 < \dots < n_p = s$ are the integers with

$\mathbf{G}_{n_i} \subset I$, we define

$$\text{Crit}(I; \mathbb{G}) = \bigcup_{i=0}^{p-1} \text{Crit}(I; \mathcal{L}_{\mathbf{G}_{n_i}}(I)).$$

For any complex puzzle piece I and any critical point c we define

$$k_c(I, \mathbb{G}) = \inf\{k_c \geq 0 : \text{there exists no } j = 1, 2, \dots, s-1 \text{ with } \mathbf{G}_j \subset \mathcal{C}_c^{k_c}(\hat{\mathcal{L}}_c(I))\},$$

where we take $\mathcal{C}_c^0(\hat{\mathcal{L}}_c(I)) = \hat{\mathcal{L}}_c(I)$ and

$$k(I, \mathbb{G}) = \sum_{c \in \text{Crit}(I; \mathbb{G})} k_c(I, \mathbb{G}).$$

The *combinatorial depth of the chain \mathbb{G} with respect to I* is defined to be $k(I, \mathbb{G})$. Note that $k(I, \mathbb{G})$ is well-defined even if I does not contain a critical point. These definitions are the same if we replace I and J by nice intervals.

Let us recall the following result:

Proposition 5.14. [CvST, Proposition 7.1] *For each $\delta > 0, k \geq 0$ and $N \geq 0$ there exist $\mu(k, N, \delta) \in (0, 1)$ and $\delta' > 0$, and for each $\theta \in (0, \pi)$ there exists $\varepsilon > 0$ so that the following holds. Let I be a δ -nice interval with $|I| < \varepsilon$. Suppose that $\mathbb{G} := \{G_i\}_{i=0}^s$ is a chain such that G_0, G_s are nice intervals contained in I , the pullbacks of G_s and I are nested or disjoint, the intervals G_0, \dots, G_{s-1} are pairwise disjoint and $G_0 \cap \omega(c_0) \neq \emptyset$. Assume that*

$$k(I, \mathbb{G}) \leq k \text{ and } \#\text{Crit}(I; \mathbb{G}) \leq N.$$

Let \hat{G}_s be an interval with $G_s \subset \hat{G}_s \subset (1 + 2\delta)\hat{G}_s \subset I$. Let $\mathbf{V} = D_\theta(\hat{G}_s) \cap \mathbb{C}_{G_s}$ and $\mathbf{U}_i = \text{Comp}_{G_i} F^{-(s-i)}(\mathbf{V})$ for $i = 0, \dots, s$. Then, there exists an interval $\hat{I} \supset G_0$ with $(1 + 2\delta')\hat{I} \subset I$ such that

$$\mathbf{U}_0 \subset D_{\mu(k, N, \delta)\theta}(\hat{I}).$$

For any point x , let $\mathbf{Y}_x^0 \supset \mathbf{Y}_x^1 \supset \mathbf{Y}_x^2 \supset \dots$ be the principle nest constructed about x . Let $\hat{m} > 0$, where we allow $\hat{m} = \infty$, be minimal $R_{\mathbf{Y}_x^0} |_{\mathbf{Y}_x^1}(x) \in \mathbf{Y}^{\hat{m}-1} \setminus \mathbf{Y}^{\hat{m}}$. If \hat{m} is finite, define $\hat{\mathcal{C}}_x(\mathbf{Y}) = \mathbf{Y}_x^{\hat{m}}$ and $\hat{\mathcal{C}}_x(\mathbf{Y}_x) = \mathbf{Y}_x^{\hat{m}+1}$. By [vSV1, Theorem A] we have that $\hat{\mathcal{C}}_x(\mathbf{Y}_x)$ is well-inside $\tilde{\mathcal{C}}_x(\mathbf{Y}_x)$, and that there exists a constant $\delta > 0$ so that $\hat{\mathcal{C}}_x(\mathbf{Y})$ is δ -nice. If \hat{m} is infinite, let $\tilde{\mathcal{C}}_x(\mathbf{Y}) = \hat{\mathcal{C}}_x(\mathbf{Y}) = I^\infty$.

Given a puzzle piece $\mathbf{U} \ni x$, let $\hat{k}(\mathbf{Y}_x^0, \mathbf{U}) = \hat{k}$ be minimal so that $\tilde{\mathcal{C}}_x^{\hat{k}}(\mathbf{Y}_x^0) \subset \mathbf{U}$, and we define the *depth* of a puzzle piece $\mathbf{U} \ni x$ to be $\hat{k}(\mathbf{Y}_x^0, \mathbf{U})$.

Let $\{\mathbf{U}_j\}_{j=0}^s$ be a chain of complex puzzle pieces. Suppose that \mathbf{U}_{j_1} is a first return domain to \mathbf{U}_{j_0} and \mathbf{U}_{j_2} is a first return domain to \mathbf{U}_{j_1} , $0 \leq j_2 < j_1 < j_0 \leq s$. We say that $\{\mathbf{U}_j\}_{j=0}^s$ is *free from central returns* if we have that $R_{\mathbf{U}_{j_0}} |_{\mathbf{U}_{j_1}}(\mathbf{U}_{j_2}) \subset \mathbf{U}_{j_0} \setminus \mathbf{U}_{j_1}$. A central cascade in a chain $\{\mathbf{U}_j\}_{j=0}^s$ is a sequence of critical puzzle pieces

$$\mathbf{U}_{j_0} \supset \mathbf{U}_{j_1} \supset \mathbf{U}_{j_2} \supset \dots \supset \mathbf{U}_{j_N} \supset \mathbf{U}_{j_{N+1}}$$

from the chain so that for each $i = 0, \dots, N$, $\mathbf{U}_{j_{i+1}}$ is a first return domain to \mathbf{U}_{j_i} and return time of $\mathbf{U}_{j_{i+1}}$ to \mathbf{U}_{j_i} is the same as the return time of \mathbf{U}_{j_1} to \mathbf{U}_{j_0} . The maximum number N so that this occurs for a sequence of first returns in the chain is the *length of the central cascade*. We say that $\{\mathbf{U}_j\}_{j=0}^s$ *does not have central cascades of length greater than N* if any central cascade in the chain $\{\mathbf{U}_j\}_{j=0}^s$ has length less than N .

5.4.2. *Controlling the diameters of complex puzzle pieces.* For convenience, let us restrict to the case that $F: \mathbf{U} \rightarrow \mathbf{V}$ is a complex box mapping given by either Theorem 5.2 or Theorem 5.3.

Let $M \in \mathbb{N}_{\geq 2}$, and let $\{\mathbf{U}_j\}_{j=0}^s$ be a chain of complex puzzle pieces. Let us construct the M -shielding intervals: For each $U_j := \mathbf{U}_j \cap \mathbb{R}$, let k be the depth of \mathbf{U}_j . Assume that k is at least $M + 1$. Let $x \in U_j$. Then $U_j \subset \tilde{\mathcal{C}}_x^{k-1}(Y_x^0)$. For i , $0 \leq i \leq M - 2$, let $\mathcal{S}_i(U_j) = \hat{\mathcal{C}}_x^{k-(M-i)}(Y_x^0)$.

Lemma 5.15. *There exist constants $M \geq 2, \lambda \in (0, 1)$ and $\theta_0 \in (0, \pi/2)$, such that for any $N \geq M$ the following holds: Suppose that \mathbf{U} is a puzzle piece with $\hat{k}(\mathbf{Y}_{\mathbf{U}}^0, \mathbf{U}) = N$ and $|\mathcal{S}_0(\mathbf{U})|$ sufficiently small. Let $\mathcal{S}_0(\mathbf{U}) \supset \mathcal{S}_1(\mathbf{U}) \supset \dots \mathcal{S}_{M-2}(\mathbf{U})$, be the M -shielding intervals. We have that*

$$\mathbf{U} \subset D_{\theta_0}(\mathcal{S}_0(\mathbf{U})) \cup D_{\lambda\theta_0}(\mathcal{S}_1(\mathbf{U})) \cup \dots \cup D_{\lambda^{M-3}\theta_0}(\mathcal{S}_{M-3}(\mathbf{U})) \cup D_{\alpha_U}(\mathcal{S}_{M-2}(\mathbf{U})),$$

with $\alpha_U = |\mathcal{S}_{M-2}(\mathbf{U})|^{1/3}$.

Proof. First we define the number M in the statement of the theorem. Let $J \ni x$ be a puzzle piece of depth n , and $\delta > 0$ be the universal constant so that for all $i \in \mathbb{N}$, each $\hat{\mathcal{C}}_x^i(Y_x^0)$ is δ -nice. Let C be the constant given by Lemma 3.11. Let M be so that $C \cdot J \subset \hat{\mathcal{C}}_x^{n-M}(Y_x^0)$.

We will prove the lemma by induction of the depth of the puzzle pieces. Since the top level puzzle pieces are Poincaré lens domains, and puzzle pieces are nested or disjoint, the initial step of the induction holds automatically for puzzle pieces with depth M . So suppose that the statement holds for puzzle pieces of depth at most $N \geq M$, and let us argue that it holds for puzzle pieces of depth $N + 1$.

Let \mathbf{U} be any puzzle piece of depth $N + 1$. Let s be so that \mathbf{U} is a component of $F^{-s}(\mathbf{V})$, and let $\{\mathbf{U}_j\}_{j=0}^s$ be the chain so that $\mathbf{U}_0 = \mathbf{U}$. Let us divide the chain $\{\mathbf{U}_j\}_{j=0}^s$ into pieces based on their depth. Let $l_0 = s$. Let $l_1 < s$ be maximal so that there is a point $x' \in U_{l_1}$ such that $U_{l_1} \subset \hat{\mathcal{C}}_{x'}^0(Y_{x'}^0)$. Continuing inductively, if l_i has been defined, let $l_{i+1} < l_i$ be maximal so that there exists a point $x'' \in U_{l_{i+1}}$ such that $U_{l_{i+1}} \subset \hat{\mathcal{C}}_{x''}^{i+1}(Y_{x''}^0)$, and so on.

By definition, we have that $\hat{\mathcal{C}}_x^{N+1}(\mathbf{V}(x)) \subset \mathbf{U}_0 \subset \hat{\mathcal{C}}_x^N(\mathbf{V}(x)) \subset \tilde{\mathcal{C}}_x^N(\mathbf{V}(x))$. Let us now consider the chain $\{\mathbf{V}_j\}_{j=0}^{s'}$, where $\mathbf{V}_0 = \hat{\mathcal{C}}_x^N(\mathbf{V}(x))$ and $\mathbf{V}_{s'} = \tilde{\mathcal{C}}_x^N(\mathbf{V}(x))$.

Claim 1. There exists $\lambda \in (0, 1)$ such that the following holds. Let $0 \leq i \leq M - 3$, and let \tilde{U}_i be an interval that is well-inside $\mathcal{S}_i(U_0)$ and that contains $V_{s'}$. Then there exists an interval \tilde{U}_{i+2} that is well-inside of $\mathcal{S}_{i+2}(U_0)$, such that for any $\theta \in (0, \pi/2)$

$$\text{Comp}_{V_0}(F^{-s'}(D_{\theta}(\tilde{U}_i)) \cap \mathbb{C}_{V_{s'}}) \subset D_{\lambda\theta}(\tilde{U}_{i+2}),$$

where $\mathbb{C}_{V_{s'}} = \mathbb{C} \setminus (\mathbb{R} \setminus V_{s'})$.

Proof of Claim 1. Choose $x \in U_0$. Let $j_3 > 0$ be minimal so that $V_{j_3} \subset \tilde{\mathcal{C}}_x^{N-i+2}(Y_x^0)$. Such a j_3 exists since the return to $\tilde{\mathcal{C}}_x^{N-i+2}(Y_x^0)$ is non-central. Let $J^0 = \mathcal{S}_i(U_0)$, and assuming that J^i has already been constructed let $J^{i+1} = \mathcal{L}_x(J^i)$. Recall that there exists $\delta > 0$ so that $\mathcal{S}_i(U_0)$ is δ -nice. Let $n \geq 0$ be minimal so that $R_{J_0}(x) \in J^n \setminus J^{n+1}$. Let $j_1 < s$ be maximal so that $V_{j_1} \in J^n \setminus J^{n+1}$. Note, $j_1 > j_3$. Let L denote the domain of the return mapping to J^0 that contains $R_{J_0}^n(V_{j_1})$, and let $j'_1 > j_1$ be minimal so that $V_{j'_1} \subset L$. It follows from Proposition 5.14 and Corollary 3.14 that there exists $\lambda'_1 \in (0, 1)$ and an interval $\tilde{K}_{j'_1}$ that is

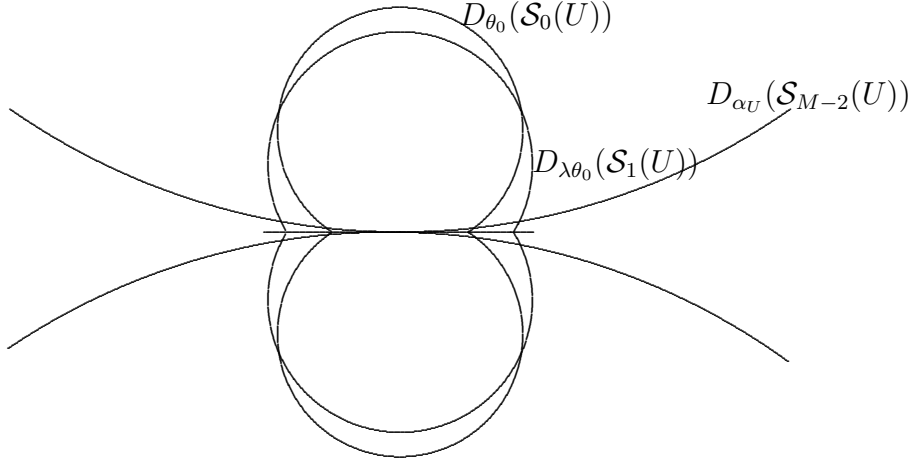

FIGURE 12. The shielding intervals and Poincaré disks with $M = 4$. When we pull back, this picture replicates itself at successive depths. The pullback of $D_{\theta_0}(\mathcal{S}_0(U_{j_1}))$ is contained in $D_{\lambda\theta_0}(\mathcal{S}_1(U_{j_3}))$, the pullback of $D_{\lambda\theta_0}(\mathcal{S}_1(U_{j_0}))$, is contained in $D_{\alpha_U}(\mathcal{S}_2(U_{j_3}))$, and the pullback of $D_{\alpha_U}(\mathcal{S}_2(U_{j_0}))$, is contained in $D_{\eta\alpha_U}(\mathcal{S}_2(U_{j_3})) \cup D_{\theta_0}(\mathcal{S}_0(U_{j_3}))$, with η close to 1.

well-inside L , such that

$$\text{Comp}_{V_{j'_1}}(F^{-(s'-j'_1)}(D_\theta(\tilde{U}_i)) \cap \mathbb{C}_{V_{s'}}) \subset D_{\lambda'_1\theta}(\tilde{K}_{j'_1}).$$

To see this, observe that we can use Proposition 5.14 to control the angle when we pull back from time s' to the last visit to J^0 before time j'_1 , and then use Corollary 3.14 to control the angle when we pull back one more time along the return mapping of L to J^0 .

Let $\{L_i\}$ denote the chain with $L_0 \subset J^n \setminus J^{n+1}$, the component of $R_{j_0}^{-n}(L)$ that contains V_{j_1} and $L_n = L$. Since the pullback from L_0 to L_n is along a diffeomorphic branch of a central return, we have that there exists an interval \tilde{K}_{j_1} well-inside L^0 and $\lambda_1 \in (0, 1)$ so that

$$\text{Comp}_{V_{j_1}} F^{-(s'-j_1)}(D_\theta(\tilde{U}_i) \cap \mathbb{C}_{V_{s'}}) \subset D_{\lambda_1\theta}(\tilde{K}_{j_1}).$$

Moreover, L_0 is δ' -nice for some $\delta' > 0$. Let $j_2 > j_3$ be minimal so that $V_{j_2} \subset \tilde{\mathcal{C}}_x^{N-i+1}(Y_x^0) \setminus \hat{\mathcal{C}}_x^{N-i+1}(Y_x^0)$. Let $j'_2 > j_2$ be minimal so that $V_{j'_2} \subset L_0$. By Proposition 5.14 there exists $\lambda'_2 \in (0, 1)$ and an interval $\tilde{K}_{j'_2}$ that is well-inside L_0 such that

$$\text{Comp}_{V_{j'_2}} F^{-(s'-j'_2)}(D_\theta(\tilde{U}_i) \cap \mathbb{C}_{V_{s'}}) \subset D_{\lambda'_2\theta}(\tilde{K}_{j'_2}),$$

and by Proposition 5.14 and Corollary 3.14 there exists λ_2 and an interval \tilde{K}_{j_2} that is well-inside $\mathcal{L}_{U_{j_2}}(\mathcal{C}_x^{n-i+1}(Y_x^0))$ such that

$$\text{Comp}_{V_{j_2}} F^{-(s'-j_2)}(D_\theta(\tilde{U}_i) \cap \mathbb{C}_{V_{s'}}) \subset D_{\lambda_2\theta}(\tilde{K}_{j_2}).$$

Since \tilde{K}_{j_2} is disjoint from $\hat{\mathcal{C}}_x^{n-i+1}(Y_x^0)$, the pullback of \tilde{K}_{j_2} is contained in $\tilde{\mathcal{C}}_x^{n-i+2}(Y_s^0)$. Arguing as before, by Proposition 5.14 and Corollary 3.14, there exist $\lambda_3 \in (0, 1)$ and \tilde{K}_{j_3} well-inside $\tilde{\mathcal{C}}_x^{n-i+2}(Y_x^0)$, so that

$$\text{Comp}_{V_{j_3}} F^{-(s'-j_3)}(D_\theta(\tilde{U}_i) \cap \mathbb{C}_{V_{s'}}) \subset D_{\lambda_3\theta}(\tilde{K}_{j_3}).$$

Finally by Corollary 3.14, there exists $\lambda \in (0, 1)$ and an interval \tilde{U}_{i+2} that is well-inside $\mathcal{S}_{i+2}(U_0)$ such that

$$\text{Comp}_{V_0} F^{-s'}(D_\theta(\tilde{U}_i) \cap \mathbb{C}_{V_{s'}}) \subset D_{\lambda\theta}(\tilde{U}_{i+2}).$$

✓

As above, $\{\mathbf{V}_j\}_{j=0}^{s'}$ denotes the chain with $\mathbf{V}_{s'} = \tilde{\mathcal{C}}_x^N(\mathbf{Y}_x^0)$ and $\mathbf{V}_0 = \hat{\mathcal{C}}_x^N(\mathbf{Y}_x^0)$. Now, let us pull back the slit Poincaré disk $D_{\alpha\mathcal{S}_{M-2}(U)}(\tilde{U}_{M-2}) \cap \mathbb{C}_{V_{s'}}$ back along the chain $\{\mathbf{V}_j\}_{j=0}^{s'}$.

Claim 2. There exist $\theta_0 \in (0, \pi/2)$, $\alpha \in (|\mathcal{S}_{M-1}(U)|^{1/3}, |\mathcal{S}_{M-2}(U)|^{1/3})$ such that the following holds. Let \tilde{U}_{M-2} be an interval that is well-inside $\mathcal{S}_{M-2}(U_0)$ and that contains $V_{s'}$. Then

$$\text{Comp}_{V_0} F^{-s'}(D_{|\mathcal{S}_{M-2}(U)|^{1/3}}(\tilde{U}_{M-2}) \cap \mathbb{C}_{V_{s'}}) \subset D_\alpha(\tilde{\mathcal{C}}_x^N(\mathbf{Y}_x^0)) \cup D_{\theta_0}(\hat{\mathcal{C}}_x^{N-M}(\mathbf{Y}_x^0)) \cap \mathbb{C}_{V_0}.$$

Proof of Claim 2: Recall that $\tilde{\mathcal{C}}_x^N(\mathbf{Y}_x^0) \subset \mathcal{S}_{M-1}(U_0)$. Let us start by explaining how we use Lemma 3.11 together with Proposition 5.14 to control the pullbacks of the Poincaré disk with small angle along many iterates of the return mapping to $\mathcal{S}_{M-2}(U_0)$.

Let $t_1 < s'$ be maximal so that $V_{t_1} \subset \mathcal{S}_{M-2}(U_0)$, then since there exists $\delta > 0$ such that $(1 + 2\delta)\tilde{U}_{M-2} \subset \mathcal{S}_{M-2}(U_0)$, by Lemma 3.11, Proposition 3.7 and Proposition 5.14, there exists η close to 1, $\delta' > 0$, and an interval $(1 + 2\delta')\tilde{U}'_{t_1} \subset \mathcal{L}_{V_{t_1}}(\mathcal{S}_{M-2}(U_0))$, and an angle $\theta_0 \in (0, \pi/2)$ such that

$$\text{Comp}_{V_{t_1}} F^{-(s'-t_1)}(D_{|\mathcal{S}_{M-2}(U)|^{1/3}}(\tilde{U}_{M-2}) \cap \mathbb{C}_{V_{s'}}) \subset D_{\eta|\mathcal{S}_{M-2}(U)|^{1/3}}(\tilde{U}'_{t_1}) \cup D_{\theta_0}(\hat{\mathcal{C}}_x^{N-1-M}(\mathbf{Y}_x^0)),$$

but now since $\mathcal{S}_{M-2}(U_0)$ is δ -nice, have that there exists an interval \tilde{U}_{t_1} such that $(1+2\delta)\tilde{U}_{t_1} \subset \mathcal{S}_{M-2}(U_0)$ and

$$\text{Comp}_{V_{t_1}} F^{-(s'-t_1)}(D_{|\mathcal{S}_{M-2}(U)|^{1/3}}(\tilde{U}_{M-2}) \cap \mathbb{C}_{V_{s'}}) \subset D_{|\mathcal{S}_{M-2}(U)|^{1/3}}(\tilde{U}_{t_1}) \cup D_{\theta_0}(\hat{\mathcal{C}}_x^{N-1-M}(\mathbf{Y}_x^0)).$$

Let us remark that further pullbacks of $D_{\theta_0}(\hat{\mathcal{C}}_x^{N-1-M}(\mathbf{Y}_x^0))$ are handled by Claim 1, so we will not treat them in detail in this part of the proof.

We now argue exactly as in the proof of Claim 1, but we control the loss of angle differently. We set $J^0 = \mathcal{S}_{M-2}(U_0)$, $J^{i+1} = \mathcal{L}_x(J^i)$, and let $n \geq 0$ be minimal so that $R_{J^0}(x) \in J^n \setminus J^{n+1}$. We define times $j_1 < s'$ maximal so that $V_{j_1} \in J^n \setminus J^{n+1}$, $j'_1 > j_1$ minimal so that $V_{j_1} \subset J^0 \setminus J^1$. We let $L = \mathcal{L}_{V_{j'_1}}(\mathcal{S}_{M-2}(U_0))$, and we let $\{L_i\}_{i=0}^n$ be the chain with $L_n = L$ and $L_0 = \text{Comp}_{V_{j_1}} R_{J^0}^{-n}(L_n)$. We let $j_2 > 0$ be minimal so that $V_{j_2} \subset \tilde{\mathcal{C}}_x^{N-1}(\mathbf{Y}_x^0) \setminus \hat{\mathcal{C}}_x^{N-1}(\mathbf{Y}_x^0)$, and we let $j'_2 > j_2$ be minimal so that $V_{j'_2} \subset L_0$.

We have that there exists η close to 1, and interval $\tilde{U}_{j'_1}$ that is well-inside L_n so that

$$\text{Comp}_{V_{j'_1}} F^{-(s'-j'_1)}(D_{|\mathcal{S}_{M-2}(U)|^{1/3}}(\tilde{U}_{M-2}) \cap \mathbb{C}_{V_{s'}}) \subset D_{\eta|\mathcal{S}_{M-2}(U)|^{1/3}}(\tilde{U}_{j'_1}) \cup D_{\theta_0}(\hat{\mathcal{C}}_x^{N-1-M}(\mathbf{Y}_x^0)).$$

Since the pullback from L_0 to L_n is by a diffeomorphism, there exists η' close to one and an interval \tilde{U}_{j_1} that is well-inside L_0 so that

$$\text{Comp}_{V_{j_1}} R_{J^0}^{-n}(D_{\eta|\mathcal{S}_{M-2}(U)|^{1/3}}(\tilde{U}_{j'_1}) \cap \mathbb{C}_{V_{s'}}) \subset D_{\eta'|\mathcal{S}_{M-2}(U)|^{1/3}}(\tilde{U}_{j_1})$$

Now we have that there exists an interval $\tilde{U}_{j'_2}$ that is well-inside L_0 so that

$$\text{Comp}_{V_{j'_2}} F^{-(j_1-j'_2)}(D_{\eta'|\mathcal{S}_{M-2}(U)|^{1/3}}(\tilde{U}_{j_1}) \cap \mathbb{C}_{V_{s'}}) \subset D_{\eta'|\mathcal{S}_{M-2}(U)|^{1/3}}(\tilde{U}_{j'_2}) \cup D_{\theta_0}(\hat{\mathcal{C}}_x^{N-M-1}(\mathbf{Y}_x^0)),$$

and there exists η'' close to 1 and an interval \tilde{U}_{j_2} that is well-inside $\mathcal{L}_{V_{j_2}}(\mathcal{C}_x^{N-1}(Y_x^0))$ so that

$$\text{Comp}_{V_{j_2}} F^{-(j'_2-j_2)}(D_{\eta''|\mathcal{S}_{M-2}(U)|^{1/3}}(\tilde{U}_{j'_2}) \cap \mathbb{C}_{V_{s'}}) \subset D_{\eta''|\mathcal{S}_{M-2}(U)|^{1/3}}(\tilde{U}_{j_2}) \cup D_{\theta_0}(\hat{\mathcal{C}}_x^{N-M-1}(Y_x^0)).$$

Finally, since $|\mathcal{S}_{M-1}(U_0)| < (1 + 2\delta)^{-1}|\mathcal{S}_{M-2}(U_0)|$ we have that there exists an interval \tilde{U} well-inside $\hat{\mathcal{C}}_x^{N-1}(Y_x^0)$ such that

$$\text{Comp}_{V_0} F^{-j_2}(D_{\eta''|\mathcal{S}_{M-2}(U)|^{1/3}}(\tilde{U}_{j_2}) \cap \mathbb{C}_{V_{s'}}) \subset D_{|\mathcal{S}_{M-1}(U)|^{1/3}}(\tilde{U}) \cup D_{\theta_0}(\hat{\mathcal{C}}_x^{N-M}(Y_x^0)).$$

✓

This concludes the proof. \square

Proposition 5.16. *There exists $C > 0$ such that for any $N \in \mathbb{N}$, the following holds. Suppose that \mathbf{U}_s is a puzzle piece of level 0. Suppose that $\{\mathbf{U}_j\}_{j=0}^s$ is a chain of puzzle pieces without central cascades of length greater than N and that \mathbf{U}_0 intersects the real line. Then*

$$\sum_{j=0}^s (\text{diam}(\mathbf{U}_j))^2 \leq N \cdot C \cdot \mu(\mathcal{V})^{1/3},$$

where $\mu(\mathcal{V}) = \max_{V \subset \mathcal{V}} \text{diam}(V)$, and the maximum is taken over connected components V of \mathcal{V} .

Proof. For each puzzle piece \mathbf{U}_j , let $\mathcal{S}_0(\mathbf{U}_j) \supset \mathcal{S}_1(\mathbf{U}_j) \supset \cdots \supset \mathcal{S}_{M-2}(\mathbf{U}_j)$ be the shielding intervals for $\mathbf{U}_j := \mathbf{U}_j \cap \mathbb{R}$.

By Lemma 5.15 if for any $\mathcal{S}_{i_0}(\mathbf{U}_{j_0})$, $0 \leq j_0 \leq s$ and $0 \leq i_0 \leq M-2$, there there are at most $N(M-1)+1$ numbers $j \in \{0, 1, 2, \dots, s\}$ such that there exists i , $0 \leq i \leq M-2$ with $\mathcal{S}_i(\mathbf{U}_j) = \mathcal{S}_{i_0}(\mathbf{U}_{j_0})$, then there exists $C_0 > 0$ depending on N so that

$$\sum_{j=0}^s \sum_{i=0}^{M-2} \text{diam}(|\mathcal{S}_i(\mathbf{U}_j)|)^2 < C_0.$$

Since each

$$\mathbf{U}_j \subset \cup_{i=0}^{M-3} D_{\lambda^i \theta_0}(\mathcal{S}_i(\mathbf{U}_j)) \cup D_{|\mathcal{S}_{M-2}(\mathbf{U}_j)|^{1/3}}(\mathcal{S}_{M-2}(\mathbf{U}_j)),$$

we have that there exists a constants $C, C' > 0$ such that

$$\sum_{j=0}^s \text{diam}(\mathbf{U}_j)^2 \leq C \sum_{j=0}^s \sum_{i=0}^{M-2} \text{diam}(\mathcal{S}_i(\mathbf{U}_j))^2 \leq C'.$$

So suppose that for some pair j_0, i_0 with $0 \leq j_0 \leq s$ and $0 \leq i_0 \leq M-2$, we have that there are at least $N(M-1)+1$, $j \in \{0, 1, 2, \dots, s\}$ such that there exists i , $0 \leq i \leq M-2$, depending on j , so that $\mathcal{S}_i(\mathbf{U}_j) = \mathcal{S}_{i_0}(\mathbf{U}_{j_0})$. Let $k+1$ denote the depth of \mathbf{U}_{j_0} . Let $j_1, 0 \leq j_1 \leq j_0$ be minimal so that $\mathcal{S}_{i_0}(\mathbf{U}_{j_1})$ is a shielding interval, with the same subindex, for \mathbf{U}_{j_1} , and for all \mathbf{U}_t such that $\mathbf{U}_t \subset \tilde{\mathcal{C}}_c^k(\mathbf{U}_{j_0})$ we have that $\mathcal{S}_{i_0}(\mathbf{U}_{j_0}) = \mathcal{S}_{i_0}(\mathbf{U}_t)$ is a shielding interval for \mathbf{U}_t and $\hat{k}(\mathcal{S}_{i_0}(\mathbf{U}_{j_0}), \mathbf{U}_t) = \hat{k}(\mathcal{S}_{i_0}(\mathbf{U}_{j_0}), \mathbf{U}_{j_0})$. Choose some $x \in \mathbf{U}_{j_1}$. Let $J^0 = \tilde{\mathcal{C}}_x^k(Y_x^0)$, and let $J^{i+1} = \mathcal{L}_x(J^i)$ be the principal nest about x . Relabeling, if necessary, let $j_0 \leq s$ be maximal so that $\mathcal{S}_{i_0}(\mathbf{U}_{j_0})$ is a shielding interval for \mathbf{U}_{j_0} , $j_0 - j_1 =: k_0 > N$, so that $\tilde{\mathcal{C}}_x(J_0) = J^{k_0}$, and the return from $R_{J_1} \rightarrow J^0$ has a critical point.

Notice that if $j_2 < j_1$ is maximal so that $\mathbf{U}_{j_2} \subset \tilde{\mathcal{C}}_x(J_0) = J^{k_0}$, then \mathbf{U}_{j_2} is not contained in the same component of the landing domain to J^{k_0} as \mathbf{U}_{j_1} , so that the depth of \mathbf{U}_{j_2} is $k+1$.

By Proposition 5.12, there exists $\theta \in (0, \pi)$ so that $\mathbf{J}^2 \subset D_\theta(J^1)$. Since the chain, $\{\mathbf{U}_j\}_{j=0}^s$ does not contain central cascades with length greater than N , there exists $k_1 \leq N$ and $j'_0, j_1 <$

$j'_0 \leq j_0$, so that we have that $U_{j'_0} \subset J^{k_1} \setminus J^{k_1+1}$, and there exists $\delta' > 0$ and $\theta' \in (0, \pi)$ depending on N , so that $U_{j'_0} \subset D_{\theta'}(\mathcal{L}_{U_{j'_0}}(\mathbf{J}^{k_1-1}))$. We have that $\text{Comp}_{U_{j_1}} F^{-(j'_0-j_1)}(\mathcal{L}_{U_{j'_0}}(\mathbf{J}^{k_1-1}))$, is a pullback of $\mathcal{L}_{U_{j'_0}}(\mathbf{J}^{k_1-1})$ with bounded degree through a monotone branch of a return mapping. Set $\mu(\mathbf{J}^0) = \max \text{diam}(\mathbf{U})$ where the maximum is taken over components \mathbf{U} of $\text{Dom}'(\mathbf{J}^0)$. Hence by Proposition 5.13 we have that there exists a constant $C > 0$ such that

$$\begin{aligned}
 \sum_{j=j_1}^{j_0} \text{diam}(\mathbf{U}_j)^2 &\leq \sum_{j=j'_0+1}^{j_0} \text{diam}(\mathbf{U}_j)^2 + \sum_{j=j_1}^{j'_0} \text{diam}(\mathbf{U}_j)^2 \\
 &\leq N \cdot \mu(\mathbf{J}^0) + \max_{j_1 \leq j \leq j'_0} \{\text{diam}(\mathbf{U}_j)\} \cdot \sum_{j=j_0}^{j'_0} \text{diam}(\mathbf{U}_j) \\
 &\leq N \cdot \mu(\mathbf{J}^0) + C \cdot \max_{j_1 \leq j \leq j'_0} \text{diam}(\mathbf{U}_j) \leq CN\mu(\mathbf{J}^0).
 \end{aligned}$$

This gives us an estimate on the sum of the squares of the diameters whenever we pull back through a monotone branch of a long central cascade in the principal nest.

Let us now combine the arguments when there are no central cascades with the argument for controlling the sum through a central cascade. Observe that for j , $j_0 \leq j \leq s$, we have that

$$\sum_{j=j_0}^s \text{diam}(\mathbf{U}_j)^2 \leq N \left(\sum_{j=j_0}^s \sum_{i=0}^{M-3} (\text{diam} D_{\lambda^i \pi/2}(\mathcal{S}_i(U_j)))^2 + (\text{diam} D_{|\mathcal{S}_{M-2}(U_j)|^{1/3}}(\mathcal{S}_{M-2}(U_j)))^2 \right),$$

and this estimate holds if we take the sum on the left over segments of the chain that do not pass through a cascade of central returns in a principle nest with length greater than N .

Let \mathcal{S} denote the set of all shielding Poincaré disks, that is \mathcal{S} is the set of all Poincaré disks,

$$\mathcal{S}_{i,j} = D_{\lambda^i \pi/2}(\mathcal{S}_i(U_j)), \quad 0 \leq j \leq s, 0 \leq i \leq M-3,$$

together with

$$D_{|\mathcal{S}_{M-2}(U_j)|^{1/3}}(\mathcal{S}_{M-2}(U_j)), \quad 0 \leq j \leq s.$$

where the domains in the union are not included with multiplicity. Thus we have that there exists a constant $C' > 0$ such that

$$\sum_{j=0}^s \text{diam}(\mathbf{U}_j)^2 \leq N \sum_{\mathcal{S} \in \mathcal{S}} \text{diam}(\mathcal{S})^2 + C' \sum_{c \in \text{Crit}(f)} \sum_k \mu(\hat{\mathcal{C}}_c^k(\mathbf{Y}_c^0)),$$

where the last summand is restricted to k such that $\hat{\mathcal{C}}_c^k(\mathbf{Y}_c^0)$ is at the start of a long central cascade, which is bounded from above. In fact, by Lemma 5.15, M is universal, so we have that there exists a constant $C > 0$ so that

$$\sum_{j=0}^s \text{diam}(\mathbf{U}_j)^2 \leq N \cdot C \cdot \mu(\mathcal{V})^{1/3}.$$

□

5.5. The good nest and complex bounds. We are going to adapt the construction of the *good nest* of [AKLS] to multicritical complex box mappings. Suppose that $F: \mathbf{U} \rightarrow \mathbf{V}$ is a complex box mapping given by Theorem 5.1, Theorem 5.2 or Theorem 5.3 with $\text{diam}(\mathbf{V})$ sufficiently small. For each critical point $c \in \text{Crit}(F)$, let $\mathbf{V}_c^0 = \text{Comp}_c(\mathbf{V})$, and let $\mathbf{V}^0 = \cup_{c' \in \text{Crit}(F)} \mathbf{V}_{c'}^0$. For each $c \in \text{Crit}(F)$, let $\mathbf{W}_c^0 = \mathcal{L}_c(\mathbf{V}^0)$. The domain \mathbf{W}_c^0 is the return domain containing c to the union of puzzle pieces, $\cup_{c' \in \text{Crit}(F)} (\mathbf{V}_{c'}^0)$. Assuming that for each critical point we have constructed $\mathbf{V}_c^i \supset \mathbf{W}_c^i$, we construct $\mathbf{V}_c^{i+1} \supset \mathbf{W}_c^{i+1}$: Assume that $c \in \text{Crit}(F)$. Let $k_c > 0$ be minimal so that for some $c' \in \text{Crit}(F)$, $F^{k_c}(c) \in \mathbf{V}_{c'}^i \setminus \mathbf{W}_{c'}^i$, and let $l_c > k_c$ be minimal so that for some $c'' \in \text{Crit}(F)$, $F^{l_c}(c) \in \mathbf{W}_{c''}^i$. Let $\mathbf{V}_c^{i+1} = \text{Comp}_c F^{-l_c}(\mathbf{V}_{c''}^i)$. Once we have constructed \mathbf{V}_c^{i+1} for each $c \in \text{Crit}(F)$, let $\mathbf{V}^{i+1} = \cup_{c \in \text{Crit}(F)} (\mathbf{V}_c^{i+1})$, $\mathbf{W}_c^{i+1} = \mathcal{L}_c(\mathbf{V}^{i+1})$, and $\mathbf{W}^{i+1} = \cup_{c \in \text{Crit}(F)} (\mathbf{W}_c^{i+1})$.

The chain from \mathbf{V}_c^{i+1} onto a component $\mathbf{V}_{c''}^i$ of \mathbf{V}^i has order bounded by the number of critical points of F , and the critical value $F^{l_c}(c)$ is contained in $\mathbf{W}_{c''}^i$. To see that it has bounded order observe that the chain from \mathbf{V}_c^{i+1} to $F^{k_c}(\mathbf{V}_c^{i+1})$ can intersect each critical point at most once and the mapping from $F^{k_c}(\mathbf{V}_c^{i+1})$ to $\mathbf{V}_{c''}^i$ is obtained by iterating diffeomorphic branches of the return mapping to \mathbf{V}^i . By Proposition 5.16 for any n and any $c \in \text{Crit}(F)$, the mapping from \mathbf{V}_c^n up to the top level has bounded dilatation.

Before we prove complex bounds for this nest, let us state the following easy lemma.

Lemma 5.17. *For each K and d there exists a constant $\kappa > 0$ so that for each K -quasi-regular map $g: U \rightarrow V$ (which is a branched covering onto V) the following holds. Let $B \subset V$ a disc and let A be a component of $g^{-1}(B)$. Then*

$$\text{mod}(U \setminus A) \geq \kappa \text{mod}(V \setminus B).$$

Remark 5.6. If $g: U \rightarrow V$ has critical values in $V \setminus B$ then there will be several preimages of B . So in the previous lemma we consider the annulus generated by considering U minus just one of the components of $g^{-1}(B)$.

Proposition 5.18. *There exists $\delta > 0$ so that for all $j > 0$, and $c \in \text{Crit}(f)$,*

$$\text{mod}(\mathbf{V}_c^j \setminus \mathbf{W}_c^j) > \delta.$$

Proof. We are going to use a similar argument to the one given in the proof of moduli bounds for the enhanced nest, compare Proposition 5.9 and [KvS].

For each $c \in \text{Crit}(F)$ and each i , let $p_{i,c}$ be so that $F^{p_{i,c}}(\mathbf{V}_c^i) = \mathbf{V}_{c'}^{i-1}$ for some $c' \in \text{Crit}(F)$. Let $12\#\text{Crit}(F) + 5 \leq M \leq n$. Let c_1 be so that $F^{p_{n,c}}(\mathbf{V}_c^n) = \mathbf{V}_{c_1}^{n-1}$, and assuming that c_i is chosen, let c_{i+1} be so that $F^{p_{n-i,c_i}}(\mathbf{V}_{c_i}^{n-i}) = \mathbf{V}_{c_{i+1}}^{n-(i+1)}$. Let

$$P_{n,M,c} = p_{n,c} + p_{n-1,c_1} + \cdots + p_{n-(M-1),c_{M-1}}.$$

Step 1: There exists a critical point c_0 and $k_0 \leq \#\text{Crit}(F) + 2$ such that for some $x \in \text{PC}(F)$, $F^{P_{n,M,c}}(\mathbf{W}_c^n) \subset \mathcal{L}_x(\mathbf{V}_{c_0}^{n-k_0})$.

Claim 1. If c' is so that $F^{p_{n-1,c'}}(\mathbf{V}_{c'}^{n-1}) = \mathbf{V}_{c''}^{n-2}$, then $r(\mathbf{W}_c^n) \geq p_{n,c} \geq p_{n-1,c} + p_{n-2,c'}$.

Proof of Claim 1. Let us start with the first inequality. Let r be the return time of c to \mathbf{V}^n . Let $k_c > 0$ be minimal so that $c \in \mathbf{V}^{n-1} \setminus \mathbf{W}^{n-1}$. Then $\mathbf{V}_c^n \subset \mathcal{L}_c(\mathcal{L}_{F^{k_c}(c)}(\mathbf{V}^{n-1}))$, and the chain from $\mathcal{L}_c(\mathcal{L}_{F^{k_c}(c)}(\mathbf{V}^n))$ to $\mathcal{L}_{F^{k_c}(c)}(\mathbf{V}^n)$ is disjoint, so we must have that $r > k_c$. Since the return time of $F^{k_c}(c)$ to \mathbf{W}^{n-1} cannot exceed its return time to \mathbf{V}^n (since $\mathbf{W}^{n-1} \supset \mathbf{V}^n$), we have that $r \geq p_{n,c}$.

To see the second inequality, observe that as in the first part since $\mathbf{V}_c^n \subset \mathcal{L}_c(\mathcal{L}_{f^{k_c}(c)}(\mathbf{V}^{n-1}))$ and $\mathbf{W}^{n-2} \supset \mathbf{V}^{n-1}$, we have that $p_{n-1,c} \leq k_c$. But now, since $F^{k_c}(c) \in \mathbf{V}^{n-1} \setminus \mathbf{W}^{n-1}$, and $\mathbf{W}^{n-1} \subset \mathbf{W}^{n-2}$, arguing similarly, we have that $p_{n-1,c} + p_{n-2,c'} \leq p_{n,c}$. \checkmark

The second inequality of the claim gives us the following recursive bound on the return times:

$$\begin{bmatrix} p_{n-1,c_1} \\ p_{n-1,c_2} \\ \vdots \\ p_{n-1,c_b} \\ p_{n-2,c_1} \\ p_{n-2,c_2} \\ \vdots \\ p_{n-2,c_b} \end{bmatrix} \geq \begin{bmatrix} I_b & X \\ I_b & 0 \end{bmatrix} \begin{bmatrix} p_{n-2,c_1} \\ p_{n-2,c_2} \\ \vdots \\ p_{n-2,c_b} \\ p_{n-3,c_1} \\ p_{n-3,c_2} \\ \vdots \\ p_{n-3,c_b} \end{bmatrix},$$

where X is a $b \times b$ square matrix with a single one in each row. The inequality should be interpreted entry wise. Let

$$A_i = \begin{bmatrix} I_b & X_i \\ I_b & 0 \end{bmatrix}$$

and set $\mathcal{A}_n = A_n A_{n-1} \dots A_1$, then one sees easily that

$$\mathcal{A}_n \begin{bmatrix} 1 \\ \vdots \\ 1 \end{bmatrix} = \begin{bmatrix} T_n \\ \vdots \\ T_n \\ T_{n-1} \\ \vdots \\ T_{n-1} \end{bmatrix},$$

where T_n is the $n + 1$ -st Fibonacci number

$$T_0 = 1, T_1 = 2, T_3 = 3, T_4 = 5, \dots$$

Observe that this is the sum of the entries in a row of \mathcal{A}_n .

Let $k \in \mathbb{N}_{\geq 2}$. By the Pigeonhole Principle we have that for some critical point $c_0 \in \text{Crit}(F)$ and some $k_0 \in \{k, k + 1\}$ the mapping from $\mathbf{V}_{c_0}^{n-1}$ to $\mathbf{V}_{c'}^{n-2}$, occurs after $T_{k_0-1}/(2\#\text{Crit}(F))$ iterates of the mapping $F^{p_{n-k_0,c_0}}: \mathbf{V}_{c_0}^{n-k_0} \rightarrow \mathbf{V}_{c_1}^{n-k_0-1}$.

Take $k = 6\#\text{Crit}(F) + 1$, so that $k_0 \in \{6\#\text{Crit}(F) + 1, 6\#\text{Crit}(F) + 2\}$. Then we have that the mapping from \mathbf{V}_c^{n-1} to $\mathbf{V}_{c'}^{n-2}$ occurs after six iterates of the mapping from $\mathbf{V}_{c_0}^{k_0}$ to $\mathbf{V}_{c_1}^{k_0-1}$. Let t be the entry time of \mathbf{V}_c^{n-1} to $\mathbf{V}_{c_0}^{n-k_0}$, then we have that $F^t(\mathbf{V}_c^{n-k_0}) \supset \mathbf{V}_{c_0}^{n-k_0}$. Let us now define a sequence of critical points starting with c_0 : let c_{i+1} be so that $F^{p_{n-k_0-i,c_i}}(\mathbf{V}_{c_i}^{n-k_0-i}) = \mathbf{V}_{c_{i+1}}^{n-k_0-(i+1)}$. Set

$$P_{n-k_0, M-k_0, c_0} = p_{n-k_0, c_0} + p_{n-k_0-1, c_1} + p_{n-k_0-2, c_2} + \dots + p_{n-M+1, c_{M-1}}.$$

We have that $F^{P_{n-k_0, M-k_0, c_0}}(\mathbf{V}_{c_0}^{n-k_0})$ is a component of \mathbf{V}^{n-M} .

Let $k(\mathbf{V}_{c_0}^{n-k_0})$ denote the minimal return time to $\mathbf{V}_{c_0}^{n-k_0}$ for $x \in \mathbf{V}_{c_0}^{n-k_0}$, and $r(\mathbf{W}_{c_0}^{n-k_0})$ be the return time of $\mathbf{W}_{c_0}^{n-k_0}$ to $\mathbf{V}_{c_0}^{n-k_0}$. Observe that the six iterates of the mapping from $\mathbf{V}_{c_0}^{n-k_0}$ to \mathbf{V}^{n-k_0-1} occurs after $r(\mathbf{W}_{c_0}^{n-k_0}) + 4k(\mathbf{V}_{c_0}^{n-k_0})$ iterates of F .

Claim 2. $P_{n-k_0, M-k_0, c_0} \leq r(\mathbf{W}_{c_0}^{n-k_0}) + 4k(\mathbf{V}_{c_0}^{n-k_0})$,

Proof of Claim 2. Let $\mathbf{P}^0 = \mathbf{V}_{c_0}^0$, and consider the modified principal nest over c_0 :

$$\mathbf{P}^0 \ni \mathbf{Q}^0 \ni \mathbf{P}^1 \ni \mathbf{Q}^1 \dots$$

defined as follows. Let $\mathbf{Q}^0 = \mathcal{L}_c(\mathbf{P}^0)$. Let $k > 0$ be minimal so that $F^k(c_0) \in \mathbf{Q}^0 \setminus \mathbf{P}^0$, and let $l > k$ be minimal so that $F^l(c_0) \in \mathbf{Q}^0$. Let $\mathbf{P}^1 = \text{Comp}_{c_0} F^{-l}(\mathbf{Q}^0)$. Let $\mathbf{Q}^1 = \mathcal{L}_{c_0}(\mathbf{P}^1)$, and continue inductively. Let t_j be so that $F^{t_j}(\mathbf{P}^j) = \mathbf{P}^{j-1}$. Observe that $t_j \geq t_{j-1} + t_{j-2}$ since return of the critical point to \mathbf{Q}^{j-1} occurs after it passes through $\mathbf{P}^{j-1} \setminus \mathbf{Q}^{j-1}$, and then through $\mathbf{P}^{j-2} \setminus \mathbf{Q}^{j-2}$. Assume that j_0 is minimal so that $\mathbf{P}^{j_0} \subset \mathbf{V}_{c_0}^{n-k_0}$. The same reasoning shows that, $r(\mathbf{W}_{c_0}^{n-k_0}) \geq t_{j_0}$. Then we have that

$$(5.1) \quad r(\mathbf{W}_{c_0}^{n-k_0}) + 4k(\mathbf{V}_{c_0}^{n-k_0}) \geq t_{j_0} + 4t_{j_0-1} \geq t_{j_0} + t_{j_0-1} + \dots + t_1 + t_0 \geq P_{n-k_0, M-k_0, c_0} \quad \checkmark$$

Keeping the same notation as in the proof of the Claim 2 we have that $\mathbf{P}^{j_0} \subset \mathbf{V}_{c_0}^{n-k_0} \subset F^t(\mathbf{V}_c^{n-k_0})$ and $s = r - P_{n-k_0, M-k_0, c_0} - t \geq 0$. So

$$F^s \circ F^{P_{n-k_0, M-k_0, c_0}} \circ F^t(\mathbf{W}_c^n)$$

is a component $\mathbf{V}_{c'_n}^n$ of \mathbf{V}^n . Assuming that c'_j is defined, let c'_{j-1} be so that $F^{P_{j, c'_j}}(\mathbf{V}_{c'_j}^j) = \mathbf{V}_{c'_{j-1}}^{j-1}$. We have that

$$F^{P_{n-k_0+1, c_{n-k_0+1}}} \circ F^{P_{n-k_0+2, c_{n-k_0+2}}} \circ \dots \circ F^{P_{n, c_n}} \circ F^s \circ F^{P_{n-k_0, M-k_0, c_0}} \circ F^t(\mathbf{W}_c^n) = \mathbf{V}_{c_{n-k_0}}^{n-k_0}.$$

Therefore, for some $x \in \text{PC}(F)$, $F^{P_{n, M, c}}(\mathbf{W}_c^n)$ is contained in $\mathcal{L}_x(\mathbf{V}_{c_{n-k_0}}^{n-k_0})$.

Step 2: Let $i \in \{n - k_0, n - k_0 - 1, \dots, n - M\}$, let ν be the first entry time of $B = F^{P_{n, M, c}}(\mathbf{W}_c^n)$ to some \mathbf{W}_c^i . Let $D_i = \text{Comp}_B F^{-\nu}(\mathbf{V}_c^i)$. The mapping $F^\nu: D_i \rightarrow \mathbf{V}_c^i$ has bounded degree, since after the first entry to \mathbf{V}^i it is obtained by iterating the non-critical branches of the return mapping to \mathbf{V}^i . Let $C_i = \text{Comp}_B F^{-\nu}(\mathbf{W}_c^i)$ and set $\mathbf{A}_i = D_i \setminus C_i$. Since for all j , $\mathbf{V}^j \supset \mathbf{W}^j \supset \mathbf{V}^{j+1}$, we have that the \mathbf{A}_i are disjoint.

Step 3: Let μ_j denote $\min(\mathbf{V}_c^j \setminus \mathbf{W}_c^j)$, where the minimum is taken over the critical points c of F . Thus we have that

$$\text{mod}(F^{P_{n, M, c}}(\mathbf{V}_c^n) \setminus F^{P_{n, M, c}}(\mathbf{W}_c^n)) \geq (K_1/K_2)(\mu_{n-M} + \mu_{n-M+1} + \dots + \mu_{n-k_0}).$$

Step 4: It is obvious that the degree of $F^{P_{n, M, c}}|_{\mathbf{V}_c^n}$ is bounded by some constant D that depends on M , so we only show that the degree of $F^{P_{n, M, c}}|_{\mathbf{W}_c^n}$ is bounded by some constant d that does not depend on M . From Step 1, we have that there exists $k_0 \in \{\#\text{Crit}(F) + 1, 6\#\text{Crit}(F) + 2\}$ so that $F^{P_{n, M, c}}(\mathbf{W}_c^n) \subset \mathcal{L}_x(\mathbf{V}_{c'}^{n-k_0})$. Since $M - k_0 \geq 6\#\text{Crit}(F) + 2$, by Claim 2 of Step 1, there exists $k_1 \in \{\#\text{Crit}(F) + 1, 6\#\text{Crit}(F) + 2\}$, so that the following holds. Let us decompose the mapping $F^{P_{n, M, c}}|_{\mathbf{W}_c^n}$ as $F^{P_{n-(k_0+k_1), M-(k_0+k_1), c_1}} \circ F^{P_{n, k_0+k_1, c}}|_{\mathbf{W}_c^n}$, where $c_1 \in \text{Crit}(F)$, is such that $F^{P_{n, k_0+k_1, c}}(\mathbf{V}_c^n) = \mathbf{V}_{c_1}^{n-(k_0+k_1)}$. The degree of $F^{P_{n, k_0+k_1, c}}|_{\mathbf{W}_c^n}$ is bounded by a constant which depends only on $\#\text{Crit}(F)$. Since $M \geq 12\#\text{Crit}(F) + 5 > k_0 + k_1$, $F^{P_{n, k_0+k_1, c}}(\mathbf{W}_c^n)$ belongs to some other component $\mathcal{L}_y(\mathbf{V}_c^{n-k_0})$. Let $r > 1$ be such that $F^r(\mathcal{L}_y(\mathbf{V}_c^{n-k_0})) = \mathbf{V}_c^{n-k_0}$. We have that $r > P_{n-(k_0+k_1), M-(k_0+k_1), c}$, therefore the degree of the mapping $F^{P_{n-(k_0+k_1), M-(k_0+k_1), c''}}|_{F^{P_{n, k_0+k_1, c}}(\mathbf{W}_c^n)}$ is less than or equal to the degree of some landing map $R_{\mathbf{V}_c^{n-k_0}}|_{\mathcal{L}_y(\mathbf{V}_c^{n-k_0})}$, which is bounded by some constant d which depends only on b .

Step 5: Now apply Lemma 5.8 exactly as in the proof of Proposition 5.9. Notice that by Lemma 5.17 there exists $\kappa > 0$ such that $\text{mod}(\mathbf{V}_c^n \setminus \mathbf{W}_c^n) > \kappa\mu_{n-1}$. \square

By Lemma 5.17, we have the following corollary:

Corollary 5.19. *There exists $\delta_0 > 0$ so that each \mathbf{W}^n is δ_0 -nice. In fact we have that for each component \mathbf{U} of $(R_{\mathbf{V}^n}|_{\mathbf{W}^n})^{-1}(\text{Dom}'(\mathbf{W}^n))$ if \mathbf{W}_c^n is the component of \mathbf{W}^n that contains \mathbf{U} then $\text{mod}(\mathbf{W}_c^n \setminus \mathbf{U}) \geq \delta_0$.*

Let us now show that the puzzle pieces \mathbf{V}_c^n from the good nest have δ -bounded geometry. We will require the following lemmas from [KvS].

Lemma 5.20. *Let \mathbf{U} be a domain that has ρ -bounded geometry with respect to some point x and let $\mathbf{A} \subset \mathbf{U}$ be a domain containing x . Then \mathbf{U} has $K\rho$ -bounded geometry with respect to all $y \in \mathbf{A}$, where K depends only on $\text{mod}(\mathbf{U} \setminus \mathbf{A})$.*

Lemma 5.21. *Let $f: \mathbf{U} \rightarrow \mathbf{V}$ be a $(1 + \eta)$ -qc branched covering map $\mathbf{B} \subset \mathbf{V}$ and \mathbf{A} a connected component of $f^{-1}(\mathbf{B})$. Then if \mathbf{B} has ρ -bounded geometry with respect to some point y in \mathbf{B} then \mathbf{A} has $K\rho$ -bounded geometry with respect to $x \in \mathbf{A}$, where K depends only on $\text{mod}(\mathbf{V} \setminus \mathbf{B})$, the degree of f and $\eta > 0$.*

Let us show that each \mathbf{V}_c^j has bounded geometry at $c \in \text{Crit}(F)$. The proof is the same as the proof of [KvS, Proposition 11.1].

Proposition 5.22. *The domains \mathbf{V}_c^j have bounded geometry at c ; that is, there exists $\eta > 0$ so that for each j , $\mathbf{V}_c^j \supset D_{\eta \text{diam}(\mathbf{V}_c^j)}(c)$.*

Proof. Let $\eta_{j,c} > 0$ be so that \mathbf{V}_c^j has $\eta_{j,c}$ -bounded geometry at c . Let l_c and $c' \in \text{Crit}(f)$ be so that $f^{l_c}: \mathbf{V}_c^j \rightarrow \mathbf{V}_{c'}^{j-1}$ is onto. Since $f^{l_c}(c) \in \mathbf{W}_{c'}^{j-1}$ and $\text{mod}(\mathbf{V}_{c'}^{j-1} \setminus \mathbf{W}_{c'}^{j-1}) > \delta$, by Lemma 5.20 there exists K_1 so that $\mathbf{V}_{c'}^{j-1}$ has $K_1\eta_{j-1,c'}$ -bounded geometry at $f^{l_c}(c)$. By Lemma 5.21 there exists K_2 so that $f(\mathbf{V}_c^j)$ has $K_1K_2\eta_{j-1,c'}$ -bounded geometry at $f(c)$. Thus we have that \mathbf{V}_c^j has $\sqrt{K_1K_2\eta_{j-1,c'}}$ -bounded geometry at c . Thus the $\eta_{j,c}$ are bounded away from 0. \square

6. DYNAMICS AWAY FROM CRITICAL POINTS: TOUCHING BOX MAPPINGS

The purpose of this section is to deal with the set of points which always stay away from critical points. More precisely, given an open set \mathcal{I} which contains all critical points and the immediate basin of all periodic attractors, define

$$E(\mathcal{I}) = \{x; f^n(x) \notin \mathcal{I} \text{ for all } n \geq 0\}.$$

In this section we will prove the following

Theorem 6.1 (QC-rigidity of points staying away from the critical points). *Let f, \tilde{f} be conjugate maps as in Theorem A. Let I be an open set which contains all critical points and the immediate basin of all periodic attractors. Then there exists a quasiconformal mapping h so that $h(E(\mathcal{I})) = E(\tilde{\mathcal{I}})$ and so that $h|_{E(\mathcal{I})}$ is a conjugacy between f and \tilde{f} .*

The proof of this theorem will be given at the end of this section, and is complicated by the fact that we do not want to exclude the presence of parabolic periodic points. We will construct suitable “touching box mappings” extending certain iterates of the real mapping along diffeomorphic branches. These touching box mappings will be different from complex box mappings as the boundaries of their domains and the boundaries of their ranges will intersect. As mentioned, the reason we need these touching box mappings is because we

need to deal with the part of the dynamics which does not come close to critical points, and since we will eventually need to cover the entire space by suitable complex domains.

In Subsection 6.3 we shall give a precise definition of the notion of “touching box mapping”, while in the next subsection we will treat the local situation near (not necessarily hyperbolic) repelling periodic points.

6.1. Touching box mappings and petals at (possibly parabolic) periodic points.

To simplify the notation, if $f \in \mathcal{C}$, we will identify f with its asymptotically holomorphic extension of order 3.

Proposition 6.2 (Petals and local QC conjugacies within petals). *Assume that $f \in \mathcal{C}$, that p is a periodic point with $f^s(p) = p$ and that there exists a one-sided neighbourhood $[p, q_0]$ of p with $Df^s(x) \geq 1$. Then there exists $\theta_0 \in (0, \pi/2)$ and $\delta > 0$ so that for each $\theta \in (0, \theta_0)$ and for any interval $J = [p, q] \subset [p, q_0]$ with $|J| < \delta$, such that $f^s|_J$ is a diffeomorphism and $J' = f^s(J) \supset J$, the following holds.*

- (1) $U := \text{Comp}_p f^{-s}(D_{\pi-\theta}(J'))$ is contained in $V := D_{\pi-\theta}(J')$ and they intersect only in the periodic point.
- (2) $\text{Comp}_p f^{-ks}(D_{\pi-\theta}(J'))$ is contained in a set of the form $D_{\pi-\theta}(J_k)$ where $J_k \subset J$ and $|J_k| \rightarrow 0$ as $k \rightarrow \infty$.

Moreover, assume that \tilde{f} is another mapping which is topologically conjugate to f with corresponding periodic point \tilde{p} and intervals \tilde{J}, \tilde{J}' , so that either $Df^s(p)$ and $D\tilde{f}^s(\tilde{p})$ are both greater than one or both equal to one, and J and J' are so small that $\tilde{U} := \text{Comp}_{\tilde{p}} \tilde{f}^{-s}(\tilde{V})$ is contained in $\tilde{V} := D_{\pi-\theta}(\tilde{J}')$.

- (3) Then there exists a K -qc homeomorphism $H: \mathbb{C} \rightarrow \mathbb{C}$ that maps $\partial U \cup \partial V$ to $\partial \tilde{U} \cup \partial \tilde{V}$ such that $\tilde{f}^s \circ H = H \circ f^s$ on U . Here K depends on $|J|/|J'|, |\tilde{J}|/|\tilde{J}'|$ and θ .

In other words, H maps $V \setminus U$ to $\tilde{V} \setminus \tilde{U}$ and is a conjugacy on $\text{Cl}(U)$.

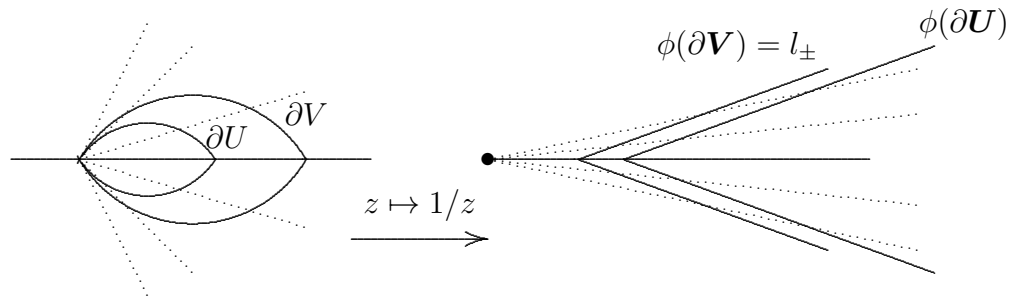

FIGURE 13. Part of the touching box mapping at a fixed point p of f^s , with domain $U := \text{Comp}_p f^{-s}(D_{\pi-\theta}(J'))$ is contained in $V := D_{\pi-\theta}(J')$. The mapping $z \mapsto 1/z$ sends the curves $\partial U, \partial V$ to the wedge-shaped curves on the right.

We note that by [MdMvS], see also Theorem IV.B in [dMvS], each C^3 mapping of the interval or circle has at most a finite number of parabolic or attracting periodic points.

We should note that in the parabolic case, we construct a qc map which maps the parabolic petal associated to $f(z) = z + z^{n+1} + \dots$ to that of $\tilde{f}(z) = z + z^{\tilde{n}} + \dots$ where n and \tilde{n} are not necessarily the same. If $n \neq \tilde{n}$, this qc mapping can definitely **not** be extended to a global conjugacy. Since n and \tilde{n} are not necessarily the same, we cannot argue exactly as in

for example [M, Chapter 10], but have to vary the argument a little. We find it also useful to ensure that \mathbf{V} is a Poincaré domain, so the shape of the 'petals' differs marginally from those usually constructed.

That \mathbf{U} is contained in \mathbf{V} does not simply follow from Proposition 3.7, because no loss of angle is allowed at the points where \mathbf{U} and \mathbf{V} touch.

Proof. It is enough to consider the case that p is a fixed point.

Case 1: Assume that $Df(p) > 1$. Recall that

$$\frac{\bar{\partial}f}{y^2} \rightarrow 0 \text{ as } y \rightarrow 0,$$

and we can express

$$f(z) = \lambda z + az^2 + O(z^3) + R(x, y),$$

where $R(x, y)$ is C^3 and $D^j R(0, 0) = 0$ for $j = 0, 1, 2, 3$, and $R(x, y) = o(\|(x, y)\|^3)$. Note that we are abusing notation and denoting both the interval mapping and its asymptotically conformal extension by f .

Consider the coordinate transformation $w := \phi(z) = 1/z$. Since $\partial\mathbf{V}$ consists of two pieces of circles, $\phi(\partial\mathbf{V})$ consists of two rays of lines l_{\pm} in the w -plane, which can be parametrized by

$$x = \alpha|y| + x_0 \text{ where } w = x + iy,$$

where $\alpha > 0$ depends on θ (with $\alpha \rightarrow \infty$ as $\theta \rightarrow 0$) and where $x_0 = 1/|J'|$. The mapping $z \mapsto f(z) = \lambda z + az^2 + O(z^3)$ (where $a \in \mathbb{R}$) corresponds in w -coordinates to $w \mapsto g(w) = (1/\lambda)w - (a/\lambda^2) + O(1/w)$ whereas its preimage corresponds to $w \mapsto g^{-1}(w) = \lambda w + (a/\lambda) + O(1/w)$. Since $(\alpha|y| + x_0 + i \cdot y) \in l_{\pm} = \partial V$ is mapped by g^{-1} to $(\lambda(\alpha|y| + x_0) + (a/\lambda) + O(1/w)) + i(\lambda y + O(1/w)) \in \partial U$, we get that $\partial\phi(U)$ is parametrized by $(\alpha|y'| + \lambda x_0 + (a/\lambda) + O(1/w)) + i \cdot y'$ (where $y' = \lambda y + O(1/w)$). So $\phi(\partial U)$ is also the image of $\phi(\partial V)$ under the map $w = (x + i \cdot y) \mapsto (x + (\lambda - 1)x_0 + a/\lambda + O(1/w) + i \cdot (y + O(1/w)))$. That is, $\phi(\partial U)$ is up to small error a translation of $\phi(\partial V)$ to the right (since $x_0 < \lambda x_0 + a/\lambda + O(1/w)$ when x_0 is large). So $\phi(V \setminus U)$ corresponds to the strip drawn on the right in Figure 13. The 2nd assertion follows immediately.

Assume that \tilde{f} is a similar map, with corresponding \tilde{U} , \tilde{V} and \tilde{g} . So $\partial\tilde{V}$ can also be parametrized by $x = \alpha|y| + \tilde{x}_0$ where $w = x + i \cdot y$ and $\tilde{x}_0 = 1/|\tilde{J}'|$. Let us now construct a qc mapping $H: \mathbb{C} \rightarrow \mathbb{C}$ in the w plane so that $\hat{H}(\phi(\mathbf{U})) = \tilde{U}$, $\hat{H}(\phi(\mathbf{V})) = \phi(\tilde{V})$ and $\hat{H} \circ g = \tilde{g} \circ \hat{H}$ on $\phi(\mathbf{U})$. To do this, we first define a foliation as follows. Take $w = (x + i \cdot y) \in l_+$, i.e. $x = \alpha|y| + x_0$ with $y > 0$, and consider the line segment $L(w)$ connecting w to $g^{-1}(w)$. Let us show that all these line segments are disjoint. For this observe that for $w \in l_+$, the vectors $T_w(l_+)$ and $Dg^{-1}T_w(l_+)$ are both transversal to and both have the same orientation with respect to the vector $g^{-1}(w) - w$. (To see this, note that $Dg^{-1}T_w(l_+) = Dg_w^{-1}(\alpha + i) = (\lambda + O(1/w^2))(\alpha + i)$, that $g^{-1}(w) - w = (\lambda - 1)w + (a/\lambda) + O(1/w)$ and that $w = x + iy$ is of the form $x = \alpha|y| + x_0$.) Since the same holds for $w \in l_-$, we obtain a foliation on $\phi(\mathbf{V} \setminus \mathbf{U})$ consisting of the line segments $L(w)$, $w \in l_{\pm}$. For $w \in \phi(\mathbf{V} \setminus \mathbf{U})$ define $L(w)$ to be the line segments which contains w . Similarly, we have a foliation on $\phi(\tilde{V} \setminus \tilde{U})$ consisting of the line segments $\tilde{L}(\tilde{w})$, $\tilde{w} \in \tilde{l}_{\pm}$ corresponding to \tilde{f} . Note that $\tilde{l}_{\pm} = l_{\pm} + (\tilde{x}_0 - x_0)$.

Choose $\hat{H}: l_{\pm} \rightarrow \tilde{l}_{\pm}$ so that it maps $(\alpha|t| + x_0 + i \cdot t) \in l_{\pm}$ to $(\alpha|\tilde{t}| + \tilde{x}_0 + i \cdot \tilde{t}) \in \tilde{l}_{\pm}$ where $\tilde{t} = t^{\rho}$ and $\rho = \log \tilde{\lambda} / \log \lambda$. Then define the mapping \hat{H} mapping the leaves of the foliation to the leaves of foliation, interpolating linearly as before. Then, taking $w \in$

l_{\pm} and $\tilde{w} = \hat{H}(w) \in \tilde{l}_{\pm}$, we have $\|\tilde{g}^{-1}(\tilde{w}) - \tilde{w}\|/\|g^{-1}(w) - w\| = \|(\tilde{\lambda} - 1)\tilde{w} + (\tilde{a}/\tilde{\lambda}) + O(1/\tilde{w})\|/\|(\lambda - 1)w + (a/\lambda) + O(1/w)\| \approx \|w\|^{\rho-1}$. At the same, taking $w, w' \in l_{\pm}$ nearby we have $\|\hat{H}(w) - \hat{H}(w')\|/\|w - w'\| \approx \|w\|^{\rho-1}$. It follows that \hat{H} is a K -quasiconformal map from $\phi(\mathbf{V} \setminus \mathbf{U})$ to $\phi(\tilde{\mathbf{V}} \setminus \tilde{\mathbf{U}})$. Next extend \hat{H} to the right of $\phi(\partial\mathbf{V})$ to the right of $\phi(\partial\tilde{\mathbf{V}})$ by $\hat{H}(w) = \tilde{g}^{-n} \circ \hat{H} \circ g^n(w)$ where $n = n(w) \geq 0$ is minimal so that $g^n(w) \in \phi(\mathbf{V} \setminus \mathbf{U})$. Next choose \hat{H} so that for each $0 \leq x \leq x_0$ the point $(\alpha|t| + x + i \cdot t) \in l_{\pm}$ is mapped to $(\alpha|\tilde{t}| + x(\tilde{x}_0/x_0) + i \cdot \tilde{t}) \in \tilde{l}_{\pm}$ where $\tilde{t} = t^{\rho}$. Then $\hat{H}(\alpha|t| + i \cdot t) = (\alpha|t|^{\rho} + i \cdot t^{\rho})$ for $t \geq 0$. One can extend \hat{H} in various ways to the left of the sector $(\alpha|t| + i \cdot t)$, $t \in \mathbb{R}$, for example defining \hat{H} for each vector v not in the sector between $(\alpha - i)$ and $(\alpha + i)$, as follows $\hat{H}(t \cdot v) = t^{\rho} \cdot v$. In this way we get a globally defined qc mapping \hat{H} . Therefore $H: \mathbb{C} \rightarrow \mathbb{C}$ defined by $H(z) = \phi^{-1} \circ \hat{H} \circ \phi(z)$ is again a quasiconformal map such that $H(\mathbf{U}) = \tilde{\mathbf{U}}$, $H(\mathbf{V}) = \tilde{\mathbf{V}}$ and $\tilde{f} \circ H = H \circ f$ on \mathbf{U} .

Observe that the mapping $f|_U$ is monotone, and U contains no parabolic points. So that Lemma 4.4 implies that

$$\sum_{n=0}^{\infty} |(f|_U)^{-n}(U)|^2 < C|U|^{1/2}.$$

Since we have no loss of angle at periodic points, and $f \in \mathcal{C}$ this implies that the dilatations of the $g^n: g^{-n}(\phi(\mathbf{V} \setminus \mathbf{U})) \rightarrow \phi(\mathbf{V} \setminus \mathbf{U})$ are summable, and indeed bounded from above by $C|U|^{1/2}$.

Case 2: Let us now consider the parabolic case, i.e. $f(z) = z + az^{n+1} + \dots$ with $a > 0$. In this case define the $w = \phi(z) = 1/z^n$. Then f corresponds to $g(w) = w - (na) + O(1/\sqrt[n]{|w|})$ which has inverse $g^{-1}(w) = w + (na) + O(1/\sqrt[n]{|w|})$. The set $\partial\mathbf{V}$ corresponds under ϕ to the n -th power of the half-lines l_{\pm} from Case 1 (note that $\phi(z) = (1/z)^n$). One can parametrize l_{\pm} by $\alpha|y| + x_0 + i \cdot y \in \mathbb{C}$ where $y \in \mathbb{R}$ and where $\alpha \rightarrow \infty$ when $\theta \rightarrow 0$. The n -th power of these two half-lines is equal to $(\alpha|y| + x_0 + i \cdot y)^n = y^n(\pm\alpha + x_0/y + i)^n$, which for $|y|$ large is again almost a line. When $\alpha > 0$ is sufficiently large, $\phi(\partial\mathbf{V})$ is contained in $\{w = x + i \cdot y; x, y \in \mathbb{R} \text{ and } x \geq A\}$ with A large. Moreover, $\phi(\partial\mathbf{V})$ can be parametrized by $\beta(t) + i \cdot t + x_0$ where β is a smooth function with $\beta'(s) \rightarrow \pm c$ as $s \rightarrow \pm\infty$ with $\alpha \in (0, \infty)$ depends on θ and $\alpha \rightarrow \infty$ when $\theta \rightarrow 0$) and where $x_0 = (1/|J'|)^n$. The set $g^{-1}(\phi(\partial\mathbf{V}))$ is to the right of $\phi(\partial\mathbf{V})$ since $a > 0$. Hence $\phi(\mathbf{V} \setminus \mathbf{U})$ corresponds again to a similar strip as before, see the right part of Figure 13, and that $\mathbf{U} \subset \mathbf{V}$ with only a common point in p .

Now assume that \tilde{f} is a similar map, with corresponding $\tilde{\mathbf{U}}, \tilde{\mathbf{V}}$ and \tilde{g}_2 , but not necessarily with the same order of contact. That is $\tilde{f}(z) = z + \tilde{a}z^{\tilde{n}+1} + \dots$ and $\tilde{\phi}(z) = 1/z^{\tilde{n}}$. Let us again define a mapping \hat{H} similarly as before. For each $w \in \phi(\partial\mathbf{V})$ take the line segment $L(w)$ connecting w to $g^{-1}(w) \in \phi(\partial\mathbf{U})$. As before, this defines a foliation in $\phi(\mathbf{V} \setminus \mathbf{U})$. Next define $\hat{H}: \phi(\partial\mathbf{V}) \rightarrow \tilde{\phi}(\partial\tilde{\mathbf{V}})$ by mapping $w = \beta(t) + i \cdot t + (1/|J'|)^n$ to $\tilde{w} = \tilde{\beta}(t) + i \cdot t + (1/|\tilde{J}'|)^{\tilde{n}}$. Next extend $\hat{H}: \phi(\partial\mathbf{V}) \rightarrow \tilde{\phi}(\partial\tilde{\mathbf{V}})$ continuously to $\hat{H}: \phi(\mathbf{V} \setminus \mathbf{U}) \rightarrow \tilde{\phi}(\tilde{\mathbf{V}} \setminus \tilde{\mathbf{U}})$ so that for each $w \in l_{\pm}$, the line segment $L(w)$ is mapped to the line segment $\tilde{L}(w)$ by linear interpolation. Note that in this case $\|\tilde{g}^{-1}(\tilde{w}) - \tilde{w}\|$ and $\|g^{-1}(w) - w\|$ (with $w \in \phi(\partial\mathbf{V})$ and $\tilde{w} \in \tilde{\phi}(\partial\tilde{\mathbf{V}})$) are both bounded. As defined, we have that \hat{H} is K -qc for some $K \geq 1$. To see that \hat{H} is K' -qc. we need only observe that backward orbits converge to 0 at a rate

$$|z'_{-n}| \asymp \left(\frac{1}{\frac{1}{|z_0|^d} + dn} \right)^{1/d}$$

and since f is C^{d+2} , and the asymptotically conformal extension is of order $d + 2$ in a neighbourhood of 0 in the complex plane. So that we can bound that qc constant of \hat{H} from above by

$$K + \sum_{n=0}^{\infty} \left(\frac{1}{\frac{1}{|z_0|^d} + dn} \right)^{(d+1)/d},$$

which converges. It follows that $\hat{H}: \phi(\mathbf{V} \setminus \mathbf{U}) \rightarrow \phi(\tilde{\mathbf{V}} \setminus \tilde{\mathbf{U}})$ is K -quasiconformal. Next extend \hat{H} to the right of $\phi(\partial\mathbf{V})$ to the right of $\phi(\partial\tilde{\mathbf{V}})$ by $\hat{H}(w) = \tilde{g}^{-n} \circ \hat{H} \circ g^n(w)$ where $n = n(w) \geq 0$ is minimal so that $g^n(w) \in \phi(\mathbf{V} \setminus \mathbf{U})$. On the strip between the sector $(c|t| + i \cdot t)$, $t \in \mathbb{R}$ and $\partial\mathbf{V}$ define \hat{H} so it maps to the strip between the sector $(\alpha|t| + i \cdot t)$, $t \in \mathbb{R}$ $\partial\tilde{\mathbf{V}}$ by linearly interpolating horizontal lines. In particular, $\hat{H}(\alpha|t| + i \cdot t) = \alpha|t| + i \cdot t$ for all $t \in \mathbb{R}$ and \hat{H} is K -quasiconformal on the sector to the right of these rays through 0. Since ϕ is not univalent anyhow, we will not extend \hat{H} globally.

Let $\beta = \arg(\alpha + i) \in (0, \pi/2)$. Then ϕ maps the sector $\{z \in \mathbb{C}; |\arg(z)| < \beta/n\}$ to the sector to right of $(\alpha|t| + i \cdot t)$, $t \in \mathbb{R}$. Similarly, $\tilde{\phi}$ maps the sector $\{z \in \mathbb{C}; |\arg(z)| < \beta/\tilde{n}\}$ to the sector to right of $(\alpha|t| + i \cdot t)$, $t \in \mathbb{R}$. So we obtain that $H(z) = \tilde{\phi}^{-1} \circ \hat{H} \circ \phi(z)$ is a well-defined K -qc mapping from the sector $\{z \in \mathbb{C}; |\arg(z)| < \beta/n\}$ to the sector $\{z \in \mathbb{C}; |\arg(z)| < \beta/\tilde{n}\}$. Note that $H(te^{\pm i \cdot \beta/n}) = t^{\tilde{n}/n} e^{\pm i \cdot \beta/\tilde{n}}$. Finally, one can extend H so that $H(te^{\pm i \cdot \gamma}) = t^{\tilde{n}/n} e^{\pm i \cdot \tilde{\gamma}}$ where $[\beta/n, 2\pi - \beta/n] \ni \gamma \mapsto \tilde{\gamma} \in [\beta/\tilde{n}, 2\pi - \beta/\tilde{n}]$ is a linear map. \square

6.1.1. *Touching box mappings and petals in a complex neighbourhood of (possibly parabolic) periodic points.* This subsection is an addendum to Proposition 6.2. We will show how to extend conjugacies to neighbourhoods of periodic points in the hyperbolic repelling case or in the parabolic case when the multiplicities of the parabolic points are the same.

Proposition 6.3 (Petals and local QC conjugacies within petals). *Let f, \tilde{f} be topologically conjugate maps which satisfy the assumptions of the previous proposition and let p, \tilde{p} be corresponding periodic points of, say, period s . Moreover, assume that either*

- (1) p and \tilde{p} are both hyperbolic repelling periodic points of f, \tilde{f} respectively, or
- (2) p and \tilde{p} are both parabolic and

$$f^s(x) = p + \lambda(x - p) + a(x - p)^{d+1} + o(|x - p|^{d+1})$$

and

$$\tilde{f}^s(x) = \tilde{p} + \lambda(x - \tilde{p}) + \tilde{a}(x - \tilde{p})^{d+1} + o(|x - \tilde{p}|^{d+1})$$

where $\lambda = \tilde{\lambda} \in \{-1, 1\}$, $d = \tilde{d}$ and a, \tilde{a} have the same sign.

Then one can obtain a quasiconformal conjugacy H on a complex neighbourhood of p .

Proof. The case when p is hyperbolic and repelling was already considered in the proof of the previous proposition. Let us next consider the case that $s = 1$, $\lambda = 1$, $a > 0$ and $d = 2$. For convenience assume $p = 0$. Then f has a fixed point at 0 which on \mathbb{R} repels on both sides of p . Therefore there exists two repelling petals along the real line. Let us assume that on these two repelling petals the conjugacy is already defined. Since $d = 2$, there exists one attracting petal between the repelling petals in the vertical direction at p . Indeed, consider $w := \phi(z) = 1/z^2$ and let g be the mapping corresponding to f in the w -coordinates (taking the branch corresponding to the positive half-plane in the left-panel of Figure 14.). Take

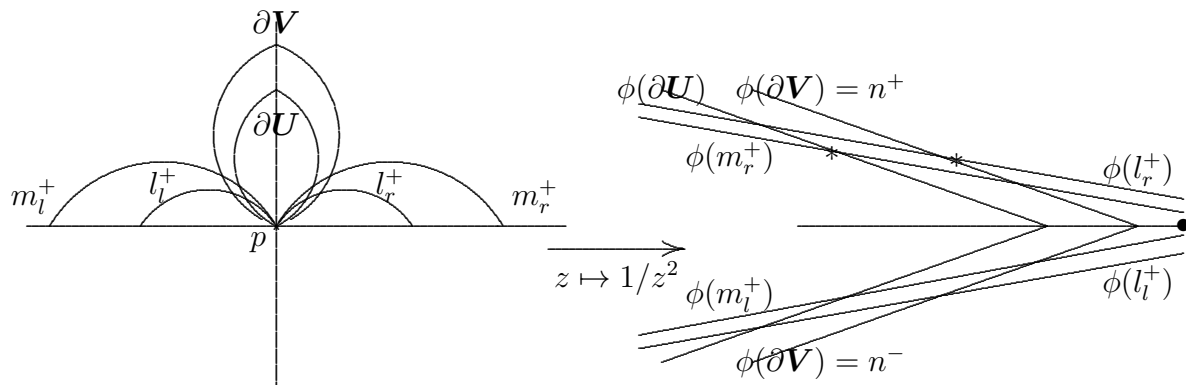

FIGURE 14. Part of the touching box mapping at a fixed point p of f^s , with domain $\mathbf{U} := \text{Comp}_p f^{-s}(D_{\pi-\theta}(J'))$ is contained in $\mathbf{V} := D_{\pi-\theta}(J')$. In this case \mathbf{U} maps to \mathbf{V} . The pre-image under $z \mapsto 1/z^2$ of the wedge-shaped region on the right, bounded by half-lines $\phi(m^\pm)$ and n^\pm , have preimages which form part of the boundary of the horizontal and vertical petal. The point 0 in the w plane is marked by a \bullet in the right panel.

two half-lines n^\pm through a point in the negative real axis in the w -plane as in the figure and consider $g(n^+)$. Then $\phi^{-1}(n^\pm)$ and $\phi^{-1}(g(n^\pm))$ bound two regions \mathbf{U} and \mathbf{V} (only the components in the upper half-plane are shown in Figure 14). The part of the petal to the right of p above the real axis is bounded by curves l and m (and the real axis). These curves correspond in the w -coordinates to half-lines $\phi(l^\pm)$ and its image under g . As in the proof of the previous proposition g is close to a translation. The conjugacy H from the previous proposition is defined on \mathbf{W} , the image of \mathbf{V} in w -coordinates. So in the w -coordinates H is defined above the line $\phi(m^+)$ and below the line $\phi(m^-)$. This mapping can be extended in the same way to the region in the w -plane to the left of n^\pm and above the real line. Exactly as in the proof of the previous proposition, this gives a quasiconformal conjugacy on the right half of the petal \mathbf{V} . To construct the conjugacy on the left half of the petal \mathbf{V} , we next extend the conjugacy in the same way on the left petal. In this way, we obtain in this case a qc conjugacy on a complex neighbourhood of p .

If $d > 2$ there are more petals, but in the same way we glue the construction of the conjugacies of the petals along the real line to a conjugacy on a neighbourhood of p .

If $d = 1$ and $a > 0$ then one has an attracting and repelling petal along the real line, and there are no other petals. In this case, in order to ensure that the petal regions overlap, we introduce a region which is no longer lens-shaped: replace the lines $x = \alpha|y| + x_0$ with $\alpha > 0$ in the w -plane, as was done in Figure 13, to lines $x = \alpha|y| + x_0$ with $\alpha < 0$ as in Figure 15. The corresponding regions then are no longer lens-shaped, but we as before we can glue the construction of the conjugacy in the attracting petal on the left with the conjugacy in the repelling petal on the right to obtain a quasiconformal conjugacy on a neighbourhood of p . \square

6.2. Angle control in the presence of parabolic points. To prove the existence of the touching box mappings, we shall also need the following corollary.

Corollary 6.4. *Suppose that f is C^3 and that p is a periodic point of period s . There exists $\delta > 0$ and $\theta_0 \in (0, \pi/2)$, such that for any $\theta \in (0, \theta_0)$ and all i sufficiently large,*

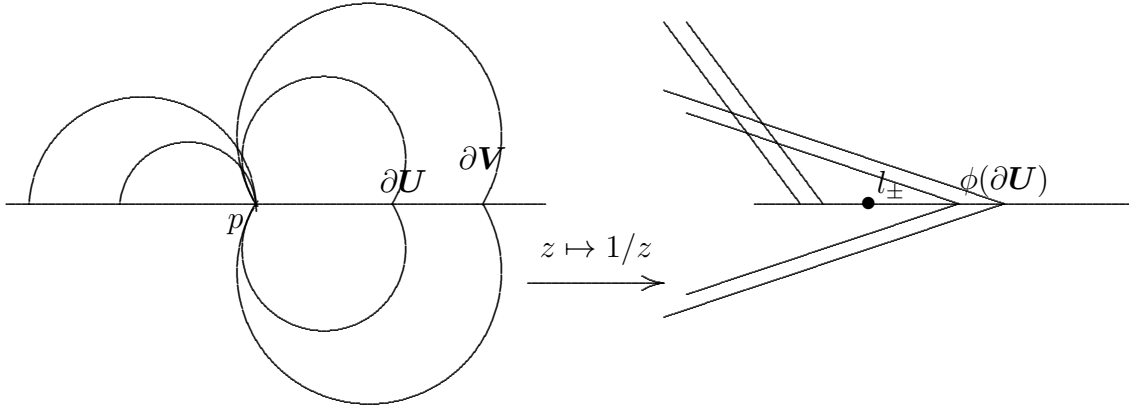

FIGURE 15. Part of the touching box mapping at a fixed point p of f^s , with domain $\mathbf{U} := \text{Comp}_p f^{-s}(D_{\pi-\theta}(J'))$ is contained in $\mathbf{V} := D_{\pi-\theta}(J')$. The mapping $z \mapsto 1/z$ sends the curves $\partial\mathbf{U}, \partial\mathbf{V}$ to the wedge-shaped curves on the right. Here $\phi(\partial\mathbf{V}) = l_{\pm}$

we have the following. Take $J = [p, q_0]$ and $J' = f^s(J)$, with $|J'| < \delta$. Assume that x is such that $f^k(x) = p$ and that J_x is a one-sided neighbourhood of x so that $f^k(J_x) \rightarrow J$ is a diffeomorphism with $Df^k(x) \neq 0$. Then

$$\text{Comp}_x f^{-n}(D_{\pi-\theta}(J')) \subset D_{\pi-\theta}(J_x),$$

where $n = k + is$.

Proof. When f is analytic, we argue as follows. By Proposition 6.2, $\text{Comp}_p f^{-is}(D_{\pi-\theta}(J')) \subset D_{\pi-\theta}(J)$ for all $i > 0$. Moreover, for fixed θ , the curvature of the boundary of $f^{-is}D_{\pi-\theta}(J')$ tends to ∞ as $i \rightarrow \infty$, and the diameter of this set shrinks to zero. At the same time, f^k is a C^3 diffeomorphism from a real neighbourhood W_x of J_x to a neighbourhood of J , the curvature of $D_{\pi-\theta}(J)$ is bounded, and $(f^k|_{W_x})^{-1}(\text{Comp}_p f^{-is}(D_{\pi-\theta}(J')))$ and $D_{\pi-\theta}(J_x)$ are tangent to each other at x .

To make this argument work when f is C^3 we need to show that the curvature of $f^{-is}D_{\pi-\theta}(J')$ tends to ∞ as $i \rightarrow \infty$. Let $J_0 = J'$ and set $J_k = \text{Comp}_p f^{-ks}(J_0)$. Let Λ_{J_k} be the rescaling from an interval I of unit size to J_k , $k = 0, \dots, i$ and let $g = \Lambda_{J_0}^{-1} \circ f^s \circ \Lambda_{J_1}$ near p . By the Faà di Bruno Formula, we have the following expression for the second derivative of g^k .

$$D^2 g^k(z) = D^2 g \circ g^{k-1}(z) \cdot (Dg^{k-1}(z))^{\otimes 2} + \sum_{j=1}^{k-1} Dg^{k-j} \circ g^j(z) \cdot D^2 g \circ g^{j-1}(z) \cdot (Dg^{j-1}(z))^{\otimes 2}.$$

Since the asymptotically holomorphic extension of f is C^3 , there exists $C_0 > 0$ be so that $\|f\|_{C^3} < C_0$. In particular, we have that Df^s and $D^2 f^s$ are uniformly Lipschitz. Thus we have that if $x_0 \in J_k$ and $y_0 \in \text{Comp}_p f^{-ks}(D_{\pi-\theta}(J_0))$, then

$$\|Df^s(x_0) - Df^s(y_0)\| \leq C_0|x_0 - y_0| \leq C_0|J_k|.$$

So we have that

$$\|Df^s(y_0)\| \leq C_0|J_k| + \|Df^s(x_0)\|.$$

By the chain rule, we have that

$$\begin{aligned} \|Df^{ks}(y_0)\| &\leq \prod_{i=1}^k (C_0|J_i| + \|Df^s(f^{si}(x_0))\|) \\ &\leq C_1 \prod_{i=1}^k \left(|J_i| + \frac{|J_{i-1}|}{|J_i|} \right) \leq C_2 \prod_{i=1}^k \frac{|J_{i-1}|}{|J_i|} \left(1 + \frac{|J_i|^2}{|J_{i-1}|} \right) \\ &\leq C_3 \left(\frac{J_0}{J_1} \right)^k \prod_{i=1}^k \left(1 + \frac{|J_i|^2}{|J_{i-1}|} \right) \leq C_4 \left(\frac{|J_0|}{|J_1|} \right)^k. \end{aligned}$$

Now for the rescaled maps, observe that there exists a constant C' so that

$$\|D(\Lambda_{J_0}^{-1} \circ f^{sk} \circ \Lambda_{J_k})\| \leq C',$$

and

$$\|D^2(\Lambda_{J_{i-1}}^{-1} \circ f^s \circ \Lambda_{J_i})(x)\| \leq C'|J_i| \|D^2 f^s|_{D_\theta(J_i)}\|.$$

Observe that for a fixed periodic point p , $\|D^2 f^s|_{D_\theta(J_1)}\|$ is bounded. Therefore we have that there exists a constant $C > 0$ such that

$$\|D^2 g^k\| \leq C \sum_{i=1}^k \|D^2(\Lambda_{J_{i-1}}^{-1} \circ f^s \circ \Lambda_{J_i})\| \leq C \sum_{i=1}^k |J_i|,$$

which can be made as small as we like by choosing of $J' = J_0$ small. \square

Proposition 6.5 (Pullbacks of Poincaré lens domains). *Let $f \in \mathcal{C}$ be a mapping with periodic points. Let I be a real neighbourhood of the set of critical points of f and let B_0 be the union of the immediate basins of attraction of the periodic attractors of f . There exist constants $\delta > 0$, $C > 0$ and $\theta_0 \in (0, \pi/2)$, so that for any $\theta \in (0, \theta_0)$, there exists θ' with the following properties. Let Z' and $\mathcal{P}' = M \setminus Z'$ be a set and a partition given by Lemma 4.9, so that each periodic point in Z' is within distance δ from a different point in Z' , on both sides if the periodic point is repelling on both sides. Let J' be a component of \mathcal{P}' and let J be a component of $f^{-n}(J')$ such that $f^n|_J$ is a diffeomorphism. Assume that $f^i(J) \cap (I \cup B_0) = \emptyset$ for all $i = 0, \dots, n-1$. Then*

$$\text{Comp}_J f^{-n}(D_{\pi-\theta}(J')) \subset D_{\pi-\theta'}(J),$$

where $\theta' < C\theta$.

Proof. Case 1. Let us first suppose that J' does not contain a parabolic point in its boundary. By Lemma 4.5, there exists a constant C such that $\sum_{i=0}^n |f^i(J)|^{3/2} < C$. Moreover, since f has no wandering domains, there exists a constant $C' > 0$ such that for all i , $|f^i(J)| < C'|J'|$. So we have that

$$\sum_{i=0}^n |f^i(J)|^2 < C'|J'|^{1/2} \sum_{i=0}^n |f^i(J)|^{3/2} < CC'|J'|.$$

Now, by Lemma 3.15, since $f^n: J \rightarrow J'$ is a diffeomorphism,

$$(f^n|_J)^{-1} D_{\pi-\theta}(J') \subset D_{\pi-\theta'}(J),$$

where $|\theta' - \theta| \rightarrow 0$ as $|J'| \rightarrow 0$.

Case 2. Suppose now that J' contains a parabolic periodic point p in its boundary. Let \hat{p} denote the orbit of p . For convenience let us assume that f^s is orientation preserving near

p . Let $k_0, 0 \leq k_0 \leq n$ be minimal so that $f^{k_0}(J)$ contains a point of \hat{p} in its boundary. Let $k_1, k_1 \geq k_0$ be minimal so that $f^{k_1}(J)$ contains p in its boundary. Then by Proposition 6.2

$$\text{Comp}_{f^{k_1}(J)} f^{-(n-k_1)} D_{\pi-\theta}(J') \subset D_{\pi-\theta}(f^{k_1}(J)).$$

By Lemma 3.15, there exists θ' , close to θ so that

$$\text{Comp}_{f^{k_0}(J)} f^{-(n-k_0)} D_{\pi-\theta}(J') \subset D_{\pi-\theta'}(f^{k_0}(J)).$$

By the choice of \mathcal{P}' , $f^{k_0}(J)$ cannot contain a parabolic periodic point in its boundary. If $k_0 = 0$ we are done. Otherwise, arguing as in Case 1 finishes the proof. \square

6.3. Global touching box mappings. In order to deal with the part of the dynamics which stays away from the set of critical points, we shall introduce so-called *global touching box mappings*. These are maps for which the domains and ranges touch at certain points, and where the domain does not contain critical points. These objects are similar to what was constructed in Kozlovski's thesis [Ko] and are defined as follows. (But in Kozlovski's setting there are big bounds and no parabolic points, so we have to argue somewhat more carefully here.)

Consider a C^3 mapping $f: M \rightarrow M$, where M is $[0, 1]$ or S^1 . Let B_0 be the union of immediate basins of attraction of f (possibly one-sided). Let Z' be a finite forward invariant set containing the boundary points of B_0 , the boundary points of a nice real neighbourhood K of the set of critical points of f and all parabolic orbits. Let $N \geq 1$ be an integer, $Z \subset f^{-N}(Z')$ and take $\theta \in (0, \pi/2)$. We say that

$$F_T: \mathcal{U}_T \rightarrow \mathcal{V}_T$$

is a *touching box mapping* if the following hold. Let \mathcal{P} and \mathcal{P}' be the partitions corresponding to Z and Z' , respectively.

(a) We have

$$\mathcal{V}_T = \cup_{J'} D_{\pi-\theta}(J')$$

where the union runs over all components J' of \mathcal{P}' .

(b) We have $\text{closure}(\mathcal{U}_T)$ contains

$$[0, 1] \setminus \text{int}(B_0 \cup K) \quad \text{or} \quad S^1 \setminus \text{int}(B_0 \cup K).$$

(c) For each component J of \mathcal{P} in the complement of $K \cup B_0$, there exists an integer $k = k(J) \leq N$ so that $f^k|_J$ is a diffeomorphism and $J' := f^k(J) \in \mathcal{P}'$. Correspondingly, there exists a set $\mathcal{U}(J)$ with $\mathcal{U}(J) \cap \mathbb{R} = J$, which is mapped by the asymptotically holomorphic extension of $f^k: J \rightarrow J' \in \mathcal{P}'$ diffeomorphically onto $D_{\pi-\theta}(J')$; that is,

$$f^{k(J)}: \mathcal{U}(J) \rightarrow \text{Comp}_{J'}(\mathcal{V}_T)$$

is an asymptotically conformal diffeomorphism. Define $F_T|_{\mathcal{U}(J)}$ to be this extension of $f^{k(J)}$ and let

$$\mathcal{U}_T = \bigcup_J \mathcal{U}(J)$$

where the union is taken over all these intervals J .

(d) $\mathcal{U}_T \subset \mathcal{V}_T$. More precisely, each component of \mathcal{U}_T is either compactly contained in \mathcal{V}_T or it has a quadratic tangency with \mathcal{V}_T . Any two components of \mathcal{U}_T which have a common end point, do not have a tangency.

Note that by Theorem B of [MdMvS] there are only finitely many periodic attractors. Note that \mathbf{U}_T does not contain critical points of f , and that \mathbf{U}_T does not cover the entire interval $[0, 1]$ (resp. S^1). See Figure 2 for a sketch of a global touching box mapping.

Theorem 6.6 (Global touching box mappings). *Suppose that $f \in \mathcal{C}$ is a mapping with periodic points. For each $\tau > 0$, there exists a nice real neighbourhood K of the set of critical points of f , such that $\text{diam}(K(c)) < \tau$ for each $c \in \text{Crit}(f)$, and finite forward invariant sets Z and Z' as above, and $\theta \in (0, \pi/2)$ so that these choices give a touching box mapping as defined above.*

Moreover, if \tilde{f} is another mapping of class \mathcal{C} that is topologically conjugate to f by a conjugacy that maps parabolic points bijectively to parabolic points, then we can take Z, Z', θ for F_T so that

- if \tilde{Z}, \tilde{Z}' and $\tilde{\theta} = \theta$ are the corresponding objects for \tilde{f} , these objects yield a touching box mapping for \tilde{f} ;
- there exists a qc mapping $H: \mathbb{C} \rightarrow \mathbb{C}$ with $H(\mathbf{V}_T) = \tilde{\mathbf{V}}_T$, $H(\mathbf{U}_T) = \tilde{\mathbf{U}}_T$ which agrees with the topological conjugacy on Z and which agrees on the petals attached to periodic points in Z' with the conjugacy H defined in Proposition 6.2;
- inside the components \mathbf{V}_i of \mathbf{V}_T , which do not intersect \mathbf{U}_T , we can choose $H: \mathbf{V}_i \rightarrow \tilde{\mathbf{V}}_i$, so that it extends a qs-conjugacy $h: V_i \rightarrow \tilde{V}_i$ provided that the following holds: for each $x \in V_i$ so that there exists $f^n(x) \in Z'$ one has $\tilde{f}^n \circ h(x) = H \circ f^n(x)$.

Proof. Let $\theta_0 \in (0, \pi/2)$ and $\delta > 0$ be as in Proposition 6.2. Let \mathcal{P} be the partition given by Lemma 4.9. Let c be any critical point of f . If f is infinitely renormalizable at c we can choose $\mathcal{P}(c)$ so that $|\mathcal{P}(c)| < \tau$; moreover, taking $\mathcal{P}(c)$ smaller if necessary we can assume that if c' is any critical point whose orbit accumulates on c , then $|\text{Comp}_{c'} f^{-n}(\mathcal{P}(c))| < \tau$, where n is minimal so that $f^n(c') \in \mathcal{P}(c)$. If f is finitely renormalizable at c , then let $K' = \mathcal{P}(c)$. The interval K' is a periodic interval of period $s \geq 0$ and the mapping $f^s: K' \rightarrow K'$ is non-renormalizable. Observe that we do not exclude the possibility that f is non-renormalizable at c . By the last point of Lemma 4.9 there exists a nice interval $K(c)$ containing c such that $|K(c)| < \tau$ for any $c \in \text{Crit}(f)$ and $\partial K(c)$ consists of preperiodic points. Let Z' be a smallest finite forward invariant set that contains the boundary points of all immediate basins of periodic attractors of f , all parabolic periodic orbits, and the points $\cup_{c \in \text{Crit}(f)} \partial K(c)$ and with the property that each periodic point p in Z' is within distance δ from a point p' in Z' , with $p' \neq p$ (on each side if p is repelling on both sides). Such a set exists by Lemma 4.9. Let Z_0 be the collection of periodic points in Z' . Now choose $\theta \in (0, \theta_0)$ so small that for any interval T and any n for which $f^i(T) \cap (I \cap B_0) = \emptyset$, $i = 0, 1, \dots, n-1$, so that $f^n|_T$ is a diffeomorphism, one has

$$\text{Comp}_T f^{-n}(D_{\pi-\theta}(T')) \subset D_{\pi-\theta_0}(T),$$

where $T' = f^n(T)$.

Next choose N_0 large enough so that each point $x \in Z'$ is mapped into Z_0 within N_0 iterates of f , and choose $N > N_0$ so that $N - N_0$ is a multiple of the periods of the periodic orbits of f in Z_0 and so large that we can apply Corollary 6.4 for each $p \in Z_0$ and each $x \in Z'$; in other words, when J_x is a component of \mathcal{P}' containing x in its boundary and J'_p is a component of \mathcal{P}' containing $p = f^N(x) \in Z_0$, then

$$\text{Comp}_x f^{-N} D_{\pi-\theta}(J_p) \subset D_{\pi-\theta}(J_x).$$

Now let

$$Z = \{x : f^N(x) \in Z' \text{ and } f^i(x) \notin I \cup B_0 \text{ for all } i = 0, 1, \dots, N-1\},$$

and let \mathcal{P} be the corresponding partition. For each component J of \mathcal{P} , there exists $k(J) \leq N$ such that $f^k|_J$ is a diffeomorphism and $J' := f^k(J) \in \mathcal{P}'$. If $k < N$, then $f^k(J)$ is equal to a component of I or of B_0 . Define $\mathbf{V}_T = \cup_{J' \in \mathcal{P}'} D_{\pi-\theta}(J')$. Let $\mathbf{U}_T = \cup_{J \in \mathcal{P}} \mathbf{U}(J)$, and

$$F_T(x) = f^{k(J)}(x).$$

Now we need to check that $F_T: \mathbf{U}_T \rightarrow \mathbf{V}_T$ is a touching box mapping. We must show that $\mathbf{U}_T \subset \mathbf{V}_T$ in the required way. Let $J \in \mathcal{P}$ and let \hat{J} be the component of \mathcal{P}' which contains J . By

$$\text{Comp}_T f^{-n}(D_{\pi-\theta}(T')) \subset D_{\pi-\theta_0}(T),$$

we have that

$$\mathbf{U}(J) \subset \text{Comp}_J(f^{-k(J)} D_{\pi-\theta}(J')) \subset D_{\pi-\theta_0}(J) \subset D_{\pi-\theta}(\hat{J}),$$

when J and \hat{J} do not have a common boundary point. If J has a common boundary point with J' then we have that $\mathbf{U}(J) \subset \mathbf{V}(J')$.

It follows from Proposition 6.2 that there is a qc-conjugacy as in the statement of the theorem. Consider a point x where $\partial \mathbf{U}_T$ and $\partial \mathbf{V}_T$ are tangent to each other. Each such point is contained in Z and therefore is mapped by some iterate f^n to a periodic point $f^n(x) = p$. Hence, provided that $\theta \in (0, \pi/2)$ is chosen sufficiently small, we can define H near x by nearly repeating the argument of Proposition 6.2.

That H is quasisymmetric at a point x where some \mathbf{V}_i and \mathbf{V}_j touch can be seen as follows. Each such point is mapped under N_0 iterates to some periodic point $b \in Z_0$ of say period s with associated petal(s) $\mathbf{V}_{i'}$ and $\mathbf{V}_{j'}$. By construction H is a quasiconformal conjugacy on a complex neighbourhood of b intersected with the Poincaré lens domains $\mathbf{V}_{i'}$ and $\mathbf{V}_{j'}$. Moreover, if y is near b and $f^n(y) \in Z'$, then $\tilde{f}^n(H(y)) \in \tilde{Z}'$. Such points converge no faster than exponentially to b and the rates of approach are the same from both sides of b . Since $f \mapsto f^N(t)$ is a diffeomorphism near x , and the assumption that parabolic periodic points are mapped bijectively to parabolic periodic points that there exists a similar sequence of points approaching from both sides of x and the rates of approach are the same. It follows that H is quasisymmetric at x . \square

The proof of Theorem 6.1 follows immediately from the following corollary to Theorem 6.6.

Corollary 6.7 (Rigidity away from $\text{Crit}(f)$). *Consider two \mathcal{C} maps f and \tilde{f} as in the Theorem A that are topologically conjugate, by a topological conjugacy that maps hyperbolic, respectively parabolic, periodic points of f to hyperbolic, respectively parabolic, periodic points of \tilde{f} . Assume that associated to these maps we have two touching box mappings*

$$F_T: \mathbf{U}_T \rightarrow \mathbf{V}_T \text{ and } \tilde{F}_T: \tilde{\mathbf{U}}_T \rightarrow \tilde{\mathbf{V}}_T$$

defined as in the Theorem 6.6. Then there exists a quasiconformal conjugacy $H: \mathbf{V}_T \rightarrow \tilde{\mathbf{V}}_T$ so that $H(\mathbf{U}_T) = \tilde{\mathbf{U}}_T$, and so that $\tilde{F}_T \circ H = H \circ F_T$ on \mathbf{U}_T . Restricted to $\mathbf{V}_T \setminus \mathbf{U}_T$, this H agrees with the H from Theorem 6.6.

Proof. Define H_0 to be equal to the K -qc map $H: \mathbf{V}_T \rightarrow \tilde{\mathbf{V}}_T$ from Theorem 6.6. Since $H(\mathbf{U}_T) = \tilde{\mathbf{U}}_T$, $\tilde{F}_T \circ H = H \circ F_T$ on $\partial \mathbf{U}_T$, and $F_T: \mathbf{U}_T \rightarrow \mathbf{V}_T$ and $\tilde{F}_T: \tilde{\mathbf{U}}_T \rightarrow \tilde{\mathbf{V}}_T$ are

conjugate, and these maps have no critical points, we can inductively define H_n on \mathbf{U}_T by $\tilde{F}_T \circ H_n = H_{n-1} \circ F$ on \mathbf{U}_T and $H_n = H_{n-1}$ on $\mathbf{V}_T \setminus \mathbf{U}_T$.

It follows from Lemma 4.5 as we pull back that the limiting mapping is K' -qc: we can control the sum of diameters along the pullbacks of intervals, which in turn controls the constant of quasiconformality. \square

Note that the Julia set $K(F_T) = \{z \in \mathbf{U}_T; (f_T)^n(z) \in \mathbf{U}_T \text{ for all } n \geq 0\}$ of the touching box mapping $F_T: \mathbf{U}_T \rightarrow \mathbf{V}_T$ is in general *not* hyperbolic (if f has parabolic periodic points).

7. COMBINATORIAL EQUIVALENCE AND EXTERNAL CONJUGACIES

In this section, we will show that two holomorphic complex box mappings that are non-renormalizable and combinatorially equivalent are quasiconformally conjugate, and in the smooth case, we show that the restrictions of smooth, quasiregular complex box mappings to their real traces are quasisymmetrically conjugate on the real line, provided that there exists an *external* quasiconformal conjugacy between them. We will define this notion below and we will also prove a theorem that tells us when such an external conjugacy exists (see Theorem 7.1).

We say that two real-symmetric box mappings $F: \mathbf{U} \rightarrow \mathbf{V}$ and $\tilde{F}: \tilde{\mathbf{U}} \rightarrow \tilde{\mathbf{V}}$ are *strongly combinatorially equivalent* if there exist two real-symmetric homeomorphisms $H_i: \mathbf{V} \rightarrow \tilde{\mathbf{V}}$, $i = 0, 1$ such that

- $\tilde{F} \circ H_1 = H_0 \circ F$ on \mathbf{U} ;
- $H_1 = H_0$ on $\mathbf{V} \setminus \mathbf{U}$;
- $H_1 = H_0$ on $\mathcal{V} = \mathbf{V} \cap \mathbb{R}$.

Note that this implies that H_0 maps a critical point of F to a critical point of \tilde{F} of the same order (and the post-critical set of F to the post-critical set of \tilde{F}). Also note that H_1 and H_0 are homotopic relative to $\mathbf{V} \setminus \mathbf{U}$ and $\mathbf{V} \cap \mathbb{R}$. Hence we can find a sequence of real-symmetric homeomorphisms $H_n: \mathbf{V} \rightarrow \tilde{\mathbf{V}}$ with $\tilde{F} \circ H_{n+1} = H_n \circ F$. In this way, each puzzle piece \mathbf{P} of F (i.e. component of $F^{-n}(\mathbf{V})$) corresponds to a unique puzzle piece $\tilde{\mathbf{P}}$ of \tilde{F} , i.e., $H_k(\mathbf{P}) = H_n(\mathbf{P})$ is a puzzle piece of level n for \tilde{F} for each $k \geq n$.

We say that H_0 is an *external conjugacy* if

- (1) $H_0(\mathbf{V}) = \tilde{\mathbf{V}}$,
- (2) $H_0(\mathbf{U}) = \tilde{\mathbf{U}}$,
- (3) $\tilde{F} \circ H_0 = H_0 \circ F$ on $\partial\mathbf{U}$.

See Figure 16. An external conjugacy provides us with a *boundary marking* H on $\partial\mathbf{U}$ for any puzzle piece \mathbf{U} of level n through the formula $H_0 \circ F^n(z) = \tilde{F}^n \circ H(z)$ for $z \in \partial\mathbf{U}$, when there is a choice of pullback (e.g. when $F^n|_{\mathbf{U}}$ is not univalent) we choose H so that it maps points on the real line to points on the real line and preserves the order on the real line.

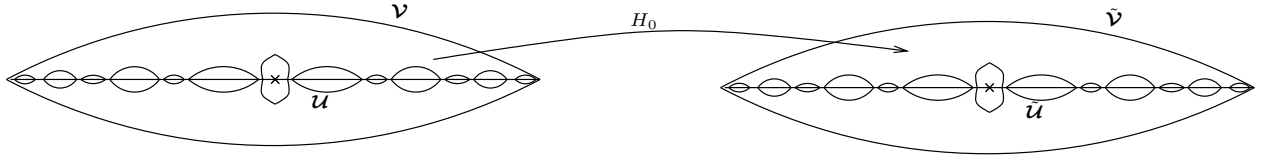

FIGURE 16. An external conjugacy. $H_0: \mathbf{V} \rightarrow \tilde{\mathbf{V}}$ is a conjugacy on the boundaries of the puzzle pieces in \mathbf{U} .

7.1. Existence of external conjugacies.

Theorem 7.1 (Conditions for the existence of a quasiconformal external conjugacy). *There exists $\theta \in (0, \pi/2)$ such that the following holds. Assume that $F: \mathcal{U} \rightarrow \mathcal{V}$ and $\tilde{F}: \tilde{\mathcal{U}} \rightarrow \tilde{\mathcal{V}}$ are complex box mappings which are non-renormalizable and strongly combinatorially equivalent that extend the real return maps to I and \tilde{I} , where I and \tilde{I} are unions of critical puzzle pieces. Moreover, assume that*

- (1) F, \tilde{F} are real-symmetric and that all components of $\mathcal{U}, \tilde{\mathcal{U}}$ intersect the real line, and that the components of $\mathcal{V}, \tilde{\mathcal{V}}$ that intersect Ω' are Poincaré discs with angle $\pi - \theta$;
- (2) there exist touching box mappings $F_T: \mathcal{U}_T \rightarrow \mathcal{V}_T$ and $\tilde{F}_T: \tilde{\mathcal{U}}_T \rightarrow \tilde{\mathcal{V}}_T$ with angle $\pi - \theta'$ satisfying the angle condition

$$\theta \in (0, \theta'/2),$$

where for any critical point c of F , $\mathcal{V}_T(c) \cap \mathbb{R} = I(c)$, and similarly for the corresponding objects associated to \tilde{F} .

- (3) $F: \mathcal{U} \rightarrow \mathcal{V}$ and $\tilde{F}: \tilde{\mathcal{U}} \rightarrow \tilde{\mathcal{V}}$ both satisfy the gap and extension properties from page 51.

Furthermore, assume that there exists a quasiconformal homeomorphism $h: \mathcal{V} \rightarrow \tilde{\mathcal{V}}$ so that

- (4) $h: \partial(\mathcal{U} \cap \mathbb{R}) \rightarrow \partial(\tilde{\mathcal{U}} \cap \mathbb{R})$ is a bijection which conjugates F and \tilde{F} on these sets;

Then there exists a quasiconformal external conjugacy H with $H(\mathcal{V}) = \tilde{\mathcal{V}}$, $H(\mathcal{U}) = \tilde{\mathcal{U}}$ and $\tilde{F} \circ H = H \circ F$ on $\partial\mathcal{U}$.

Proof. The proof of this theorem is almost the same as the one given in the first part of the proof of Theorem B' in [LvS2, page 440–442] except that we shall use the conjugacy at periodic points associated to the touching box mappings, see Theorem 6.6. In order to be complete, we will outline the proof here.

Let V be a component of \mathcal{V} .

Step 1: $A^+ := (V \setminus \mathcal{U}) \cap \mathbb{H}^+$ is a quasidisk (i.e. ∂A^+ is a quasicircle.) Here \mathbb{H}^\pm are the upper and lower half-planes. For convenience we write $U^\pm = \mathcal{U} \cap \mathbb{H}^\pm$ and $V^\pm = V \cap \mathbb{H}^\pm$. To show that A^+ is a quasicircle, we use the Ahlfors-Beurling Criterion which says a topological circle γ is a quasicircle, if there exists a constant C for any two points $z_1, z_2 \in \gamma$ there exists an arc $\gamma_{z_1, z_2} \subset \gamma$ such that $\text{diam}(\gamma_{z_1, z_2}) \leq C \text{dist}(z_1, z_2)$. To verify this condition take $z_1, z_2 \in \partial A^+$. If z_1, z_2 are both in ∂V^+ , then the Ahlfors-Beurling Criterion holds because ∂V^+ is piecewise smooth. Note that by assumption there exists a neighbourhood V' of V and for each component U_i of \mathcal{U} that intersects the orbit of a critical point has a neighbourhood U'_i which is mapped with bounded degree on a component of V' . Observe that by Lemma 3.13 we may assume that any other component of the domain is a Poincaré lens domain with angle bounded uniformly away from $\pi/2$. Hence the Ahlfors-Beurling Criterion also holds on ∂U_i^+ (with a constant which is independent of i). If z_1, z_2 are in different components $\partial U_i^+, \partial U_j^+$ of ∂U^+ , then the Ahlfors-Beurling Criterion holds uniformly.

Step 2: Let us construct a quasiconformal mapping $h: \mathcal{V} \rightarrow \tilde{\mathcal{V}}$ with $h(\mathcal{U}) = \tilde{\mathcal{U}}$. We start by noting that each $x_i \in \partial(\mathcal{U} \cap \mathbb{R})$ is mapped to some $b_i \in \partial\mathcal{V}$, and that each $b_i \in \partial\mathcal{V}$ is mapped by f^{N_0} to a periodic points a_i in the finite forward invariant set associated to the touching box map. The angle condition is satisfied, and there exist complex neighbourhoods D_i around each of these finitely many periodic points a_i and neighbourhoods W_i around each x_i so that $f^{N_0} \circ F$ maps W_i univalently onto D_i (and extends univalently onto a neighbourhood of D_i) and so that $f^{N_0} \circ F(W_i \cap U_i) \subset \mathcal{V}_T$. Of course around each $a_i \in \partial(\mathcal{V} \cap \mathbb{R})$, there exists also a

neighbourhood \mathbf{W}_i so that f^{N_0} maps \mathbf{W}_i univalently onto \mathbf{D}_i and so that $f^{N_0}(\mathbf{W}_i \cap \mathcal{V}) \subset \mathcal{V}_T$. For convenience choose \mathbf{D}_i so that $H_T(\mathbf{D}_i) = \tilde{\mathbf{D}}_i$. Now define $H: \partial\mathcal{V}^+ \rightarrow \partial\tilde{\mathcal{V}}^+$ so that $H_T \circ f^{N_0} = \tilde{f}^{N_0} \circ H$ on $\mathbf{W}_i \cap \partial\mathcal{V}^+$ where \mathbf{W}_i are the neighbourhoods of $\partial(\mathcal{V}^+ \cap \mathbb{R})$ as above. Extend this mapping on the remainder of $\partial\mathcal{V}$ by defining $H: \partial\mathcal{V} \rightarrow \partial\tilde{\mathcal{V}}$ so that it distorts arc-length by a constant factor. Next define a provisional mapping $H_0: \mathcal{V} \rightarrow \tilde{\mathcal{V}}$ which agrees with the $H: \partial\mathcal{V} \rightarrow \partial\tilde{\mathcal{V}}$ we just defined and so that $H_0(F(c)) = \tilde{F}(\tilde{c})$ for the finitely many critical points of F . Choose $H: \mathbf{U}_i \rightarrow \tilde{\mathbf{U}}_i$ so that $\tilde{F} \circ H = H_0 \circ F$, where the choices of inverses of $\tilde{F}|_{\tilde{\mathbf{U}}_i}$ are determined by the ordering on the real line. On $\partial\mathcal{U} \cap \mathbb{R}$, the mapping H is defined by the assumption of the theorem. Thus H is defined on $\partial\mathbf{A}^+$. Let ϕ be the restriction of H to $\partial\mathbf{A}^+$. Let us show ϕ is a quasisymmetric homeomorphism on this quasicircle. To do this, we need to show that for any three points $z_1, z_2, z_3 \in \partial\mathbf{A}^+$ which are roughly equidistant, $H(z_1), H(z_2), H(z_3)$ are also roughly equidistant. If z_i are all in some set \mathbf{W}_j as above, then using that $f^{N_0} \circ F|_{\mathbf{W}_i}$ is univalent, by the Koebe Distortion Theorem, we get that $y_i := f^{N_0} \circ F(z_i)$, $i = 1, 2, 3$ are also roughly equidistant. Since H_T is quasiconformal, this implies that $H(z_i) = (\tilde{f}^{N_0} \circ \tilde{F})^{-1} \circ H_T(y_i)$ are also all equidistant. If z_i are not all in some set \mathbf{W}_j as above, then we argue exactly as in case (b) in [LvS2, page 442].

Step 3: It follows that there exists a quasiconformal map $H: \mathbf{A}^+ \rightarrow \tilde{\mathbf{A}}^+$ (and similarly a quasiconformal mapping $H: \mathbf{A}^- \rightarrow \tilde{\mathbf{A}}^-$.) Since we already defined a quasiconformal map $H: \mathbf{U}_i \rightarrow \tilde{\mathbf{U}}_i$ we obtain the required quasiconformal mapping $H: \mathcal{V} \rightarrow \tilde{\mathcal{V}}$. \square

7.2. Rigidity of non-renormalizable analytic complex box mappings.

Proposition 7.2 (The Spreading Principle (Analytic Version)[KSvS1] page 769). *Suppose that $F: \mathcal{U} \rightarrow \mathcal{V}$ and $\tilde{F}: \tilde{\mathcal{U}} \rightarrow \tilde{\mathcal{V}}$ are strongly combinatorially equivalent holomorphic box mappings. Suppose that $h: \mathbb{C} \rightarrow \mathbb{C}$ is a K -qc external mapping for F and \tilde{F} . Let $\mathcal{O} \supset \text{Crit}(F)$ be a nice open set consisting of puzzle pieces. Let $\phi: \mathcal{O} \rightarrow \tilde{\mathcal{O}}$ be a K -qc mapping that respects the boundary marking on each component of \mathcal{O} . Then there exists a K -qc mapping $\Phi: \mathcal{V} \rightarrow \tilde{\mathcal{V}}$ such that the following hold:*

- $\Phi = \phi$ on \mathcal{O} ;
- for each $z \in \mathcal{V} \setminus \mathcal{O}$,

$$\tilde{F} \circ \Phi(z) = \Phi \circ F(z);$$

- $|\bar{\partial}\Phi| < k$ on $\mathcal{V} \setminus \text{Dom}(\mathcal{O})$, where k satisfies $K = \frac{1+k}{1-k}$;
- for each puzzle piece \mathbf{P} which is not contained in $\text{Dom}(\mathcal{O})$, $\Phi(\mathbf{P}) = \tilde{\mathbf{P}}$ and $\Phi: \mathbf{P} \rightarrow \tilde{\mathbf{P}}$ respects the boundary marking.

Theorem 7.3 (QC rigidity of combinatorially equivalent complex box mappings). *Suppose that $F: \mathcal{U} \rightarrow \mathcal{V}$ and $\tilde{F}: \tilde{\mathcal{U}} \rightarrow \tilde{\mathcal{V}}$ are corresponding complex box mappings given by either Theorem 5.2 or Theorem 5.3. In particular assume that they satisfy conditions 1, 2 and 3 of Theorem 7.1. Assume further that F and \tilde{F} are strongly combinatorially equivalent via homeomorphisms H_0 and H_1 , where H_0 is a quasiconformal external conjugacy. Then $F|_{\mathcal{U} \cap \mathbb{R}}$ and $\tilde{F}|_{\tilde{\mathcal{U}} \cap \mathbb{R}}$ are quasisymmetrically conjugate; that is, there exists a qs mapping $H: \mathcal{U} \rightarrow \tilde{\mathcal{U}}$ such that $H \circ F = \tilde{F} \circ H$ on \mathcal{U} and in particular, H maps critical points of F to critical points of \tilde{F} and $H(F^i(c)) = \tilde{F}^i(H(c))$.*

Proof. This theorem is proved Lemma 6.6 and 6.7 and Section 6.4 of [KSvS1]. Lemma 6.6 and 6.7 show that there exist $\delta > 0$ and arbitrarily small critical puzzle pieces \mathbf{U} which have δ -bounded geometry and so that first the first landing map to \mathbf{U} extends to a definite neighbourhood of \mathbf{U} , so that \mathbf{U} is δ -nice. Lemma 6.6 deals with the case that F is reluctantly recurrent and Lemma 6.7 deals with the persistently recurrent case. The proof of this lemma relies on Theorem 5.1. One then uses the Spreading Principle, as in In Section 6.4 of [KSvS1], to complete the proof of the theorem. \square

Remark 7.1. In Section 8, we will show that the conditions of Theorem 7.1 are satisfied for these complex box mappings.

We will now develop the tools that we will need to deal with smooth mappings. Quasisymmetric rigidity for smooth complex box mappings is proved in Theorem 7.8.

7.3. Restricting the puzzle to control dilatation. Let us give some terminology. Suppose that $F: \mathbf{U} \rightarrow \mathbf{V}$ is a complex box mapping. For $n \in \mathbb{N} \cup \{0\}$, the *Yoccoz puzzle pieces of level n* , denoted by \mathcal{Y}^n is the set of connected components of $F^{-n}(\mathbf{V})$ and \mathbf{P} is a puzzle piece if \mathbf{P} a component of \mathcal{Y}^n for some n . The *Yoccoz puzzle* is the set of all puzzle pieces. In this subsection we will define a sub-puzzle \mathcal{M} of \mathcal{Y} . Roughly, we construct it from the Yoccoz puzzle by excluding from the Yoccoz puzzle all puzzle pieces that are critical puzzle pieces that are deep in long cascades of central returns or that are complex puzzle pieces that do not intersect the real line and are obtained as a “complex” pullback of such a puzzle piece through a long central cascade, and we do not refine puzzle pieces that do not intersect the real line. We will refer to this nest as the *modified Yoccoz puzzle*. The modified Yoccoz puzzle does not give a partition of \mathbf{U} in the same way as some \mathcal{Y}^n ; it has “holes” off the real line when there is a long cascade of central returns, see Figure 17. An important step in the proof of rigidity of complex box mappings is filling in these holes. This is done in Theorem 7.5. Let us be more precise.

Let b denote the number of critical points of F . Fix $N_0 \geq 12b^2 - 4b$ (notice that $N_0 \geq 8$). We will call central cascades of length longer than N_0 *long*. Suppose that $\mathbf{U} \ni c, c \in \text{Crit}(F)$, is a critical puzzle piece. Assume that $k \in \mathbb{N}$ is such that $\mathcal{C}_c^{k+1}(\mathbf{Y}_c^0) \subset \mathbf{U} \subsetneq \mathcal{C}_c^k(\mathbf{Y}_c^0)$. Let $\mathbf{Z}^0 = \mathcal{C}_c^k(\mathbf{Y}_c^0)$, and let

$$\mathbf{Z}^0 \supset \mathbf{Z}^1 \supset \mathbf{Z}^2 \supset \dots$$

be the principal nest about c . We will say that \mathbf{U} is *deep in a central cascade* if $\mathbf{U} \subset \mathbf{Z}^{N_0}$, and the return time of c to \mathbf{U} is the same as its return time to \mathbf{Z}^0 . It is easy to see that when we exclude puzzle pieces that are deep in a sufficiently long central cascade, we do not exclude puzzle pieces from the enhanced nest, any enhanced nest over a central cascade or from the good nest, from the modified puzzle: Provided that $N_0 \geq 12b^2 - 4b$, any puzzle piece \mathbf{I} in the enhanced nest has the property that if $\{\mathbf{U}_i\}_{i=0}^s$ is the chain of puzzle pieces with $\mathbf{U}_0 = \mathbf{I}$ and $\mathbf{U}_s = \mathbf{V}$, a component of \mathbf{V} , then no critical puzzle piece \mathbf{U}_i is deep in a central cascade. This follows immediately from the fact that the mapping $F^{p_i}: \mathbf{I}_{i+1} \rightarrow \mathbf{I}_i$ between two puzzle pieces in the enhanced nest has bounded degree, see [KSvS1], Section 8, and similarly for the puzzle pieces in the enhanced nest over a long central cascade and for puzzle pieces in the good nest.

Let \mathcal{M}^0 be the components of \mathcal{Y} . These are the puzzle pieces of level 0 in the modified Yoccoz puzzle. Assuming that \mathcal{M}^{n-1} is defined, let $\widehat{\mathcal{M}}^n$ denote the collection of all puzzle pieces $(F|_{\mathbf{P}'})^{-1}(\mathbf{P})$, for $\mathbf{P} \in \mathcal{M}^{n-1}$ and $\mathbf{P}' \in \mathcal{M}^{n-1}$, with $\mathbf{P}' \cap \mathbb{R} \neq \emptyset$. We have that either

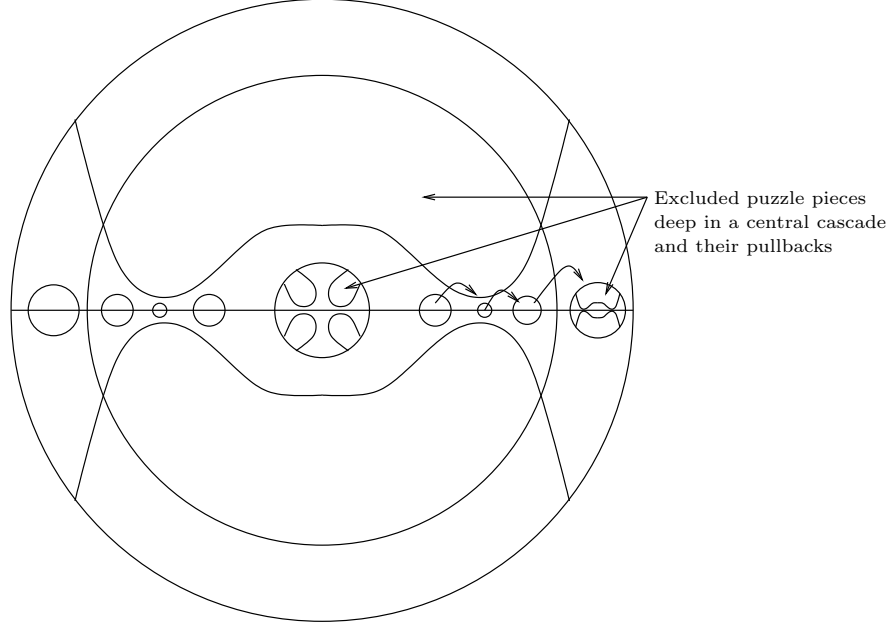

FIGURE 17. Exclude puzzle pieces that pass through long central cascades, and their pullbacks from the Yoccoz puzzle.

- $F^{-1}(\mathbf{P})$ intersects the real line ($\widehat{\mathcal{M}}^n$ contains all real puzzle pieces) or
- $F^{-1}(\mathbf{P})$ is not properly contained in a connected component of some \mathcal{M}^i , $0 \leq i \leq n - 1$ which does not intersect the real line ($\widehat{\mathcal{M}}^n$ contains all largest puzzle pieces that do not intersect the real line).

Now we remove certain puzzle pieces which pass through long cascades of central returns from $\widehat{\mathcal{M}}^n$. We let \mathcal{M}^n denote the set of all puzzle pieces U in $\widehat{\mathcal{M}}^n$ such that one of the following holds:

- (1) If U is a critical puzzle piece, U is not deep in central cascade (we exclude real puzzle pieces that are deep in central cascades).
- (2) If U is a largest complex puzzle piece, then $U \in \mathcal{M}^n$ if one of the following holds:
 - (a) The smallest puzzle piece in the (full) puzzle \mathcal{Y} that intersects the real line and that contains U is not deep in a central cascade.
 - (b) The smallest puzzle piece in the (full) puzzle \mathcal{Y} that intersects the real line and that contains U is deep in a central cascade,

$$V^0 \supset V^1 \supset V^2 \supset \dots \supset V^N \supset V^{N+1},$$

and if $1 \leq i \leq N$ is such that $U \subset V^i \setminus V^{i+1}$, then U intersects a component of $(V^i \setminus V^{i+1}) \setminus R_{V^0}^{-i}(V^0 \setminus V^1)$, which intersects the real line.

(We exclude complex puzzle pieces that are pullbacks of puzzle pieces through a long cascade of central returns, unless these pullbacks are along real branches of the return map.)

Let \mathcal{M} denote the collection of all puzzle pieces U , such that $U \in \mathcal{M}^n$ for some n .

Proposition 7.4. *There exists $C > 0$ such that for any $n \geq 0$, if $\mathbf{U}_0 \in \mathcal{M}^n$ then*

$$\sum_{i=0}^n \left(\text{dist}(F^i(\mathbf{U}_0), \mathbb{R}) + \text{diam}(F^i(\mathbf{U}_0)) \right)^2 < C \cdot \mu(\mathcal{V})^{1/3}.$$

Proof. Let $\mathbf{U}_i = F^i(\mathbf{U}_n)$ for $i = 0, \dots, n$. We decompose the chain $\{\mathbf{U}_i\}_{i=0}^n$ into pieces in a similar way as in the proof of Lemma 5.16. If \mathbf{U}_0 is a puzzle piece that intersects the real line, then this follows from Lemma 5.16. So we can suppose that \mathbf{U}_0 does not intersect the real line. Let $m > 0$ be minimal so that \mathbf{U}_{m+1} is a real puzzle piece. Then the puzzle pieces $\mathbf{U}_0, \dots, \mathbf{U}_m$ are all largest complex puzzle pieces, moreover for each of these puzzle pieces either condition 2(a) or 2(b) holds, see page 91. If condition 2(a) holds for \mathbf{U}_m , Let $\hat{\mathbf{U}}_m$ be the smallest real puzzle in $\cup_{i=0}^{n-m} \mathcal{M}^i$ that contains \mathbf{U}_m . Suppose first that condition 2(a) holds for \mathbf{U}_m . If for all $0 \leq i \leq m$ condition 2(a) holds for \mathbf{U}_i , let $\hat{\mathbf{U}}_i = \text{Comp}_{\mathbf{U}_i} F^{-(m-i)}(\hat{\mathbf{U}}_m)$. Observe that since $\mathbf{U}_{m-1} \subset \hat{\mathbf{U}}_{m-1}$ we must have that $\hat{\mathbf{U}}_{m-1}$ intersects the real line, for if not, then since $\hat{\mathbf{U}}_{m-1}$ does not intersect the real line, $\mathbf{U}_{m-1} \notin \mathcal{M}$, which is a contradiction. Moreover, if $\hat{\mathbf{U}}_{m-1}$ is deep in a central cascade (and condition 2(b) on page 91 does not hold), \mathbf{U}_{m-1} would have been excluded from $\mathcal{M}^{n-(m-1)}$, and \mathbf{U}_0 could not be in \mathcal{M}^n . Thus we have that $\hat{\mathbf{U}}_{m-1}$ is a puzzle piece in the modified Yoccoz puzzle. Arguing inductively, we have that $\hat{\mathbf{U}}_0$ is a real puzzle piece in the modified Yoccoz puzzle, so

$$\sum_{i=0}^n \left(\text{dist}(F^i(\mathbf{U}_0), \mathbb{R}) + \text{diam}(F^i(\mathbf{U}_0)) \right)^2 \leq \sum_{i=0}^m \text{diam}(F^i(\hat{\mathbf{U}}_0))^2 + \sum_{i=m+1}^n \text{diam}(F^i(\mathbf{U}_{m+1}))^2,$$

which is bounded as required by Lemma 5.16.

So let $k_0 \leq m$ be maximal so that condition 2(b) holds for \mathbf{U}_{k_0} , and let $\hat{\mathbf{U}}_{k_0}$ be the component of $(\mathbf{V}^i \setminus \mathbf{V}^{i+1}) \setminus R_{\mathbf{V}^0}^{-i}(V^0 \setminus V^1)$ that intersects \mathbf{U}_{k_0} . Let j be so that $R_{\mathbf{V}^0}|_{\mathbf{V}^1} = F^j|_{\mathbf{V}^1}$, and let l_0 be maximal so that $\mathbf{U}_{k_0-l_0j} \in \mathbf{V}^{l_0} \setminus \mathbf{V}^{l_0+1}$. Then there exists a constant $C > 0$ such that $\sum_{k=k_0-l_0j}^{k_0} \text{diam}(\mathbf{U}_k)^2 \leq C \text{diam}(\mathbf{V}^0)$. Since the diameters of the puzzle pieces at the tops of long central cascades decays exponentially, Proposition 5.13, we can control the sum of the squares of the diameters of the subsequences of $\{\mathbf{U}_i\}_{i=0}^m$ which pass through central cascades. For the segments of the orbits that are not pullbacks through long cascades of central returns condition 2(a) holds, and we argue as in the first case until the next central cascade. \square

7.4. Statement of the QC\BG Partition of a Central Cascade. Let us describe a theorem that we will use when there are no long central cascades. If there are no long central cascades, then this theorem is not required. Let $N_0 \in \mathbb{N}$ be the lower bound on the length of a long central cascade. We will assume that $N_0 \geq 12b^2 - 4b$. Suppose that c is a recurrent critical point of $F: \mathcal{U} \rightarrow \mathcal{V}$. Fix a critical point $c_0 \in \omega(c)$ chosen so that c_0 has even order if there exists a critical point of even order in $\omega(c)$ and let \mathbf{I}^0 be the component of \mathcal{V} that contains c_0 . For each $k \in \mathbb{N}$, such that $\hat{\mathcal{C}}_{c_0}^k(\mathbf{I}^0)$ is the first puzzle piece in a maximal central cascade of length $N \geq N_0$, let $\mathcal{G}_{c_0}(k)$, denote the δ -excellent puzzle piece given by Proposition 5.13. Recall that $\mathcal{G}_{c_0}(k)$ is a $(1 + 1/\delta)$ -quasidisk.

Definition 7.1. Suppose that I is a real puzzle piece. A *necklace neighbourhood* of I is a countable union of pairwise disjoint open sets $\mathbf{U}_i \subset \mathbb{C}$ such that $I = \overline{\cup \mathbf{U}_i}$.

Recall the definition of a (K, δ) -qc\bg mapping from page 23. We will say that a mapping $H: \Omega \rightarrow \tilde{\Omega}$ is (K, δ) -qc\bg in the upper half-plane if it is (K, δ) -qc\bg, and the following holds: Let X_1 and \tilde{X}_1 be the subsets of Ω and $\tilde{\Omega}$ given in the definition of a (K, δ) -qc\bg mapping. We require additionally that each component \mathbf{P} of X_1 that is contained in \mathbb{H}^+ additionally satisfies

$$\text{mod}(\Omega \cap \mathbb{H}^+ \setminus \mathbf{P}) \geq \delta \text{ and, } \text{mod}(\tilde{\Omega} \cap \mathbb{H}^+ \setminus \tilde{\mathbf{P}}) \geq \delta.$$

We will refer to this property as H having *moduli bounds in the upper half-plane*.

Let us assume the following proposition, which we prove in the Section 7.6. It is one of the key ingredients for proving rigidity of smooth mappings. It is designed to be applied with the QC Criterion in the upper half-plane to show that there is a quasiconformal mapping with the same values on the real line. It can be thought of as a Carleson Box construction of a quasiconformal mapping, but where rather than controlling the dilatation on every box, we only control the dilatation on a subset, and prove that the complementary set satisfies certain geometric bounds. Recall that $\mu(\mathbf{J}^0) = \max_{U \subset \text{Dom}'(\mathbf{J}^0)} \text{diam}(U)$, where the maximum is taken over connected components U of $\text{Dom}'(U)$.

Theorem 7.5 (QC\BG Partition of a Central Cascade). *There exist $K_0, \hat{K} \geq 1, \delta_0, C > 0$ such that for any $K \geq 1, \delta > 0, c \in \text{Crit}(F)$ and $k \in \mathbb{N}$ with the property that $\hat{C}_c^k(\mathbf{I}_c^0)$ is the first puzzle piece in a maximal central cascade of length $N \geq N_0$ the following holds: Let $\mathbf{J}^0 = \mathcal{G}_{c_0}(k)$ and let $\tilde{\mathbf{J}}^0$ be the corresponding puzzle piece for \tilde{F} . Let $R: \mathbf{J}^1 \rightarrow \mathbf{J}^0$ be the first return mapping of \mathbf{J}^1 to \mathbf{J}^0 and $\tilde{R}: \tilde{\mathbf{J}}^1 \rightarrow \tilde{\mathbf{J}}^0$ be the first return mapping of $\tilde{\mathbf{J}}^1$ to $\tilde{\mathbf{J}}^0$. Assume that $H_0: \mathbf{J}^0 \rightarrow \tilde{\mathbf{J}}^0$ is a (K, δ) -qc\bg mapping which respects the boundary markings on $\partial \mathbf{J}^0$ and $\partial \tilde{\mathbf{J}}^0$. Then there exists a (K', δ') -qc\bg mapping $H: \mathbf{J}^0 \rightarrow \tilde{\mathbf{J}}^0$ with the following properties:*

- $K' = \max\{\hat{K}, K(1 + C\mu(\mathbf{J}^0))(1 + C\mu(\tilde{\mathbf{J}}^0))\}$,
- $\delta' = \min\{\delta_0, \delta(1 + C\mu(\mathbf{J}^0))^{-1}, \delta(1 + C\mu(\tilde{\mathbf{J}}^0))^{-1}\}$,
- *there exists a partition of \mathbf{J}^0 into sets disjoint sets X_0, X_1, X_2 and X_3 , and similarly for the objects marked with a tilde,*

such that:

- (1) For $i = 0, 1, 2, 3$, $H(X_i) = \tilde{X}_i$.
- (2) The set X_0 has measure zero and H satisfies (2.1) at each $x \in X_0$.
- (3) The set X_1 and the corresponding set \tilde{X}_1 are union of pairwise disjoint topological disks Y , respectively $\tilde{Y} = H(Y)$, with δ' -bounded geometry and if Y and \tilde{Y} are contained in the upper half-plane

$$\text{mod}(\mathbf{J}^0 \cap \mathbb{H}^+ \setminus Y) \geq \delta' \text{ and, } \text{mod}(\tilde{\mathbf{J}}^0 \cap \mathbb{H}^+ \setminus \tilde{Y}) \geq \delta'.$$

- (4) The set X_2 contains a necklace neighbourhood of the real line and $\mathbf{J}^0 \setminus \mathbf{J}^3$. For any puzzle piece $\mathbf{P} \subset X_2$ for F and for each $z \in \partial \mathbf{P}$ we have $H \circ R(z) = \tilde{R} \circ H(z)$.
- (5) The set X_3 and \tilde{X}_3 are K_1 -quasidisks that are disjoint from the set of puzzle pieces that intersect the real line and $H|_{X_3}$ is \hat{K} -quasiconformal.

We define $\mathcal{N}_c(k) = X_2$.

This will be proved in Section 7.6.

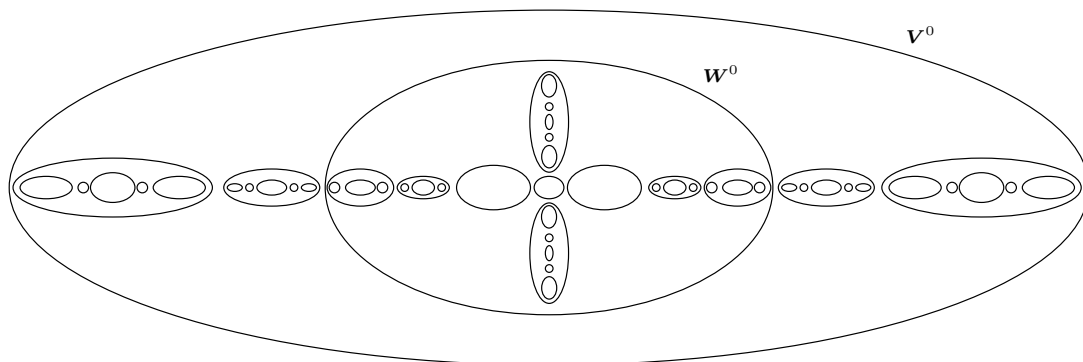

FIGURE 18. The puzzle pieces \mathbf{V}^0 and \mathbf{W}^0 together with some pullbacks. The pullbacks of components of $\text{Dom}(\mathbf{V}^0)$ which do not intersect the real line do not necessarily have moduli bounds in \mathbb{H}^+ . However, such pullbacks of $\text{Dom}'(\mathbf{W}^0)$ do, since $\text{mod}(\mathbf{V}^0 \setminus \mathbf{W}^0)$ is bounded away from zero. The same is true on deeper levels.

Remark 7.2. The definition of a qc\bg partition consists of three sets: a set of measure zero, a set with bounded geometry and a set where the dilatation is bounded. However, in the QC\BG Partition of a Central Cascade, the partition consists of four sets. The sets X_2 , where the mapping H is defined dynamically, and X_3 , which can be decomposed into quasidisks, are both included in the set where the dilatation is bounded.

7.5. A Real Spreading Principle. Let us use Theorem 7.5 to prove a spreading principle.

Proposition 7.6 (A Real Spreading Principle). *There exists $\delta_0 > 0$ and for any $K \geq 1$ there exists $K_0 \geq 1$ such that the following holds. Assume that $F: \mathcal{U} \rightarrow \mathcal{V}, \tilde{F}: \tilde{\mathcal{U}} \rightarrow \tilde{\mathcal{V}}$, are complex box mappings which satisfy the conditions of Theorem 7.1, and let $H_0: \mathbb{C} \rightarrow \mathbb{C}$ be a K -qc external conjugacy between F and \tilde{F} . Then there exist arbitrarily small nice open complex neighbourhoods \mathcal{O} of $\text{Crit}(F)$ consisting of puzzle pieces in \mathcal{M} and a mapping $H_{\mathcal{O}}: \mathbb{C} \rightarrow \mathbb{C}$ such that*

- $H_{\mathcal{O}}(\mathcal{O}) = \tilde{\mathcal{O}}$;
- $H_{\mathcal{O}}$ agrees with the boundary marking on $\partial\mathcal{O}$;
- $H_{\mathcal{O}}(\text{Dom}'(\mathcal{O})) = \text{Dom}'(\tilde{\mathcal{O}})$;
- for each component \mathbf{U} of $\text{Dom}'(\mathcal{O})$, $H_{\mathcal{O}} \circ F(z) = \tilde{F} \circ H_{\mathcal{O}}(z)$ for $z \in \partial\mathbf{U}$.

Moreover, $H_{\mathcal{O}}: \mathbb{H}^+ \rightarrow \mathbb{H}^+$ is a (K_0, δ_0) -qc\bg mapping.

Proof. Before we give the details of the proof, let us explain our strategy. We start with a K -qc external conjugacy $H_0: \mathbb{C} \rightarrow \mathbb{C}$ between $F: \mathcal{U} \rightarrow \mathcal{V}$ and $\tilde{F}: \tilde{\mathcal{U}} \rightarrow \tilde{\mathcal{V}}$. We are going to pull H_0 back by F and \tilde{F} . We only pull H_0 back along branches of F which intersect the real line, see Figure 18. It is impossible for us to control the dilatation of high iterates of F along complex branches of F , and this is one reason why we cannot repeat the proof of the usual Spreading Principle. In Step 1, we pullback to obtain a mapping that is a *conjugacy up to the first landing time to \mathbf{W}^0* ; that is, we will show that there exists a qc mapping ψ_0 of the plane, so that for any $z \in \text{Dom}'(\mathbf{W}^0)$, if $s_z \geq 0$ is minimal so that $F^{s_z}(z) \in \mathbf{W}^0$, we have that $\psi_0 \circ F^{s_z}(z) = \tilde{F}^{s_z} \circ \psi_0(z)$. In this step we are only pulling back through diffeomorphic branches of $R_{\mathbf{V}^0}(= F)$. The next pullback has a critical point, and in order to pull H_0 back we need to modify it so that it maps critical values of F to critical values of \tilde{F} . This is done

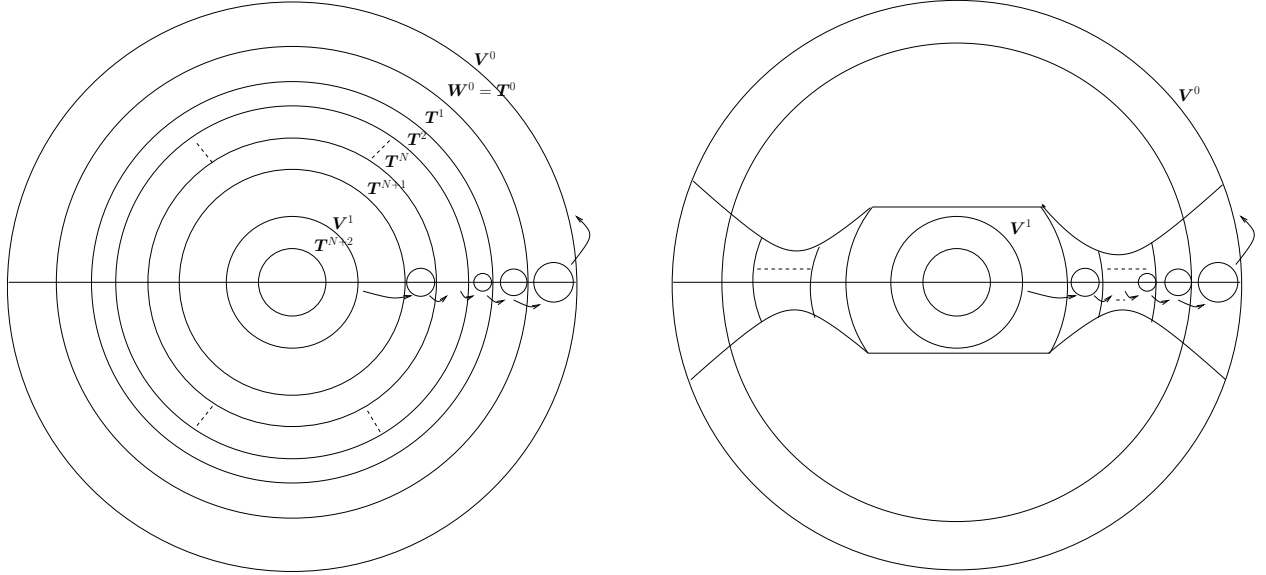

FIGURE 19. Applying Theorem 7.5

in Step 2. We do not control the dilatation of the new mapping, but we only modify it in components of $\text{Dom}(\mathbf{W}^0)$ which contain critical values of $R_{\mathbf{V}^0}$. These puzzle pieces have bounded geometry. In Step 3, we use Steps 1 and 2 to go down to the next level of the good nest. Figure 19 shows how the domains are nested. The mapping that we obtain in this step is not quite a (K_0, δ_0) -qc mapping on the upper half-plane, since some of the puzzle pieces where the dilatation is unbounded may not be well-inside the complex plane. We rectify this by refining the mapping in these domains, see Figure 4. These puzzle pieces are components of $F^{-1}(F|_{\mathbf{W}^0})^{-1}(\text{Dom}'(\mathbf{W}^0))$. Using the fact that the components of $(F|_{\mathbf{W}^0})^{-1}(\text{Dom}'(\mathbf{W}^0))$, are well-inside of \mathbf{W}^0 , after we pullback the mapping from \mathbf{W}^0 to $\widetilde{\mathbf{W}}^0$ defined in Step 3 to these components of $F^{-1}(F|_{\mathbf{W}^0})^{-1}(\text{Dom}'(\mathbf{W}^0))$, which are mapped diffeomorphically onto components of \mathbf{W}^0 , we obtain a (K_0, δ_0) -qc mapping. This is done in Step 4. In Step 5, we explain how to continue the proof inductively to obtain a mapping H_n which conjugates the dynamics of F and \tilde{F} up to their first entry times to \mathbf{W}^n . We use the QC Criterion to obtain a K_2 -qc mapping from \mathbf{W}^n to $\widetilde{\mathbf{W}}^n$ which agrees with the boundary marking. If there were no long central cascades, we would have that H_n is a (K_0, δ_0) -qc mapping on the upper half-plane. Long central cascades are dealt with in Step 6, where we replace the mapping that we define by pulling back in Steps 1–5, with the geometrically defined mapping in the QC\BG Partition of a Central Cascade, given by Theorem 7.5, see Figure 19.

Let us first give the proof of this result when there are no long central cascades.

Let $H_0: \mathbb{C} \rightarrow \mathbb{C}$ be an external mapping, so that $H_0(\mathbf{V}) = \tilde{\mathbf{V}}$, $H_0(\mathbf{U}) = \tilde{\mathbf{U}}$, and for $z \in \partial\mathbf{U}$, $H_0 \circ F(z) = \tilde{F} \circ H_0(z)$. For $c \in \text{Crit}(F)$, let $\mathbf{V}_c^0 = \text{Comp}_c \mathbf{V}$, and $\mathbf{V}^0 = \cup_{c \in \text{Crit}(F)} \mathbf{V}_c^0$. Let

$$\mathbf{V}^0 \supset \mathbf{W}^0 \supset \mathbf{V}^1 \supset \mathbf{W}^1 \supset \dots$$

be the good nest of puzzle pieces, see Section 5.5. Notice that $\mathbf{W}^0 = \cup_{c \in \text{Crit}(F)} \text{Comp}_c(\mathbf{U})$. Recall that by Corollary 5.19 and by Proposition 5.22, we have that there exists $\delta > 0$ such that for all n \mathbf{W}^n is δ -nice and each component of $\text{Dom}(\mathbf{W}^n)$ has δ -bounded geometry. We will use these properties to apply the QC Criterion. Let us show how to pull H_0 back through this nest of puzzle pieces. See Figure 18

Step 1: Refine H_0 so that it is a conjugacy up to the first landing to \mathbf{W}^0 . For each z in $\text{Dom}(\mathbf{V}^0)$ (the domain of the first entry mapping to \mathbf{V}^0), let $s_z \geq 0$ be minimal so that $F^{s_z}(z) \in \mathbf{W}^0 \cup (\mathbf{V}^0 \setminus \text{Dom}'(\mathbf{W}^0))$, where we set $s_z = \infty$ if the orbit of z is contained in $\text{Dom}(\mathbf{V}^0)$, but avoids \mathbf{W}^0 . The set of points for which $s_z = \infty$ is a hyperbolic Cantor set of measure zero, and so it is removable. For each z for which s_z is finite, we define $\psi_0(z)$ by the formula:

$$H_0 \circ F^{s_z}(z) = \tilde{F}^{s_z} \circ \psi_0(z).$$

Observe that ψ_0 is well-defined since the mapping $F^{s_z}: \hat{\mathcal{L}}_z(\mathbf{W}^0) \rightarrow \mathbf{W}^0$ is a diffeomorphism onto its image, a component of \mathbf{W}^0 . For $z \in \mathbb{C} \setminus \text{Dom}(\mathbf{V}^0)$, we set $\psi_0(z) = H_0(z)$. Thus, by the complex bounds we have that there exists a constant $C > 0$ so that if H_0 is K -qc, then ψ_0 is a $K(1 + C\mu(\mathbf{V}^0))(1 + C\mu(\tilde{\mathbf{V}}^0))$ -qc mapping of the plane.

Step 2. Moving the critical values and pulling back. Since F and \tilde{F} are topologically conjugate, for each critical point c of F , $\psi_0(\hat{\mathcal{L}}_{F(c)}(\mathbf{W}^0)) = \hat{\mathcal{L}}_{\tilde{F}(\tilde{c})}(\tilde{\mathbf{W}}^0)$. For each component $\hat{\mathcal{L}}_{F(c)}(\mathbf{W}^0)$, with $c \in \text{Crit}(F)$, let $\phi_c: \mathbb{C} \rightarrow \mathbb{C}$ be a quasiconformal mapping which is the identity on $\mathbb{C} \setminus \hat{\mathcal{L}}_{\tilde{F}(\tilde{c})}(\tilde{\mathbf{W}}^0)$, and such that for each critical value $F(c') \in \hat{\mathcal{L}}_{F(c)}(\mathbf{W}^0)$, we have that $\phi_c \circ \psi_0(F(c')) = \tilde{F}(\tilde{c}')$. Let $\phi = \phi_{c_1} \circ \dots \circ \phi_{c_k}$, where $\{c_1, \dots, c_k\} \subset \text{Crit}(F)$ is such that each component of $\text{Dom}'(\mathbf{W}^0)$ that intersects $F(\text{Crit}(F))$ contains exactly one of the critical values $F(c_i)$. Then $\phi \circ \psi_0$ may have big quasiconformal distortion. However, it still has quasiconformal distortion bounded by $K(1 + C\mu(\mathbf{V}^0))(1 + C\mu(\tilde{\mathbf{V}}^0))$ on $\mathbb{C} \setminus \cup_{i=1}^k \hat{\mathcal{L}}_{F(c_i)}(\mathbf{W}^0)$. We define ψ_1 on \mathbf{W}^0 by the formula

$$\phi \circ \psi_0 \circ F(z) = \tilde{F} \circ \psi_1(z).$$

For $z \in \mathbb{C} \setminus \mathbf{W}^0$, we set $\psi_1(z) = \psi_0(z)$. The mapping ψ_1 is a $K(1 + C\mu(\mathbf{V}^0))^2(1 + C\mu(\tilde{\mathbf{V}}^0))^2$ -qc mapping outside of $(\text{Dom}'(\mathbf{W}^0) \setminus \mathbf{W}^0) \cup (F|_{\mathbf{W}^0})^{-1}(\text{Dom}'(\mathbf{W}^0)) \supset \text{Dom}^*(\mathbf{W}^0)$.

Remark 7.3. Observe that since F has critical points, some components of $F^{-1}(\text{Dom}'(\mathbf{W}^0))$ may not intersect the real line, and while they have bounded geometry, they do not necessarily have moduli bounds in the upper half-plane, see Figure 18. We will deal with this in Step 4.

Let us consider the following multicritical variant of the principal nest of puzzle pieces: Let $\mathbf{T}^0 = \mathbf{W}^0$, and for each critical point c , let $\mathbf{T}_c^{i+1} = \mathcal{L}_c(\mathbf{T}^i)$, and set $\mathbf{T}^{i+1} = \cup_{c \in \text{Crit}(F)} \mathbf{T}_c^{i+1}$. For each critical point c such that $F(c) \in \mathbf{T}^0$, let $N_c \geq 0$ be minimal so that $F(c) \in \mathbf{T}^{N_c} \setminus \mathbf{T}^{N_c+1}$. Let $N = \max_{c \in \text{Crit}(F)} N_c$.

Step 3: A qc conjugacy up to the first return to \mathbf{V}^1 . We will show that there exist $K_1 \geq 1$, given by Proposition 7.4, and a qc mapping $\Psi_1: \mathbb{C} \rightarrow \mathbb{C}$ such that $\Psi_1(\mathbf{V}^1) = \tilde{\mathbf{V}}^1$, $\Psi_1(\text{Dom}(\mathbf{V}^1)) = \text{Dom}(\tilde{\mathbf{V}}^1)$, and for each component \mathbf{U} of $\text{Dom}(\mathbf{V}^1)$, if $z \in \partial\mathbf{U}$, $\Psi_1 \circ F(z) = \tilde{F} \circ \Psi_1(z)$. Moreover, Ψ_1 is K_1 -qc outside $\text{Dom}(\mathbf{V}^1) \cup \mathbf{X}^1$, where $\mathbf{X}^1 \subset \mathbb{C} \setminus \mathbb{R}$.

Remark 7.4. We will give an explicit description of \mathbf{X}^1 . For now, let us just point out that it consists of certain pullbacks of landing domains which do not intersect the real line.

We have that ψ_1 conjugates the dynamics of F and \tilde{F} up to the first entry of each point to \mathbf{W}^0 . Suppose that c is a critical point of F with the property that $F(c) \in \mathbf{V}^0 \setminus \mathbf{W}^0$. Then $\mathcal{L}_c(\mathbf{W}^0) \subset \mathbf{V}_c^1 \subset \mathbf{W}_c^0$. Since ϕ is the identity outside $\cup_{i=1}^k \hat{\mathcal{L}}_{\tilde{F}(\tilde{c}_i)}(\tilde{\mathbf{W}}^0)$, we have that

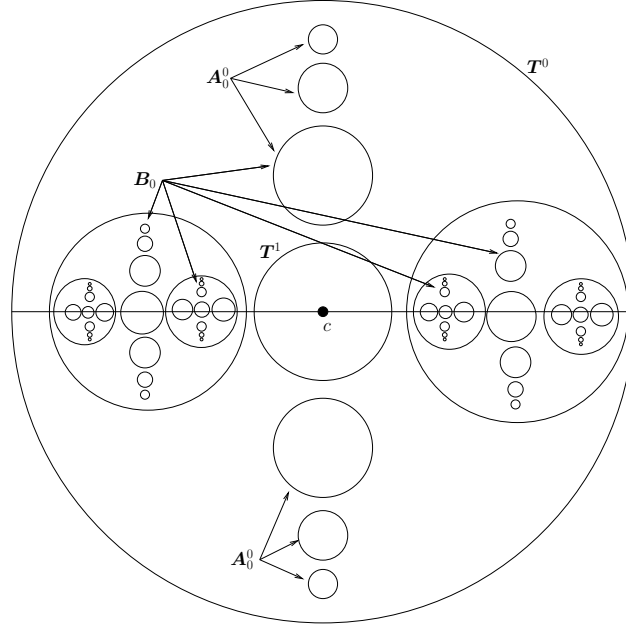

FIGURE 20. Complex pullbacks of landing domains.

$\psi_1(\mathbf{V}_c^1) = \tilde{\mathbf{V}}_{\tilde{c}}^1$. However, if $F(c) \in \mathbf{W}^0$, then this need not be the case. To obtain this, we will pullback through the nest

$$\mathbf{T}^0 \supset \mathbf{T}^1 \supset \mathbf{T}^2 \supset \dots$$

To simplify the notation, we will do more (that is, pull back further) than we strictly need to at certain critical points, but this will not cause problems for us.

Let $\phi_0 = \psi_1$. As in Step 1, refine ϕ_0 so that it is a conjugacy up to the first landing to \mathbf{T}^1 : for each $z \in \text{Dom}(\mathbf{T}^0)$, let $s_z > 0$ be minimal so that $F^{s_z}(z) \in \mathbf{T}^1 \cup (\mathbf{T}^0 \setminus \text{Dom}(\mathbf{T}^0))$, and for $z \in \text{Dom}(\mathbf{T}^0)$ define $\phi'_0(z)$ so that

$$\tilde{F}^{s_z} \circ \phi'_0(z) = \phi_0 \circ F^{s_z}(z).$$

As before s_z is finite except at a set of points which is conformally removable.

Let

$$\mathbf{A}_0^0 \subset \mathbf{T}^0 \setminus \text{Dom}(\mathbf{T}^0)$$

be the union of components of $(F|_{\mathbf{W}^0})^{-1}(\text{Dom}'(\mathbf{W}^0))$ that do not intersect the real line. Let

$$\mathbf{B}_0 = \cup_{i=0}^{\infty} (F|_{\text{Dom}'(\mathbf{T}^0) \setminus \mathbf{T}^1})^{-i}(\mathbf{A}_0^0).$$

See Figure 20 for the first few pullbacks of \mathbf{A}_0^0 . For any $i \geq 0$, the set $(F|_{\text{Dom}'(\mathbf{T}^0) \setminus \mathbf{T}^1})^{-i}(\mathbf{A}_0^0)$ is contained in $(F|_{\text{Dom}'(\mathbf{T}^0) \setminus \mathbf{T}^1})^{-i}(\mathbf{T}^0)$. Each component \mathbf{T}' of $(F|_{\text{Dom}'(\mathbf{T}^0) \setminus \mathbf{T}^1})^{-i}(\mathbf{T}^0)$ intersects the real line, and the mapping $F^i|_{\mathbf{T}'}$ is a diffeomorphism with dilatation bounded independently of i by Proposition 7.4.

Since ψ_1 is $K(1+C\mu(\mathbf{V}^0))^2(1+C\mu(\tilde{\mathbf{V}}^0))^2$ -qc outside of $(\text{Dom}'(\mathbf{W}^0) \setminus \mathbf{W}^0) \cup (F|_{\mathbf{W}^0})^{-1}\text{Dom}'(\mathbf{W}^0)$, we have that ϕ'_0 conjugates the dynamics of F and \tilde{F} up to the first landings to $\mathbf{T}^1 \cup (\mathbf{T}^0 \setminus \text{Dom}(\mathbf{T}^0))$ and it is $K(1+C\mu(\mathbf{V}^0))^3(1+C\mu(\tilde{\mathbf{V}}^0))^3$ -qc outside of $\text{Dom}'(\mathbf{T}^1) \cup \mathbf{B}_0$. Since F and \tilde{F} are topologically conjugate, we have that $\phi'_0(F(c))$ and $(\tilde{F}(\tilde{c}))$ are contained in the same component of $\text{Dom}'(\tilde{\mathbf{T}}^1)$. As in Step 2, we modify ϕ'_0 in each component of $\text{Dom}'(\mathbf{T}^1)$ that contains a critical value of F , so that $\phi'_0(F(c)) = \tilde{F}(\tilde{c})$ for each critical point c of F .

Abusing notation, we will use ϕ'_0 to denote the modified mapping. It is important to observe that if $\mathbf{U} = \text{Comp}_{F^{k_c(c)}}(F^{-(l_c-k_c)}(\mathbf{V}^0))$, where $c \in \text{Crit}(F)$, then since \mathbf{U} is a pullback of \mathbf{V}^0 and we are only modifying ϕ'_0 in $\text{Dom}'(\mathbf{T}^1)$, we have that $\phi'_0(\mathbf{U}) = \tilde{\mathbf{U}}$.

For each $z \in \mathbf{T}^1$, let $\phi_1(z)$ be defined by

$$\phi'_0 \circ F = \tilde{F} \circ \phi_1,$$

and for $z \in \mathbb{C} \setminus \mathbf{T}^1$, set $\phi_1(z) = \phi'_0(z)$. Observe that ϕ_1 is a qc mapping of the plane that is $K(1 + C\mu(\mathbf{V}^0))^4(1 + C\mu(\tilde{\mathbf{V}}^0))^4$ -qc outside of

$$(\text{Dom}'(\mathbf{T}^1) \setminus \mathbf{T}^1) \cup \mathbf{B}_0 \cup (F|_{\mathbf{T}^1})^{-1}(\text{Dom}'(\mathbf{T}^1) \cup \mathbf{B}_0) \supset \text{Dom}(\mathbf{T}^1),$$

$\phi_1(\mathbf{T}^1) = \tilde{\mathbf{T}}^1$, $\phi_1(\text{Dom}(\mathbf{T}^1)) = \text{Dom}(\tilde{\mathbf{T}}^1)$, and for any component \mathbf{U} of $\text{Dom}(\mathbf{T}^1)$, if $z \in \partial\mathbf{U}$, $\phi_1 \circ F(z) = \tilde{F} \circ \phi_1(z)$.

Let \mathbf{A}_1^0 denote the union of the components of $(F|_{\mathbf{T}^1})^{-1}(\text{Dom}'(\mathbf{T}^1))$ that do not intersect the real line. Let

$$\mathbf{A}_1 = \mathbf{B}_0 \cup (F|_{\mathbf{T}^1})^{-1}(\mathbf{B}_0) \cup \mathbf{A}_1^0,$$

and let

$$\mathbf{B}_1 = \cup_{i=0}^{\infty} (F|_{\text{Dom}(\mathbf{T}^1) \setminus \mathbf{T}^2})^{-i}(\mathbf{A}_1).$$

Then after refining ϕ_1 , to obtain ϕ'_1 , which conjugates the dynamics of F and \tilde{F} up to the first landing to $\mathbf{T}^2 \cup (\mathbf{T}^1 \setminus \text{Dom}(\mathbf{T}^1))$, we have that ϕ'_1 is $K(1 + C\mu(\mathbf{V}^0))^5(1 + C\mu(\tilde{\mathbf{V}}^0))^5$ -qc outside of $\text{Dom}'(\mathbf{T}^2) \cup \mathbf{B}_1$.

Repeating this argument for each $i \leq N + 1$, we obtain a qc mapping $\phi'_{N+1}: \mathbb{C} \rightarrow \mathbb{C}$ with the following properties:

- ϕ'_{N+1} is K_1 -qc outside of $\text{Dom}'(\mathbf{T}^{N+2}) \cup \mathbf{B}_{N+1}$, where K_1 depends on N and $\mu(\mathbf{V}^0)$, see Proposition 7.4;
- for $0 \leq j \leq N + 2$, $\phi'_{N+1}(\mathbf{T}^j) = \tilde{\mathbf{T}}^j$, $\phi'_{N+1}(\text{Dom}'(\mathbf{T}^j)) = \text{Dom}'(\tilde{\mathbf{T}}^j)$;
- for $0 \leq j \leq N + 1$, $\phi'_{N+1}(\text{Dom}(\mathbf{T}^j)) = \text{Dom}(\tilde{\mathbf{T}}^j)$; and
- if \mathbf{U} is a component of $\text{Dom}(\mathbf{T}^j) \cup \text{Dom}'(\mathbf{T}^{N+2})$, for $0 \leq j \leq N + 1$, and $z \in \partial\mathbf{U}$, then $\phi'_{N+1} \circ F(z) = \tilde{F} \circ \phi'_{N+1}(z)$.

Since we only ever modify, that is, move, the points $\phi'_j(F(c))$, for $c \in \text{Crit}(F)$ and $0 \leq j \leq N + 1$, inside of $\text{Dom}'(\mathbf{T}^j)$, we have that for each $c \in \text{Crit}(f)$, $\mathbf{T}_c^{N+2} \subset \mathbf{V}_c^1$, $\phi'_{N+1}(\mathbf{V}^1) = \tilde{\mathbf{V}}^1$, and if \mathbf{U} is a component of $\text{Dom}'(\mathbf{V}^1)$ and $z \in \partial\mathbf{U}$, then $\phi'_{N+1} \circ F(z) = \tilde{F} \circ \phi'_{N+1}(z)$.

Let $\psi_2(z) = \phi'_{N+1}(z)$. Let us point out that if every critical value of F is contained in $\mathbf{V}^0 \setminus \mathbf{W}^0$, then $\psi_2 = \psi_1$. We have that $\psi_2: \mathbb{C} \rightarrow \mathbb{C}$ and $\psi_2(\mathbf{V}^1) = \tilde{\mathbf{V}}^1$. Let $\mathbf{T} = \cup_{c \in \text{Crit}(F)} \mathbf{T}_c^{N_c+1}$. We have that ψ_2 conjugates F and \tilde{F} up to the first entry mapping to \mathbf{T} . Now, refine ψ_2 in $\text{Dom}(\mathbf{T})$ as in Step 1, so that it is a conjugacy up to the first landing time to \mathbf{V}^1 . Let $\mathbf{B}^1 = \mathbf{B}_{N+2} \setminus \text{Dom}'(\mathbf{V}^1)$. As in Step 2, since F and \tilde{F} are topologically conjugate, corresponding critical values are contained in corresponding components of $\text{Dom}(\mathbf{V}^1)$, moving each $\psi_2(F(c))$ so that it agrees with $\tilde{F}(\tilde{c})$, by a qc mapping which is the identity outside of $\text{Comp}_{\tilde{F}(\tilde{c})}(\text{Dom}(\tilde{\mathbf{V}}^1))$, and pulling back, we obtain a qc mapping $\Psi_1: \mathbb{C} \rightarrow \mathbb{C}$ which is K_1 -qc outside of $\text{Dom}(\mathbf{V}^1) \cup \mathbf{X}^1$, where $\mathbf{X}^1 = \mathbf{B}^1 \cup (F|_{\mathbf{V}^1})^{-1}(\mathbf{B}^1)$ and $K_1 = K_1(N, \mu(\mathbf{V}^0)) \geq 1$, see Proposition 7.4. Moreover, $\Psi_1(\text{Dom}(\mathbf{V}^1)) = \text{Dom}(\tilde{\mathbf{V}}^1)$, and Ψ_1 conjugates F and \tilde{F} on $\partial\mathbf{U}$ for each component \mathbf{U} of $\text{Dom}(\mathbf{V}^1)$.

Step 4: A qc\bg pseudo-conjugacy. In this step, we deal with the issue concerning moduli bounds pointed out in the remark in Step 2. Let \mathbf{U} be a component of \mathbf{A}_0^0 , so that $\mathbf{V} = F(\mathbf{U})$ is a component of $\text{Dom}'(\mathbf{W}^0)$. We have that $\psi_1|_{\mathbf{W}^0}$ is $K(1 + C\mu(\mathbf{V}^0))^2(1 + C\mu(\tilde{\mathbf{V}}^0))^2$ -qc on $\mathbf{W}^0 \setminus (F|_{\mathbf{W}^0})^{-1}(\text{Dom}'(\mathbf{W}^0))$ (where K still denotes the dilatation of the external conjugacy). By Corollary 5.19, we have that there exists $\delta > 0$, so that for each critical point c of F and each component \mathbf{U} of $(F|_{\mathbf{W}_c^0})^{-1}(\text{Dom}'(\mathbf{W}^0))$ we have that $\text{mod}(\mathbf{W}_c^0 \setminus \mathbf{U}) \geq \delta$. Let $s \in \mathbb{N}$ be so that $F^s(\mathbf{U})$ is a component of \mathbf{W}^0 . Let $\psi_3|_{\mathbf{U}}$ be defined by

$$\psi_1 \circ F|_{\mathbf{U}}^s(z) = \tilde{F}^s \circ \psi_3(z).$$

The mapping $\psi_3|_{\mathbf{U}}$ is $K(1 + C\mu(\mathbf{V}^0))^3(1 + C\mu(\tilde{\mathbf{V}}^0))^3$ -qc on

$$\mathbf{U} \setminus (F|_{\mathbf{U}})^{-s}(F|_{\mathbf{W}_c^0})^{-1}(\text{Dom}'(\mathbf{W}^0)),$$

and there exists $\varepsilon'_0 > 0$ so that each component of \mathbf{U}' of $(F|_{\mathbf{U}})^{-s}(F|_{\mathbf{W}_c^0})^{-1}(\text{Dom}'(\mathbf{W}^0))$ has ε'_0 -bounded geometry and $\text{mod}(\mathbf{U} \setminus \mathbf{U}') \geq \varepsilon'_0$.

Thus we have ψ_3 defined on \mathbf{A}_0^0 , where it is a $(K(1 + C\mu(\mathbf{V}^0))^3(1 + C\mu(\tilde{\mathbf{V}}^0))^3, \varepsilon'_0)$ -qc\bg mapping. For any component \mathbf{V} of \mathbf{B}_0 , let $j \geq 0$ be so that $F^j(\mathbf{V})$ is a component of \mathbf{A}_0^0 , and define ψ_3 on \mathbf{V} by $\psi_3 \circ F^j|_{\mathbf{V}}(z) = \tilde{F}^j \circ \psi_3(z)$. This is well defined since $F^j|_{\mathbf{V}}$ is a diffeomorphism as $\mathbf{V} \cap \mathbb{R} = \emptyset$. Moreover, since we are pulling ψ_3 back along real diffeomorphic branches of F , we have there exists $\varepsilon_0 > 0$ so that that the resulting mapping is $(K(1 + C\mu(\mathbf{V}^0))^4(1 + C\mu(\tilde{\mathbf{V}}^0))^4, \varepsilon_0)$ -qc\bg.

Let \mathbf{U} be a component of \mathbf{A}_1^0 such that if $\hat{\mathbf{U}}$ is the component of $F^{-1}(\text{Dom}'(\mathbf{W}_0))$ which contains \mathbf{U} , then $\hat{\mathbf{U}}$ intersects the real line, see Figure 4. (In the previous step, we defined ψ_3 on the components of $(F|_{\mathbf{W}_0})^{-1}(\text{Dom}'(\mathbf{W}_0))$ which do not intersect the real line.) Let $s \in \mathbb{N}$ be so that $F^s(\mathbf{U})$ is a component of \mathbf{T}^1 . We have that $\phi_1|_{\mathbf{T}^1}$ is $K(1 + C\mu(\mathbf{V}^0))^4(1 + C\mu(\tilde{\mathbf{V}}^0))^4$ -qc on $\mathbf{T}^1 \setminus ((F|_{\mathbf{T}^1})^{-1}(\text{Dom}'(\mathbf{T}^1) \cup \mathbf{B}_0))$. Recall that on each component of \mathbf{B}_0 , ψ_3 is $(K(1 + C\mu(\mathbf{V}^0))^4(1 + C\mu(\tilde{\mathbf{V}}^0))^4, \varepsilon_0)$ -qc\bg. We define $\psi_3|_{\mathbf{U}}$ by the formula:

$$\phi_1 \circ F^s(z) = \tilde{F}^s \circ \psi_3(z), \text{ for } z \in \mathbf{U}.$$

Then $\psi_3|_{\mathbf{U}}$ is $K(1 + C\mu(\mathbf{V}^0))^5(1 + C\mu(\tilde{\mathbf{V}}^0))^5$ -qc on $\mathbf{U} \setminus (F|_{\mathbf{U}})^{-s}((F|_{\mathbf{T}^1})^{-1}(\text{Dom}'(\mathbf{T}^1) \cup \mathbf{B}_0))$. Moreover, there exists $\varepsilon_1 > 0$ so that each if \mathbf{U}' is a component of the set

$$(F|_{\mathbf{U}})^{-s}((F|_{\mathbf{T}^1})^{-1}(\text{Dom}'(\mathbf{T}^1))),$$

then \mathbf{U}' has ε_1 -bounded geometry and $\text{mod}(\mathbf{U} \setminus \mathbf{U}') \geq \varepsilon_1$. The bound on the geometry follows from Lemma 5.21, and we obtain the moduli bounds from Corollary 5.19 and Lemma 5.17. We extend ψ_3 to all of \mathbf{B}_1 by pulling back through diffeomorphic branches of F - just as we did to extend it from \mathbf{A}_0^0 to \mathbf{B}_0 .

We repeat this argument for each component of $(F|_{\mathbf{T}^j})^{-1}(\text{Dom}'(\mathbf{T}^j))$, $0 \leq j \leq N + 2$. This processes gives us a $\varepsilon_{N+2} > 0$, depending on N , and a (K_1, ε_{N+2}) -qc\bg mapping $\psi_3: \mathbf{X}^1 \rightarrow \tilde{\mathbf{X}}^1$, where $K_1 \geq 1$ is given by Proposition 7.4, with the following properties. Suppose that \mathbf{U} is a component of \mathbf{X}^1 , then \mathbf{U} there exists $s \in \mathbb{N}$, $c \in \text{Crit}(F)$ and $0 \leq j \leq N + 2$ so that $F^s(\mathbf{U}) = \mathbf{T}_c^j$. Then $\psi_3|_{\mathbf{U}}$ is K_1 -qc outside of $F^{-s}(F^{-1}(\text{Dom}'(\mathbf{T}^j) \cup \mathbf{B}_{j-1}))$, and each component \mathbf{U}' of $F^{-s}(F^{-1}(\text{Dom}'(\mathbf{T}^j) \cup \mathbf{B}_{j-1}))$ has ε_{N+2} -bounded geometry and $\text{mod}(\mathbf{U} \setminus \mathbf{U}') \geq \varepsilon_{N+2}$.

Define $H_1: \mathbb{C} \rightarrow \mathbb{C}$ by $H_1(z) = \Psi_1(z)$ for $z \in \mathbb{C} \setminus \mathbf{X}^1$ and $H_1(z) = \psi_3(z)$ for $z \in \mathbf{X}^1$. Then

$$H_1|_{\mathbb{C} \setminus \text{Dom}(\mathbf{V}^1)}: \mathbb{C} \setminus \text{Dom}(\mathbf{V}^1) \rightarrow \mathbb{C} \setminus \text{Dom}(\tilde{\mathbf{V}}^1)$$

is a (K_1, ε_{N+2}) -qc\bg mapping.

Step 5: The inductive step. When the length of long central cascades is bounded, we have that there exists $\delta_0 > 0$ such that the following holds: Repeating Steps 1 through 4 for each $n \in \mathbb{N} \cup \{0\}$ we have there is a (K_1, δ_0) -qc\bg mapping:

$$H_n|_{\mathbb{H}^+ \setminus \text{Dom}'(\mathbf{W}^n)}: \mathbb{H}^+ \setminus \text{Dom}'(\mathbf{W}^n) \rightarrow \mathbb{H}^+ \setminus \text{Dom}'(\widetilde{\mathbf{W}}^n),$$

such that H_n agrees with the boundary marking on each component of $\text{Dom}'(\mathbf{W}^n)$. By the QC Criterion and the complex bounds (see Step 4), we have that there exists $K_2 = K_2(K_1, \delta, N) \geq 1$, and K_2 -qc mapping $\Psi_2: \mathbf{W}^n \rightarrow \widetilde{\mathbf{W}}^n$, which agrees with the boundary marking on each component of \mathbf{W}^n . Let Ψ_3 be the mapping from $\text{Dom}'(\mathbf{W}^n)$ to $\text{Dom}'(\widetilde{\mathbf{W}}^n)$ obtained by pulling this mapping back by the first entry mapping to \mathbf{W}^n . Define $H_{\mathbf{W}^n}(z) = H_n(z)$ for $z \in \mathbb{C} \setminus \text{Dom}(\mathbf{W}^n)$, and $H_{\mathbf{W}^n}(z) = \Psi_3(z)$ for $z \in \text{Dom}(\mathbf{W}^n)$. Then we have that there exists $K_0 \geq 1$ so that $H_{\mathbf{W}^n}: \mathbb{H}^+ \rightarrow \mathbb{H}^+$ is a (K_0, δ_0) -qc\bg mapping.

Let us just point out that to start the construction of the set off the real line with bounded geometry at deeper levels we take \mathbf{A}_n^0 to be the set \mathbf{X}^{n-1} together with the components of $(F|_{\mathbf{W}^n})^{-1}(\text{Dom}'(\mathbf{W}^0))$ which do not intersect the real line. By Proposition 5.18, we have that there exists a constant $C_1 \geq 1$, so that for any component \mathbf{U} of $\cup_{n=1}^{\infty} \mathbf{X}^n$, if $j > 0$ is so that $F^j(\mathbf{U})$ is a component of \mathbf{A}_k^0 for some $k \geq 0$, then $F^k|_{\mathbf{U}}$ is C_1 -qc, and thus $\psi_3|_{\mathbf{U}}$ (constructed in Step 4) is a (K_1, δ_1) -qc\bg mapping.

Step 6: Long central cascades. When there is a long central cascade we are unable to control the dilatation of the ϕ_n constructed in Step 3. To deal with this problem, we replace the mapping ϕ_n , constructed by pulling back, with the mapping H given by Theorem 7.5, which gives us the QC\BG Partition of the Central Cascade. The reason that we cannot do this automatically is that the puzzle pieces, $\mathcal{G}_c(k)$ are not necessarily contained in the good nest. We will prove that there exist $K_3 \geq 1, \delta_3 > 0$, which do not depend on c or k , such that for any $\mathcal{G}_c(k)$ at the top of a long central cascade, there is a mapping $\hat{H}: \mathbb{C} \rightarrow \mathbb{C}$, such that $\hat{H}: \mathbb{H} \rightarrow \mathbb{H}$ is a (K_3, δ_3) -qc\bg mapping, $\hat{H}(\mathcal{G}_c(k)) = \widetilde{\mathcal{G}}_c(k)$, $\hat{H}(\mathcal{L}_c(\mathcal{G}_c(k))) = \mathcal{L}_{\tilde{c}}(\widetilde{\mathcal{G}}_c(k))$, and \hat{H} respects the boundary marking on $\mathcal{G}_c(k)$ and $\mathcal{L}_c(\mathcal{G}_c(k))$. Then Theorem 7.5 yields a mapping from $\mathcal{G}_c(k)$ to $\widetilde{\mathcal{G}}_c(k)$, as in the conclusion of Theorem 7.5. Once we have this mapping we spread it around dynamically.

Let $n \in \mathbb{N}$, and let $H_{\mathbf{W}^n}$ be the mapping constructed in Steps 1–5. We have that

$$H_{\mathbf{W}^n}: \mathbb{C} \rightarrow \mathbb{C}$$

is such that

- $H_{\mathbf{W}^n}(\mathbf{W}^n) = \widetilde{\mathbf{W}}^n$;
- $H_{\mathbf{W}^n}(\text{Dom}(\mathbf{W}^n)) = \text{Dom}(\widetilde{\mathbf{W}}^n)$; and
- for any component \mathbf{U} of $\text{Dom}(\mathbf{W}^n)$, $H_{\mathbf{W}^n} \circ F(z) = \tilde{F} \circ H_{\mathbf{W}^n}(z)$, for $z \in \partial\mathbf{U}$.

Step 6a. Now, let us construct a neighbourhood of the post-critical set as follows: for each critical point c_0 of F , let $\mathcal{O}_{c_0} \ni c_0$ be the smallest puzzle piece from the good nest with the following property: Suppose that $\{U_j\}_{j=0}^s$ is the chain with $U_0 = \mathcal{O}_c$, and $U_s = \mathbf{V}_c^0$ for some $c \in \text{Crit}(F)$. If $U_j \ni F(c')$, for some $c' \in \text{Crit}(F)$, then $H_{\mathbf{W}^n}(F(c')) = \tilde{F}(\tilde{c}')$. Let $\mathcal{O} = \cup_c \mathcal{O}_c$. Note that it follows from equation 5.1, we have that as $n \rightarrow \infty$, for each $c \in \text{Crit}(F)$, $\text{diam}(\mathcal{O}_c) \rightarrow 0$.

Let us regard $H_n: \mathbf{V}^0 \rightarrow \widetilde{\mathbf{V}}^0$ as a conjugacy between $F: \mathbf{W}^0 \rightarrow \mathbf{V}^0$ and $\tilde{F}: \widetilde{\mathbf{W}}^0 \rightarrow \widetilde{\mathbf{V}}^0$.

Step 6b. Set $\hat{H}_0 = H_{W^n}$. We pullback \hat{H}_0 as follows: Let $\mathcal{Y}^0 = V^0$, $\mathcal{Y}^1 = W^0$. Assuming that \mathcal{Y}^i has been defined, we define \mathcal{Y}^{i+1} to be the set of all connected components $(F|_P)^{-1}(Q)$ where P is a puzzle piece in \mathcal{Y}^i which intersects the real line and Q is a puzzle piece in \mathcal{Y}^i .

For each component U of W^0 , with the property that if U contains a critical value $F(c')$, then $\text{Comp}_c F^{-1}(U) \supset \mathcal{O}_c$, define \hat{H}_1 on U by $\tilde{F} \circ \hat{H}_1(z) = \hat{H}_0 \circ F(z)$. Assuming that \hat{H}_i is defined on \mathcal{Y}^i , on each component P of \mathcal{Y}^{i+1} , with the property that if P contains a critical value $F(c')$, then $\text{Comp}_c F^{-1}(U) \supset \mathcal{O}_c$, we define \hat{H}_{i+1} by $\tilde{F} \circ \hat{H}_{i+1}(z) = \hat{H}_i \circ F(z)$. By the choice of \mathcal{O} we can pullback $\hat{H}_0 = H_n: \mathbb{C} \rightarrow \mathbb{C}$ to obtain $\hat{H}: \mathbb{C} \rightarrow \mathbb{C}$ such that $\hat{H}(\mathcal{O}) = \tilde{\mathcal{O}}$. Now, arguing as in Step 1, we may assume that \hat{H} is a conjugacy up to the first landing mapping to \mathcal{O} . By Proposition 7.4, the dilatation of the mapping from any component of \mathcal{O} onto a component of V^0 is bounded.

Step 6c. In this step we redefine \hat{H} inside of central cascades so that it will be a qc\bg mapping. By Prop 5.13, for any critical point c and any $\mathcal{C}_c^k(V_c^0) \supset \mathcal{O}$ that is at the top of a long central cascade (with length at least $12b^2 - 4b$, where b is the number of critical points of F) there exists a δ -excellent puzzle piece $\mathcal{G}_c(k)$ at the ‘‘top’’ of the central cascade.

Moreover, unless V_c^n is at the top of a long central cascade and $\mathcal{G}_c(k)$ is at the top of the same long central cascade, we have that \hat{H} conjugates the dynamics of F and \tilde{F} on the boundary of a necklace neighbourhood of the real line contained in $\mathcal{N}_c(k)$, since \hat{H} conjugates the dynamics of F and \tilde{F} up to the first landing time to \mathcal{O} . By Theorem 7.5, we can redefine \hat{H} from $\mathcal{G}_c(k) \setminus \mathcal{N}_c(k) \rightarrow \tilde{\mathcal{G}}_c(k) \setminus \tilde{\mathcal{N}}_c(k)$ obtain a mapping which is (K', δ') -qc\bg on $\mathcal{G}_c(k)$.

To conclude the proof, we almost repeat the argument from Step 6b, except here we do not refine \hat{H} in $\mathcal{G}_c(k) \setminus \mathcal{N}_c(k)$. Instead we use the mapping given by Theorem 7.5, and then pull this mapping back. We have that $\hat{H}: V^0 \rightarrow \tilde{V}^0$ is a conjugacy between $F: W^0 \rightarrow V^0$ and $\tilde{F}: \tilde{W}^0 \rightarrow \tilde{V}^0$. Let us abuse notation and redefine the sequence \hat{H}_0 . Let $\hat{H}_0 = \hat{H}$. Assuming that \hat{H}_i is defined on \mathcal{Y}^i , on each component P of \mathcal{Y}^{i+1} , with the property that if P contains a critical value $F(c')$, then $\text{Comp}_c F^{-1}(U) \supset \mathcal{O}_c$, we define \hat{H}_{i+1} as follows: If neither U nor the smallest real puzzle piece that contains U is deep in a central cascade, then for $z \in U$, define \hat{H}_{i+1} so that $\tilde{F} \circ \hat{H}_{i+1}(z) = \hat{H}_i \circ F(z)$. If either U or the smallest real puzzle piece that contains U is deep in a central cascade with $\mathcal{G}_c(k)$ as a top level puzzle piece, then set $\hat{H}_{i+1}(z) = \hat{H}_0(z)$ if $z \notin \mathcal{N}_c(k)$, and if $z \in \mathcal{N}_c(k)$, then define H so that $\tilde{F} \circ \hat{H}_{i+1}(z) = \hat{H}_i \circ F(z)$. Thus we obtain a neighbourhood \mathcal{O} of $\text{Crit}(F)$, and a (K_1, δ_1) -qc\bg mapping $\hat{H}_{\mathcal{O}}: \mathbb{C} \setminus \text{Dom}(\mathcal{O}) \rightarrow \mathbb{C} \setminus \text{Dom}(\tilde{\mathcal{O}})$.

Before concluding the proof, let us point out that we by the QC Criterion, we have the following Corollary.

Corollary 7.7. *For any N_0 , there exists $K \geq 1$ such that for any puzzle piece E that is either from the enhanced nest, $E = W_c^n$, from the good nest, or that is obtained as a pullback of a component of \mathcal{V} with order bounded by N_0 , there exists a K -qc mapping from E to \tilde{E} that agrees with the boundary marking.*

Step 6d. By the corollary, we have that there exist $K_3 \geq 1$ and arbitrarily small neighbourhoods \mathcal{O} of $\text{Crit}(F)$ such that for each component \mathcal{O}_c of \mathcal{O} , there is a K_4 -qc mapping from $\mathcal{O}_c \rightarrow \tilde{\mathcal{O}}_c$, which respects the boundary marking. Thus redefining $\hat{H}_{\mathcal{O}}$ in $\text{Dom}'(\mathcal{O})$, by

pulling back this mapping by the landing map, we obtain a (K_0, δ_0) -qc\bg mapping $H_{\mathcal{O}}$ of the \mathbb{H} which agrees with the standard boundary marking on $\text{Dom}'(\mathcal{O})$. \square

By the QC Criterion and compactness of the space of K -qc mappings we have:

Theorem 7.8 (Quasisymmetric rigidity for box mappings). *Suppose that $F: \mathcal{U} \rightarrow \mathcal{V}$ $\tilde{F}: \tilde{\mathcal{U}} \rightarrow \tilde{\mathcal{V}}$ are non-renormalizable, strongly combinatorially equivalent box mappings that are given by either Theorem 5.2 or Theorem 5.3, which in particular satisfy the conditions of Theorem 7.1. Then restricted to the real line, the mappings $F: \mathcal{U} \rightarrow \mathcal{V}$ and $\tilde{F}: \tilde{\mathcal{U}} \rightarrow \tilde{\mathcal{V}}$, are quasimetrically conjugate.*

Proof. We have that there exist arbitrarily small neighbourhoods \mathcal{O} of $\text{Crit}(F)$ and (K_0, δ_0) -qc\bg mappings $H: \mathbb{H}^+ \rightarrow \mathbb{H}^+$ such that H conjugates F and \tilde{F} up to the first landing times to \mathcal{O} . By the QC Criterion, there is a K_1 -qc mapping \hat{H} , which agrees with the restriction of H to \mathbb{R} . By the compactness of the space of K_1 -qc mappings, as we take smaller neighbourhoods of $\text{Crit}(F)$, there exists a limiting K_1 -qc mapping which conjugates F and \tilde{F} on their real traces. \square

7.6. Central cascades, the proof of a QC\BG Partition of a Central Cascade. We will require the following partial ordering on central cascades: we say that a central cascade $Z^0 \supset Z^1 \supset \dots \supset Z^{N_1} \supset Z^{N_1+1} \ni c_1$ is *deeper* than a central cascade $U^0 \supset U^1 \supset \dots \supset U^{N_2} \supset U^{N_2+1} \ni c_2$ if $\mathcal{L}_{c_1}(U_0) \supset Z^1$. Suppose that $Z^0 \supset Z^1 \supset \dots \supset Z^{N_1} \supset Z^{N_1+1} \ni c_1$ and $U^0 \supset U^1 \supset \dots \supset U^{N_2} \supset U^{N_2+1} \ni c_2$ are two cascades so that neither is deeper than the other. Then $\mathcal{L}_{c_1}(U^0) \subset Z^1$, and $\mathcal{L}_{c_2}(Z^0) \subset U^1$. But now, if $x \in Z^0 \setminus Z^1$, then $\mathcal{L}_x(U_0) \subset Z^0 \setminus Z^1$ and if $x \in U^0 \setminus U^1$, then $\mathcal{L}_x(Z_0) \subset U^0 \setminus U^1$. Because of this observation, it will not matter in which order we treat central cascades that are unrelated by the partial ordering. We will prove Theorem 7.5 starting with the shallowest (least deep) central cascades, and proceeding to deeper central cascades.

We will need the following lemmas:

Lemma 7.9. *If Z^0 is sufficiently small, the first return mapping $R: Z^2 \rightarrow Z^1$ has negative Schwarzian derivative.*

Proof. We will decompose the mapping into a composition of polynomials and diffeomorphisms. Let $\{G_j\}_{j=0}^s$ denote the chain with $G_s = Z^1$ and $G_0 = Z^2$. Let $0 = s_1 < s_1 < \dots < s_{b-1} < s_b = s$, denote the indices such that G_{s_i} contains a critical point. Label the critical point in G_{s_i} by c_i . We can express $R|_{Z^2}$ as

$$F^{s_b-s_{b-1}} \circ F^{s_{b-1}-s_{b-2}} \circ \dots \circ F^{s_2-s_1} \circ F^{s_1}|_{Z^2}: Z^2 \rightarrow Z^1.$$

For each $F^{s_i-s_{i-1}}|_{G_{s_{i-1}}}$, $i = 1, 2, \dots, b$, we estimate the Schwarzian derivative as usual.

$$SF^{s_i-s_{i-1}}(x) = SF^{s_i-s_{i-1}-1}(F(x))F'(x)^2 + SF(x).$$

For $x \in G_{s_{i-1}}$, we have that

$$SF(x) \asymp -\frac{1}{(x-c_i)^2} \leq -\frac{1}{|G_{s_{i-1}}|}.$$

For $x \in F(G_{s_{i-1}})$,

$$\begin{aligned} SF^{s_i-s_{i-1}-1}(F(x)) &= \sum_{i=0}^{s_i-s_{i-1}-2} SF(F^{i+1}(x))((F^i)'(x)) \\ &\leq \frac{C}{|G_{s_{i-1}+1}|^2} \max_{y \in \tilde{Z}^0} SF(y) \sum_{s=s_{i-1}+2}^{s_i} |G_j|^2. \end{aligned}$$

So we have that

$$SF^{s_i-s_{i-1}}(x) \leq \frac{C}{|G_{s_{i-1}+1}|^2} \cdot \max_{y \in \tilde{Z}^0} SF(y) \sum_{j=s_{i-1}+1}^{s_i} |G_j|^2 \left(\frac{|G_{s_{i-1}+1}|}{|G_{s_{i-1}}|} \right)^2 - \frac{1}{|G_{s_{i-1}}|^2}.$$

This is negative when $\sum_{j=s_{i-1}+1}^{s_i} |G_j|^2$ is small, and this holds when $|Z^0|$ is sufficiently small. \square

Lemma 7.10. *For any $\delta > 0$ there exist $\kappa > 0$ and $C > 0$ with the following properties. Let Z be a nice interval (as usual, assumed to be sufficiently small), having a central cascade $Z := Z^0 \supset Z^1 \supset \dots \supset Z^{N+1}$ with $N \geq 1$ and let r be the return time of Z^1 to Z^0 .*

(1) *If $|Z^2| \geq \delta|Z^0|$, then for any critical point c of the mapping $R_Z|_{Z^2}$ we have*

$$|F^r(c) - c| \geq \kappa|Z^0| \text{ and } |DF^r(x)| \leq C \text{ for all } x \in Z^2.$$

(2) *If $|Z^1| \geq \delta|Z^0|$ and we let $\tilde{Z} = (1 + 2\delta)Z$ and $\tilde{Z}^1 = \text{Comp}_{Z^1}(F^{-r}(\tilde{Z}))$ the following holds. Suppose that F^r extends to a mapping from \tilde{Z}^1 to \tilde{Z} , with the same set of critical points as $F^r|_{Z^1}$, that can be decomposed into a finite composition of maps with bounded distortion and polynomials. Then for any critical point c of the mapping $R_Z|_{Z^1}$ we have*

$$|F^r(c) - c| \geq \kappa|Z^0|, \text{ and } |DF^r(x)| \leq C \text{ for all } x \in Z^1.$$

Finally we will need the following Lemma of Yoccoz, which gives us precise control of the real geometry in saddle-node cascades. For a proof, we refer the reader to [dFdM1]. Suppose that $\Delta_0, \Delta_1, \Delta_2, \dots, \Delta_a$ is a sequence of adjacent intervals in \mathbb{R} . If $g: \cup_{i=0}^{a-1} \Delta_i \rightarrow \cup_{i=1}^a \Delta_i$ is a diffeomorphism with negative Schwarzian derivative such that $g(\Delta_i) = \Delta_{i+1}$ for $i = 0, \dots, a-1$, then we call g an *almost parabolic map of length a* with fundamental domains Δ_i .

Lemma 7.11 (Yoccoz Lemma). *For any $\sigma > 0$, there exists $C > 1$ such that the following holds. Let $g: J \rightarrow I$ be an almost parabolic mapping of length a with fundamental domains $\Delta_i, i = 0, \dots, a$. If $|\Delta_0| > \sigma|I|$ and $|\Delta_{a-1}| > \sigma|I|$, then*

$$\frac{1}{C} \frac{|I|}{\min\{i, a-i\}^2} \leq |\Delta_i| \leq C \frac{|I|}{\min\{i, a-i\}^2}.$$

We will use the following simple lemma to prove that certain domains are quasidisks.

Lemma 7.12. *For any $\alpha \geq 1, \delta > 0, n \in \mathbb{N}$ and $c \in (0, 1)$ there exists $K \geq 1$ such that the following holds. Suppose that $D \subset \mathbb{C}$ is a topological disk with marked points $\{a_1, a_1, \dots, a_n\} \in \partial D$. Assume that $D \setminus \{a_1, a_1, \dots, a_n\}$ is a union of n piecewise smooth α -quaisarcs $\gamma_i, i = 1, 2, \dots, n$ with*

- $\text{diam}(\gamma_i) > \delta \text{diam}(D)$.
- if γ_i and $\gamma_{i'}, i \neq i'$ are not adjacent in ∂D , then $\text{dist}(\gamma_i, \gamma_{i'}) \geq \delta \text{diam}(D)$,

- If $\gamma_i, \gamma_{i'}$ are adjacent, then for any $z_1, z_2 \in \overline{\gamma_i \cup \gamma_{i'}}$ we have that the shortest $\gamma_{[z_1, z_2]}$ path in ∂D connecting z_1 and z_2 satisfies $c \cdot \text{diam}(\gamma_{[z_1, z_2]}) \leq |z_1 - z_2|$.

Then D is a K -quasidisk.

Proof. Let us verify the Ahlfors-Beurling Criterion for any two points $z_1, z_2 \in \partial D$. First suppose that $z_1, z_2 \in \gamma_i$. Then since γ_i is an α -quasiarc, we have that the diameter of the path in γ_i that connects z_1 and z_2 has diameter at most $C \cdot |z_1 - z_2|$, for some C depending only on α . By assumption, the Ahlfors-Beurling Criterion holds if z_1 and z_2 are in adjacent components of $\partial D \setminus \{a_1, \dots, a_n\}$. So, let us suppose that $z_1 \in \gamma_i, z_2 \in \gamma_{i'}$, and γ_i and $\gamma_{i'}$ are not adjacent. Then we have that $\text{dist}(z_1, z_2) > \delta \text{diam} D > n\delta \max_{i=1, \dots, n} \text{diam}(\gamma_i) \geq n\delta \gamma_{[z_1, z_2]}$. \square

The following lemma provides the first step in the inductive proof of Theorem 7.5. It is proved using the fact that there are no central cascades lower in the partial ordering on central cascades, and the same argument as the one used to obtain the Real Spreading Principle.

Lemma 7.13. *There exist $\delta_1 > 0$ and $K_1 \geq 1$ so that if $\hat{\mathcal{C}}_{c_0}^k(\mathbf{I}_{c_0}^0)$, $c_0 \in \text{Crit}(F)$ and $k \in \mathbb{N} \cup \{0\}$, is a puzzle piece at the top of a maximal central cascade of length $N \geq N_0$ which is lowest in the partial ordering on central cascades, then the following holds. There exists a mapping $H: \mathbb{C} \rightarrow \mathbb{C}$ such that $H: \mathbb{H}^+ \rightarrow \mathbb{H}^+$ is a (K_1, δ_1) -qc\bg mapping, and a neighbourhood \mathcal{O} of $\text{Crit}(F)$ such that $\text{Comp}_{c_0} \mathcal{O} = \mathcal{G}_{c_0}(k)$, $H(\mathcal{O}) = \tilde{\mathcal{O}}$, $H(\text{Dom}(\mathcal{O})) = \text{Dom}(\tilde{\mathcal{O}})$ and H agrees with the boundary markings on \mathcal{O} and on each component of $\text{Dom}(\mathcal{O})$, where $\mathcal{G}_{c_0}(k)$ is the puzzle piece associated to the long central cascade by Proposition 5.13.*

Proof. Since this central cascade is lowest in our ordering, we can argue as in the proof of the Real Spreading Principle to see that there is a (K_1, δ_1) -qc\bg mapping of the plane as in the statement of the lemma. Specifically, let n be so that $\mathbf{W}_{c_0}^n$ is at the top of the central cascade, and let $H_{\mathbf{W}^n}: \mathbb{C} \rightarrow \mathbb{C}$ be the mapping constructed in Steps 1–5 of Proposition 7.6. Let $\mathbf{T}^0 = \mathbf{W}^n$, and let $t > 0$ be minimal so that $\mathbf{T}^t \subset \mathcal{L}_{c_0}^7(\mathbf{T}_{c_0}^0)$. Note that t is at most $7\#\text{Crit}(F)$. Now, starting with $H_{\mathbf{W}^n}$, use the argument of Step 3 of Proposition 7.6 to construct $\phi_t: \mathbb{C} \rightarrow \mathbb{C}$, which conjugates the dynamics of F and \tilde{F} on $\text{Dom}(\mathbf{T}^t)$. Starting with ϕ_t , use the argument from Step 6b of Proposition 7.6 to pullback ϕ_t , acting as a conjugacy between $F: \mathcal{U} \rightarrow \mathcal{V}$ and $\tilde{F}: \tilde{\mathcal{U}} \rightarrow \tilde{\mathcal{V}}$. Let $r > 0$ be so that $F^r(\mathcal{G}_{c_0}(k))$ is a component of \mathcal{V} . Since by Lemma 5.7 there are at most six visits of c_0 to $\mathcal{G}_{c_0}(k)$ along the orbit $\{f^i(c_0) : 0 < i \leq r\}$, we have that after pulling ϕ_t back, we can assume that $\phi_t(\mathcal{G}_{c_0}(k)) = \tilde{\mathcal{G}}_{c_0}(k)$. Now we conclude the proof as in Proposition 7.6. \square

Assume that

$$\mathbf{Z}^0 \supset \mathbf{Z}^1 \supset \dots \mathbf{Z}^{N+1}$$

is a maximal central cascade and that Theorem 7.5 holds for all maximal central cascades that are lower in the partial ordering on central cascades than $\mathbf{Z}^0 \supset \mathbf{Z}^1 \supset \dots \mathbf{Z}^{N+1}$. Then by the argument used to prove the Real Spreading Principle and Lemma 7.13, we have that there exists $K \geq 1, \delta > 0$ and a mapping $H: \mathbf{Z}^0 \rightarrow \tilde{\mathbf{Z}}^0$ with $H(\mathbf{Z}^1) = \tilde{\mathbf{Z}}^1$ which is (K, δ) -qc\bg and, and a (K, δ) -qc\bg in the upper half-plane. Let us now carry out the inductive step of the proof of Theorem 7.5.

The proof of Theorem 7.5. Recall that $R: \mathbf{J}^1 \rightarrow \mathbf{J}^0$ is the first return mapping to a δ -excellent puzzle piece at the “top” of a long central cascade. To begin, let us explain a

construction that we will use in all cases to subdivide \mathbf{J}^0 into the sets X_0, X_1, X_2 and X_3 . We are going to construct four “staircases” which will consist of alternating pre-images of the real fundamental domains $J^0 \setminus J^1$ under R^i that lie in $\mathbb{C} \setminus \mathbb{R}$, and piecewise smooth arcs in $\partial \mathbf{J}^{i+1}$, see Figure 21. These staircases are piecewise smooth curves and will be part of the set X_0 . They will serve as the boundaries of artificial, but still dynamically defined, “puzzle pieces” that we will use to form the sets X_1, X_2 and X_3 .

Suppose that the degree of R is d . Let e_0 be the union of the two fundamental intervals comprising $J^0 \setminus J^1$. Then $R^{-1}(e_0) \subset \mathbf{J}^1 \setminus \mathbf{J}^2$ consists of $2d$ components contained in $\mathbf{J}^1 \setminus \mathbf{J}^2$ that connect $\partial \mathbf{J}^1$ with $\partial \mathbf{J}^2$. Of these components, $2d - 2 \geq 2$ lie in $\mathbb{C} \setminus \mathbb{R}$. We let e_1 denote the union of components e_1^j of $R^{-1}(e_0)$ with the property that there exists a path in $\mathbf{J}^1 \setminus (\overline{\mathbf{J}^2} \cup R^{-1}(e_0))$ that connects e_1^j with the real fundamental domains, $J^1 \setminus J^2$.

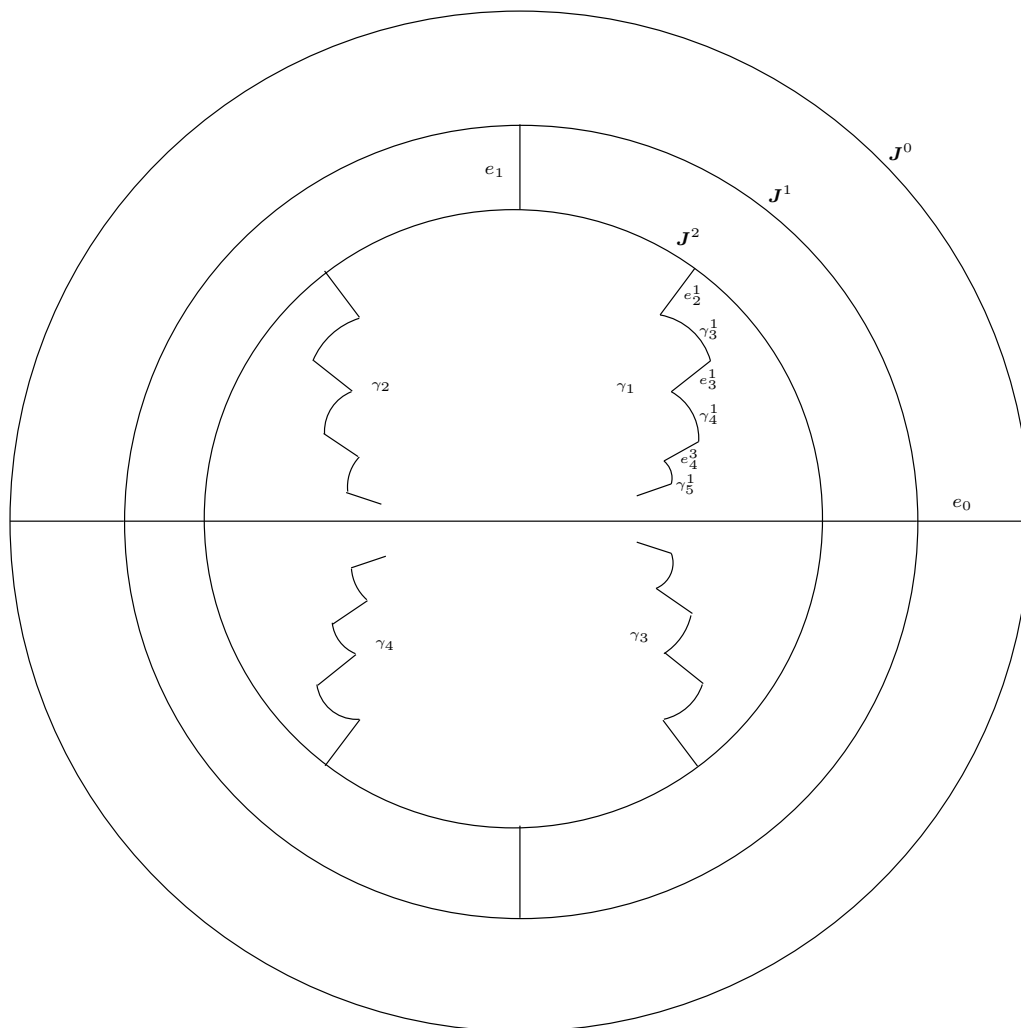

FIGURE 21. The first few segments of the paths, γ_i .

Notice that if the degree of R is two, then e_1 consists of exactly two components, and if the degree of R is greater than two, e_1 consists of four components. We repeat this construction in each fundamental annulus: for $i = 1, \dots, N$, we let e_i the union of components of $R^{-i}(e_0)$ with the property that there exists a path in $\mathbf{J}^i \setminus (\overline{\mathbf{J}^{i+1}} \cup R^{-i}(e_0))$ that connects e_i^j with

$J^i \setminus J^{i+1}$. For all $i > 1$, e_i consists of four components. It is useful to think of these as the components of the $R^{-i}(J^0 \setminus J^1)$ that lie closest to, but not on, the real line. For $i = 1, \dots, N$, we let $\alpha_i \subset \partial J^i$ be the union of the two shortest paths, α_i^1, α_i^2 , each crossing the real line that connect two points of ∂e_i . For $i = 1, \dots, N$, we let $\gamma_i \subset \alpha_i$ be the union of shortest arcs that connect ∂e_i with ∂e_{i+1} . Then for $i \geq 3$, γ_i is a union of four disjoint connected arcs, $\gamma_i^j, j \in \{1, 2, 3, 4\}$ and $\cup_{j=1}^4 \gamma_i^j = \gamma_i$. We have that

$$e_2 \cup \bigcup_{i=3}^N \{\gamma_i, e_i\}$$

is a union of four disjoint paths that connect ∂J^2 with ∂J^{N+1} . We will need to adjust this construction below to deal with specific cases.

To fix notation, for $i = 2, \dots, N$, we let e_i^1, e_i^2 be the components of e_i that are contained in the upper half-plane, and we let e_i^3, e_i^4 be the components that are contained in the lower half-plane. We will also label the components so that for all $j \in \{1, 2, 3, 4\}$ we have that e_i^j is connected to e_{i+1}^j by the component γ_{i+1}^j of γ_{i+1} . For $i \geq 2$ and $j \in \{1, 2, 3, 4\}$ we let $v_i^j = e_i^j \cap \partial J^i$ and $w_i^j = e_i^j \cap \partial J^{i+1}$. Moreover, we will label the components so that e_i^1 is connected with e_i^3 by α_i^1 and e_i^2 is connected with e_i^4 by α_i^2 .

Let us start by explaining the proof in two cases when we have bounded geometry and when there is just one critical point. We will then explain how to extend the proof to the case the $R: J^1 \rightarrow J^0$ is monotone, and finally to the general multimodal cases. We will define the constant separating the big and bounded geometry cases, when we treat the cases when $|J^0|$ is much bigger than $|J^1|$.

We divide the proof into the following types of returns. Suppose that c is a critical point of F , I is a nice interval and $R: I^1 \rightarrow I$ is the first return mapping. We say that the return is *high* if $c \in R(I^1)$ and otherwise we say that the return is *low*.

Case 1: Suppose that $R: J^1 \rightarrow J^0$ is unimodal mapping with a low return and $|J^0|/|J^1|$ is bounded. In this case, $R: J^1 \rightarrow J^0$ has no fixed points on the real line, and $R(J^1) \subset J^0 \setminus J^{N+1}$.

Step 1: Decomposing J^0 . See Figure 3 for a sketch of the decomposition. First extend the staircase arcs that we have already constructed by an extra step. For $k = 2, \dots, \text{degree}(R)$, let \mathbf{W}_k index the components of $R^{-1}(J^{N+1})$. Let e_{N+1} be union of the components of $R^{-1}(e_N)$ that can be connected to $\mathbb{R} \setminus \{0\}$ by a path in $J^{N+1} \setminus (R^{-1}(e_N) \cup \overline{R^{-1}(J^{N+1})})$. Then e_{N+1} consists of four disjoint components $e_{N+1}^1 \cup e_{N+1}^2 \cup e_{N+1}^3 \cup e_{N+1}^4$ each connecting ∂J^{N+1} with some \mathbf{W}_k . We let $\alpha_{N+1} \subset \partial J^{N+1}$ be the union of the two shortest paths, $\alpha_{N+1}^1, \alpha_{N+1}^2$, each crossing the real line that connect two points of ∂e_{N+1} , and we let γ_{N+1} be the union of the four shortest disjoint paths in α_{N+1} that do not intersect the real line and connect ∂e_N with ∂e_{N+1} . We label the components of these sets so that for $j \in \{1, 2, 3, 4\}$

$$\gamma_j = e_3^j \cup \bigcup_{i=4}^{N+1} \{\gamma_i^j \cup e_i^j\}$$

is a path connecting ∂J^3 with $\cup_k \partial \mathbf{W}_k$.

A definite neighbourhood of the critical value. We will now construct a definite neighbourhood of the critical value. See Figure 23 and 25. We need to construct a region with bounded geometry and moduli bounds in the upper half plane that separates a $X_2 \ni c$ from X_3 , in

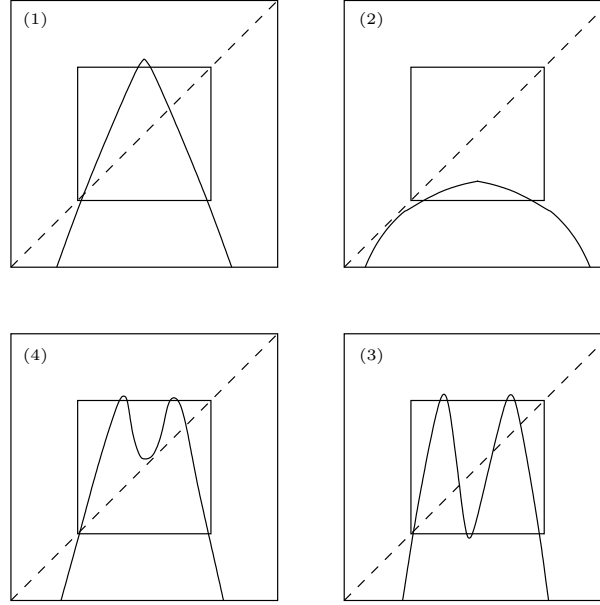

FIGURE 22. Types of returns in the setting of long cascades, clockwise from the top left: (1) a unimodal high return, (2) a unimodal low return, (3) a high return followed by a high return, (4) a high return followed by a low return.

the language of the qc\bg partition. To do this, we construct a definite neighbourhood of the critical value, where we choose the neighbourhood depending on its position. We will use this idea in other cases as well.

Recall that $\mathbf{J}^0 = \mathbf{I}_n^{\mathbf{Z}^0}$ for some n , and let $\mathbf{B}'_0 = \mathbf{I}_n^{\mathbf{Z}^0} \setminus \mathbf{I}_n^-$, see Lemma 5.6. There are two components of $R^{-(N+1)}(\mathbf{B}'_0) \setminus e_{N+1}$ that intersect the real line. Let \mathbf{B}'_1 be the component of $R^{-(N+1)}(\mathbf{B}'_0) \setminus e_{N+1}$ that intersects the real line with the property that the region \mathbf{M}'_1 bounded by $\partial\mathbf{B}'_1 \cup e_{N+1} \cup \gamma_{N+1} \cup e_N \cup \alpha_N$ contains the critical value. Notice that \mathbf{B}'_1 is mapped onto \mathbf{B}'_0 by a mapping with bounded degree and small dilatation, so \mathbf{B}'_1 is a rectangle with bounded modulus, $m \geq 1$, and there exists $K' \geq 1$ such that each arc of the boundary of \mathbf{B}'_1 is a K' -quasiarc. If \mathbf{M}'_1 does not contain the critical point, set $\mathbf{B}_1 = \mathbf{B}'_1$ and $\mathbf{M}_1 = \mathbf{M}'_1$. Otherwise, if \mathbf{M}'_1 contains the critical point, then the critical value is not close to $\partial\mathbf{J}^{m+1}$, and we let \mathbf{B}_1 be the rectangle bounded by $\partial\mathbf{J}^{N+1} \cup e_N \cup R^{-(N+1)}(\partial\mathbf{I}_n^+)$ that is closest to the critical value, and we let \mathbf{M}_1 be the region bounded by $\partial\mathbf{B}_1 \cup e_N \cup \gamma_N \cup e_{N-1} \cup \alpha_{N-1}$. Let $b_1 = \partial\mathbf{B}_1 \cap \partial\mathbf{J}^{N+1}$, let b_2 and b_4 be the components of $\partial\mathbf{B}_1 \cap \bar{e}_{N+1}$, and let $b_3 = \partial\mathbf{B}_1 \setminus (b_1 \cup b_2 \cup b_4)$. Let $\phi_{\mathbf{B}_1} : \mathbf{B}_1 \rightarrow [0, 1] \times [0, 1]$ be a K'' -qc uniformization of \mathbf{B}_1 that maps \mathbf{B}_1 onto $[0, 1] \times [0, 1]$, where K'' -depends only on m , with the property that it maps \bar{b}_1 to $\{1\} \times [0, 1]$ and \bar{b}_3 to $\{0\} \times [0, 1]$. Let us subdivide \mathbf{B}_1 into $\mathbf{B} = \phi_{\mathbf{B}_1}^{-1}((1/2, 1] \times [0, 1])$ and $\mathbf{B}' = \phi_{\mathbf{B}_1}^{-1}[0, 1/2] \times [0, 1]$. Let \mathbf{M} be the region bounded by bounded by $\partial\mathbf{B} \cup e_{N+1} \cup \gamma_{N+1} \cup e_N \cup \alpha_N$. Observe that we can carry out this construction for R and \tilde{R} simultaneously to produce corresponding neighbourhoods of the critical point for each map.

Let Γ_1 be the region that intersects the real line and is disjoint from the critical point that is bounded by $\partial\mathbf{M} \cup \gamma \cup \partial\mathbf{J}^3$, and let $\Gamma_2 = \tau(\Gamma_1)$ where τ is the symmetry about the even critical point. Let $\Gamma = \Gamma_1 \cup \Gamma_2$. We take $\mathbf{N} = \Gamma \cup R^{-1}(\mathbf{M})$.

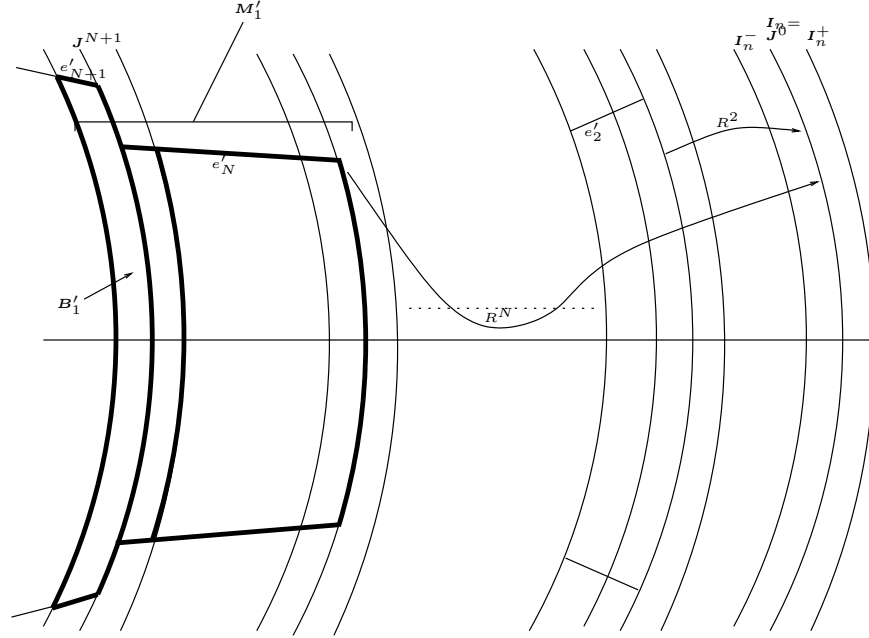

FIGURE 23. Choosing a definite neighbourhood of the critical value. The figure shows one monotone branch of R . The critical value is contained in M'_1 . Depending on its position, we choose the left hand boundary of M'_1 , whose preimage under R is off the real line.

Let us now construct a neighbourhood $N' \supset N$, see Figure 24. As before, we will construct staircases which will form part of the boundary of N' . They are constructed in the same way as at the start of the proof, but the construction is shifted by one level. For $i = 2, \dots, N$, let e'_i be the components of $R^{-(i-1)}(J^1 \setminus J^3)$ that are contained in $J^i \setminus (J^{i+1} \cup \mathbb{R})$, and that can be connected to $J^i \setminus J^{i+1}$ by a path in $J^i \setminus (J^{i+1} \cup \overline{R^{-(i-1)}(J^1 \setminus J^2)})$. For $i = N + 1$, let e'_{N+1} be union of the components of $R^{-1}(e'_N)$ that can be connected to $\mathbb{R} \setminus \{0\}$ by a path in $J^{N+1} \setminus (R^{-1}(e'_N) \cup \overline{R^{-1}(J^{N+1})})$. For $i = 2, \dots, N$, e'_i connects ∂J^i with ∂J^{i+1} , and e'_{N+1} connects ∂J^{N+1} with some W_k . Let $v'_i = \partial e'_i \cap \partial J^i$ and $w'_i = \partial e'_i \cap \partial J^{i+1}$. For $i = 1, 2, \dots, N + 1$ let $\gamma'_i \in \partial J^i$ be the union of shortest arcs in ∂J^i connecting w'_{i-1} with v'_i . Let

$$\gamma' = e'_3 \cup \bigcup_{i=3}^N \{\gamma'_i \cup e'_{i+1}\}.$$

γ' consists of four arcs connecting ∂J^3 to $R^{-1}(J^{N+1})$. Let us label the four components of $\gamma'_1, \gamma'_2, \gamma'_3, \gamma'_4$ of γ' so that for $j \in \{1, 2, 3, 4\}$ we have that $\gamma_j \cap \gamma'_j \neq \emptyset$.

Now we will close off the region around the critical value, see Figure 25. We will give the construction in the case when the critical value is not contained in $R^{-N}(I_n^-)$ - this corresponds to the case when it may be close to ∂J^{N+1} . The modifications to the construction when the critical value is in $R^{-N}(I_n^-)$ are the same as in the construction of N . First, we extend the domain B_1 constructed above: As before, there are two components of $R^{-(N+1)}(B_0) \setminus e'_{N+1}$ that intersect the real line. Let B'_1 be the component of $R^{-(N+1)}(B_0) \setminus e'_{N+1}$ that intersects the real line with the property that the region M' bounded by $\partial B'_1 \cup e'_{N+1} \cup \gamma'_{N+1} \cup e'_N \cup \alpha'_N$ contains the critical value and not the critical point. Observe that $B'_1 \setminus B_1$ consists of three

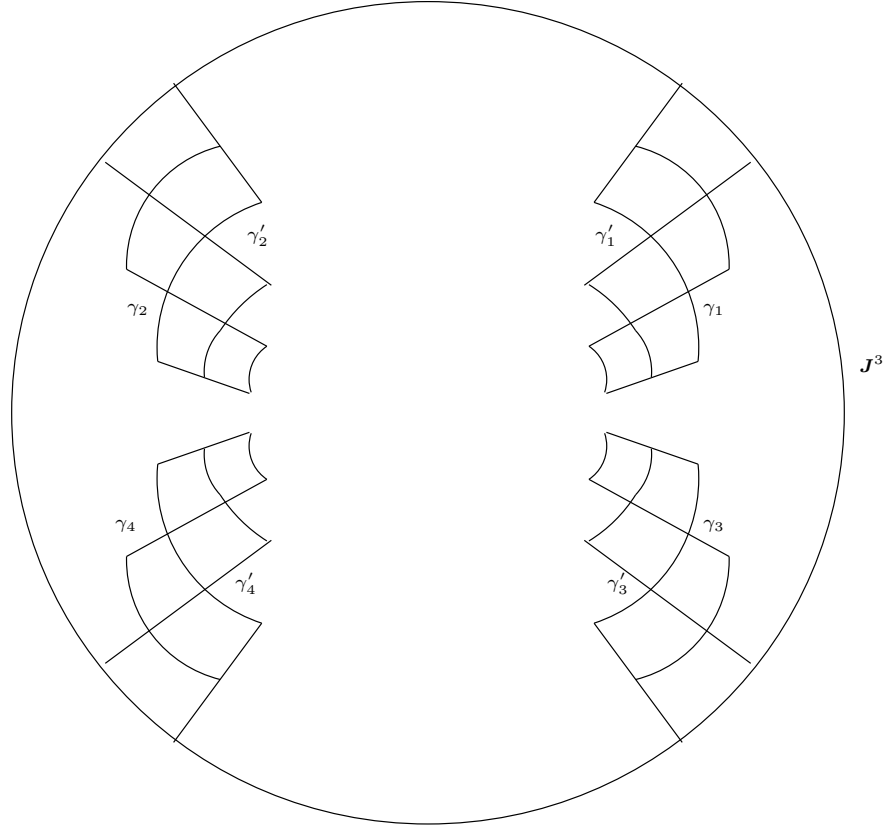

FIGURE 24. The first few components of $\mathbf{N}' \setminus \mathbf{N} \subset X_1$ refer to Figure 3.

topological squares with bounded geometry whose boundaries consist of arcs in α'_{N+1} , the components of $\partial \mathbf{J}^{N+1} \setminus \bar{e}'_{N+1}$ that intersect the real line. $\partial \mathbf{B}'_1 \setminus \partial \mathbf{B}_1$, e_{N+1} and e'_{N+1} , and $\phi_{B_1}^{-1}(\{1/2\} \times [0, 1])$, and that $\mathbf{M}' \setminus \mathbf{M} = (\mathbf{B}'_1 \setminus \mathbf{B}_1) \cup \mathbf{B}'$. Let Γ'_1 be the region that intersects the real line and disjoint from the critical point that is bounded by $\partial \mathbf{B}'_1 \cup \gamma' \cup \partial \mathbf{J}^3$, and let $\Gamma'_2 = \tau(\Gamma'_1)$ where τ is the symmetry about the even critical point. Let $\Gamma' = \Gamma'_1 \cup \Gamma'_2$. Let $\mathbf{N}' = \Gamma' \cup R^{-1}(\mathbf{M}')$.

The shape of Γ' is dictated by the Yoccoz Lemma: Let \mathbf{Z}_2 be a topological rectangle bounded by $e_2 \cup \partial \mathbf{J}^2 \cup \partial \mathbf{J}^3 \cup (J^2 \setminus J^3)$ whose intersection with the real line is a component of $J^2 \setminus J^3$ - a fundamental domain for R . For $i \leq N - 2$, let \mathbf{Z}_{i+2} be a component of $R^{-i}(\mathbf{Z}_2)$ that intersects the real fundamental domain $J^{i+2} \setminus J^{i+3}$. Then \mathbf{Z}_{i+2} is mapped with bounded dilatation onto \mathbf{Z}_2 by R^i . So since the height and width of \mathbf{Z}_2 are both comparable to $J^2 \setminus J^3$, the height and width of \mathbf{Z}_i are both comparable to the length of the real trace of \mathbf{Z}_i , a component of $J^i \setminus J^{i+1}$. By the Yoccoz Lemma

$$|\mathbf{Z}_i| \asymp \frac{|J^0|}{\min\{i^2, (N - i)^2\}}.$$

So we see that near the middle of a long saddle-node cascade, the region Γ' is pinched close to the real line.

Now we are ready to describe the sets X_0 , X_1 , X_2 and X_3 . Set

$$X_1 = (\mathbf{N}' \setminus \mathbf{N}) \cup (J^3 \setminus (J^4 \cup \mathbf{N}')).$$

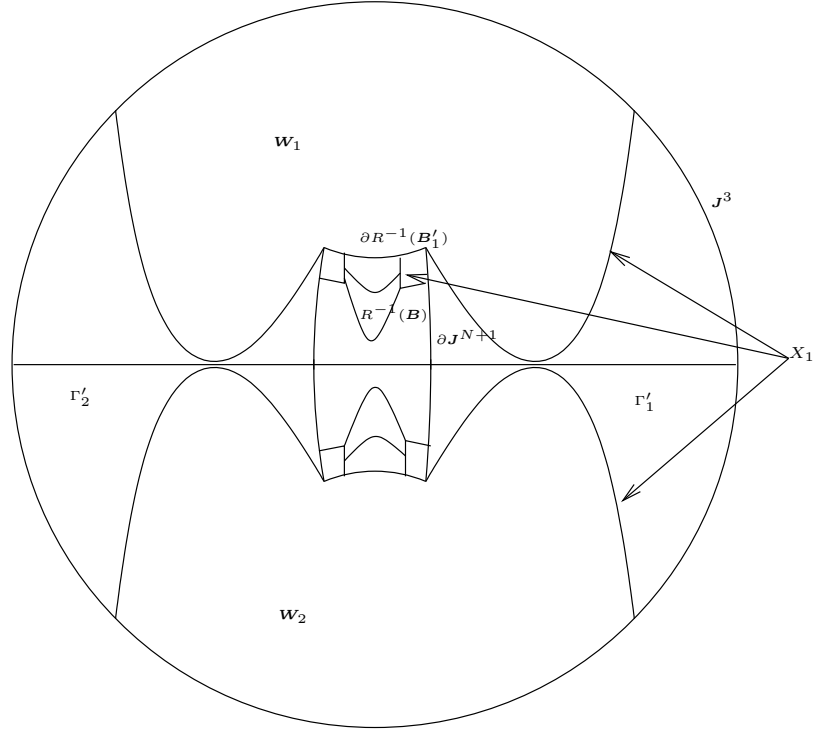

FIGURE 25. The components \mathbf{W}_1 and \mathbf{W}_2 of X_3 and detail of the construction around the critical point. This picture does not show the detail of X_1 . Refer to Figures 3 and 24 for the detail of X_1 . The complex fixed points of R are contained in $\mathbf{W}_1 \cup \mathbf{W}_2$.

From the construction above, we have that X_1 is a union of combinatorially defined topological squares with bounded geometry, and moduli bounds as in conclusion (3) from Theorem 7.5. To be definite, let us suppose that \mathbf{S} is contained in the upper half-plane. Then \mathbf{S} is a pullback of a component of X_1 that is either bounded by $e_i \cup e'_i$ and the shortest arcs in $\partial \mathbf{J}^i$ and $\partial \mathbf{J}^{i+1}$ connecting the end points of e_i and e'_i , where $i = 3$ or 4 . Let \mathbf{S}' denote this component. It follows from the complex bounds, Proposition 5.13, that \mathbf{S}' has bounded geometry. We also have that it is contained in the set $\hat{\mathbf{S}}'$ which is contained in the upper half-plane and is bounded by a component of $R^{-1}(J^1 \setminus J^4)$ lying in $\mathbb{C} \setminus \mathbb{R}$, a component of $J^2 \setminus J^5 \subset \mathbb{R}$, and two arcs contained in $\partial \mathbf{J}^2$, $\partial \mathbf{J}^5$, respectively. We have from the complex bounds that $\text{mod}(\hat{\mathbf{S}}' \setminus \mathbf{S}')$ is bounded away from zero. Moreover, the mapping from \mathbf{S} onto \mathbf{S}' extends to a mapping with small dilatation onto $\hat{\mathbf{S}}'$. Hence there exists $\delta' > 0$ depending only on the complex bounds such that \mathbf{S} has δ' -bounded geometry and $\text{mod}(\mathbf{J}^0 \cap \mathbb{H}^+ \setminus \mathbf{S}) > \delta$. It follows from this and the construction near the critical value that $R^{-1}(\mathbf{M}' \setminus \mathbf{M})$ has universally bounded geometry and moduli bounds as well. Finally, we set

- $X_2 = \mathbf{N} \cup (\mathbf{J}^0 \setminus \mathbf{J}^3)$, and
- X_3 to be the components of $\mathbf{J}^0 \setminus \overline{X_1 \cup X_2}$.

There exists a constant $K_1 \geq 1$ such that each component of X_3 is a K_1 -quasidisk. To show this we use Lemma 7.12. Let \mathbf{W} be a component of X_3 . The boundary of \mathbf{W} consists of four arcs. $v_1 \subset \partial \mathbf{J}^4$, $v_2 \subset \Gamma'_1$, $v_3 \subset \partial R^{-1}(\mathbf{B}'_1)$ and $v_4 \subset \Gamma'_2$. Since \mathbf{J}^4 is a K'_0 -quasidisk, we have that v_1 is a K''_1 -quasiarc. Similarly, v_3 is a K''_1 -quasiarc, since $\partial R^{-1}(\mathbf{B}'_1)$ is a

K'_0 -quasiarc. We also have that v_2 and v_4 are K''_0 -quasiarcs: if $\zeta \subset \gamma'_i$ is a subarc of γ'_i , then ζ is a union of preimages of real fundamental domains and the boundaries of puzzle pieces that are K'_0 -quasiarcs, the intersections of these paths do not contain any cusps, so the only interesting case is when $|x - y|$ is small, and ζ contains many steps in the staircase. But now the statement follows since $\Gamma' \setminus \Gamma$ consists of topological squares with bounded geometry. Since \mathbf{J}^4 is δ' -nice for some $\delta' > 0$, universal, we have that $\text{dist}(v_1, v_3)$, $\text{diam}(v_2)$, $\text{diam}(v_4)$ are comparable to $\text{diam}(\mathbf{J}^0)$, and Lemma 7.10 and the same analysis as above imply that $\text{diam}(v_1)$, $\text{diam}(v_3)$, $\text{dist}(v_2, v_4)$ are comparable to $\text{diam}(\mathbf{J}^0)$. It remains to verify the Ahlfors-Beurling Criterion on adjacent components of $\partial\mathbf{W}$. Consider $v_1 \cup v_2$. Suppose that $z_1, z_2 \in v_1 \cup v_2$. Let $\gamma_{[z_1, z_2]}$ be the path connecting z_1 and z_2 in $v_1 \cup v_2$. We can assume that $z_1 \in v_1$ and $z_2 \in v_2$. If $v_2 \in \mathbf{J}^5$, then $\text{diam}(\gamma_{[z_1, z_2]})$ and $|z_1 - z_2|$ are comparable to $\text{diam}(\mathbf{J}^0)$, so we can assume that $z_2 \in e_4$, but now e_4 is a preimage of an interval in $\mathbf{J}^0 \setminus \mathbf{J}^1$ that meets $\partial\mathbf{J}^0$ at a definite angle. So $\text{diam}(\gamma_{[z_1, z_2]})$ and $|z_1 - z_2|$ are comparable. The similar arguments show that the Ahlfors-Beurling Criterion holds on the arcs $v_1 \cup v_4$, $v_2 \cup v_3$ and $v_3 \cup v_4$.

It is important to observe that the boundary of X_3 consists of pullbacks of the real line and boundaries of puzzle pieces, so that for each component of X_3 there is a corresponding component of \tilde{X}_3 . The set X_0 is the union of the piecewise smooth boundaries of these regions.

Step 2: Constructing the quasiconformal mapping H . We define H on X_2 dynamically. For $z \in \Gamma \cup \mathbf{B}$, let $0 < k_z \leq N + 1$ be so that $R^{k_z}(z) \in \tilde{\mathbf{J}}^0 \setminus \mathbf{J}^1$, and define $H(z)$ by $H_0 \circ R^{k_z}(z) = \tilde{R}^{k_z} \circ H(z)$. Let \mathbf{P} be the component of $\text{Dom}^*(\mathbf{J}^0)$ that contains $R^{k_c}(c)$ (the image of the critical point when it escapes through the cascade). For $z \in \mathbf{R}^{-1}(\mathbf{M}) \setminus R^{-k_c}(\mathbf{P})$, We define H in $\mathbf{R}^{-1}(\mathbf{M})$ by $\tilde{R} \circ H(z) = H \circ R(z)$. By applying the inductive step, by the conclusion of Theorem 7.5 for central cascades that are lower in the partial ordering, together with the argument used to prove the Real Spreading Principle, we have that there exists $K' \geq 1$ and $\delta' > 0$ such that $H|_{\mathbf{P}}$ is a (K', δ') -qc mapping. Thus by the QC Criterion, we have that there is a K'' -qc mapping that agrees with the boundary marking on $R^{-k_c}(\mathbf{P})$. Observe that this procedure defines H on $\partial X_1 \cap \partial X_2 = \cup_{i=2}^{N+1} \{v'_i\}$.

Let us now define H on X_3 . Let \mathbf{W} be a component of X_3 . Since \mathbf{W} and $\tilde{\mathbf{W}}$ are K_1 -quasidisks, there exist K_1 -qc mappings $\phi_{\mathbf{W}}, \phi_{\tilde{\mathbf{W}}}: \mathbb{C} \rightarrow \mathbb{C}$ such that $\phi_{\mathbf{W}}(\mathbb{D}) = \mathbf{W}$, and $\phi_{\tilde{\mathbf{W}}}(\mathbb{D}) = \tilde{\mathbf{W}}$. We start by partially defining a mapping $h_{\mathbf{W}}$ from $\partial\mathbf{W}$ to $\partial\tilde{\mathbf{W}}$. Observe that $w_i = v'_{i+1}$ and that $\gamma \cap \gamma' = \cup_{i=2}^{N+1} \{v'_i\}$. Observe that we can define $h_{\mathbf{W}}$ arbitrarily on $\partial\mathbf{J}^4 \cap \mathbf{W}$, so that it maps $\partial\mathbf{J}^4 \cap \mathbf{W}$ to $\partial\tilde{\mathbf{J}}^4 \cap \tilde{\mathbf{W}}$. We set $h_{\mathbf{W}}(v'_i) = H(v'_i) = H(w_{i-1})$ where H is the mapping on \tilde{X}_2 already defined, and we define $h_{\mathbf{W}}(w'_i) = \tilde{w}'_i$.

By Theorem A [vSV1], we have that there exists $\delta_0 > 0$, universal, so that $(1 + \delta_0)J^1 \subset J^0$. Moreover, since $|J^1| \asymp |J^0|$, we have that each of the components of $J^0 \setminus J^1$ have length comparable to $|J^0|$, and it follows from Lemma 7.10, there exists $\delta' > 0$ such that $|R(c) - c| > \delta'|J^0|$. So we may apply the Yoccoz Lemma.

Suppose that x, y, z are three points lying in $\cup_{i=2}^{N+1} \{v'_i, w'_i\}$. Observe that each e'_i bounds a rectangle Z'_i in the upper half-plane bounded by $J^i \setminus J^{i+1}$ and two arcs in α_i and α_{i+1} , respectively. Moreover, this rectangle is mapped with bounded dilatation by R^{i-3} onto a rectangle Z'_4 in the upper half-plane contained in $J^4 \setminus J^5$ and bounded by e'_4 and two arcs in α_4 and α_5 . Since we have that the distance between the corners of Z'_4 are all comparable,

we have the same for the corners of $Z_i^{1'}$. Hence have that $|w'_i - v'_i|$ and $|v'_i - w'_{i-1}|$ are both comparable to $\frac{|J^0|}{\min\{i^2, (N-i)^2\}}$.

For $i \leq N$, let Δ_i be the component of $J^i \setminus J^{i+1}$ containing $R^{N-i+1}(c)$. Let B_1 be the component of $J^0 \setminus J^{N+1}$ that contains $R(c)$. By the Yoccoz Lemma, we have that there exists a constant C for $1 \leq i \leq N$,

$$\frac{1}{C} \frac{|B_1|}{\min\{i, N-i\}^2} \leq |\Delta_i| \leq C \frac{|B_1|}{\min\{i, N-i\}^2}.$$

Moreover, we have the same estimates for the objects marked with tilde, with the same C (since $|J^1|/|J^0|$ is comparable to $|\tilde{J}^1|/|\tilde{J}^0|$). Suppose that $w \in \Delta_{j_w}$, $w \in \{x, y, z\}$. Without loss of generality, we can assume that Δ_{j_x} lies to the left of Δ_{j_y} , which lies to the left of Δ_{j_z} , and that $j_z \leq j_y \leq j_x$. Then we have that

$$\frac{1}{|B_1|} \sum_{k=j_y+1}^{j_x-1} |\Delta_k| \leq C \sum_{k=j_y+1}^{j_x-1} \frac{1}{\min\{i, N-i\}^2} \leq C^2 \frac{1}{|\tilde{B}_1|} \sum_{k=j_y+1}^{j_x-1} |\tilde{\Delta}_k|.$$

Similarly we have that

$$\frac{1}{C^2} \frac{1}{|\tilde{B}_1|} \sum_{k=j_y+1}^{j_x-1} |\tilde{\Delta}_k| \leq \frac{1}{|B_1|} \sum_{k=j_y+1}^{j_x-1} |\Delta_k|,$$

and

$$\frac{1}{C^2} \frac{1}{|\tilde{B}_1|} \sum_{k=j_z+1}^{j_y-1} |\tilde{\Delta}_k| \leq \frac{1}{|B_1|} \sum_{k=j_z+1}^{j_y-1} |\Delta_k| \leq C^2 \frac{1}{|\tilde{B}_1|} \sum_{k=j_z+1}^{j_y-1} |\tilde{\Delta}_k|.$$

Thus we have that

$$\frac{|\tilde{x} - \tilde{y}|}{|\tilde{y} - \tilde{z}|} = \frac{\sum_{k=j_2+1}^{j_1-1} |\tilde{\Delta}_k|}{\sum_{k=j_3+1}^{j_2-1} |\tilde{\Delta}_k|} \asymp \frac{\frac{|\tilde{B}_1|}{|B_1|} \sum_{k=j_2+1}^{j_1-1} |\Delta_k|}{\frac{|\tilde{B}_1|}{|B_1|} \sum_{k=j_3+1}^{j_2-1} |\Delta_k|} = \frac{|x - y|}{|y - z|}.$$

Thus $h_{\mathbf{W}}$ is (C, p) -qs on $\cup_{i=2}^{N+1} \{v'_i, w'_i\}$, where $C > 0, p \geq 1$ depend only on $|J^0|/|J^1|$, by way of Lemma 7.10 and the Yoccoz Lemma.

Let us define a mapping $h': \partial\mathbb{D} \rightarrow \partial\mathbb{D}$ as follows. For $z \in \cup_{N=2}^{N+1} \phi_{\mathbf{W}}^{-1}\{v'_i, w'_i\}$ we define $h'(z) = \phi_{\tilde{\mathbf{W}}}^{-1} \circ H \circ \phi_{\mathbf{W}}(z)$. Thus we have that h' is κ' -quasisymmetric on $\cup_{i=2}^{N+1} \phi_{\mathbf{W}}^{-1}\{v'_i, w'_i\}$, where $\kappa' \geq 1$ depends only on K_1 and κ . Let us show that $\cup_{i=2}^{N+1} \phi_{\mathbf{W}}^{-1}\{v'_i, w'_i\}$ is M -relatively connected. First, choose $x \in \cup_{i=2}^{N+1} \phi_{\mathbf{W}}^{-1}\{v'_i, w'_i\}$, and $r > 0$ so that $\bar{B}(x, r) \neq S$. Since the gaps between adjacent points in $\cup_{i=2}^{N+1} \phi_{\mathbf{W}}^{-1}\{v'_i, w'_i\}$ are governed by the Yoccoz Lemma, we have S is M -relatively connected at x with $M \asymp 2$. Since $\phi^{-1}(\partial J^4) \cup \cup_{i=2}^{N+1} \phi_{\mathbf{W}}^{-1}\{v'_i, w'_i\}$ is M -relatively connected, by Proposition 3.3 we can extend h' to a κ'' -qs mapping $h': \partial\mathbb{D} \rightarrow \partial\mathbb{D}$. Thus by Ahlfors-Beurling it extends to a \hat{K}_2 -qc mapping $H': \mathbb{D} \rightarrow \mathbb{D}$ and we thus we have that $h_{\mathbf{W}}: W \rightarrow \tilde{W}$ extends to a \hat{K} -qc mapping,

$$H_{\mathbf{W}} = \phi_{\tilde{\mathbf{W}}} \circ H' \circ \phi_{\mathbf{W}}^{-1}: \mathbf{W} \rightarrow \tilde{\mathbf{W}}$$

that agrees with H where ever they are both defined.

Finally, we define the mapping on X_1 . Let \mathbf{S} be a component of X_1 , and let $\tilde{\mathbf{S}}$ be the corresponding component of \tilde{X}_1 . Then \mathbf{S} and $\tilde{\mathbf{S}}$ are bounded by piecewise smooth quasiarcs. The mapping H is already defined on some components of $\partial\mathbf{S}$. We leave H unchanged

where it is already defined, and extend it to a homeomorphism from $\partial\mathcal{S}$ to $\partial\tilde{\mathcal{S}}$, and then to a homeomorphism from the interior of \mathcal{S} to the interior of $\tilde{\mathcal{S}}$, so that it satisfies (2.1) on $\partial\mathcal{S}$.

Case 2: Suppose that $R: J^1 \rightarrow J^0$ is a unimodal mapping with a high return and $|J^0|/|J^1|$ is bounded. In this case, R has an orientation preserving fixed point $\beta \in J^{N+1}$. As usual $\tau(\beta)$ denotes the symmetric point under the symmetry about the even critical point. We have that $R(c) \in J^N \setminus [\beta, \tau(\beta)]$ and $c \in R((\beta, \tau(\beta)))$.

Step 1: Decomposing \mathbf{J}^0 . Let us start by decomposing \mathbf{J}^0 into the sets X_0, X_1, X_2, X_3 . See Figure 26 for a rough picture of the decomposition. In this case, the staircases consist of infinitely many $e_i, i = 3, 4, \dots$, pullbacks of the real fundamental domains $J^0 \setminus J^1$, or $J^1 \setminus J^2$, and subarcs γ_i of the boundaries of certain puzzle pieces that intersect the real line.

Let us choose the puzzle pieces whose boundaries will contain the γ_i . For $0 \leq j \leq N + 1$, let $\mathbf{U}^j = \mathbf{J}^j$; these are exactly the puzzle pieces in the principal nest. For $j > N + 1$, let \mathbf{U}^j be the components of $R^{-j}(\mathbf{J}^0)$ that contain β and $\tau(\beta)$. These are no longer puzzle pieces in the principal nest (in particular, they do not contain the escaping critical point); they are the “outermost” pullbacks of \mathbf{J}^{N+1} by R that intersect the real line, and they are mapped diffeomorphically onto \mathbf{J}^{N+1} . For $i \in \mathbb{N}$, we let e_i the union of components e_i^j of $R^{-i}(e_0)$ with the property that there exists a path in $\mathbf{U}^i \setminus (\bar{\mathbf{U}}^{i+1} \cup R^{-i}(J^0))$ that connects e_i^j with $\mathbf{U}^i \setminus (\mathbf{U}^{i+1} \cup [\beta, \tau(\beta)])$. As before, for all $i > 1$, e_i consists of four components. For $i \in \mathbb{N}$, we let $\alpha_i \subset \partial\mathbf{U}^i \setminus [\beta, \tau(\beta)]$ be the shortest path crossing the real line that connects two points of ∂e_i . We let $\gamma_i \subset \alpha_i$ be the union of shortest arcs that connect ∂e_i with ∂e_{i+1} . Then for $i \geq 3$, γ_i is a union of four disjoint connected arcs $\gamma = \cup_{j=1}^4 \gamma_i^j$. We have that

$$e_3 \cup \bigcup_{i=3}^{\infty} \{\gamma_i, e_i\}$$

union of four disjoint paths that connect $\partial\mathbf{J}^3$ with $\{\beta, \tau(\beta)\}$. The arcs $\partial\mathbf{J}^3 \cup \gamma$ bound three regions in the complex plane. Let Γ be the union of the two regions bounded by $\partial\mathbf{J}^3$ and γ that do not intersect $(\beta, \tau(\beta))$, see Figure 26. We obtain a neighbourhood of the critical point given by $\text{Comp}_c R^{-1}(\Gamma)$.

We construct the neighbourhood $\Gamma' \supset \Gamma$ using staircases exactly as before. For $i = 2, \dots, \infty$, let e'_i be the components of $R^{-(i-1)}(J^1 \setminus J^2)$ that are contained in $\mathbb{C} \setminus \mathbb{R}$, and that are not separated from the real line. For $i \in \{2, 3, \dots\}$, e'_i connects $\alpha'_i \subset \partial\mathbf{U}^i$ with $\alpha'_{i+1} \subset \partial\mathbf{U}^{i+1}$. Let $v'_i = e'_i \cap \alpha'_i$ and $w'_i = e'_i \cap \alpha'_{i+1}$. For $i = 1, 2, \dots$, let $\gamma'_i \in \alpha'_i$ be the union of arcs connecting w'_{i-1} with v'_i . Let

$$\gamma' = e'_3 \cup_{i=4}^{\infty} \{e'_i \cup \gamma'_i\}.$$

γ' consists of four arcs connecting $\partial\mathbf{J}^3$ to $\{\beta, \tau(\beta)\}$. Let Γ' be the union of the regions bounded by $\partial\mathbf{J}^3$ and γ' that intersect the $J^3 \setminus J^4$. Now, we pull $\Gamma \subset \Gamma'$ back by one iterate of R . See Figure 26 for the detail of the construction up to this point.

Let us now partition \mathbf{J}^0 ; this partition will serve as a qc\bg partition. We take

$$X_2 = (\mathbf{J}^0 \setminus \mathbf{J}^3) \cup \Gamma \cup \text{Comp}_c R^{-1}(\Gamma),$$

$$X_3 = \mathbf{J}^4 \setminus \left(\Gamma \cup \text{Comp}_c R^{-1}(\Gamma') \right),$$

$$X_1 = (\mathbf{J}^3 \setminus (\mathbf{J}^4 \cup \Gamma')) \cup (\Gamma' \setminus \Gamma) \cup (R^{-1}(\Gamma') \setminus R^{-1}(\Gamma)),$$

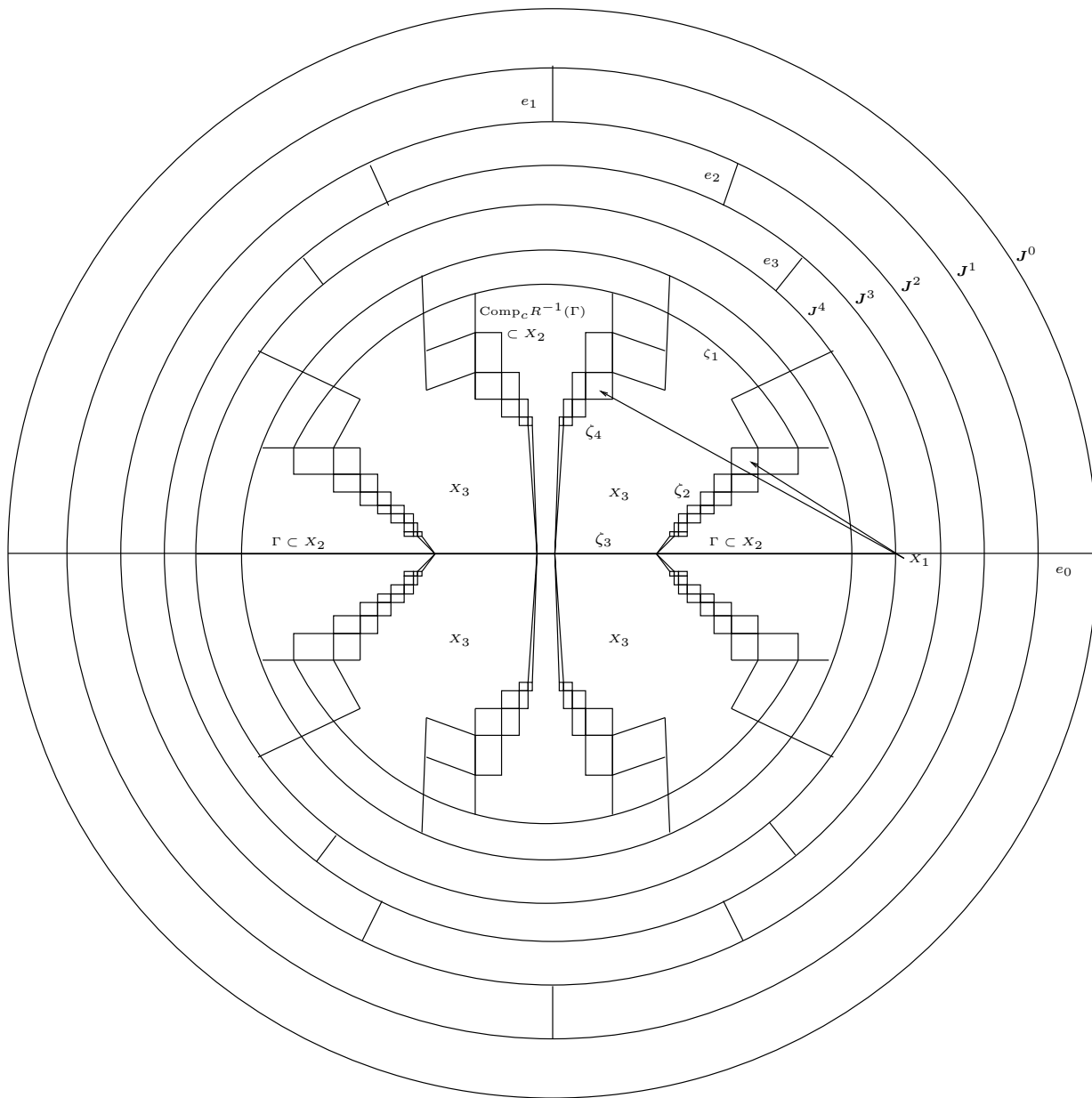

FIGURE 26. Domains around the critical point of a high return.

and the set X_0 is the union of their boundaries. To see that there exists $K_1 \geq 1$ so that each component of X_3 is a K_1 -quasidisk, we verify the conditions of Lemma 7.12. This is essentially the same as the proof in the low return case, so we only give a sketch.

Claim: X_3 is a union of quasidisks. Let \mathbf{W} be a connected component of X_3 . We can decompose $\partial\mathbf{W}$ into arcs $\zeta_1, \zeta_2, \zeta_3, \zeta_4$ where $\zeta_1 \subset \partial\mathbf{J}^4, \zeta_2 \subset \gamma', \zeta_3$ consists of an interval in the real-line and $\zeta_4 \subset \text{Comp}_c \partial R^{-1}(\Gamma')$. Since \mathbf{J}^4 is a K'_0 -quasidisk, we have that ζ_1 is a K''_0 -quasiarc, and $\text{dist}(\zeta_1, \zeta_3)$ is bounded from below. We have that $\text{dist}(\zeta_2, \zeta_4)$ is comparable to $\text{diam}(\mathbf{J}^0)$, since close to the real line, ζ_2 is close to β and ζ_4 is close to c_0 and away from the real line they are separated by topological squares with bounded geometry and diameters comparable to $\text{diam}(\mathbf{J}^0)$. It remains for us to show that ζ_2 is a K' -quasiarc, and that the

Ahlfors-Beurling Criterion is satisfied on adjacent quasiarcs. To see that ζ_2 is a K' -quasiarc, we verify the Ahlfors-Beurling Criterion. If $z_1, z_2 \in \zeta_2$, let $\gamma_{[z_1, z_2]}$ be the path between them. If $z_1, z_2 \in e_i$ for some i , then we have that $\text{diam}(\gamma_{[z_1, z_2]}) \leq C|z_1 - z_2|$ for some C since e_i is a pullback of a real interval with bounded dilatation. If $\gamma_{[z_1, z_2]} \subset \alpha_i$ for some i , then $\text{diam}(\gamma_{[z_1, z_2]}) \leq C|z_1 - z_2|$ since α_i is a pullback of a subset of $\partial\mathbf{J}^0$ with bounded dilatation. In general, we have that $\text{diam}(\gamma_{[z_1, z_2]}) \leq C|z_1 - z_2|$ since the path between z_1 and z_2 can be decomposed into e_i and pieces of α_i that intersect at approximately right angles, form the boundaries of squares with bounded geometry, and the squares bounded by $\alpha_i, \alpha_{i+1}, e_i$ and $J_i \setminus J_{i+1}$ also have bounded geometry. Similarly we can argue that the Ahlfors-Beurling Criterion holds on ζ_3 and its adjacent arcs. To see that it holds on ζ_1 and its adjacent arcs we need only observe that ζ_2 and ζ_4 intersect ζ_1 at an almost right angle, and that $\zeta_i \cap \mathbf{J}^5$ is bounded away from ζ_1 for $i = 2, 4$. \checkmark

Also, arguing in the same way as in the saddle node case, we have that X_1 is a union of topological squares with bounded geometry and moduli bounds in \mathbf{J}^0 , and in the upper half-plane. Around a component \mathbf{S}' of X_1 that is contained in $\mathbf{J}^4 \setminus \mathbf{J}^5$ we can build a topological square $\hat{\mathbf{S}}' \supset \mathbf{S}'$ such that $\text{mod}(\hat{\mathbf{S}}' \setminus \mathbf{S}')$ is universally bounded from below, and any component \mathbf{S} of X_1 is a pullback of such an \mathbf{S}' and the mapping from \mathbf{S} to \mathbf{S}' extends to a diffeomorphism with bounded dilatation onto $\hat{\mathbf{S}}'$, and the result follows.

Step 2: Constructing the quasiconformal mapping. In X_2 , the construction is identical to the one used in the low return case. Let \mathbf{P} denote the puzzle piece that contains $R^{k_c}(c)$, then for each $z \in X_2 \setminus \text{Comp}_c R^{-k_c}(\mathbf{P})$, there exists k_z such that $R^{k_z}(z) \in \mathbf{J}^0 \setminus \mathbf{J}^1$. We define $H(z)$ by $H_0 \circ R^{k_z}(z) = \tilde{R}^{k_z} \circ H(z)$. On $\text{Comp}_c R^{-k_c}(\mathbf{P})$ we define H so that it agrees with the mapping on the boundary using the QC Criterion.

Now let us define H on X_3 . Let \mathbf{W} be a component of X_3 , and let $\tilde{\mathbf{W}}$ be the corresponding set for \tilde{R} .

Claim: *There exists a \hat{K} -quasiconformal mapping $H_{\mathbf{W}}: \mathbf{W} \rightarrow \tilde{\mathbf{W}}$ such that for each $x_i \in \cup_{i=3}^{\infty} \{v'_i, w'_i\} \cup R^{-1}(\cup_{i=3}^{\infty} \{v'_i, w'_i\})$, $H_{\mathbf{W}}(x_i) = \tilde{x}_i$. We have that \mathbf{W} and $\tilde{\mathbf{W}}$ are K_1 -quasidisks. Let us start by partially defining a mapping $h_{\mathbf{W}}$ from \mathbf{W} to $\tilde{\mathbf{W}}$. For each $x_i \in \{v'_i, w'_i\}, i = 2, 3, \dots$, we set $h_{\mathbf{W}}(x_i) = \tilde{x}_i$. Pulling back once, for each point $x \in \text{Comp}_c R^{-1}(\Gamma')$ such that $R(x) \in \cup_{i=N-2}^{\infty} \{v'_i, w'_i\}$, we define $h_{\mathbf{W}}$ so that $h_{\mathbf{W}} \circ R(x) = \tilde{R} \circ h_{\mathbf{W}}(x)$. Let $\{y_i\}_{i=1}^{\infty}$ denote the set of all points not in $\partial\mathbf{J}^2$ where $h_{\mathbf{W}}$ has been defined. Take any $x, y, z \in \cup \{y_i\}_{i=1}^{\infty} \subset \partial\mathbf{W}$ arranged with y between x and z in $\partial\mathbf{W}$. Because of the linear behaviour near the β fixed point, there exist $C > 0$ and so that $\frac{|\tilde{x}-\tilde{y}|}{|\tilde{y}-\tilde{z}|} \leq C \left(\frac{|x-y|}{|y-z|} \right)^{\eta}$.*

Now we extend $h_{\mathbf{W}}$ to \mathbf{W} . Let $\phi_{\mathbf{W}}, \phi_{\tilde{\mathbf{W}}}: \mathbb{C} \rightarrow \mathbb{C}$ be \hat{K} -qc mappings of the plane such that $\phi_{\mathbf{W}}(\mathbb{D}) = \mathbf{W}$, and $\phi_{\tilde{\mathbf{W}}}(\mathbb{D}) = \tilde{\mathbf{W}}$. Arguing as in the unimodal, low return case, we have that the mapping $\phi_{\tilde{\mathbf{W}}}^{-1} \circ h_{\mathbf{W}} \circ \phi_{\mathbf{W}}$, which maps $\phi_{\mathbf{W}}^{-1}(\text{Domain}(h_{\mathbf{W}}))$ into $\partial\mathbb{D}$ is κ' -quasisymmetric, and that there exists $M \geq 1$ depending only on $|J^0|/|J^1|$ so that $\phi_{\mathbf{W}}^{-1}(\text{Domain}(h_{\mathbf{W}}))$ is an M -relatively connected subset of \mathbb{D} . So by Proposition 3.3, we have that $\phi_{\tilde{\mathbf{W}}}^{-1} \circ h_{\mathbf{W}} \circ \phi_{\mathbf{W}}$ extends to a κ'' -qs mapping from $\partial\mathbb{D}$ to itself. Thus by using the Ahlfors-Beurling extension it extends to a \hat{K}_1 -qc mapping on the unit disk, and so $h_{\mathbf{W}}$ extends to a \hat{K} -qc mapping $H_{\mathbf{W}}: \mathbf{W} \rightarrow \tilde{\mathbf{W}}$. \checkmark

Now let us extend the mappings that we have defined to X_1 . Fix a small $\delta' > 0$. Let \mathbf{S} be a component of X_1 , with corners v', w', v and w . The mapping H may already be defined at

some of the corners. We extend H to $\overline{\mathcal{S}}$, so that it is a homeomorphism and satisfies (2.1) on X_0 , which contains the boundary of each component of \mathcal{S} .

Since H is a conjugacy on the boundary of X_2 , we can pull this construction back along the two monotone branches of R . Because $J^0 \setminus \Gamma$ is contained in a Poincaré disk, $D_\theta((\beta, \tau(\beta)))$ with θ bounded away from zero, and each monotone branch of R is mapped onto an interval containing $(\beta, \tau(\beta))$ and bounded by a boundary point of J^0 and $\tau(\beta)$, we can control the dilatation of H as we pullback it along these branches. In particular, pulling back along these branches infinitely many times refines the mapping H in X_3 : under R , every point in X_3 either lands in $\overline{\text{Comp}_c R^{-1}(\Gamma)}$ or it escapes through $J^4 \setminus J^5$, and the orbit of almost every point in $[\beta, \tau(\beta)] \setminus \text{Comp}_c R^{-1}(\Gamma)$ enters $\text{Comp}_c R^{-1}(\Gamma)$. Thus we obtain a mapping on the real line that is a conjugacy up to the first entry time of a point in N . Moreover H is defined dynamically on Γ and on X_3 (after refining the original mapping). Observe that if H_0 is quasiconformal on a neighbourhood of the interval $J^0 \setminus J^1$ then so is H .

Case 3: $R: J^1 \rightarrow J^0$ is a monotone mapping. Here we explain how to deal with the case when $R: J^1 \rightarrow J^0$ is a monotone mapping with possibly several critical points of odd order. Suppose first that $|J^0|/|J^1|$ is bounded. To simplify the exposition, we will assume that R is orientation preserving; the orientation reversing case is similar. We will focus on the key differences of this case with the two unimodal cases already considered.

We construct γ and γ' , by considering infinitely many pullbacks of the fundamental domains $J^0 \setminus J^1$ lying in $\mathbb{C} \setminus \mathbb{R}$, which are “closest to the real line,” and connecting them by boundary arcs of puzzle pieces.

Let $\beta \in J^{N+1}$ denote the fixed point of R . By Lemma 7.10, and [dMvS, IV. Theorem B], if $|J^0|$ is sufficiently small, there exists a constant C such that $1 + 1/C < |DR(\beta)| < C$. Notice that $\gamma_i, \gamma'_i, i \in \{1, 2, 3, 4\}$ all have a common boundary point at β . Let us now construct the regions Γ and Γ' . There are two cases to consider,

- (1) all critical points of R are contained in a single component of $J^0 \setminus \{\beta\}$ or
- (2) each component of $J^0 \setminus \{\beta\}$ contains at least one critical point of R .

Suppose first that all critical points of R are contained in one component of $J^0 \setminus \{\beta\}$. Let N' be maximal so that $J^{N'+1}$ contains a critical point c' of R . As in the unimodal, low return case, we need to be a little careful about complex pullbacks of the rectangles bounded by $\alpha_{i+1} \cup \alpha_i \cup e_i$ or $\alpha_{i+1} \cup \alpha_i \cup e'_i$ (whose real traces are a fundamental domain in $J^i \setminus J^{i+1}$), but observe that R has at most $\text{Crit}(F)$ critical points, and each passes through $J^i \setminus J^{i+1}$ at most once, so we can construct a shielding region about each critical point as in the unimodal, low return case, see page 106 and Figure 23. Let us construct a neighbourhood about c' under the assumption that $R(c') \in R^{-N}(\mathbf{I}_n \setminus \mathbf{I}_n^-)$; the alternative case is similar. Let Γ be the region bounded by $\partial J^4 \cup \gamma \cup \partial J^{N'+1}$ that contains a critical value of R and let Γ' be the region bounded by $\partial J^3 \cup \gamma' \cup \partial R^{-(N+1)}(\mathbf{I}_n^+)$ that contains a critical value of R . If each component of $J^0 \setminus \{\beta\}$ contains at least one critical point of R , then we make the same construction on either side of β to obtain a neighbourhoods Γ_1 of the component of $J^0 \setminus J^{N'}$ that contains $R(c')$ and a neighbourhood Γ_2 of the component of $J^0 \setminus J^{N''}$ that contains $R(c'')$. We let $\Gamma = \Gamma_1 \cup \Gamma_2$, and define Γ' analogously. We omit the details.

There exists $\delta > 0$ such that $\Gamma' \setminus \Gamma$ consists of a union of topological squares \mathcal{S} with δ -bounded geometry, so that $\text{mod}(\mathbf{J}^0 \setminus \mathcal{S}) \geq \delta$ and with moduli bounds as in (3) of Theorem 7.5. To see that these bounds hold, we can argue just as in the unimodal case.

We let

- $X_1 = \mathbf{J}^3 \cap (\Gamma' \setminus \Gamma) \cup (\mathbf{J}^3 \setminus (\mathbf{J}^4 \cup \Gamma'))$,
- $X_2 = (\mathbf{J}^0 \setminus \mathbf{J}^3) \cup \Gamma$,
- $X_3 = \mathbf{J}^0 \setminus \overline{X_1 \cup X_2 \cup \mathbb{R}}$, and
- $X_0 = \mathbf{J}^0 \setminus (X_1 \cup X_2 \cup X_3)$.

We define H on X_2 by pulling back when we can and applying the QC Criterion to construct K' -qc mappings that match the boundary markings on puzzle pieces that contain critical points. Here are the details.

First we will construct a complex neighbourhood of $\text{Crit}(F)$. We will use the same construction in the multicritical saddle-node and high-return cases. Let $\{\tilde{\mathbf{G}}_j\}_{j=0}^s$ be the chain with $\tilde{\mathbf{G}}_s = \mathbf{J}^0$, and $\tilde{\mathbf{G}}_0 = \mathbf{J}^1$ and let $\{\mathbf{G}_j\}_{j=0}^s$ be the chain with $\mathbf{G}_s = \mathbf{J}^1$, and $\mathbf{G}_0 = \mathbf{J}^2$. Let c be a critical point of F . If there exists i , $0 < i \leq s$ such that $c \in \tilde{\mathbf{G}}_i$, let $\mathbf{J}_c = \tilde{\mathbf{G}}_i = \hat{\mathcal{L}}_c(\mathbf{J}^0)$. Otherwise we define \mathbf{J}_c as follows: Let n be so that $\mathbf{W}_{c_0}^n$ is at the top of the same long central cascade as \mathbf{J}^0 . If \mathbf{W}_c^n is at the top of a long central cascade, then we take \mathbf{J}_c to be the excellent puzzle piece associated to the long central cascade by Proposition 5.13, otherwise we take $\mathbf{J}_c = \mathbf{W}_c^n$. Let T' be the set of critical points of F such that $\mathbf{J}_c = \mathbf{W}_c^n$. Let \hat{R} be the return mapping to $\cup_{c \in \text{Crit}(F)} \mathbf{J}_c$. Let \mathbf{P}'_1 denote the components of $\hat{R}^{-1}(\text{Dom}(\cup_c \mathbf{J}_c))$, that intersect $\mathbf{J}^0 \setminus \mathbf{J}^1$.

When we pull back a puzzle piece in \mathbf{P}'_1 through the central cascade, it could intersect several critical points, we need to ensure that the critical values are contained in puzzle pieces with bounded geometry and moduli bounds.

Let us suppose first that \mathbf{W} is a pullback of some \mathbf{J}_c that is a puzzle piece given by Proposition 5.13, which is at the top of some central cascade. To be definite, let

$$\mathbf{W} = \text{Comp}_{R^{N+1}(c_1)}(\text{Dom}(\cup_{c \in \text{Crit}(F)} \mathbf{J}_c)).$$

Then \mathbf{W} is mapped diffeomorphically onto \mathbf{J}_c . Consider the chain $\{\mathbf{Z}_j\}_{j=0}^N$ where $\mathbf{Z}_N = \mathbf{W}$ and for $j = 0, \dots, N-1$, we set \mathbf{Z}_j to be the component of $(R_{\mathbf{J}^0}|_{\mathbf{J}^1})^{-1}(\mathbf{Z}_{j+1})$ that intersects the real line. Each \mathbf{Z}_j intersects $J^j \setminus J^{j+1}$. Let b'_0 be the number of $\mathbf{Z}_j, j = 0, \dots, N$ that contain a critical point of $R = R_{\mathbf{J}^0}|_{\mathbf{J}^1}$. Let us index these critical points by c'_i where $c'_i \in \mathbf{Z}_{j_i}$, and $j_1 < j_2 < \dots < j_{b'_0}$. Let $T = \{c'_1, c'_2, \dots, c'_{b'_0}\}$. For each $c'_i, j_i \leq N+1$ let $v_i := R^{j_i}(c'_i)$.

Let us now refine \mathbf{W} : For any $v_i, i \in \{1, \dots, b'_0\}$, let s be minimal so that either

- $\hat{R}^s(v_1) \in \mathbf{J}_c$ where $c \in T'$, in which case $\mathbf{J}_c = \mathbf{W}_c^n$ is a puzzle piece in the good nest or
- $\hat{R}^s(v_1) \in \mathcal{L}_c(\mathbf{J}_c)$, for $c \in \text{Crit}(F) \setminus T'$, in which case \mathbf{J}_c is given by Proposition 5.13.

If $c \in T'$, let $\mathbf{Q}_{v_1} = \text{Comp}_{v_1} \hat{R}^{-s}(\mathbf{J}_c)$, and $\mathbf{Q}'_{v_1} = \text{Comp}_{v_1} \hat{R}^{-s}(\text{Comp}_{R^s(v_1)}(\text{Dom}(\mathbf{W}^n)))$, and if $c \in \text{Crit}(F) \setminus T'$, let $\mathbf{Q}_{v_1} = \text{Comp}_{v_1} \hat{R}^{-s}(\mathbf{J}_c)$, $\mathbf{Q}'_{v_1} = \text{Comp}_{v_1} \hat{R}^{-s}(\mathcal{L}_c(\mathbf{J}_c))$. By Proposition 5.13, Proposition 5.18, Corollary 5.19 and Proposition 7.4, we have that there exist $K_1 \geq 1$ and $\delta_1 > 0$ such that \mathbf{Q}'_{v_1} has δ_1 -bounded geometry, that $\text{mod}(\mathbf{Q}_{v_1} \setminus \mathbf{Q}'_{v_1}) \geq \delta_1$, and that H is (K_1, δ_1) -qc\bg on each component of that contains a forward image of a critical point. So by the QC Criterion there exists a $K' = K'(K_1, \delta_1)$ -qc mapping on each $\mathbf{Z}_j, j = 1, \dots, N$ that agrees with the boundary marking. Finally, we can extend H to $(\mathbf{J}^0 \setminus \mathbf{J}^1) \setminus (\cup \mathbf{Q}_v)$ using the same argument given to prove the Real Spreading Principle.

Once again, we have that X_3 is a union of disjoint K_1 -quasidisks. This is checked as in the unimodal, low return case using Lemma 7.12. We define H on each component \mathbf{W} of X_3 just as we did in the unimodal case:

- First, we define $h_{\mathbf{W}}$ on $\bigcup_{i=3}^{\infty} \{v'_i, w'_i\}$, so that it matches the boundary marking on this set. As in the unimodal case, it is straightforward to check that $h_{\mathbf{W}}$ defined on this set is (C, p) -qs for some C, p depending on $|J^0|/|J^1|$, and the escape times of the critical points. Note that when we pass through a long piece of the cascade that contains an escaping odd critical point, the cascade behaves according to the Yoccoz Lemma, as in the unimodal, low return case.
- There exists a K_1 -quasiconformal mapping of the plane so that $\phi_{\mathbf{W}}: \mathbb{D} \rightarrow \mathbf{W}$.
- Just like in the unimodal case, we have that $\phi_{\mathbf{W}}^{-1}(\bigcup_{i=3}^{\infty} \{v'_i, w'_i\})$ is an M -relatively connected subset of $\partial\mathbb{D}$, so by Proposition 3.3, we have that $\phi_{\mathbf{W}}^{-1} \circ h_{\mathbf{W}} \circ \phi_{\mathbf{W}}$ extends to a κ' -qs mapping on $\partial\mathbb{D}$.
- Finally since $\phi_{\mathbf{W}}^{-1} \circ h_{\mathbf{W}} \circ \phi_{\mathbf{W}}$ extends to a \hat{K}_2 -qc mapping on \mathbb{D} , we have that $h_{\mathbf{W}}$ extends to a \hat{K} -qc mapping $H_{\mathbf{W}}: \mathbf{W} \rightarrow \mathbf{W}$.

On X_1 we define H so that it is a homeomorphism, which agrees with the mapping already defined on a subset of ∂X_1 and so that it satisfies (2.1) on X_0 . So there exists a (K', δ') -qc mapping $H: \mathbb{C} \rightarrow \mathbb{C}$ such that $H(\mathbf{J}^0) = \tilde{\mathbf{J}}^0$ as in the statement of Theorem 7.5. Now we pull this construction back by one iterate of R .

The mapping constructed up to this moment is a conjugacy outside of a neighbourhood of the β fixed point. Let $\mathbf{W}_0 = \text{Comp}_{\beta} \mathbf{J}^4 \setminus R^{-1}(\Gamma)$. We are going to refine H in \mathbf{W}_0 , so that we obtain a mapping that is a conjugacy in a neighbourhood of J^1 (the real trace of the dynamics). Let $\mathbf{W}^1 = \text{Comp}_{\beta}(R^{-1}(\mathbf{W}_0))$. By definition H conjugates the dynamics of R and \tilde{R} on $\partial\mathbf{W}^1$, so we can pull it back by $R|_{\mathbf{W}^1}^i$ for $i = 1, 2, 3, \dots$. Since \mathbf{W}_0 is contained in a Poincaré disk with angle bounded away from zero based on its real trace, the dilatation as we pullback is small, and we obtain a conjugacy between R and \tilde{R} on \mathbf{W}^0 .

Suppose now that $|J^0|$ is much bigger than $|J^1|$. Since \mathbf{J}^0 is a K_0 -quasidisk, there exists $\theta \in (0, \pi)$ such that $\mathbf{J}^0 \subset D_{\theta}(J^0)$. So by Lemma 3.9, for $0 \leq i \leq N + 1$ we have that there exists $\lambda \in (0, 1)$ such that $\mathbf{J}^i \subset D_{\lambda^i \theta}(J^i)$. Thus we have that there exists a constant C such that $\text{diam}(\mathbf{J}^i) \leq C|J^i|/\lambda^i \theta$. So if $|J^{i+1}|$ is much smaller than $|J^i|$, for $i = 0, \dots, i_0$, with $i_0 \in \{0, \dots, N + 1\}$, we have that $|J^{i+1}|$ is much smaller than $\lambda|J^i|$, and so $\frac{|J^{i+1}|}{\lambda^{i+1} \theta}$ is much smaller than $\frac{|J^i|}{\lambda^i \theta}$. Hence there exists a constant $\eta < 1$ so that $\text{diam}(\mathbf{J}^{i+1}) < \eta \text{diam}(\mathbf{J}^i)$. So we can assume that the diameters of the puzzle pieces \mathbf{J}^i decay exponentially, for $0 \leq i \leq i_0$ and that $|J^{i_0}|$ is comparable to $|J^{i_0+1}|$ or $i_0 = N + 1$.

We construct $\mathbf{Q}_v \subset \mathbf{Q}'_v$ just as in the bounded geometry case, and refine the conjugacy H exactly as before. As long as J^i is much bigger than J^{i+1} we can pull back the conjugacy, and we deal with puzzle pieces that contain critical points exactly as in the bounded geometry case. So we pull back until the moment when the geometry becomes bounded. Let this moment be i_0 , so that $|J^{i_0}|$ is comparable to $|J^{i_0+1}|$. If all critical values of R are contained in $J^0 \setminus J^{i_0+1}$ or if both components of $J^{i_0} \setminus J^{i_0+1}$ are comparable to J^{i_0} then we can conclude the proof using the argument in the bounded geometry case. It could be the case that one of the components F_{i_0} of $J^{i_0} \setminus J^{i_0+1}$ is very small. In this case, we look at the forward images of this fundamental domain: $F_i = \text{Comp}_{R^{-i_0}(F_{i_0})} J^i \setminus J^{i+1}$. By the Koebe theorem, we can find i so that $|F_i| \asymp |J^i|$, and now we can repeat the argument from the bounded geometry case.

Case 4: $R: J^1 \rightarrow J^0$ is a multicritical mapping with a low return and $|J^0|/|J^1|$ is bounded. This is the case when $R(J^1)$ does not contain the critical point, and R does not have fix points on the real line, as in Figure 22(2), but with more critical points. We will treat the case when the geometry is unbounded after we consider the multicritical, high return case. First, we construct $Q_v \subset Q'_v$ exactly as in the monotone case, see page 117. Now, let us show that we can reduce this case to the case when there is a single turning point. For convenience, we will choose the chain $\{G_j\}_{j=0}^s$ so that $G_0 = J^2$ contains a critical point c_0 of even order, and $G_s = J^1$. Then $F^s(G_0) \not\supseteq c_0$. If $s' < s$ is maximal so that $G_{s'}$ contains a critical point c' of F of even order, we have that that $F^{s-s'}(c')$ is a global maximum for $F^s|_{J^1}$ and $F^{s-s'}(G_{s'}) \not\supseteq c_0$. Thus if we let $s_1 > 0$ be minimal so that G_{s_1} contains a critical point c_1 of even order, we have that $F^{s-s_1}(G_{s_1}) \not\supseteq c_0$, so that the return mapping $F^s: G_{s_1} \rightarrow \tilde{G}_{s_1}$, has one fewer critical points than $F^s|_{G_0}$, and since $F^s|_{G_{s_1}}$ does not have a fixed point, we have that $F^s(G_{s_1})$ does not contain c_1 . Continuing in this fashion we obtain that the return mapping $F^s: G_{s'} \rightarrow \tilde{G}_{s'}$, $\tilde{G}_{s'} = \text{Comp}_{F^{s'}(c_0)} F^{-(s-s')}(J^0)$, is a unimodal mapping. Moreover, c' corresponds to the last critical point of R to escape the central cascade.

Using the arguments from the previous cases we obtain a decomposition of $J^0_{s'}$ into sets X_0, X_1, X_2 and X_3 : We build the paths γ and γ' just as before. Suppose that N is so that $J^N \setminus J^{N+1}$ contains the even critical point. Then γ, γ' are both unions of four paths that connect ∂J^3 with $\partial R^{-1}(J^{N+1})$. We construct a neighbourhood of the critical points just like we did in the unimodal saddle node and monotone cases, compare Figure 23, but just as in the monotone case we have to argue more carefully since there could be odd critical points in the monotone branches of R : Observe that there are at most $\#\text{Crit}(f) - 1$ such odd critical points, so $\#\{R^{k_c}(c) : c \in \text{Crit}(R)\} \cap B_0$ is at most $\#\text{Crit}(f) - 1$. Thus there is a subinterval J of B_0 with length comparable to $|J^0|$ such that if J' is any component of $R^{-(N+1)}(J)$ that is contained in the real line then $R^{N+1}: J' \rightarrow J$ is a diffeomorphism. Now as in the unimodal and monotone cases, we can obtain neighbourhoods of the critical points which are “shielded” by topological rectangles with bounded geometry and moduli bounds. With this preparation, we define $X_i, i \in \{1, 2, 3, 4\}$, exactly as in the unimodal, low return case, and we can construct H in the same way as we did in the unimodal and monotone cases (since there could be critical points in the monotone branches of R). We will deal with the big geometry case after we treat cascades with a high return.

Case 5: $R: J^1 \rightarrow J^0$ is a high return. First let us consider the case when $|J^0|/|J^1|$ is bounded. Let β denote the outermost orientation preserving fixed point of $R: J^1 \rightarrow J^0$. Let λ_β be the multiplier of β . Provided that J^0 is small enough, which we can and will assume, by [dMvS, Chapter IV. Theorem B] there exists a $\varepsilon_0 > 0$, universal, so that $|\lambda_\beta| > 1 + \varepsilon_0$, and by Lemma 7.10, $|\lambda_\beta|$ is bounded from above.

We begin as in the unimodal case by constructing two regions $\Gamma \subset \Gamma'$ whose boundaries consist of staircases landing at β and $\tau(\beta)$ respectively and boundary arcs of ∂J^4 . To construct a conjugacy on the boundaries of puzzle pieces in Γ that contain critical points, we use the same procedure as in the monotone case, see page 117.

Let us now construct a first qc\mapping and partition. Let

- $X_1 = \Gamma' \setminus \Gamma \cup (J^3 \setminus (J^4 \cup \Gamma'))$,
- $X_2 = \Gamma \cup J^0 \setminus J^3$
- $X_3 = J^4 \setminus \overline{X_1 \cup X_2 \cup \mathbb{R}}$
- X_0 is the union of their boundaries.

We construct a qc\bg mapping H' associated to this partition exactly as in the unimodal case: Arguing as before, we have that there exists a \hat{K} -qc mapping from each component \mathbf{W} of X_3 to the corresponding component $\widetilde{\mathbf{W}}$. Moreover, We have that $(\mathbf{J}^3 \setminus (\mathbf{J}^4 \cup \Gamma'))$ and $\Gamma' \setminus \Gamma$, are both unions of combinatorially defined topological squares with bounded geometry and moduli bounds as in (3) of Theorem 7.5. So we can extend the mapping constructed in X_2 to a qc\bg mapping $H: \mathbf{J}^0 \rightarrow \widetilde{\mathbf{J}}^0$.

Now we pull this picture back by one iterate of R . For each critical point c such that $R(c) \notin [\beta, \tau(\beta)]$, we have that $c \in \text{Comp}_c R^{-1}(\Gamma)$. Let T_0 denote the critical points of R that do not escape $[\beta, \tau(\beta)]$ under R . We have that $T_0 \subset J^{N_1+2}$. If $T_0 = \emptyset$, then we can conclude the argument exactly as in the unimodal case, so let us suppose that $T_0 \neq \emptyset$. We will construct neighbourhoods of these critical points. We let \mathbf{W}' be the union of components of $\mathbf{J}^3 \setminus (\Gamma \cup R^{-1}(\Gamma))$ that contain the critical points $c \in T_0$, and we let \mathbf{W} be the union of components of $\mathbf{J}^3 \setminus (\Gamma \cup R^{-1}(\Gamma'))$ that contain critical points $c \in T_0$. Observe that $\mathbf{W} \subset \mathbf{W}'$. We let \mathbf{W}'_0 be a component of \mathbf{W}' and let \mathbf{W}_0 be the component of \mathbf{W} contained in \mathbf{W}'_0 . As before, it is not hard to use Lemma 7.12 to show that \mathbf{W}_0 and \mathbf{W}'_0 are K_1 -quasidisks. We also have that $\mathbf{W}'_0 \setminus \mathbf{W}_0$ is a union of topological squares with bounded geometry and moduli bounds as in (3) of Theorem 7.5. See Figure 27, for a rough idea of what the decomposition looks like in this case.

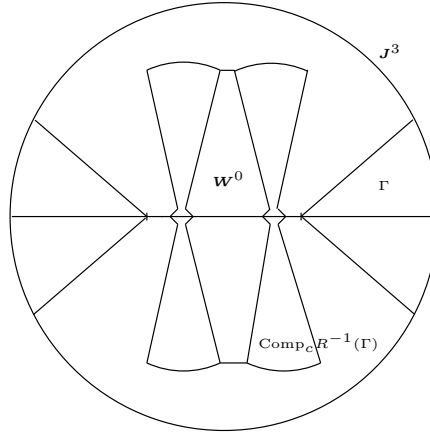

FIGURE 27. A sketch of the decomposition for a multicritical high return.

For each critical point $c \in T_0$, let $k_c \in \mathbb{N}$ be minimal so that $R^{k_c}(c) \in [\beta, \tau(\beta)] \setminus \mathcal{W}$. Order the critical points in T_0 , $c_1 < c_2 < c_3 < \dots < c_{|T_0|}$, so that $k_{c_i} \leq k_{c_{i+1}}$. Let $i_0 < b$ be minimal so that $k_{c_{i_0+1}} - k_{c_{i_0}} \geq N_0$. If no such i_0 exists, set $i_0 = |T_0|$. Let T_1 denote the set of critical points c_i with $i \leq i_0$. For each critical point c_i with $i \leq i_0$, we have that $k_{c_i} \leq |T_0|N_0$. Let $N_2 = k_{c_{i_0}}$. Let T_2 denote the set of critical points that do not escape \mathcal{W} under $R^{N_0+N_2}$. This is the same as the set of critical points c_i with $i > i_0$.

Let \mathbf{W}'_1 denote the components of $\mathbf{J}^3 \setminus (\Gamma \cup R^{-1}(\Gamma))$, that do not contain a critical point of R . Suppose that \mathbf{W} is a component of \mathbf{W}'_1 . Then by construction H is a conjugacy on $\partial\mathbf{W}$. So as in the unimodal, high return case, by pulling H back through infinitely many iterates of $R|_{\mathbf{W}'_1}$, we construct a conjugacy on the union of such components, up to the landing time of points in $\mathbf{W} \cup \mathbf{J}^0 \setminus \mathbf{J}^1$.

When $T_2 = \emptyset$, we can conclude proof by pulling back by a bounded number of steps. So suppose that $T_2 \neq \emptyset$. For convenience, let us suppose that $c_1 \in T_2$. Then we have that

$W^0 \supset W^1 \supset \dots \supset W^{k_{c_1}-1} \supset W^{k_{c_1}}$ is a long central cascade and $R(c_1) \in W^{k_{c_1}-1} \setminus W^{k_{c_1}}$. There are three cases to consider: The return mapping to \mathbf{W}^0 has a low return, a high return or is monotone. Depending on the case, we use one of the arguments we have already given. Notice in the low return case, the argument terminates after one step, since all the critical points escape through the monotone branches of R . In the high return case, if there are more non-escaping critical points, the argument will not terminate, but it eventually reduces to either the unimodal or monotone case.

Now let us consider the case when $|J^0|$ is much bigger than $|J^1|$ and c_0 is even. Then since \mathbf{J}^0 has bounded geometry and J^1 is approximately in the middle of J^0 , there exists C_0 large so that $|J^0| > C_0|J^1|$ and $\text{mod}(\mathbf{J}^0 \setminus J^1)$ is large.

If there exists $\delta_0 > 0$ such that for all $n, 0 \leq n \leq N$, we have that $\text{mod}(\mathbf{J}^n \setminus \mathbf{J}^{n+1}) \geq \delta_0$, then, there exists $\delta'_0 \in (0, 1)$, depending only on δ_0 , so that $\text{diam}(\mathbf{J}^{n+1}) < \delta'_0 \text{diam}(\mathbf{J}^n)$. Thus for $n = 1, 2, \dots, N$, there exists a constant $C > 0$ such that the dilatation of $R|_{\mathbf{J}^n \setminus \mathbf{J}^{n+1}}$ is bounded from above by

$$C \max_{0 \leq i \leq s} \{ \text{diam}(\text{Comp}_{f^i(c)} f^{-(s-i)}(\mathbf{J}^{n-1})) \},$$

which decays exponentially fast, and so we can pull the conjugacy back through the entire central cascade as we did above in the high-return case for the critical points in T_1 .

So we can assume that for some n , $\text{mod}(\mathbf{J}^n \setminus \mathbf{J}^{n+1}) < \delta'$. We claim that there exists $C' > 1$ such that $|J^n| < C'|J^{n+1}|$ and for all $i, 0 \leq i < n$ we have that $|J^i| > C'|J^{i+1}|$. Suppose not, then $|J^{n+1}|$ is much smaller than $|J^n|$, and $\text{mod}(\mathbf{J}^n \setminus \mathbf{J}^{n+1}) \leq D(1 + C(\mu(J^{n-1})))\delta_0$, where D is the degree of R . Since c_0 is even, we still have that J^{n+1} is approximately in the middle of J^n . Thus at least one of \mathbf{J}^n or \mathbf{J}^{n+1} does not have bounded geometry, even more that either the largest Euclidean circle centered at c that can be inscribed in \mathbf{J}^n has diameter much smaller than J^n or the smallest Euclidean circle centered at c that contains \mathbf{J}^{n+1} has diameter much larger than J^{n+1} . But then since for all $i, 0 \leq i < n$ $|J^i| > C'|J^{i+1}|$ the critical value of F is roughly in the middle of J^i , \mathbf{J}^{i+1} cannot be pinched at c , which together with the moduli bounds for $\text{mod}(\mathbf{J}^i \setminus \mathbf{J}^{i+1})$ for $i = 0, \dots, n$, gives a contradiction. Thus we can reduce the argument in the big geometry case to the bounded geometry case. Observe that by Lemma 3.2, the quasimetric mapping that we obtain by gluing together the mapping h we get by pulling back the quasiconformal mapping as long as the geometry is big, and the qs mapping \hat{h} on J^n , given by argument in the bounded geometry case, is κ -qs on \mathbb{R} . This concludes the proof of Theorem 7.5. \square

8. QUASISYMMETRIC RIGIDITY

Recall that we have a natural partial ordering on the set of critical points: $c_1 \geq c_0$ if $c_0 \in \omega(c_1)$ or if $c_0 = f^n(c_1)$ for some $n \geq 0$. We need to start with critical points which are lowest in this ordering because other critical points can accumulate on these. We then spread the information to other critical points which are higher in this partial ordering. So we start with the infinitely renormalizable and attracting cases, and proceed to the non-renormalizable cases; we first deal with the persistently recurrent and at most finitely renormalizable case, and finally treat the reluctantly recurrent case. Recall that the case of critical points that are non-recurrent and do not accumulate on other critical points was treated by Theorem 6.1 through the use of touching box mappings. We prove that immediate basins of attraction are rigid in Proposition 8.2.

To organize things properly, we decompose the set of critical points as in Section 4.4. Let Ω be a connected component of the graph of critical points. Let $\Omega_0 \subset \Omega$ be the set of critical points which are in the immediate basin of a periodic attractor or at which f is infinitely renormalizable. Let $\Omega_1 \subset \Omega$ be the set of critical points c for which f is persistently recurrent on $\omega(c)$ and at most finitely renormalizable. Let $\Omega'_1 \subset \Omega_1$ be a smallest subset so that $\cup_{c \in \Omega'_1} \omega(c) = \cup_{c \in \Omega_1} \omega(c)$. Let $\Omega_2 = \Omega \setminus (\Omega_0 \cup \Omega_1)$ be a set of critical points c which are reluctantly recurrent or nonrecurrent.

Let I_0 consist of the immediate basins of periodic attractors and of periodic intervals on which the mapping is infinitely renormalizable, where if c' is a critical point at which f is infinitely renormalizable, $I_0(c')$ is chosen so that if c is any critical point whose orbit does not accumulate on c' or land on c' , then $f^k(c) \notin I_0(c')$ for all $k = 0, 1, 2, \dots$. Let I'_1 be nice intervals around critical points $c' \in \Omega'_1$ again chosen so small that if c is any critical point whose orbit does not accumulate on c' or land on c' , then $f^k(c) \notin I_1(c')$ for all $k = 0, 1, 2, \dots$. As in Subsection 5.1.1 define

$$I_1 = \bigcup_{c \in \Omega_1 \setminus \Omega'_1} \mathcal{L}_c(I) \cup I'_1$$

and

$$I_2 = \bigcup_{c \in \Omega_2} I_2(c),$$

where $I_2(c) = \mathcal{L}_c(I_0 \cup I_1)$ if the latter set is non-empty, and $I_2(c)$ is some arbitrarily small nice interval, disjoint from I_1 and the other components of I_2 , otherwise. Note that by shrinking I'_1 we can choose I_2 as small as we like, and that $I_0 \cup I_1 \cup I_2$ is by construction a nice set. Hence we can assume that iterates of $c \in \Omega_0 \cup \Omega_1$ never enter I_2 . Moreover, we can replace I_1 by an arbitrarily small puzzle piece (while keeping I_2 as before); the resulting union of intervals will remain nice because $c \in \Omega_1$ does not enter I_2 . As usual, if \tilde{f} is topologically conjugate to f , we mark the corresponding objects for \tilde{f} with a tilde.

8.1. The immediate basin of attraction of a periodic attractor. Let \mathcal{C} be the class of maps defined in Section 1.4.1.

Proposition 8.1. *Assume that $f: [0, 1] \rightarrow [0, 1]$ is of class \mathcal{C} , $f(\{0, 1\}) \subset \{0, 1\}$ and that every $x \in (0, 1)$ is attracted to a fixed point p of f . Let $\tilde{f}: [0, 1] \rightarrow [0, 1]$ be another mapping with the same properties and which is topologically conjugate to f . Moreover, we require that the order of the maps at the fixed points are the same. Then f and \tilde{f} are quasisymmetrically conjugate.*

Here we use the convention that we say that the *order* of f at p is equal to zero, if $Df(p) \neq 0$ and otherwise it is the order of the critical point.

Although we do not need it in this generality, we state this result without requiring that the conjugacy maps critical points to critical points of the same order (except if the critical point is a fixed point). For example, it is allowed to mapping a critical point of odd order to a regular point, unless this point is the attracting fixed point of f . Note that if the fixed point is a critical point of f then the conjugacy can only be quasisymmetric if the orders of the two maps are the same at these fixed points. Indeed, the rates of convergence near these fixed points are of the form λ^{d^n} and $\tilde{\lambda}^{\tilde{d}^n}$ where d, \tilde{d} are the order of these critical points at p resp. \tilde{p} and this is only compatible with a Hölder conjugacy if $d = \tilde{d}$.

The proof of the Proposition 8.1 also gives the following statement:

Proposition 8.2. *Assume that f, \tilde{f} is of class \mathcal{C} which are topologically conjugate as in Theorem A, and with one or more periodic attractors. Then there exists a quasimetric homeomorphism h such that the following holds.*

- (1) *If p, \tilde{p} are corresponding attracting periodic points, then $h: B_0(p) \rightarrow B_0(\tilde{p})$ and h is a conjugacy between f and \tilde{f} restricted to these sets. Here $B_0(p)$ is the immediate basin of p (i.e. the component of the basin of p which contains p).*
- (2) *For each critical point c of f and each n for which $f^n(c) \in B_0(p)$, one has $h(f^n(c)) = \tilde{f}^n(\tilde{c})$, where \tilde{c} is the corresponding critical point of \tilde{f} .*

Proof of Proposition 8.1. Although the proof of this is more or less standard, we will give it to be complete. Label corresponding folding points of f and \tilde{f} by c_1, \dots, c_d resp. $\tilde{c}_1, \dots, \tilde{c}_d$. First assume that $Df(p) \neq 0$. Take an interval U around p so that by Proposition 3.6 f is quasiconformally linearizable on a complex neighbourhood of p and so that \tilde{f} has the same property on $h(U)$. Take a fundamental annulus $A \subset U$ which contains an iterate of each critical point. Take a corresponding fundamental annulus \tilde{A} for \tilde{f} , and take a smooth mapping $H: \text{Cl}(A) \rightarrow \text{Cl}(\tilde{A})$ so that $H \circ f = \tilde{f} \circ H$ on the outer boundary of A and so that it maps the n -th iterate of c_j to the n -th iterate of \tilde{c}_j . (We don't care about critical points of odd order.)

Next extend $h: \cup_{n \geq 0} f^n(A) \rightarrow \tilde{f}^n(\tilde{A})$ in the obvious way by $h = (\tilde{f}|_{\tilde{A}})^n \circ h \circ (f|_A)^{-n}$ (on $f^n(A)$). This mapping is quasiconformal on a neighbourhood of p .

Next extend the qc conjugacy H to a qs conjugacy H defined on $(0, 1)$ as follows: Take $x \in (\epsilon, 1 - \epsilon)$, take n minimal so that $f^n(x) \in A$, and define $(\tilde{f})^{-n} \circ H \circ f^n(x)$. Here the choice of the inverse is uniquely dictated by continuity. It is easy to see that H is quasimetric restricted to an interval of the form $[\delta, 1 - \delta]$, since then n is uniformly bounded. (Restricted to this set, H is possibly only non-smooth points in the backward iterates of critical points. There the points are locally of the form $t \mapsto t^p$.) But then if $a \in \{0, 1\}$ is a fixed point of f then take a complex neighbourhood U_a of a on which f is linearizable, take a fundamental annulus A_a and take the corresponding annulus \tilde{A}_a for a . Then extend the qs mapping $A_a \cap [0, 1] \rightarrow \tilde{A}_a \cap [0, 1]$ to a quasiconformal $A_a \rightarrow \tilde{A}_a$, and extend H to a neighbourhood of a by $(\tilde{f})^n \circ H \circ (f|_{U_a})^{-n}(x)$.

Observe that if a is hyperbolic repelling fixed point then backward orbits converge to a at an exponential rate, and if it is parabolic repelling, then since $f \in \mathcal{C}$, backward orbits converge to a at the rate

$$|z_{-n} - p'| \asymp \frac{1}{n^{1/d}}$$

and the asymptotically conformal extension is of order $d + 2$ in a neighbourhood of the parabolic periodic point. So that in a neighbourhood of z_{-n} , H is K -quasiconformal with

$$K < C \sum_{k=1}^n \frac{1}{k^{\frac{d+1}{d}}} < C \sum_{k=1}^{\infty} \frac{1}{k^{\frac{d+1}{d}}},$$

which converges. Thus the resulting limit mapping is quasiconformal. If a is not a fixed point, then either it is mapped to the other endpoint of $[0, 1]$ which is a fixed point or both boundary points have period two, and then we argue similarly.

If $Df(p) = 0$, then by Proposition 3.6 we can locally conjugate f to z^d by a qc mapping and argue as before. □

8.2. The infinitely renormalizable, analytic case. Let us first show how to prove rigidity at critical points at which f is infinitely renormalizable when f is real-analytic. In this case only minor modifications of [KSvS1] are needed. In the infinitely renormalizable case we have to use an approach which is more ‘real’: we cannot simply pull back through the enhanced nest associated to non-renormalizable complex box mappings. Fortunately, we can combine a result of [KSvS1] and the touching box mappings.

Theorem 8.3. *Let $g: [0, 1] \rightarrow [0, 1]$ and $\tilde{g}: [0, 1] \rightarrow [0, 1]$ be two real-analytic maps which are topologically conjugate. Assume that $\omega(c) = \omega(c')$ for each two critical points c, c' of f and that f is infinitely renormalizable at each of its critical points. Then there exists a qs conjugacy between $g: [0, 1] \rightarrow [0, 1]$ and $\tilde{g}: [0, 1] \rightarrow [0, 1]$.*

This theorem is a generalization of Theorem 7.1 in [KSvS2], where it was assumed that f, \tilde{f} are polynomials with only have real critical points which are all of even order, Here we will show how to modify this proof and use the touching box mappings to prove Theorem 8.3.

First note that by Theorem 5.1, if c is a critical point at which g is infinitely renormalizable, then there exists an interval $I \ni c$ so that $g^s(I) \subset I$ (with the interiors of $I, \dots, g^{s-1}(I)$ disjoint and with $g^s(\partial I) \subset I$) so that $g^s: I \rightarrow I$ extends to a polynomial-like mapping $G: U \rightarrow V$ and so that $\text{mod}(V \setminus U) \geq \mu$. Here $\mu > 0$ is *beau* (eventually universal). We can choose s and I , so that for the corresponding interval \tilde{I} the map $\tilde{g}^s: \tilde{I} \rightarrow \tilde{I}$ also extends to a polynomial-like mapping $G: \tilde{U} \rightarrow \tilde{V}$.

Hence, by Douady and Hubbard’s Straightening Lemma, $g^s: U \rightarrow V$ is K -qc conjugate to a polynomial $G: \mathbb{C} \rightarrow \mathbb{C}$, where K only depends on μ . In particular, $g^s: I \rightarrow I$ is qs-conjugate to a polynomial $G: [-1, 1] \rightarrow [-1, 1]$ with $G(\{-1, 1\}) \subset \{-1, 1\}$. If $\omega(c)$ contains b critical points, then this polynomial G is a composition of b real unicritical polynomials q_i , for which $q_i(\{-1, 1\}) \subset \{-1, 1\}$, i.e. $G = q_{b-1} \circ q_{b-2} \circ \dots \circ q_0$. The mapping G may have critical points off the real line, but G is a composition of maps with only real critical values, and in particular any non-real critical point \hat{c} is eventually mapped into the real line and $\omega(c) = \omega(c')$ for all real critical points c, c' of G .

Lemma 8.4. *If $G: [-1, 1] \rightarrow [-1, 1]$ and $\tilde{G}: [-1, 1] \rightarrow [-1, 1]$ are qs conjugate, then $g: [0, 1] \rightarrow [0, 1]$ and $\tilde{g}: [0, 1] \rightarrow [0, 1]$ are qs conjugate.*

Proof. Since $g^s: I \rightarrow I$ is qs conjugate to $G: [-1, 1] \rightarrow [-1, 1]$ (and similarly, for \tilde{g}^s and \tilde{G}), if $G: [-1, 1] \rightarrow [-1, 1]$ and $\tilde{G}: [-1, 1] \rightarrow [-1, 1]$ are qs conjugate, then $g^s: I \rightarrow I$ and $\tilde{g}^s: \tilde{I} \rightarrow \tilde{I}$ are qs conjugate. Let c_0 be the critical point of g in I . Set $I^s = I$ and let $I^i = \text{Comp}_{g^i(c_0)} g^{s-i}(I)$ for $s = 0, 1, \dots, s-1$. Using the conjugacy equation (and that g and \tilde{g} have critical points of the same order), we also get that $g^s: I^i \rightarrow I^i$ and $\tilde{g}^s: \tilde{I}^i \rightarrow \tilde{I}^i$ are qs conjugate for each $i = 0, 1, \dots, s-1$. Thus we have obtained a qs conjugacy $h: \cup_{i=0, \dots, s-1} I^i \rightarrow \cup_{i=0, \dots, s-1} \tilde{I}^i$ between g and \tilde{g} . Let us now show how to extend h to a qs conjugacy defined on $[0, 1]$.

To do this, we construct a touching complex box mapping. Consider a finite, forward invariant set Z'_0 containing $\{0, 1\}$ and ∂I^i , $i = 1, \dots, s$. Let $\delta > 0$ be the constant from Proposition 6.2. Let $N > 0$ be so large that each point $z \in Z'_0$ is approximated by a different point $z' \in g^{-N}(Z'_0) \setminus (\cup_{i=0}^s I^i)$ with $|z - z'| < \delta$. Such an N exists by Lemma 4.9.

Let $Z' = g^{-N}(Z'_0)$. Let $\mathcal{P}' = [0, 1] \setminus Z'$. and $\mathcal{P} = [0, 1] \setminus g^{-1}(Z')$. Next, consider a Poincaré lens neighbourhood (a “necklace” neighbourhood) of \mathcal{P}' , where for each component J' of \mathcal{P}'

the component of the neighbourhood is the Poincaré lens domain $D_{\pi-\theta}(J')$ where θ is chosen close to 0.

Next consider a component J of \mathcal{P} which is not contained in $\cup g^i(I)$. Since all critical points of g are contained in $\cup g^i(I)$, g is a diffeomorphism from J to some component T' of \mathcal{P}' . It follows from Proposition 3.7 that the component containing J of $g^{-1}(D_{\pi-\theta}(T'))$ is contained in $D_{\pi-\theta'}(J)$ where θ' is slightly larger than θ . In fact, θ'/θ can be chosen as close to one as we want by taking N sufficiently large, and it can be arranged so that there exists $c < 1$ (not depending on Z') so that $|J|/|J'| \leq c$ where $J' = J'(J)$ is the component of \mathcal{P}' containing J . It follows that $g^{-s}(D_{\theta}(T'))$ is compactly contained in $D_{\pi-\theta}(J')$ whenever J is compactly contained in J' . If J has a boundary point in common with J' , then $D_{\pi-\theta'}(J)$ is contained in $D_{\pi-\theta}(J')$, in view of Proposition 6.2.

Thus we have constructed a touching complex box mapping $g_T: \mathcal{U}_T \rightarrow \mathcal{V}_T$. Here \mathcal{U}_T is equal to the union of sets of the form $\text{Comp}_J g_T^{-1}(D_{\pi-\theta}(T'))$ where T' is a component of $[0, 1] \setminus g^{-1}(Z)$ not contained in $\cup g^i(I)$ and $T' = g(J)$. Similarly, \mathcal{V}_T is the union of sets of the form $D_{\pi-\theta}(T')$ where T' is a component of $[0, 1] \setminus Z'$. Note that $\overline{\mathcal{V}_T}$ contains $[0, 1]$ and that \mathcal{U}_T contains $[0, 1] \setminus \cup g^i(I)$.

Now define a qc mapping $H: \mathbb{C} \rightarrow \mathbb{C}$ which is real-symmetric and so that

- H is an extension of $h: \cup_{i=0, \dots, s-1} g^i(I) \rightarrow \cup_{i=0, \dots, s-1} \tilde{g}^i(\tilde{I})$
- \mathcal{V}_T is mapped onto $\tilde{\mathcal{V}}_T$;
- \mathcal{U}_T is mapped onto $\tilde{\mathcal{U}}_T$;
- $\tilde{g} \circ H = H \circ g$ on $\partial \mathcal{U}_T$.

That this can be achieved follows from Proposition 6.2 and Theorem 6.6. Now apply successive pullbacks H_n of H . Now take $H_0 = H$ and define $H_n|_{\mathcal{U}_T}$ inductively by $\tilde{g}_T \circ H_{n+1} = H_n \circ g_T$ and define H_n outside \mathcal{U}_T to be equal to H . Since g, \tilde{g} are univalent on each component of $\mathcal{U}_T, \tilde{\mathcal{U}}_T$, the dilatation of H_n is the same as that of H . Note also that H_{n+1} agrees with H_n outside the set $\mathcal{U}_n = \{z \in \mathcal{U}_T; g(z), \dots, g^n(z) \in \mathcal{U}_T\}$. It follows that H_n converges to a qc mapping H_∞ and that H_∞ is a conjugacy between g_T and \tilde{g}_T . \square

It follows from Lemma 8.4 that it is enough to show that the polynomials F and \tilde{F} are qc conjugate. Even though not all critical points of F and \tilde{F} are real, we have as in Theorem 7.1 of [KSvS1]:

Theorem 8.5. *There exists a qs homeomorphism $h: [-1, 1] \rightarrow [-1, 1]$ which maps critical points of G to critical points of \tilde{G} so that $h(G^i(c)) = \tilde{G}^i(h(c))$.*

Proof. The proof of this result is based on [KSvS1]. Since we will give a different proof using the qc\bg partition, we will be relatively brief. The proof of this Theorem goes essentially as in Sections 7.3-7.5 in Section 7 of [KSvS1]. Indeed, the maps G, \tilde{G} are in the same class \mathcal{T}_b as the maps used in Sections 7.3-7.5 in Section 7 of [KSvS1], with the only difference being that in our case the maps can have inflection points. However, from Theorem 5.1 we have complex bounds for maps with inflection points, and otherwise the modifications needed in the proof are minor (for example, Fact 7.2 (part 2), in Lemma 7.2 if $F^2: M_1 \rightarrow M_0$ is monotone, then it does not need to be a diffeomorphism). \square

Corollary 8.6. *G and \tilde{G} are qc conjugate.*

Proof. Take a qc mapping $H_0: \mathbb{C} \rightarrow \mathbb{C}$ which agrees with the qs homeomorphism h from Theorem 8.5. Note that all critical values of G are in the real line, and have the same ω -limit (and similarly for \tilde{G}). Hence we can define inductively H_{n+1} by $\tilde{G} \circ H_{n+1} = H_n \circ G$. Since $h(G^i(c)) = \tilde{G}^i(h(c))$ for all $i \geq 0$, this is possible, and H_n has the same dilatation as H_0 . It follows that H_n has a convergent limit H_∞ , and that $\tilde{G} \circ H_\infty = H_\infty \circ G$. \square

Proof of Theorem 8.3. The theorem follows from the Corollary 8.6 and Lemma 8.4. \square

8.3. The infinitely renormalizable, C^3 case. In the smooth case we cannot make use of the Douady-Hubbard Straightening Theorem. We will give a proof of quasimetric rigidity, which is new (even in the analytic case), and which uses similar ideas as proof of Theorem 7.5.

Suppose that c_0 is a critical point at which f is infinitely renormalizable. We may assume that c_0 is even. Let $J = J_0 \supset J_1 \supset J_2 \supset J_3 \supset \dots$ be successive periodic intervals about c_0 with periods $1 < s_1 < s_2 < s_3 < \dots$. Let $J_n^j = \text{Comp}_{f^j(c_0)} f^{-(s_n-j)}(J_n)$, where $0 \leq j < s_n$. We denote the boundary of J_n by $\{\beta, \tau(\beta)\}$ where β is a repelling periodic point (for f) that is fixed by $R_{J_n} = f^{s_n}|_{J_n}$.

Proposition 8.7 ([KSvS1, CvST]). .

There exists a positive integer $N = N(f)$ such that if $n \geq N$ we have the following.

- (1) *There exist $0 = j_0 < j_1 < j_2 < \dots < j_{b-1} < s_n$ such that each $J_n^{j_i}$ contains a critical point equivalent to c_0 and for any other i , $0 < i < s_n$, J_n^i is disjoint from $\text{Crit}(f)$. Moreover, $f^{j_{i+1}-j_i}(J_n^{j_i})$ contains the critical point in $J_n^{j_{i+1}}$.*
- (2) *Let $\mathcal{J}_n = \cup_{j=0}^{b-1} J_n^j$. Then the distortion of the first landing mapping to \mathcal{J}_n under f restricted to $\cup_{j=0}^{s_n-1} J_n^j$ is bounded from above by a constant depending only on the number of critical points of f (in the equivalence class of c_0) and their orders.*
- (3) *For any $0 \leq i \leq s_n$ and $0 \leq i' \leq s_{n+1}$, if $J_{n+1}^{i'} \subset J_n^i$, then*

$$(1 + \tau)J_{n+1}^{i'} \subset J_n^i,$$

where $\tau > 0$ is a constant depending only on the vector of critical points.

- (4) *The derivative of $f^{s_n}: J_n \rightarrow J_n$ is bounded from above by a constant that depends only on the number of critical points of f and their orders.*
- (5) *The multipliers of the periodic points of $f^{s_n}: J_n \rightarrow J_n$ are bounded from below by a constant $\rho > 1$.*
- (6) *There exists a constant δ such that if c is a critical point of $f^{s_n}: J_n \rightarrow J_n$, then $|f^{s_n}(c) - c| > \delta|J_n|$.*
- (7) *Let α be the fixed point of $f^{s_n}|_{J_n}$ closest to c_0 , β be the fixed point of $f^{s_n}: J_n \rightarrow J_n$ in ∂J_n and $x_0 \in f^{-s_n}(\alpha) \cap J_n$ be the point closest to β . For $i > 0$, let x_{i+1} be the preimage of x_i under $f^{s_n}|_{J_n}$ closest to β . There exist constants $C, c > 0$ and $0 < \lambda < 1$ such that $c\lambda^n < |x_n - \beta| < C\lambda^n$ (see [KSvS1, Fact 7.3]).*

Suppose that f is an infinitely renormalizable mapping as in Theorem A. Suppose that J is a periodic interval for f of sufficiently high period so that by Theorem 5.1 there exists a K -qr polynomial-like mapping $F: \mathbf{U} \rightarrow \mathbf{V}$ that extends R_J such that $\text{mod}(\mathbf{V} \setminus \mathbf{U})$ is bounded away from 0, \mathbf{U} has ρ -bounded geometry and $\text{diam}(\mathbf{U}) < C|J|$. Let us first show that we can construct a Yoccoz puzzle \mathcal{Y} for F , and show that the puzzle pieces have good geometric properties. The proof of the following is the same as for (holomorphic) polynomial-like maps with non-escaping critical points.

Lemma 8.8. *Let F be as above. Let J_F be the set of non-escaping points of F . Then J_F is connected.*

Let us show that we can construct external rays for the Julia set of a K -qr polynomial-like mapping $F: \mathbf{U} \rightarrow \mathbf{V}$ with a connected Julia set. We use a method of [LP]. Let K_F denote the filled Julia set of F . Let $B_F: \mathbf{V} \rightarrow \mathbf{W}_+$ be an isomorphism of $\mathbf{U} \setminus K_F$ onto the round annulus $\mathbf{W}_+ = \{z : 1 < |z| < R\}$ where $\log R$ is the modulus of $\mathbf{V} \setminus K_F$, such that $|B_F(z)| \rightarrow 1$ as $z \rightarrow J_F$, so that B_F is a proper map. Let $\mathbf{W}'_+ = B_F(\mathbf{U})$. Let $h_+: \mathbf{W}'_+ \rightarrow \mathbf{W}_+$ be the mapping $h_+(x) = B_F \circ F \circ B_F^{-1}(x)$. Let $\sigma: z \mapsto 1/\bar{z}$ be the reflection with respect to the unit circle. Let $\mathbf{W}_- = \sigma(\mathbf{W}_+)$ and $\mathbf{W}'_- = \sigma(\mathbf{W}'_+)$. Define $\mathbf{W} = \mathbf{W}_+ \cup S^1 \cup \mathbf{W}_-$ and $\mathbf{W}' = \mathbf{W}'_+ \cup S^1 \cup \mathbf{W}'_-$. By the reflection principle for qc mappings h_+ extends to a K -qc mapping $h: \mathbf{W}' \rightarrow \mathbf{W}$. We have that h is strongly expanding in a neighbourhood of S^1 , and consequently that h^{-1} is strongly contracting for the Poincaré metric in a neighbourhood of S^1 . Let us foliate $\mathbf{V} \setminus K_F$ as follows. Choose $\eta > 1$ and let ϕ be an arbitrary smooth conjugacy between h and $\psi: z \mapsto z^d$ on a neighbourhood of $\mathbf{W} \setminus \mathbf{W}'$ to $\mathbf{\Lambda} = \{z : \eta < |z| < \eta^d\} \cup \{z : 1/\eta^d < |z| < 1/\eta\}$. Foliate $\mathbf{\Lambda}$ by radii, and extend it to a foliation τ' of a neighbourhood of S_1 by $(\phi \circ h^n)^{1/d^n}$. Define $\tau^* = \phi^{-1}(\tau')$ and $\tau = B_F^{-1}(\tau^*)$. Then τ is a smooth foliation defined on $\mathbf{V} \setminus K_F$ that is invariant under F with the property that each leaf of τ passes through $\partial\mathbf{V}$ and $\partial\mathbf{U}$ and intersects these sets transversally. Note the τ is smooth since all the critical points of F are contained in J_F . We will call any leaf of τ an external ray of J_F . Since h is strongly expanding, each leaf of τ^+ intersects S^1 in a unique point $e^{2\pi it}$. Thus we extend τ^* to a foliation of \mathbf{W} . From the construction of τ^* via τ' we have that for each $t \in [0, 1)$ only one leaf of τ^* passes through $e^{2\pi it}$. For each external ray ℓ we let ℓ^* denote the leaf of τ^* that contains $B_F(\ell)$.

Lemma 8.9. *Keeping the same notation as above. Suppose that p is a real repelling periodic point of $F: \mathbf{U} \rightarrow \mathbf{V}$. Then at least one ray lands at p .*

Proof. Suppose that the period of p is s , then by considering the mapping $F^s: p \mapsto p$, we can suppose that p is a fixed point of F , so that is what we will do. Let $\lambda = F'(p)$. Let N denote a complex neighbourhood of p on which F is quasiconformally conjugate to $x \mapsto \lambda x$. Let $g = F^{-1}|_N$. Then there exists a constant C such that for $x \in N$

$$\frac{1}{C\lambda^n} < |(g^n)'(x)| < \frac{C}{\lambda^n}.$$

For any ray R that is fixed by F , let R_t denote the segment on the ray R lying between t and $F(t)$, and including t . Then R_t is a fundamental domain for the dynamics on R . It follows from the facts that h is strongly expanding near S^1 and that B_F is proper, that the Euclidean length of R_t tends to 0 as $t \rightarrow 0$. Let $S' \subset N$ be a complex neighbourhood of p and let $S = g^{-1}(S')$. Let

$$\varepsilon = \inf_{z \in \partial S, z' \in \partial S'} |z - z'|.$$

There exists t_ε , such that for all $t \in (0, t_\varepsilon)$, the Euclidean length of R_t is less than ε . Take t so small that R_t lies in S' . Then for all n , $R_{g^n(t)} \subset S'$ and

$$R_{g^n(t)} \subset B\left(p, \frac{C \text{diam}(S')}{\lambda^n}\right),$$

which implies that the ray R lands. □

Let α be the orientation reversing fixed point in J_n that is furthest from $c \in J_n$. From the above and by slightly modifying the arguments of Lemmas 5.1 and 5.2 of [KSvS1], we have two rays, symmetric about the real line, landing at α , and pulling them back by one iterate of F , we obtain two rays landing at $\tau(\alpha)$. Let $M_0 = (\alpha, \tau(\alpha))$. Inductively define M_{n+1} to be the pullback of M_n that contains α in its boundary. Assuming that the first renormalization of F is not of intersection type, we have $M_1 \neq M_0$. If the mapping $F^2: M_1 \rightarrow M_0$ is monotone, then it has a unique fixed point, which we denote by ρ . Just as above, we have two rays landing at each of ρ and $\tau(\rho)$. If the mapping $F^2: M_1 \rightarrow M_0$ is not monotone, then the mapping $F^2: M_2 \rightarrow M_1$ is. In this case we can apply the argument on pages 796-797 of [KSvS1] to reduce to the previous case. So let us just consider the case where $F^2: M_1 \rightarrow M_0$ is monotone.

Let \mathbf{Y}' be the puzzle piece bounded by the rays through α and $\tau(\alpha)$ and $\partial\mathbf{V}$ containing c_0 , and let \mathbf{Y} be the puzzle piece bounded by the rays through ρ and $\tau(\rho)$ and the curve $\partial\mathbf{U}$ containing c_0 . Let \mathbf{Y}_0 be the union of puzzle pieces bounded by $\partial\mathbf{V}$, $\partial\mathbf{U}$ and the rays landing at $\alpha, \tau(\alpha), \rho$ and $\tau(\rho)$. Just as for polynomials, the pullbacks of these puzzle pieces are either nested or disjoint.

Lemma 8.10. *There exists $\tau > 0$ and $\theta \in (0, \pi/2)$ such that \mathbf{Y} has θ -bounded shape and $\text{mod}(\mathbf{Y}' \setminus \mathbf{Y}) \geq \tau$.*

Proof. The relative length in I of each component of $I \setminus \{\alpha, \tau(\alpha), \rho, \tau(\rho)\}$ is uniformly bounded away from zero. The multipliers of α and ρ are uniformly bounded from above and away from one, $\mathbf{Y} \Subset \mathbf{Y}'$, and there exists a constant C so that F is $(1 + C \max_{0 \leq j < s_n} (|J_n^j|))$ -quasiregular on $\mathbf{U} \cap \mathbb{R}$, so $\text{mod}(\mathbf{Y}' \setminus \mathbf{Y})$ is bounded away from 0. Let $T \ni \rho$ be the maximal open interval such that $F^4|_T$ is monotone. Let L be the component of $T \setminus \{\rho\}$ that is contained in (ρ, c_0) . Let R be the other one. The relative lengths of L and R are bounded away from zero. For some constant $\theta > 0$, $\partial\mathbf{Y} \cap (\mathbb{C} \setminus F^{-4}(\mathbf{V}))$ is contained in $D_\theta(L) \cap D_\theta(R)$, and is disjoint from $D_{\pi-\theta}((\rho, -\rho))$, so, the external rays landing at ρ are contained in $D_\theta(L) \cap D_\theta(R)$. Similarly around the preimage of ρ . This is enough to show that \mathbf{Y} has θ -bounded shape. \square

Let f, \tilde{f} be maps as in Theorem A. Suppose that f is infinitely renormalizable at c_0 , and let $F: \mathbf{U} \rightarrow \mathbf{V}$ and $\tilde{F}: \tilde{\mathbf{U}} \rightarrow \tilde{\mathbf{V}}$ be the K -qr polynomial-like mappings that extend the return maps to corresponding periodic intervals $I \ni c_0, \tilde{I} \ni \tilde{c}_0$ of sufficiently high period given by Theorem 5.1. Let \mathbf{Y}_0 and $\tilde{\mathbf{Y}}_0$ be the puzzles constructed as above for F and \tilde{F} , and let $H_0 = B_{\tilde{F}}^{-1} \circ B_F$. Then $H_0: \partial\mathbf{Y}_0 \rightarrow \partial\tilde{\mathbf{Y}}_0$ conjugates F and \tilde{F} on $\partial\mathbf{Y}_0$, and since F, \tilde{F} are asymptotically conformal on the real slices of their domains there exists $K' > 1$ so that H_0 is a K' -qc in a neighbourhood of \mathbf{Y}_0 . Mimicking the case of polynomials, we refer to H_0 as a *boundary marking*.

Lemma 8.11 (Puzzle geometry control for K -qr polynomial-like mappings, c.f. Lemma 7.4 [KSvS1]). *Let f, \tilde{f} be maps as in Theorem A. Suppose that f is infinitely renormalizable at $c_0 \in \text{Crit}(f)$, and let $F: \mathbf{U} \rightarrow \mathbf{V}$ be a K -qr polynomial-like mapping that extends the return mapping to a periodic interval $I \ni c_0$ of sufficiently high period s given by Theorem 5.1. Suppose that F is not immediately renormalizable (equivalently, the next renormalization of F is not of intersection type). Let J_0 be the maximal properly periodic interval for $F|_I$ that contains c_0 . Then there exist two puzzle pieces $\mathbf{P}' \supset \mathbf{P}$ for F that contain J_0 and are contained in the Yoccoz puzzle \mathbf{Y} for F such that*

- (1) *the first return time of c_0 to \mathbf{P}' is equal to the first renormalization period s ;*

- (2) $\mathbf{P}' \setminus \mathbf{P}$ is disjoint from $\omega(c_0)$
- (3) $\text{mod}(\mathbf{P}' \setminus \mathbf{P}) \geq \eta$;
- (4) \mathbf{P} is an η -excellent puzzle piece, see page 57,

where $\eta > 0$ is a constant independent of F . Moreover, if we replace the mapping F and the puzzle pieces \mathbf{P}', \mathbf{P} by the corresponding objects for f , the statements remain true.

Proof. We will explain how to modify the proof of Lemma 7.4 of [KSvS1]. First, by the Complex Bounds of [CvST], and Lemma 4.4, the existence of domains \mathbf{V} and \mathbf{V}' as in the start of the proof of [KSvS1], Lemma 7.4 imply the result. Since we are using \mathbf{V} to denote the range of a qr polynomial-like mapping, we will deviate from the notation in [KSvS1] and denote \mathbf{V} and \mathbf{V}' by \mathbf{Q} and \mathbf{Q}' respectively. Moreover, Lemma 8.10 gives us puzzle pieces \mathbf{Y}, \mathbf{Y}' as in Fact 7.4 of [KSvS2]. Proceeding as in [KSvS1], we introduce an extended mapping as follows. Let $\{c_0, \dots, c_{b-1}\}$ be the set of critical points in $\omega(c_0)$ ordered so that $\mathbf{U} \ni c_0, f^{s_1}(\mathbf{U}) \ni c_1, f^{s_2}(\mathbf{U}) \ni c_2, \dots, f^{s_{b-1}}(\mathbf{U}) \ni c_{b-1}$ with $0 = s_0 < s_1 < s_2 < \dots < s_{b-1}$. For each c_i , let $\mathbf{U}_i = f^{s_i}(\mathbf{U})$. For each $i, 0 < i < b-1$, if $z \in \mathbf{U}_i$ define $\mathbf{F}(z, i) = (f^{s_{i+1}-s_i}(z), i+1)$. We say that an interval $K \times \{i\} \subset [0, 1] \times \{i\}$ or $S^1 \times \{i\}$ is an \mathbf{F} -pullback of $M_0 \times 0$ of depth k if it is a component of $\mathbf{F}^{-k}(M_0 \times \{0\}) \cap (\mathbb{R} \times \{i\})$ so that $i+k = 0 \pmod{b}$. Let m be the maximal positive integer so that $M_0 \times \{0\}$ has a unicritical \mathbf{F} -pullback, $K \times \{i\}$. For each $(x, i) \in \text{PC}(\mathbf{F}) \cap (K \times \{i\})$, we have $\mathbf{F}^m(x, i) \in (M_0 \setminus (M_1 \cup (-M_1))) \times \{0\}$. This follows exactly as on page 795 [KSvS1]. Let $\mathbf{W} = \text{Comp}_{c_i}(\mathbf{F}^{-m}(\mathbf{Y} \times \{0\}))$ and $\mathbf{W}' = \text{Comp}_{c_i}(\mathbf{F}^{-m}(\mathbf{Y}' \times \{0\}))$. Then $\mathbf{W}' \setminus \mathbf{W}$ is disjoint from the post-critical set of \mathbf{F} , and since there exists a constant $C > 0$ such that the mapping

$$\mathbf{F}^m : (\mathbf{W}', \mathbf{W}) \rightarrow (\mathbf{Y}' \times \{0\}, \mathbf{Y} \times \{0\})$$

is a degree d_{c_i} unicritical, $(1 + C \max_{0 \leq i \leq m-1} (\text{diam}(\mathbf{G}_i))^{1/2})$ -qr branched covering, where $\{\mathbf{G}_i\}_{i=0}^m$ is the chain with $\mathbf{G}_m = \mathbf{Y}' \times \{0\}$, and $\mathbf{G}_0 = \mathbf{W}'$, we have

$$\text{mod}(\mathbf{W}' \setminus \mathbf{W}) \geq \frac{\text{mod}(\mathbf{Y}' \setminus \mathbf{Y})}{d(1 + C \max_{0 \leq i \leq m-1} (\text{diam}(\mathbf{G}_i))^{1/2})},$$

which is bounded from below. To see that \mathbf{W} has bounded geometry follows from Lemmas 4.4, 3.9 and 3.10. Now we define \mathbf{Q} , respectively \mathbf{Q}' , to be the topological disk that is the component of the domain of the first landing mapping to \mathbf{W} , respectively \mathbf{W}' , under F that contains c_0 . □

The following gives qc\bg partition for a qr polynomial-like mapping. It is analogous to Theorem 7.5. for a qr polynomial-like renormalization of f at an even critical point c_0 . For an image showing part of the construction see Figure 28.

Lemma 8.12. *There exist $\delta_0 > 0$, $K_1 \geq 1$ and $\hat{K} \geq 1$, such that for any $K, K_0 \geq 1, \delta > 0$ the following holds. Suppose that c_0 is an even critical point at which f is infinitely renormalizable. Suppose that $F: \mathbf{U} \rightarrow \mathbf{V}$ is a $(1 + \mu(\mathbf{V}))$ -qr polynomial-like mapping that extends the first return mapping to a periodic interval of sufficiently high period, where $\partial\mathbf{V}$ is a K_0 -quasidisk. Assume that there exists a (K, δ) -qc\bg mapping $H_0: \mathbb{C} \rightarrow \mathbb{C}$ such that $H_0(\mathbf{V}) = \tilde{\mathbf{V}}$ and $H_0(\mathbf{U}) = \tilde{\mathbf{U}}$. Assume that the set $X_1^{H_0}$ (the set with bounded geometry) has moduli bounds in \mathbf{V} and $\mathbf{V} \cap \mathbb{H}$. Then there exists a (K', δ') -qc\bg mapping $H: \mathbb{C} \rightarrow \mathbb{C}$, with $K' = \max\{\hat{K}, (1 + C\mu(\mathbf{V})), (1 + C\mu(\tilde{\mathbf{V}}))K\}$ and $\delta' = \min\{\delta_0, (1 + C\mu(\mathbf{V}))^{-1}\delta, (1 + C\mu(\tilde{\mathbf{V}}))^{-1}\delta\}$, where $C > 0$ is a universal constant, a partition of \mathbf{V} into combinatorially*

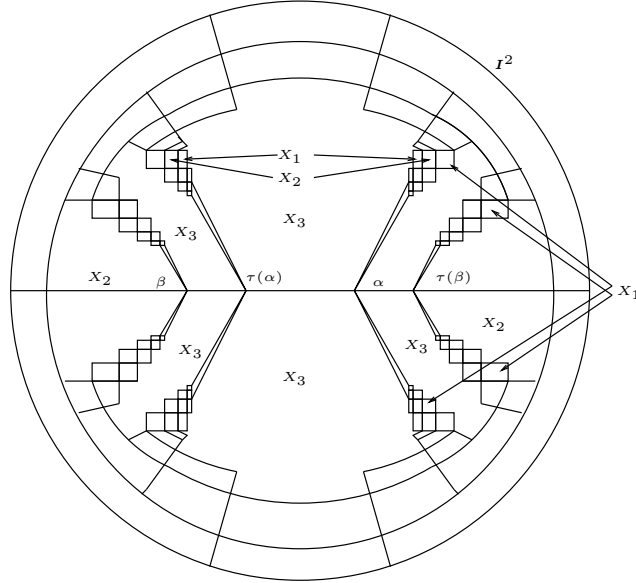

FIGURE 28. The qc\bg partition of a polynomial-like mapping.

defined disjoint sets X_0, X_1, X_2 and X_3 , and a partition of $\tilde{\mathbf{V}}$ into combinatorially defined disjoint sets $\tilde{X}_0, \tilde{X}_1, \tilde{X}_2$ and \tilde{X}_3 such that the following holds:

- (1) $H(X_i) = \tilde{X}_i$, for $i = 0, 1, 2, 3$.
- (2) X_1 is a union of combinatorially defined topological squares \mathbf{S} such that each \mathbf{S} has δ' -bounded geometry and satisfies the following moduli bounds:

$$\text{mod}(\mathbf{U} \setminus \mathbf{S}) > \delta',$$

and if $\mathbf{S} \subset \mathbb{H}^+$, then

$$\text{mod}(\mathbf{U} \cap \mathbb{H} \setminus \mathbf{S}) > \delta'.$$

- (3) Each component of X_3 is a K_1 -quasidisk and H is \hat{K} -qc on X_3 .
- (4) H is K' -qc on X_2 moreover, H is defined dynamically on X_2 and X_2 includes $\mathbf{V} \setminus F^{-2}(\mathbf{U})$, and a combinatorially defined neighbourhood of the rays landing at $\beta, \alpha, \rho, \tau(\beta), \tau(\alpha)$, and $\tau(\rho)$.
- (5) The measure of X_0 is zero and H satisfies (2.1) at each $x \in X_0$.

Remark 8.1. We will prove in Lemma 8.14 that there exists $K_0 \geq 1$ such that that $\partial\mathbf{V}$ is always a K_0 -quasidisk.

Proof. To simplify the notation, let $\mathbf{I} = \mathbf{I}^0 = \mathbf{V}$ and $\mathbf{I}^1 = \mathbf{U}$, so that $F: \mathbf{I}^1 \rightarrow \mathbf{I}^0$, and as usual, we define the puzzle pieces in the principle nest about c_0 by $\mathbf{I}^i = \text{Comp}_{c_0} F^{-i}(\mathbf{I}^0)$. In this case, the puzzle pieces shrink to the filled Julia set of F .

We will only consider the bounded geometry case. We can reduce the big geometry case to the bounded geometry case exactly as we did at the end of the proof of Theorem 7.5.

Let us start by partitioning \mathbf{I} into sets $X_i, i \in \{0, 1, 2, 3\}$. Our construction is similar to the one used to deal with long central cascades when there is a high return; however, we need to partition \mathbf{I} into new ‘‘puzzle pieces’’.

Let β denote the outermost orientation preserving fixed point of F and let $\tau(\beta)$ denote its image under the even symmetry about c_0 . As in the long saddle node case, let $\Gamma_\beta \subset \Gamma'_\beta$

denote the regions intersecting $\mathbf{I}^0 \setminus [\beta, \tau(\beta)]$, which are bounded by $\partial\mathbf{I}^4$ and the staircases γ, γ' , respectively, that connect $\partial\mathbf{I}^4$ with β and $\tau(\beta)$.

We will now construct regions about the rays landing at $\alpha, \tau(\alpha), \rho, \tau(\rho)$. Order the components of $(\mathbf{I}^i \setminus \mathbf{I}^{i+1}) \setminus F^{-i}(\mathbf{I}^0 \setminus \mathbf{I}^0)$ counterclockwise by $S_i^j, j = \{0, \dots, 2d^i\}$ where S_i^0 lies in the upper half-plane is bounded by the component of $I_i \setminus I_{i+1}$ that is contained in the image of I^1 . For each $i \in \mathbb{N} \cup \{0\}$ let $S_i^{j_\alpha}$ be the component of $\cup_{j=0}^{2d^i} S_i^j$ that is contained in the upper half-plane and intersects one of the two rays landing at α , then $S_i^{2d^i+1-j_\alpha}$ is the component of $(\mathbf{I}^i \setminus \mathbf{I}^{i+1}) \setminus F^{-i}(\mathbf{I}^0 \setminus \mathbf{I}^0)$ that lies in the lower half-plane and intersects a ray landing at α . Let $S_{i,\alpha} = S_i^{j_\alpha} \cup S_i^{2d^i+1-j_\alpha}$. We construct the ‘‘shielding’’ region about these topological squares by setting

$$S'_{i,\alpha} = \left(\bigcup_{k=-2}^2 S_i^{j_\alpha+k} \right) \cup \left(\bigcup_{k=-2}^s S_i^{2d^i+1-j_\alpha+k} \right).$$

We let

$$\Gamma_\alpha = \bigcup_{i=0}^{\infty} S_{i,\alpha} \quad \text{and} \quad \Gamma'_\alpha = \bigcup_{i=0}^{\infty} S'_{i,\alpha}.$$

Carrying out identical constructions, we construct regions $\Gamma_a \subset \Gamma'_a$ about the rays landing at a for $a \in \{\tau(\alpha), \rho, \tau(\rho)\}$. We set

$$\Gamma' = \bigcup_{a \in \{\alpha, \beta, \rho, \tau(\alpha), \tau(\beta), \tau(\rho)\}} \Gamma'_a \quad \text{and} \quad \Gamma = \bigcup_{a \in \{\alpha, \beta, \rho, \tau(\alpha), \tau(\beta), \tau(\rho)\}} \Gamma_a.$$

We partition \mathbf{V} as follows:

- $X_1 = (\Gamma' \setminus \Gamma) \cup (\mathbf{I}^3 \setminus (\mathbf{I}^4 \cup \Gamma'))$
- $X_2 = \Gamma \cup \mathbf{I}^0 \setminus \mathbf{I}^3$
- $X_3 = \mathbf{I}^4 \setminus \bar{\Gamma}$
- $X_0 = \mathbf{I}^0 \setminus \overline{X_1 \cup X_2 \cup X_3}$.

We saw in the proof of Lemma 8.10 that there exists a real neighbourhood of W of α such that $F|_W$ is a diffeomorphism and $|W| \asymp \text{diam}(\mathbf{U})$. Thus there exists $\theta \in (0, \pi)$ such that $D_\theta(W)$ contains all the components of $\mathbf{I}^2 \setminus (\mathbf{I}^3 \cup F^{-3}(V \setminus U))$ except those whose boundaries intersect the real line. Since the lengths of $W^i = \text{Comp}_\alpha F^{-i}(W)$ shrink exponentially quickly, we have that the dilation of F^i is bounded, independently of i , on $\Gamma_\alpha \cap (\mathbf{I}^i \setminus \mathbf{I}^{i+1})$. The proof is similar in the other components of $\Gamma \cap (\mathbf{I}^i \setminus \mathbf{I}^{i+1})$.

Suppose that \mathbf{W} is a component of $(\mathbf{I}^4 \setminus \Gamma') \cap \mathbb{H}$. We will use Lemma 7.12 to show that \mathbf{W} is a \hat{K} -quasidisk for some universal \hat{K} . To be concrete we will carry out the proof in a specific case. The proofs for the other components are identical. We assume \mathbf{W} is a topological rectangle with $\partial\mathbf{W} = \bar{\eta}_1 \cup \eta_2 \cup \eta_3 \cup \eta_4$ where $\eta_1 \subset \partial\mathbf{I}^4$, $\eta_2 \subset \partial\Gamma'_\alpha$, $\eta_3 \subset \mathbb{R}$ and $\eta_4 \subset \partial\Gamma'_{\tau(\beta)}$.

Since $\partial\mathbf{V}$ is a K_0 -quasicircle, we have that η_1 is a k -quasiarc. We verify that both η_2 and η_4 are k -quasiarcs, exactly as we showed that γ is a quasiarc in the central cascades, high return argument, see page 114. We have that η_3 is a 1-quasiarc since it is an interval in the real line. Theorem 5.1 implies that there exists $\delta_1 > 0$ such that $\text{dist}(\eta_1, \eta_3) \geq \delta_1 \text{diam}(\mathbf{I}^4)$, and that for each $i \in \{1, 2, 3, 4\}$, we have $\text{diam}(\eta_i) > \delta_1 \text{diam}(\mathbf{I}^4)$. A compactness argument shows that there exists $\delta_2 > 0$ such that $\text{dist}(\eta_2, \eta_4) \geq \delta_2 \text{diam}(\mathbf{I}^4)$.

So it remains for us to show that the Ahlfors-Beurling Criterion holds on adjacent boundary arcs. The arguments are similar near the intersections $\bar{\eta}_1 \cap \bar{\eta}_2$ and $\bar{\eta}_1 \cap \bar{\eta}_4$, and near $\bar{\eta}_3 \cap \bar{\eta}_2$ and

$\bar{\eta}_3 \cap \bar{\eta}_4$. So let us only consider the cases when $z_1 \in \eta_1, z_2 \in \eta_2$ and when $z_1 \in \eta_3$ and $z_2 \in \eta_2$. First suppose that $z_1 \in \eta_1, z_2 \in \eta_2$ and z_2 is not contained in $F^{-4}(I^0 \setminus I^2)$, then, there exists a constant $c > 0$ such that $|z_1 - z_2| > c \cdot \text{diam}(I^4)$, and so $|z_1 - z_2| \geq c \cdot \text{diam}(\gamma_{[z_1, z_2]})$, so we can assume that $z_2 \in F^{-4}(I^0 \setminus I^2)$. Then we have that $\gamma_{[z_1, z_2]}$ consists of an arc in $F^{-4}(I^0 \setminus I^2)$ and an arc in α_1 . Since I^0 is a real-symmetric K_0 -quasidisk, we have that for any $x \in I^0 \setminus I^1$ and $z \in \partial I^0$, there exists $c' > 0$ such that $|x - z| \geq c' \cdot \text{diam}(\eta')$ where η' is the shortest path in $\partial I^0 \cup \mathbb{R}$ connecting x and z . Since there exists a definite neighbourhood U of $\gamma_{[z_1, z_2]}$ such that F^4 has small dilatation on U , $F^4(z_1) \in I^0$ and $F^4(z_2) \in (I^0 \setminus I^2)$, there exists $c > 0$ such that $|z_1 - z_2| \geq c \cdot \text{diam}(\gamma_{[z_1, z_2]})$. In case $z_1 \in \eta_3$ and $z_2 \in \eta_2$ the estimate follows exactly as in the proof that Y has bounded shape.

We construct H using the same method as in the proof of Theorem 7.5. We define it on X_2 dynamically, by pulling H_0 back. We have shown that each component W of X_3 is a K_1 -quasidisk. Using the same argument as in the high return case, we define $H: W \rightarrow \tilde{W}$ so that it is \hat{K} -qc mapping which maps each point of $\partial W \cap \Gamma' \cap \partial I^i$ to the corresponding point for \tilde{F} , for $i = 4, 5, 6, \dots$. Finally, we extend H so that it is a homeomorphism on V , maps each topological square in $\Gamma' \setminus \Gamma$ to the corresponding topological square for \tilde{F} and satisfies (2.1) on X_0 , which contains the boundary of each such topological square. \square

The following proposition combines Lemmas 8.11 and 8.12 in the case when $F: U \rightarrow V$ is immediately renormalizable.

Lemma 8.13. *There exist $K_1, \hat{K} \geq 1$, and $\delta_0, \delta_1 > 0$, such that for any $K_0 \geq 1, K \geq 1$ and $\delta > 0$ the following holds. Suppose that $F: U \rightarrow V$ is a qr polynomial-like mapping that extends the return mapping to a periodic interval $I \ni c_0$ of sufficiently high period. Assume that $H_0: \mathbb{C} \rightarrow \mathbb{C}$ is a (K, δ) -qc\bg mapping such that $H_0(V) = \tilde{V}, H_0(U) = \tilde{U}$, and for $z \in \partial U, H_0 \circ F(z) = \tilde{F} \circ H_0(z)$. Let $X_1^{H_0}$ be the set with bounded geometry for H_0 . Suppose that F is immediately renormalizable, and let $J = (\alpha, \tau(\alpha)) = (\beta', \tau(\beta'))$ be the periodic interval of period two under F . Then there exists a qr polynomial-like renormalization $F': U' \rightarrow V'$ such that V' is combinatorially defined and $\text{mod}(V' \setminus U') > \delta_1$. Moreover, there exist a (K', δ') -qr\bg mapping $H: V \rightarrow \tilde{V}$, with $K' = \max\{\hat{K}, (1 + \mu(V))(1 + \mu(\tilde{V}))K\}$ and $\delta' = \min\{\delta_0, (1 + C\mu(V))^{-1}\delta, (1 + C\mu(\tilde{V}))^{-1}\delta\}$, where $C > 0$ is a universal constant, a partition of V into sets $V = X_0 \cup X_1 \cup X_2 \cup X_3$, and similarly for the objects marked with a tilde, such that*

- (1) $H(X_i) = \tilde{X}_i$, for $i = 0, 1, 2, 3$.
- (2) $H(V') = \tilde{V}', H(U') = \tilde{U}'$ and if $x \in \partial U'$ then $H(F^i(z)) = \tilde{F}^i(H(z)), i = 1, 2$.
- (3) X_1 is a union of combinatorially defined topological squares S such that each S has δ' -bounded geometry and satisfies the following moduli bounds:

$$\text{mod}(U \setminus S) > \delta',$$

and if $S \subset \mathbb{H}^+$, then

$$\text{mod}(U \cap \mathbb{H} \setminus S) > \delta'.$$

- (4) Each component of X_3 is a K_1 -quasidisk and H is \hat{K} -qc on X_3 .
- (5) H is K' -qc on X_2 moreover, H is defined dynamically on X_2 and X_2 includes $V^0 \setminus F^{-1}(U)$, and a combinatorially defined neighbourhood of the rays landing at $\beta, \alpha, \zeta, \tau(\beta), \tau(\alpha)$, and ζ' , where $\zeta, \zeta' \in U$ are the real preimages of $\tau(\alpha)$.
- (6) The measure of X_0 is zero and H satisfies (2.1) on X_0 .

Proof. The first part of the proof of this lemma is almost the same as the proof of Lemma 8.12; however, we are going to construct larger shielding regions about the rays. Instead of using two “squares” on either side of the square containing the ray, we will use three. This will let us use the outer boundary of this “shielding region” as part of the boundary of \mathbf{V}' .

Let $\mathbf{I}^0 = \mathbf{V}$, and as usual, let $\mathbf{I}^{i+1} = \text{Comp}_{c_0}(\mathbf{I}^i)$. We will first construct regions about the rays landing at $\alpha, \tau(\alpha), \zeta$ and ζ' . As before, order the components of $(\mathbf{I}^i \setminus \mathbf{I}^{i+1}) \setminus F^{-i}(I^0 \setminus I^0)$ counterclockwise by S_i^j , $j = \{0, \dots, 2d^i\}$. For each $i \in \mathbb{N} \cup \{0\}$ let $S_i^{j\alpha}$ be the component of $\cup_{j=0}^{2d^i} S_i^j$ that is contained in the upper half-plane and intersects a ray landing at α . Let $S_{i,\alpha} = S_i^{j\alpha} \cup S_i^{2d^i+1-j\alpha}$. We set

$$S'_{i,\alpha} = \cup_{k=-3}^3 S_i^{j\alpha+k} \cup \cup_{k=-2}^s S_i^{2d^i+1-j\alpha+k}.$$

We let

$$\Gamma_\alpha = \cup_{i=0}^\infty S_{i,\alpha} \text{ and } \Gamma'_\alpha = \cup_{i=0}^\infty S'_{i,\alpha}.$$

Carrying out identical constructions, we construct regions $\Gamma_a \subset \Gamma'_a$ about the rays landing at a for $a \in \{\tau(\alpha), \zeta, \zeta'\}$. We set

$$\Gamma' = \bigcup_{a \in \{\alpha, \beta, \tau(\alpha), \tau(\beta), \zeta, \zeta'\}} \Gamma'_a \text{ and } \Gamma = \bigcup_{a \in \{\alpha, \beta, \tau(\alpha), \tau(\beta), \zeta, \zeta'\}} \Gamma_a.$$

Let us now construct little topological disks about α and its preimages. Let α' be the orientation reversing fixed point of F^2 closest to c_0 . Let $x_0 = \alpha'$, and let x_{i+1} be the point in $F^{-1}(x_i)$ that is contained in the monotone branch of F which contains α . Then the x_i converge to α from either side at a definite exponential rate. We can choose i_0 so that $|\alpha - x_{i_0}|$ and $|\alpha - x_{i_0+1}|$ are both comparable to $|U|$. Now, choose D_α so that $\partial D_\alpha \cap \partial \Gamma'_\alpha$ are combinatorially defined points lying the $\partial \mathbf{I}^{i_0} \cap F^{-i_0}(\overline{V} \setminus \overline{U})$. By doing this, we can carry out this construction simultaneously for F and \tilde{F} .

Let $D'_\alpha = \text{Comp}_\alpha F^{-1}(D_\alpha)$ By [dMvS], Chapter IV, Theorem B $|DF(\alpha)| > 1 + \eta$, so $\text{mod}(D_\alpha \setminus D_{\tau(\alpha)})$ is bounded away from zero. Let $D_{\tau(\alpha)} = \text{Comp}_{\tau(\alpha)} F^{-1}(D_\alpha)$ and let $D_\zeta = \text{Comp}_\zeta F^{-1}(D_{\tau(\alpha)})$, and $D_{\zeta'} = \text{Comp}_{\zeta'} F^{-1}(D_{\tau(\alpha)})$. Set

$$\Delta' = \cup_{a \in \{\alpha, \tau(\alpha), \zeta, \zeta'\}} D_a.$$

Let us now define an intermediate qc mapping $H': \mathbf{V} \rightarrow \tilde{\mathbf{V}}$ that agrees with H_0 on ∂U . This is identical to the construction of H in Lemma 8.12, so we will be brief. We define H' in the annuli, $F^{-i}(\mathbf{V} \setminus \mathbf{U})$ for $i = 1, 2, 3$, by pulling back H_0 . The components of $\mathbf{I}^4 \setminus \overline{\Gamma' \cup \Delta'}$ are K_1 -quasidisks, which can be seen by using Lemma 7.12, so as in the proof of Theorem 7.5 in the high return case, for any component \mathbf{W} of $\mathbf{I}^4 \setminus \overline{\Gamma' \cup \Delta'}$ we can define a \hat{K} -qc mapping from \mathbf{W} to $\tilde{\mathbf{W}}$ that is a conjugacy on $\overline{\Gamma'} \cap \partial \mathbf{I}_i \cap \partial \mathbf{W}$ for $i = 5, 6, \dots$. We define H' on Γ and in Δ by pulling back the mappings already constructed. We extend it to each topological square $\overline{\mathbf{S}}$ of $\Gamma' \setminus \Gamma$ so that it is a homomorphism and satisfies (2.1) at each point $x \in \partial \mathbf{S}$, for each \mathbf{S} .

We obtain a polynomial-like mapping with complex bounds that extends $F^2|_{\alpha, \tau(\alpha)}$ as follows: Let

- v_1 be the connected component of $\partial D \setminus \Gamma'_\alpha$ that does not intersect $(\alpha, \tau(\alpha))$,
- v_2 be the two arcs of $\partial \Gamma'_\alpha \setminus \partial U$ that intersect \bar{v}_α ,
- v_3 be the connected component of $\partial D_{\tau(\alpha)} \setminus \Gamma'_{\tau(\alpha)}$ that does not intersect $(\alpha, \tau(\alpha))$,
- v_4 be two arcs of $\partial \Gamma'_{\tau(\alpha)} \setminus \partial U$ that intersect $\bar{v}_{\tau(\alpha)}$, and

- v_5 be the two arcs of $\partial\mathbf{U}$ lying in the upper and lower half-planes, respectively, that connect v_2 and v_4 .

Let \mathbf{V}' be the region bounded by $\overline{v_1 \cup v_2 \cup v_3 \cup v_4 \cup v_5}$, and let $\mathbf{U}' = \text{Comp}_{c_0} F^{-2}(\mathbf{V}')$. By construction we have that $\mathbf{U}' \Subset \mathbf{V}'$. Since $\text{diam}(J_F) \asymp \text{diam}(\mathbf{V}')$ and $\text{dist}(\partial\mathbf{V}', J_{F^2})$ is bounded away from zero, we have that $\text{mod}(\mathbf{V}' \setminus \mathbf{U}')$ is also bounded away from 0. We have already defined H' on \mathbf{V} so that $H'(\mathbf{V}') = \tilde{\mathbf{V}}'$. Now we are going to define H . Outside of \mathbf{U}' , we define H by pulling back H' . To define H in \mathbf{U}' , we use the same ideas as before: In the sets $\Delta' \cap \mathbf{U}'$ and $\Gamma \cap \mathbf{U}'$, H is already defined and the complementary regions in \mathbf{U} consist of a K_1 -quasidisk, and a region consisting of topological squares with bounded geometry and with moduli bounds as stated in conclusion (2) of the lemma. \square

Lemma 8.14. *For any $K'_0 \geq 1$ there exists $K_0 \geq 1$ such that the following holds. Suppose that f is infinitely renormalizable at an even critical point c_0 . Suppose that $F_0: \mathbf{U}_0 \rightarrow \mathbf{V}_0$ is a qr polynomial-like mapping that extends the first return mapping to a periodic interval $J_0 \ni c_0$ of sufficiently high period s . Let $s_0 = s$ and for $i \in \mathbb{N}$, let $s_i > s_{i-1}$ be minimal so that there exists a periodic interval $J_i \ni c_0$ of period s_i . Assume that \mathbf{V}_0 is a K'_0 -quasidisk. Then there exists a qr polynomial-like mapping $F_i: \mathbf{U}_i \rightarrow \mathbf{V}_i$ that extends $f^{s_i}: J_i \rightarrow J_i$ such that \mathbf{V}_i is a K_0 -quasidisk.*

Proof. We will use Lemma 7.12. Let us consider the case when there are several immediately renormalizable levels in a row. Let $F_i: \mathbf{U}_i \rightarrow \mathbf{V}_i$ denote this sequence of renormalization levels $i = 1, 2, 3, \dots, k$. Suppose that $z_1, z_2 \in \partial\mathbf{V}_k$, and let $\gamma_{[z_1, z_2]}$ denote the shortest path connecting z_1 and z_2 in $\partial\mathbf{V}_k$. The boundary of \mathbf{V}_k consists of arcs in \mathbf{I}_{k-1}^6 , arcs in $\partial\Delta_k$ and arcs in $\partial\Gamma'_k$. If $\gamma_{[z_1, z_2]} \subset \partial\Delta_k \cup \partial\Gamma'_k$, then arguing exactly as for the staircases landing at the β fixed point in the high return case, we have that there exists a constant C such that $\text{diam}(\gamma_{[z_1, z_2]}) \leq C|z_1 - z_2|$. Thus we can assume that $\gamma_{[z_1, z_2]} \cap \partial\mathbf{I}_{k-1}^6 \neq \emptyset$. If $\gamma_{[z_1, z_2]} \cap \mathbf{I}_{k-1}^7 \neq \emptyset$, then by the moduli bounds, we have that there exists C , depending only on the moduli bounds, such that $|z_1 - z_2| \geq \frac{1}{C} \text{diam}(\mathbf{V}_k) \geq \frac{1}{C} \text{diam}(\gamma_{[z_1, z_2]})$. So we can assume that $\gamma_{[z_1, z_2]} \cap \partial\mathbf{I}_{k-1}^6 \neq \emptyset$ and $\gamma_{[z_1, z_2]} \cap \mathbf{I}_{k-1}^7 = \emptyset$. Now we have that $F_{k-1}^6(\gamma_{[z_1, z_2]}) \subset \partial\mathbf{V}_{k-1} \cup \mathbf{V}_{k-1} \setminus \mathbf{U}_{k-1}$. If $F_{k-1}^6(\gamma_{[z_1, z_2]}) \cap \mathbf{V}_{k-1} \setminus \mathbf{U}_{k-1} \neq \emptyset$, then, since $\partial\Delta_{k-1} \cap \partial\mathbf{V}_{k-1}$ consists of K_2 -quasiarcs (for a universal K_2), and the diameters and the distances between the arcs in $\partial\Delta_{k-1} \cap \partial\mathbf{V}_{k-1}$, and $\text{diam}(\partial\Gamma'_{k-1} \cap \partial\mathbf{V}_{k-1})$ are all comparable to $\text{diam}(\mathbf{V}_{k-1})$, we have that there exists C' such that $C'|F_{k-1}^6(z_1) - F_{k-1}^6(z_2)| \geq \text{diam}(F_{k-1}^6(\gamma_{[z_1, z_2]}))$, and so there exists C such that $C|z_1 - z_2| \geq \gamma_{[z_1, z_2]}$, since F_{k-1}^6 has small dilatation in a definite neighbourhood of $\gamma_{[z_1, z_2]}$. Thus we can assume that $F_{k-1}^6(\gamma_{[z_1, z_2]}) \subset \partial\mathbf{V}_{k-1}$. Now we can repeat the argument that we just gave to show that $F_{k-1}^6(\gamma_{[z_1, z_2]}) \cap \partial\mathbf{I}_{k-2}^6 \neq \emptyset$ and $F_{k-1}^6(\gamma_{[z_1, z_2]}) \cap \mathbf{I}_{k-2}^7 = \emptyset$, and again if $F_{k-2}^6(F_{k-1}^6(\gamma_{[z_1, z_2]})) \cap \mathbf{V}_{k-2} \setminus \mathbf{U}_{k-2} \neq \emptyset$, we have that there exists C' such that $C'|F_{k-2}^6 \circ F_{k-1}^6(z_1) - F_{k-2}^6 \circ F_{k-1}^6(z_2)| \geq \text{diam}(F_{k-2}^6(F_{k-1}^6(\gamma_{[z_1, z_2]})))$, and again we are done since $F_{k-2}^6 \circ F_{k-1}^6$ has bounded dilatation in a definite neighbourhood of $\gamma_{[z_1, z_2]}$. So we can assume that $F_{k-2}^6(F_{k-1}^6(\gamma_{[z_1, z_2]})) \subset \partial\mathbf{V}_{k-2}$. We can repeat this argument infinitely many times since, in the circumstances where we repeat the argument, by the moduli bounds, the dilatation of $F_i^6 \circ F_{i+1}^6 \circ \dots \circ F_{k-1}^6$ is bounded in a neighbourhood of $\gamma_{[z_1, z_2]}$.

The proof is the almost the same in the general case, when there are both immediate and non-immediate renormalizations of f about a critical point c_0 . However, if $F_{i-1}: \mathbf{U}_{i-1} \rightarrow \mathbf{V}_{i-1}$ is not immediately renormalizable, then $F_i: \mathbf{U}_i \rightarrow \mathbf{V}_i$ is the first return mapping from $\mathbf{U}_i = \mathcal{L}_{c_0}(\mathbf{P})$ to $\mathbf{V}_i = \mathbf{P}$, where \mathbf{P} is the puzzle piece given by Lemma 8.11. The domain $\mathbf{P} = \mathbf{I}_n$ is the first terminating interval in the enhanced nest about c_0 , starting with $\mathbf{I}_0 = \mathbf{Q}$,

see the proof of Lemma 8.11. So $F_{i-1}^{p_{n-1}+p_{n-2}+\dots+p_0} : \mathbf{P} \rightarrow \mathbf{Q}$ has bounded dilatation, and we can argue as in Proposition 5.12 in between renormalization levels, and we can argue as in the immediately renormalizable case to pass from one renormalization to the next. \square

Concluding the infinitely renormalizable case. Let c_0 be an even critical point at which f is infinitely renormalizable. To conclude the infinitely renormalizable case, let us describe how to use these lemmas to build a qc\bg mapping that gives a partial conjugacy between f and \tilde{f} ; that is, a conjugacy between f and \tilde{f} defined on a subset of M up to the landing time of a point to a neighbourhood of $\text{Crit}(f) \cap \omega(c_0)$. Let $J_0 \ni c_0$ be a sufficiently small periodic interval that contains c_0 . Let s_0 be the period of J_0 . Inductively define $s_{i+1} > s_i$, minimal, so that there exists a periodic interval $J_{i+1} \ni c_0$ with period s_{i+1} . Let $F_i : \mathbf{U}_i \rightarrow \mathbf{V}_i$ be the qr polynomial-like mapping that extends the return mapping to J_i , where we choose the qr polynomial-like mappings $F_i : \mathbf{U}_i \rightarrow \mathbf{V}_i$ as follows: The mapping $F_0 : \mathbf{U}_0 \rightarrow \mathbf{V}_0$ is given by Theorem 5.1. Inductively, we define $F_{i+1} : \mathbf{U}_{i+1} \rightarrow \mathbf{V}_{i+1}$, if F_i is not immediately renormalizable $F_{i+1} : \mathbf{U}_{i+1} \rightarrow \mathbf{V}_{i+1}$ is given by the first return mapping to the first terminating interval in the enhanced nest about c_0 starting with $\mathbf{I}_0 = \mathbf{Q}$, where \mathbf{Q} is the puzzle piece from the proof of Lemma 8.11, and if F_i is immediately renormalizable, $F_{i+1} : \mathbf{U}_{i+1} \rightarrow \mathbf{V}_{i+1}$ is the qr polynomial-like mapping given by Lemma 8.13. Let $\{J_i^j\}_{j=0}^{s_i}$ be the chain of intervals with $J_i^{s_i} = J_i$ and $J_i^j = \text{Comp}_{f^j(c_0)} f^{-(s_i-j)}(J_i)$. Let $\{\mathbf{U}_i^j\}$ be the chain of domains associated to the first return mapping $F_i : \mathbf{U}_i \rightarrow \mathbf{V}_i$, so that $\mathbf{U}_i^j \supset J_i^j$. Since there are only finitely many components of $\{\mathbf{U}_0^j\}$ it is easy to build by hand a qc mapping H_0 of the plane so that for $0 \leq j < s_0 - 1$, $H_0(\mathbf{U}_0^j) = \tilde{\mathbf{U}}_0^j$, $z \in \partial\mathbf{U}_0^j$ we have $H_0 \circ f(z) = \tilde{f} \circ H_0(z)$. Now, Lemma 8.12 allows us to extend H_0 as a qc\bg mapping to a mapping $H'_0 : \mathbf{V}_0 \rightarrow \tilde{\mathbf{V}}_0$ so that it preserves some additional dynamical information inside of \mathbf{V}_0 , see the conclusion of Lemma 8.12. If the next renormalization is not of intersection type, then by Theorem 7.5 and the (proof of) the Real Spreading Principle, we obtain a qc\bg mapping H_1 of the plane such that $H_0(\mathbf{U}_1^j) = \tilde{\mathbf{U}}_1^j$, if $z \in \partial\mathbf{U}_0^j$ we have $H_0 \circ f(z) = \tilde{f} \circ H_0(z)$, and for $z \notin \mathbf{V}_1$ we have $H_1 \circ f(z) = \tilde{f} \circ H_1(z)$. Thus we can continue on to the next renormalization level.

If the next renormalization level is of intersection type, then we have from Lemma 8.13, a qc\bg mapping H'_0 of the plane such that $H'_0(\mathbf{U}_1^j) = \tilde{\mathbf{U}}_1^j$, and for $0 \leq j < s_1 - 1$, $z \in \partial\mathbf{U}_1^j$ $H'_0 \circ f(z) = \tilde{f} \circ H'_0(z)$. We need to extend H'_0 to the union of intervals $\cup_{j=0}^{s_0-1} \mathbf{V}_0^j$, so that it is a conjugacy outside of a neighbourhood of the critical points. In this case, all the critical points of $F_0 : \mathbf{U}_0 \rightarrow \mathbf{V}_0$ are contained in $(-\alpha, \tau(\alpha)) \cup (\alpha, \zeta)$, where we choose ζ to be the preimage of $\tau(\alpha)$ that is closest to α . First, we extend H'_0 to the component \mathbf{X} of $\mathbf{V}_0 \setminus \Gamma'$ that has β_0 in its boundary. Since this branch contains no critical points, we define H'_0 dynamically. If $z \in \mathbf{X}$ and $k > 0$ is minimal so that $F_0^k(z) \in \text{Comp}_{c_0}(\mathbf{V}_0 \setminus \Gamma') \cup \Gamma'_{\tau(\alpha)}$, then we define $H'_0(z)$ by $\tilde{F}_0^k \circ H'_0(z) = H'_0 \circ F_0^k(z)$. We define H'_0 on the component of $\mathbf{V}_0 \setminus \Gamma'$ that has $\tau(\beta)$ in its boundary by pulling the extension of H'_0 just constructed back by one iterate of F . Now, we spread this around to the each \mathbf{V}_0^j by pulling back by the landing mapping $f^{s_0-j} : \mathbf{V}_0^j \rightarrow \mathbf{V}_0$, except that we extend H'_0 to each component of the partition that contains a critical point using the fact that it is a quasidisk, that is bounded by topological squares with bounded geometry and moduli bounds as in the conclusion of Lemma 8.13, and the same argument to build a \hat{K} -qc mapping that we have used many times.

Observe that the qc constants and geometric bounds are controlled as we pullback from one level to the next since $\text{diam}(\mathbf{V}_i)$ decay exponentially.

8.4. The persistently recurrent, finitely renormalizable case. In the remaining sections, we will consider the smooth and analytic cases together. In the analytic case, we obtain a qc mapping that conjugates the dynamics of f and \tilde{f} in a necklace neighbourhood of the real line, but in the smooth case we only obtain a conjugacy on the real-line. It is important to observe that this conjugacy is obtained as the restriction to the real-line of a qc\bog mapping in the upper half-plane, which is quasiasymmetric by the QC Criterion.

In this section we treat critical points $c \in \text{Crit}(f)$ such that $\omega(c)$ is persistently recurrent and f is not infinitely renormalizable at c . Fix such a critical point c and let \tilde{c} be the corresponding critical point for \tilde{f} . In this case, Theorem 5.1 implies that c and \tilde{c} possess arbitrarily small combinatorially defined nice real neighbourhoods I and \tilde{I} , such that the first return maps to $I \cup \cup_{c' \in \omega(c)} \mathcal{L}_{c'}(I)$ and $\tilde{I} \cup \cup_{\tilde{c}' \in \omega(\tilde{c})} \mathcal{L}_{\tilde{c}'}(\tilde{I})$ restricted to components that intersect $\omega(c)$ and $\omega(\tilde{c})$, respectively, extend to complex box mappings

$$F: \mathcal{U} \rightarrow \mathcal{V} \text{ and } \tilde{F}: \tilde{\mathcal{U}} \rightarrow \tilde{\mathcal{V}}$$

whose ranges are δ -nice and have δ -bounded geometry. Moreover, these box mappings are strongly combinatorially equivalent.

If F and \tilde{F} are analytic, by Theorem 7.3, these mappings are qc-conjugate provided that there exists a quasiconformal external conjugacy between the maps. Since both \mathcal{U} and $\tilde{\mathcal{U}}$ consist of just finitely many components, whose boundaries are piecewise smooth Jordan curves with a finite number of corners, such a conjugacy is simple to construct. On the other hand, if F and \tilde{F} are C^3 , then we still have that there is an external conjugacy between F and \tilde{F} ; however, we do not have that F and \tilde{F} are qc-conjugate. Instead by Theorem 7.5 and the argument used to prove the Real Spreading Principle, we have that there exist $K \geq 1$ and $\delta > 0$ and a (K, δ) -qc\bog mapping in the upper half-plane $H: \mathcal{V} \rightarrow \tilde{\mathcal{V}}$ that conjugates F and \tilde{F} on their real traces.

In the analytic case, we immediately get that the box mappings $F: \mathcal{U} \rightarrow \mathcal{V}$ and $\tilde{F}: \tilde{\mathcal{U}} \rightarrow \tilde{\mathcal{V}}$ are qc-conjugate by a quasiconformal homeomorphism $h: \mathcal{V} \rightarrow \tilde{\mathcal{V}}$ that is a conjugacy on the set

$$K(I_1) = \{z : (R_{I_1})^n(z) \in \text{Dom}_{\Omega_1}(I_1) \text{ for all } n \geq 0\} \supset \omega(c),$$

where $\text{Dom}_{\Omega_1}(I_1)$ is as defined on Page 29. In the smooth case, we have that h is qc\bog in the upper half-plane, so again, by the QC Criterion, we have that $h|_{\mathbb{R}}$ is a quasiasymmetric mapping that is a conjugacy on $K(I_1)$.

Recall that $I_1 = \cup_{c \in \Omega_1 \setminus \Omega'_1} \mathcal{L}_c(I) \cup I'_1$, $\text{Dom}_{\Omega_1}(I_1)$ is the collection of components of $\text{Dom}(I_1)$ that intersect $\cup_{c \in \Omega_1} \omega(c)$ and $\text{Dom}_{\text{diff}}(I_1)$ is the union of components, J , of $\text{Dom}(I_1)$ satisfying

- (1) $J \subset I'_1$;
- (2) $J \cap (\cup_{c \in \Omega_1} \omega(c)) = \emptyset$;
- (3) if s is the first return time of J to I_1 , then $f^i(J) \cap \mathcal{I} = \emptyset$ for all $i = 0, 1, \dots, s - 1$.

Consider the first entry map

$$R_{\hat{I}_*} : \text{Dom}_{\Omega_1}(I_1) \cup \text{Dom}_{\text{diff}}(I_1) \cup (\text{Dom}(I_0) \cap I) \rightarrow I_1 \cup I_0.$$

By definition if J is a component of the domain and $s = s(J)$ is its return time, then $f^i(J) \cap \mathcal{I} = \emptyset$ for $i = 1, \dots, s - 1$. By Theorem 5.2, there exists an integer m such that the m -th iterate of this map has an extension to a complex box mapping

$$F_{it}: \mathcal{U}_{it} \rightarrow \mathcal{V}_{it}$$

with $\mathcal{V}_{it} \cap \mathbb{R} = I_1 \cup I$ such that \mathcal{V}_{it} is δ -nice and any component of either \mathcal{U}_{it} or \mathcal{V}_{it} has δ -bounded geometry, and so that the mapping $F_{it}: \text{Dom}_{\Omega_1}(\mathcal{V}_{it}) \rightarrow \mathcal{V}_{it}$; that is, the mapping F_{it} restricted to components of the domain that intersect $\omega(c)$, for some $c \in \Omega_1$, satisfies the gap and extension conditions. From this it is easy to construct a box mapping $F'_{it}: \mathcal{U}'_{it} \rightarrow \mathcal{V}'_{it}$ where $\mathcal{V}'_{it} = \cup_{c \in \Omega'_1} \mathcal{V}_{it}(c)$, and each component of \mathcal{U}'_{it} is a component of \mathcal{U}_{it} (if necessary, simply post-compose $F_{it}|_{\mathcal{U}}$ by a first landing onto some component $V \ni c$ of \mathcal{V}_{it} with $c \in \Omega'_1$). As usual, we mark the corresponding object for \tilde{f} with a tilde. Moreover, by Theorem 6.1, the set

$$E(\mathcal{I}) = \{z \in [0, 1] : f^n(z) \notin \mathcal{I}, \text{ for } n = 0, 1, \dots\}$$

is quasiconformally rigid. Since $\partial \text{Dom}_{\Omega_1}(I_1) \cup \partial \text{Dom}_{\text{diff}}(I_1) \subset E(\mathcal{I})$, it follows that we may apply Theorem 7.1 to obtain a quasiconformal external conjugacy between F'_{it} and \tilde{F}'_{it} . In the analytic case, we have that Theorem 7.3 implies that $F'_{it}: \mathcal{U}'_{it} \rightarrow \mathcal{V}'_{it}$ and the corresponding box mapping $\tilde{F}'_{it}: \tilde{\mathcal{U}}'_{it} \rightarrow \tilde{\mathcal{V}}'_{it}$ are quasiconformally conjugate. Arguing as before in the smooth case we have that there exists a qc\bg mapping in the upper half-plane that conjugates F'_{it} and \tilde{F}'_{it} on their real traces. It follows that the set

$$K_m(I_0 \cup I_1 \cup \mathcal{I}^{\text{Comp}}) = \{z : (R_{\hat{f}_*})^{mn}(z) \in I_0 \cup I_1 \cup E(\mathcal{I}) \text{ for all } n \geq 0\}$$

is quasiconformally rigid. By pulling back at most m times along the branches of

$$R_{\hat{f}_*}: \text{Dom}_{\Omega_1}(I_1) \cup \text{Dom}_{\text{diff}}(I_1) \rightarrow I_1$$

one can obtain a quasisymmetric homeomorphism that is a conjugacy on the set

$$(8.1) \quad K(I_0 \cup I_1 \cup \mathcal{I}^{\text{Comp}}) = \{z : (R_{\hat{f}_*})^n(z) \in I_0 \cup I_1 \cup E(\mathcal{I}) \text{ for all } n \geq 0\}.$$

8.5. The reluctantly recurrent case. Finally, we treat the critical points; $c \in \Omega_2$ such that f is reluctantly recurrent at c . Let $\Omega_r \subset \Omega_2$ be a non-trivial block of critical points such that each recurrent critical point $c \in \Omega_r$ is reluctantly recurrent, and with the property that if Ω is the component of the graph on the critical points that contains Ω_r , then f is not infinitely renormalizable at any $c' \in \Omega$. Since we have rigidity away from the critical set, we may as well assume that if $c \in \Omega_r$ is non-recurrent, then the orbit of c accumulates on a critical point in Ω_r . Let $\Omega'_r \subset \Omega_r$ denote a smallest set of critical points such that each critical point in Ω'_r is recurrent, and any critical point $c \in \Omega_r \setminus \Omega'_r$ accumulates on some critical point $c' \in \Omega'_r$.

Let I_r denote a small real neighbourhood of Ω_r with the properties given by Proposition 4.14, and let $I'_r = \cup_{c \in \Omega'_r} I_r(c)$.

Let

$$R_{I_r}: \text{Dom}_{\Omega_r}(I_r) \cup \text{Dom}_{I_0 \cup I'_1}(I_r) \rightarrow I_r \cup I_0 \cup I'_1$$

denote the first entry map, where $\text{Dom}_{\Omega}(I_r)$ denotes the collection of domains of the return mapping to I_r that intersect $\omega(c)$ for some critical point $c \in \Omega_r$ and $\text{Dom}_{I_0 \cup I'_1}(I_r)$ consists of the intervals in I_r that are eventually mapped into $I_0 \cup I'_1$.

By Theorem 5.3 and our choice of neighbourhood of $\text{Crit}(f)$, we can assume that this mapping has an extension to a box mapping

$$\hat{F}: \mathcal{U} \rightarrow \mathcal{V},$$

where for components $I_{0,i}$ of I_0 the set $\text{Comp}_{I_{0,i}} \mathcal{V}$ is a Poincaré disk $D_{\pi-\theta_0}(I_{0,i})$, for components $I'_{1,i}$ of I'_1 the set $\text{Comp}_{I'_{1,i}} \mathcal{V}$ is a Poincaré disk $D_{\pi-\theta_1}(I'_{1,i})$ and for components $I'_{r,i}$ of I'_r the set $\text{Comp}_{I'_{r,i}} \mathcal{V}$ is a Poincaré disk $D_{\pi-\theta}(I'_{r,i})$, where $0 < \theta_0 < \theta_1 < \theta$, and restricted to

components that intersect the orbit of a critical point $c \in \Omega_r$ this box mapping has the gap and extension properties. The angles θ_0, θ_1 are chosen as in the proof of Theorem 5.2.

Claim: $\partial\mathcal{U} \cap \mathbb{R}$ is qs-rigid.

Proof. Let

$$E(I_r) = \{x \in [0, 1] : f^n(x) \notin I_r \text{ for all } n \geq 0\}, \quad E'(I_r) = \{x \in [0, 1] : f^n(x) \notin I_r \text{ for all } n \geq 1\}$$

and

$$CV(f) = \{f(c) : c \in \Omega_r \text{ and } f(c) \notin E(I_r)\}.$$

Notice that $\partial\mathcal{U} \cap \mathbb{R} \subset E'(I_r)$. Consider a touching box mapping as in Subsection 6.3

$$F_T: \mathcal{U}_T \rightarrow \mathcal{V}_T,$$

so that the components of $\mathcal{V}_T \cap \mathbb{R}$ that contain critical points in $\Omega_0 \cup \Omega_1 \cup \Omega_r$ are the components of I_0, I_1 and I_r . Recall that $\mathcal{U}_T \cap I_i = \emptyset, i = 0, 1, r$, and let

$$\tilde{F}: \tilde{\mathcal{U}}_T \rightarrow \tilde{\mathcal{V}}_T$$

be the corresponding touching box mapping for \tilde{f} . By Theorem 6.6 and the qs-rigidity of the set

$$K(I_0 \cup I_1 \cup \mathcal{I}^{\text{comp}}) = \{z : (R_{\hat{I}_*})^n(z) \in I_0 \cup I_1 \cup E(\mathcal{I}) \text{ for all } n \geq 0\},$$

as above, there exists a qc-homeomorphism H_0 that maps \mathcal{V}_T to $\tilde{\mathcal{V}}_T$ with $H_0(\mathcal{U}_T) = \tilde{\mathcal{U}}_T$ that agrees with the given topological conjugacy between f and \tilde{f} . As in Corollary 6.7 we get a qc-homeomorphism H with $H(\mathcal{U}_T) = \tilde{\mathcal{U}}_T$ with $\tilde{F}_T \circ H = H \circ F_T$ on \mathcal{U}_T and which is a conjugacy on the closed set $E(I_r)$. We modify H on the finite set, $CV(f)$, so that it sends $CV(f)$ to $CV(\tilde{f})$. Pulling back H once, we obtain a qc-conjugacy on the set $E'(I_r)$, and since $\partial\mathcal{U} \cap \mathbb{R} \subset E'(I_r)$, we have completed the proof of the claim. \checkmark

It follows from Theorem 7.1, that there exists a quasiconformal external conjugacy H between F and \tilde{F} so that $H(\cup_{c \in \Omega'_r} \mathcal{V}(c)) = \cup_{c \in \tilde{\Omega}'_r} \tilde{\mathcal{V}}(c)$, $H(\mathcal{U}) = \tilde{\mathcal{U}}$ and H is a conjugacy on $\partial\mathcal{U}$. Thus, in the analytic case, Theorem 7.3 implies that $F: \mathcal{U} \rightarrow \cup_{c \in \Omega'_r} \mathcal{V}$ and $\tilde{F}: \tilde{\mathcal{U}} \rightarrow \cup_{c \in \tilde{\Omega}'_r} \tilde{\mathcal{V}}(c)$ are qc conjugate. In the smooth case we have that the mappings are as conjugate on their real traces by Theorem 7.8. Thus we obtain a quasisymmetric homeomorphism that is a conjugacy on

$$K(I_r) = \{z \in \mathcal{I}_r : \hat{R}_{I_r}(z) \in I_r \text{ for all } n \geq 0\}.$$

We now repeat this argument for each block of critical points Ω_r .

8.6. Conclusion. Since almost every point in the interval eventually lands in $I_0 \cup I_1 \cup I_2$, we extend the conjugacies near the critical points and in immediate basins of attraction almost everywhere in the interval by considering the first entry mappings to $I_0 \cup I_1 \cup I_2$, and we do the same for the objects marked with a tilde. This yields a globally defined conjugacy on M , since for any component J of the first landing map to $I_0 \cup I_1 \cup I_2$, the first landing mapping extends to a complex domain \mathcal{U}_J , and near the boundary of \mathcal{U}_J conjugacy is defined as the pullback of the conjugacy between the touching box mappings $F_T: \mathcal{U}_T \rightarrow \mathcal{V}_T$ and $\tilde{F}_T: \tilde{\mathcal{U}}_T \rightarrow \tilde{\mathcal{V}}_T$.

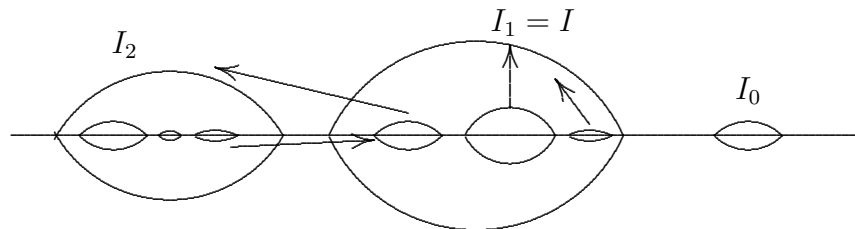

FIGURE 29. The box mapping associated to the non-minimal case. Some domains of the first return mapping to I_2 can spend a lot of time in I_1 . We also need to consider domains which eventually enter into I_0 .

9. TABLE OF NOTATION AND TERMINOLOGY

Forward(c), Back(c)	page 29	$\Omega, \Omega_0, \Omega_1, \Omega_2$	page 43
Dom(P), Dom $_{\Omega}$ (P)	page 29	I_0, I'_1, I_1, I_2	pages 43
Dom * (P), Dom'(P)	page 30	$\Omega_r, \Omega_{r,e}, \Omega_{r,o}$	page 47, 48
$\mathcal{L}_x(I)$	page 29	$D_{\theta}(I)$	page 33
$\hat{\mathcal{L}}_x(V)$	page 29	\mathcal{I}	page 52
well-inside	page 29	Dom $_{\text{diff}}$ (I_1)	page 52
$\mathcal{C}(M) = \mathcal{C}$	page 11	$E(\mathcal{I})$	page 76

REFERENCES

[A] A. Avila, On rigidity of critical circle maps, *Bull. Braz. Math. Soc. (n. s.)*, **44**(4) (2013), 611–619.

[AKLS] A. Avila, J. Kahn, M. Lyubich and W. Shen, Combinatorial rigidity for unicritical polynomials, *Ann. of Math. (2)*, **170**(2) (2009), 783–797.

[AL] A. Avila and M. Lyubich, The full renormalization horseshoe for unimodal maps of higher degree: exponential contraction along hybrid classes, *Publ. Math. Inst. Hautes Études Sci.*, **114** (2011), 171–223.

[ALdM] A. Avila, M. Lyubich and W. de Melo, Regular or stochastic dynamics in real analytic families of unimodal maps, *Invent. Math.*, **154** (2003), 451–550.

[ALS] A. Avila, M. Lyubich and W. Shen, Parapuzzle of the multibrot set and typical dynamics of unimodal maps, *J. Eur. Math. Soc.*, **013**(1) (2011), 27–56.

[AM1] A. Avila and C. G. Moreira, Statistical properties of unimodal maps: the quadratic family, *Ann. of Math. (2)*, **161**(2) (2005), 831–881.

[AM2] A. Avila and C. G. Moreira, Phase-parameter relation and sharp statistical properties for general families of unimodal maps. *Geometry and dynamics*, Contemp. Math. 389, 1–42, Aportaciones Mat., Amer. Math. Soc., Providence, RI, 2005.

[AM3] A. Avila and C. G. Moreira, Statistical properties of unimodal maps: physical measures, periodic orbits and pathological laminations, *Publ. Math. Inst. Hautes Études Sci.*, **101** (2005), 1–67.

[BF] B. Branner and N. Fagella, *Quasiconformal surgery in holomorphic dynamics*, Cambridge Studies in Advanced Mathematics, 141, Cambridge University Press, Cambridge, 2014.

[BJ] H. Bruin and M. Jakobson, New examples of topologically equivalent S-unimodal maps with different metric properties. With an appendix "Quasiconformal deformations of multipliers" by Genadi Levin, in *Geometric and probabilistic structures in dynamics*, Contemp. Math., 469, 119–139, Amer. Math. Soc., Providence, RI, 2008.

[BSvS] H. Bruin, W. Shen and S. van Strien, Existence of unique SRB-measures is typical for real unicritical polynomial families, *Ann. Sci. École Norm. Sup.*, **39** (2006), 381–414.

- [BvS] H. Bruin and S. van Strien, Monotonicity of entropy for real multimodal maps, *J. Amer. Math. Soc.*, **28**(1) (2015), 1–61.
- [BKNvS] H. Bruin, G. Keller, T. Nowicki and S. van Strien, Wild Cantor attractors exist, *Ann. of Math. (2)*, **143**(1) (1996), 97–130.
- [C] D. Cheraghi, Combinatorial rigidity for some infinitely renormalizable unicritical polynomials, *Conform. Geom. Dyn.*, **14** (2010), 219–255.
- [CSH] D. Cheraghi and M. Shishikura, Satellite renormalization of quadratic polynomials, [arXiv:1509.07843 \[math.DS\]](https://arxiv.org/abs/1509.07843).
- [CS] D. Cheraghi and S. van Strien, Connectedness of topological entropy with the space of real unimodal polynomials of degree 4, in preparation.
- [Cl] T. Clark, Regular or stochastic dynamics in higher degree families of unimodal maps, *Ergod. Theory Dyn. Syst.*, **34**(5) (2014), 1538–1566.
- [CvST] T. Clark, S. Trejo and S. van Strien, Complex bounds for real maps, *Comm. Math. Phys.*, **355**(3) (2017), 1001–1119.
- [D] A. Douady, Topological entropy of unimodal maps: Monotonicity for quadratic polynomials, in B. Branner and P. Hjorth (eds.), *Real and Complex Dynamical Systems*, 65–87, NATO Adv. Sci. Inst. Ser. C Math. Phys. Sci., 464, Kluwer Acad. Publ., Dordrecht, 1995.
- [DH1] A. Douady and J. H. Hubbard, Étude dynamique des polynômes quadratiques complexes, I (1984) & II (1985), *Publ. Mat. d’Orsay*.
- [DH2] A. Douady and J. H. Hubbard, A proof of Thurston’s topological characterization of rational functions, *Acta Math.*, **171**(2) (1993), 263–297.
- [Ep] A. Epstein, Towers of finite type complex analytic maps. Thesis (Ph.D.) City University of New York. 1993.
- [EdF] G. Estevez and E. de Faria, Real bounds and quasimetric rigidity of multicritical circle maps, to appear in *Trans. Amer. Math. Soc.*, DOI: <https://doi.org/10.1090/tran/7177>
- [dFdM1] E. de Faria and W. de Melo, Rigidity for critical circle maps I., *J. Eur. Math. Soc.*, **1**(4) (1999), 339–392.
- [dFdM2] E. de Faria and W. de Melo, Rigidity for critical circle maps II., *J. Amer. Math. Soc.*, **13**(2) (1999), 343–370.
- [dFdMP] E. de Faria, W. de Melo and A. Pinto, Global hyperbolicity of renormalization for C^r unimodal mappings, *Ann. of Math. (2)*, **164**(3) (2006), 731–824.
- [GS1] J. Graczyk and G. Świątek, Polynomial-like properties for real quadratic polynomials, *Top. Proc.*, **21** (1996), 33–112.
- [GS2] J. Graczyk and G. Świątek, Generic hyperbolicity in the logistic family, *Ann. of Math. (2)*, **146** (1997), 1–52.
- [GS3] J. Graczyk and G. Świątek, *The real Fatou conjecture*, *Annals of Math. Studies*, vol. 144, Princeton University Press, Princeton, 1998.
- [GSS] J. Graczyk, D. Sands and G. Świątek, Decay of geometry for unimodal maps: negative Schwarzian case, *Ann. of Math. (2)*, **161** (2005), 613–677.
- [GdM] P. Guarino and W. de Melo, Rigidity of smooth critical circle maps, *J. Eur. Math. Soc.*, **19**(6) (2017), 1729–1783.
- [GdMM] P. Guarino, W. de Melo and M. Martens, Rigidity of critical circle maps, [arXiv:1511.02792 \[math.DS\]](https://arxiv.org/abs/1511.02792).
- [He] M. R. Herman, Sur la conjugaison différentiable des difféomorphismes du cercle à des rotations, *Publ. Math. Inst. Hautes Études Sci.*, **48** (1979), 5–233.
- [He2] M. R. Herman, Conjugaison quasi symétrique des homéomorphismes du cercle à des rotations. Unpublished but available at <https://www.math.kyoto-u.ac.jp/~mitsu/Herman/index.html>.
- [Hu] J. H. Hubbard, Local connectivity of Julia sets and bifurcation loci: three theorems of J.-C. Yoccoz, *Topological methods in modern mathematics*, (Stony Brook, NY, 1991), 467–511, Publish or Perish, Houston, TX, 1993.
- [J] M. Jakobson, Quasimetric conjugacy for some one-dimensional maps inducing expansion, *Symbolic dynamics and its applications*, (New Haven, CT, 1991), *Contemp. Math.*, 135, 203–211, Amer. Math. Soc., Providence, RI, 1992.

- [JS] M. Jakobson and G. Świątek, *Quasisymmetric conjugacies between unimodal maps*, [arXiv:math/9201292](#) [[math.DS](#)].
- [Ji] Y. Jiang, Geometry of geometrically finite one-dimensional maps, *Comm. Math. Phys.*, **156** (1993), 639–647.
- [Ji2] Y. Jiang, Geometry of Cantor systems, *Trans. Amer. Math. Soc.*, **351**(5) (1999), 1975–1987.
- [K] J. Kahn, A priori bounds for some infinitely renormalizable quadratics: I. Bounded primitive combinatorics, [arXiv:math/0609045](#) [[math.DS](#)]
- [KL] J. Kahn and M. Lyubich, The quasi-additivity law in conformal geometry, *Ann. of Math. (2)*, **169**(2) (2009), 561–593.
- [KL2] J. Kahn and M. Lyubich, A priori bounds for some infinitely renormalizable quadratics: II. Decorations, *Ann. Sci. Éc. Norm. Supér. (4)*, **41**(1) (2008), 57–84.
- [KL3] J. Kahn and M. Lyubich, A priori bounds for some infinitely renormalizable quadratics, III. Molecules, in D. Schleicher (ed.), *Complex dynamics: Families and Friends. Proceeding of the conference dedicated to Hubbard's 60th birthday*, 229–254, A K Peters, Wellesley, MA, 2009.
- [KT] K. Khanin and A. Teplinsky, Robust rigidity for circle diffeomorphisms with singularities, *Invent. Math.*, **169**(1) (2007), 193–218.
- [Ko] O. Kozlovski, Axiom A maps are dense in the space of unimodal maps in the C^k topology, *Ann. of Math. (2)*, **157**(1) (2003), 1–43.
- [KSvS1] O. Kozlovski, W. Shen and S. van Strien, Rigidity for real polynomials, *Ann. of Math. (2)*, **165** (2007), 749–841.
- [KSvS2] O. Kozlovski, W. Shen and S. van Strien, Density of hyperbolicity in dimension one, *Ann. of Math. (2)*, **166** (2007), 145–182.
- [KvS] O. Kozlovski and S. van Strien, Local connectivity and quasi-conformal rigidity of non-renormalizable polynomials, *Proc. Lond. Math. Soc. (3)*, **99**(2) (2009), 275–296.
- [L1] G. Levin, Rigidity and non-local connectivity of Julia sets of some quadratic polynomials, *Comm. Math. Phys.*, **304**(2) (2011), 295–328.
- [L2] G. Levin, Addendum to: Rigidity and Non-Local Connectivity of Julia Sets of Some Quadratic Polynomials, *Comm. Math. Phys.*, **325**(3) (2014), 1171–1178.
- [LP] G. Levin and F. Przytycki, External rays to periodic points, *Israel J. Math.*, **94** (1995), 29–57.
- [LvS1] G. Levin and S. van Strien, Local connectivity of the Julia set of real polynomials, *Ann. of Math. (2)*, **147** (1998), 471–541.
- [LvS2] G. Levin and S. van Strien, Bounds of maps of an interval with one critical point of inflection type. II, *Invent. Math.*, **141** (2000), 399–465.
- [LSvS1] G. Levin, W. Shen and S. van Strien, Transversality for critical relations of families of rational maps: an elementary proof, [arXiv:1702.02582](#) [[math.DS](#)].
- [LSvS2] G. Levin, W. Shen and S. van Strien, Monotonicity of entropy and positively oriented transversality for families of interval maps, [arXiv:1611.10056](#) [[math.DS](#)].
- [LiS1] S. Li and W. Shen, Smooth conjugacy between S-unimodal maps, *Nonlinearity*, **19**(7) (2006), 1629–1634.
- [LiS2] S. Li and W. Shen, Hausdorff dimension of Cantor attractors in one-dimensional dynamics, *Invent. Math.*, **171**, (2008) 345–387.
- [LiS3] S. Li and W. Shen, An improved real C^k Koebe principle, *Ergod. Theory Dyn. Syst.*, **30**(5) (2010), 1485–1494.
- [LPS] L. Lomonaco, C. Petersen and W. Shen, On parabolic external maps, *Discrete Cont. Dyn. A*, **37**(10) (2017), 5085–5104.
- [Ly1] M. Lyubich, Teichmüller space of Fibonacci maps, [arXiv:math/9311213](#) [[math.DS](#)].
- [Ly2] M. Lyubich, Dynamics of quadratic polynomials I-II, *Acta Math.*, **178** (1997), 185–297.
- [Ly3] M. Lyubich, Feigenbaum-Couillet-Tresser universality and Milnor's hairiness conjecture, *Ann. of Math. (2)*, **149** (1999), 319–420.
- [Ly4] M. Lyubich, Almost every real quadratic map is either regular or stochastic, *Ann. of Math. (2)*, **156** (2002), 1–78.
- [LM] M. Lyubich and J. Milnor, The Fibonacci unimodal map *J. Amer. Math. Soc.*, **6**(2) (1993), 425–457.

- [LyY] M. Lyubich and M. Yampolsky, Complex bounds for real maps, *Ann. Inst. Fourier (Grenoble)*, **47**(4) (1997), 1219–1255.
- [MoSm] C. G. Moreira and D. Smania, Metric stability for random walks (with applications in dynamics), in *Frontiers in Complex Dynamics*, Princeton Math. Ser., 51, 65–87, Princeton University Press, Princeton, 2014.
- [MdM] M. Martens and W. de Melo, The multipliers of periodic points in one-dimensional dynamics, *Nonlinearity*, **12** (1999), 217–27.
- [McM] C. McMullen, *Complex dynamics and renormalization*, Annals of Math. Studies, vol. 135, Princeton University Press, Princeton, 1994.
- [McM2] C. McMullen, The classification of conformal dynamical systems, in *Current developments in mathematics*, 1995 (Cambridge, MA), 323–360, Int. Press, Cambridge, MA, 1994.
- [McM3] C. McMullen, *Renormalization and 3-manifolds which Fiber over the Circle*, Annals of Math. Studies, vol. 142, Princeton University Press, Princeton, 1996.
- [MdMvS] M. Martens, W. de Melo and S. van Strien, Fatou-Julia-Sullivan theory for real one-dimensional dynamics, *Acta Math.*, **168** (1992), 273–318.
- [dMSV] W. de Melo, P. A. S. Salomão and E. Vargas, A full family of multimodal maps on the circle, *Ergod. Theory Dyn. Syst.*, **31**(5) (2011), 1325–1344.
- [dMvS] W. de Melo and S. van Strien. *One-Dimensional Dynamics*, Springer-Verlag. Berlin (1993).
- [M] J. Milnor. *Dynamics in one complex variable*, Annals of Math. Studies, vol. 160, Princeton University Press, Princeton, 2006.
- [MT] J. Milnor and W. Thurston, On iterated maps of the interval: I, II, Preprint 1977. Published in Lect. Notes in Math. 1342, 465–563, Springer, Berlin New York, 1988.
- [MTr] J. Milnor and C. Tresser, On entropy and monotonicity for real cubic maps. With an appendix by Adrien Douady and Pierrette Sentenac, *Comm. Math. Phys.*, **209**(1) (2000), 123–178.
- [Pa] W. Pałuba, The Lipschitz condition for the conjugacies of Feigenbaum-like mappings, *Fund. Math.*, **132**(3) (1989), 227–258.
- [PT] Wenjuan Peng and Lei Tan, Quasi-conformal rigidity of multicritical maps, *Trans. Amer. Math. Soc.*, **367**(2) (2014) 1151–1182.
- [P1] C. Peterson, Local connectivity of some Julia sets containing a circle with an irrational rotation, *Acta Math.*, **177**(2) (1996), 163–224.
- [P2] C. Petersen, The Herman-Świątek theorems with applications, in *The Mandelbrot set, theme and variations*, London Math. Soc. Lecture Note Ser., 274, 211–225, Cambridge Univ. Press, Cambridge, 2000.
- [P3] C. Petersen, Quasi-symmetric conjugacy of Blaschke products on the unit circle, *Bull. London. Math. Soc.*, **39**(5) (2007), 724–730.
- [RvS1] L. Rempe and S. van Strien, Absence of line fields and Mañé’s theorem for nonrecurrent transcendental functions, *Trans. Amer. Math. Soc.*, **363** (2011), 203–228.
- [RvS2] L. Rempe-Gillen and S. van Strien, Density of hyperbolicity for classes of real transcendental entire functions and circle maps, *Duke Math. J.*, **164**, no. 6 (2015), 1079–1137.
- [Sa] D. Sands, *Parabolic Mañé theorem*, Unpublished manuscript.
- [Sc] D. Schleicher, On fibers and local connectivity of Mandelbrot and Multibrot sets, in *Fractal geometry and applications: a jubilee of Benoît Mandelbrot. Part 1*, Proc. Sympos. Pure Math., 72, 477–517, Amer. Math. Soc., Providence, RI, 2004.
- [S1] W. Shen, Bounds for one-dimensional maps without inflection critical points, *J. Math. Sci. Univ. Tokyo*, **23**(3) (2003), 957–983.
- [S1] W. Shen, On the measurable dynamics of real rational functions, *Ergod. Theory Dyn. Syst.*, **23**(3) (2003), 957–983.
- [S2] W. Shen, On the metric properties of multimodal interval maps and C^2 density of Axiom A, *Invent. Math.*, **156** (2004), 301–403.
- [ST] W. Shen and M. Todd, A real C^k Koebe principle, *Fundam. Math.*, **185**(1) (2005), 61–69.
- [Sm1] D. Smania, Phase space universality for multimodal maps, *Bull. Braz. Math. Soc. (n.s.)*, **36**(2) (2005), 225–274.
- [Sm2] D. Smania, Puzzle geometry and rigidity: the Fibonacci cycle is hyperbolic, *J. Amer. Math. Soc.*, **20**(3) (2007), 629–673.

- [Sm3] D. Smania, Shy shadows of infinite-dimensional partially hyperbolic invariant sets, *Ergod. Theory Dyn. Syst.*, (2017), 1–40. Available online. doi:10.1017/etds.2017.65
- [Sm4] D. Smania, *Solenoidal attractors with bounded combinatorics are shy*, arXiv:1603.06300 [math.DS].
- [vS] S. van Strien, Hyperbolicity and invariant measures for general C^2 interval maps satisfying the Misiurewicz condition, *Comm. Math. Phys.*, **128**(3) (1990), 437–495.
- [vSV1] S. van Strien and E. Vargas, Real bounds, ergodicity and negative Schwarzian derivative for multimodal maps, *Jour. Amer. Math. Soc.*, **17**(4) (2004), 749–782.
- [vSV2] S. van Strien and E. Vargas, Erratum to “Real bounds, ergodicity and negative Schwarzian derivative for multimodal maps, *Jour. Amer. Math. Soc.* **17**(4), (2004) 749–782.” *Jour. Amer. Math. Soc.*, **20**(1) (2007), 267–268.
- [Su1] D. Sullivan, Quasiconformal homeomorphisms in dynamics, topology, and geometry, *Proceedings of the International Congress of Mathematicians*, vol. 1, 2 (Berkeley, Calif., 1986), 1216–1228, Amer. Math. Soc., Providence, RI, 1987.
- [Su2] D. Sullivan, *Bounds, quadratic differentials and renormalization conjectures*, AMS Centennial Publications, vol. 2, 1992. Mathematics into the Twenty-First Century.
- [Swi] G. Świątek, Rational rotation numbers for maps of the circle, *Comm. Math. Phys.*, **119**(1) (1988), 109–128.
- [T] M. Tsujii, A simple proof for monotonicity of entropy in the quadratic family, *Ergod. Theory Dyn. Syst.*, **20** (2000), 925–933.
- [V] V. Vellis, Quasisymmetric extension on the real line, arXiv:1509.06638 [math.MG].

IMPERIAL COLLEGE LONDON

E-mail address: t.clark@imperial.ac.uk, s.van-strien@imperial.ac.uk