

# Towards Memory Prefetching with Neural Networks: Challenges and Insights

Leeor Peled<sup>†</sup>    Uri Weiser<sup>†</sup>    Yoav Etsion<sup>†§</sup>  
<sup>†</sup>Electrical Engineering    <sup>§</sup>Computer Science  
Technion — Israel Institute of Technology  
{leeor@tx, uri.weiser@ee, yetsion@tce}.technion.ac.il

## ABSTRACT

Accurate memory prefetching is paramount for processor performance, and modern processors employ various techniques to identify and prefetch different memory access patterns. While most modern prefetchers target *spatio-temporal* patterns by matching memory addresses that are accessed in close proximity (either in space or time), the recently proposed concept of *semantic locality* views locality as an artifact of the algorithmic level and searches for correlations between memory accesses and program state.

While this approach was shown to be effective, capturing semantic locality requires significant associative learning capabilities. In this paper we utilize neural networks for this task. Artificial neural networks are becoming increasingly effective in tasks of pattern recognition and associative learning of complex relations. We leverage recent advances in this field to propose a conceptual neural network prefetcher. We show that by targeting semantic locality, this prefetcher can learn distinct memory access patterns that cannot be covered by other state-of-the-art prefetchers.

We evaluate the neural network prefetcher over SPEC2006, Graph500, and a variety of handwritten kernels. We show that the prefetcher can deliver an average speedup of 22% for SPEC2006 (up to 90% ) and up to  $5\times$  over kernels. We also explore the limitations of using neural networks for prefetching. Ultimately, we conclude that although there are still many challenges to overcome before we can reach a feasible, power-efficient implementation, the neural network prefetcher potential gains over state-of-the-art prefetchers justify further exploration.

## 1. INTRODUCTION

Hiding memory access latency through memory prefetching is increasingly critical to processor performance. As a result, most modern processors employ multiple types of prefetchers to cover a wide range of application behaviors. Existing prefetching schemes are designed to identify specific memory access patterns, ranging from sequential and strided access patterns to traversals over linked data structures. Most of these schemes target *spatio-temporal locality*. They analyze the memory access stream and identify *spatio-temporal relations* and instances of *temporal correlation* between addresses or address-space artifacts (e.g., address deltas) [1].

An alternative view of data locality was recently proposed by Peled et al. [2]. The proposed *Semantic locality* model argues that *spatio-temporal locality* is a manifestation of a fundamental relation between accesses that is derived from the program semantics. According to this approach, access locality is an artifact of the algorithmic design of the code. Correlations between memory accesses may therefore be inferred from the program state, which in turn can be represented through various attributes of program and machine context at any point during the run. However, the detection of state-address correlation is not deterministic. The simplistic reinforcement learning method proposed by Peled et al. extracted a number of attributes describing the program state and history, but could not discern between useful attributes and superfluous ones. This suggests that a stronger learning mechanism is required to extract semantic correlation.

Neural networks have become extremely popular in recent years as generic tools for solving complicated learning problems. Their structure allows them to solve non-linear classification problems, to learn patterns, and to perform associative reasoning tasks. As such, they appear to present a compelling option for the engine behind a semantic prefetcher. We believe that once technology advances enough to alleviate their power/performance costs, they will become a dominant component for dynamic optimization of future CPUs.

In this paper, we examine the use of neural networks to capture semantic locality. We present a conceptual neural network prefetcher that examines various machine and workload attributes and predicts memory addresses that will be accessed by the running program in the near future.

Our exploration demonstrates that a single neural network prefetcher can be dynamically trained to learn multiple access patterns that are today targeted by multiple, distinct, heuristic memory prefetchers. We analyze the learning rate of neural networks and its applicability to dynamically learning memory access streams, the encoding of access patterns as synaptic weights in a network, and the network size required to store address correlations. In particular, we explore the limits of pattern complexity that various neural networks can learn, and examine their success over sequences representing the specialization of common existing prefetchers.

Alongside these benefits, we also study the conceptual and technical challenges that impede a neural network prefetcher.

We conclude that while existing neural network technology has not yet matured to deliver a feasible implementation, such a prefetcher demonstrates improved abilities in predicting memory patterns and brings real performance benefits.

Our contributions in this paper are as follows:

- We present multiple methods for learning memory access patterns using neural networks.
- We explore the limits of pattern detection and predictability using different neural network types and layouts. We evaluate the size, depth and characteristics of networks suited for address prediction, and discuss various trade offs involved in the implementation of a neural network prefetcher.
- We define and implement a neural network prefetcher using gem5 [3] and evaluate its performance over a variety of benchmark suites including SPEC2006 [4], Graph500 [5], and a variety of hand-written kernels. We show that our prefetcher can gain an average speedup of 22% over SPEC2006, and up to 5× on some kernels, compared to a baseline without prefetching.

The remainder of this paper is organized as follows: Section 2 describes the challenges of contextual prefetching. Section 3 describes a method for pattern detection and contextual prefetching using a neural network. Section 4 presents the design considerations for the neural network and discusses its advantages and trade offs. Section 5 presents related work. Section 6 shows the experimental layout, simulators and benchmarks used. Section 7 describes the simulation results, and we conclude in Section 8.

## 2. LEARNING MEMORY ACCESS PATTERNS

Prefetchers observe the stream of requests emitted by the processor and use that information to predict the next accesses. The predicted lines are fetched from memory ahead of time and installed in a local cache, obviating the cache miss of the later demand and hiding its latency.

The *fetch* problem statement can therefore be formulated as follows: at any point during the run, given the history of memory addresses previously accessed (and any complementary information available), produce the most likely N addresses to continue the sequence.

When observing a sequence stripped of any additional information, this task is known as the problem of *universal prediction* [6], which is prevalent in the field of information theory and often handled with probabilistic tools. However, since we know that the stream represents accesses to data structures, constructed and used by an algorithm with some form of internal logic and recurrence, we have better chances of finding order in the underlying semantics that produced it.

### 2.1 Identifying semantic locality

Memory access streams are usually constructed of multiple sub-streams. Each of these sub-streams represents a portion of the application and is generated by distinct elements of the program semantics. The relations within such sub-stream can be defined as *semantic locality* [2] if they represent *consequential* (not merely *consecutive*) actions.

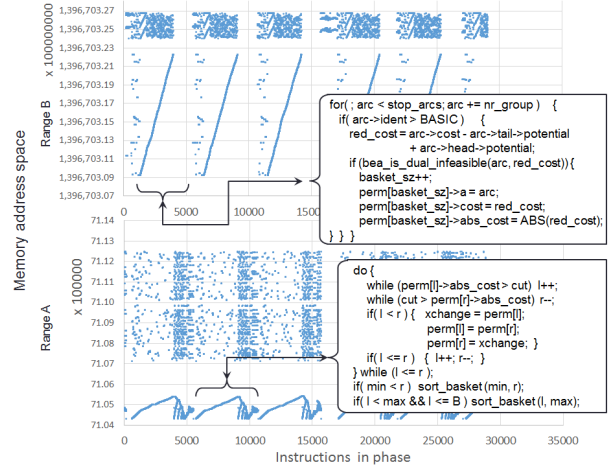

**Figure 1: Access patterns during one of the phases of MCF, over several memory activity ranges(covering over 30% of the runtime). The bottom range (also enlarged in figure 2) exhibits an interesting pattern that represents a quicksort algorithm. Other patterns include direct linear strides representing the direct fields in the array of *arc* structs, while the scatters represent indirectly linked elements accessed through the pointers there.**

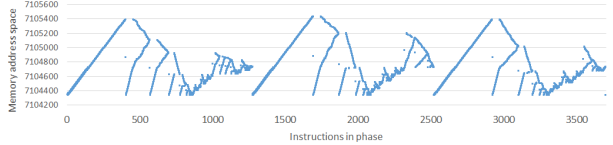

**Figure 2: Zoom-in on several quicksort phases from Figure 1. The pivot in each step is chosen and elements are rearranged on its sides, creating a cone shape. Each pivot creates a skewed cone according to its location.**

The program interleaves these sub-streams, effectively forming a global stream that is further reordered at run-time by program control flow and sometimes also by an underlying out-of-order micro-architecture. This makes isolation of elements in the sequence very hard, since the prefetcher doesn't always know where to look for patterns, and since the patterns themselves often vary in their relation types.

Figure 1 shows an example of multiple sub-streams that are simultaneously active in SPEC2006 MCF benchmark. The different memory ranges reflect different data sets (lists, trees, and arrays pointing at each other) that are interleaved by the algorithm. Each range has different characteristics, some with spatial layout and a linear access pattern, and others with more complicated accesses. For example, figure 2 illustrates a quicksort phase in MCF, going back and forth around a pivot element at each iteration. This mixture of access patterns demonstrates the interleaving problem, as each sub-stream would benefit from different prefetching techniques.

Most common existing prefetchers are designed to handle specific predefined types of semantic relations and patterns, most often based on their manifestations as spatio-temporal locality or temporal correlation. Table 1 shows simple ex-

amples of such relations. Real applications with complex semantics often exhibit many types of relations (as shown in the MCF example), making the use of predefined relations insufficient. One of our goals in this paper is to explore whether a sufficiently powerful and generic learning model can identify and learn the memory access patterns and semantic relations used by a program.

## 2.2 Observing semantic locality by context

Since memory accesses are derived from the algorithms, the data structures, and the programming paradigms used, the program context itself can become a useful hint in the de-obfuscation process of the access stream. For that reason, most advanced prefetchers employ some portions of the program context to isolate substreams and discover patterns within them. The last column in Table 1 shows examples of the context attributes used by each prefetcher. This raises the question whether truly abundant context will allow better pattern isolation and detection of true semantic locality.

We define a *program context-state* as a state vector with the current values of a set of attributes representing the CPU and program state (such as register values, branch and access history, access type, and similar attributes that relate to the current program phase). Each memory access has a distinct context-state at the time of dispatch that has some correlation to what the program was doing at that exact moment. Even though we cannot *infer* what the program was doing from this information, we can still use it to *correlate* how it was doing it. A strong correlation between past contextual states and future addresses often indicates true semantic correlation [2].

However, a context that is not detailed enough may fail to expose the desired relations, while an overly detailed context may overfit. To find an effective context one must use only the attributes that are semantically meaningful for a given relation (e.g. the register used for computing an address, or an IP for recurring accesses into a data structure).

Selectively picking context attributes and identifying their relations to future memory accesses of the program requires unique learning capabilities not available in the past proposals. However, thanks to recent developments in the field of machine learning, we believe this can now be achieved through neural networks employing online learning.

## 3. THE CONTEXTUAL NEURAL NETWORK PREFETCHER

We propose to use a neural network to extract the contextual information and derive prefetch candidates. The proposed prefetcher, shown in figure 3, receives the stream of memory addresses accessed by the program and the context state at the time of each access. The context states are represented as bit-vectors describing CPU attributes at the time of access. Among these attributes, we list the code address; access type (read/write), and other potentially related values as described in listing 1. These attributes were already shown [2] to be useful in semantical correlation of access stream elements (although different attributes have varying levels of usefulness on different applications). Elements representing accumulated history values are implemented using shift registers and concatenate a subset of each value.

**Listing 1: Context vector layout**

```
Context[0:31] <= address;
Context[32:63] <= LIP;
Context[64:127] <= branch_history;
Context[128:143] <= last_address_delta;
Context[144:159] <= data_fetched;
Context[160] <= access_type; // r/w
Context[161] <= access_mode; // ptr/array
```

### 3.1 Selecting context-address associations

The prefetcher must be able to train on unsupervised samples of context-address pairs based on the observed history. We do not know at the time of training if the associations would prove to be semantically related. To overcome that, we rely on recurrence to strengthen true relations over time.

Since we want to establish a useful prefetch distance, we must represent a long window of history between each context and the associated address it should predict. This presents the challenge of picking context-address pairs within this window that are likely to be semantically related and are not too close or too far away so that the prefetching will be effective. To address this issue we maintain the *Association Queue*. This queue stores the history of context states and addresses observed on every memory unit access. On every access we push the current state vector and address at the head of the queue, and pop the element at the tail which represents the oldest stored context state  $S_N$ . We then choose one of the recent addresses from the queue to associate with it. Since the addresses are selected from around the head of the queue, they represent a distance of roughly  $N$  accesses (where  $N$ , the queue size, is selected to fit the desired prefetch depth given the machine average miss time). We used a queue of up to 128 elements in our runs (conversely, GHB variants usually use 256 long history queue).

The distance of a correlated state-address pair may change between recurrences due to execution reordering or code path changes. To mitigate, we allow some variance in association depth. We achieve that by matching  $S_N$  against all of the most recent  $d$  addresses, selecting the best candidate for a match. During the training phase,  $S_N$  is first fed into the neural network to produce a prediction on the output. This output is matched against the  $d$  recent addresses read from the queue, and the closest match (in terms of minimal bit-wise error) is selected. We rely on the slow momentum of the gradient descent method to produce the strongest recurring pattern for that given input and further strengthen such associations, assuming they represent a semantic connection, while in parallel we eliminate random or transient associations.

In this paper we use a delta-prediction mode, where the output is trained to be the address delta relative to the address of the associated context ( $A_N$ ). This allows bounding the stored values (usually 16 bits are enough), as well as providing better recurrence on strided patterns. However, unlike most delta based prefetchers we are not limited to small deltas within the same page, and therefore storing the deltas is not inferior to storing the full addresses (aside for the need to support negative values). This is important when trying to achieve partial memoization of fractured linked data structures.

#### 3.1.1 Association filtering

Prefetcher	Sample sequence						Sample rule	Context info used
Streamer	A	A+1	A+2	A+3	A+4	A+5	+1,+1,...	Last address
Strider	A	A+n	A+2n	A+3n	A+4n	A+5n	+n,+n,...	Last address
SMS [7]	A	A+n	A+m	B	B+n	B+m	offsets: 0,n,m	Address delta history
Markov [8]	A	B	A	C	A	B	$A \xrightarrow{33\%} B ; A \xrightarrow{66\%} C$	Last address
VLDP [9], GHB */DC [10]	A	A+2	A+3	A+5	A+6	A+8	+2,+1,+2,+1..	Address delta history
GHB PC/* [10]	A <sub>1</sub>	B <sub>1</sub>	A <sub>2</sub>	B <sub>2</sub>	A <sub>3</sub>	B <sub>3</sub>	PC <sub>A</sub> : A <sub>n</sub> ; PC <sub>B</sub> : B <sub>n</sub>	PC + Addr. delta history

**Table 1: Example pattern types targeted by common prefetchers. Including streamers/striders ; Spatial pattern based ones (SMS) that repeat a pattern around anchor addresses; Markov prefetchers that rely on a probability model; VLDP and delta-correlation GHB that learn recurring delta patterns; and GHB/PC records patterns based on PC.**

Notably, all addresses that reported an L1 cache hit are filtered out of the selection process, under the assumption that we should focus on predicting accesses that incur miss penalties. Nevertheless, they still allocate an entry in the Association Queue for correct depth tracking, and their context state may still trigger predictions. Accesses that hit a cache line installed by a prefetch are treated like misses so that we may strengthen the useful association they represent.

On top of that, we restrict the maximal address delta that may be associated, to increase the chances that associations are made within related memory ranges. This restriction is very useful in some cases, but may become detrimental in cases of highly fractured data sets. We therefore apply a dynamic limit, where the max delta is incremented when the prefetcher usefulness is deemed insufficient over a time window. We allow several sweeps through possible values, each having a chance to generate useful new association, and eventually select the max-delta value that performed best. The usefulness metric used here is percent of demands hitting a prefetched line, and the max delta multiplier is changed after 1000 cycles below a 15% threshold.

In addition to the association above, we observed the need to kickstart the initial convergence of the neural network, especially in the presence of contradicting associations. For that purpose, we add a secondary network and a context hash: each context vector being associated will store the associated delta into the hash, indexed by a hashing of the context vector. The context hash will be overwritten on conflicting associations (or on overloaded hash values), making its storage very short-lived, but most of the time this mechanism gives us an additional level of confidence that the trained context/address pair was already observed, and it helps increase the recurrence that is crucial for producing accurate outputs.

### 3.1.2 Parallel association policies

Since different policies match different types of patterns, we can place two networks in parallel and train each one independently with the address associated according to each one of the policies. We then select the winner either by confidence (error level of the output bits) or by comparing average success rates over time. Alternatively, the network output can be split into subsets (as shown in Figure ??). This way, different associations may be trained in parallel over a single network, allowing shared storage and shared learning.

In our experiments we use one subset range of nodes to train associations with minimal distance in terms of minimal square error (MSE) from the current output of the network.

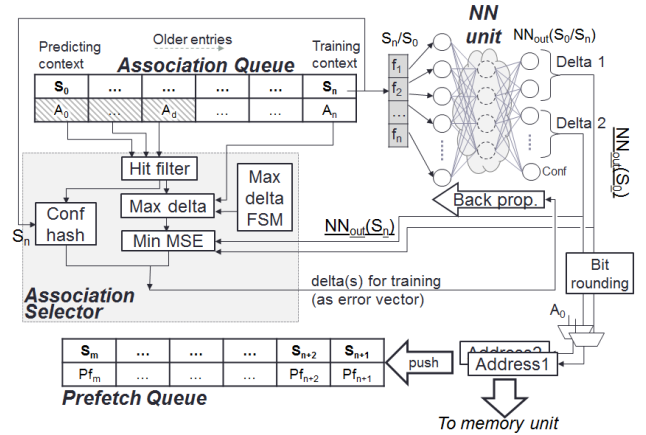

**Figure 3: NN prefetcher diagram, showing the association queue, the NN unit, the logic for selecting which associations to train, and the Prefetch Queue that keeps prefetches for feedback**

We use the other subset to train best context-hash match (i.e. a first context-address pair that hits in the context hash). The hashed based associations often give better results during early stages of the run, as they are faster to train, while the MSE one is slower to learn.

We attempted using up to four parallel networks, where the other two are trained over PC confidence (i.e. prefer associating addresses with highest recurring program counters), or simply choosing another best MSE match (since it is done on a separate network, over time it will learn different predictions and make different min-MSE associations). However, while the context-hash-based network has shown to be critical for performance, the other two had only marginal benefits.

The predictions generated by the networks are eventually collected, added on top of the address of the predicting context (in delta prediction mode), and sent back to the memory unit for prefetching. Since triggering prefetches comes with a price on overall system bandwidth, the proposed prefetcher may dispatch "shadow prefetches", similar to the RL-context prefetcher [2]. This is achieved by storing all generated prefetches into a *Prefetch Queue* and using them to collect feedback, but dispatching only the highest confidence ones to become actual prefetches.

## 3.2 The NN prediction engine

The central component in our prefetcher is the neural net-

work itself. It consists of 3 or more layers (deep neural networks often reach 7 or more) of fully connected *perceptron* nodes, where each perceptron models a simplified *neuron*. Each perceptron performs a linear product between the outputs of the previous layer and a locally stored weight vector, and then applies a non-linear activation function on the result (such as ReLU [11]). The depth and layout of the neural network are explored in section 4. Area/power mitigations are discussed in section 7.4.

The neural network performs two phases on each L1 cache miss. First, the *prediction* phase performs *inference* over the most recent context state vector ( $S_0$ ): It feeds the input context vector to the entry layer, computes the neuron activations at each layer, and interprets the values at the output layer as a binary representation of the predicted value. If the result is distinct enough (the output bits are within valid thresholds), it is sent to the memory unit to be prefetched.

Subsequently, the *training* phase performs an inference on the oldest context state vector  $S_n$ . It then receives the value we wish to associate with the given input (explained in section 3.1), and performs *backpropagation* using gradient-descent to correct the weights according to the bitwise error vector. Over time, and given sufficient samples, the weights will adapt so that the network will map as many of the trained input-output pairs as its size and layout can support.

### 3.3 Prediction feedback

One of the most important capabilities for reinforcement learning is to provide feedback, both positive and negative. We achieve this by tracking predictions (both real ones and shadow prefetches) in the *Prefetch Queue*. When a demand hits this queue at a depth deemed useful (we use the same weight function as in [2]), we trigger another training pass on the NN to strengthen the context/address pair that was hit. If, however, a prediction is hit outside the useful range, or if it falls off the queue without ever being hit, we need to provide negative feedback. The neural network is less equipped to provide such feedback as there is no way to "un-train" a sample. Instead we use a single bit of the predicted output, and train it to hold the confidence of the prediction. Any positive feedback will train it to a high value, and any negative feedback will train it to a low one. Since this bit is not intended to be interpreted as a binary value like the address bits, we are not encumbered by quantized values. Instead, we can assign gradual values according to the strength of the feedback and achieve faster training.

## 4. NN DESIGN CONSIDERATIONS

The strength of neural networks stems from their structure and internal connectivity, making associative learning and distributed storage possible. This section explores these benefits and demonstrates their advantage in learning simple streams with varying complexity.

### 4.1 Pattern complexity

Access sequences may have varying levels of pattern complexity, and a neural network may have different chances of success predicting them. A linear sequence with constant stride will be relatively easy to learn, while a pseudo random sequence will be harder. Similarly, some patterns will exhibit

stronger correlation to prior accesses (a recursive series, for example), while others will be easier to compute based on some argument (such as an index).

The concept of *Kolmogorov complexity* can be used to describe the difficulty level of representing access sequences. It is defined for any given object (such as a sequence of values) to be the length of the shortest description (for example a computer program in any language) that generates it. Since neural networks were shown to be equivalent to a Turing machine [12], a corollary for the Kolmogorov complexity of a sequence can also be described as the minimal size of a neural network able to produce it.

Therefore, a key problem when using NNs for prefetching is how well can we learn to approximate the observed access pattern with our finite neural network?

## 4.2 Information encoding

The structure and connectivity of neural networks provide a novel way to encode and represent information that makes them superior in some aspects to normal array-mapped representations in hardware (such as tables or hashes). The difference has two main aspects:

### 4.2.1 Storage

Unlike other learning mechanisms that rely on direct or semi-associative storage, neural networks store their knowledge in the form of node weights. Rather than performing lookups in internal tables, the neural network calculates the outcome using multiple paths that combine the values of all the active nodes in parallel. Consequently, we do not control how information will be stored in the neural network, and the actual layout depends on the convergence of the training process. Notably, a single node in the network might sometimes be associated with a specific, highly-specialized feature of the input pattern (a concept sometimes referred to as the "grandmother cell" [13]), describing how single neurons can learn to recognize abstract concepts.

This form of distributed storage increases the number of unique patterns a neural network can learn (sometimes referred to as the network's *expressiveness*). The resulting number of patterns can often exceed that encoded using a direct representation of equal size. For example, a network learning an addition function may first attempt to memorize all encountered results, but after sufficiently long training may eventually converge towards a simpler implementation of a bitwise adder simply because memoization will no longer fit in the network's storage capacity.

### 4.2.2 Memory

*Recurrent neural networks* (RNN) represent an important connectivity enhancement. Normal feed-forward networks connect neurons only between consecutive layers and are effectively stateless (the weights are maintained, but the last input is not stored past the current learning stage). RNNs add the notion of loops within the layers, allowing the network to preserve memory of the previous learning steps. This makes such networks effective in learning sequences and patterns (as opposed to a set of unordered samples), since the previously observed inputs take part in the computation of the current one, thereby allowing the trained functions to

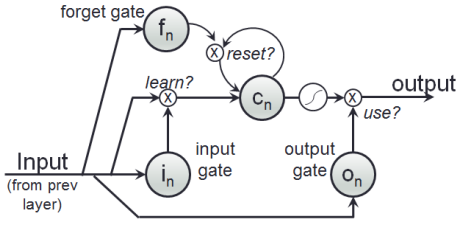

**Figure 4: Schematics of a single LSTM node. The incoming input value triggers the input, output and forget gates, which in turn update, reset, or use the value stored in the LSTM cell itself ( $c_n$ ) [14]**

become temporal. This is crucial when attempting to learn a sequence of memory accesses, since they very often represent some forms of temporal relations.

In this work we focus on a recent type of RNN called *Long-Short-Term-Memory* (LSTM) [14]. This variant adds neurons functioning as "gates" to control the internal loops, able to learn when the internal node should be used, adjusted, or reset. This allows memory to be safely stored for short or long periods, and used only when necessary. Figure 4 shows a single LSTM module, featuring an input, an output and a forget gate, all fed (along with the node itself) by the inputs of their respective layer, and trained by the backward step.

### 4.3 Sequence prediction with NNs

Before testing the full prefetcher design on real workloads, we first inspect several variants for training our neural network in order to observe how well they predict sequences of values. We start with the basic patterns in Table 1 as a benchmark for real memory access streams. We also add several sequences based on functions that represent patterns of various complexities, as a proxy for more complicated access streams: a (shifted) sine function, a polynomial function, a linear line and a pseudo-random function (LFSR over a 10th degree polynomial Galois field). Each series is fed into the neural network a single value at a time. And the output is trained to provide the next sequential element in one of several methods: Given  $x_n$ , the  $n^{th}$  element in the sequence of arguments, we teach the neural network to predict the next value based on the input in one of the following modes: Function estimation ( $x_n \rightarrow f(x_n)$ ); Next element prediction ( $f(x_{n-1}) \rightarrow f(x_n)$ ); Next element with history ( $f(x_{n-2}), f(x_{n-1}) \rightarrow f(x_n)$ ); or delta prediction ( $f(x_{n-1}) - f(x_{n-2}) \rightarrow f(x_n) - f(x_{n-1})$ ).

#### 4.3.1 Case study results

We measure the behavior of all benchmark sequences, using the 4 learning modes, and 5000 iteration phases with varying neural network sizes and structures. Results are shown in square error per element (sum of squares over all output bits), averaged over all elements in the sequence. Measuring average wrong bits per value produced similar results.

Figure 5 shows the average square error convergence over time for the same function, during the training process (sum of squared error per bit, averaged across all predicted values on a single cycle). As expected, the fastest converging network is initially the 3-level one which reaches steady state in less than 1000 iterations. The two 4-level networks ini-

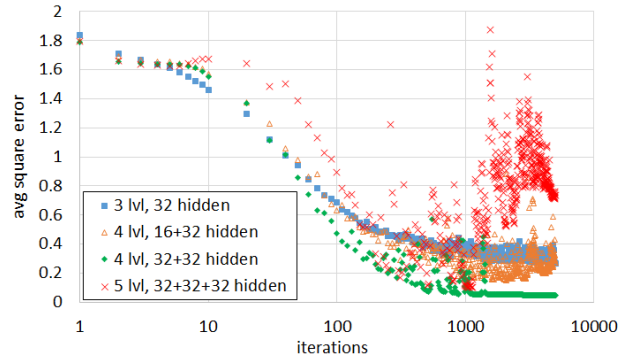

**Figure 5: Average square error convergence over time when training the  $\sin(x)$  function over different NN depths and sizes (lower is better).**

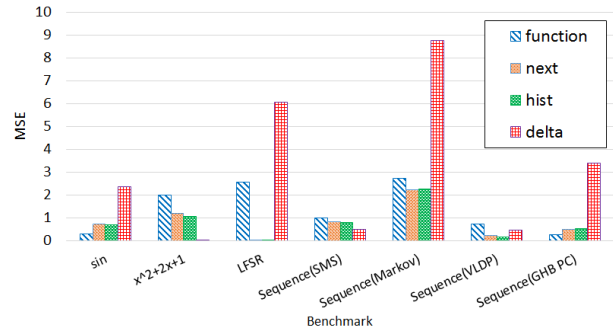
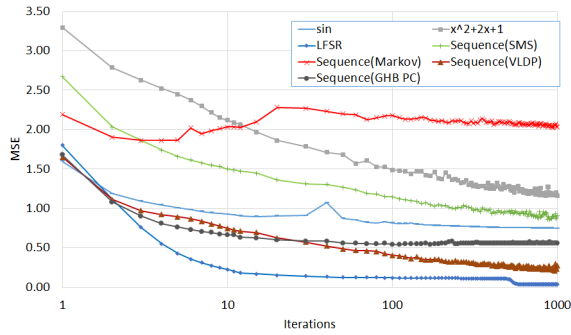

**Figure 6: Average square error for different sequences and learning modes, on a network with 32 hidden nodes.**

tially converge slower and are much more jittery during that process (as can be seen from the "cloud" of results) due to the interplay between the gradients of the two hidden levels, but eventually both surpass the 3-level network. The 5-level neural network is fluctuating even worse, as expected. However, it does not seem to converge on better results than the shallower networks, even when extending the process to  $10^6$  iterations, which makes it unpractical for online learning.

Figure 6 shows the average square error for the different benchmarks covered in this section, over a 3-level network with 32 hidden layer neurons, after 5000 iterations (each covering all the elements in the sequence). We observe that different functions benefit from different correlation methods: the polynomial function, for example, benefits from delta-learning as it reduces the polynomial degree. SMS benefits from deltas as well, since the pattern is intended to stress such recurring deltas. Markov and VLDP sequences, on the other hand, benefit from employing history in the input since this is the main way to distinguish between the Markov states. LFSR converges to an almost perfect prediction with any input that includes the previous element, due to the simple shift relations between elements (requiring that only the entropy bit be learned). The final conclusion from this experiment is that for best coverage of real sequences, we need to implement multiple modes of correlation in parallel, and dynamically alternate between them.

Figure 7 plots the rate of convergence over time for all



**Figure 7: Convergence rate for different benchmarking sequences, using history correlation mode.**

the benchmark functions (using history learning mode as an example), over the first 1000 steps. The rate of convergence is relatively fast: most of the patterns had to be replayed only 100-200 times for the network to reach close to the final values, and the error remains stable past that point. The only slow-to-converge sequence is the Markov series, due to the order of the benchmark, which traverses each edge on the address "graph" several consecutive times to give it the desired probability before traversing the other edges.

## 5. RELATED WORK

The challenge of using neural networks for predicting addresses consists, first, of showing that a neural network is able to provide meaningful predictions and identify complex patterns better than existing mechanisms. Then, we must understand whether it is possible to build such a network, fit it into the CPU, and sustain its power requirements. In this section we survey such prior work.

### 5.1 Prefetching techniques

Falsafi and Wenisch classified [1] prefetchers into 3 groups:

- **Stream/stride prefetchers** utilize *spatial locality*, common in many applications that use linear data structures placed sequentially in memory. These prefetchers simply detect the constant stride pattern and run ahead of the demand stream (sometimes even across page boundaries, effectively prefetching also page table entries). Most modern CPUs employ flavors of this family. Recent work by Pugsly et al. [15] proposed the Sandbox prefetcher, which cautiously tests different strides before choosing. Subsequent work by Ishii et al. [16], proposed Access Map Pattern Matching (AMPM), which detects the stride using shifted access pattern matching.
- **Address-correlating prefetchers** utilize *temporal locality* between pairs or sequences of accesses, indicating that accesses that appeared with some temporal adjacency in the past will manifest this adjacency in the future as well. The challenge is to isolate the correlated accesses out of a stream of unrelated ones. This approach can benefit from modeling the access stream as a Markov model; hence one of the original examples was the Markov predictor [8]. Later work improved the prefetching depth, including the

Global History Buffer Address-Correlation flavors (GHB/AC) by Nesbit and Smith [10], which observes a long history of accesses and isolates recurrences from it (sometimes using the program counter to isolate sub-streams); and the Irregular Stream Buffer (ISB) by Jain and Lin [17], which attempts to restructure the dataset spatially, similar to the instruction-based counterpart, the trace cache [18]. This category also includes work targeting linked data structures, such as that by Roth, Moshovos and Sohi [19], [20], and Bekerman et al. [21]. These prefetchers track recurring memory accesses and generate jump pointers into irregular data structures.

- **Spatially-correlated prefetchers** use an extension of temporal locality that correlates between spatial patterns instead of absolute addresses. These prefetchers seek out recurring spatial patterns that are not part of a long consecutive sequence but may repeat locally, such as accesses to the same fields of a structure across different instances. Examples of this family are Spatial Memory Streaming (SMS) by Somogyi et al. [7], the DC flavors of GHB [10], and the Variable Length Delta Prefetcher (VLDP) by Shevgoor et al. [9].

Context-based prefetchers can be seen as a combination of all the above. The wide context they use allows the correlation learning engine to extract either address or delta correlation artifacts, or even other forms of relations between history elements. Such a technique was recently presented by Peled et al. [2], using a *contextual-bandits* scheme and a slew of hardware and software attributes. However, that approach had to rely on complicated context hashing mechanisms and an inefficient attribute selection, and in many cases was shown to suffer from *overfitting*, causing storage bloat as well as having to re-learn the same context multiple times due to insignificant differences in useless attributes.

### 5.2 Neural network based predictors

The concept of using neural networks to optimize micro-architectural speculations and predictions has already been suggested. Jimenez and Lin proposed using perceptron-based neural networks for branch prediction [22]. More recently Teran, Wang and Jimenez extended this concept for predicting reuse distance and replacement policy [23]. The CPU industry is also attempting to incorporate these techniques, with both AMD and Samsung publicly claiming to incorporate neural networks into their branch predictors, in AMD's recent "Ryzen" architecture [24] and in Samsung's "M1" [25].

While predicting addresses adds a degree of complexity since the target is not a binary decision (taken vs. not-taken branch, or keep vs. replace for a cache line), this work sheds some light on the feasibility of implementing a simple neural network over hardware. Section 3 discusses how such networks may be constructed.

Due to the approximated results of a neural networks, their use is restricted to micro-architectural predictions, where a mistake does not have functional effects. However, neural networks are not restricted to that domain. Some researchers also apply them to predict functionally visible results. Esmaeilzadeh et al. presented a neural network based predictor for estimating function results [26], used when some degree

of approximation is allowed (such as some image processing kernels). Outside the CPU architecture domain, Knoll and Freitas [27] reviewed neural network models with *stochastic memoization* for sequence prediction used to optimize compression algorithms.

Siegelmann and Sontag have shown recurrent neural networks (RNN) to be Turing complete, i.e., to have the computational complexity of a Turing machine [28], even with the constraint of having rational weights, thus making it possible to model them with real hardware.

More recently, Google teams proposed using neural networks as a Turing-compatible model of computation in some scenarios: Graves, Wayne and Danihelka [29] proposed training such a network to learn the actions of an actual Turing machine, allowing it to learn simple algorithms; while Kurchak, Andrychowicz and Sutskever [30] proposed using a neural network with controlled memory nodes (LSTM) to perform complicated algorithms involving linked data structure and array manipulations, focusing on the detection of memory access sequence of specific tasks with small footprints. More recently, Graves et al. published a complete neural network based compute model called *differentiable neural computer (DNC)* [31], augmenting the neural network with a novel form of random access memory based on parallel weighted read/write matrix operations. DNC was also shown to successfully learn short graph traversals and predict resulting nodes and shortest paths.

However, when applying these models on real hardware, the computational and storage cost remains a critical limitation. Recent work attempts to mitigate that by employing dedicated eDRAM and optical interconnects for storing the weights (DaDianNao by Luo et al [32]), or by using resistive-memory based crossbars for storage and for analog computation of the neurons’ output (Shafiee et al. [33]).

Meanwhile, ongoing research seeks to simplify the cost of maintaining the NN node weights by reducing them to quantized (e.g. binary or ternary) values that will be easier to manage in hardware [34] [35]. This approach is for inference only, but quantized training is also explored [36]

### 5.3 Complexity limits

As stated before, different access sequences have different levels of pattern complexity. Balcázar and Gavaldà [12] proposed a set of complexity classes describing recursive sequences (they used the complexity theory equivalent of *languages* to the same effect), and have shown how the complexity is related to the amount of information the network can store in its weights, and at what precision (integer, rational or unbounded real numbers).

## 6. METHODOLOGY

The neural network based prefetcher was modeled on the gem5 [3] simulator, using system emulation (SE) mode in order to focus on the application user-level code, and running an out-of-order x86 CPU for realistic behavior. Table 3 specifies the parameters of the simulated system.

A large selection of frameworks is available for implementing neural networks (alexNet [37], Caffe [38], torch [39]). However, we preferred instead a simplified in-house model, both due to constraints in integration into our simulator, as

BFS	Breadth-first search over a spatial (array-based) 10k vertice graph
listsort	Linked list sorted insertion & deletion (over 1M elements)
matmul	Matrix multiplication (1k × 512 by 512 × 1k)
suffixArray	Create a suffix array of a 34M long DNA sequence
setCover	Find a greedy approximate minimal set cover over a 20k rMat based array represented graph
convexHull	Find a convex hull of a 500k 2D plumber map
spmv	Sparse matrix multiplication
array	Sum a 1M long array
bst	Binary search along a 10k array-based tree
prim	Find a Prim min spanning tree over a linked graph (2 <sup>12</sup> nodes, rMat generated)
list	Pointer chasing along a 200k long linked list
kruskal	Find a Kruskal min spanning tree over an array-based graph (100k nodes rMat generated)
patterns	Access along a 200k-long array using arithmetically growing index jumps

Table 2: Manual kernels.

Simulation mode	Sys. emulation, accurate timing, x86
Core type	OoO, 4-wide fetch
Queue sizes	192 ROB, 64 IQ, 256 PRF, 32 LQ/SQ
MSHRs	L1: 4, L2: 20
L1 cache	64kB Data, 32kB Code, 8 ways, 2 cycles access, private
L2 cache	2MB, 16 ways, 20 cycles access, shared
Main memory	2GB, 300 cycles access
NN prefetcher	
Levels	3, 4 or 5
Neurons	162 input, 64 output, 32-128 hidden per layer + 16 LSTM nodes (when applicable)
History queue	128 entries
Competing prefetchers	
GHB (all) [10]	GHB size: 2K, History length: 3 Prefetch degree: 3, Overall size: 32kB
SMS [7]	PHT size: 2K, AGT size: 32, Filter Table: 32 Regions size: 2kB, Overall size: 20kB
VLDP [9]	3 DPTs × 64 entries
Context RL [2]	CST size: 2K entries x 4 links (18kB), Reducer: 16K entries (12kB) Prefetch queue: 128 entries

Table 3: Simulator parameters.

well as to ensure that the implementation is feasible to implement in hardware and has no hidden optimizations.

Our network parametrizes the depth (number of layers), the width (number of nodes per layer), and the connectivity (number of nodes in the previous layer connected to a single node in the current one). In addition, it allows adding an arbitrary number of nodes with memory connectivity and gates, modeling LSTM connections.

Finally, we selected a wide range of common benchmark suites, including SPEC 2006 [4], Graph500 [5], HPCS [40]. We also added multiple hand-written kernels, to achieve high coverage of application behavior. Table 2 describes the manual kernels used. In this paper we focus on single-threaded applications to demonstrate how semantic locality prefetching can contribute even on that hard-to-scale class.

The benchmarks were compiled with an LLVM v3.6.2 compiler [41]. The simulation was done over 50M instructions phases, at skips of 50B/100B instructions. For SPEC06



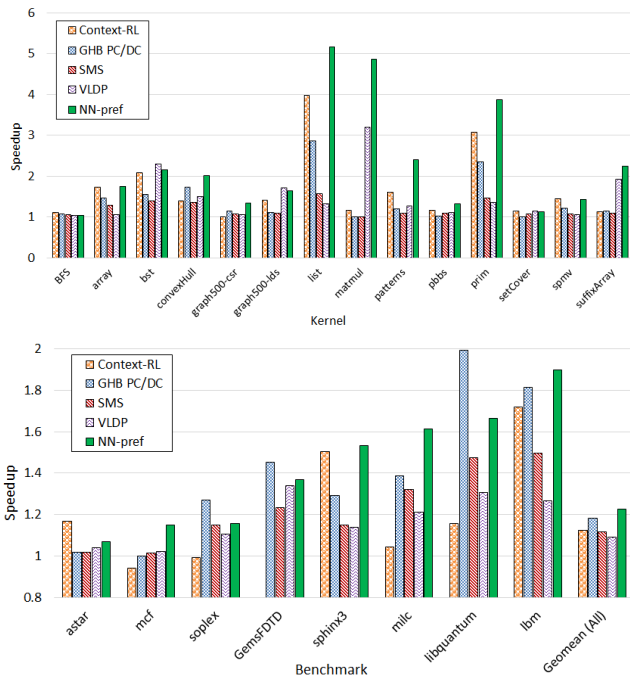

**Figure 8: Speedup gain from NN based prefetching vs. other techniques, over a variety of applications from different benchmark suites. Showing only tests with gain above 5% over any prefetcher (SPEC suite includes c/c++ based benchmarks could compile over LLVM).**

traces we usually captured 2-3 phases per trace, except when the hotspot did not show benefit for any of the prefetchers checked (usually due to low memory activity phases).

Multi threaded applications were not handled in this paper as we aim to explore the limits of single-threaded performance which is more limited by memory latency. We believe that MT runs may gain additional benefit from shared learning on similar threads and further improve the performance, but this is left for future work.

## 7. EVALUATION

The neural networks evaluated for our prefetcher have 3 levels (1 hidden layer with 128 neurons), 4 levels (2 hidden layers with 96 and 64 neurons respectively) and 5 levels (3 hidden layers with 96, 64 and 64 neurons). We also ran the 3 level network with additional 16 LSTM nodes, making them recurrent (RNN). Deeper networks are not tested here as even 5-level networks were shown in Section 4 to converge too slowly. Convolutional neural networks (CNN) were also tested but are not shown since the results were not stable enough and the partial connectivity we used degraded their performance without exposing the desired spatial locality across input nodes.

Figure 8 compares the IPC speedup of the 3-level NN prefetcher against other state-of-the-art prefetchers. The speedup is shown compared to a baseline with no prefetching. The workloads shown are the ones that have exhibited some minimal degree of sensitivity to prefetching, getting a speedup of at least 5% on any of the tested prefetchers. How-

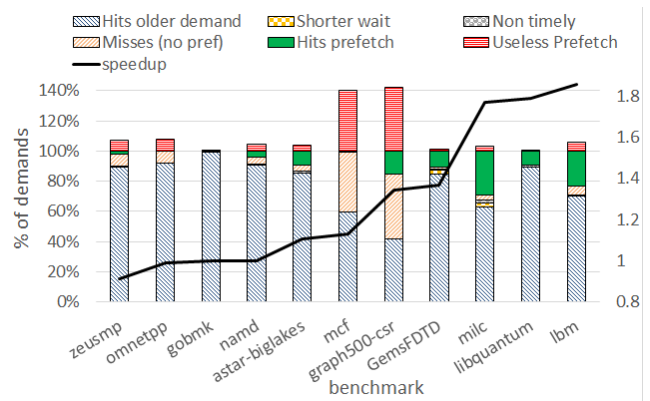

**Figure 9: Breakdown of demand accesses according to the prefetch usefulness. Useless prefetches are stacked on top of the 100% demands. Only tests with over 10% demand L1 miss rate or with a large useless prefetch bucket are shown. The secondary axis shows the speedup curve.**

ever, the geomean shown for SPEC2006 is over the entire suite, except for Fortran benchmarks that could not be compiled on our LLVM/clang, and some benchmarks that had build issues (gcc, perlbench) or were not supported by gem5. The graph shows most of the benchmarks with complex memory access patterns benefit significantly from the neural network based prefetchers. On average, the NN-prefetcher gains 22%, which is 17% higher than GHB PC/DC, 1.7 $\times$  higher than SMS, 1.9 $\times$  higher than VLDP and 2 $\times$  higher than the RL-based context prefetcher. The most notable gain on SPEC2006 was in LBM (which averaged to 90%, although some of the phases reached a local speedup of 2.8 $\times$ ). On kernels, the benefits are even higher, with the max gain (on a linked list traversal test) above 5 $\times$ .

Figure 10 Shows how the different association schemes described in Section 3 perform over some of the benchmarks (single phase at 50G skip). When there are more NNs than allowed prefetches, we arbitrate based on NN usefulness, which is tracked over time (same as the metric used for dynamic parameter tuning). We observe that 4 parallel networks are not necessarily better than two, both due to additional thrashing (GemsFDTD for example loses the more networks we activate), and possibly because the PC-based association is less effective (LBM and milc). The remainder of the results were obtained using the 2NN scheme.

Figure 9 shows the breakdown of miss reasons in the L1 cache. A request can be categorized as one of the following:

- Miss (not prefetched): the line was never prefetched, and the request resulted in a cache miss.
- Non-timely: the address was predicted by the prefetcher, but a prefetch has not been sent yet. This indicates the prefetcher was predicting the right address, but associated it with a too-recent context.
- Shorter wait: a prefetch was sent but has not completed yet. This hides the miss latency only partially.
- Hit older demand: cache hit on a line that was already accessed by another demand. Prefetch is not needed.

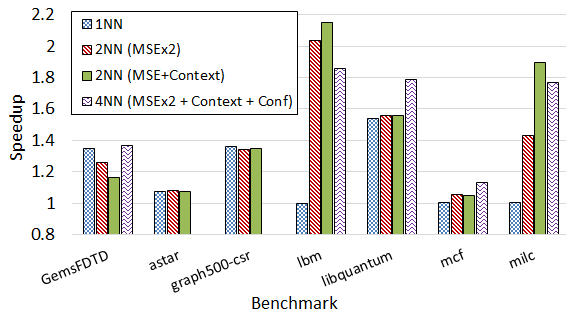

**Figure 10: Comparison between different layouts of parallel NNs with different association schemes. MSE associates min MSE output (per NN), Context prefers matches in context hash, and Conf prefers associating addresses of frequent PCs.**

On top of these categories covering 100% demands, we add bad prefetches: addresses prefetched but never used while in the cache, indicating that the prefetcher was wrong about the address or the timing. Speedup is correlated with having many useful prefetches, but also not having too many useless ones. In some cases (e.g. MCF), the gain is purely from reducing the latency, indicating that the prefetcher is successful, but further depth tuning may provide better results.

### 7.1 Comparing different neural networks

Figure 11 shows the impact of network size (number of neurons in the hidden layers), depth, and the use of special features such as LSTM nodes. Interestingly, the differences are very small, and some benchmarks exhibit opposite trends (LBM prefers smaller, simpler networks, while GemsFDTD and MCF prefer larger networks). This negligible differences conforms with the observation that deeper networks cannot perform online training fast enough against changing code phases to extract any benefits from their size, instead using only part of their potential.

As for the differences per application preference: LBM benefits the most from a simple neural network while MCF, GemsFDTD and astar get a small benefit from adding LSTM nodes. This is due to the reuse-distance of pattern types: MCF cannot memorize its full linked data structures as they are too big, and can therefore gain from long term memory for some critical nodes (like the first few levels of its cost network). The same applies for other applications using linked data structures like astar. LBM on the other hand has a grid layout that is more spatially recurrent, and can train a generic pattern that does not require long term memory.

### 7.2 Classifying prefetch usefulness

The wide range of applications demonstrates different ways in which the neural network prefetcher may be useful. These can be bucketed according to the classification described in Section 5. First, there are the spatially organized applications (or phases within an application), where the program traverses data structures sequentially. In these cases, the neural network prefetcher can learn a constant delta, but so can the other prefetchers (especially the spatially oriented SMS and both delta-correlation (DC) flavors of GHB). The

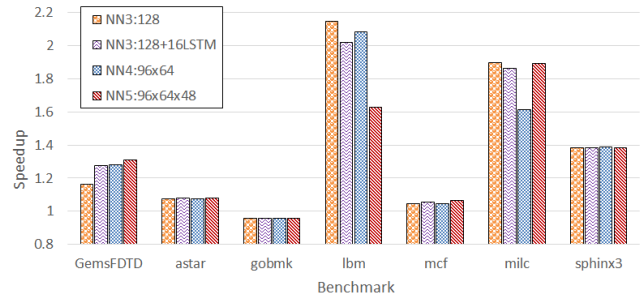

**Figure 11: Comparison between NN sizes, depths, and special features like LSTM nodes.**

neural network prefetcher was able to gain more owing to better context localization (of which the GHB-PC/DC also benefits to a lesser extent). In some of the cases, the neural network prefetcher also gained thanks to the fixed distance policy (associations are always made at a fixed history distance), which improved its coverage.

The second category is of temporally correlated applications such as linked lists. These cases are almost impossible to describe as a function, as they exhibit a random dataset layout. The recurrence can however be recorded and replayed, at least up to the length that the prefetcher storage can support. In this category (and most notably in the link-based version of SSCA), the context-RL prefetcher often wins due to the speed of its learning (a single access is enough to generate a complete prediction). However, on larger data-set sizes, the neural network will be able to scale better than the context-RL prefetcher thanks to its distributed storage.

### 7.3 Comparison with other prefetchers

The neural network prefetcher and the context-based RL prefetcher represent a similar method of learning through associative pairing between context states and addresses. Comparing them will therefore illustrate the difference between the storage and complexity limitations (albeit there may also be minor differences in the policies used by the two methods to select the best associations).

For some of the applications we can see that context-RL provides a higher speedup, the most notable example being the list-sort kernel. Analyzing the results shows that the list itself is too big to fit in any of the prefetchers in full (allowing only a subset of the list to be stored). Because the sorted list is built gradually, a limited head segment of it can easily fit, since it has a higher chance to be used during every search. However, this segment may frequently change while elements are being added with uniform distribution across the list. The context-RL prefetcher can update the CST table on such changes with a better association (a process that occurs instantly once the score of the new association exceeds that of the old one). Conversely, the neural network prefetcher has to rebuild its weights to reflect the change. Since each these weights represent multiple elements in parallel, this process may break other predictions, and may take a long while to reconverge every time the data structure changes.

In some cases, however, applications such as LBM, and kernels such as prim and matmul, show significant gains com-

pared to the context-RL prefetcher, partly because of better storage and contextual associations (mostly on a complex pattern, as in prim and LBM), and partially due to association policies that favor constant lookahead depth (which is useful for spatial traversals, as in matmul).

Gobmk shows an interesting gain unique to NN-prefetch (only on the longer skips). This Go benchmark recursively plays game moves down the decision tree and recovers them when they are pruned. This makes the stack of board states big, but the allocation scheme groups related moves spatially. The descent depends on prior decisions, making the branch/PC history an effective heuristic for the chosen paths. The NN usefulness is only observable on the longer skips, when the game stack becomes larger and more fractured.

## 7.4 Path to feasibility

Implementing a neural network requires a significant die area and consumes a lot of power. Even for the simplest 3-level flavor explored (with 32 hidden neurons), a fully connected topology using our  $\sim 162$ -wide input vector will include the following multiply-and-accumulate operations for the feed forward operation (and approximately the same for the backward propagation step):

$$N_{fma} = N_{input} * N_{hidden} + N_{hidden} * N_{output} \approx 6.2k \quad (1)$$

Based on Horowitz et al. [42], with 32bit floating point (single precision), on a 45nm process, this would consume roughly 4.6pJ per FMA operation, and a total of 30nJ for a single inference flow. This is 10-20x more than the single DRAM access that we aim to predict. However, process scaling have provided a significant power and energy reduction since: Bohr claims [43] an estimated  $1.6\times$  improvement in energy efficiency per generation on Intel process, indicating that a neural network on 14nm (3 process nodes beyond 45nm) should be  $\sim 4\times$  more energy efficient.

Next is the issue of die area. Based on estimations by Brunie [44], a single precision FP FMA with fixed point accumulator would require  $\approx 4800\mu m^2$  per cell, or about  $30mm^2$  for the required FMAs, before considering the control logic, data paths, registers and other components. Even scaled to 14nm ( $8\times$  smaller in area), this is impossible to fit on core.

The first mitigation, often employed in modern neural networks, is trading off precision for power and area. Most common implementation today support half-precision floating point math (FP-16) [45], and some even reach 8-bit precision [46], with very small impact on the overall accuracy of the NN results. Such reduction was shown to save area by up to 62% per 2x precision reduction [44], due to both the number of operations and the simplification of the carry chains. Furthermore, since most of the operations performed by a neural network are eventually matrix multiplications, some designs such as Google’s TPU implement a systolic array and tile the operations to fit it. This allows a further trade off of power and area by spanning each phase over several cycles.

Finally, recent work is showing rapid progress with quantized neural networks, where the values (weights and activation values) are reduced to a few bits [36], with the extreme of binary neural networks [34] [47] [48]. This allows to simplify the calculation steps significantly. With a BNN for example, all FMA operations on binary values are reduced to simple

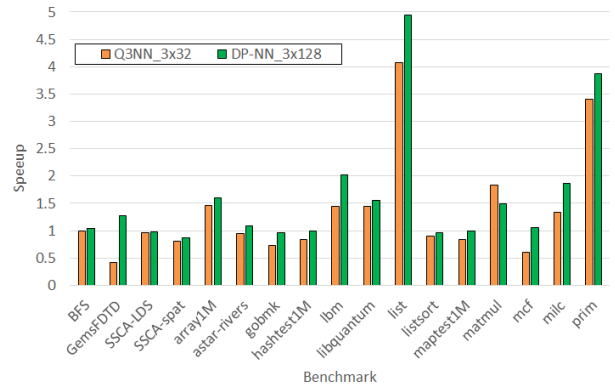

**Figure 12: Comparing a neural network using double-precision FP values and one using 3 bit quantized values.**

bitwise logic (XNOR and popcount). The main hurdle with quantized networks is that until recently they were applied only for inference. However, recent work by Courbariaux et al. [49] and by Tang et al. [50] shows promising results in training such networks using binary calculation.

We implemented a simplified version of a QNN network and integrated it into our prefetcher. Figure 12 shows a comparison of a 3-layer network (128 hidden nodes) between using a double-precision floating-point weights and activations and 3-bit quantized values (the input and output values are always binary, but the internal neuron outputs are not necessarily so). Most benchmarks sustain only a small hit in their speedup, with the exception of MCF and gemsFDTD that get a significant slowdown due to their inability to converge.

Finally, the prefetcher will be triggered only on L1 misses, which reduces the required energy. We assume an average load frequency of  $\sim 50\%$  and an  $\sim 80\%$  L1 hit rate (this was confirmed by miss rates in the actual runs, seen in figure 9), thereby triggering the training process only once every  $\sim 10$  instructions. This gives an additional  $10\times$  reduction in power. It also allows spanning the training flow over multiple cycles.

## 8. CONCLUSIONS

This paper presents a conceptual neural network memory prefetcher based on the *semantic locality* model. This recently proposed model argues that locality of reference is an artifact intrinsic to the program implementation rather than a simple *spatio-temporal* correlation. The proposed prefetcher learns the algorithmic properties of the running program by feeding machine and program state elements as inputs to a neural network, which predicts future memory accesses. The neural network is trained at runtime using the observed memory access stream and the machine state.

Our main goal in this paper is to examine whether the learning capabilities of a neural network are inherently superior to those of other machine learning or heuristic-based techniques. The neural network prefetcher covers a spectrum of spatio-temporal access patterns that today require multiple heuristic *spatio-temporal* prefetchers to handle. Our analysis of the demonstrates that it outperforms other state-of-the-art prefetchers, providing 17% more speedup on SPEC06 than GHB-PC/DC and  $1.7\times$  more than SMS.

Our feasibility analysis of the proposed prefetcher shows it is not yet realizable using existing neural network technology. The benefits are currently outweighed by the overheads in learning time, area, and power efficiency. However, we show that precision reduction and quantization will soon be able to mitigate these overheads with little impact on accuracy. The fast evolution of neural network technology will make future networks faster, more compact, and more efficient, thereby making the neural network prefetcher feasible.

## 9. REFERENCES

- [1] B. Falsafi and T. F. Wenisch, "A primer on hardware prefetching," *Synthesis Lectures on Computer Architecture*, vol. 9, no. 1, 2014.
- [2] L. Peled, S. Mannor, U. Weiser, and Y. Etsion, "Semantic locality and context-based prefetching using reinforcement learning," Jun 2015.
- [3] N. Binkert, B. Beckmann, G. Black, S. K. Reinhardt, A. Saida, A. Basu, J. Hestness, D. R. Hower, T. Krishna, S. Sardashti, R. Sen, K. Sewell, M. Shoaib, N. Vaish, M. D. Hill, and D. A. Wood, "The Gem5 simulator," vol. 39, Aug. 2011.
- [4] Standard Performance Evaluation Corporation, "SPEC2006," <http://www.spec.org>.
- [5] R. C. Murphy, K. B. Wheeler, B. W. Barrett, and J. A. Ang, *Introducing the Graph 500*. Cray Users Group (CUG), May 2010.
- [6] N. Merhav and M. Feder, "Universal prediction," *IEEE Trans. on Information Theory*, vol. 44, no. 6, pp. 2124–2147, 1998.
- [7] S. Somogyi, T. F. Wenisch, A. Ailamaki, B. Falsafi, and A. Moshovos, "Spatial memory streaming," Jun 2006.
- [8] D. Joseph and D. Grunwald, "Prefetching using markov predictors," Jun 1997.
- [9] M. Shevgoor, S. Koladiya, R. Balasubramonian, C. Wilkerson, S. H. Pugsley, and Z. Chishti, "Efficiently prefetching complex address patterns," Dec 2015.
- [10] K. J. Nesbit and J. E. Smith, "Data cache prefetching using a global history buffer," Feb 2004.
- [11] V. Nair and G. E. Hinton, "Rectified linear units improve restricted boltzmann machines," in *Proceedings of the 27th international conference on machine learning (ICML-10)*, pp. 807–814, 2010.
- [12] J. L. Balcazar, R. Gavalda, and H. T. Siegelmann, "Computational power of neural networks: a characterization in terms of Kolmogorov complexity," *IEEE Trans. on Information Theory*, vol. 43, pp. 1175–1183, Jul 1997.
- [13] C. G. Gross, "Genealogy of the 'grandmother cell'," *The Neuroscientist*, vol. 8, no. 5, pp. 512–518, 2002.
- [14] K. Greff, R. K. Srivastava, J. Koutník, B. R. Steunebrink, and J. Schmidhuber, "LSTM: A search space odyssey," *CoRR*, vol. abs/1503.04069, 2015.
- [15] S. H. Pugsley, Z. Chishti, C. Wilkerson, P. f. Chuang, R. L. Scott, A. Jaleel, S. L. Lu, K. Chow, and R. Balasubramonian, "Sandbox prefetching: Safe run-time evaluation of aggressive prefetchers," Feb 2014.
- [16] Y. Ishii, M. Inaba, and K. Hiraki, "Access map pattern matching for data cache prefetch," Jun 2009.
- [17] A. Jain and C. Lin, "Linearizing irregular memory accesses for improved correlated prefetching," Dec 2013.
- [18] A. Peleg and U. Weiser, "Dynamic flow instruction cache memory organized around trace segments independent of virtual address line," Jan 1995. US Patent 5,381,533.
- [19] A. Roth, A. Moshovos, and G. S. Sohi, "Dependence based prefetching for linked data structures," Oct 1998.
- [20] A. Roth and G. S. Sohi, "Effective jump-pointer prefetching for linked data structures," May 1999.
- [21] M. Bekerman, S. Jourdan, R. Ronen, G. Kirshenboim, L. Rappoport, A. Yoaz, and U. Weiser, "Correlated load-address predictors," May 1999.
- [22] D. A. Jimenez and C. Lin, "Dynamic branch prediction with perceptrons," Jan 2001.
- [23] E. Teran, Z. Wang, and D. A. Jiménez, "Perceptron learning for reuse prediction," Oct 2016.
- [24] AMD, "The "zen" core architecture." <http://www.amd.com/en-gb/innovations/software-technologies/zen-cpu>, 2016.
- [25] AnandTech, "Hot chips 2016: Exynos m1 architecture disclosed." <http://www.anandtech.com/show/10590/hot-chips-2016-exynos-m1-architecture-disclosed>, 2016.
- [26] H. Esmaeilzadeh, A. Sampson, L. Ceze, and D. Burger, "Neural acceleration for general-purpose approximate programs," Dec 2012.
- [27] B. Knoll and N. de Freitas, "A machine learning perspective on predictive coding with PAQ8," in *Data Compression Conference (DCC)*, pp. 377–386, 2012.
- [28] H. T. Siegelmann and E. D. Sontag, "On the computational power of neural nets," in *Ann. Workshop on Computational Learning Theory*, pp. 440–449, 1992.
- [29] A. Graves, G. Wayne, and I. Danihelka, "Neural turing machines," *CoRR*, vol. abs/1410.5401, Dec 2014.
- [30] K. Kurach, M. Andrychowicz, and I. Sutskever, "Neural random-access machines," *CoRR*, vol. abs/1511.06392, Feb 2015.
- [31] A. Graves, G. Wayne, M. Reynolds, T. Harley, I. Danihelka, A. Grabska-Barwińska, S. G. Colmenarejo, E. Grefenstette, T. Ramalho, J. Agapiou, *et al.*, "Hybrid computing using a neural network with dynamic external memory," *Nature*, vol. 538, no. 7626, pp. 471–476, 2016.
- [32] T. Luo, S. Liu, L. Li, Y. Wang, S. Zhang, T. Chen, Z. Xu, O. Temam, and Y. Chen, "DaDianNao: A neural network supercomputer," vol. 66, Jan 2017.
- [33] A. Shafiee, A. Nag, N. Muralimanohar, R. Balasubramonian, J. P. Strachan, M. Hu, R. S. Williams, and V. Srikumar, "ISAAC: A convolutional neural network accelerator with in-situ analog arithmetic in crossbars," June 2016.
- [34] I. Hubara, M. Courbariaux, D. Soudry, R. El-Yaniv, and Y. Bengio, "Binarized neural networks," in *Advances in Neural Information Processing Systems 29* (D. D. Lee, M. Sugiyama, U. V. Luxburg, I. Guyon, and R. Garnett, eds.), pp. 4107–4115, Curran Associates, Inc., 2016.
- [35] H. Alemdar, V. Leroy, A. Prost-Boucle, and F. PÄI'trot, "Ternary neural networks for resource-efficient ai applications," in *2017 International Joint Conference on Neural Networks (IJCNN)*, pp. 2547–2554, May 2017.
- [36] I. Hubara, M. Courbariaux, D. Soudry, R. El-Yaniv, and Y. Bengio, "Quantized neural networks: Training neural networks with low precision weights and activations," *arXiv preprint arXiv:1609.07061*, 2016.
- [37] A. Krizhevsky, I. Sutskever, and G. E. Hinton, "ImageNet classification with deep convolutional neural networks," 2012.
- [38] Y. Jia, E. Shelhamer, J. Donahue, S. Karayev, J. Long, R. Girshick, S. Guadarrama, and T. Darrell, "Caffe: Convolutional architecture for fast feature embedding," in *ACM Intl. Conference on Multimedia*, 2014.
- [39] R. Collobert, S. Bengio, and J. Marithoz, "Torch: a modular machine learning software library," Tech. Rep. IDIAP Research Report 02-46, Idiap Research Institute, 2002.
- [40] D. A. Bader and K. Madduri, "Design and implementation of the HPCS graph analysis benchmark on symmetric multiprocessors," in *Intl. Conf. on High Performance Computing (HiPC)*, Dec 2005.
- [41] C. Latner and V. Adve, "LLVM: a compilation framework for lifelong program analysis transformation," Mar 2004.
- [42] M. Horowitz, "1.1 computing's energy problem (and what we can do about it)," in *2014 IEEE International Solid-State Circuits Conference Digest of Technical Papers (ISSCC)*, pp. 10–14, Feb 2014.
- [43] M. Bohr, "14 nm process technology: Opening new horizons," in *Intel Developer Forum (IDFÄZ14)*, 2014.
- [44] N. Brunie, "Modified fused multiply and add for exact low precision product accumulation," in *2017 IEEE 24th Symposium on Computer Arithmetic (ARITH)*, pp. 106–113, July 2017.
- [45] M. H. Ionica and D. Gregg, "The movidius myriad architecture's

potential for scientific computing,” *IEEE Micro*, vol. 35, pp. 6–14, Jan 2015.

- [46] N. P. Jouppi, C. Young, N. Patil, D. Patterson, G. Agrawal, R. Bajwa, S. Bates, S. Bhatia, N. Boden, A. Borchers, R. Boyle, P.-I. Cantin, C. Chao, C. Clark, J. Coriell, M. Daley, M. Dau, J. Dean, B. Gelb, T. V. Ghaemmaghani, R. Gottipati, W. Gulland, R. Hagmann, C. R. Ho, D. Hogberg, J. Hu, R. Hundt, D. Hurt, J. Ibarz, A. Jaffey, A. Jaworski, A. Kaplan, H. Khaitan, D. Killebrew, A. Koch, N. Kumar, S. Lacy, J. Laudon, J. Law, D. Le, C. Leary, Z. Liu, K. Lucke, A. Lundin, G. MacKean, A. Maggiore, M. Mahony, K. Miller, R. Nagarajan, R. Narayanaswami, R. Ni, K. Nix, T. Norrie, M. Omernick, N. Penukonda, A. Phelps, J. Ross, M. Ross, A. Salek, E. Samadiani, C. Severn, G. Sizikov, M. Snelham, J. Souter, D. Steinberg, A. Swing, M. Tan, G. Thorson, B. Tian, H. Toma, E. Tuttle, V. Vasudevan, R. Walter, W. Wang, E. Wilcox, and D. H. Yoon, “In-datacenter performance analysis of a tensor processing unit,” in *Proceedings of the 44th Annual International Symposium on Computer Architecture*, ISCA ’17, (New York, NY, USA), pp. 1–12, ACM, 2017.
- [47] M. Kim and P. Smaragdis, “Bitwise neural networks,” *CoRR*, vol. abs/1601.06071, 2016.
- [48] M. Rastegari, V. Ordonez, J. Redmon, and A. Farhadi, *XNOR-Net: ImageNet Classification Using Binary Convolutional Neural Networks*, pp. 525–542. Cham: Springer International Publishing, 2016.
- [49] M. Courbariaux and Y. Bengio, “Binarynet: Training deep neural networks with weights and activations constrained to +1 or -1,” *CoRR*, vol. abs/1602.02830, 2016.
- [50] W. Tang, G. Hua, and L. Wang, “How to train a compact binary neural network with high accuracy?,” in *Thirty-First AAAI Conference on Artificial Intelligence*, 2017.