

Mobile Energy Internet

Mingqing Liu, Mingliang Xiong, Hao Deng, Qingwen Liu, Jun Wu, and Pengfei Xia

Abstract

Similar to the evolution from the wired Internet to mobile Internet (MI), the growing demand for power delivery anywhere and anytime appeals for power grid transformation from wired to mobile domain. We propose here the next generation of power delivery network – mobile energy internet (MEI) for wireless energy transfer within a mobile range from several meters to tens of meters. MEI will be a significant complement for the Internet of things (IoT), because battery charging is one of the biggest headaches for IoT devices. At first, we present the application scenarios of MEI to show its prospect in practical application. Since MEI relies on wireless power transfer (WPT), we then particularly introduce a promising long-range high-power WPT method, namely resonant beam charging (RBC), which can transmit wireless power to multiple devices concurrently and safely. Following the comparison of various WPT technologies, we specify the MEI architecture with access layer and backbone layer, and then propose the software-defined MEI. Finally, we demonstrate the features and challenges of MEI. MEI will be the expansion from the power grid to mobile domain, which has the potential to play the similar role of MI in information technology.

Index Terms

Mobile Energy Internet, Wireless Power Transfer, Resonant Beam Charging, Internet of Things.

I. INTRODUCTION

Beyond enhancement of bit-rate and latency performance for mobile communication systems, Klaus David and Hendrik Berndt “present a vision for the sixth generation (6G) and its requirements” that “mobile device battery life should be substantially extended”, where one of the key approaches is wireless energy transmission [1]. The perpetual battery life for mobile devices is one of the promising 6G innovations. Thus, mobile access to energy anywhere and anytime becomes a vital requirement for the next generation of the Internet. Similar to wireless information transfer (WIT) in information domain, the wireless power transfer (WPT) technology enables mobile power transfer in energy domain. Therefore, we propose the mobile energy internet (MEI), in order to extend the power delivery to the mobile realm.

The concept of MEI is derived from the evolvement of the Internet to mobile Internet (MI). In contrast to fixed Internet, MI realizes the information dissemination over the air and solves the problem of the last-kilometer information delivery. Similarly, to deal with the limits of fixed power transfer with the power grid, MEI is presented to transfer power over the air and solve the last-meters power delivery. Moreover, the idea of MEI is designed with

Mingqing Liu, Mingliang Xiong, Hao Deng, Qingwen Liu, Jun Wu, Pengfei Xia, are with Department of Computer Science and Technology, Tongji University, Shanghai, People’s Republic of China (e-mail: clare@tongji.edu.cn, xiongml@tongji.edu.cn, qliu@tongji.edu.cn, wujun@tongji.edu.cn, pengfei.xia@gmail.com).

the combination of wireless power transfer (WPT) technologies and wireless communications technologies, so as to achieve the control, scheduling, and user services of power transfer. Thus, the “mobile power delivery” anywhere, anytime could be realized.

Nowadays, the issue of battery endurance has been plaguing smartphone users. On the one hand, the ratio of the battery volume/weight to smartphones is up to 40 percent and the risks of explosion limit the increment of battery capacity. On the other hand, people desire the WiFi-like power supply to be available in public places such as airport terminals and theatres with the increasing “smartphone power anxiety”. However, the inconvenience of carrying battery charger or finding power supply become tremendous headaches for mobile device users. Unmanned aerial vehicle (UAV), as an emerging technology, has rapid development and wide application. However, UAV battery endurance is still a key challenge restricting its prospective development. Likewise, consumer electronics such as Internet of things (IoT) products, wearable devices and virtual reality (VR) / augmented reality (AR) equipment also face the predicament on the sustainable power supply. Thus, mobile power delivery that supports wireless charging anywhere anytime draws our attention to break the above bottlenecks. Given such motivations, we propose the paradigm of MEI relying on WPT technologies. It is a promising solution to provide convenient and perpetual battery life, which can satisfy the most basic human needs in this era of digital evolution.

Matter, information and energy are the three fundamental elements of nature and society. The basic needs of humans are based on the transformation and circulation of the three elements in time and space. Just as the advent of transportation networks enables physical delivery and the development of MI facilitates the mobile information exchange, the emergence of MEI can realize mobile power transfer anywhere, anytime. People will get mobile power no longer restricted by safety, time, space and other limitations, which will bring 6G vision into reality.

II. APPLICATION SCENARIOS

Figure 1 shows MEI’s application scenarios. A dividing line separates the fixed power grid and the Internet from MEI, while the right part shows the mobile essence of MEI: solving the mobile power transmission problems of the last few meters or tens of meters. Different from the existing fixed power grid, MEI focuses on wireless power transmission over the air and delivers power primarily depending on a variety of WPT technologies, so that power can be obtained anywhere and anytime. Furthermore, MEI also includes the unified control and management of wireless power transfer, while the data generated from MEI is mainly internal control signaling. The information in MEI accesses to the Internet, while the power in MEI is provided primarily by the fixed power grid. To elaborate the application scope of MEI and the benefits brought by MEI, we summarize MEI network as MEI infrastructural network and MEI ad-hoc network. We also discuss the WPT requirements of each possible application scenario.

1) *MEI Infrastructural Network*: In Fig. 1, the MEI infrastructural network provides wireless power for multiple devices in an indoor environment, where the wireless power transmitters can be embedded in light bulbs on the ceiling. The network can be deployed in public places such as coffee shops, airport terminals and theatres to provide charging services covering the room. Moreover, MEI infrastructural network can provide mobile power for electric vehicles if deployed in parking lots. The power transmitters may also be placed on buildings, utility poles or trees to provide power supply outdoors. Thereafter wireless power may be provided and managed by specialized operators

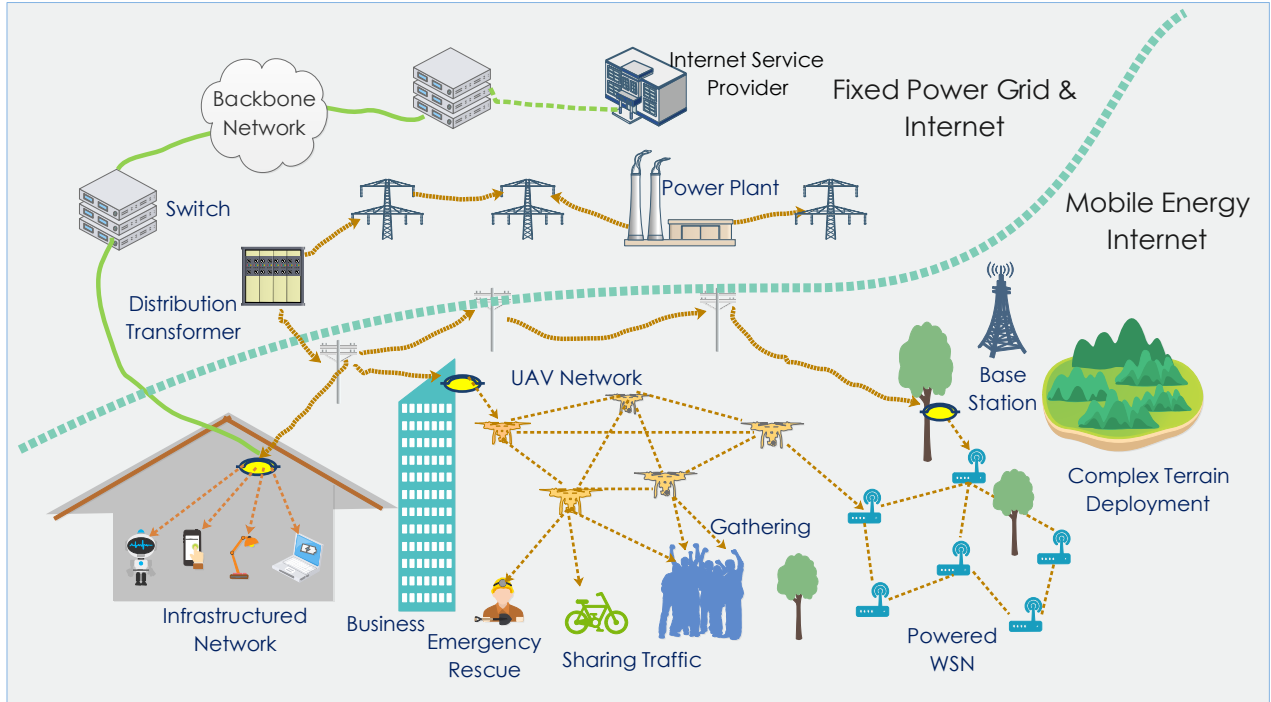

Figure 1. MEI Application Scenarios

and power can be accessed anytime and anywhere, similar to the information access process nowadays. As applied in the scenarios closely related to humans, safety is a fundamental requirement of the employed WPT technologies. High power is also needed due to the charging power level of mobile devices. Moreover, the feature of simultaneous multi-users charging contributes to the increment of network capacity. With appropriate WPT technologies, the MEI infrastructural network can satisfy the mobile charging demand of home appliances and mobile devices without cords, which will bring much convenience for human life.

2) *MEI Ad-hoc Network*: The MEI ad-hoc network aims at providing the wireless charging services in the temporarily established outdoor situation. It can serve scenarios such as large gatherings, shared traffic and emergency rescues. UAVs, which are integrated with the wireless power transmitter, can provide power to each other to ensure the stability and long-term functionality of the network. Meanwhile, UAVs can serve all the devices requiring mobile power in their charging ranges. In UAV-based MEI ad-hoc network, the WPT technologies with the features of long charging distance, high efficiency, high-power, line of sight (LOS) and large user capacity should be adopted, so that wireless power may be provided without limitation of time and places. Wireless sensor network (WSN) faces power endurance challenges particularly when applied in extreme environment. The MEI ad-hoc network can also supply power to WSNs, particularly when WSN is deployed in forests, deserts or oceans to monitor environment. While determined by the characteristic of WSN, the watt-level of WPT may be not highly required. Therefore, MEI for WSN should employ the WPT technologies with features of long-range and non LOS to provide perpetual power supply.

Above all, MEI relies on the integration of various WPT technologies for their respective applications and

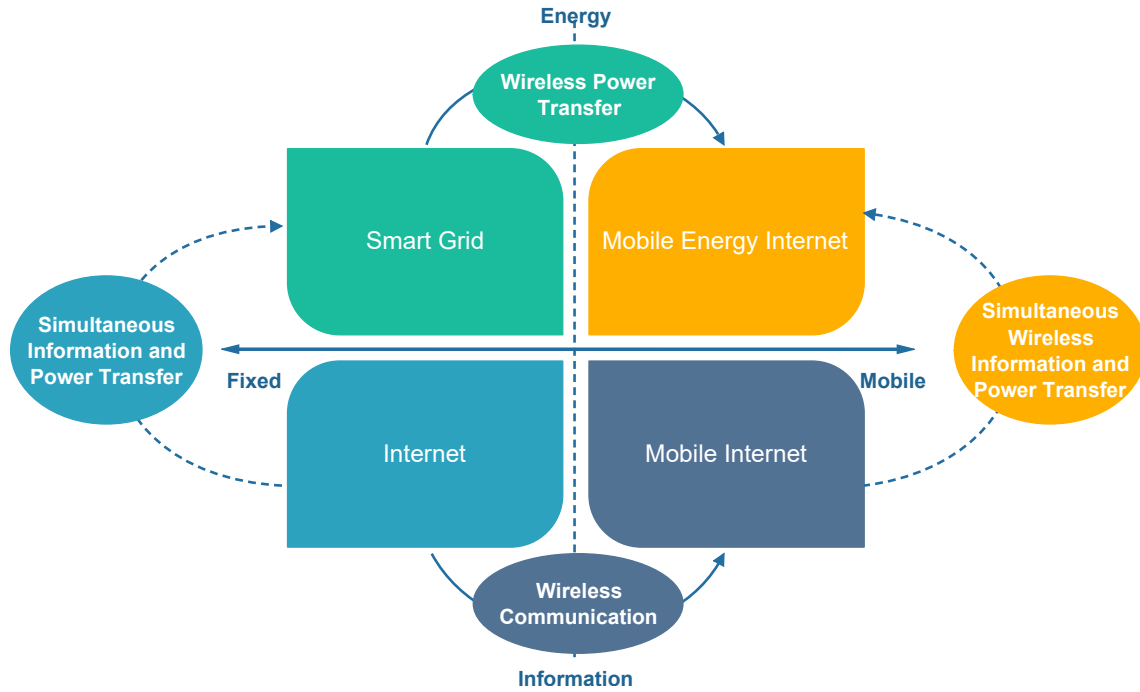

Figure 2. Concept Evolution

the centralized management. MEI provides diversified possibilities for charging devices to access to power supply wirelessly. Mobile devices can require wireless charging services by sending signals to the servers through cellular base stations.

III. CONCEPTUAL RELATIONSHIP

The Internet is the subversive medium which has changed human life from various aspects. Mobility, however, is an important dimension of Internet development. From the Internet to the MI, mobile terminals can connect to the Internet anywhere, anytime. Currently, people can get information whenever and wherever they want just with a mobile terminal which can access to MI. Furthermore, MI provides freedom for people with a brand new lifestyle of study, work, entertainment, and business.

Smart grid is an electrical grid which includes intelligent operation and management of power with advanced information technologies [2]. It enables power supply entering into human's daily life which brings much convenience for people in using power. The essence of smart grid is to realize flexible, stable, efficient and accessible power supply. However, the fixed smart grid couldn't meet the emerging charging requirements with the popularity of mobile devices. Nowadays, the endurance of various mobile devices appeals for anywhere and anytime power supply without being limited by charging plugs or cables.

Then MEI is presented to extend the interconnection of power grid to the mobile domain. MEI could support wireless power supply to mobile terminals as similar as wireless information delivery in MI, so that people can

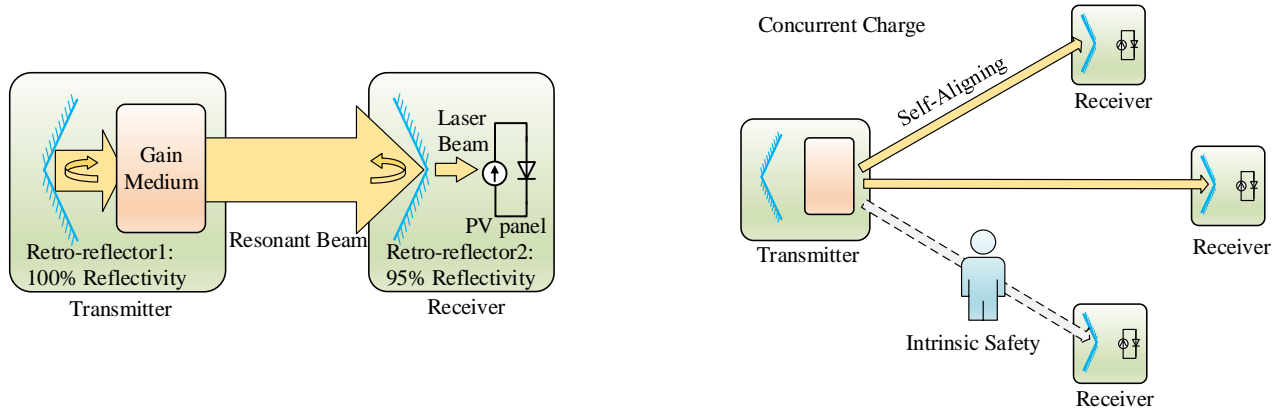

Figure 3. Resonant Beam Charging Principle and Features

get power as handily as information access. Therefore, MEI is a vital supplement of wireless power supply with mobility, which may lead to a high-level life freedom and enable another climax of innovation.

As shown in Fig. 2, the horizontal dimension represents the advent of mobility. Based on the wireless communication technologies, MI extends the Internet, which enables a breakthrough from wired to mobile region for information interconnection. Similarly, MEI extends power grid in mobile domain relying on WPT technologies, which enables mobile power supply. The vertical dimension illustrates the span from information to energy. Based on the Internet, smart grid realizes both information and power transfer. Furthermore, MEI can implement simultaneous wireless information and power transfer (SWIPT) on the basis of MI. On the one hand, energy transmission through radio waves or laser beams while wireless communicating is a part of the 6G vision; on the other hand, MEI will combine multiple WPT and wireless communication technologies to achieve SWIPT.

IV. SUPPORTING TECHNOLOGIES

WPT technologies are the foremost supporting technologies to realize MEI. Nikola Tesla invented the “Tesla coil” for the original wireless power transmission test one hundred years ago. In recent years, the development of wireless charging technologies has made great strides. WPT technologies which draw great attention in industry and academia include: inductive coupling, magnetic resonance, capacitive coupling, radio waves charging, ultrasonic charging, laser charging, etc. However, the above WPT technologies face the challenges of simultaneously satisfying mobility, high power, and safety requirements in MEI applications, especially for infrastructural network and UAV-based ad-hoc network. Thus, we will particularly introduce a promising resonant beam charging (RBC) technology, as known as distributed laser charging (DLC), which can safely transfer several watts of power over several meters is proposed by Wi-Charge [3].

A. Resonant Beam Charging

The RBC system uses the optical retro-reflector as the resonator mirror [4]. In contrast with the parallel mirror which can only feedback the beam vertical to the mirror, the retro-reflector ensures that the light beam entering

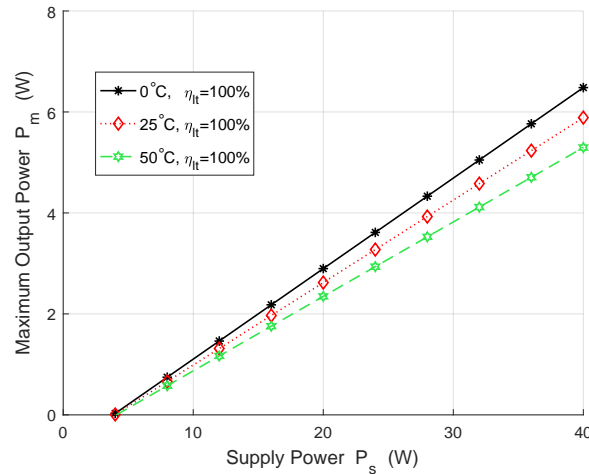

Figure 4. Maximum Output Power vs. Supply Power (ref. Fig. 23 in [5])

from a wide range of angles can be returned back to its incoming direction. In Fig. 3, the RBC system integrates a retro-reflector and a gain medium at the transmitter, while the other retro-reflector and a photoelectric converter are integrated at the receiver. The transmitter and the receiver jointly form a beam resonator. In this system, the beam reflected by the retro-reflector is folded back into the gain medium multiple times to be amplified. This process generates a resonant beam of stimulated radiation within the resonator (i.e., the transmitter and receiver). As a result, mobile devices integrated with the RBC receiver can be charged with the resonant beam transmitted through the internal retro-reflector.

In the RBC system, the alignment between the transmitter and the receiver is automatically generated [3]. Moreover, any foreign object that enters the line of sight, i.e., the beam cavity, will block the path of photons, disrupt positive feedback for resonance, and automatically shut off the resonant beam. Thus, the requirements of high-power transmission and safe charging can be guaranteed. Therefore, the salient features of RBC are safety and mobility. In addition, RBC also has the characteristics of long-range, high-power, self-aligning, concurrently-charging, and compact-size as specified in [4]. The receiver can be integrated into mobile devices, which leads to the feasibility for practical implementation.

A preliminary theoretical study on the end-to-end transmission efficiency of the RBC system is proposed in [5]. The RBC system is modularized as three theoretical parts: electricity-to-laser conversion model, laser transmission model and laser-to-electricity model. As a result, the end-to-end efficiency can be depicted through the efficiency analysis of the above three models. The electricity-to-laser efficiency lies on the capability of laser-photoelectric conversion which can attain about 45% with the 810nm laser. The laser transmission efficiency is affected by laser transmission attenuation, where air quality, wavelength and transmission distance are the impact factors. The single-diode equivalent circuit model for the photovoltaic panel (PV-panel) can illustrate the laser-to-electricity conversion mechanism. Based on the numerical analysis, the maximum laser-to-electricity conversion efficiency is up to 50%. For the scenarios considered in [5], the maximum output power P_m as a function of the supply power is depicted

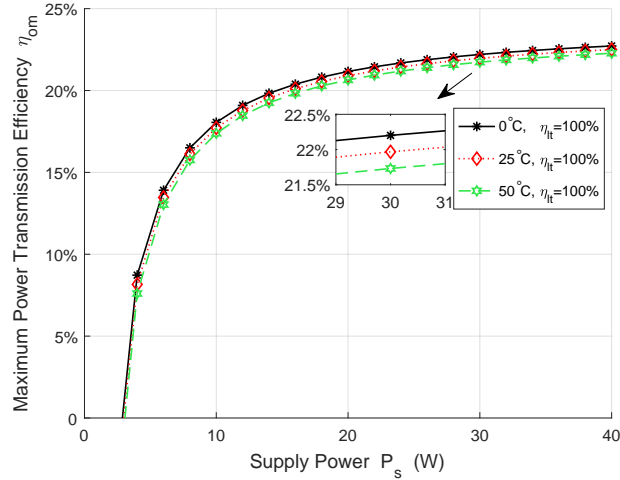

Figure 5. Maximum Power Transmission Efficiency vs. Supply Power (ref. Fig. 24 in [5])

in Fig. 4, and the end-to-end power transmission efficiency of the RBC system can be 15% to 25%, as shown in Fig. 5. η_{lt} represents the laser power transmission efficiency, and laser wavelength λ is 880nm.

The impacts on the end-to-end energy conversion efficiency η_{om} are also studied in [5]. Figure 6 shows the η_{om} as a function of transmission distance with different laser wavelength λ and PV-panel temperature when the supply power is 40W and the air is clear. The similar analysis with different air condition can be found in [5]. In summary, the impacts can be summarized as follows:

1) *Temperature*: When the temperature increases, the electricity-to-laser conversion efficiency, the laser transmission efficiency and the PV-panel conversion performance will all reduce. Thus, the heat dissipation is crucial to improve the power transmission efficiency.

2) *Laser wavelength*: Laser wavelength affects electricity-to-laser conversion efficiency due to laser characteristics. The detailed analysis is illustrated in [5].

3) *Material*: The gain medium materials of laser devices affect the electricity-to-laser conversion efficiency, while the material and structure of PV-panel are important impact factors on laser-to-electricity conversion efficiency. The PV-panel in the simulation has the photoelectric conversion efficiency up to 50%, while the recent research shows that the PV-panel can achieve more than 60% conversion efficiency [6].

4) *Distance and air quality*: Distance and air quality both have impacts on laser propagation attenuation. The increasing distance between transmitter and receiver as well as the bad air quality will reduce laser transmission efficiency. However, the RBC beam has low attenuation in a short distance. Relying on the analysis, the infrared beam transmission efficiency of the RBC system at a distance of 5 meters is almost 100% [7].

Besides, the adaptive resonant beam charging (ARBC) design is presented for adaptively controlling the transmitting power from the transmitter according to the charging requirement of the receiver to avoid power waste and accidental dangers [8]. Based on RBC, for better charging services, wireless power scheduling algorithm in terms of battery charging profile for fairly keeping all devices working as long as possible is proposed [9].

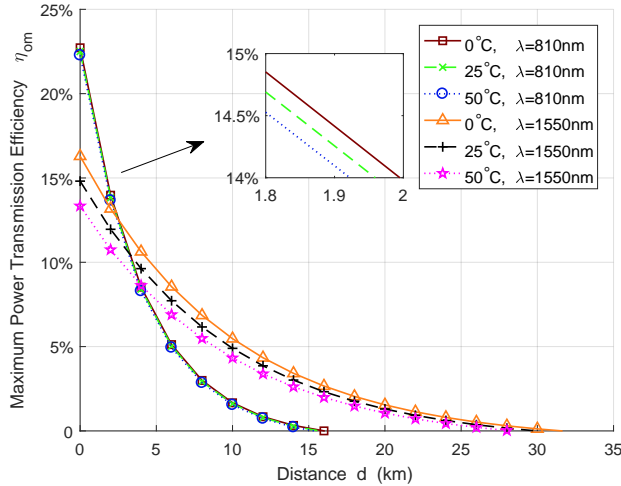

Figure 6. Maximum Power Transmission Efficiency vs. Distance (ref. Fig. 26 in [5])

Moreover, the scheduling algorithm for earning maximization with quality of charging service guarantee [10], and the TDMA-based WPT scheduling algorithm for efficient WPT in ARBC [11] are put forth. These efforts are to drive the progress and implementation of MEI's wireless charging services.

B. WPT Technology Comparison

The MEI architecture requires not only far-field wireless charging technologies but also near-field wireless charging technologies for their respective application scenarios. For example, magnetic inductive coupling and magnetic resonance technology can be applied in the MEI infrastructural network to supply power for home appliances and electric vehicles. Laser charging, radio waves or ultrasonic charging may be used in the MEI powered WSNs. Based on the comparison of these WPT technologies, we can find that RBC is the suitable technology for mobile applications.

The comparison of several WPT technologies which are attracting attention from both academia and industry has been summarized in [4]. Magnetic inductive coupling which is the mature and widely used technology, enables the wireless power delivery through magnetic field induction established between two coils [12]. The focus of magnetic resonance technology lies in that the two coils in the magnetic field have the same vibration frequency, and power transmission realizes through resonance effect [13]. The capacitive coupling method does not use coils, but sets electrodes at the power transmitting and receiving ends, and uses the electric field generated between the two to supply power [14]. The above WPT technologies can only convey wireless power up to several centimeters. Thus, they belong to the near-field WPT. Near-field WPT technologies are generally safe for humans while the charging distance and tight alignment are the defects restricting mobility.

For far-field WPT, the methods of transferring power from power hubs to receiving devices are more diverse. Radio waves can achieve tens of meters transmission distance [12]. However, the radiative power of radio waves (RF) is limited by the Federal Commissions Committee for safety regulations. Commercial RF charging systems can only provide the power in the order of micro-watts to milliwatts over several meters. Besides, uBeam used

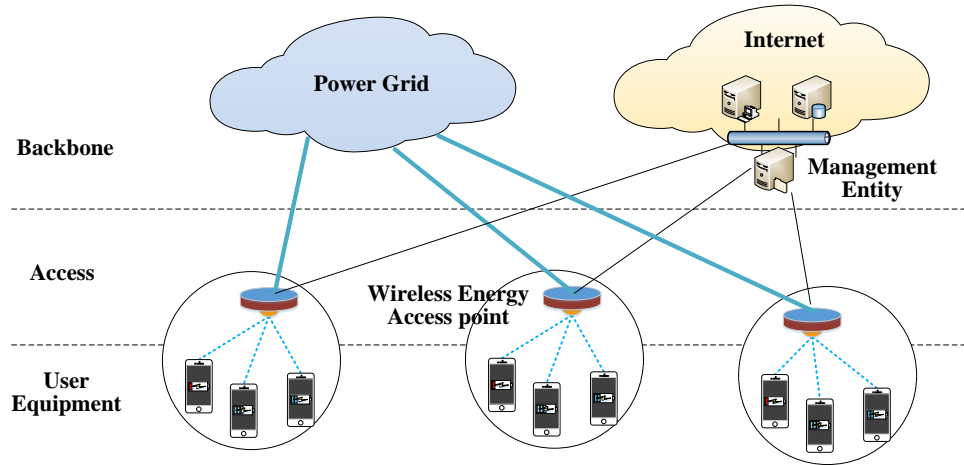

Figure 7. MEI Network Architecture

ultrasonic waves to transmit power to 15 feet (about 4.6 meters) away [15], and Lockheed Martin charged the drone through a laser system. However, they are also difficult to realize the high-power energy transfer with safety.

V. MOBILE ENERGY INTERNET ARCHITECTURE

Based on RBC, we design the mobile energy internet (MEI) architecture to provide wide-area mobile charging services. As the RBC transmitters can be equipped not only in indoor situations, but also in street lights or base stations, mobile devices can be charged anywhere and anytime based on the MEI infrastructure. Relying on the features of RBC technology, one transmitter can charge several receivers at the same time, while one receiver can be served by several transmitters. Thus, the control functions such as access control, scheduling control and mobility management will be provided by the MEI.

In Fig. 7, the MEI architecture is separated into two layers: access layer and backbone layer. The access layer takes charge of wireless power transfer for user equipment. Moreover, the entities in access layer should assist access control, scheduling control, and energy channel switching. In the backbone layer, wireless energy access points are connected to the power grid to get source power. Furthermore, to realize mobile power transfer anywhere and anytime, the Internet access is of great significance to provide access control, resource allocation, and authentication, authorization, accounting (AAA) services.

User equipment can get wireless power through the wireless energy access points in the access layer, and information exchange can be realized through wireless communication technologies. The major components in the network are as follows:

1) *User Equipment*: User equipments (UEs) are the devices such as smart phones which require mobile charging services and access to MEI. UE can convert the beam power transmitted by the built-in RBC transmitter to electrical power, so that UE can be charged wirelessly. In addition, UE should be able to access the wireless energy access point and realize information exchange with the management entity to get mobile charging services.

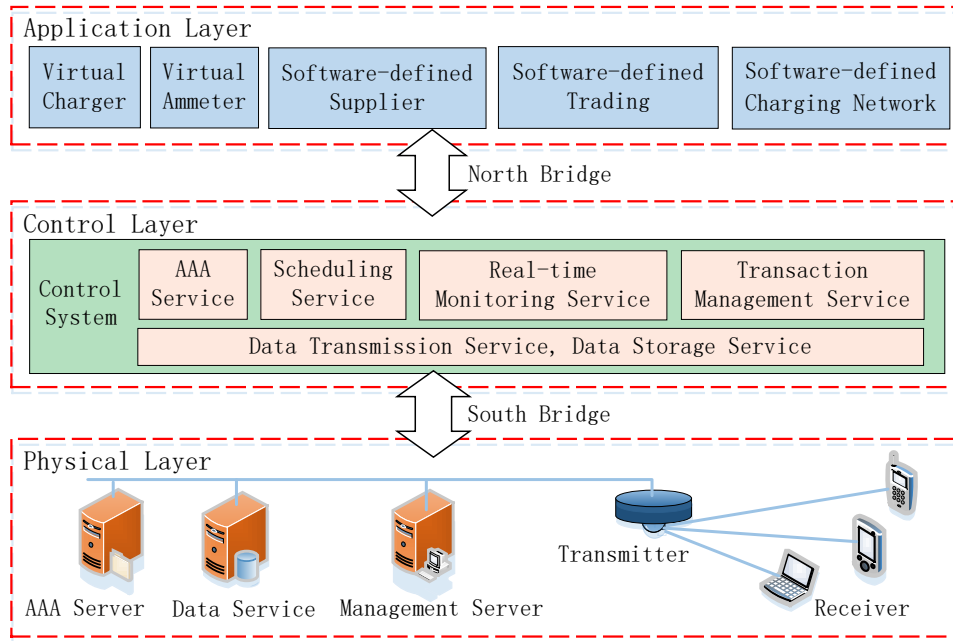

Figure 8. Software-defined MEI

2) *Wireless Energy Access Point:* Wireless energy access point (WEAP) provides wireless RBC power for receivers. It connects to the fixed power grid for the source power and accesses to the Internet for power transfer managements. WEAP assists UE accessing and ensure the mobile charging quality. It also assists resource scheduling of MEI. According to the signaling from the management entity, WEAP relies on the power controller to determine the power allocation in a multi-user scenario. Moreover, WEAP is responsible for switching energy transfer channel when UE moves from a WEAP charging area to another like handover in MI.

3) *Management Entity:* It is responsible for processing the information such as transaction data, real-time status and resource management in the network, in order to provide the best decision for power transmission, access control, and resource allocation. It contains the functions of authentication, authorization, accounting (AAA) and location-based service (LBS) for mobility management. Furthermore, it takes charge of handover control for wide-area coverage. It also provides the application interfaces for value-added enhancement.

Software-defined MEI system which logically implements centralized control of physical devices by establishing standard interfaces is depicted in Fig. 8. North bridge defines the interaction interface between the control layer and the application layer, and the south bridge defines the interaction interface between the control layer and the physical layer. The physical layer includes various types of servers, RBC transmitters, and RBC receivers. The control layer is a standardized control system that provides the basic services, such as AAA, scheduling, and real-time monitoring.

At the application layer, the virtual charger enables seamless switching between the two adjacent transmitters, allowing the user to experience a smooth charging as if they were always connected to the same wireless charging transmitter. The virtual ammeter provides users with power statistics, power display, and power billing. Software-

defined suppliers can distribute the deployment and operation of equipment in the MEI to multiple companies, i.e., to achieve the separation of platform management and equipment maintenance to improve management efficiency. Software-defined trading is the implementation of power trading between users and different operating companies. The software-defined charging network implements centralized control of various physical devices in the MEI, and performs device configuration and firmware upgrades.

VI. FEATURES AND OPPORTUNITIES

The wireless charging networks relying on near-field WPT technologies can only be deployed in a small area with limited mobility and safety. The concept of MEI, which is based on RBC as enabling technology, can highlight the characteristics of mobility and safety. In addition to the advantages of the RBC system mentioned earlier, the main features of MEI can be summarized as follows:

1) *Mobility*: RBC architecture relies on the distributed laser resonator (consisting of two retro-reflectors and the gain medium) to generate a resonating beam without the assistance of specific aiming or tracking [4]. Thus, the resonating beam can be self-aligned when one receiver changes its position, so that mobile terminals can still be charged while moving. On the other hand, MEI expands the power transfer over distance, so that users can have a mobile WiFi-like experience to obtain wireless charging services with mobility.

2) *Safety*: When encountering an obstruction within the resonating beam path in the RBC system, the resonance ceases at the speed of light since the photons are blocked by the obstacle. Thus, the energy transfer is curtailed immediately without any software or decision-making circuitry involvement, which can ensure the coexistence of high power and safety. With the unique features of the RBC system, MEI can achieve a good balance between power and safety.

3) *High-Power*: Mobile devices can be charged with the high-power near-field WPT technologies such as inductive coupling charging in MEI. On the other hand, as the mobility-enabling technology, RBC can provide Watt-level power over meter-level distance with the premise of safety. The high-power WPT technologies are sufficient for charging mobile devices like smartphones. Thus, MEI is a high-power network which can support mobile power supply in various high-power charging scenarios.

In summary, MEI will bring convenience with enhanced charging experiences to human life in various aspects, such as medical treatment and smart homes. It breaks the development bottlenecks as dealing with the power supply problems for mobile devices, IoT devices, and UAVs. The simultaneous optical wireless information and power transfer (OWIPT) can be promoted with MEI. More importantly, MEI will motivate new ideas to find solutions and new possibilities for a more imaginative world. New business models will be built and new lifestyles will be created. Furthermore, MEI is undoubtedly consistent with environmental protection and contributes to clean energy substitution.

VII. CHALLENGES AND OPEN ISSUES

There still exist several challenges in developing MEI. Here are some concerns:

1) *Safety*: Safety is still a big focus since the laser hazard is hard to be avoided in some unforeseen circumstances. Thus, we still need further study the safety of RBC system under various situations.

2) *Efficiency*: Based on the analysis in the context, the end-to-end efficiency of the RBC system has not optimized. There is considerable potential to improve the transmitter's electric-photo conversion efficiency and the PV's photoelectric conversion efficiency. It's necessary to choose the most appropriate scheme which can balance both the conversion efficiency and the transmission efficiency, and design a better heat sink, in order to enhance the end-to-end efficiency. Moreover, the efficiency may be affected in a multi-user scenario when the transmitting power cannot meet the requirements of all users. The user numbers as well as the network topologies have effects on the MEI network efficiency. Therefore, algorithms and control methods should be designed to maintain the network efficiency in such scenarios.

3) *Distance*: The output power and transmission distance of RBC technology are still need to be improved, which hinders the development and application of MEI. More researches on higher output power and longer charging distance should be done so that MEI can apply to various application scenarios.

4) *Network Topology*: So far we only considered basic MEI network architecture since the power transmission efficiency restricts the application of multi-hop networks. However, the qualitative and quantitative density analysis of multi-hop networks as well as control algorithms is worthy of further research.

5) *Standardization*: Enterprises are prone to separating into different standard camps such as Qi, power matters alliance (PMA), and alliance for wireless power (A4WP) for technical research and product development. These standards are difficult to meet or integrate into the MEI system, which is the challenge for MEI's popularization.

VIII. CONCLUSIONS

Driven by the demand of solving power hungry problem for mobile and IoT devices, we propose the mobile energy internet (MEI) based on wireless power transfer (WPT) technologies. We at first illustrate an MEI application scenario and show its practical applications in the mobile realm. We then emphasize on the promising resonant beam charging (RBC) technology and compare the various WPT technologies. Furthermore, we provide the RBC end-to-end energy conversion efficiency and analyze its impact factors. In addition, we present the MEI architecture consisting of access layer and backbone layer. We then put forth the software-defined MEI. Thereafter, the feasibility of MEI to provide mobile charging services can be drawn. Finally, we analyze the features of MEI and discuss the challenges and open issues of future work. MEI is extended from the fixed power grid to mobile power network region, which may play the significant role as MI in information technology.

REFERENCES

- [1] K. David and H. Berndt, "6G vision and requirements: Is there any need for beyond 5G?" *IEEE Vehicular Technology Magazine*, vol. 13, no. 3, pp. 72–80, Sept 2018.
- [2] Z. Dong, J. Zhao, F. Wen, Y. Xue, and Z. University, "From smart grid to energy internet: basic concept and research framework," *Automation of Electric Power Systems*, vol. 38, no. 15, pp. 1–11, 2014.

- [3] O. R. Mor, O. Alpert, A. Slepoy, L. Golan, R. Sagi, V. Shmukler, E. Ronen, O. Nahmias, and V. Vaisleib, "System for optical wireless power supply," Patent 9742223, Aug, 2017. [Online]. Available: <http://www.freepatentsonline.com/9742223.html>
- [4] Q. Liu, J. Wu, P. Xia, S. Zhao, W. Chen, Y. Yang, and L. Hanzo, "Charging unplugged: Will distributed laser charging for mobile wireless power transfer work?" *IEEE Vehicular Technology Magazine*, vol. 11, no. 4, pp. 36–45, 2016.
- [5] Q. Zhang, W. Fang, Q. Liu, J. Wu, P. Xia, and L. Yang, "Distributed laser charging: A wireless power transfer approach," *IEEE Internet Things J.*, to appear, 2018, doi: 10.1109/JIOT.2018.2851070.
- [6] P. Crump, G. Erbert, H. Wenzel, C. Frevert, C. M. Schultz, K. Hasler, R. Staske, B. Sumpf, A. Maadorf, F. Bugge, S. Knigge, and G. Trnkle, "Efficient high-power laser diodes," *IEEE Journal of Selected Topics in Quantum Electronics*, vol. 19, no. 4, pp. 1501211–1501211, 2013.
- [7] Wi-charge, "Absorption in air and wireless charging," [Online]. Available: <http://www.wi-charge.com/blogpost/absorption-in-air-and-wireless-charging/>, Apr. 2018.
- [8] Q. Zhang, X. Shi, Q. Liu, J. Wu, P. Xia, and Y. Liao, "Adaptive distributed laser charging for efficient wireless power transfer," in *IEEE Vehicular Technology Conference*, Sept. 2017, pp. 1–5.
- [9] W. Fang, Q. Zhang, Q. Liu, J. Wu, and P. Xia, "Fair scheduling in resonant beam charging for IoT devices," *IEEE Internet Things J.*, to appear, 2018, doi: 10.1109/JIOT.2018.2853546.
- [10] W. Fang, Q. Zhang, M. Liu, Q. Liu, and P. Xia, "Earning maximization with quality of charging service guarantee for IoT devices," *IEEE Internet of Things Journal*, to appear, 2018, doi: 10.1109/JIOT.2018.2868226.
- [11] M. Xiong, M. Liu, Q. Zhang, Q. Liu, J. Wu, and P. Xia, "TDMA in adaptive resonant beam charging for IoT devices," *IEEE Internet of Things Journal*, to appear, 2018, doi: 10.1109/JIOT.2018.2863232.
- [12] X. Lu, P. Wang, D. Niyato, D. I. Kim, and Z. Han, "Wireless charging technologies: Fundamentals, standards, and network applications," *IEEE Commun. Surveys Tuts.*, vol. 18, no. 2, pp. 1413–1452, 2016.
- [13] T. Imura and Y. Hori, "Unified theory of electromagnetic induction and magnetic resonant coupling," *Ieej Transactions on Industry Applications*, vol. 135, no. 6, pp. 697–710, 2017.
- [14] M. Kline, I. Izyumin, B. Boser, and S. Sanders, "Capacitive power transfer for contactless charging," in *Applied Power Electronics Conference and Exposition*, 2011, pp. 1398–1404.
- [15] J. Constine, "uBeam finally reveals the secret of how its wireless charging phone case works safely," [Online]. Available: <https://techcrunch.com/2015/10/08/how-ubeam-works/>, Oct. 2015.