

A brief survey on singularities of geodesic flows in smooth signature changing metrics on 2-surfaces

N.G. Pavlova* and A.O. Remizov†

October 10, 2018

Abstract

We present a survey on generic singularities of geodesic flows in smooth signature changing metrics (often called pseudo-Riemannian) in dimension 2. Generically, a pseudo-Riemannian metric on a 2-manifold S changes its signature (degenerates) along a curve S_0 , which locally separates S into a Riemannian (R) and a Lorentzian (L) domain. The geodesic flow does not have singularities over R and L , and for any point $q \in R \cup L$ and every tangential direction $p \in \mathbb{R}\mathbb{P}$ there exists a unique geodesic passing through the point q with the direction p . On the contrary, geodesics cannot pass through a point $q \in S_0$ in arbitrary tangential directions, but only in some admissible directions; the number of admissible directions is 1 or 2 or 3. We study this phenomenon and the local properties of geodesics near $q \in S_0$.

1 Introduction

Let S be a real smooth manifold, $\dim S = n \geq 2$. By *metric* on S we mean a symmetrical covariant tensor field of the second order on the tangent bundle TS , not necessary positive defined. Moreover, metrics whose signature has different signs at different points of S , are of the special interest. For instance, in the quantum theory of gravitation and general relativity two types of signature changing metrics are considered:

*Department of Nonlinear Analysis and Optimization, RUDN University (Moscow, Russia). Email: natasharussia@mail.ru.

†CMAP École Polytechnique (Palaiseau, France), CNRS. Email: alexey-remizov@yandex.ru.
2010 Mathematics Subject classification 53C22, 53B30, 34C05.

Key Words and Phrases. Pseudo-Riemannian metrics, Geodesics, Singular points, Normal forms.

- **Smooth.** The metric is degenerate on a hypersurface $S_0 \subset S$ that divides the *Riemannian* region $R \subset S$ with signature $(+\cdots+)$ from the *Lorentzian* region $L \subset S$ with signature $(+\cdots-)$. Example: $ds^2 = dx_1^2 + \cdots + dx_{n-1}^2 + x_n dx_n^2$.
- **Discontinuous.** The metric is smooth and non-degenerate everywhere except for a hypersurface $S_0 \subset S$ (which separates R and L defined as above), where it fails to be continuous. Example: $ds^2 = dx_1^2 + \cdots + dx_{n-1}^2 + \frac{1}{x_n} dx_n^2$.

In the paper [27], Russian physicist A.D. Sakharov conjectured there exist states of the physical continuum which include regions with different signatures of the metric; the observed Universe and an infinite number of other Universes arose as a result of quantum transitions with a change in the signature of the metric. This concept is exemplified by Fig. 1.

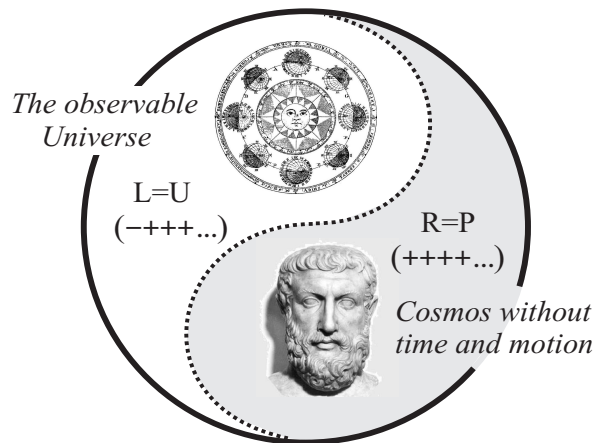

Figure 1: Sakharov's cosmological model. Here the region L (which apparently includes the observable Universe) is denoted by U and the region R (cosmos without time and motion) is denoted by P (after Parmenides, a Greek philosopher theorized about space and time). The hypersurface S_0 is represented by the dotted line.

In his cosmological model, Sakharov used discontinuous metrics. However, some other authors consider models with smooth signature changing metrics; see e.g. [1, 17, 18, 19] and the references therein. From physical viewpoint, the difference between smooth and discontinuous signature changing metrics corresponds to different physical proposals, in particular, different solutions of the Einstein equation. *Euclidean-Lorentzian transitions* (junctions) between the domains R and L play an important role, both in the smooth and discontinuous models. The term *Euclidean* is used in sense of *Riemannian*, that is typical for physical literature, see e.g. [2]. Similarly, the term *Lorentzian* is referred to non-degenerate indefinite metrics.

In this paper, we discuss a purely mathematical problem connected with smooth signature changing metrics (further called *pseudo-Riemannian*): the local behavior of

geodesics in a neighborhood of the points where the metric has a generic degeneracy. Such points are singular points of the geodesic flow, and the standard existence and uniqueness theorem for ordinary differential equations is not applicable. This leads to an interesting geometric phenomenon: geodesics cannot pass through a degenerate point in arbitrary tangential directions, but only in certain directions said to be *admissible*.

A study of this phenomenon for two-dimensional pseudo-Riemannian metrics is started in [13, 24, 25, 26]; similar results in three-dimensional case were announced in [22]. In these works, mainly the local properties of geodesics and geodesic flows were considered, some global properties of geodesics of pseudo-Riemannian metrics with differentiable groups of symmetries are investigated in [25]. This allows, in particular, to obtain the phase portraits of geodesics on surfaces of revolution (sphere, torus, etc.) embedded in three-dimensional Minkowski space.

Various other aspects of pseudo-Riemannian metrics (including the Gauss–Bonnet formula) are treated by many authors, see e.g. [12, 16, 18, 19, 20, 21, 28] and the references therein. However, there exist a number of unsolved problem connected with degeneracy of metrics. According to our knowledge, the problem of local geodesic equivalence of pseudo-Riemannian metrics at degenerate points is not studied yet, although it is well studied for Riemannian and Lorentzian metrics, see e.g. [7] (in this paper, the authors call *pseudo-Riemannian* what we call *Lorentzian*, i.e., non-degenerate indefinite metrics).

From now we always assume that $\dim S = 2$.

Similarly, just as Riemannian metrics naturally appear on surfaces embedded in Euclidean space, pseudo-Riemannian metrics can be generated in pseudo-Euclidean space. Let S be a smooth surface embedded in 3D Minkowski space (X, Y, Z) with the pseudo-Euclidean metric $dX^2 + dY^2 - dZ^2$. Then the pseudo-Euclidean metric in the ambient (X, Y, Z) -space induced a pseudo-Riemannian metric on S . For instance, let S be the standard Euclidean sphere

$$X^2 + Y^2 + Z^2 = 1.$$

The metric induced on the sphere S degenerates on two parallels $Z = \pm 1/\sqrt{2}$, which separate S into three regions, where the metric has constant signatures. The North ($Z > 1/\sqrt{2}$) and the South ($Z < -1/\sqrt{2}$) regions are Riemannian, while the equatorial region $|Z| < 1/\sqrt{2}$ is Lorentzian; see Fig. 2 (left). The condition of the point $q \in S$ belonging to R or S_0 or L depends on the mutual relationships between the tangent plane $T_q S$ and the *isotropic (light) cone*

$$dX^2 + dY^2 - dZ^2 = 0;$$

see Fig. 2 (right).

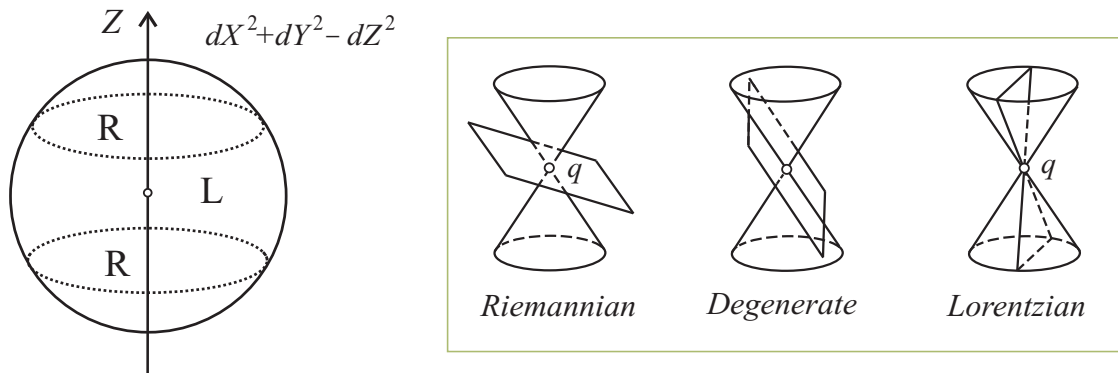

Figure 2: On the left: pseudo-Riemannian metric on the sphere $X^2 + Y^2 + Z^2 = 1$ in 3D Minkowski space. Here S_0 consists of two parallels $Z = \pm 1/\sqrt{2}$ depicted as dotted lines. On the right: intersections of the light cone with the tangent plane $T_q S$, $q \in S$.

2 Definition of geodesics

Consider a two-dimensional manifold (surface) S with pseudo-Riemannian metric

$$ds^2 = a(x, y) dx^2 + 2b(x, y) dx dy + c(x, y) dy^2, \quad (1)$$

whose coefficients are smooth (i.e., C^∞). Geodesics in the metric (1) can be defined via variational principles similarly to the Riemannian case, with additional nuances.

For instance, the arc-length parametrization is not defined for the *isotropic lines* (or *lightlike lines* or *null curves*). Moreover, the Lagrangian of the length functional

$$J_l(\gamma) = \int_{\gamma} \sqrt{a\dot{x}^2 + 2b\dot{x}\dot{y} + c\dot{y}^2} dt \rightarrow \text{extr},$$

where the dot means differentiation by the parameter t , fails to be differentiable on the *isotropic surface* \mathcal{F}

$$a(x, y) dx^2 + 2b(x, y) dx dy + c(x, y) dy^2 = 0, \quad (2)$$

and the Euler–Lagrangian equation for the length functional is not defined on \mathcal{F} . Note that equation (2) defines the isotropic surface \mathcal{F} in the complement of the zero section of TS or, equivalently, in the projectivized tangent bundle PTS .

Binary differential equation (2) defines a direction field on \mathcal{F} , whose integral curves correspond to isotropic lines in the metric (1). This equation plays an important role for understanding the behavior of geodesics, and we consider it in more detail below.

As already mentioned above, the Euler–Lagrangian equation for the length functional J_l does not allow to define extremals on \mathcal{F} . However, this problem does not

arise if we define geodesics as extremals of the action functional

$$J_a(\gamma) = \int_{\gamma} (a\dot{x}^2 + 2b\dot{x}\dot{y} + c\dot{y}^2) dt \rightarrow \text{extr.}$$

The corresponding Euler–Lagrange reads

$$\begin{cases} 2(a\ddot{x} + b\ddot{y}) = (c_x - 2b_y)\dot{y}^2 - 2a_y\dot{x}\dot{y} - a_x\dot{x}^2, \\ 2(b\ddot{x} + c\ddot{y}) = (a_y - 2b_x)\dot{x}^2 - 2c_x\dot{x}\dot{y} - c_y\dot{y}^2, \end{cases} \quad (3)$$

and the corresponding parametrization is called *natural* or *canonical*. Obviously, the definition of geodesics as auto-parallel curves in the Levi–Civita connection generated by the metric (1) leads to the same Equation (3).

The natural parametrization is well defined for all types of geodesics, including isotropic. For non-isotropic geodesics it coincides with the arc-length (of course, here the length to be real or imaginary). The functionals J_l (length) and J_a (action) define the corresponding fields of extremals: χ_l on PTS away of \mathcal{F} and χ_a on the complement of the zero section of TS (including \mathcal{F}). The relationship between the fields χ_l and χ_a is as follows (see also Fig. 3).

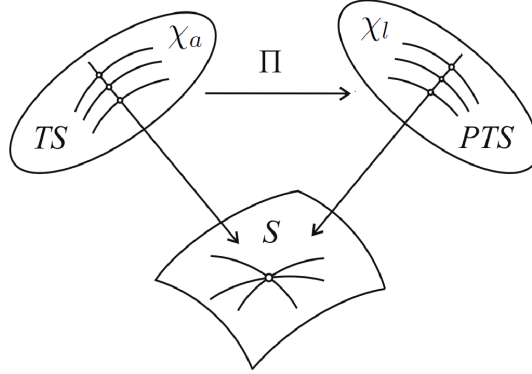

Figure 3: The relationship between the fields χ_l and χ_a . The horizontal arrow means the projectivization $\Pi: TS \rightarrow PTS$. Two lower arrows are the standard projections $TS \rightarrow S$ and $PTS \rightarrow S$.

The natural projectivization $\Pi: TS \rightarrow PTS$ sends the field χ_a to a direction field on PTS , which is parallel to the vector field

$$\vec{V} = 2\Delta \left(\frac{\partial}{\partial x} + p \frac{\partial}{\partial y} \right) + M \frac{\partial}{\partial p}, \quad p = \frac{dy}{dx}, \quad (4)$$

where

$$\Delta(x, y) = ac - b^2, \quad M(x, y, p) = \sum_{i=0}^3 \mu_i(x, y) p^i,$$

with the coefficients

$$\begin{aligned}
\mu_0 &= a(a_y - 2b_x) + a_x b, \\
\mu_1 &= b(3a_y - 2b_x) + a_x c - 2ac_x, \\
\mu_2 &= b(2b_y - 3c_x) + 2a_y c - ac_y, \\
\mu_3 &= c(2b_y - c_x) - bc_y.
\end{aligned} \tag{5}$$

The vector field \vec{V} given by (4) is defined and smooth at all points of PTS including the isotropic surface \mathcal{F} . It is worth observing that the direction field χ_l is parallel to (4) at all points where χ_l is defined, i.e., at all points away from the surface \mathcal{F} . One can interpret the direction field given by (4) as a natural extension of χ_l to \mathcal{F} . This brings us to the following definition: the projections of integral curves of the field (4) from PTS to S distinguished from a point are *non-parametrized geodesics* in the pseudo-Riemannian metric (1).

Moreover, let \vec{W} be the vector field on PTS (determined uniquely up to multiplication by a non-vanishing scalar factor) that corresponds to the length functional J_l . Since the length functional is invariant with respect to reparametrizations, one can put $t = x$ and take as \vec{W} the vector field corresponding to the Euler–Lagrange equation with the Lagrangian \sqrt{F} , where $F(x, y, p) = a(x, y) + 2b(x, y)p + c(x, y)p^2$. A straightforward calculation (see [25]) shows that

$$\vec{W} = \frac{1}{2F^{\frac{3}{2}}} \vec{V} \quad \text{and} \quad \text{div } \vec{W} = 0 \quad \text{at all points where } F \neq 0. \tag{6}$$

The field \vec{W} is divergence-free, since it comes directly from an Euler–Lagrange equation, while \vec{V} is not, since it is obtained via an additional procedure, the projectivization $\Pi: TS \rightarrow PTS$. The property (6) plays an important role, due to the following general fact:

Theorem 1 ([13]) *Let $\vec{V}(\xi)$, $\xi \in \mathbb{R}^n$, be a smooth vector field, $f(\xi)$ be a smooth scalar function such that the hypersurface $\mathcal{F} = \{\xi : f(\xi) = 0\}$ is regular, r be a positive real number. Suppose that the field $\vec{W}(\xi) = f^{-r}(\xi)\vec{V}(\xi)$ is divergence-free at all points where it is defined, i.e., at all points $\xi \notin \mathcal{F}$. Then \mathcal{F} is an invariant hypersurface of the field \vec{V} . Moreover, let $\xi_* \in \mathcal{F}$ be a singular point of \vec{V} and $\lambda_1, \dots, \lambda_n$ be the eigenvalues of the linearization of \vec{V} at ξ_* . Then $\lambda_1 + \dots + \lambda_n = r\lambda_j$ for at least one j .*

By Theorem 1, we have the following assertions:

- The isotropic surface \mathcal{F} is an invariant surface of the field (4) and all isotropic lines are geodesics (with identically zero length).¹
- Geodesics do not change their type (timelike, spacelike, isotropic) away of degenerate points. This statement follows from the previous one.

¹ The first assertion is valid for any $\dim S \geq 2$, while the second assertion (about isotropic lines) is valid for $\dim S = 2$ only. Indeed, in the case $\dim S > 2$ there exist isotropic lines that are not geodesics; see the example in [25].

3 Equation of isotropic lines

Suppose that set

$$S_0 = \{q = (x, y) \in S : \Delta(x, y) = 0\}$$

is a regular curve. It is called the *degenerate* or *discriminant* curve of the metric (1), and points $q \in S_0$ are called *degenerate points* of the metric. Then the coefficients a, b, c do not vanish simultaneously, and the isotropic direction

$$p_0(q) = -\frac{a}{b}(q) = -\frac{b}{c}(q), \quad q \in S_0, \quad (7)$$

is defined and unique at every point $q \in S_0$.

The projectivization $\Pi: TS \rightarrow PTS$ transforms binary differential equation (2) into the implicit differential equation

$$F(x, y, p) = 0, \quad \text{where} \quad F = a(x, y) + 2b(x, y)p + c(x, y)p^2. \quad (8)$$

In the space PTS , the surface \mathcal{F} composes a two-sheeted covering of the Lorentzian domain of S ($\Delta < 0$) with branching along the discriminant curve S_0 . Over the Riemannian domain ($\Delta > 0$), the surface \mathcal{F} does not pass. See Fig. 4.

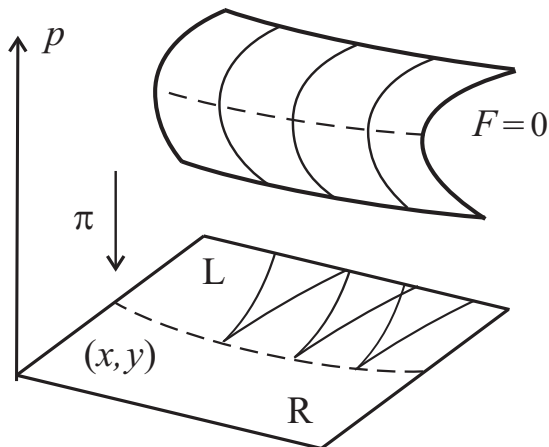

Figure 4: The isotropic surface \mathcal{F} in PTS , integral curves of the field X (top) and integral curves of the equation $F(x, y, p) = 0$ (down). The dashed lines represent the discriminant (top) and the discriminant curve (down).

A well-known geometrical approach to study implicit equation (8) consists of the lift the multivalued direction field on S to a single-valued direction field X on the surface \mathcal{F} .² The field X is an intersection of the contact planes $dy = pdx$ with the

² This approach is applicable to implicit differential equations $F(x, y, p) = 0$ with a smooth function F not necessarily quadratic in p . The idea goes back to H. Poincaré and A. Clebsch, see [23] for details.

tangent planes to the surface \mathcal{F} , that is, X is defined by the vector field

$$\dot{x} = F_p, \quad \dot{y} = pF_p, \quad \dot{p} = -(F_x + pF_y), \quad (9)$$

whose integral curves become isotropic lines of the metric (1) after the projection $\pi : \mathcal{F} \rightarrow S$ along the p -direction. Further we shall call this direction *vertical* in the space PTS . The locus of the projection $\pi : \mathcal{F} \rightarrow S$ (given by the equations $F = F_p = 0$) is called the *criminant* of equation (8). It is not hard to see that the criminant consists of the points $(q, p_0(q))$, $q \in S_0$ (see formula (7)).

Since \mathcal{F} is an invariant surface of the field (4) and both fields (4) and (9) are tangent to the contact planes $dy = p dx$, the restriction of (4) to the invariant surface \mathcal{F} is parallel to (9). Moreover, the restriction of the field (4) to \mathcal{F} is equal to the field (9) multiplied by a smooth scalar function vanishing along the criminant (see [13]). Generically, here there are two possible cases:

- The case *C*: the isotropic direction $p_0(q)$ is transversal to S_0 . Then the field (9) at the point $(q, p_0(q))$, $q \in S_0$, is non-singular, and binary equation (2) has *Cibrario normal form* $dx^2 = y dy^2$. See Fig. 5 (left).
- The case *D*: the isotropic direction $p_0(q)$ is tangent to S_0 . The field (9) at $(q, p_0(q))$, $q \in S_0$, has a non-degenerate singular point: saddle or node or focus (subcases D_s, D_n, D_f , respectively). Under certain additional conditions (formulated below), binary equation (2) has *Dara–Davydov normal form*

$$dy^2 = (y - \varepsilon x^2) dx^2, \quad (10)$$

where $\varepsilon < 0$ (if saddle) or $0 < \varepsilon < \frac{1}{16}$ (if node) or $\varepsilon > \frac{1}{16}$ (if focus). See Fig. 5.

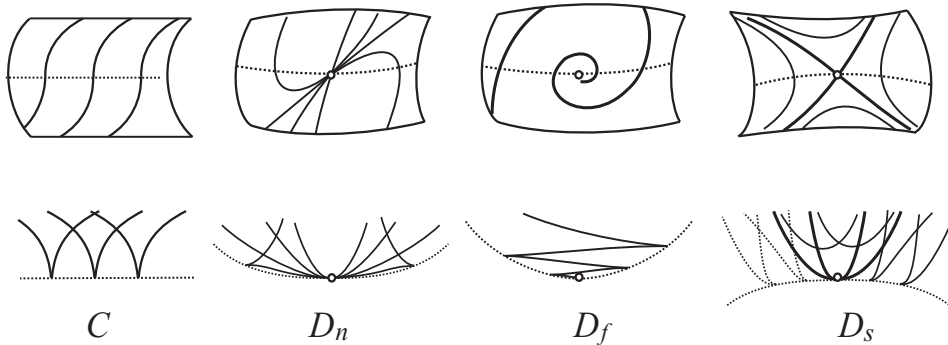

Figure 5: From the top to the bottom: integral curves of the field (9) on the isotropic surface \mathcal{F} and isotropic lines, obtained by the the projection $\pi : \mathcal{F} \rightarrow S$. The dashed lines represent the criminant (top) and the discriminant curve (down).

The normal form $dx^2 = y dy^2$ is named after Italian mathematician Maria Cibrario who established it first in C^ω (real analytic) category when studying second-order linear partial differential equations of the mixed type [8]. Later on, a general (and rather simple) proof of the Cibrario normal form (in C^ω and C^∞ categories) was presented in the famous Arnold's book [4].

The normal form (10) was firstly conjectured by Brazilian mathematician Lak Dara [9] and then proved by A.A. Davydov [10] under the following genericity conditions. Let $\alpha_{1,2}$ be the eigenvalues of the linearization of the vector field (9) at the singular point considered. Then $\alpha_{1,2}$ are roots of the characteristic equation $\alpha^2 - \alpha + 4\varepsilon = 0$, and the excluded values $\varepsilon = 0$ and $\varepsilon = \frac{1}{16}$ correspond to a degenerate singular point (saddle-node or degenerate node, respectively). The additional conditions required for the normal form (10) are the following.

First, the ratio of $\alpha_{1,2}$ is different from ± 1 , and the eigendirections are not tangent to the discriminant. Second, the germ of the vector field (9) is C^∞ -linearizable, i.e., it is C^∞ -smoothly equivalent to its linear part. The C^∞ -linearizability condition holds true, for instance, if between the eigenvalues $\alpha_{1,2}$ there are no resonant relations $\alpha_i = n_1\alpha_1 + n_2\alpha_2$ with integers $n_{1,2} \geq 0$, $n_1 + n_2 \geq 2$ (Sternberg-Chen Theorem, see e.g., [5, 14]). The proof presented in [10] is done in C^∞ category, but is valid in C^ω as well (the requirement of C^∞ -linearizability should be replaced with C^ω -linearizability), see also the recent paper [6].

4 Singular points of the geodesic flow

In addition to the isotropic surface \mathcal{F} , the vector field \vec{V} given by (4) has one more evident invariant surface – the *vertical* surface

$$\bar{S}_0 = \{(q, p) \mid q = (x, y) \in S_0, \ p \in \mathbb{RP}\}.$$

The restriction of the field (4) to \bar{S}_0 is vertical at almost all points (except for the points where $M = 0$, and the field vanishes). Hence the surface \bar{S}_0 is filled with vertical integral curves of the field (4) and its singular points.

Singular points of the field (4) are given by two equations:

$$\Delta(x, y) = 0 \quad \text{and} \quad M(x, y, p) = 0, \tag{11}$$

and consequently, they are not isolated, but form a curve (or curves) in *PTS*. Algebraically, this property can be expressed in the following form: all components of the vector field (4) belong to the ideal I (in the ring of smooth functions) generated by two of them, namely, $I = \langle \Delta, M \rangle$.

Remark 1 The fact that the *horizontal* generator $\Delta(x, y)$ of the field (4) does not depend on p and the *vertical* generator $M(x, y, p)$ is a cubic polynomial in p , plays a

crucial role in a general geometrical context, e.g., in the framework of Cartan's theory of the projective connection [3, 4].

Let us list those of the properties of the field (4) that we are going to use:

- Singular points of the field (4) are given by equation (11) and form a curve (or several curves) in PTS .
- The spectrum of the linearization of the field (4) at every singular point contains one zero eigenvalue and two real eigenvalues $\lambda_{1,2}$, which vanish (simultaneously) at those points where the cubic polynomial $M(q, p)$ has a double root p . The latter condition is equivalent to the direction p is tangent to S_0 at the point q .
- For every point $q \in S_0$ and any $p \in \mathbb{RP}$ such that $M(q, p) \neq 0$ there exists a unique integral curve of the field (4) that passes through the point (q, p) – a vertical straight line, whose projection on S is not a geodesic. Consequently, the vertical surface \overline{S}_0 is an invariant surface of (4).
- Geodesics cannot enter a point $q \in S_0$ in arbitrary tangential direction, but only in *admissible* directions p that satisfy the condition $M(q, p) = 0$.
- The isotropic direction $p_0(q)$ given by formula (7) is admissible at every point $q \in S_0$, i.e., $M(q, p_0(q)) = 0$ for all $q \in S_0$.

Depending on the roots of the cubic polynomial M (see Fig. 6), we have four cases:

- C_1 : the isotropic direction p_0 is a unique real root of M ,
- C_2 : M has a simple root p_0 and a double non-isotropic real root $p_1 = p_2$,
- C_3 : M has three simple real roots: isotropic p_0 and non-isotropic p_1, p_2 ,
- D : the isotropic double root $p_0 = p_1$ and a simple non-isotropic root p_2 .

If $\text{Re } \lambda_{1,2} \neq 0$, the set W is the center manifold of the field, and the restriction of the field to W is identically zero. Hence in a neighborhood of every singular point where $\text{Re } \lambda_{1,2} \neq 0$, the phase portrait of the field has a very simple topological structure. Indeed, the reduction principle [5, 15] asserts that the germ of the field is orbitally topologically equivalent to the direct product of the standard 2-dimensional node (if $\text{Re } \lambda_{1,2}$ have the same sign) or saddle (if $\text{Re } \lambda_{1,2}$ have different signs) and 1-dimensional zero vector field. However, the topological classification is not enough.

The paper [23] presents finite-smooth local normal forms of such fields, [26] contains a brief survey (Appendix A) on the smooth and C^ω classifications. These results allow to establish smooth local normal forms of the field (4) at all singular points (q, p_i) , $q \in S_0$, where p_i is a simple real root of $M(q, p)$. This gives the description of geodesics

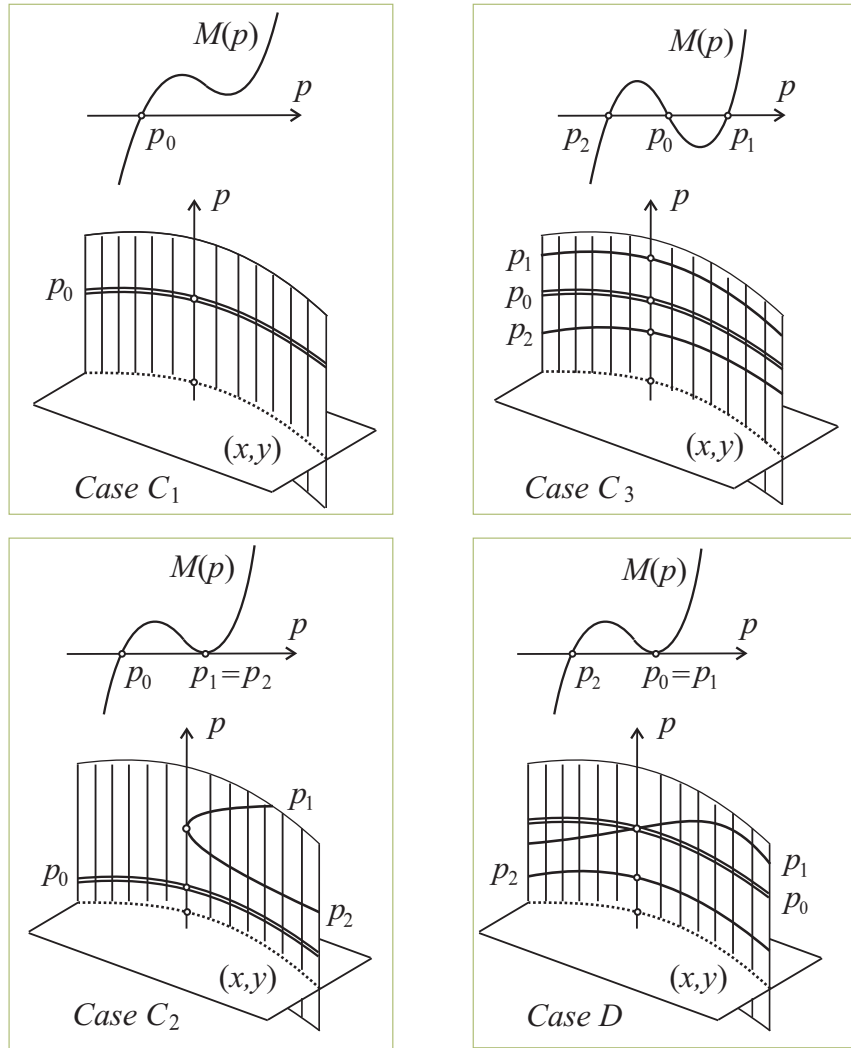

Figure 6: Real roots of the cubic polynomial $M(p)$ and the set of singular point of the field (4). The double line presents $\{(q, p_0), q \in S_0\}$, the bold lines present $\{(q, p_i), q \in S_0\}$, $i = 1, 2$, the dotted line presents S_0 .

that enter a degenerate point with all possible admissible directions for the cases C_1 , C_3 . To study geodesics with the isotropic admissible direction in the cases C_2 and D , one can use a blow-up procedure.

Choosing appropriate local coordinates, we shall further assume that in a neighborhood of the point $q \in S_0$, equation (2) has the form $dx^2 = y dy^2$ in the case C and (10) in the case D . Consequently, the discriminant curve S_0 is the axis $y = 0$ in the case C and the parabola $y - \varepsilon x^2 = 0$ in the case D . Since multiplication the metric by the factor -1 does not change the geodesic flow, without loss of generality, assume that $y > \varepsilon x^2$ and $y < \varepsilon x^2$ (including the case $\varepsilon = 0$) are Lorentzian and Riemannian domains, respectively.

From now on, we shall consider geodesics outgoing from a degenerate point $q \in S_0$ with the isotropic admissible direction $p_0(q)$ as semitrajectories starting from q . We distinguish geodesics outgoing into the Lorentzian (resp. Riemannian) domains using the superscript $+$ (resp. $-$). Let us clarify this with the following example.

Example 1 For the metric $ds^2 = dx^2 - y dy^2$, the discriminant curve $S_0 = \{y = 0\}$ divides the plane into the Lorentzian ($y > 0$) and Riemannian ($y < 0$) domains. Formula (5) yields $M(q, p) = p^2$, and we have the case C_2 .

At every degenerate point $q \in S_0$ there exist two admissible directions: $p_1 = 0$ (non-isotropic, double root) and $p_0 = \infty$ (isotropic). To see that the direction $p_0 = \infty$ is admissible, it is convenient to interchange x and y . In the new coordinates $\bar{x} = y$, $\bar{y} = x$, $\bar{p} = 1/p$, the polynomial $M(q, \bar{p}) = -\bar{p}$ has the root $\bar{p} = 0$.

The corresponding field (4) has a unique integral curve $y = 0$ that pass through every point $q \in S_0$ with tangential direction $p_1 = 0$. Substituting $y = 0$ directly in (3), one can see that $y = 0$ is an extremal of the action functional and its natural parametrization is given by the equation $\ddot{x} = 0$. Moreover, given degenerate point $q \in S_0$ there exists a one-parameter family of geodesics outgoing from q with the tangential direction $p = \infty$. For instance, consider the family Γ_0 of geodesics γ_α , $\alpha \in \mathbb{R}$, outgoing from the origin; see Fig. 8 (right). They can be presented in the agreed upon way as

$$\gamma_\alpha = \begin{cases} \gamma_\alpha^+ : x = \alpha y^{\frac{3}{2}}, & y \geq 0, \\ \gamma_\alpha^- : x = \alpha(-y)^{\frac{3}{2}}, & y \leq 0. \end{cases} \quad (12)$$

4.1 The case C

The linearization of the field (4) at every singular point (q, p_i) , $q \in S_0$, $i = 0, 1, 2$, has the spectrum $(\lambda_1, \lambda_2, 0)$ with non-zero real eigenvalues $\lambda_{1,2}$. Moreover, at a singular point (q, p_0) corresponding to the isotropic admissible direction the resonant relation $\lambda_1 = 2\lambda_2$ holds. On the other hand, at a singular point (q, p_i) , $i = 1, 2$, corresponding

to non-isotropic admissible direction the resonant relation $\lambda_1 + \lambda_2 = 0$ holds.³ Using the smooth classification of vector fields with non-isolated singular points (see e.g. [26], Appendix A), we have the following results.

The germ of the field (4) at any point (q, p_0) , $q \in S_0$, has C^∞ orbital normal form

$$2\xi \frac{\partial}{\partial \xi} + \eta \frac{\partial}{\partial \eta} + 0 \frac{\partial}{\partial \zeta} \quad (13)$$

with the first integrals $I_1 = \xi/\eta^2$ and $I_2 = \zeta$. The germ of the field (4) at any point (q, p_i) , $q \in S_0$, $i = 1, 2$, has C^∞ orbital normal form

$$\xi \frac{\partial}{\partial \xi} - \eta \frac{\partial}{\partial \eta} + \xi \eta \frac{\partial}{\partial \zeta} \quad (14)$$

with the first integral $I = \xi\eta$. One can see that to every singular point of the field (13) corresponds a one-parameter family of integral curves passing through this point, while to every singular point of the field (14) correspond only two integral curves. Projecting the integral curves down, we obtain the following results.

Theorem 2 ([24, 25]) *Suppose that C holds true. Then to the isotropic direction p_0 corresponds a one-parameter family Γ_0 of geodesics outgoing from the point q . There exist smooth local coordinates centered at q such that the discriminant curve S_0 coincides with the x -axis, the isotropic direction $p_0(q) = \infty$ and the geodesics $\gamma_\alpha^\pm \in \Gamma_0$ are semi-cubic parabolas*

$$x = \alpha\tau^3 X_\alpha^\pm(\tau), \quad y = \tau^2 Y_\alpha^\pm(\tau), \quad \alpha \geq 0, \quad (15)$$

where $X_\alpha^\pm, Y_\alpha^\pm$ are smooth functions, $X_\alpha^\pm(0) = 1$, $Y_\alpha^\pm(0) = \pm 1$.

Theorem 3 ([24, 25]) *Suppose that C_3 holds true. Then to each admissible direction p_i , $i = 1, 2$, corresponds a unique geodesic passing through the point q . Both these geodesics are smooth and timelike.*

In the left panel of Fig. 7 we present the invariant foliations of the field (4) in a neighborhood of the point (q, p_0) , $q \in S_0$, that correspond to the first integrals $I_1 = \xi/\eta^2$ (left) and $I_2 = \zeta$ (right) of the normal form (13). Intersection of these foliations gives the family of integral curves of (4). The family Γ_0 of the geodesics (15) is obtained (by the projection $PTS \rightarrow S$) from the family of integral curves of the field (4) that pass through its singular point (q, p_0) . The subfamily $\Gamma_0^+ \subset \Gamma_0$ of the geodesics (15) outgoing into the Lorentzian semiplane, contains timelike, spacelike, and isotropic geodesics.

³ The relation $\lambda_1 = 2\lambda_2$ is a corollary of $\lambda_1 + \lambda_2 + \lambda_3 = r\lambda_1$ with $r = \frac{3}{2}$ and $\lambda_3 = 0$, see Theorem 1 and formula (6). The relation $\lambda_1 + \lambda_2 = 0$ follows from the fact that the field \vec{W} is divergence-free and the function F does not vanish in a neighborhood of (q, p_i) , $i = 1, 2$.

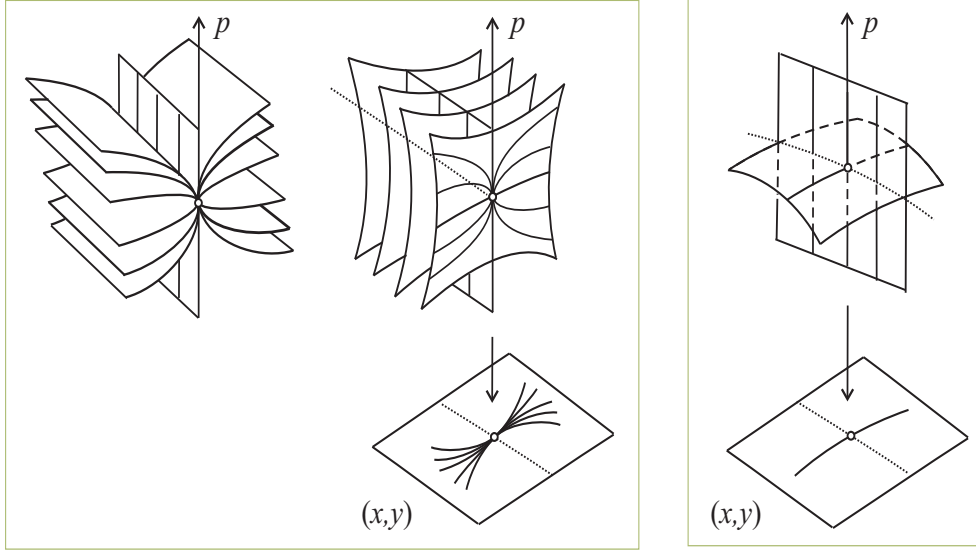

Figure 7: The cases C_1, C_3 . Left panel: two invariant foliations of the field (4) near the point (q, p_0) , $q \in S_0$. Right panel: the invariant leaves of the field (4) passing through the point (q, p_i) , $q \in S_0$, $i = 1, 2$. The dotted lines present the set of singular points of the field (4) and its projection, the discriminant curve.

In the right panel of Fig. 7 we present those of the leaves of the invariant foliation of the field (4) in a neighborhood of the point (q, p_i) , $q \in S_0$, $i = 1, 2$, that pass through (q, p_i) . This foliation corresponds to the first integral $I = \xi\eta$ in the normal form (14), and the leaves passing through (q, p_i) coincide with the planes $\xi = 0$ and $\eta = 0$, while none of the remaining leaves contains singular points of (4). One of these leaves coincides with the vertical surface \bar{S}_0 filled with vertical integral curves whose projection on S are points of S_0 . Another invariant surface is filled with non-vertical integral curves, through every point (q, p_i) , $q \in S_0$, there pass exactly one curve.

Example 2 To illustrate the above, return to Example 1. In the coordinates $\bar{x} = y$, $\bar{y} = x$, $\bar{p} = 1/p$, the equation of isotropic lines coincides with Cibrario normal form. After multiplication by -1 , the corresponding vector field (4) reads

$$\vec{V} = 2\bar{x} \left(\frac{\partial}{\partial \bar{x}} + \bar{p} \frac{\partial}{\partial \bar{y}} \right) + \bar{p} \frac{\partial}{\partial \bar{p}}. \quad (16)$$

It is easy to check that the field (16) possesses the invariant foliation $\bar{x} = c\bar{p}^2$, which includes, in particular, the vertical surface \bar{S}_0 (for $c = 0$), the isotropic surface (for $c = 1$). This foliation is presented in the left side of the left panel of Fig. 7. The restriction of the field (16) to every invariant leaf $\bar{x} = c\bar{p}^2$ reads $2c\bar{p}^3 \frac{\partial}{\partial \bar{y}} + \bar{p} \frac{\partial}{\partial \bar{p}}$. Canceling the factor \bar{p} , we obtain the non-singular field $2c\bar{p}^2 \frac{\partial}{\partial \bar{y}} + \frac{\partial}{\partial \bar{p}}$, whose integral curves are

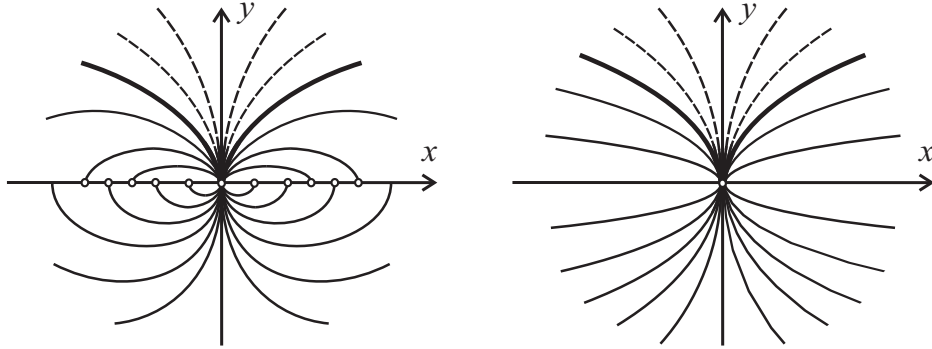

Figure 8: Two examples of the family Γ_0 in Theorem 2. Geodesics in the metrics $e^y dx^2 - y dy^2$ (left) and $dx^2 - y dy^2$ (right) outgoing from $q = 0$. Timelike, spacelike, and isotropic geodesics are depicted as solid, dashed, and bold solid lines respectively.

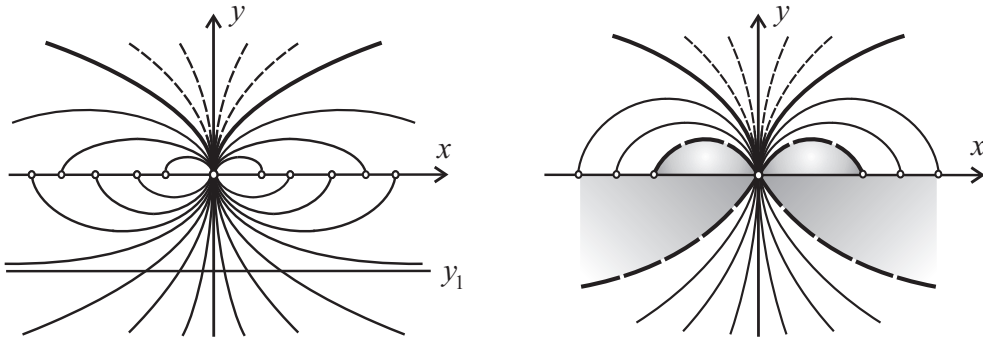

Figure 9: Geodesics in the metrics $ds^2 = a(y)dx^2 - ydy^2$ with $a(y) = 1 + (y + y_1)^2$ outgoing from $q = 0$. The case C_1 ($y_1 < 0$, left) and the case C_3 ($y_1 > 0$, right). Timelike, spacelike, and isotropic geodesics are depicted as solid, dashed, and bold solid lines respectively. Geodesics passing through 0 with non-isotropic admissible directions (right) are depicted as long-dashed bold lines. The grey domains do not contain geodesics passing through 0.

presented in Fig. 5 (left). Fixing a degenerate point $q \in S_0$, in going through all invariant leaves $\bar{x} = c\bar{p}^2$ and projecting down, we obtain the family (12) of geodesics γ_α^+ (for $c > 0$) and γ_α^- (for $c < 0$) presented in Fig. 8 (right).⁴

Remark 2 If the pseudo-Riemannian metric on the surface S is induced by the pseudo-Euclidean metric $dX^2 + dY^2 - dZ^2$ of the ambient space (see the example above), the difference between the cases C_1 and C_3 has a graphical interpretation. Namely, C_1 and C_3 correspond to positive and negative Gaussian curvature of the surface S calculated in the Euclidean metric $dX^2 + dY^2 + dZ^2$.

Theorem 4 *Suppose that C_2 holds true. Generically, the point q locally separates the curve S_0 in two parts, filled with C_1 and C_3 points, respectively, and there exist smooth local coordinates centered at q such that the metric has the form*

$$ds^2 = a(x, y) dx^2 + ye(x, y) dy^2, \quad a(0) \neq 0, \quad e(0) \neq 0, \quad a_y(0) = 0, \quad a_{xy}(0) \neq 0. \quad (17)$$

Then to the double admissible direction $p_1 = p_2$ corresponds a unique geodesic passing through the point q , a semicubic parabola with branches outgoing from q into the Lorentzian and Riemannian domains (depicted as long-dashed line in Fig. 10, center).

The proof is not published yet. In Example 1 considered above, we deal with a non-generic case C_2 , since the condition $a_{xy}(0) \neq 0$ in (17) does not hold true. This leads to the geodesic $y = 0$ instead of a semicubic parabola mentioned in Theorem 4.

4.2 The case D

The cubic polynomial M at $q \in S_0$ has the isotropic double root $p_0 = p_1$ and a simple non-isotropic root p_2 . For the admissible direction p_2 , the analogous assertion to Theorem 3 holds true: the germ of the field (4) at (q, p_2) has C^∞ normal form (14), and to the direction p_2 corresponds a unique smooth geodesic passing through the point q . However, the study of geodesics with the isotropic direction is more complicated.

A special feature of the case D is that the linear part of the germ (4) at (q, p_0) , $q \in S_0$, has three zero eigenvalues. This prevents the possibility to obtain a normal form similar to (13) in Theorem 2 or similar to (14) in Theorem 3. Moreover, in this case even the reduction principle does not allow to establish the topological normal

⁴ The attentive reader may remark that this invariant foliation contains also the leaf $\bar{p} = 0$, which can be considered as the limiting case for $c \rightarrow \infty$. The restriction of (16) to this leaf is filled with integral curves parallel to the \bar{x} -axis. This gives the family of geodesics $x = \text{const}$, which are the limiting case of the semi-cubic parabolas (15): the two branches are glued together.

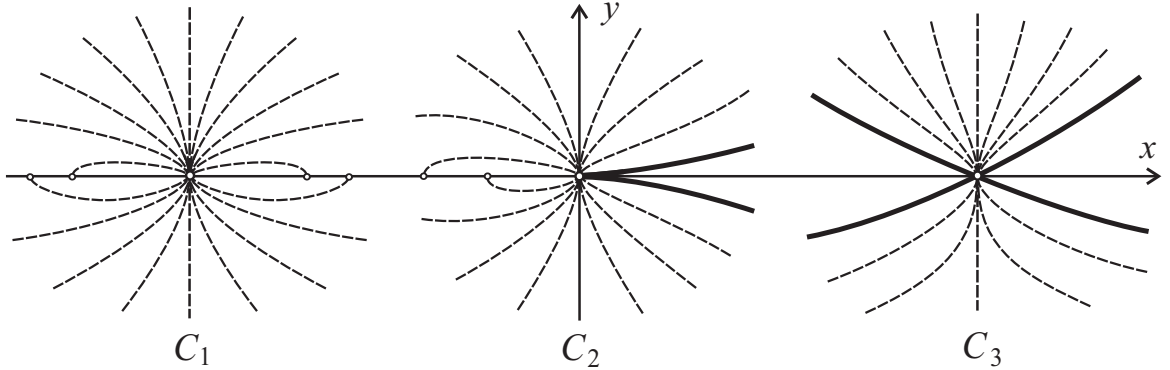

Figure 10: Geodesics in the metrics (17) outgoing from three different degenerate points: C_1 ($x < 0$, left), C_2 ($x = 0$, center), and C_3 ($x > 0$, right). Here timelike, spacelike, and isotropic geodesics outgoing from $q \in S_0$ with the isotropic direction $p_0 = \infty$ are depicted as dashed lines, while the geodesics outgoing from $q \in S_0$ with non-isotropic admissible direction $p_1 = 0$ are depicted as bold lines.

form of this field, since the *center subspace*⁵ of the germ (4) at (q, p_0) coincides with the whole tangent space, see [5]. However, using appropriate blowing up procedure, one can reduce the germ (4) at (q, p_0) to a smooth vector field with non-zero spectrum and study the obtained vector field using the standard methods.

Further we always assume that in the cases D_s and D_n the following genericity condition holds true: there are no non-trivial integer relations

$$n_1\alpha_1 + n_2\alpha_2 + n_3\alpha_3 = \alpha_j, \quad n_1 + n_2 + n_3 \geq 1, \quad n_i \in \mathbb{Z}_+, \quad j = 1, 2, 3,$$

where $\alpha_{1,2}$ are the eigenvalues of the linearization of the vector field (9) at (q, p_0) and $\alpha_3 = 2$. This condition implies the germ of a vector field obtained from (4) by the blowing up procedure is linearizable, as well as the germ of the field (9).

4.2.1 The cases D_n and D_f

In a neighborhood of the considered point (q, p_0) , $q \in S_0$, the field (4) above the Lorentzian domain has an invariant foliation $\{\mathcal{F}_\alpha\}$ presented in the left panel of Fig. 11. Here the invariant leaf \mathcal{F}_0 coincides with the isotropic surface \mathcal{F} . The invariant leaves above the Riemannian domain are not depicted, since they contain no integral curves that pass through (q, p_0) .

The linear part of the restriction of the field (4) to every invariant leaf \mathcal{F}_α at its singular point (q, p_0) is equal to (9) multiplied by a smooth scalar function σ_α vanishing

⁵ The center subspace T_c of a vector field \vec{V} at its singular point 0 is spanned by the generalized eigenvectors of the linearization of \vec{V} at 0 corresponding to the eigenvalues λ with $\text{Re } \lambda = 0$.

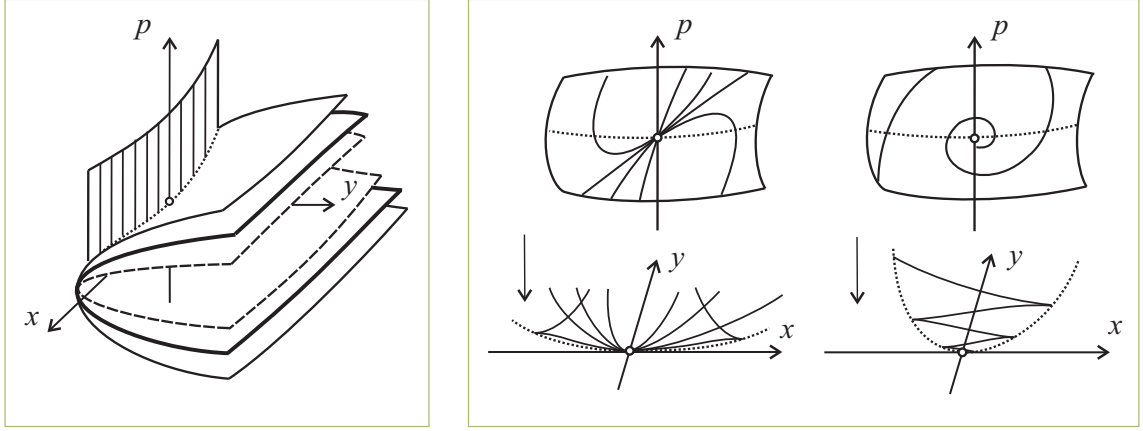

Figure 11: The cases D_n and D_f . The left panel: the invariant foliation $\{\mathcal{F}_\alpha\}$ of the field (4) above the Lorentzian domain (the isotropic surface $\mathcal{F} = \mathcal{F}_0$ is depicted as bold). Here the leaves filled with timelike, spacelike and isotropic geodesics are depicted as solid, dashed and bold solid lines, respectively. The right panel: integral curves of the restriction of field (4) to \mathcal{F}_α and their projections (the case D_n on the left and D_f on the right). The criminant and the discriminant curve are depicted as dotted lines.

along the criminant. Therefore, the restriction of the field (4) to every invariant leaf \mathcal{F}_α has the local phase portrait of the same type: node or focus. See Fig. 11 (right panel). In going through all invariant leaves \mathcal{F}_α and projecting the integral curves down, we obtain the following result.

Theorem 5 ([26]) *Let the case D_n or D_f holds true. Then to the isotropic direction p_0 corresponds a two-parameter family Γ_0 of C^2 -smooth geodesics γ_α^+ outgoing from q into the Lorentzian domain, while there are no geodesics outgoing from q into the Riemannian domain. Given α , the geodesics $\gamma_{\alpha,\beta}^+ \in \Gamma_0$ with fixed α and varying β are projections of the integral curves from the leaf \mathcal{F}_α ; see Fig. 11, center for D_n and right for D_f . The geodesics $\gamma_{\alpha,\beta}^+ \in \Gamma_0$ are timelike if $\alpha < 0$, spacelike if $\alpha > 0$ and isotropic if $\alpha = 0$.*

4.2.2 The case D_s

In a neighborhood of the considered point (q, p_0) , $q \in S_0$, the field (4) above the Lorentzian domain has an invariant foliation $\{\mathcal{F}_\alpha\}$ presented in the left panel of Fig. 12. Here the invariant leaf \mathcal{F}_0 coincides with the isotropic surface \mathcal{F} . The invariant leaves above the Riemannian domain are not depicted, since they contain no integral curves that pass through (q, p_0) .

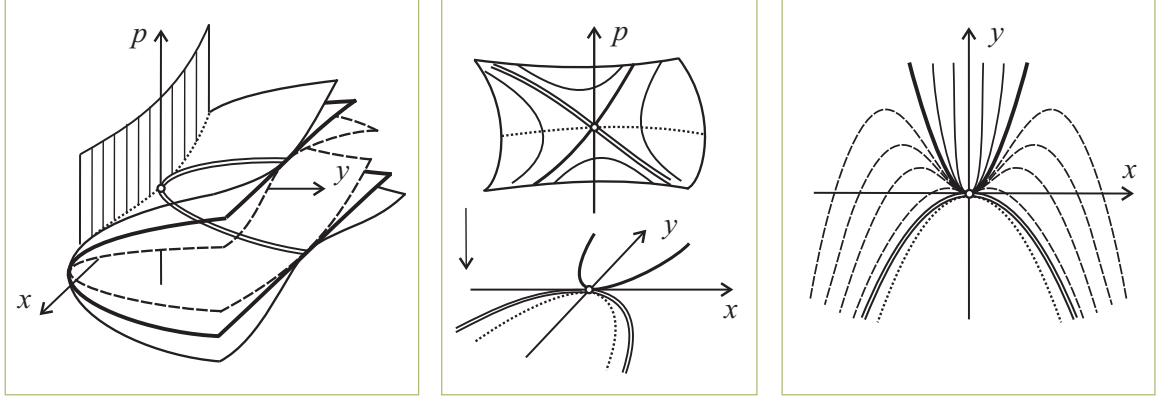

Figure 12: The case D_s . On the left: invariant foliation $\{\mathcal{F}_\alpha\}$ of the field (4) above the Lorentzian domain (the isotropic surface $\mathcal{F} = \mathcal{F}_0$ is depicted as bold). Center: integral curves of the field (4) on an invariant leaf \mathcal{F}_α . On the right: geodesics outgoing from the point $q \in S_0$. Timelike and spacelike geodesics are depicted as solid and dashed lines, respectively. The bold solid and the double solid lines present two isotropic geodesics. The criminant and the discriminant curve are depicted as dotted lines.

The linear part of the restriction of the field (4) to every invariant leaf \mathcal{F}_α at its singular point (q, p_0) is equal to (9) multiplied by a smooth scalar function σ_α vanishing along the criminant. Therefore, the restriction of the field (4) to every invariant leaf \mathcal{F}_α has a saddle at (q, p_0) . See Fig. 12 (right panel).

Theorem 6 ([26]) *Let the case D_s holds true. Then to the isotropic direction p_0 corresponds a one-parameter family Γ_0 of C^2 -smooth geodesics outgoing from q into the Lorentzian domain, while there are no geodesics outgoing from q into the Riemannian domain. There exist smooth local coordinates centered at q such that S_0 is the parabola $y = \varepsilon x^2$ and the geodesics $\gamma_\alpha^+ \in \Gamma_0$ outgoing from q have the form*

$$y = \frac{\varepsilon_1}{2}x^2 + Y_\alpha(x), \quad Y_\alpha(x) = o(x^2), \quad \alpha \in \mathbb{R}, \quad (18)$$

together with one additional isotropic geodesic

$$y = \frac{\varepsilon_2}{2}x^2 + Y(x), \quad Y(x) = o(x^2), \quad (19)$$

where $\varepsilon_1\varepsilon_2 = \varepsilon$, $\varepsilon_1 + \varepsilon_2 = \frac{1}{2}$, $\varepsilon_1 > \frac{1}{2}$, $\varepsilon_2 < 0$. Geodesics (18) are timelike if $\alpha < 0$, spacelike if $\alpha > 0$, isotropic if $\alpha = 0$; see Fig. 12, right.

It is interesting to note that invariant foliations in the cases D_n , D_f and D_s have the different topological structures (compare the left panels of Figures 11 and 12).

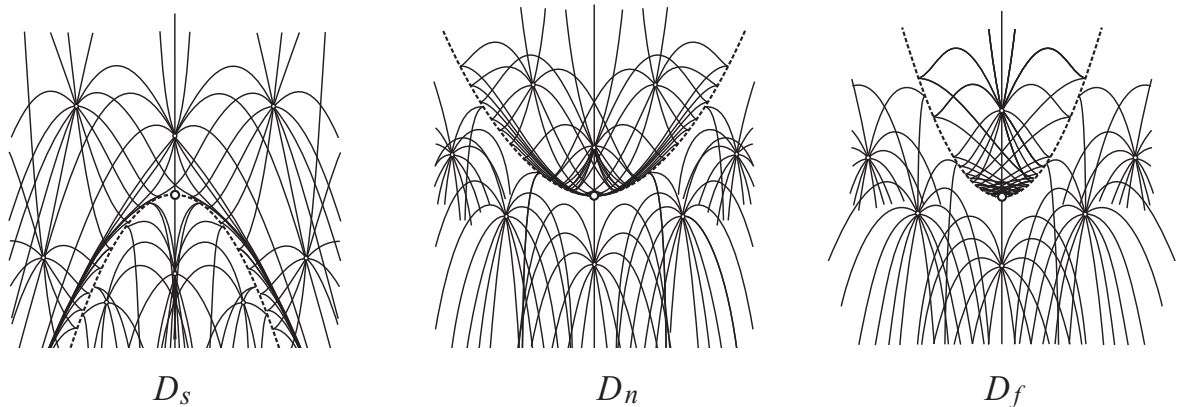

Figure 13: Computer generated geodesics (solid lines) of the metric $dy^2 + (\varepsilon x^2 - y)dx^2$ with $\varepsilon < 0$ (the case D_s), $0 < \varepsilon < \frac{1}{16}$ (the case D_n), and $\varepsilon > \frac{1}{16}$ (the case D_f). The parabola depicted as dotted line is the discriminant curve S_0 .

In the cases D_n , D_f all invariant leaves intersect on the criminant only, while in the case D_s they intersect on the criminant (dotted line) and on the double line, whose projection is the isotropic geodesic (19).

4.3 Example: Clairaut type

It is of interest to observe an important difference between the families Γ_0 in the cases C_1 , C_3 and D . In the cases C_1 , C_3 , the family Γ_0 is symmetric with respect to S_0 in the following sense: it contains an infinite number of geodesics $\gamma_\alpha^+ \in \Gamma_0$ outgoing into the Lorentzian domain and an infinite number of geodesics $\gamma_\alpha^- \in \Gamma_0$ outgoing into the Riemannian domain. On the contrary, in the case D , the family Γ_0 is non-symmetric: it contains an infinite number of geodesics $\gamma_\alpha^+ \in \Gamma_0$ outgoing into the Lorentzian domain and no geodesics $\gamma_\alpha^- \in \Gamma_0$ outgoing into the Riemannian domain.

To understand this phenomenon better, consider the case when the isotropic direction p_0 is tangent to the curve S_0 at all points $q \in S_0$, for instance, the metric $dy^2 + (\varepsilon x^2 - y)dx^2$. The equation of geodesics in the metric $ds^2 = dy^2 - ydx^2$ can be studied using qualitative methods, see [25] (Section 3). The Lagrangian of the length functional $L = \sqrt{p^2 - y}$ does not depend on the variable x , hence the field (4) possesses the energy integral $H = L - pL_p$. After evident transformations, equation $H = \text{const}$ can be reduced to

$$p^2 = y - \alpha y^2, \quad \alpha \in \mathbb{R}, \quad (20)$$

which is a family of implicit differential equations of *Clairaut type* [11].

Every (unparametrized) geodesic in the metric $ds^2 = dy^2 - ydx^2$ is a solution of equation (20). Conversely, every solution of (20) is a geodesic except the horizontal

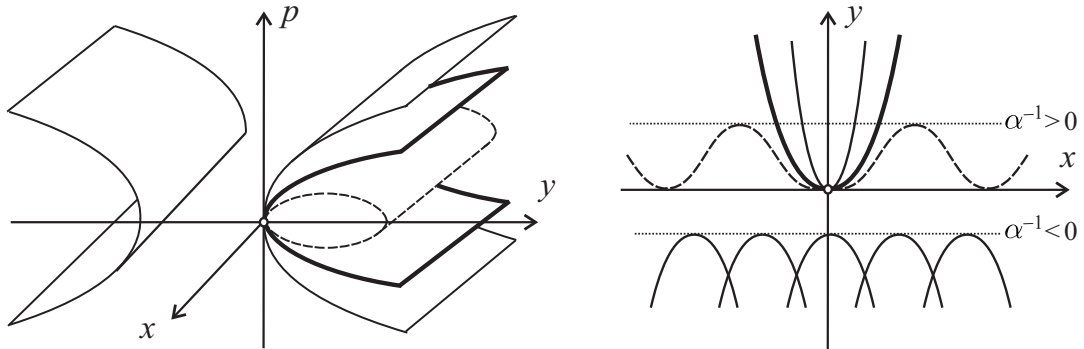

Figure 14: The invariant foliation $p^2 = y - \alpha y^2$ in the (x, y, p) -space (left) and the corresponding geodesics (right). Timelike, spacelike and isotropic geodesics are solid, dashed and bold solid lines, respectively.

lines $y \equiv \text{const}$, each of which is the envelop of the family of integral curves of (20) for a given α (see [25]). For instance, the value $\alpha = 0$ corresponds to the isotropic surface $p^2 = y$ (a parabolic cylinder) and gives, in particular, the isotropic geodesic $y = \frac{1}{4}x^2$ passing through the origin.

For determining non-isotropic geodesics, observe that every invariant surface (20) is a cylinder whose generatrices are parallel to the x -axis and the base is an ellipse (if $\alpha > 0$) or a hyperbola (if $\alpha < 0$). In the latter case, the hyperbolic cylinder $p^2 = y - \alpha y^2$ consists of two connected components: *positive* and *negative* lying in the domains $y \geq 0$ and $y \leq \alpha^{-1}$, respectively. Positive components of the hyperbolic cylinders ($\alpha < 0$) together with all other cylinders ($\alpha \geq 0$) form an invariant foliation over the Lorentzian domain $y > 0$. Negative components of the hyperbolic cylinders form an invariant foliation over the Riemannian domain $y < 0$; they do not intersect the plane $y = 0$, and consequently, do not contain integral curves whose projections to the (x, y) -plane are geodesics passing through the x -axis. See Fig. 14 (left).

Thus to every $\alpha \geq 0$ corresponds a geodesic $\gamma_\alpha^+ \in \Gamma_0$ which is timelike if $\alpha > 0$ or isotropic if $\alpha = 0$. To every $\alpha < 0$ corresponds a spacelike geodesic $\gamma_\alpha^+ \in \Gamma_0$, whose lift belongs to the positive component of the hyperbolic cylinder $p^2 = y - \alpha y^2$. In contrast to this, the negative component of the same cylinder is filled with integral curves of the field (4) whose projections on the (x, y) -plane are separated from the x -axis by the horizontal strip $\alpha^{-1} < y < 0$. Therefore, there are no geodesics outgoing into the Riemannian domain. See Fig. 14, right.

Acknowledgement. The publication was supported by the Russian Foundation for Basic Research (research projects 16-01-00766, 17-01-00849).

References

- [1] Aguirre, E., Fernandez, V., Lafuente, J., On the conformal geometry of transverse Riemann–Lorentz manifolds. *J. Geometry and Physics* 57 (2007), 1541–1547.
- [2] Al'tshuler, B. L., Barvinski, A. O., Quantum cosmology and physics of transitions with a change of spacetime signature. *Uspekhi Fiz. Nauk* 166:5 (1996), 459.492; English transl. in *Physics-Uspekhi* 39, 429.
- [3] Aminova, A. V., Projective transformations and symmetries of differential equations. *Mat. Sb.*, 186:12 (1995), 21–36.
- [4] Arnol'd, V. I., *Geometrical methods in the theory of ordinary differential equations*, Springer-Verlag, New York, 1988.
- [5] Anosov, D. V., Arnold, V. I. (eds.). Dynamical systems I. Ordinary differential equations and smooth dynamical systems. *Encyclopaedia of Mathematical Sciences* 1. Springer-Verlag (1988).
- [6] Bogaevsky, I. A., Implicit ordinary differential equations: bifurcations and sharpening of equivalence. *Izvestiya: Mathematics*, 78:6 (2014), 1063–1078.
- [7] Bolsinov, A. V., Matveev, V. S., Local normal forms for geodesically equivalent pseudo-Riemannian metrics. *Trans. Amer. Math. Soc.*, 367 (2015), 6719–6749.
- [8] Cibrario, M., Sulla riduzione a forma delle equazioni lineari alle derivate parziali di secondo ordine di tipo misto. *Accademia di Scienze e Lettere, Istituto Lombardo Redicconti* 65 (1932), 889–906.
- [9] Dara, L., Singularités générique des équations différentielles multiformes. *Bol. Soc. Bras. Math.* 6, n. 2 (1975), 95–128.
- [10] Davydov, A. A., The normal form of a differential equation, that is not solved with respect to the derivative, in the neighborhood of its singular point, *Funktsional. Anal. i Prilozhen.* 19 (1985), 1–10.
- [11] Davydov, A. A., Ishikawa, G., Izumiya, S., Sun, W.-Z., Generic singularities of implicit systems of first order differential equations on the plane. *Jpn. J. Math.* 3 (2008), 93–119.
- [12] Genin, D., Khesin, B., Tabachnikov, S., Geodesics on an ellipsoid in Minkowski space. *Enseign. Math.* 53 (2007), 307–331.
- [13] Ghezzi, R., Remizov, A. O., On a class of vector fields with discontinuities of divide-by-zero type and its applications to geodesics in singular metrics. *J. Dyn. Control Syst.*, 18 (2012), 135–158.
- [14] Hartman, Ph., *Ordinary differential equations*. Birkhauser, Boston, Mass., 1982.
- [15] *Hirsch M. W., Pugh C. C., Shub M.*, Invariant manifolds. Lecture Notes in Mathematics, Vol. 583. Springer-Verlag, Berlin-New York, 1977.

- [16] Khesin, B., Tabachnikov, S., Pseudo-Riemannian geodesics and billiards. *Adv. Math.* 221 (2009), 1364–1396
- [17] Kossowski, M., Kriele, M., Smooth and discontinuous signature type change in general relativity. *Class. Quantum Grav.* 10, 2363–2371 (1993).
- [18] Kossowski, M., Kriele, M., Transverse, type changing, pseudo-Riemannian metrics and the extendability of geodesics. *Proc. Roy. Soc. Lond. Ser. A Math. Phys.* 444:1921, 297–306 (1994).
- [19] Kossowski, M., Kriele, M., The Einstein equation for signature type changing space-times. *Proc. Roy. Soc. Lond. Ser. A Math. Phys.* 446:1926, 115–126 (1994).
- [20] Kossowski, M., Pseudo-Riemannian metrics singularities and the extendability of parallel transport. *Proc. Amer. Math. Soc.* 99 (1987), 147–154.
- [21] Miernowski, T., Formes normales d’une métrique mixte analytique réelle générique. *Ann. Fac. Sci. Toulouse Math.* 16 (2007), 923–946.
- [22] Pavlova, N. G., Remizov, A. O., Geodesics on hypersurfaces in the Minkowski space: singularities of signature change. *Russian Math. Surveys* 66 (2011), 1201–1203.
- [23] Remizov, A. O., Multidimensional Poincaré construction and singularities of lifted fields for implicit differential equations. *J. Math. Sci. (N.Y.)* 151:6 (2008), 3561–3602.
- [24] Remizov, A. O., Geodesics on 2-surfaces with pseudo-Riemannian metric: singularities of changes of signature. *Mat. Sb.*, 200:3 (2009), 75–94.
- [25] Remizov, A. O., On the local and global properties of geodesics in pseudo-Riemannian metrics. *Differential Geometry and its Applications*, 39 (2015), 36–58.
- [26] Remizov, A. O., Tari, F., Singularities of the geodesic flow on surfaces with pseudo-Riemannian metrics. *Geometriae Dedicata* 185 (2016), no. 1, pp. 131–153.
- [27] Sakharov, A.D., Cosmological transitions with changes in the signature of the metric. *Zh. Eksper. Teor. Fiz.* 87:2 (8) (1984), 375–383. English transl. in *Soviet Phys. JETP* 60 (2), August 1984, 214–218.
- [28] Steller, M., A Gauss-Bonnet formula for metrics with varying signature. *Z. Anal. Anwend.* 25 (2006), pp. 143–162.