

Deep Learning for End-to-End Automatic Target Recognition from Synthetic Aperture Radar Imagery

Hidetoshi FURUKAWA[†]

[†] Toshiba Infrastructure Systems & Solutions Corporation

1 Komukaitoshiba-cho, Saiwai-ku, Kawasaki-shi, Kanagawa, 212-8581 Japan

E-mail: †hidetoshi.furukawa@toshiba.co.jp

Abstract The standard architecture of synthetic aperture radar (SAR) automatic target recognition (ATR) consists of three stages: detection, discrimination, and classification. In recent years, convolutional neural networks (CNNs) for SAR ATR have been proposed, but most of them classify target classes from a target chip extracted from SAR imagery, as a classification for the third stage of SAR ATR. In this report, we propose a novel CNN for end-to-end ATR from SAR imagery. The CNN named verification support network (VersNet) performs all three stages of SAR ATR end-to-end. VersNet inputs a SAR image of arbitrary sizes with multiple classes and multiple targets, and outputs a SAR ATR image representing the position, class, and pose of each detected target. This report describes the evaluation results of VersNet which trained to output scores of all 12 classes: 10 target classes, a target front class, and a background class, for each pixel using the moving and stationary target acquisition and recognition (MSTAR) public dataset.

Key words Automatic target recognition (ATR), Multi-target detection, Multi-target classification, Pose estimation, Convolutional neural network (CNN), Synthetic aperture radar (SAR)

1. Introduction

Synthetic aperture radar (SAR) transmits microwaves and generates imagery using microwaves reflected from objects, under all weather, day and night conditions. However, it is difficult for a human to recognize a target from SAR imagery since there is no color information and the shape reflected from a target changes. Therefore, automatic target recognition (ATR) from SAR imagery (or image) has been studied for many years.

The standard architecture of SAR ATR consists of three stages: detection, discrimination, and classification. Detection: the first stage of SAR ATR detects a region of interest (ROI) from a SAR image. Discrimination: the second stage of SAR ATR discriminates whether an ROI is a target or non-target region, and outputs the discriminated ROI as a target chip. Classification: the third stage of SAR ATR classifies target classes from a target chip.

In recent years, methods using convolution neural network (CNN) [1]–[4] have been successful in the classification of image recognition. Similarly, CNNs for SAR ATR have been proposed. On the moving and stationary target acquisition and recognition (MSTAR) public dataset [5], the target classification accuracy of the CNNs [6]–[9] exceeds conventional

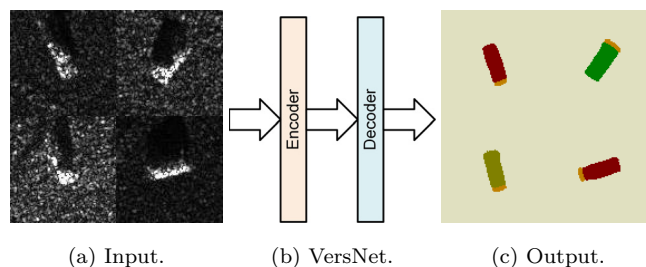

Fig. 1 Illustration of input and output of proposed CNN. The CNN named VersNet performs automatic target recognition of multi-class / multi-target in variable size SAR image. In this case, the input is a single image with three classes and four targets (upper left and lower right targets are the same class). VersNet outputs the position, class, and pose (front side) of each detected target.

methods (support vector machine, etc.). However, most of CNNs for SAR ATR classify target classes from a target chip extracted from SAR image but do not classify multiple targets or a target chip (or SAR image) of an arbitrary size. In addition, a CNN for target classification can output score or probability of each class as classification result, but it is difficult for a human to verify the classification result.

We propose a new CNN which inputs a SAR image of variable sizes with multi-target and outputs a SAR ATR image.

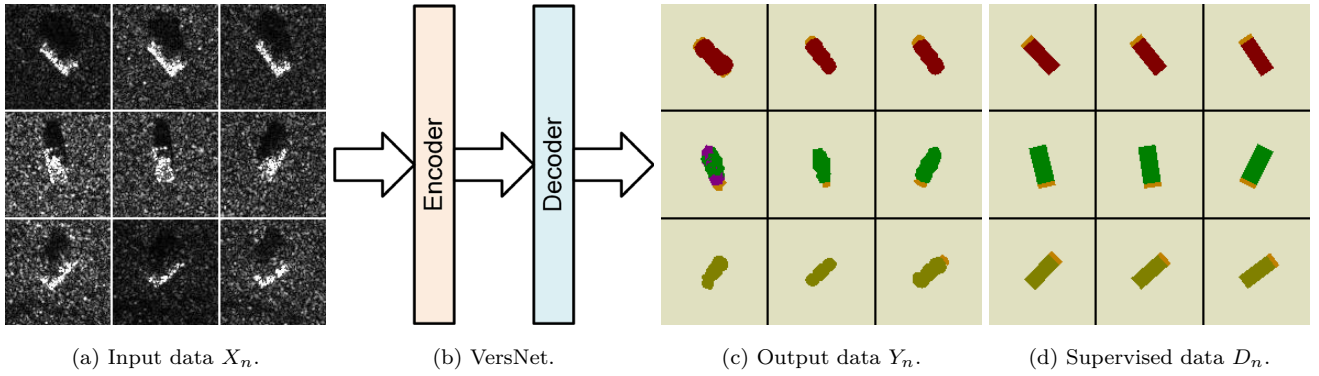

Fig. 2 Illustration of training for proposed CNN.

2. Related Work

In segmentation of image recognition giving classification label for each pixel of an image, methods using CNN [10]–[12] show a good performance in recent years. For SAR image, segmentation of a target region which reflected from a target, and a shadow region which not reflected from a target by radar shadow is performed. The CNN [13], WD-CFAR [14], and other methods [15]–[17] have been proposed for segmentation of a SAR image. The reference [18] describes manually generating the segmentation of target and shadow regions as ground truth. Generally, for segmentation using CNN, supervised learning is performed using label images corresponding to input images, but the difficulty of the generation of label images for SAR ATR is a problem for applying this method. In response to this problem, the reference [13] describes the CNN which trained to output a contour using the contour data of target and shadow regions generated by computer graphics as ground truth.

In contrast, our proposed CNN performs target detection, target classification, and pose estimation by segmentation.

3. Proposed Method

A proposed CNN named verification support network (VersNet) inputs an arbitrary size SAR image with multiple classes and multiple targets, and outputs the position, class, and pose of each detected target as a SAR ATR image.

Figure 1 shows the outline of VersNet for end-to-end SAR ATR. VersNet is a CNN composed of an encoder and a decoder. The encoder of VersNet extracts features from an input SAR image. The decoder converts the features based on the conversion rule in the training data and outputs it as a SAR ATR image.

Here, we define the end-to-end SAR ATR as a task of supervised learning. Let $\{(X_n, D_n), n = 1, \dots, N\}$ be the training dataset, where $X_n = \{x_i^{(n)}, i = 1, \dots, |X_n|\}$ is SAR image as input data, $D_n = \{d_i^{(n)}, i = 1, \dots, |D_n|, d_i^{(n)} \in \{1, \dots, N_c\}\}$

Table 1 Dataset. The training and testing data contain respectively 2747 and 2420 target chips from the MSTAR.

Class	Training data	Testing data
2S1	299	274
BMP2 (9563)	233	195
BRDM2	298	274
BTR60	256	190 ⁽¹⁾
BTR70	233	196
D7	299	274
T62	299	273
T72 (132)	232	196
ZIL131	299	274
ZSU234	299	274
Total	2747	2420

is label image for X_n , which is the supervised data of VersNet output data $Y_n = f(X_n; \theta)$. The values of $|X_n|$ and $|D_n|$ represent the number of pixels (vertical \times horizontal) of SAR and label image, respectively. When $d_i^{(n)}$ is 1, it represents a background class, and when $d_i^{(n)}$ is 2 or more, it indicates a corresponding target class. Let $L(\theta)$ be a loss function, the network parameters θ are adjusted using training data so that the output of loss function becomes small.

4. Experiments

4.1 Dataset

For training and testing of VersNet, we used the ten classes data shown in Table 1 from the MSTAR [5]. The dataset contains 2747 target chips with a depression angle of 17° for the training and 2420 target chips with a depression angle of 15° for the testing. As described later in Appendix 1, five target chips of target class BTR60 for testing data were excluded.

Of course, label images for segmentation do not exist in the MSTAR dataset. Therefore, we create label images for VersNet. Figure 2(d) shows samples of label images. The label images have all 12 classes: 10 target classes, a target front class, and a background class.

(1) : Five target chips were excluded. Appendix 1 shows the details.

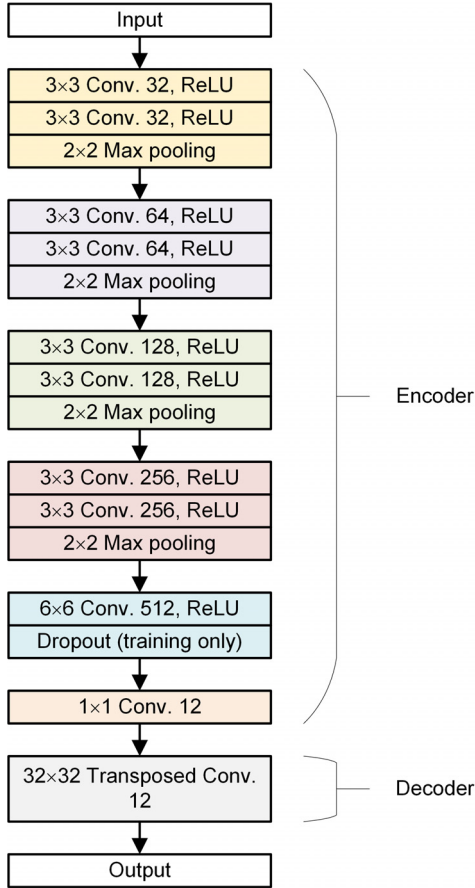

Fig. 3 Detail architecture of VersNet for experiments. The VersNet refers to the fully convolutional network called FCN-32s.

4.2 VersNet: Proposed CNN

Figure 3 shows a detailed architecture of VersNet for experiments. The encoder of the VersNet consists of four convolution blocks and two convolution layers. The convolution block contains two convolution layers of kernel size 3×3 and a pooling layer similarly to VGG [19]. The activation function of all convolutions except the final convolution uses rectified linear unit (ReLU) [20]. Dropout [21] is applied after a convolution of kernel size 6×6 . Batch normalization [22] is not applied. The decoder of the VersNet consists of a transposed convolution [23] that performs 16 times upsampling.

As the loss function, we use cross entropy expressed by

$$L(\theta) = - \sum_x p(x) \log q(x). \quad (1)$$

For the optimization of the loss function, we use stochastic gradient descent (SGD) with momentum.

Since the VersNet is a CNN without fully connected layers called fully convolutional network (FCN) [10], even if training is done with small size images, the VersNet can process SAR images of arbitrary size.

4.3 Classification Accuracy

First, we show results of classification accuracy.

Table 2 Classification accuracy of testing data. The overall accuracy is 99.55%.

Class	Accuracy (%)		
2S1	100.00		
BMP2	100.00		
BRDM2	98.54		
BTR60	98.42		
BTR70	98.98	Average	Overall
D7	100.00	99.52	99.55
T62	99.63		
T72	100.00		
ZIL131	99.64		
ZSU234	100.00		

Table 3 Definitions of TP, FP, FN, and TN.

Predicted \ True	Condition positive	Condition negative
	Condition positive	True positive (TP)
Condition negative	False negative (FN)	True negative (TN)

Table 2 shows classification accuracy for the target chips of testing if we simply select the majority class of maximum probability for each pixel from ten target classes as the predicted class. An average accuracy of ten target classes is 99.52%, and an overall accuracy is 99.55% (2409/2420), which is almost the same as a state-of-the-art accuracy. Also, Table A·2 of Appendix shows a confusion matrix for the target chips of testing.

4.4 Segmentation Performance

Next, we show results of segmentation performance.

We use precision, recall, F_1 , and intersection over union (IoU) as metrics of segmentation performance. Each metrics is given by

$$\text{Precision} = \frac{\text{TP}}{\text{TP} + \text{FP}}, \quad (2)$$

$$\text{Recall} = \frac{\text{TP}}{\text{TP} + \text{FN}}, \quad (3)$$

$$F_1 = 2 \cdot \frac{\text{precision} \cdot \text{recall}}{\text{precision} + \text{recall}}, \quad (4)$$

$$\text{IoU} = \frac{\text{TP}}{\text{TP} + \text{FP} + \text{FN}}, \quad (5)$$

where the definitions of TP, FP, FN, and TN are shown in Table 3.

Table 4 shows precision, recall, F_1 , and IoU for all the pixels of testing. The average IoU of all 12 classes and 10 target classes are 0.915 and 0.923, respectively. Also, Table A·3 of Appendix shows a confusion matrix for all the pixels of testing.

Figure 4 shows a histogram of IoU for each image with ten target classes. A mean and a standard deviation of the IoU are 0.930 and 0.082, respectively.

Table 4 Segmentation performance for all pixels of testing. The average IoU of ten target classes is 0.923.

Class	Precision	Recall	F_1	IoU
Background	0.997	0.999	0.998	0.996
2S1	0.970	0.953	0.961	0.925
BMP2	0.982	0.942	0.962	0.926
BRDM2	0.978	0.921	0.949	0.903
BTR60	0.984	0.935	0.959	0.921
BTR70	0.980	0.935	0.957	0.917
D7	0.968	0.954	0.961	0.924
T62	0.974	0.949	0.961	0.925
T72	0.978	0.962	0.970	0.941
ZIL131	0.967	0.953	0.960	0.923
ZSU234	0.955	0.966	0.960	0.924
Front	0.885	0.833	0.858	0.752
Average of 12 ⁽²⁾	0.968	0.942	0.955	0.915
Average of 10 ⁽³⁾	0.974	0.947	0.960	0.923

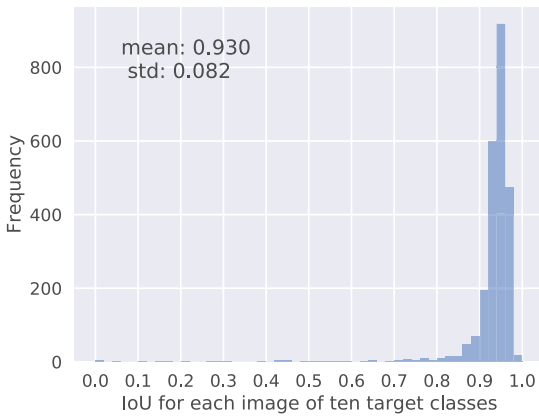

Fig. 4 Histogram of IoU.

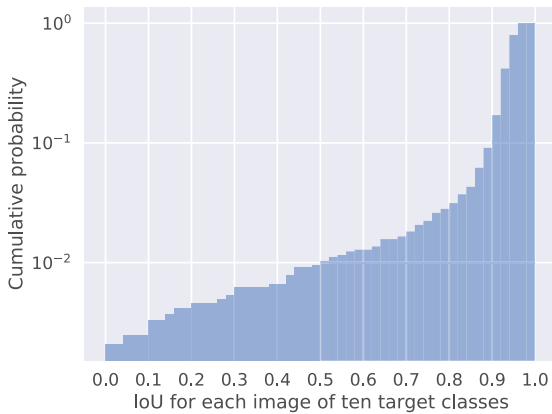

Fig. 5 Cumulative distribution of IoU.

Figure 5 shows a cumulative distribution of IoU for each image with ten target classes. The empirical cumulative distribution function $P(\text{IoU} \leq 0.5)$ and $P(\text{IoU} \leq 0.9)$ are about 0.01 and 0.1, respectively.

4.5 Multi-Class and Multi-Target

Finally, we show the VersNet output for multi-class and multi-target input.

Figure 6 shows input (SAR image of 10 target classes and 25 targets), output (SAR ATR image), and ground truth.

5. Conclusion

By applying CNN to the third stage classification in the standard architecture of SAR ATR, the performance has been improved. In order to improve the overall performance of SAR ATR, it is important not only to improve the performance of the third stage classification but also to improve the performance of the first stage detection and the second stage discrimination.

In this report, we proposed a CNN based on a new architecture of SAR ATR that consists of a single stage, i.e. end-to-end, not the standard architecture of SAR ATR. Unlike conventional CNNs for target classification, the CNN named VersNet inputs a SAR image of arbitrary sizes with multiple classes and multiple targets, and outputs a SAR ATR image representing the position, class, and pose of each detected target.

We trained the VersNet to output scores include ten target classes on MSTAR dataset and evaluated its performance. The average IoU for all the pixels of testing (2420 target chips) is over 0.9. Also, the classification accuracy is about 99.5%, if we select the majority class of maximum probability for each pixel as the predicted class.

References

- [1] A. Krizhevsky, I. Sutskever, and G.E. Hinton, “Imagenet classification with deep convolutional neural networks,” *Advances in neural information processing systems*, pp.1097–1105, 2012.
- [2] M.D. Zeiler and R. Fergus, “Visualizing and understanding convolutional networks,” *European conference on computer vision*, pp.818–833, 2014.
- [3] C. Szegedy, W. Liu, Y. Jia, P. Sermanet, S. Reed, D. Anguelov, D. Erhan, V. Vanhoucke, and A. Rabinovich, “Going deeper with convolutions,” *Proceedings of the IEEE conference on computer vision and pattern recognition*, pp.1–9, 2015.
- [4] K. He, X. Zhang, S. Ren, and J. Sun, “Deep residual learning for image recognition,” *Proceedings of the IEEE conference on computer vision and pattern recognition*, pp.770–778, 2016.
- [5] T. Ross, S. Worrell, V. Velten, J. Mossing, and M. Bryant, “Standard sar atr evaluation experiments using the mstar public release data set,” *Proc. SPIE*, vol.3370, pp.566–573, 1998.
- [6] S. Chen, H. Wang, F. Xu, and Y.Q. Jin, “Target classification using the deep convolutional networks for sar images,” *IEEE Transactions on Geoscience and Remote Sensing*, vol.54, no.8, pp.4806–4817, 2016.
- [7] S. Wagner, “Sar atr by a combination of convolutional neu-

(2) : The average of all 12 classes.

(3) : The average of ten target classes.

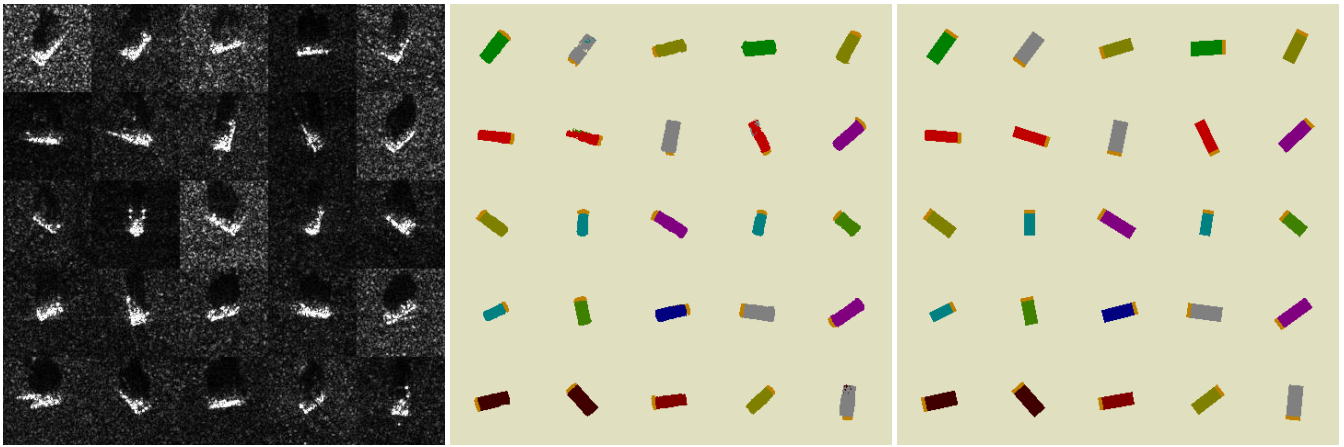

(a) Input (SAR image of 10 target classes and 25 targets).

(b) Output (SAR ATR image).

(c) Ground truth.

Fig. 6 Input (SAR image of multiple classes and multiple targets), output (SAR ATR image), and ground truth.

ral network and support vector machines,” IEEE Transactions on Aerospace and Electronic Systems, vol.52, no.6, pp.2861–2872, 2016.

- [8] Y. Zhong and G. Ettinger, “Enlightening deep neural networks with knowledge of confounding factors,” arXiv preprint arXiv:1607.02397, 2016.
- [9] H. Furukawa, “Deep learning for target classification from sar imagery: Data augmentation and translation invariance,” IEICE Tech. Rep., vol.117, no.182, SANE2017-30, pp.13–17, 2017.
- [10] J. Long, E. Shelhamer, and T. Darrell, “Fully convolutional networks for semantic segmentation,” Proceedings of the IEEE Conference on Computer Vision and Pattern Recognition, pp.3431–3440, 2015.
- [11] O. Ronneberger, P. Fischer, and T. Brox, “U-net: Convolutional networks for biomedical image segmentation,” International Conference on Medical Image Computing and Computer-Assisted Intervention, pp.234–241, 2015.
- [12] V. Badrinarayanan, A. Kendall, and R. Cipolla, “Segnet: A deep convolutional encoder-decoder architecture for image segmentation,” arXiv preprint arXiv:1511.00561, 2015.
- [13] D. Malmgren-Hansen and M. Nobel-J, “Convolutional neural networks for sar image segmentation,” 2015 IEEE International Symposium on Signal Processing and Information Technology (ISSPIT), pp.231–236, 2015.
- [14] S. Huang and T.Z. Wenzhun Huang, “A new sar image segmentation algorithm for the detection of target and shadow regions,” Scientific reports 6, Article number: 38596, 2016.
- [15] Y. Han, Y. Li, and W. Yu, “Sar target segmentation based on shape prior,” 2014 IEEE International Geoscience and Remote Sensing Symposium (IGARSS), pp.3738–3741, 2014.
- [16] E. Aitnouri, S. Wang, and D. Ziou, “Segmentation of small vehicle targets in sar images,” Proc. SPIE, vol.4726, no.1, pp.35–45, 2002.
- [17] R.A. Weisenseel, W.C. Karl, D.A. Castanon, G.J. Power, and P. Douville, “Markov random field segmentation methods for sar target chips,” Proc. SPIE, vol.3721, pp.462–473, 1999.
- [18] G.J. Power and R.A. Weisenseel, “Atr subsystem performance measures using manual segmentation of sar target chips,” Algorithms for Synthetic Aperture Radar Imagery VI, vol.3721, pp.685–692, 1999.
- [19] K. Simonyan and A. Zisserman, “Very deep convolutional networks for large-scale image recognition,” arXiv preprint

Table A.1 List of target chips excluded from testing data.

Class	Filename	Aspect angle (°)
BTR60	HB04999.003	299.48
BTR60	HB05631.003	302.48
BTR60	HB04933.003	303.48
BTR60	HB05000.003	304.48
BTR60	HB03353.003	305.48

arXiv:1409.1556, 2014.

- [20] V. Nair and G.E. Hinton, “Rectified linear units improve restricted boltzmann machines,” Proceedings of the 27th international conference on machine learning (ICML-10), pp.807–814, 2010.
- [21] N. Srivastava, G.E. Hinton, A. Krizhevsky, I. Sutskever, and R. Salakhutdinov, “Dropout: a simple way to prevent neural networks from overfitting,” Journal of Machine Learning Research, vol.15, no.1, pp.1929–1958, 2014.
- [22] S. Ioffe and C. Szegedy, “Batch normalization: Accelerating deep network training by reducing internal covariate shift,” International Conference on Machine Learning, pp.448–456, 2015.
- [23] V. Dumoulin and F. Visin, “A guide to convolution arithmetic for deep learning,” arXiv preprint arXiv:1603.07285, 2016.

Appendix

1. Excluded Target Chips from Testing Data

Table A.1 shows a list of target chips excluded from testing data. Figure A.1 shows inputs (target chips) and outputs (SAR ATR images) of the VersNet.

2. Confusion Matrix of Testing Data

Table A.2 shows a confusion matrix for the images (target chips) of testing, and Table A.3 shows a confusion matrix for all the pixels of testing. Each column in the confusion matrixes represents the actual target class, and each row represents the target class predicted by the VersNet.

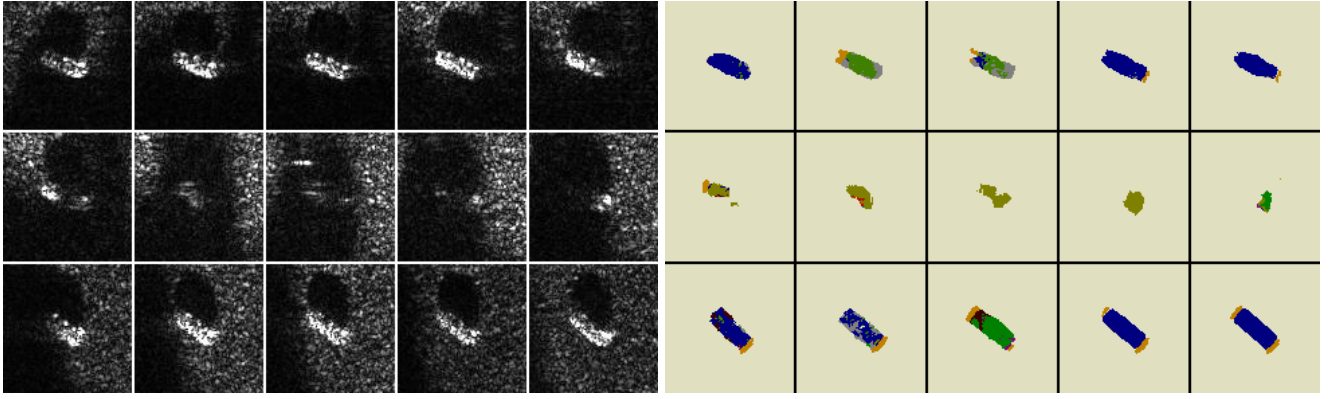

(a) Inputs (target chips of BTR60 with target aspect angle from 292° to 313°).

(b) Outputs (SAR ATR images).

Fig. A.1 Excluded target chips from testing data. As for the 2nd-row five target chips of inputs (a), the influence of the radar shadow of a certain other object appears strongly. The influence appears also in the outputs (b) of the VersNet.

Table A.2 Confusion matrix for images of testing.

Predicted \ True	True										
	2S1	BMP2	BRDM2	BTR60	BTR70	D7	T62	T72	ZIL131	ZSU234	
2S1	274	0	2	0	2	0	0	0	0	0	
BMP2	0	195	0	1	0	0	0	0	0	0	
BRDM2	0	0	270	0	0	0	0	0	0	0	
BTR60	0	0	0	187	0	0	0	0	0	0	
BTR70	0	0	0	0	194	0	0	0	0	0	
D7	0	0	0	0	0	274	0	0	0	0	
T62	0	0	0	1	0	0	272	0	0	0	
T72	0	0	0	0	0	0	0	196	0	0	
ZIL131	0	0	2	0	0	0	0	0	273	0	
ZSU234	0	0	0	1	0	0	1	0	1	274	
Accuracy (%)	100.00	100.00	98.54	98.42	98.98	100.00	99.63	100.00	99.64	100.00	
	Average 99.52										
	Overall 99.55										

Table A.3 Confusion matrix for all pixels of testing.

Predicted \ True	True												Precision
	Background	2S1	BMP2	BRDM2	BTR60	BTR70	D7	T62	T72	ZIL131	ZSU234	Front	
Background	21032341	4757	5013	7127	3808	5187	3308	5611	3535	4459	2907	20339	99.69
2S1	1646	124249	169	1071	0	602	0	71	0	89	0	209	96.99
BMP2	1080	5	99985	34	376	6	0	0	178	0	0	192	98.16
BRDM2	1947	109	119	113068	11	43	0	0	0	0	0	263	97.84
BTR60	1159	0	2	0	84603	7	0	0	0	12	0	191	98.41
BTR70	1758	0	0	0	23	97469	0	0	0	0	0	251	97.96
D7	2166	0	0	0	0	0	75195	15	0	9	3	301	96.79
T62	1877	775	0	20	714	0	0	140983	7	91	13	327	97.36
T72	1546	31	354	0	142	0	0	6	102533	0	0	202	97.82
ZIL131	2701	12	2	803	2	0	1	123	0	112804	1	193	96.71
ZSU234	2312	0	0	0	462	0	2	1161	16	309	96286	277	95.50
Front	9590	490	448	613	349	896	342	620	363	567	492	113784	88.51
Recall	99.87	95.26	94.24	92.12	93.49	93.53	95.37	94.88	96.16	95.32	96.57	83.34	
F ₁	99.78	96.12	96.16	94.90	95.89	95.69	96.07	96.10	96.98	96.01	96.03	85.85	
IoU	99.56	92.53	92.61	90.29	92.10	91.74	92.44	92.50	94.14	92.33	92.37	75.20	