

# A complete topological classification of Morse-Smale diffeomorphisms on surfaces: a kind of kneading theory in dimension two

V. Z. Grines\*, O. V. Pochinka†, S. van Strien‡

23 Nov 2017

## Abstract

In this paper we give a complete topological classification of orientation preserving Morse-Smale diffeomorphisms on orientable closed surfaces. For MS diffeomorphisms with relatively simple behaviour it was known that such a classification can be given through a directed graph, a three-colour directed graph or by a certain topological object, called a ‘scheme’. Here we will assign to any MS surface diffeomorphism a finite amount of data which completely determines its topological conjugacy class. Moreover, we show that associated to any abstract version of this data, there exists a unique conjugacy class of MS orientation preserving diffeomorphisms (on some orientation preserving surface). As a corollary we obtain a different proof that nearby MS diffeomorphisms are topologically conjugate.

**Key words:** Morse-Smale diffeomorphism, topological classification

**Bibliography:** 56 names.

## Contents

<b>1</b>	<b>Informal statement of the results</b>	<b>2</b>
<b>2</b>	<b>History of the problem of classifying MS diffeomorphisms</b>	<b>6</b>
2.1	Classification of gradient-like diffeomorphisms on surfaces . . . . .	9
2.2	Classification of non-gradient-like diffeomorphisms on closed surfaces . . . . .	16

---

\*National Research University Higher School of Economics, vgrines@yandex.ru

†National Research University Higher School of Economics, olga-pochinka@yandex.ru

‡Imperial College London, s.van-strien@imperial.ac.uk

<b>3</b>	<b>The scheme of a MS surface diffeomorphism is a complete invariant</b>	<b>18</b>
3.1	Maximal $u$ -compatible system of linearizing neighborhoods: statement of Theorem 1 . . . . .	19
3.2	Associating a scheme to a Morse-Smale surface diffeomorphism . . . . .	21
3.3	Schemes are complete invariants: statement of Theorem 2 . . . . .	24
3.4	Examples of schemes associated to gradient MS-diffeomorphisms . . . . .	24
3.5	Examples of schemes associated to non-gradient MS-diffeomorphisms . . . . .	26
<b>4</b>	<b>The decomposed scheme and realising abstract versions of such schemes by MS diffeomorphisms</b>	<b>27</b>
4.1	The decomposed scheme of a MS diffeomorphism and the statement of Theorem 2' . . . . .	29
4.2	Cut & paste operations and examples of decomposed schemes . . . . .	30
4.3	Abstract decomposed schemes defined through model objects . . . . .	34
4.4	Realisability of any abstract decomposed scheme: statement of Theorem 3 . . . . .	40
4.5	Examples of realizable abstract decomposed schemes and their realisations . . . . .	41
<b>5</b>	<b>Proof of Theorem 1: maximal systems of neighbourhoods</b>	<b>45</b>
<b>6</b>	<b>Proof of Theorem 2: classifying diffeomorphisms</b>	<b>50</b>
<b>7</b>	<b>Proof of Theorem 3: realizing diffeomorphisms</b>	<b>54</b>

## 1 Informal statement of the results

One of the main objectives in the field of dynamical systems is to obtain a classification in terms of their dynamics. Such a classification was achieved successfully in the one-dimensional setting. For example, two circle diffeomorphisms  $f, f' : S^1 \rightarrow S^1$  are called topologically conjugate if there exists an orientation preserving homeomorphism  $h : S^1 \rightarrow S^1$  so that  $hf = fh$ . In the 1880's, Poincare [42] showed that if these two diffeomorphisms are topologically conjugate then they have the same rotation number. Moreover, for two transitive homeomorphisms  $f, f'$  the condition that their rotation numbers are the same is both necessary and sufficient for the topological conjugacy. In 1932, Denjoy [14] improved this result by showing that if the diffeomorphism  $f$  is  $C^2$  and have no periodic orbits then it is transitive.

If two circle diffeomorphisms have periodic orbits and each of these periodic orbits is hyperbolic (such a diffeomorphism is called *Morse-Smale*), then a necessary and sufficient condition for these circle diffeomorphisms to be topologically conjugate is that their rotation numbers are the same and that they have the same number of periodic attractors. Moreover, if one chooses a rotation compatible permutation on a finite number of points on the circle, then this data corresponds to a Morse-Smale diffeomorphism. For *non-invertible* Morse-Smale maps of the circle or the interval one has a similar situation: it's so-called *kneading map* (describing itineraries of its turning points) is (essentially) a complete topological invariant and, moreover, each admissible kneading map corresponds to a map of the circle.

The *aim* of this paper is to establish a corresponding classification in the setting of Morse-Smale diffeomorphisms on *closed orientable surfaces*, replacing a finite number of points on a circle by a finite number of annuli on tori. In Section 3 we will state our results precisely, and define the notion of a ‘scheme’ and ‘decomposed scheme’, but *informally speaking* (see Figure 1) we have

**Theorem A (Classification by finite amount of data)** *Let  $M$  be a closed orientable surface and  $f: M \rightarrow M$  be an orientation preserving Morse-Smale diffeomorphism. Then one can assign to  $f$  a **scheme**  $S_f$  or a **decomposed scheme** consisting of a **finite amount data** (given by a finite union of tori, and the homotopy type of certain annuli in these tori), in such a way that  $f: M \rightarrow M$  and  $f': M' \rightarrow M'$  are topologically conjugate if and only if  $S_f$  is equivalent to  $S_{f'}$ .*

**Theorem B (Realisation)** *Each abstract scheme  $S$  corresponds uniquely to an orientable closed surface  $M$  and an orientation preserving Morse-Smale diffeomorphism  $f: M \rightarrow M$ .*

For a formal statement of these results, see Theorems 2 and 2’ in Subsections 3.3,4.1 and Theorem 3 in Subsection 4.4.

Notice that Theorem A implies immediately that Morse-Smale diffeomorphisms on surfaces are structurally stable, providing an ‘alternative’ proof to the one given by Palis in [33], see the corollary below Theorem 2. Of course when two maps are not close to each other, it can be hard to determine whether they are conjugate in the same way as it is not immediately obvious whether two knots in  $\mathbb{R}^3$  are the same.

Theorem A shows that two Morse-Smale diffeomorphisms are topologically conjugate if and only if their schemes are the same. For this reason we say that the scheme is a *complete invariant*. Crucially, we show that the scheme requires only finite data.

Theorem B shows that each “abstract” admissible scheme corresponds to an actual Morse-Smale diffeomorphism in the same way as each rotation number together with some additional information (about the number of periodic orbits) corresponds to circle diffeomorphism (uniquely, up to conjugacy), and the same way as every admissible kneading invariant can be “realised” within a smooth full family of interval maps, see Section II.4 in [28]. In the same way Theorem B provides a *full catalogue* of *all* Morse-Smale surface diffeomorphisms.

In this way we suggest that the scheme of a MS surface diffeomorphism should be regarded as the analogue of the rotation number for a MS circle diffeomorphism and of the kneading invariant of a MS interval map.

Here, as usual, we define a  $C^1$  interval or circle map  $f$  to be *Morse-Smale*, and say that  $f \in MS([0, 1])$  or  $f \in MS(S^1)$ , if  $f$  has only finitely many critical and periodic points, if each of its periodic points has multiplier  $\lambda \notin \{0, 1, -1\}$  and if no critical point of  $f$  is eventually mapped onto a critical or periodic point or to an iterate of another critical point (these latter assumptions are the analogue of transversality of invariant manifolds in the two-dimensional case).

**Remark 1.** A  $C^1$  map in  $MS([0, 1])$  is *not* necessarily structurally stable since a nearby diffeomorphism can have additional critical points. To obtain structural stability, we need to consider

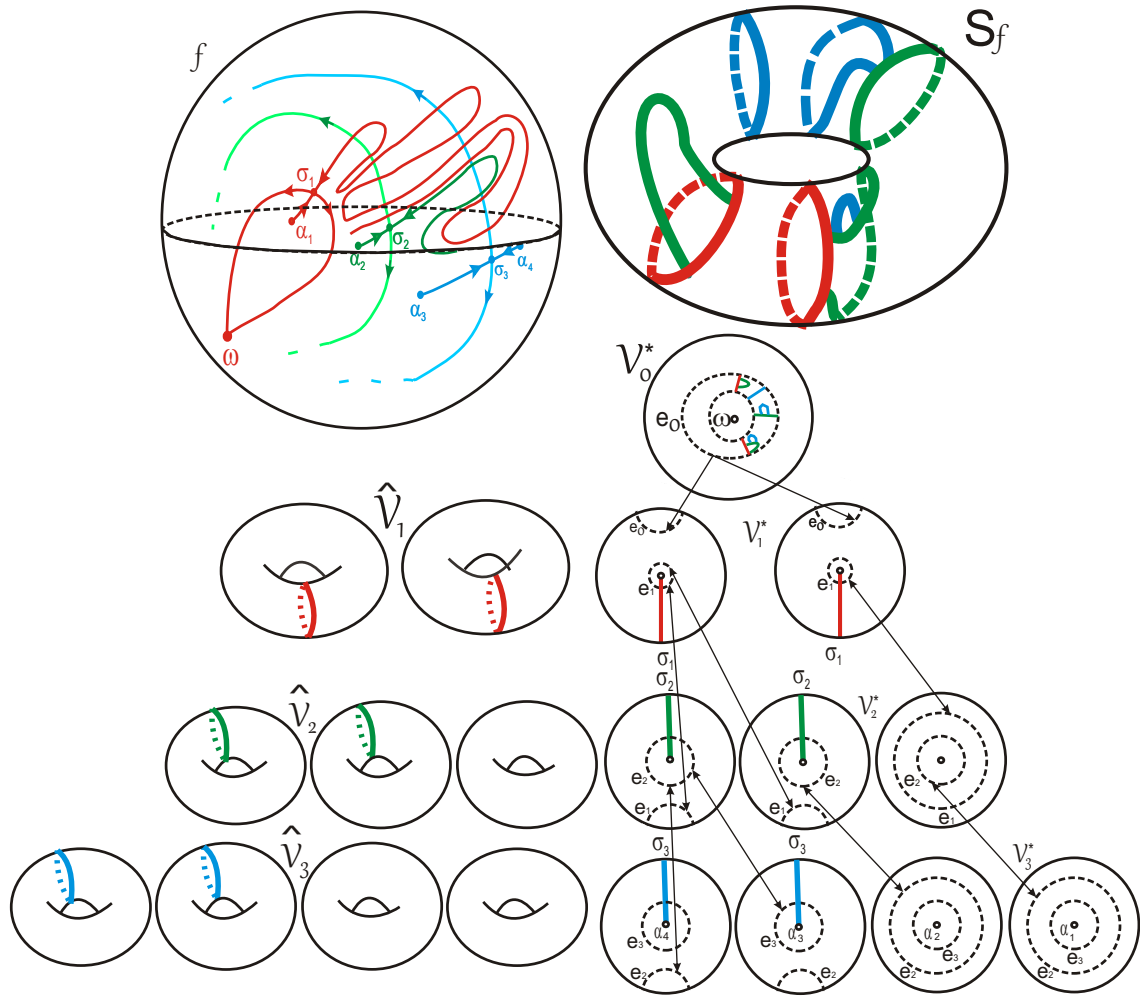

Figure 1: Theorem A gives a complete topological invariant for a Morse-Smale diffeomorphism  $f$  on the 2-sphere (drawn on the top left) by its scheme  $S_f$  (on the top right) and its decomposed scheme (depicted in the remaining figures), while Theorem B describes all possible Morse-Smale diffeomorphisms. This picture and the notions of a scheme and a decomposed scheme will be explained in Subsection 3.

the space of  $C^2$  endomorphisms, and make the additional assumption that each critical point is non-degenerate.

The analogy between the one-dimensional and two-dimensional case we are referring to is summarised in the following table:

	complete invariant (finite data)	realisation
MS circle diffeomorphism	rational rotation number + finite data	no additional conditions
MS interval map	kneading invariant + finite data	admissibility condition
MS surface diffeomorphism	scheme	admissibility condition

The analogy between the classification of MS interval and surface maps.

Indeed, for a MS circle diffeomorphism, the rotation number and the number  $\geq 1$  of periodic attractors is a complete invariant; moreover, given to this abstract data corresponds a Morse-Smale diffeomorphism (unique up to conjugacy). For piecewise monotone interval maps  $f$ , the analogue of the rotation number is the kneading invariant, defined as follows. Let  $c_1 < c_2 < \dots < c_d$  be the turning points of  $f$ , and let  $I_0, \dots, I_d$  be the components of  $I \setminus \{c_1, \dots, c_d\}$  numbered so that  $c_i \in \partial I_i \cap \partial I_{i-1}$ ,  $i = 1, \dots, d$ . Then associate to each  $c_i$ , the sequence defined by  $K(c_i) = I_{i_1} I_{i_2} I_{i_3} \dots \in \{I_1, \dots, I_d\}^{\mathbb{N}^+}$  where  $i_k$  is so that  $f^k(c_i) \in I_{i_k}$  for  $k \geq 1$ . The *kneading invariant* of  $f$  is by definition  $K(c_1), \dots, K(c_d)$  (there are other more or less equivalent definitions, see [28]). Since the kneading invariant does not detect the number of periodic attractors of  $f$  additional data is required to obtain a complete invariant. For this reason we will follow a slightly different approach.

Let  $N \in \mathbb{N} \cup \{\infty\}$  and define the finite set

$$P_f^N = \bigcup_{c \in C} \bigcup_{k=0}^N f^k(c) \cup \text{Per}_f^A \text{ where } \text{Per}_f^A = \{\text{attracting periodic points of } f\}.$$

The next (essentially well-known) theorem shows that there exists  $N < \infty$  so that the conjugacy class of  $f$  is fully determined by the finite set  $P_f^N$  together with how  $f$  acts on this set. Much of this can be expressed by the kneading invariant defined above, but the set  $P_f^N$  is more helpful in this context.

**Theorem** (Classification in the one-dimensional case). For each  $f \in MS([0, 1])$  there exists  $N$  so that  $g \in MS([0, 1])$  is topological conjugate with  $f$  if and only if there exists an order preserving bijection between  $P_f^N$  and  $P_g^N$  so that  $h \circ f(x) = g \circ h(x)$  for each  $x \in P_f^{N-1}$ .

*Proof.* We say an interval  $K$  is a renormalisation interval of period  $n$ , if  $K, f(K), \dots, f^{n-1}(K)$  have disjoint interiors,  $f^n(K) \subset K$  and  $f^n(\partial K) \subset \partial K$ . To prove this theorem, we need to use the following claim (whose prove can be found in [28][Proposition III.4.2]). **Claim:** for each  $x \in [0, 1]$  there exist  $n \geq 0$  and a renormalisation interval  $K$  of period 2, so that either (a)  $f^n(x)$  is a fixed point  $p$ , (b)  $f^k(x) \rightarrow p$  as  $k \rightarrow \infty$  where  $p$  is an attracting fixed point or (c)  $f^n(x) \in K$ . The assertion implies in particular that  $f \in MS([0, 1])$  can only have (finitely many) periodic points of periods of the form  $\{1, 2, \dots, 2^b\}$ .

For each periodic attractor  $p$ , take an interval  $J = J_p$  with  $p \in J \in W^s(p)$  so that if  $m$  is the period of  $p$  then  $f^{2m}|_J$  is orientation increasing. Since  $f \in MS([0, 1])$  the previous claim implies that each critical point is in the basin of an attracting periodic point. Hence one can choose  $N < \infty$  so that if  $c, c' \in W^s(p) \cap C(f)$  (where  $p$  is a periodic attractor of period  $m$ ) then there exists  $n, n' \leq N - 2m$  so that  $f^n(c), f^{n'}(c') \in J$ . One can arrange is so that if  $f^m|_J$  is orientation preserving and  $f^n(c), f^{n'}(c')$  lie on the same side of  $p$  then  $f^{n'}(c')$  lies between  $f^n(c)$  and  $f^{n+2m}(c)$  whereas if  $f^m|_J$  is orientation reversing then  $f^{n'}(c')$  lies between  $f^n(c)$  and  $f^{n+2m}(c)$ .

If  $g \in MS([0, 1])$  and there exists an order preserving bijection  $h$  between  $P_f^N, P_g^N$  then from the choice of  $N$ , if  $c, c' \in W^s(p)$  then there exists  $n, n' \leq N$  so that  $f^n(c), f^{n'}(c)$  lie in the same fundamental domain of  $p$ . It follows that one can extend  $h$  to an order preserving bijection between  $P_f^\infty, P_g^\infty$ . Since  $f, g$  do not have (i) wandering intervals (this follows from the previous

claim), (ii) intervals consisting of periodic points of constant period, (iii) periodic turning points which are not attracting (since  $f$  is  $C^1$  and  $f \in MS([0, 1])$ ), it follows by [28][Theorem II.3.1] that  $f, g$  are topologically conjugate.  $\square$

Conversely, one can derive from [28][Theorem II.5.2], that given (abstract) finite sets  $P' \subset P \subset [0, 1]$  and  $\pi: P' \rightarrow P$  with some additional other admissibility conditions, there exists a  $C^\infty$  MS interval map  $f$  so that  $P_f^{N-1} = P'$  and  $P_f^N = P$  and so that  $f|_{P'} = \pi$ . So this is the analogue of Theorem B in the interval case.

Before giving formal statements of theorems A and B, we will give a historical background of this classification problem, see also the survey [8] by Bonatti, Grines, Langevin for further details and references.

*Acknowledgements.* This work was supported by the Russian Foundation for Basic Research (project 16-51-10005-Ko\_a), Russian Science Foundation (project 17-11-01041), the Basic Research Program at the HSE (project 90) in 2017 and the European Union ERC AdG grant 339523 RGDD.

## 2 History of the problem of classifying MS diffeomorphisms

**Topological equivalence, roughness and structural stability.** The concept of *roughness* of a dynamical system was conceived in Nizhny Novgorod (formerly known as Gorky) in 1937. Andronov and Pontryagin considered a dynamical system

$$\dot{x} = v(x), \quad (1)$$

where  $x \in \mathbb{R}^2$  and  $v$  is a  $C^1$ -vector field defined in closed compact domain  $D \in \mathbb{R}^2$  bounded by a smooth curve  $\partial D$  without selfintersections transversal to  $v$ . They suggested to call  $v$  *rough* if for any sufficiently small  $C^1$ -perturbation of  $v$  there exists a homeomorphism  $C^0$  close to the identity which transforms the orbits of the original dynamical system to the orbits of the perturbed system (so the perturbed system is *topologically equivalent* to the original one, and the topological equivalence is close to the identity).

In [1], they showed that for such a dynamical system roughness is equivalent to the following two properties:

- 1) the number of the equilibrium points and periodic trajectories is finite and each of these is hyperbolic;
- 2) there are no saddle connections (that is stable and unstable separatrices of any saddle equilibrium state  $p$  and of any pairs of different saddle equilibrium states  $p$  and  $q$  have no intersections).

The *topological classification* (w.r.t. topological equivalence) of structurally stable *flows* (dynamical systems with continuous time) on a bounded part of the plane and on the 2-sphere follows from the results by Leontovich-Andronova and Mayer obtained in [24] and [25]. In fact,

in these papers a more general class of dynamical systems was considered. The classification was based on the ideas of Poincare-Bendixson to pick a set of specially chosen trajectories so that their relative position (the *Leontovich-Mayer scheme*) fully determines the qualitative decomposition of the phase space of the dynamical system into the trajectories.

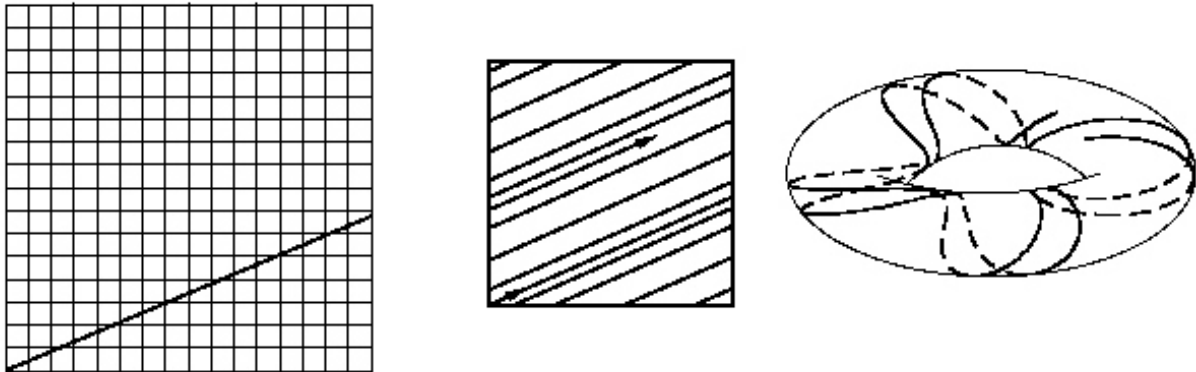

Figure 2: Irrational winding of the torus

The principal difficulty in generalising this result to flows on arbitrary orientable surfaces of positive genus is the possibility of new types of trajectories, namely *non-closed recurrent trajectories* (see Figure 2, where the natural projection of a straight line with an irrational slope on  $\mathbb{R}^2$  to the torus  $\mathbb{T}^2$  is shown, which can be a recurrent trajectory of some flow on  $\mathbb{T}^2$ ). The absence of such trajectories for structurally stable flows without singularities on the 2-torus was first proved by Mayer in 1939 [27]. Actually, in this paper he introduced the notion of roughness for *cascades* (i.e., discrete dynamical systems corresponding to  $C^1$  diffeomorphisms) on the *circle* and found necessary and sufficient conditions for the roughness these cascades: rough diffeomorphisms of the circle are exactly those that have a finite number of hyperbolic periodic points.

In 1959, Peixoto [36] introduced the concept of *structural stability* of flows to generalize the concept of roughness. A flow  $f^t$  is called *structurally stable* if for any flow  $g^t$  which is  $C^1$ -sufficiently close to  $f^t$ , there exists a homeomorphism  $h$  sending trajectories of  $g^t$  to trajectories of  $f^t$ . The original definition of a rough flow involved the additional requirement that the homeomorphism  $h$  is  $C^0$ -close to the identity map. Peixoto proved that the concepts of roughness and structural stability for flows on surfaces are equivalent. In 1962, Peixoto [37, 38] proved that the conditions 1), 2) above plus condition

- 3) all  $\omega$ - and  $\alpha$ -limit sets are contained in the union of the equilibrium points and the periodic trajectories,

are necessary and sufficient for the structural stability of a flow on any arbitrary orientable closed (i.e., compact and without boundary) surface and showed that such flows are dense in the space of all  $C^1$ -flows.

**Morse-Smale systems in arbitrary dimensions.** In 1960, Smale [45] introduced a class of diffeomorphisms on manifolds, generalising the above Andronov-Pontryagin-Peixoto conditions

(1), (2), (3) to the case of diffeomorphism in arbitrary dimensions, requiring that (i) there are at most a finite number of all periodic points, (ii) each periodic orbit is hyperbolic, and (iii) that each intersection of stable and unstable manifolds is transversal. This class of systems was also inspired by Smale's earlier work on the Poincaré conjecture for manifolds of dimension  $\geq 5$ , [48, 50], in which he made essential use of Morse theory and vector fields generated by the gradient of Morse functions. Since then flows and diffeomorphisms with these properties are called *Morse-Smale systems*. Until Smale discovered horseshoe maps, he even assumed that this class of systems is generic.

A natural question is the *existence* of Morse-Smale systems on closed manifolds. Smale [49] proved that any Morse function on the manifold can be approximated by a Morse function whose gradient vector field is a Morse-Smale flow without periodic orbits. Therefore the time-one map of this flow is a Morse-Smale diffeomorphism. Since Morse functions exist on any closed manifold, it follows that Morse-Smale systems (both flows and diffeomorphisms) exist on any closed manifold.

In the late 1960's, Palis [33] and Palis and Smale [35] proved that Morse-Smale systems are structurally stable. Therefore, these systems form an open set in the space  $C^1$ -smooth dynamical systems. From a modern point of view, Morse-Smale systems on closed manifolds, in the  $C^1$  setting, are exactly the structurally stable dynamical systems with zero topological entropy. (This holds because by Mañé [26] any  $C^1$  structurally stable system is Axiom A and satisfies the strong transversality condition, and since an Axiom A system with zero topological entropy necessarily has only a finite number of periodic orbits by [13].) From this point of view, they are the simplest structurally stable systems. Anosov [2, 3] and Smale [51, 52, 53] proved the existence of wide classes of structurally stable dynamical systems with positive topological entropy.

Already in the pioneering work [45], Smale established a close relationship between the dynamic characteristics of the Morse-Smale system and the topology of the ambient manifold. Later it was found that the periodic orbits of Morse-Smale flows without equilibrium states, form a rather special set of *knots and links*, see Franks [15], Sullivan [54], Wada [56]. Nevertheless, Morse-Smale vector fields on compact manifolds always have an energy function, as was shown by Meyer [29]. (By definition, an *energy function* for a system is a Morse-Bott function which decreases along non-periodic orbits and has critical points only at periodic orbits.) Pixton [40] showed that this is not true for Morse-Smale diffeomorphisms, namely he proved that for any Morse-Smale diffeomorphism given on a compact surface there is an energy function and that there is an example of a Morse-Smale diffeomorphism on  $S^3$  which has no an energy function. Later on, it was shown by Bonatti, Grines, Pixton, Pochinka [7, 40, 41] that there exist Morse-Smale diffeomorphisms in dimension three for which the invariant manifolds of saddle points form wild objects, and hence do not have an energy function. Grines, Laudenbach and Pochinka, see [19], established necessary and sufficient conditions for the existence of an energy function for Morse-Smale diffeomorphisms on 3-manifolds.

Morse-Smale diffeomorphism which are time-one maps of a flow, obviously induce the identity map in the homology group, which begs the question whether Morse-Smale diffeomorphisms can induce non-trivial isomorphisms in the homology group. The answer is yes, as is easy to see. First, take for example the time-one map of the gradient vector field on the torus  $T^2$  with



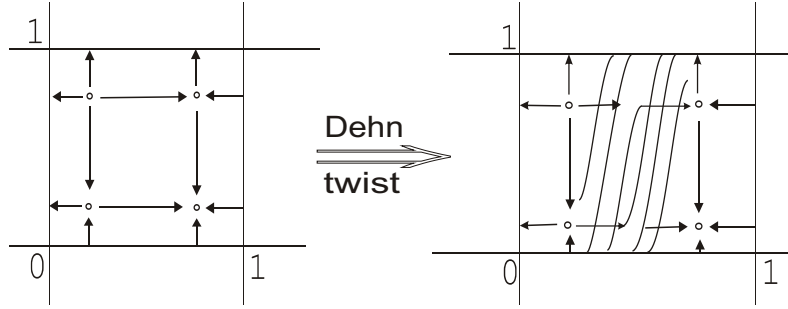

Figure 3: A Dehn twist to a Morse-Smale system on  $T^2$

two saddles and two nodes on the square, see the left side of Figure 3. Adding a Dehn twist along the closed curve corresponding to  $x = \frac{1}{2}$  we get a diffeomorphism whose stable manifold of the first saddle transversely intersects the unstable manifold of the other saddle, see the right side of Figure 3, and whose action on the homology group is non-trivial. However, the action has a special form: for arbitrary Morse-Smale diffeomorphism  $f : M^d \rightarrow M^d$  all eigenvalues of the induced map  $f_* : H_*(M^d, \mathbb{R}) \rightarrow H_*(M^d, \mathbb{R})$  are roots of unity, see works [46, 47] by Shub and Sullivan.

A Dehn twist operation not only leads to a non trivial action in the homology group but also gives rise to *heteroclinic points*, i.e., points of intersection of stable and unstable manifolds of different saddle points. A Morse-Smale diffeomorphism on a closed surface is called *gradient-like* if it has no heteroclinic points. Heteroclinic points are an obstruction to the embedding of such a diffeomorphism to a flow. Palis [33] proved that in any neighborhood of the identity map of the surface there is a Morse-Smale diffeomorphism which cannot be embedded in a flow. Moreover he listed necessary conditions for a diffeomorphism to be embedded in a flow, proved that these conditions are sufficient for Morse-Smale diffeomorphisms on surfaces and posed the problem for higher dimensions. Grines, Gurevich and Pochinka, see [17], solved this problem for Morse-Smale diffeomorphisms on 3-manifolds.

## 2.1 Classification of gradient-like diffeomorphisms on surfaces

In this subsection we describe previous approaches to classify special dynamical systems on surfaces namely for Morse-Smale flows and for gradient-like diffeomorphisms.

**A directed graph associated to Morse-Smale flows on surfaces.** In 1971, Peixoto [39] obtained the classification for Morse-Smale flows on arbitrary surfaces. He did this by generalizing the Leontovich-Mayer scheme for such flows to a *directed graph* whose vertices are in one-to-one correspondence with fixed points and closed trajectories of the flow, and whose edges correspond to the connected components of the invariant manifolds of fixed points and closed trajectories (see Figure 4). He proved that the isomorphic class of such directed graph is a complete topological invariant for Morse-Smale flows on surfaces (where the isomorphisms preserve specially chosen subgraphs).

However, in 1998, Oshemkov and Sharko [32] pointed out that the Peixoto invariant is unfortunately not complete, by giving an example showing that an isomorphism of graphs cannot always distinguish between types of decompositions into trajectories for a domain bounded by two periodic orbits of the flow. Thus they show that Peixoto's directed graph does not necessarily distinguish non-equivalent systems. They therefore suggested to use a *three-colour graph*, see Figure 4, where vertices correspond to triangular domains and the color ( $s, t, u$ ) of an edge corresponds to passing through a side of triangles of the same color. They also showed that this colour graph is a complete invariant. In the next subsection we will explain how such three-colour graphs are obtained.

The construction of the directed and three-colour graphs for Morse-Smale flows is very similar to the construction of similar graphs for gradient-like diffeomorphisms below.

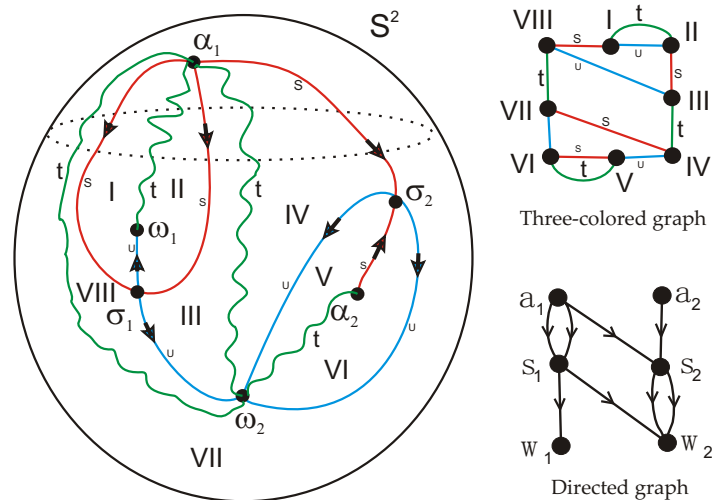

Figure 4: The directed and three-colour graphs for a gradient-like diffeomorphism on a 2-sphere, see Subsection 2.1. The regions marked in roman numbers correspond to vertices in the three color graph, while the stable and unstable manifolds and the curves marked by  $t$ , correspond to its edges. The singularities  $\alpha_i, \sigma, \omega_i$  correspond to the vertices  $a_i, s_i, w_i$  in the graph.

**Directed, equipped and three colour graphs associated to gradient-like Morse-Smale diffeomorphisms on surfaces.** As before we say that a Morse-Smale diffeomorphism on a closed surface is called *gradient-like* if it has no heteroclinic points. In 1985, Bezdenezhnych and Grines [5, 6] showed that for gradient-like diffeomorphisms on surfaces a directed graph with an automorphism is again a complete invariant. In 2014, Grines, Kapkaeva and Pochinka [18], showed that two gradient-like diffeomorphisms on a surface are topologically conjugate if and only if their three-colour graphs equipped by periodic automorphisms are isomorphic (Grines, Malyshev, Pochinka and Zinina [20] describe an efficient algorithm for distinguishing such graphs). Let us describe the above graphs in more detail.

Let  $f$  be a gradient-like diffeomorphism of an orientable surface  $M^2$ . Let  $\sigma$  be a saddle point of  $f$  of period  $m_\sigma$ . Denote by  $\nu_\sigma$  the *type of orientation of  $\sigma$* , which is 1 if the diffeomorphism

$f^{m_\sigma}|_{W_\sigma^u}$  preserves orientation and  $-1$  otherwise. Let  $l_\sigma^s$  ( $l_\sigma^u$ ) be a stable (unstable) separatrix of  $\sigma$ , i.e.,  $l_\sigma^s$  ( $l_\sigma^u$ ) is a connected component of  $W_\sigma^s \setminus \sigma$  ( $W_\sigma^u \setminus \sigma$ ). Since  $l_\sigma^s$  ( $l_\sigma^u$ ) does not intersect the unstable (stable) manifold of any saddle point, there exists a sink  $\omega$  (respectively, a source  $\alpha$ ) such that  $cl(l_\sigma^u) = l_\sigma^u \cup \sigma \cup \omega$  (respectively,  $cl(l_\sigma^s) = l_\sigma^s \cup \sigma \cup \alpha$ ); see, for example, Lemma 3.2.1 in the monograph [21] by Grines, Pochinka. For  $\delta \in \{s, u\}$  we define the direction of the separatrix  $l_\sigma^\delta$  to be towards the saddle point if  $\delta = s$  and from the saddle point if  $\delta = u$ .

We say that a *directed graph*  $\Gamma_f$  is the graph of a diffeomorphism  $f$ , see Figure 4, if

- 1) the *vertices* of the graph  $\Gamma_f$  correspond to the periodic points of the non-wandering set  $\Omega_f$ ; the vertex corresponding to the saddle periodic point  $\sigma$  we equip with the value  $\nu_\sigma$ ;
- 2) the *directed edges* of the graph  $\Gamma_f$  correspond to the directed separatrices of the saddle points.

The diffeomorphism  $f$  naturally induces an automorphism  $f_*$  of the graph  $\Gamma_f$ . Let  $\Gamma_f, \Gamma_{f'}$  be the graphs of diffeomorphisms  $f, f'$ . The existence of an isomorphism between the graphs  $\Gamma_f$  and  $\Gamma_{f'}$  conjugating the automorphisms  $f_*$  and  $f'_*$  is necessary for the topological conjugacy of the diffeomorphisms  $f, f'$ . Unfortunately, in general the existence of an isomorphism of the graphs is not sufficient for the maps  $f, f'$  to be conjugacy even if every periodic point is a fixed point and each separatrix is  $f$ -invariant. Indeed, consider diffeomorphisms  $f$  and  $f'$  with phase portraits shown in Figure 5. Even though these diffeomorphisms have isomorphic graphs, they are not topologically conjugate. To see this, notice that any conjugating homeomorphism necessarily carries the basin of the sink  $\omega$  of the diffeomorphism  $f$  into the basin of the sink  $\omega'$  of the diffeomorphism  $f'$ . However, such a homeomorphism cannot be extended to the entire sphere in such a way that it would carry the invariant manifolds of the saddle points of  $f$  into the invariant manifolds of the saddle points of  $f'$ .

So the directed graph  $\Gamma_f$  of a diffeomorphism  $f$  does not determine the topological conjugacy class of  $f$ , and we are required to add information to  $\Gamma_f$ . To obtain a complete classification for gradient-like diffeomorphisms on surfaces, Bezdenezhnykh and Grines [5, 6] introduced in 1985 the notion of *equipped graphs*. Such equipped graphs can be defined as follows. Let  $\omega$  be a sink of  $f$  and let  $L_\omega$  be the subset of the manifold  $M^2$  that consists of the separatrices which have  $\omega$  in their closures. Then there is a smooth 2-disk  $B_\omega$  such that  $\omega \in B_\omega$  and each separatrix  $l \subset L_\omega$  intersects  $\partial B_\omega$  at a unique point; see, for example, [21, Proposition 2.1.3]. For the vertex  $w$  corresponding to the periodic sink point  $\omega$ , let  $E_w$  denote the set of edges of the directed graph  $\Gamma_f$  incident to  $w$ . Let  $N_w$  denote the cardinality of the set  $E_w$ . We enumerate the edges of the set  $E_w$  in the following way. First we pick in the basin of the sink  $\omega$  a 2-disk  $B_\omega$  and set  $c_\omega = \partial B_\omega$ . We define a pair of vectors  $(\vec{\tau}, \vec{n})$  at some point of the curve  $c_\omega$  in such a way that the vector  $\vec{n}$  is directed inside the disk  $B_\omega$ , the vector  $\vec{\tau}$  is tangent to the curve  $c_\omega$  and induces a counterclockwise orientation on  $c_\omega$  with respect to  $B_\omega$  (we call this orientation positive). Enumerate the edges  $e_1, \dots, e_{N_w}$  from  $E_w$  according to the ordering of the corresponding separatrices as we move along  $c_\omega$  starting from some point on  $c_\omega$ . This enumeration of the edges of the set  $E_w$  is said to be *compatible* with the embedding of the separatrices.

The graph  $\Gamma_f$  is said to be *equipped* if each vertex  $w$  is numbered with respect to the numeration of the edges of the set  $E_w$  and the numeration is compatible with the embedding of the separatrices. We denote such a graph by  $\Gamma_f^*$ . For an example, see Figure 5.

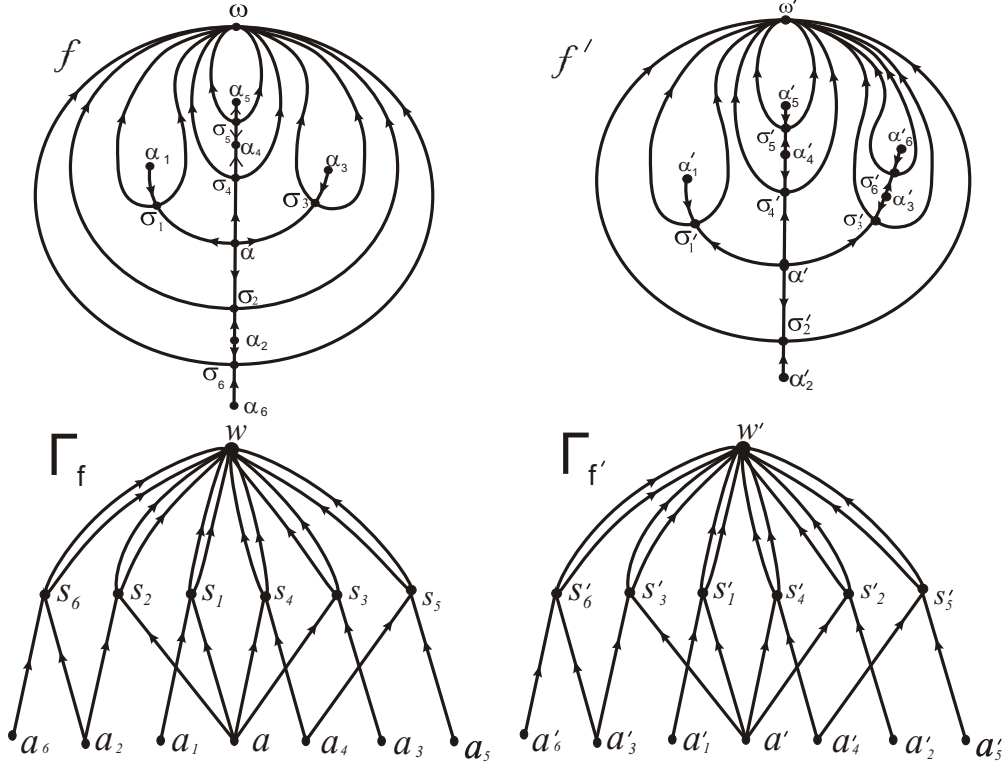

Figure 5: The diffeomorphisms  $f, f' : \mathbb{S}^2 \rightarrow \mathbb{S}^2$  have isomorphic graphs but they are not topologically conjugate as their equipped graphs  $\Gamma_f^*$  are not isomorphic (see the explanations in the text).

Let  $\Gamma_f^*$  and  $\Gamma_{f'}^*$  be equipped graphs of diffeomorphisms  $f$  and  $f'$  respectively and let  $\Gamma_f^*$  and  $\Gamma_{f'}^*$  be isomorphic by an isomorphism  $\xi$ . Let a vertex  $w$  of the graph  $\Gamma_f^*$  correspond to a sink and let  $w' = \xi(w)$ . Then the isomorphism  $\xi$  induces the permutation  $\Theta_{w,w'}$  on  $\{1, \dots, N\}$  (where  $N = N_w = N_{w'}$ ) defined by  $\Theta_{w,w'}(i) = j \Leftrightarrow \xi(e_i) = e'_j$ .

Two equipped graphs  $\Gamma_f^*, \Gamma_{f'}^*$  of diffeomorphisms  $f, f'$  are said to be *isomorphic* if there exists an isomorphism  $\xi$  of the graphs  $\Gamma_f, \Gamma_{f'}$  such that

- 1)  $\xi$  sends the vertices into the vertices and preserves the values of the vertices corresponding to the saddle periodic points; it sends the edges into the edges and preserves their direction;
- 2) the permutation  $\Theta_{w,w'}$  induced by  $\xi$  is a power of a cyclic permutation<sup>1</sup> for each vertex  $w$  corresponding to a sink;
- 3)  $f'_* = \xi f_* \xi^{-1}$ .

The equipped graph  $\Gamma_f^*$  of a diffeomorphism  $f$  is again a topological invariant up to isomorphism. Let us show that the equipped graphs  $\Gamma_f^*, \Gamma_{f'}^*$  of  $f, f'$  are not isomorphic. To do this, consider Figure 5 once again and suppose that the vertex  $w$  ( $w'$ ) of the graph corresponds to the sink point  $\omega$  ( $\omega'$ ). One can check directly that any isomorphism  $\xi$  induces the permutation  $\Theta_{w,w'}$

<sup>1</sup>It is directly checkable that the property of the permutation to be a power of a cyclic permutation is independent of the choice of the curves  $c_w$  and  $c_{w'}$ .

which is not a power of a cyclic permutation and therefore the equipped graphs  $\Gamma_f^*$ ,  $\Gamma_{f'}^*$  are not isomorphic. Generalising this argument, Bezdenezhnych and Grines [5, 6] were able to show that the equipped graphs are a complete invariant for gradient-like Morse-Smale diffeomorphisms on closed surfaces.

Let us now describe an alternative complete invariant for gradient-like diffeomorphisms, namely the *three-colour graph*. Let, as before,  $f$  be a gradient-like Morse-Smale diffeomorphism on a closed surface  $M^2$ . The non-wandering set  $\Omega_f$  can be represented as  $\Omega_f = \Omega_f^0 \cup \Omega_f^1 \cup \Omega_f^2$ , where  $\Omega_f^0$ ,  $\Omega_f^1$ ,  $\Omega_f^2$  denote the set of sinks, saddles, and sources of the diffeomorphism  $f$ , respectively. Throughout the remainder of this subsection, we assume that  $f$  has at least one saddle point<sup>2</sup>.

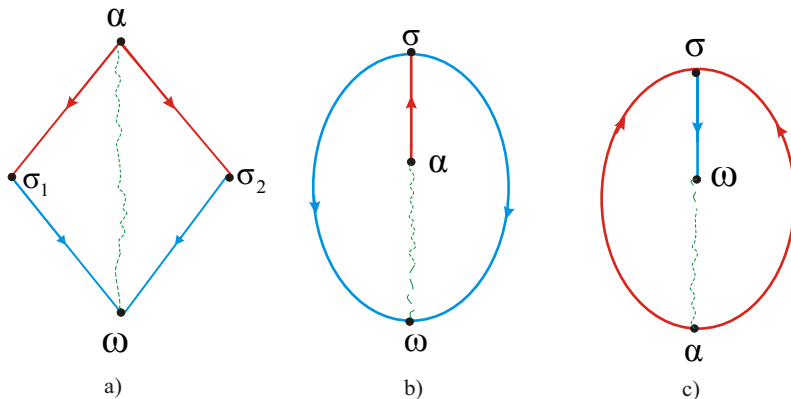

Figure 6: Types of cells with  $t$ -curves

We remove from the surface  $M^2$  the closure of the union of the stable manifolds and the unstable manifolds of all the saddle points of the diffeomorphism  $f$  and let the resulting set be denoted by  $\tilde{M}$ , that is,  $\tilde{M} = M^2 \setminus (\Omega_f^0 \cup W_{\Omega_f^1}^u \cup W_{\Omega_f^1}^s \cup \Omega_f^2)$ . The set  $\tilde{M}$  is represented in the form of a union of domains (*cells*) homeomorphic to the open two-dimensional disc such that the boundary of each of these cells has one of the forms depicted by boldface lines in Figure 6 and it contains exactly one source, one sink, one or two saddle points, and some of their separatrices.

Let  $A$  be any cell from the set  $\tilde{M}$ , and let  $\alpha$  and  $\omega$  be the source and sink contained in its boundary. A simple curve  $\tau \subset A$  whose boundary points are the source  $\alpha$  and the sink  $\omega$  is called a  $t$ -curve (see Figure 6). Let  $\mathcal{T}$  denote a set which is invariant under the diffeomorphism  $f$  and which consists of  $t$ -curves taken one from each cell.

Any connected component of the set  $M_\Delta = \tilde{M} \setminus \mathcal{T}$  is called a *triangular area*. Let  $\Delta_f$  denote the set of all triangular domains of diffeomorphism  $f$ . The boundary of every triangular domain  $\delta \in \Delta_f$  contains three periodic points: a source  $\alpha$ , a saddle  $\sigma$ , a sink  $\omega$ . It contains also the stable separatrix  $l_\sigma^s$  (called the  $s$ -curve) with  $\alpha$  and  $\sigma$  as boundary points, the unstable separatrix  $l_\sigma^u$  (called the  $u$ -curve) with  $\omega$  and  $\sigma$  as boundary points and a curve  $\tau$  (a  $t$ -curve)

<sup>2</sup>If a Morse-Smale diffeomorphism  $f : M^n \rightarrow M^n$  has no saddle points, then its nonwandering set consists of one source and one sink. All diffeomorphisms “source-sink” are topologically conjugate; the proof of this fact is given, for example, in [21] (Theorem 2.2.1).

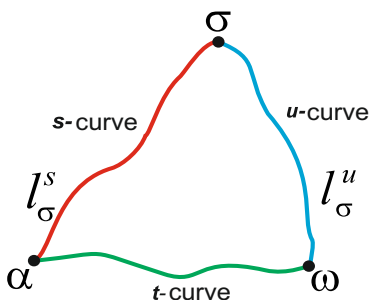

Figure 7: Triangular domain

with  $\alpha$  and  $\omega$  as boundary points (see Figure 7). A *triangular domain* is bounded by  $s$ -,  $u$ - and  $t$ -curves. We say that two triangular areas *have a common side*, if this side belongs to the closures of both domains. The *period of the triangular domain*  $\delta$  is defined to be the least positive integer  $k \in \mathbb{N}$ , such that  $f^k(\delta) = \delta$ .

We construct a *three-color* ( $s, t, u$ ) graph  $T_f$ , corresponding to a Morse-Smale gradient-like diffeomorphism  $f$  as follows (see Figure 8):

- 1) the vertices of  $T_f$  are in a one-to-one correspondence with the triangular domains of the sets  $\Delta$ ;
- 2) two vertices of the graph are incident to an edge of color  $s$ ,  $t$  and  $u$ , if the corresponding triangular domains have a common  $s$ ,  $t$  and  $u$ -curve.

By construction, three-color graphs obtained from different partitions into triangular domains (depending on the choice of  $t$ -curves) are isomorphic.

Let  $B_f$  denote the set of the vertices of the graph  $T_f$ . Since the sides of any triangular domain are assigned different colors, edges of three different colors come together at the vertex corresponding to the triangular domain. Since any side of a triangular domain is adjacent to exactly two different triangular domains, the graph  $T_f$  has no cycles of length 1. Thus, the graph  $T_f$  satisfies the definition of the three-color graph. Let  $\pi_f : \Delta_f \rightarrow B_f$  denote a one-to-one map of the set of the triangular domains of the diffeomorphism  $f$  into the set of the vertices of the graph  $T_f$ . The diffeomorphism  $f$  induces the automorphism  $f_* = \pi_f f \pi_f^{-1}$  on the set of vertices of the graph  $T_f$ . Let  $(T_f, f_*)$  be denote the three colour graph  $T_f$  together with the automorphism  $f_*$ .

Two three-color graphs with automorphisms  $(T_f, f_*)$  and  $(T_{f'}, f'_*)$  of diffeomorphisms  $f, f'$  are said to be *isomorphic* if there exists a one-to-one correspondence  $\xi$  between the sets of their vertices which preserve the relations of incidence and the color, as well as the conjugating automorphisms  $f_*$  and  $f'_*$  (that is,  $f'_* = \xi f_* \xi^{-1}$ ).

As mentioned, in [18] it is shown that the three-color graph  $(T_f, f_*)$  of a diffeomorphism  $f$  is a *complete* topological invariant up to isomorphism for gradient-like Morse-Smale diffeomorphisms on closed surfaces.

In this paper we shall associate a different complete invariant to a (general) surface Morse-Smale diffeomorphism, namely a scheme. For the diffeomorphisms from Figures 5 8 the invariants associated to each of the two diffeomorphisms consists of a torus with 10 closed curves, see

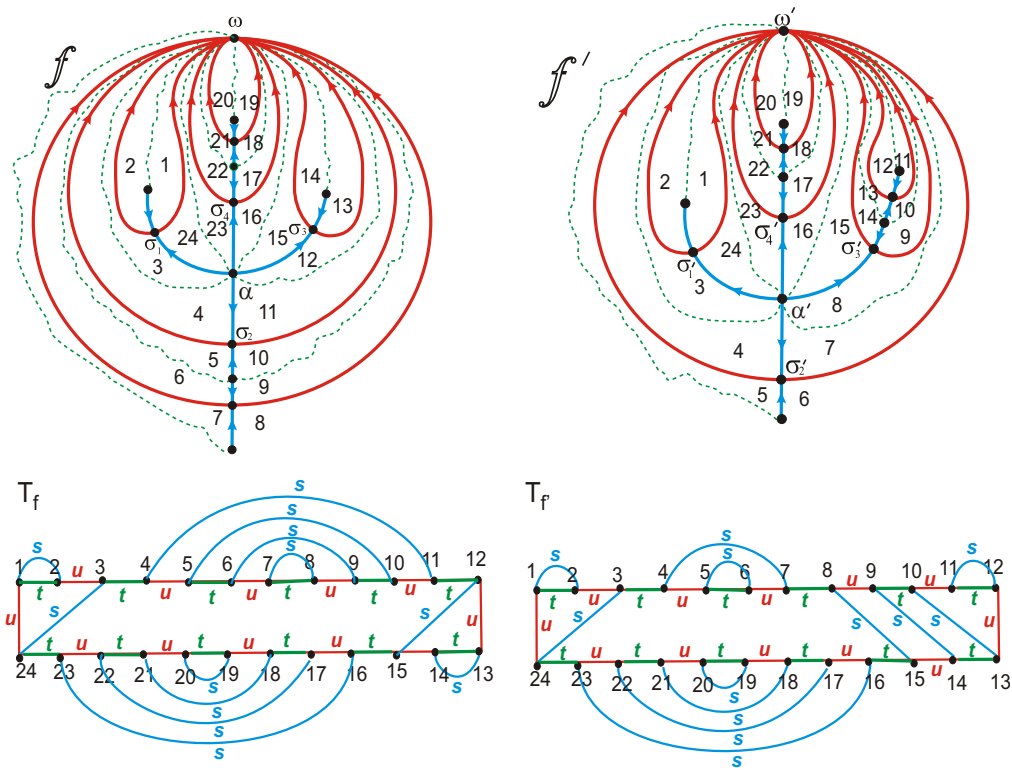

Figure 8: The non-isomorphic three-colour graphs  $T_f, T_{f'}$  associated to the non conjugated gradient-like diffeomorphisms  $f, f'$ .

Figure 19. Since these curves are ordered differently on the tori for the two diffeomorphisms, it follows at once that such systems are not topologically conjugated.

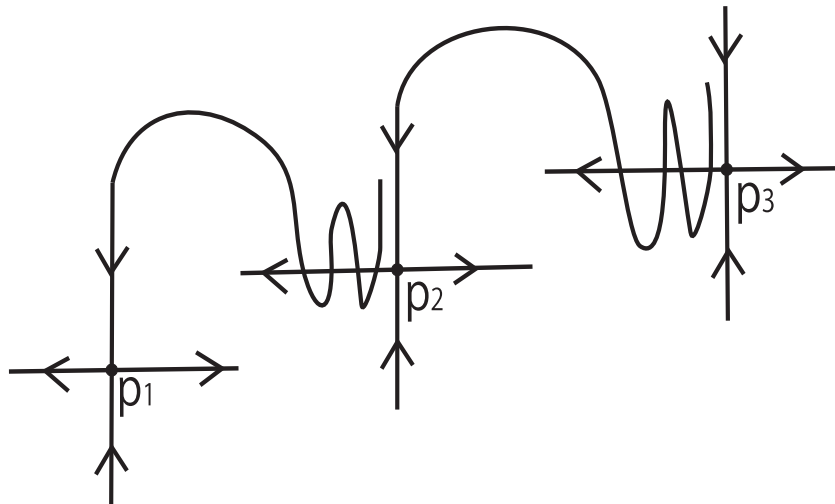

Figure 9: A chain of the length 3

## 2.2 Classification of non-gradient-like diffeomorphisms on closed surfaces

Let us now discuss previous results concerning the classification of general Morse-Smale diffeomorphisms on closed surfaces. Let  $\mathcal{O}_i, \mathcal{O}_j$  be periodic orbits of Morse-Smale diffeomorphism  $f : M^2 \rightarrow M^2$ . Smale [53] introduced a *partial order relation*  $\prec$  for the periodic orbits

$$\mathcal{O}_i \prec \mathcal{O}_j \iff W_{\mathcal{O}_i}^s \cap W_{\mathcal{O}_j}^u \neq \emptyset.$$

A sequence of distinct periodic orbits  $\mathcal{O}_i = \mathcal{O}_{i_0}, \mathcal{O}_{i_1}, \dots, \mathcal{O}_{i_k} = \mathcal{O}_j$  ( $k \geq 1$ ), such that  $\mathcal{O}_{i_0} \prec \mathcal{O}_{i_1} \prec \dots \prec \mathcal{O}_{i_k}$  is called a *chain of length  $k$  joining the periodic orbits  $\mathcal{O}_i$  and  $\mathcal{O}_j$* . The maximal length of the chain joining  $\mathcal{O}_i$  and  $\mathcal{O}_j$  is denoted by

$$beh(\mathcal{O}_j|\mathcal{O}_i)$$

(*beh* stands for *behaviour*). where we define  $beh(\mathcal{O}_j|\mathcal{O}_i) = 0$  when  $W_{\mathcal{O}_j}^u \cap W_{\mathcal{O}_i}^s = \emptyset$ . For a subset  $P$  of the periodic orbits let us set  $beh(\mathcal{O}_j|P) = \max_{\mathcal{O}_i \in P} \{beh(\mathcal{O}_j|\mathcal{O}_i)\}$ . Figure 9 gives an example where  $\mathcal{O}_1 \prec \mathcal{O}_2 \prec \mathcal{O}_3$  for saddle fixed points  $p_1 = \mathcal{O}_1, p_2 = \mathcal{O}_2, p_3 = \mathcal{O}_3$  and  $beh(\mathcal{O}_2|\mathcal{O}_1) = beh(\mathcal{O}_3|\mathcal{O}_2) = 1, beh(\mathcal{O}_3|\mathcal{O}_1) = 2$ . Set

$$beh(f) = \max\{beh(\mathcal{O}_j|\mathcal{O}_i)\}.$$

A Morse-Smale diffeomorphism has  $beh(f) = 1$  iff it is a so-called *sink-source diffeomorphism*. When  $beh(f) = 2$  then  $f$  has no heteroclinic points, and so is *gradient-like*. A Morse-Smale diffeomorphism  $f : M^2 \rightarrow M^2$  with  $beh(f) > 2$  has a chain of saddle orbits of the length  $beh(f) - 2$ .

If  $beh(f) = 3$  then  $f$  has a finite number of heteroclinic orbits. In 1993, Grines [16] proved that for such diffeomorphisms an invariant similar to Peixoto's graph carrying additional information on the *heteroclinic substitution*, describing the intersection pattern of invariant manifolds as in Figure 10, is sufficient to describe necessary and sufficient conditions for topological conjugacy.

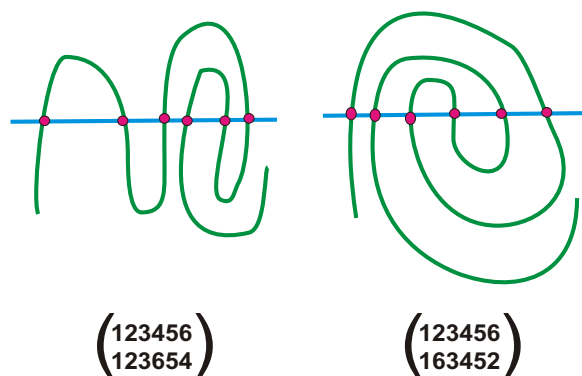

Figure 10: Heteroclinic substitution



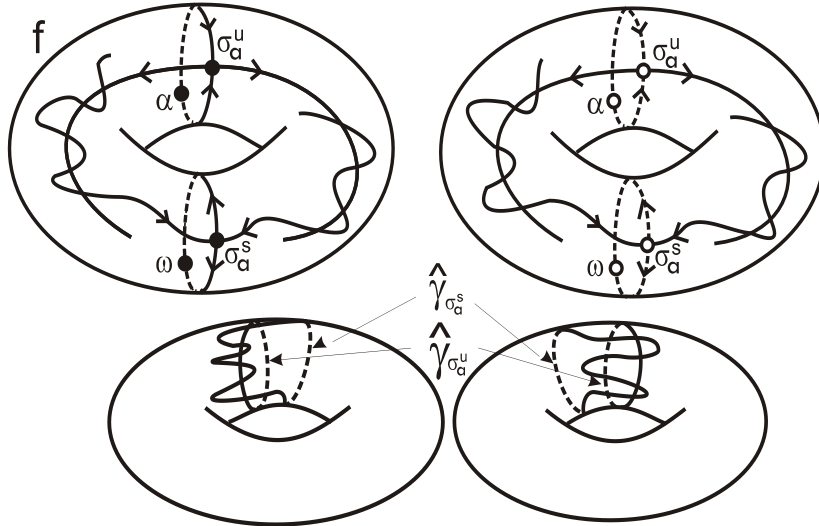

Figure 11: Scheme of a Morse-Smale diffeomorphism with  $beh(f) = 3$

In 1993, Langevin [23] proposed to consider the *orbit space* of the basin of the sink and project to this closed surface the unstable separatrices of the saddle points. This approach was generalized and successfully applied by Bonatti, Grines, Medvedev, Pecou and Pochinka in [9], [10] for the topological classification of Morse-Smale diffeomorphisms  $f$  with  $beh(f) \leq 3$  on 3-manifolds. In 2010, Mitryakova and Pochinka [30] applied this method to the topological classification of Morse-Smale diffeomorphisms  $f$  with  $beh(f) \leq 3$  on orientable surfaces. Indeed, they constructed a topological invariant (which they called a “*scheme*”) which consists of a finite number of two-dimensional tori (corresponding to the orbit space of the basin of sinks and sources), together with a set of simple closed curves (corresponding to the orbit spaces of separatrices), see Figure 11. They also proved that this invariant is complete when  $beh(f) \leq 3$ . In 2013, Mitryakova and Pochinka [31] solved the *realization problem* for such diffeomorphisms, establishing that each *abstract scheme* corresponds to a Morse-Smale diffeomorphism (we will make this notion more precise below). Vlasenko [55] in 1998 proposed another approach to the topological classification for arbitrary structurally stable diffeomorphisms of orientable surfaces using an equipped oriented graph whose vertices corresponds to a periodic and heteroclinic point and each directed edge corresponds to a connecting segment of separatrices.

In 1998, a different approach was taken Bonatti and Langevin [11], who considered  $C^1$ -structurally stable diffeomorphisms (Smale diffeomorphisms) of compact surfaces. The main result of that paper consists of a finite combinatorial presentation of the global topological dynamics in terms of the geometrical types of certain Markov partitions of the hyperbolic sets and by gluing the domains along their boundary. One important step of the proof of their theorem consists of a precise analysis of the topological position (the ‘intersection pattern’) of invariant manifolds of the Smale diffeomorphisms.

Let us describe their construction for a Morse-Smale diffeomorphism  $f : M^2 \rightarrow M^2$ . Consider a maximum heteroclinic chain  $O_1, \dots, O_h$  of saddle orbits for  $f$  and define  $K_{1h} =$

$\left(\bigcup_{i=1}^h W_{O_i}^u\right) \cap \left(\bigcup_{i=1}^h W_{O_i}^s\right)$ . The set  $\bigcup_{i=1}^h O_i \cup K_{1h}$  is called a *saturation* of the chain. So the saturation of the chain is the union of saddle orbits and various intersections of stable and unstable separatrices of saddle periodic points belonging to the chain. Note that the maximum saturation of heteroclinic chain is an invariant set  $K_f$ . By definition, separatrices of saddle periodic points intersect transversely for Morse-Smale diffeomorphisms. Using this fact, they proved that one can put a uniform hyperbolic structure on  $K_f$  and that a neighbourhood of  $K_f$  has *finite topological type*, i.e., is a closed surface with a finite number of holes.

The saturated hyperbolic set can be viewed as a generalization of the notion of a basic set of saddle type. (By definition, a basic set  $\Lambda$  is a compact invariant set which carries a hyperbolic structure and so that  $f: \Lambda \rightarrow \Lambda$  is transitive) This makes it possible to apply the Bowen-Sinai technique for constructing Markov partitions for such sets [44, 12]. In other words,  $K_f$  is covered by a special family of curvilinear quadrangles formed by segments of the stable and unstable separatrices, which they call a *good Markov partition*. The geometric type of a good Markov partition includes a description of the mutual arrangement, orientation and numbering of curvilinear quadrangles, and their images under the action of the diffeomorphism. Two geometric types are called *equivalent* if they are geometric types of some good Markov partitions of the same hyperbolic saturated set. The main result in [11] in the setting of Morse-Smale systems is the following: let  $K_{f_1}, K_{f_2}$  be the saturated hyperbolic sets of Morse-Smale diffeomorphisms  $f_1, f_2$  on closed oriented surfaces  $M_1, M_2$  respectively, suppose that  $K_{f_1}$  and  $K_{f_2}$  have good Markov partitions with equivalent geometric types, then  $f_1, f_2$  are topologically conjugate on invariant neighborhoods of the sets  $K_{f_1}, K_{f_2}$ . See Theorem 1.0.3 in [11] for a more precise statement.

In a subsequent work, Beguin [4] developed a finite algorithm to decide the equivalence of two realizable geometrical types. In fact, as is shown in [11], some of the abstract geometrical types do not correspond to any Smale diffeomorphisms on compact surfaces.

In the next section we will introduce alternative, and in our opinion more natural, combinatorial objects (called ‘schemes’) which, unlike the previous approaches, not only give a complete classification (as in Theorem A), but also describe which Morse-Smale diffeomorphisms can be realised (as in Theorem B).

### 3 The scheme of a MS surface diffeomorphism is a complete invariant

The aim of this paper is to give a different classification which is inspired by the one for circle diffeomorphisms. The upshot is that we obtain a *finite amount of data* about a Morse-Smale diffeomorphism which is *necessary and sufficient* to determine whether or not it is topologically conjugate to another Morse-Smale diffeomorphism. One of the main features of this classification is that, *given this abstract data*, we will always be able *construct* a diffeomorphism that realises this data.

More precisely, in the present paper we consider class  $MS(M^2)$  preserving orientation Morse-Smale diffeomorphisms of an orientable surface  $M^2$  and give a complete topological classification

within this class, and solve the corresponding realization problem, by means of topological invariants similar to those used in [9, 10, 30, 31]. To make this precise we need to introduce some notions.

### 3.1 Maximal $u$ -compatible system of linearizing neighborhoods: statement of Theorem 1

Let  $f \in MS(M^2)$ . We will assume that  $beh(f) > 1$  because all sink-source diffeomorphisms are topologically conjugate. For a periodic point  $p$  of  $f$  let us denote by  $k_p$  the period of  $p$  and by  $\nu_p$  the orientation type of  $p$ , i.e.  $\nu_p = + (-)$  if the map  $f^{k_p}|_{W_p^u}$  preserves (reverses) orientation. Denote by  $\Sigma$  the set of all saddle points of  $f$ . In the construction below, linearizing neighbourhoods of saddles will play a crucial role. It turns out to be convenient to choose ‘canonical’ linearizing neighborhoods. For this aim, for  $\nu \in \{+, -\}$ , let us introduce a *canonical diffeomorphism*  $a_\nu : \mathbb{R}^2 \rightarrow \mathbb{R}^2$  by the formula

$$a_\nu(x_1, x_2) = \left(\nu 2x_1, \frac{\nu x_2}{2}\right).$$

Notice that the origin  $O = (0, 0)$  is a saddle point with the unstable manifold  $W_O^u = Ox_1$  and the stable manifold  $W_O^s = Ox_2$ . Define

$$N = \{(x_1, x_2) \in \mathbb{R}^2 : |x_1 \cdot x_2| \leq 1\} \text{ and } N^t = \{(x_1, x_2) \in \mathbb{R}^2 : |x_1 \cdot x_2| \leq t\} \text{ for } t \in (0, 1].$$

By construction,  $N$  is  $a_\nu$ -invariant neighborhood of  $O$ . We will say that  $N$  is a *canonical neighborhood*. Denote by  $F^u$  the one-dimensional foliation which consists of the leaves  $\{(x_1, x_2) \in N : x_2 = c\}$ ,  $c \in \mathbb{R}$  and by  $F^s$  the one-dimensional foliation which consists of the leaves  $\{(x_1, x_2) \in N : x_1 = c\}$ ,  $c \in \mathbb{R}$ .

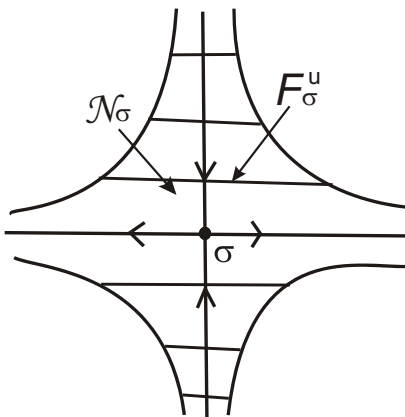

Figure 12: An  $u$ -linearizing neighborhood

**Definition 1** (The  $u$ -linearizing neighborhood). Let  $\sigma$  be a saddle periodic point for  $f$ . A neighborhood  $N_\sigma$  of  $\sigma$  together with a one-dimensional foliation  $F_\sigma^u$  containing  $W_\sigma^u$  as a leaf, is

called *u-linearizable* if there is a homeomorphism  $\mu_\sigma : N \rightarrow N_\sigma$  which conjugates the canonical diffeomorphism  $a_{\nu_\sigma}|_N$  to the diffeomorphism  $f^{k_\sigma}|_{N_\sigma}$  and sends leaves of the foliation  $F^u$  to leaves of the foliation  $F_\sigma^u$  (see Figure 12).

For every point  $x \in N_\sigma$  denote by  $F_{\sigma,x}^u$  the unique leave of the foliation  $F_\sigma^u$  passing through the point  $x$ .

**Definition 2** (A *u-compatible system of neighbourhoods*). An  $f$ -invariant collection  $N_f$  of  $u$ -linearizable neighborhoods  $N_\sigma$  of all saddle points  $\sigma \in \Sigma$  is called *u-compatible* if the following properties are hold:

- 1)  $\mu_\sigma(\partial N)$  does not contain heteroclinic points for any  $\sigma \in \Sigma$ ;
- 2) if  $W_{\sigma_1}^s \cap W_{\sigma_2}^u = \emptyset$  and  $W_{\sigma_1}^u \cap W_{\sigma_2}^s = \emptyset$  for  $\sigma_1, \sigma_2 \in \Sigma$  then  $N_{\sigma_1} \cap N_{\sigma_2} = \emptyset$ ;
- 3) if  $W_{\sigma_1}^s \cap W_{\sigma_2}^u \neq \emptyset$  for  $\sigma_1, \sigma_2 \in \Sigma$  then  $(F_{\sigma_1,x}^u \cap N_{\sigma_2}) \subset F_{\sigma_2,x}^u$  for  $x \in (N_{\sigma_1} \cap N_{\sigma_2})$  (see Figure 13).

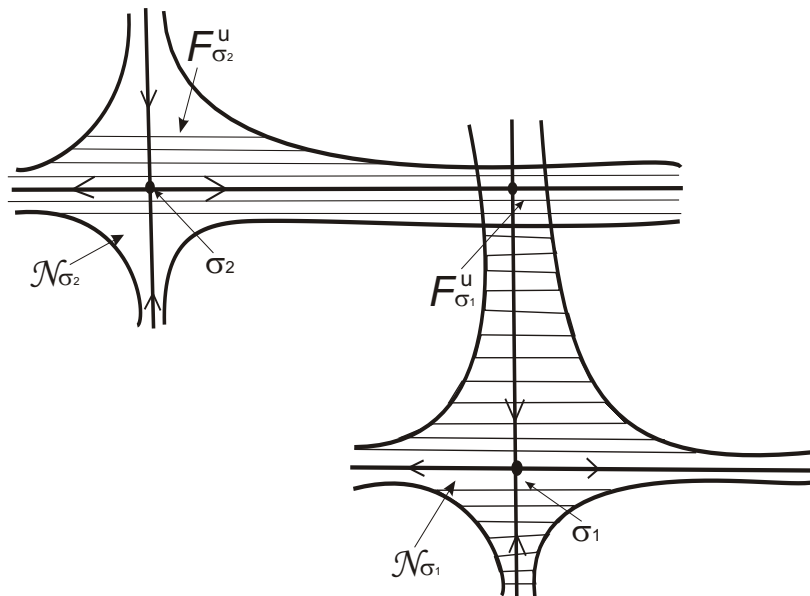

Figure 13: An  $u$ -compatible system of neighbourhoods

It will be proved in Proposition 3 that there are  $u$ -compatible neighbourhoods for every diffeomorphism  $f \in MS(M^2)$ . Indeed these are slight modifications of the admissible system of tubular families constructed by Palis and Smale in [33] and [35]. It is easy to see (see, for example Figures 1 and 21) that in general there is no conjugating homeomorphism which sends an  $u$ -compatible system of neighborhoods for  $f$  to the  $u$ -compatible system of neighborhoods for  $f'$ , even when  $f$  and  $f'$  are topologically conjugated. Therefore we need a more meaningful notion.

For a saddle point  $\sigma$  let us denote by  $[a, b]_\sigma^u$  ( $[a, b]_\sigma^s$ ) the segment of  $W_\sigma^u$  ( $W_\sigma^s$ ) situated between the points  $a, b \in W_\sigma^u$  ( $a, b \in W_\sigma^s$ ).

**Definition 3** (*Heteroclinic rectangle*). A closed 2-disc  $\Pi_\sigma$  bounded by segments  $[\sigma, a]_\sigma^u$ ,  $[a, b]_{\sigma_1}^s$ ,  $[b, c]_{\sigma_2}^u$ ,  $[c, \sigma]_\sigma^s$ ,  $\sigma_1, \sigma_2 \in \Sigma$  and such that  $\text{int } \Pi_\sigma \cap \Omega_f = \emptyset$  is called a *heteroclinic rectangle* with respect to  $\sigma$  if every connected component of the set  $W_\Sigma^s \cap \Pi_\sigma$  intersects every connected component of the set  $W_\Sigma^u \cap \Pi_\sigma$  at exactly one point (see Figure 14).

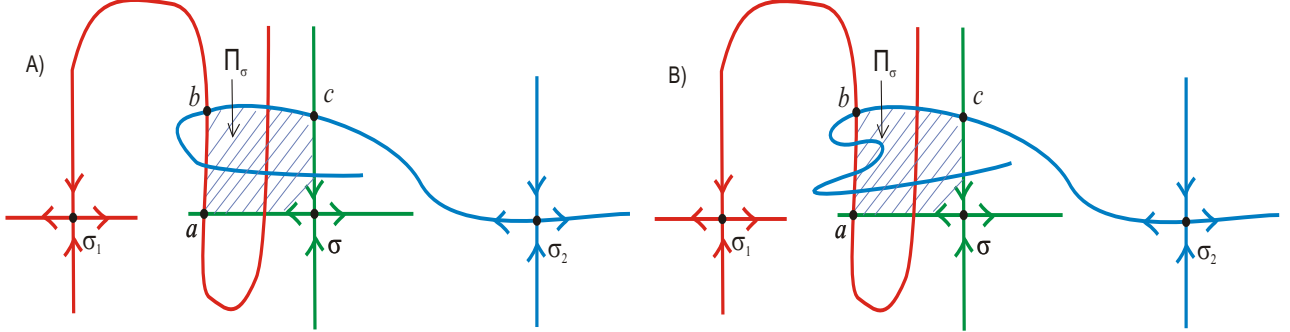

Figure 14: A)  $\Pi_\sigma$  is a heteroclinic rectangle. B)  $\Pi_\sigma$  is not a heteroclinic rectangle

**Definition 4** (*The maximal  $u$ -compatible system of neighbourhoods*). A  $u$ -compatible system of neighbourhoods  $N_f$  is called *maximal* if every linearizing neighborhood  $N_\sigma \in N_f$  contains each heteroclinic rectangle  $\Pi_\sigma$ .

**Theorem 1.** *For every diffeomorphism  $f \in MS(M^2)$  there is a maximal  $u$ -compatible system of neighbourhoods.*

The proof of this theorem will be given in Section 5. Everywhere below we will denote by  $N_\sigma$  a linearizing neighborhood of a saddle point  $\sigma$  from a maximal  $u$ -compatible system of neighbourhoods.

### 3.2 Associating a scheme to a Morse-Smale surface diffeomorphism

Let  $\Sigma_0$  be the set of all sinks of  $f$ . Let us decompose the set  $\Sigma$  of all saddle periodic points of  $f$  into subsets  $\Sigma_1, \dots, \Sigma_{\text{beh}(f)-1}$  inductively as follows: define  $\Sigma_i$  to be the set of all saddle points of  $f$  such that  $\text{beh}(\mathcal{O}_\sigma |_{\Sigma_{i-1}}) = 1$  for each orbit  $\mathcal{O}_\sigma$ ,  $\sigma \in \Sigma_i$ . Let  $\Sigma_{\text{beh}(f)}$  be the set of all sources.

**The quotient space  $\mathcal{V}_f$  of the stable manifold of sinks.** Let

$$\mathcal{V}_f = W_{\Sigma_0}^s \setminus \Sigma_0, \quad \hat{\mathcal{V}}_f = \mathcal{V}_f / f. \quad (1)$$

Since  $f$  is a diffeomorphism, the natural projection  $p_f : \mathcal{V}_f \rightarrow \hat{\mathcal{V}}_f$  is a covering map. Every connected component  $\hat{V}_j$  of  $\hat{\mathcal{V}}_f$  is homeomorphic to a 2-torus and corresponds to a unique periodic orbit  $\mathcal{O}_{\omega_j}$  of a sink  $\omega_j$ . Indeed, the factor space  $\hat{\mathcal{V}}_f = \mathcal{V}_f / f$  is obtained by taking a fundamental annulus in the basin of each attracting periodic orbit and identifying its boundaries by  $f^{m_j}$  where  $m_j$  is the *period of this sink*.

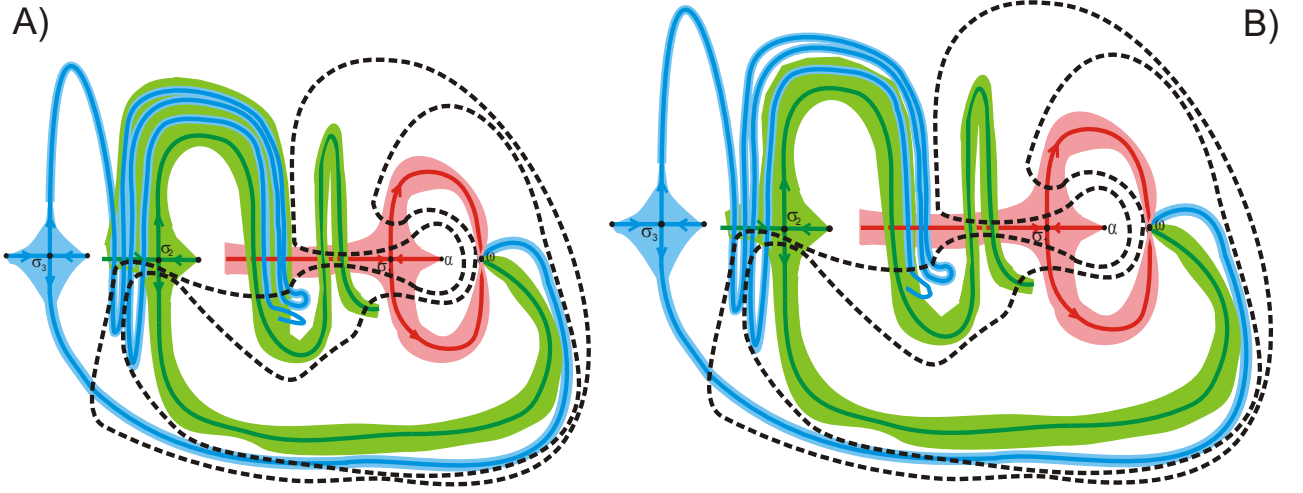

Figure 15: For a Morse-Smale diffeomorphism on the 2-sphere whose phase portrait is given in Figure 1 we represent: A) A maximal  $u$ -compatible system; B)  $u$ -compatible system which is non-maximal.

**Equators on the connected components  $\hat{V}_j$  of  $\mathcal{V}_f$ .** It will be helpful to choose a particular generator of  $\pi_1(\hat{V}_j)$  by defining an epimorphism

$$\eta_{\hat{V}_j} : \pi_1(\hat{V}_j) \rightarrow m_j \mathbb{Z}$$

as follows, where  $m_j$  is the period of the the sink  $\omega_j$ , as follows. Take the homotopy class  $[\hat{c}] \in \pi_1(\hat{V}_j)$  of a closed curve  $\hat{c} : \mathbb{R}/\mathbb{Z} \rightarrow \hat{V}_j$ . Then  $\hat{c} : [0, 1] \rightarrow \hat{V}_j$  lifts to a curve  $c : [0, 1] \rightarrow \mathcal{V}_f$  connecting a point  $x$  with a point  $f^n(x)$  for some multiple  $n \in \mathbb{Z}$  of  $m_j$ , where  $n$  is independent of the lift. So define  $\eta_{\hat{V}_j}[\hat{c}] = n$ . A simple closed curve  $\hat{e}_j$  on  $\hat{V}_j$  is called an *equator* if  $\eta_{\hat{V}_j}[\hat{e}_j] = 0$  and  $[\hat{e}_j] \neq 0$  (see Figure 3.2). Note that the equator  $\hat{e}_j$  is uniquely determined up to homotopy by  $\eta_j$ . Therefore  $\eta_{\hat{V}_j}$  is uniquely determined by the integer  $m_j \geq 1$  and the equator  $\hat{e}_j$  on  $\hat{V}_j$ . In this way we obtain a unique morphism

$$\eta_f : \pi_1(\hat{\mathcal{V}}_f) \rightarrow \mathbb{Z}$$

so that  $\eta_f|_{\pi_1(\hat{V}_j)} = \eta_{\hat{V}_j}$  for each component  $\hat{V}_j$  of  $\hat{\mathcal{V}}_f$ . We will say that a closed curve  $\hat{\gamma}$  winds  $n \in \mathbb{N}$  times in  $\hat{V}_j$  if  $\eta_{\hat{V}_j}[\hat{\gamma}] = n \cdot m_j$ , see Figure 3.2.

**The covering space  $\hat{V}_j$  of  $\hat{V}_j$ .** Given a component  $\hat{V}_j$  of  $\hat{\mathcal{V}}_f$ , the set  $p^{-1}(\hat{V}_j) \subset \mathcal{V}_f$  is equal to  $W_{\mathcal{O}_{\omega_j}}^s \setminus \mathcal{O}_{\omega_j}$  and therefore homeomorphic to  $V_j^* := (\mathbb{R}^2 \setminus O) \times \mathbb{Z}_{m_j}$  where as before  $m_j$  is the period of  $\omega_j$ . Let  $V^*$  be the union of all  $V_j^*$  and let  $p^* : V^* \rightarrow \hat{\mathcal{V}}_f$  be the covering map corresponding to  $p_f$ . If  $\hat{e}_j$  is an equator on  $\hat{V}_j$ , then  $(p^*)^{-1}(\hat{e}_j)$  is the countable union of simple closed curves in each of the sets  $(\mathbb{R}^2 \setminus O) \times \{k\} \subset V_j^*$ . The complement of these curves form annuli in  $(\mathbb{R}^2 \setminus O) \times \{k\}$ , and gluing the two boundaries of such an annulus (according to  $f^{m_j}$ ) we obtain again the torus  $\hat{V}_j$  (see Figure 3.2). For convenience, in the figures below,  $(\mathbb{R}^2 \setminus O)$  is drawn as a punctured disc  $(\mathbb{D}^2 \setminus O)$ .

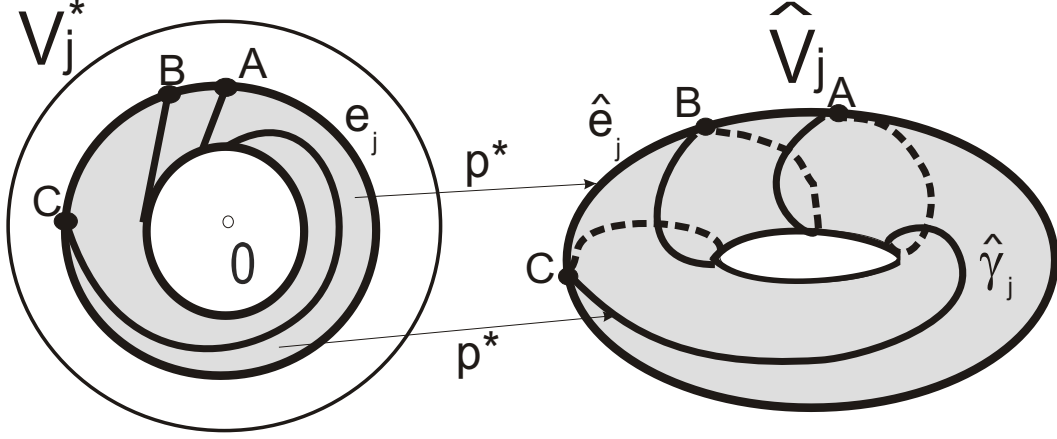

Figure 16:  $V_j^*$  is represented when  $m_j = 1$ , as is the equator  $\hat{e}_j$  and some meridian  $\hat{y}_j$  on  $\hat{V}_j$ . The curve  $e_j \subset V_j^*$  is a connected component of  $(p^*)^{-1}(\hat{e}_j)$ . The curve  $\hat{\gamma} \subset \hat{V}_j$  winds three times in  $\hat{V}_j$ , its preimage  $(p^*)^{-1}(\hat{\gamma}_j)$  consists of three curves passing through the points  $A, B, C$ , accordingly.

**The maximal linearizing neighborhoods as subsets of  $\mathcal{V}_f$ .** For each  $i \in \{0, 1, \dots, beh(f)\}$ , let

$$W_i^u = W_{\Sigma_i}^u, \quad W_i^s = W_{\Sigma_i}^s.$$

For each  $i \in \{1, \dots, beh(f) - 1\}$ , let

$$\mathcal{N}_i = \bigcup_{\sigma \in \Sigma_i} N_\sigma$$

be the corresponding linearizing neighbourhoods.

**The scheme of a diffeomorphism.** For each  $i \in \{1, \dots, beh(f) - 1\}$ ,  $\sigma \in \Sigma_i$ , let

$$U_\sigma = N_\sigma \setminus \bigcup_{j=1}^{i-1} \mathcal{N}_j, \quad \hat{U}_\sigma = p_f(U_\sigma), \quad U_\sigma^* = (p^*)^{-1}(\hat{U}_\sigma).$$

Let

$$\hat{\mathcal{U}}_i = \bigcup_{\sigma \in \Sigma_i} \hat{U}_\sigma, \quad \hat{\mathcal{U}}_f = \bigcup_{i=1}^{beh(f)-1} \hat{\mathcal{U}}_i.$$

Let us define

$$S_f = (\hat{\mathcal{V}}_f, \eta_f, \bigcup_{i=1}^{beh(f)-1} \{\hat{U}_\sigma\}_{\sigma \in \Sigma_i}).$$

**Definition 5** (The scheme of a diffeomorphism). We call the triple  $S_f$  the *scheme* associated to the diffeomorphism  $f \in MS(M^2)$ .

**Definition 6** (Equivalence of schemes). The schemes  $S_f$  and  $S_{f'}$  of the two diffeomorphisms  $f, f' \in MS(M^2)$ , respectively, are said to be *equivalent* if there exist an orientation preserving homeomorphism  $\hat{\varphi} : \hat{\mathcal{V}}_f \rightarrow \hat{\mathcal{V}}_{f'}$  such that:

- (1)  $\eta_{f'} \hat{\varphi}_* = \eta_f$ ;
- (2)  $\hat{\varphi}(\hat{\mathcal{U}}_f) = \hat{\mathcal{U}}_{f'}$ , moreover for every  $i = 1, \dots, beh(f) - 1$  and every point  $\sigma \in \Sigma_i$  there is a point  $\sigma' \in \Sigma'_i$  such that  $\varphi^*(U_\sigma^*) = U_{\sigma'}^*$ , where  $\varphi^* : \mathcal{V}_f^* \rightarrow \mathcal{V}_{f'}^*$  is the lift of  $\hat{\varphi}$ .

**Remark 2.** It will be proved in Lemma 4 below that the equivalence class of a scheme  $S_f$  does not depend on a choice of the maximal system of the neighborhoods.

**Remark 3.** Property (1) in this definition can be restated by requiring that  $\varphi$  sends equators of  $\hat{\mathcal{V}}_f$  to equators of  $\hat{\mathcal{V}}_{f'}$ , and that the integer  $m_j$  associated to a component  $\hat{V}_j$  is equal to the integer associated to  $\hat{\varphi}(\hat{V}_j)$ . Property (2) in this definition ensures that the pair of annuli corresponding to some  $\hat{U}_\sigma$  are mapped to a similar pair of annuli for  $f'$ . The need for the requirement that  $\varphi^*(U_\sigma^*) = U_{\sigma'}^*$  will be clear when considering the diffeomorphisms corresponding to Figures 36 and 37. For each of those diffeomorphisms, the corresponding set  $\hat{\mathcal{U}}_f$  consists of one annulus (which wraps 5 times around the torus). The difference between these diffeomorphisms can only be seen by considering the sets  $U_\sigma^*$  in  $\mathcal{V}_f^*$ .

### 3.3 Schemes are complete invariants: statement of Theorem 2

**Theorem 2.** *Two diffeomorphisms  $f, f' \in MS(M^2)$  are topologically conjugate iff their schemes  $S_f, S_{f'}$  are equivalent.*

As small perturbations of a diffeomorphism  $f \in MS(M^2)$  do not change its periodic dates and the topological structure of the maximal  $u$ -compatible system of neighborhood, we obtain

**Corollary 1.** *Each diffeomorphisms  $f \in MS(M^2)$  is structurally stable (in the  $C^1$  topology).*

The previous theorem shows that one can also consider two MS diffeomorphisms which are ‘far away from each’, provided their schemes are equivalent.

In the next section we will also introduce the notion of a *decomposed scheme*, which will make it clear why a scheme is determined by a finite amount of data. It will also be shown that an ‘abstract’ decomposed scheme is realizable by a MS diffeomorphisms if and only if some simple conditions are satisfied.

### 3.4 Examples of schemes associated to gradient MS-diffeomorphisms

By the construction a scheme of a Morse-Smale diffeomorphism  $f$  is completely described by a union of tori  $\hat{\mathcal{V}}_f$ , the epimorphism  $\eta_f$  and  $\bigcup_{i=1}^{beh(f)-1} \{\hat{U}_\sigma\}_{\sigma \in \Sigma_i}$  where the sets  $\Sigma_1, \dots, \Sigma_{beh(f)-1}$  are finite. As mentioned above, the epimorphism  $\eta_f$  is uniquely determined by an equators on each component  $\hat{V}_j$  of  $\hat{\mathcal{V}}_f$  and an integer  $m_j \geq 1$ . In the figures in this paper, the equators are depicted as the ‘outer boundaries’ of the tori.



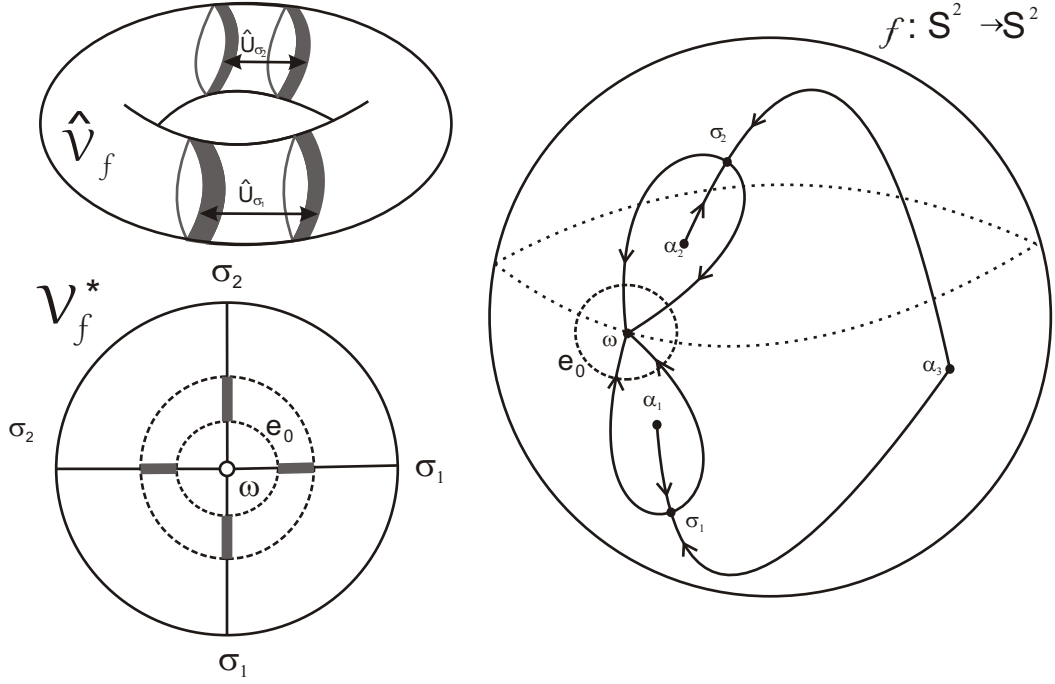

Figure 17: The scheme  $S_f$  of a diffeomorphism  $f_S \in MS(\mathbb{S}^2)$ . See Example 1 for a further discussion.

**Example 1** (Figure 17). Consider the diffeomorphism  $f: S^2 \rightarrow S^2$  from Figure 17. Here  $\hat{\mathcal{V}}_f = \mathbb{T}^2$ ,  $beh(f) = 2$ ,  $\#\Sigma_0 = 1$ ,  $m = 1$ ,  $\#\Sigma_1 = 2$  and  $\hat{U}_{\sigma_1}, \hat{U}_{\sigma_2}$  consist of four annuli on the torus  $\hat{\mathcal{V}}_f$ . The set  $\hat{\mathcal{V}}^*$  is represented as  $(\mathbb{R}^2 \setminus O)$ .

**Example 2** (Figure 18). Consider the diffeomorphism  $f: S^2 \rightarrow S^2$  from Figure 18 where we take  $f$  so that it permutes the two components of  $W^u(\sigma_1) \setminus \sigma_1$ . We obtain  $\hat{\mathcal{V}}_f = \mathbb{T}^2$ ,  $beh(f) = 2$ ,  $\#\Sigma_0 = 1$ ,  $m = 1$ ,  $\#\Sigma_1 = 2$  and  $\hat{U}_{\sigma_i}$ ,  $i = 1, 2$  is an annulus which winds around twice along the torus  $\hat{\mathcal{V}}_f$ . To see this, notice that  $f$  induces an action on  $\mathcal{V}_f^*$  which corresponds to the composition of a radial contraction and a half revolution around 0. Therefore the inner and outer circle drawn in  $\mathcal{V}_f^*$  are identified by a half revolution.

**Example 3** (Figures 8,19). Consider the diffeomorphisms  $f, f': S^2 \rightarrow S^2$  from Figure 8. The scheme associated to these diffeomorphisms are drawn in Figure 19 where  $\hat{\mathcal{V}}_f = \mathbb{T}^2$ ,  $beh(f) = 2$ ,  $\#\Sigma_0 = 1$ ,  $m = 1$ ,  $\#\Sigma_1 = 5$  and  $\hat{U}_{\sigma_i}$ ,  $i = 1, \dots, 5$  consists of 2 annuli. Note that the difference between the two schemes is the way the pair of components corresponding to each of the five saddles are jointly embedded in  $\hat{\mathcal{V}}_f$ .

**Example 4** (Figure 20). Consider the diffeomorphism  $f: S^2 \rightarrow S^2$  from Figure 20 where we take  $f$  so that it permutes the two components of  $W^u(\sigma) \setminus \sigma$ . We obtain  $\hat{\mathcal{V}}_f = \mathbb{T}^2$ ,  $beh(f) = 2$ ,  $\#\Sigma_0 = 1$ ,  $m = 1$ ,  $\#\Sigma_1 = 1$  and  $\hat{U}_\sigma$  is an annulus which winds around twice along the torus  $\hat{\mathcal{V}}_f$  as  $\nu_\sigma = -$ . To see this, notice that  $f$  induces an action on  $\mathcal{V}_f^*$  which corresponds to the composition of a radial contraction and a half revolution around 0. Therefore the inner and outer circle drawn in  $\mathcal{V}_f^*$  are identified by a half revolution.

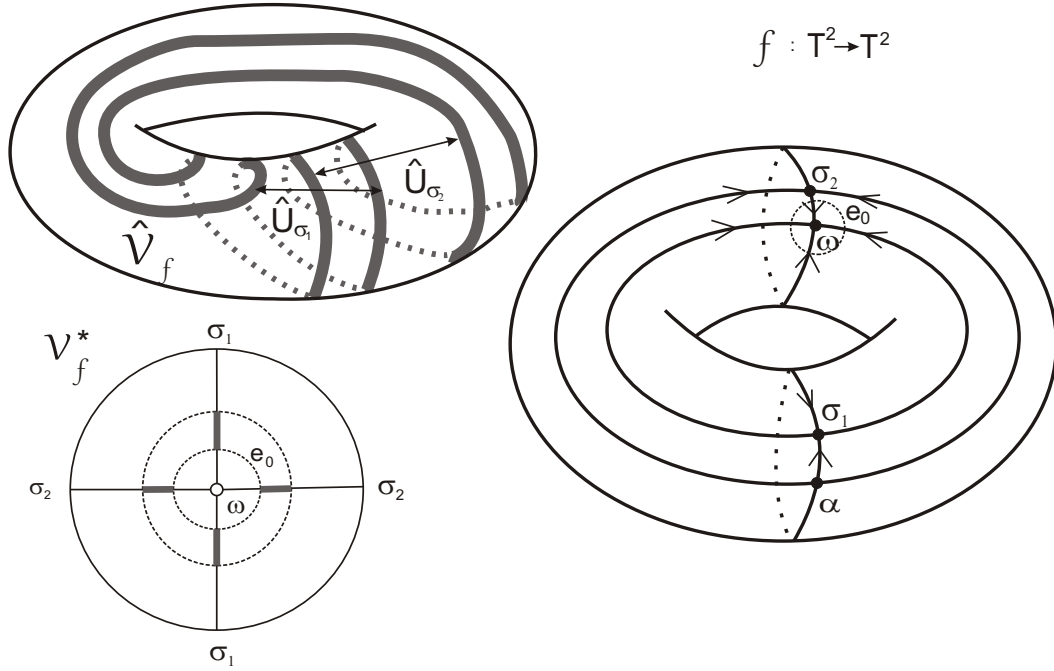

Figure 18: The scheme  $S_f$  associated to a diffeomorphism  $f_S \in MS(\mathbb{T}^2)$  for which the multipliers at the attractor  $\omega$  are negative, and the two separatrices of both saddles are permuted by  $f$ . See Example 2 for a further discussion.

### 3.5 Examples of schemes associated to non-gradient MS-diffeomorphisms

Up to now we only considered gradient MS-diffeomorphisms. Let us now consider two non-gradient systems:

**Example 5** (Figure 27). The scheme of the MS diffeomorphism  $f: S^2 \rightarrow S^2$  from Figure 27. Here  $\hat{\mathcal{V}}_f = \mathbb{T}^2$ ,  $beh(f) = 3$ ,  $\#\Sigma_0 = 1$ ,  $m = 1$ ,  $\#\Sigma_i = 1$ ,  $i = 1, 2$ . The sets  $\hat{U}_{\sigma_i}$ ,  $i = 2, 3$  are no longer annuli in  $\hat{\mathcal{V}}_f$ .

**Example 6** (Figures 1,15,21). The scheme of the MS diffeomorphism  $f: S^2 \rightarrow S^2$  from Figures 1 and 15 is represented in Figure 21. Here  $\hat{\mathcal{V}}_f = \mathbb{T}^2$ ,  $beh(f) = 4$ ,  $\#\Sigma_0 = 1$ ,  $m = 1$ ,  $\#\Sigma_i = 1$ ,  $i = 1, 2, 3$ . The sets  $\hat{U}_{\sigma_i}$ ,  $i = 2, 3$  are no longer annuli in  $\hat{\mathcal{V}}_f$ .

As the last example shows, the scheme for non-gradient like MS diffeomorphisms can in general become quite complicated. Moreover it is much less easy to see how to reconstruct  $f$  from the scheme. For this reason we will introduce the notion of a *decomposed scheme* of a MS diffeomorphism in the next section.

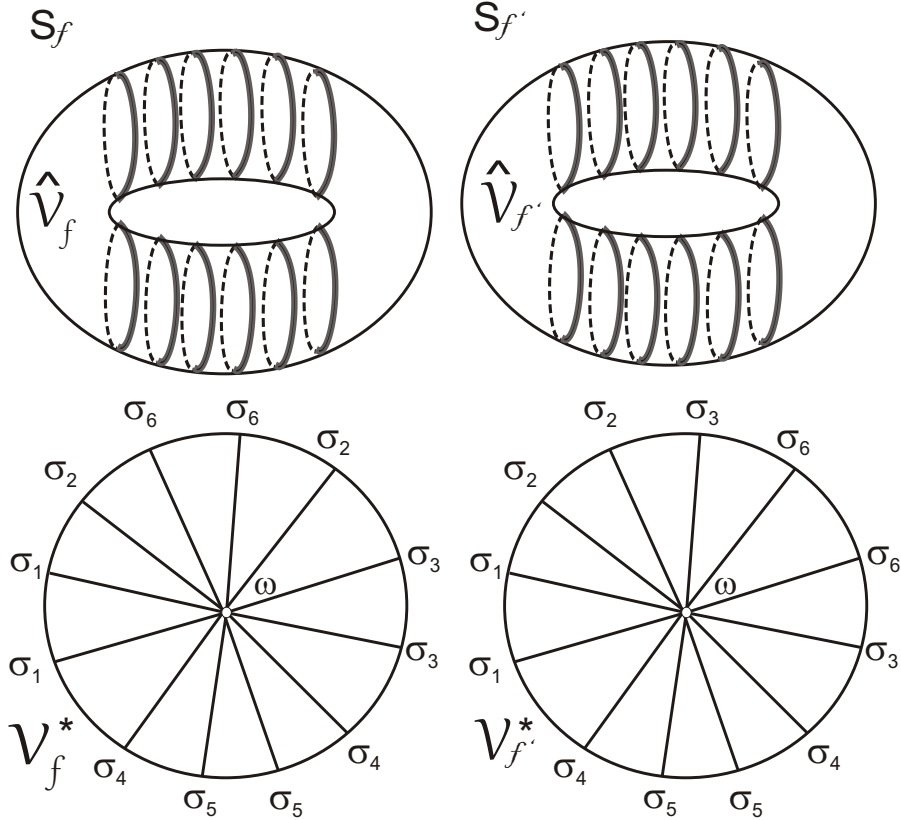

Figure 19: The schemes associated to the diffeomorphisms  $f, f'$  from Figure 5. For the schemes to be equivalent in the sense of Definition 6, each pair of thickened curves corresponding to  $\hat{U}_{\sigma_i}$  for  $f$  has to correspond to a pair associated to  $f'$ . Since there is no homeomorphism between the two tori preserving the pairs of annuli, by Theorem 2 below, the diffeomorphisms  $f, f'$  are not topologically conjugated. See Example 3 for a further discussion.

## 4 The decomposed scheme and realising abstract versions of such schemes by MS diffeomorphisms

In this section we will associate a *decomposed scheme* to a MS surface diffeomorphism. For a gradient-like MS diffeomorphism this decomposed scheme coincides with the scheme defined in the previous section, but for non-gradient-like diffeomorphisms it consists of more, but simpler, pieces.

It turns out that there one can give a few simple rules which determine whether or not an abstract version of such a decomposed scheme determines again a MS diffeomorphism.

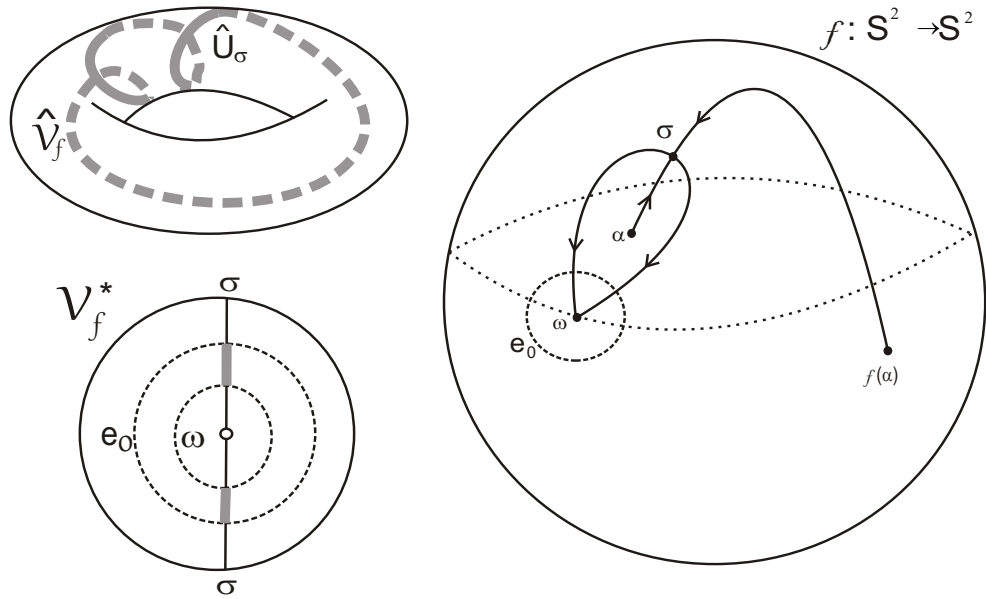

Figure 20: The scheme  $S_f$  associated to a diffeomorphism  $f_S \in MS(\mathbb{S}^2)$  for which the multipliers at the attractor  $\omega$  are negative, and the two separatrices of unique saddle are permuted by  $f$ . See Example 4 for a further discussion.

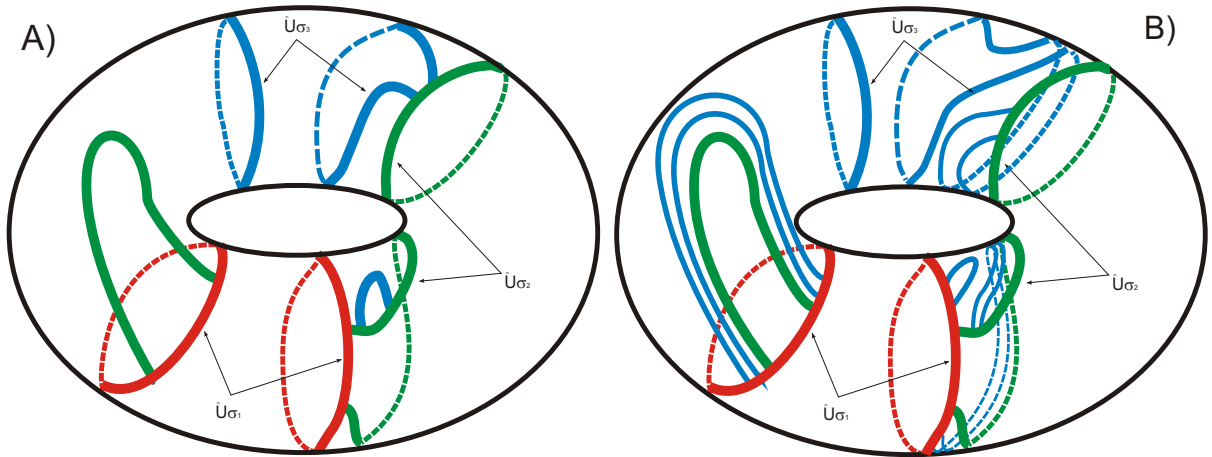

Figure 21: A) The scheme associated to the diffeomorphism  $f$  from Figures 1A) and 15 with  $beh(f) = 4$ . Here the torus is obtained by identifying, by  $f$ , the dashed curves in Figure 15A) forming the boundary of the fundamental annulus of the sink  $\omega$ . B) The projection to the  $\hat{V}_f$  of non-maximal  $u$ -compatible neighborhoods from Figures 15 B) for the same diffeomorphism. The projections A) and B) are not homeomorphic, showing why it is important to consider maximal  $u$ -compatible neighborhoods.

## 4.1 The decomposed scheme of a MS diffeomorphism and the statement of Theorem 2'

For non gradient-like diffeomorphisms, it will be useful to introduce additional factor spaces. Namely, let  $A_0 = \Omega_f^0$  and for each  $i \in \{1, \dots, beh(f) - 1\}$  let us define

$$A_i = A_0 \cup \bigcup_{j=0}^i W_j^u, \quad \mathcal{V}_i = W_{\Omega_f \cap A_i}^s \setminus A_i.$$

Observe that  $A_i$  is an attractor of  $f$  and  $f$  acts freely on  $\mathcal{V}_i$ . Set  $\hat{\mathcal{V}}_i = \mathcal{V}_i/f$  and denote the natural projection by

$$p_i : \mathcal{V}_i \rightarrow \hat{\mathcal{V}}_i.$$

Notice that  $\hat{\mathcal{V}}_0 = \hat{\mathcal{V}}_f$  and  $p_0 = p_f$ . It will be proved in Section 5 that each connected component  $\hat{V}_{i,j}$  of  $\hat{\mathcal{V}}_i$  is a torus,  $p_i$  is a covering map and that  $p_i^{-1}(\hat{V}_{i,j})$  is again homeomorphic to  $V_{i,j}^* = (\mathbb{R}^2 \setminus 0) \times \mathbb{Z}_{m_{i,j}}$  where  $m_{i,j}$  is the period of the corresponding components of  $A_i$ . As before we define a morphism  $\eta_i : \pi_1(\hat{\mathcal{V}}_i) \rightarrow \mathbb{Z}$ , an equator  $e_{i,j}$  on  $\hat{V}_{i,j}$  and  $\mathcal{V}_i^* = \bigcup_j V_{i,j}^*$ .

For each  $i \in \{1, \dots, beh(f) - 1\}$  let  $\mathcal{G}_i = W_{\Sigma_i}^s \setminus \Sigma_i$  and  $\hat{\mathcal{G}}_i = p_i(\mathcal{G}_i)$ . The *decomposed scheme* associated to  $f$  is

$$S_i = (\hat{\mathcal{V}}_i, \eta_i, \hat{\mathcal{G}}_i), i = 1, \dots, beh(f) - 1.$$

**Definition 7** (Equivalence of decomposed schemes). Two decomposed schemes  $S_i$  and  $S'_i$  are *equivalent* if there exist orientation preserving homeomorphisms  $\hat{\varphi}_i : \hat{\mathcal{V}}_i \rightarrow \hat{\mathcal{V}}'_i$ ,  $i = 1, \dots, beh(f) - 1$  such that:

- (1)  $\eta'_i \hat{\varphi}_{i*} = \eta_i$ ;
- (2)  $\hat{\varphi}(\hat{\mathcal{G}}_i) = \hat{\mathcal{G}}'_i$ , moreover for every point  $\sigma \in \Sigma_i$  there is a point  $\sigma' \in \Sigma'_i$  such that  $\varphi_i^*(W_{\sigma}^{s*}) = W_{\sigma'}^{s*}$ , where  $\varphi_i^* : \mathcal{V}_i^* \rightarrow \mathcal{V}'_i^*$  is the lift of  $\hat{\varphi}_i$ .

Let  $\mathcal{N}_f = \{N_\sigma, \sigma \in \Sigma\}$  be a maximal  $u$ -compatible system of neighborhoods for a diffeomorphism  $f \in MS(M^2)$ ,  $\mathcal{N}_i = \bigcup_{\sigma \in \Sigma_i} N_\sigma$  for  $i \in \{1, \dots, beh(f) - 1\}$ .

Analogously to Theorem 2 we have

**Theorem 2'**. Two diffeomorphisms  $f, f' \in MS(M^2)$  are topologically conjugate iff their decomposed schemes  $S_f, S_{f'}$  are equivalent.

We also will define an abstract version of a decomposed scheme. Theorem 3 states that an *abstract* decomposed scheme is equivalent to a decomposed scheme of a diffeomorphism  $f \in MS(M^2)$  if and only if Definitions 8 and 9 are satisfied.

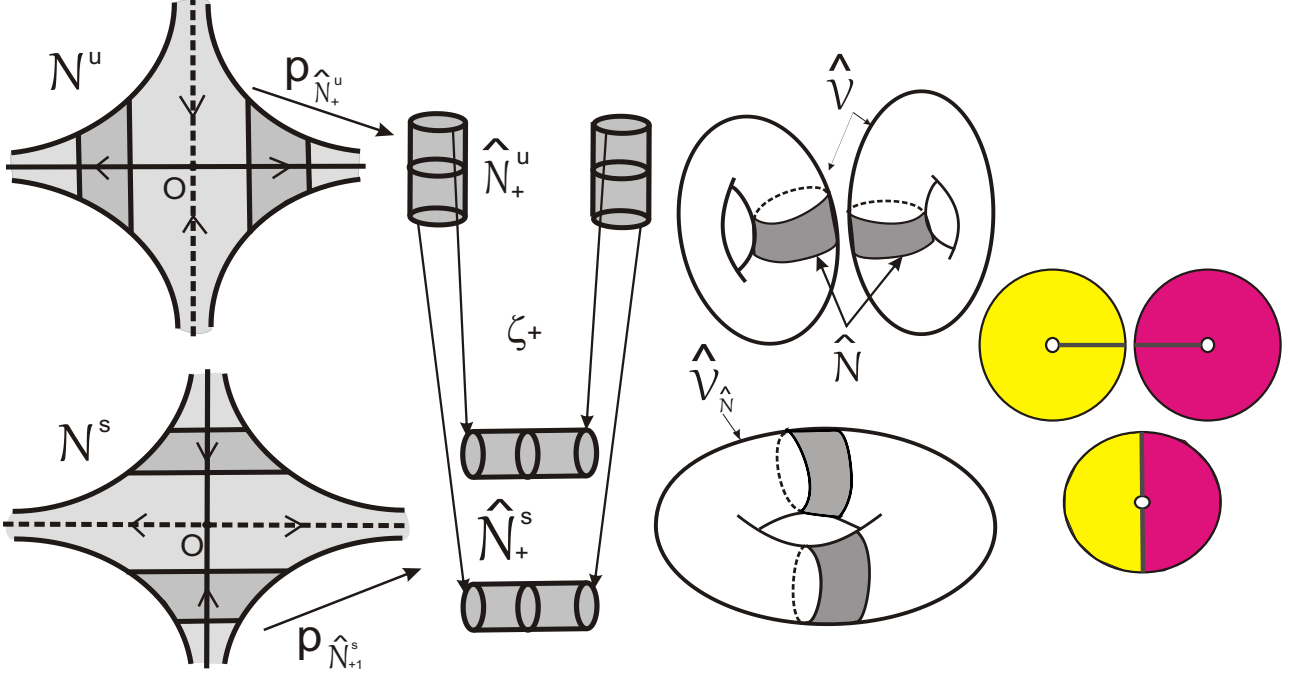

Figure 22: Cut & paste operations

## 4.2 Cut & paste operations and examples of decomposed schemes

**Cut & paste operations.** For every diffeomorphism  $f \in MS(M^2)$  the set  $\hat{\mathcal{V}}_{i-1}$  can be obtained from  $\hat{\mathcal{V}}_i$  by a cut & paste operation. Indeed, notice that the manifolds  $\hat{\mathcal{V}}_i \setminus p_i(W_i^s)$  and  $\hat{\mathcal{V}}_{i-1} \setminus p_{i-1}(W_i^u)$  are homeomorphic by the homeomorphism  $\phi_i = p_i p_{i-1}^{-1}$ . Also the manifolds  $\hat{\mathcal{V}}_i \setminus p_i(\mathcal{N}_i)$  and  $\hat{\mathcal{V}}_{i-1} \setminus p_{i-1}(\mathcal{N}_i)$  are homeomorphic by  $\phi_i$ . Each connected component  $\hat{\mathcal{N}}_\sigma$  of the set  $\hat{\mathcal{N}}_i$  is homeomorphic to  $\hat{N}_{\nu_\sigma}^u$  by means  $\mu_{\hat{\mathcal{N}}_\sigma} = p_{\hat{N}_{\nu_\sigma}^u} \mu_\sigma p_{i-1}^{-1}$  and each connected component  $\hat{\mathcal{N}}_\sigma^s$  of the set  $\hat{\mathcal{N}}_i^s$  is homeomorphic to  $\hat{N}_{\nu_\sigma}^s$  by means  $\mu_{\hat{\mathcal{N}}_\sigma^s} = p_{\hat{N}_{\nu_\sigma}^s} \mu_\sigma p_i^{-1}$ . Thus  $\hat{\mathcal{V}}_{i-1}$  formally can be obtained from  $\hat{\mathcal{V}}_i$  by a regluing of annuli  $\hat{\mathcal{V}}_i \setminus \hat{\mathcal{G}}_i$  or regluing of sectors  $\mathcal{V}_i^* \setminus \mathcal{G}_i$  (see Figure 22).

For example for a gradient-like case we have only two spaces  $\mathcal{V}_0$  which is a union of basins of the sink points and  $\mathcal{V}_1$  which is a union of basins of the source points. The transition from  $\mathcal{V}_1$  to  $\mathcal{V}_0$  consists of a consequent execution of cut & paste operations along every saddle orbits. How we will see below the transition along one saddle orbit is of three types:

1. The stable separatrices of a saddle periodic orbit with *negative multipliers* enter the basin of a periodic attractor, see Figure 23.
2. The stable separatrices of a saddle periodic orbit with *positive multipliers* enter the basin of a periodic attractor, see Figure 24.
3. The stable separatrices of a saddle periodic orbit with *positive multipliers* belong to the basins of different periodic attractors, see Figure 25.

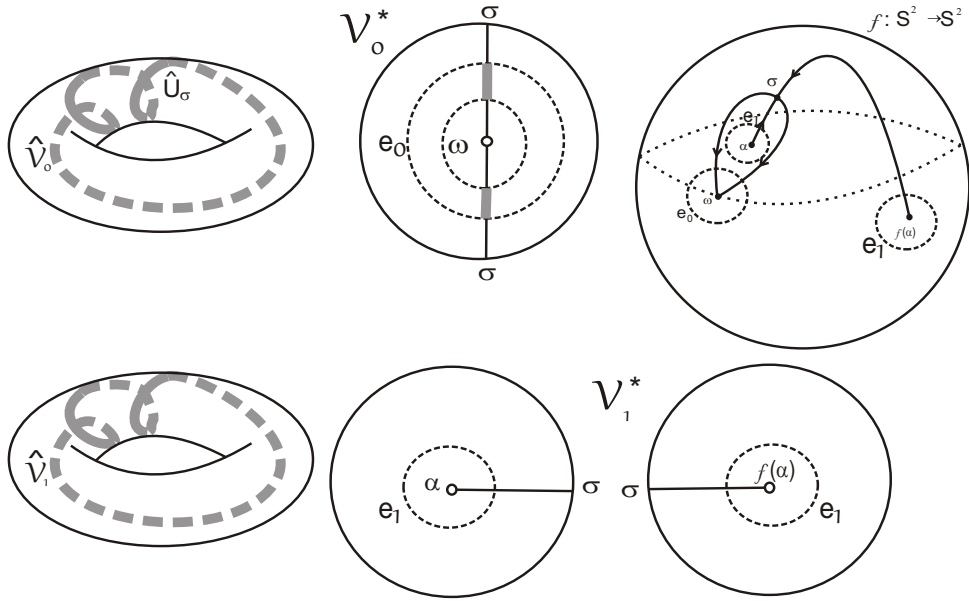

Figure 23: The transition of the type 1 from  $\mathcal{V}_1$  to  $\mathcal{V}_0$  for the diffeomorphism  $f_S \in MS(\mathbb{S}^2)$  from Figure 20 for which the multipliers at the saddle point  $\sigma$  are negative, and the two separatrices of unique saddle are permuted by  $f$

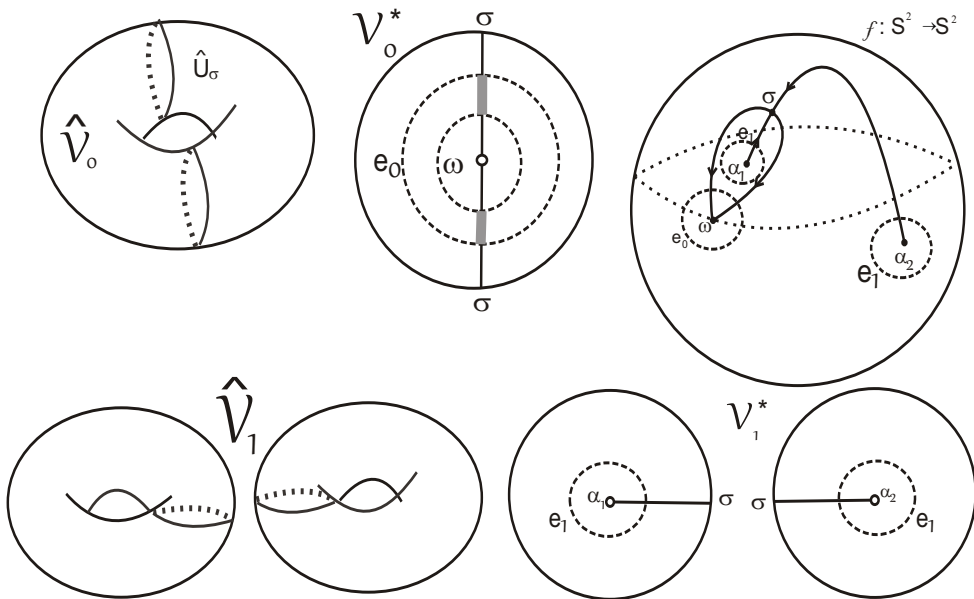

Figure 24: The transition of the type 2 from  $\mathcal{V}_1$  to  $\mathcal{V}_0$  for the diffeomorphism  $f_S \in MS(\mathbb{S}^2)$  for which the multipliers at the saddle point  $\sigma$  are positive, and the two separatrices to a basin of the same sink point  $\omega$

If there are several saddles with the separatrices entering the basins of sinks then we have to cut and paste several things at once, see Figure 26.

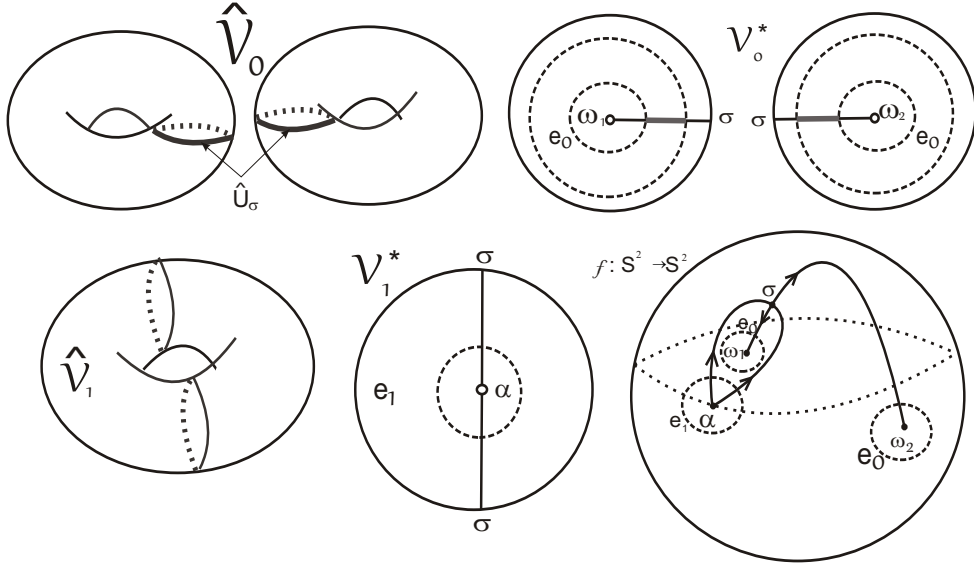

Figure 25: The transition of the type 3 from  $\mathcal{V}_1$  to  $\mathcal{V}_0$  for the diffeomorphism  $f_S \in MS(\mathbb{S}^2)$  for which the multipliers at the saddle point  $\sigma$  are positive, and the two separatrices to basins of different sink points  $\omega_1, \omega_2$

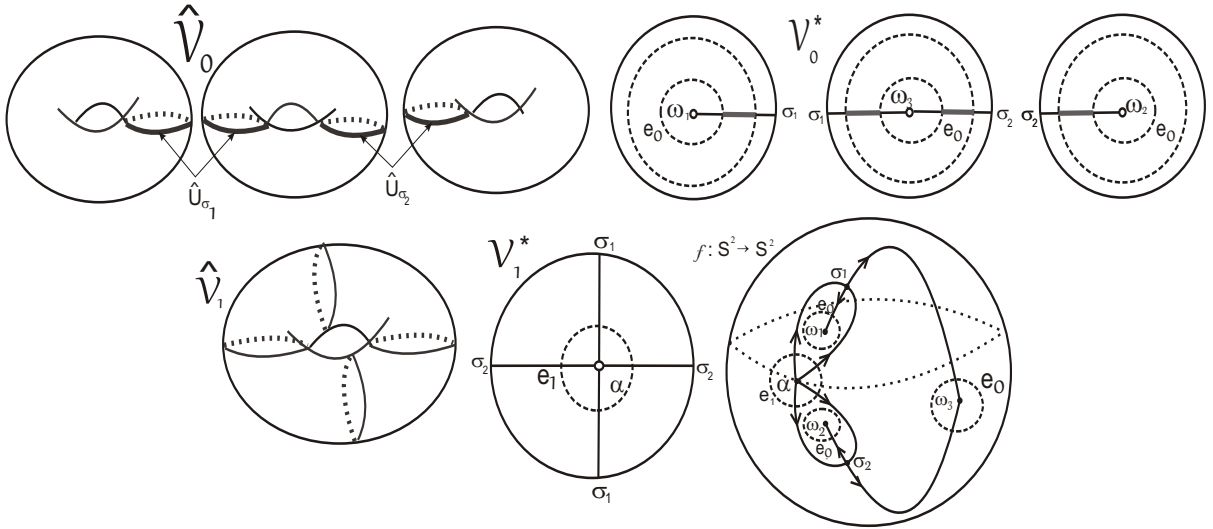

Figure 26: The transition from  $\mathcal{V}_1$  to  $\mathcal{V}_0$  for the diffeomorphism  $f_S \in MS(\mathbb{S}^2)$  for which there are several saddles with the separatrices entering the basins of sinks.

For a non gradient-like case there are more than one successive transitions (see Figure 27) but every transition along one saddle orbit is of one of these three types.

**Example 7** (Figure 27). Consider the MS-diffeomorphism  $f$  shown in the top-right of Figure 27 with  $beh(f) = 3$ .

- The set  $\mathcal{V}_0 = W_\omega^s \setminus \omega$  is homeomorphic to  $\mathbb{R}^2 \setminus O$ . We draw two equators  $e_0$  in  $\mathcal{V}_0^*$  which



bound an annulus. The torus  $\hat{\mathcal{V}}_0$  is obtained by identifying the boundary curves of this annulus. We also add two curves  $e_1$  both on the left and right side of  $\mathcal{V}_0^*$ , corresponding to curves  $e_1$  in  $\mathbb{S}^2$  (and corresponding to equators on the tori  $\mathcal{V}_1$ ).

- The attractor  $A_1 = W_{\sigma_1}^u \cup \omega$  is a circle, and its basin  $\mathcal{V}_1$  consists of two components, each topologically a punctured disc, and so each contains two equators  $e_1$ .
- The attractor  $A_2 = W_{\sigma_2}^u \cup W_{\sigma_1}^u \cup \omega$ , whose basin consists of three components surrounding  $\alpha_1, \alpha_2, \alpha_3$ , each topologically a punctured disc, and so each contains three equators  $e_2$ .
- Now it is easy to reconstruct the original diffeomorphism from the decomposed scheme as follows: we identify the parts of the boundary in  $\mathcal{V}_1^*, \mathcal{V}_2^*$  as suggested by the labelling of saddle separatrices and after that take the connected sum of  $\mathcal{V}_0^*, \mathcal{V}_1^*, \mathcal{V}_2^*$  as suggested by the labelling of equators.

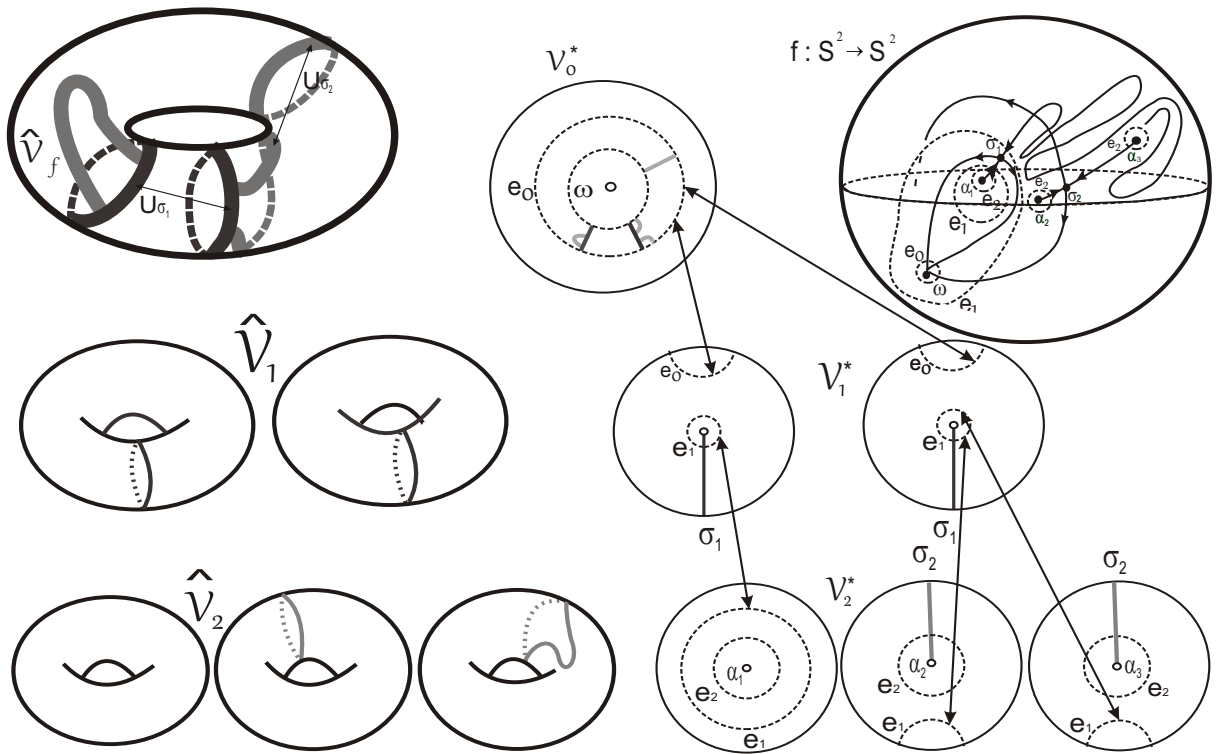

Figure 27: On the top left the scheme  $S_f$  is represented of the diffeomorphism  $f_S \in MS(\mathbb{S}^2)$  on the top right. The corresponding decomposed scheme consists of two objects  $\hat{\mathcal{V}}_1, \hat{\mathcal{V}}_2$  with circles on them. Here  $\hat{\mathcal{V}}_1$  ( $\hat{\mathcal{V}}_0$ ) is obtained by cutting and gluing along the circles in the torus  $\hat{\mathcal{V}}_2$  ( $\hat{\mathcal{V}}_1$ ). The sets  $\mathcal{V}_0^*, \mathcal{V}_1^*, \mathcal{V}_2^*$  are explained Example 7, as is the construction how these can be used to get back the original diffeomorphism  $f$ . Namely we have to identify the parts of the boundary in  $\mathcal{V}_1^*, \mathcal{V}_2^*$  as suggested by the labelling of saddle separatrices and after that take the connected sum of  $\mathcal{V}_0^*, \mathcal{V}_1^*, \mathcal{V}_2^*$  as suggested by the labelling of equators.

**Example 8** (The decomposed scheme associated to the diffeomorphism from Figures 1A) and 15 with  $beh(f) = 4$ .) Consider the MS-diffeomorphism  $f$  shown in the top-left of Figure 28 with  $beh(f) = 4$ .

- The set  $\mathcal{V}_0 = W_\omega^s \setminus \omega$  is homeomorphic to  $\mathbb{R}^2 \setminus O$ . We draw two equators  $e_0$  in  $\mathcal{V}_0^*$  which bound an annulus. The torus  $\hat{\mathcal{V}}_0$  is obtained by identifying the boundary curves of this annulus. We also add two curves  $e_1$  both on the left and right side of  $\mathcal{V}_0^*$ , corresponding to curves  $e_1$  in  $\mathbb{S}^2$  (and corresponding to equators on the tori  $\mathcal{V}_1$ ).
- The attractor  $A_1 = W_{\sigma_1}^u \cup \omega$  is a circle, and its basin  $\mathcal{V}_1$  consists of two components, each topologically a punctured disc, and so each contains two equators  $e_1$ .
- The attractor  $A_2 = W_{\sigma_2}^u \cup W_{\sigma_1}^u \cup \omega$ , whose basin consists of three components surrounding  $\alpha_1, \alpha_2, \alpha_3$ , each topologically a punctured disc, and so each contains three equators  $e_2$ .
- The attractor  $A_3 = W_{\sigma_3}^u \cup W_{\sigma_2}^u \cup W_{\sigma_1}^u \cup \omega$ , whose basin consists of four components surrounding  $\alpha_1, \alpha_2, \alpha_3, \alpha_4$ , each topologically a punctured disc, and so each contains three equators  $e_3$ .
- Now it is easy to reconstruct the original diffeomorphism from the decomposed scheme as follows: we identify the parts of the boundary in  $\mathcal{V}_1^*, \mathcal{V}_2^*, \mathcal{V}_3^*$  as suggested by the labelling of saddle separatrices and after that take the connected sum of  $\mathcal{V}_0^*, \mathcal{V}_1^*, \mathcal{V}_2^*, \mathcal{V}_3^*$  as suggested by the labelling of equators.

In the next subsection we will discuss this cut & paste operation in the setting of some model objects, and show that the decomposed scheme associated to a MS surface diffeomorphism satisfies the compatibility and realizability properties from Definitions 8 and 9 (see Lemma 1 below).

### 4.3 Abstract decomposed schemes defined through model objects

Let  $m \geq 1$  be an integer and  $V_m = \mathbb{S}^1 \times \mathbb{R}^+ \times \mathbb{Z}_m$ . Thus  $V_m$  is a model for the basin of a periodic attractor (equivalently the basin of dual repeller) of *period*  $m$ . Let  $k \in \mathbb{N}$ , an integer  $n \geq 0$  so that  $n = 0$  if  $k = 1$  and otherwise  $n \in \{1, \dots, k-1\}$  so that  $n$  and  $mk$  are coprime. Here  $k$  models the number of saddle stable separatrices in each connected component of  $V_m$  and  $\frac{n}{k}$  represents their ‘rotation number’, i.e., how the diffeomorphism permutes these separatrices. As a local model for the diffeomorphism on the basin we take the contraction  $\phi_{m,k,n} : V_m \rightarrow V_m$  given by the formula:

$$\phi_{m,k,n}(z, r, l) = (e^{\frac{2\pi n}{mk}i} z, \frac{r}{2^m}, l + 1(\text{mod } m)).$$

Let  $t \in [0, \frac{1}{k})$ ,  $j \in \{0, \dots, mk-1\}$ ,  $\gamma^j = \phi_{m,k,n}^j(e^{i2\pi t} \times \mathbb{R}^+ \times \{0\})$  and

$$\gamma = \bigcup_{j=0}^{mk-1} \gamma^j.$$

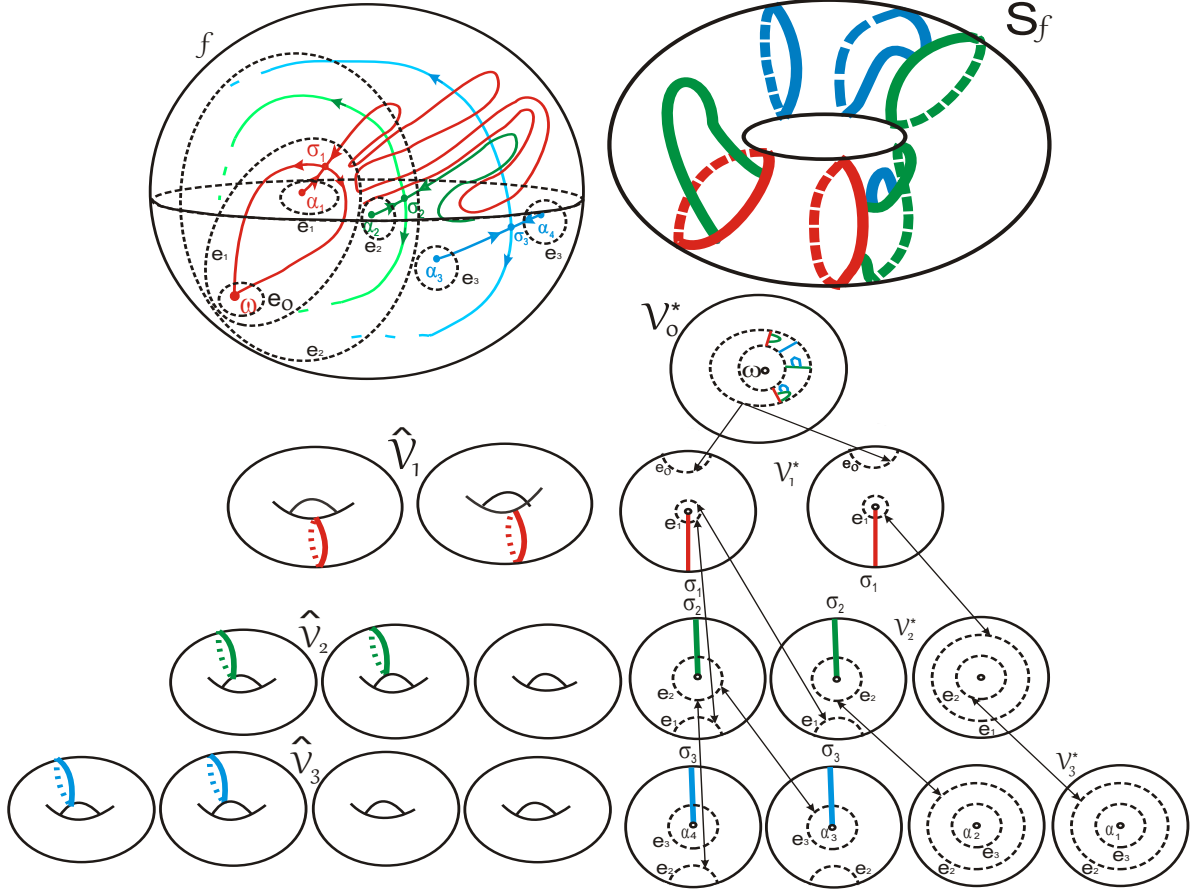

Figure 28: On the top right the scheme  $S_f$  is represented of the diffeomorphism  $f_S \in MS(\mathbb{S}^2)$  on the top left. The corresponding decomposed scheme consists of two objects  $\hat{V}_1, \hat{V}_2, \hat{V}_3$  with circles on them. Here  $\hat{V}_2$  ( $\hat{V}_1, \hat{V}_0$ ) is obtained by cutting and gluing along the circles in the torus  $\hat{V}_3$  ( $\hat{V}_2, \hat{V}_1$ ). The sets  $\mathcal{V}_0^*, \mathcal{V}_1^*, \mathcal{V}_2^*, \mathcal{V}_3^*$  are explained Example 8, as is the construction how these can be used to get back the original diffeomorphism  $f$ . Namely we have to identify the parts of the boundary in  $\mathcal{V}_1^*, \mathcal{V}_2^*, \mathcal{V}_3^*$  as suggested by the labelling of saddle separatrices and after that take the connected sum of  $\mathcal{V}_0^*, \mathcal{V}_1^*, \mathcal{V}_2^*, \mathcal{V}_3^*$  as suggested by the labelling of equators.

Thus  $t$  defines the angle of a ray  $\gamma^0$  in  $V_m$  and  $\gamma$  is  $\phi_{m,k,n}$ -invariant union of rays, containing  $\gamma^0$ , which we will refer to as a ‘frame’. So  $\gamma$  models a saddle stable separatrix of period  $mk$ . Notice that  $\hat{V}_m = V_m/\phi_{m,k,n}$  is a torus. Denote by  $p_{m,k,n} : V_m \rightarrow \hat{V}_m$  the natural projection. The set  $\hat{\gamma} = p_{m,k,n}(\gamma)$  is a knot on  $\hat{V}_m$ . Let  $e = \mathbb{S}^1 \times \{1\} \times \{0\}$  and  $\hat{e} = p_{m,k,n}(e)$ . Denote by  $\eta_{\hat{V}_m} : \pi_1(\hat{V}_m) \rightarrow m\mathbb{Z}$  an epimorphism given by conditions:  $\eta_{\hat{V}_m}([\hat{e}]) = 0$  and  $\eta_{\hat{V}_m}([\hat{\gamma}]) = km$ .

**Three types of collections of model objects.** Let  $\mathcal{V}, \Gamma, \tau, h_\tau$  be a collection of one of the following three types:

1.  $\mathcal{V}$  is  $V_m$  for some  $m$ ,  $\Gamma$  is  $\phi_{m,k,n}$ -invariant frame  $\gamma$  for some  $k, n$  with  $km$  is even,  $\tau = \frac{mk}{2}$ ,  $h_\tau$  identifies the rays  $\gamma^j$  and  $\gamma^{\tau+j}$  for every  $j \in \{0, \dots, \frac{km}{2} - 1\}$ , so that  $h_\tau$  is equal to

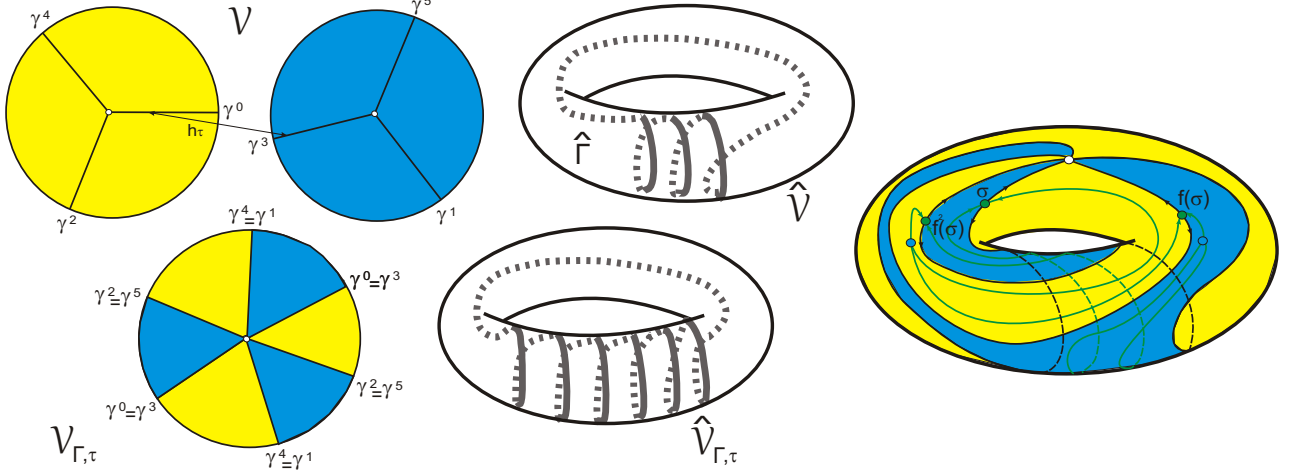

Figure 29: The *first* type of  $\mathcal{V}$ ,  $\Gamma$ ,  $h_\tau$  for  $m = 2, k = 3, n = 1, \tau = 3$ . Here  $\hat{\mathcal{V}}_{\Gamma, \tau}$  is a unique torus with  $m_{\Gamma, \tau} = 1$  and a knot with 6 rotations as a projection of frame. On the left we can see realization of this part of dynamics on torus. Here blue points are a new attractor, which consists of two components of the period two and blue point with the union of green arcs is an old attractor of the period one.

identity with respect to the coordinate in  $\mathbb{R}^+$ , i.e.,  $h(z, r, l) = (?, r, ?)$  for all  $(z, r, l) \in V_m$ . This case models the situation where the stable separatrices of a saddle periodic orbit with *negative multipliers* enter the basin of a periodic attractor of period  $m$  so that  $\gamma^j$  and  $\gamma^{\tau+j}$  correspond to the stable separatrices of one saddle point, see Figure 29.

2.  $\mathcal{V}$  is  $V_m$  for some  $m$ ,  $\Gamma$  is a *pair* of  $\phi_{m, k, n}$ -invariant pairwise disjoint frames  $\gamma_1, \gamma_2$  for some  $k, n, \tau \in \{0, \dots, km - 1\}$ ,  $h_\tau$  identifies the rays  $\gamma_1^j$  and  $\gamma_2^{\tau+j}$  for every  $j \in \{0, \dots, km - 1\}$ , where  $h_\tau$  identity with respect to the coordinate in  $\mathbb{R}^+$ . This case models stable separatrices of a saddle periodic orbit with *positive multipliers* enter the basin of a periodic attractor of period  $m$  so that  $\gamma_1^j$  and  $\gamma_2^{\tau+j}$  correspond to the separatrices of one saddle point, see Figure 30.
3.  $\mathcal{V}$  is a disjoint union of  $V_{m_1}$  and  $V_{m_2}$  for some  $m_1, m_2$ ,  $\Gamma$  is a pair of  $\phi_{m_1, k_1, n_1}$ - and  $\phi_{m_2, k_2, n_2}$ -invariant pairwise disjoint frames  $\gamma_1 \subset V_{m_1}, \gamma_2 \subset V_{m_2}$  for some  $k_1, n_1, k_2, n_2$  with  $m_1 k_1 = m_2 k_2, \tau \in \{0, \dots, k_1 m_1 - 1\}$ ,  $h_\tau$  identifies the rays  $\gamma_1^j$  and  $\gamma_2^{\tau+j}$  for every  $j \in \{0, \dots, k_1 m_1 - 1\}$  identity with respect to the coordinate in  $\mathbb{R}^+$ . This case models stable separatrices of a saddle periodic orbit with *positive multipliers* so that  $\gamma_1^j$  and  $\gamma_2^{\tau+j}$  correspond to two separatrices of one saddle belonging to the basins of different periodic attractors, see Figure 31.

For every type denote by  $\hat{\mathcal{V}}$  the corresponding space orbit, by  $p_{\hat{\mathcal{V}}} : \mathcal{V} \rightarrow \hat{\mathcal{V}}$  the natural projection, by  $\hat{\Gamma}$  the projection of  $\Gamma$  and by  $\eta_{\hat{\mathcal{V}}}$  a map composed by the corresponding epimorphisms.

**Cut & paste operations to obtain  $\mathcal{V}_{\Gamma, \tau}$ .** Denote by  $\mathcal{V}_{\Gamma, \tau}$  the space obtained by regluing the closures of sectors in  $\mathcal{V} \setminus \Gamma$  along the boundary with respect to  $h_\tau$  (see Figures 29-31 in the

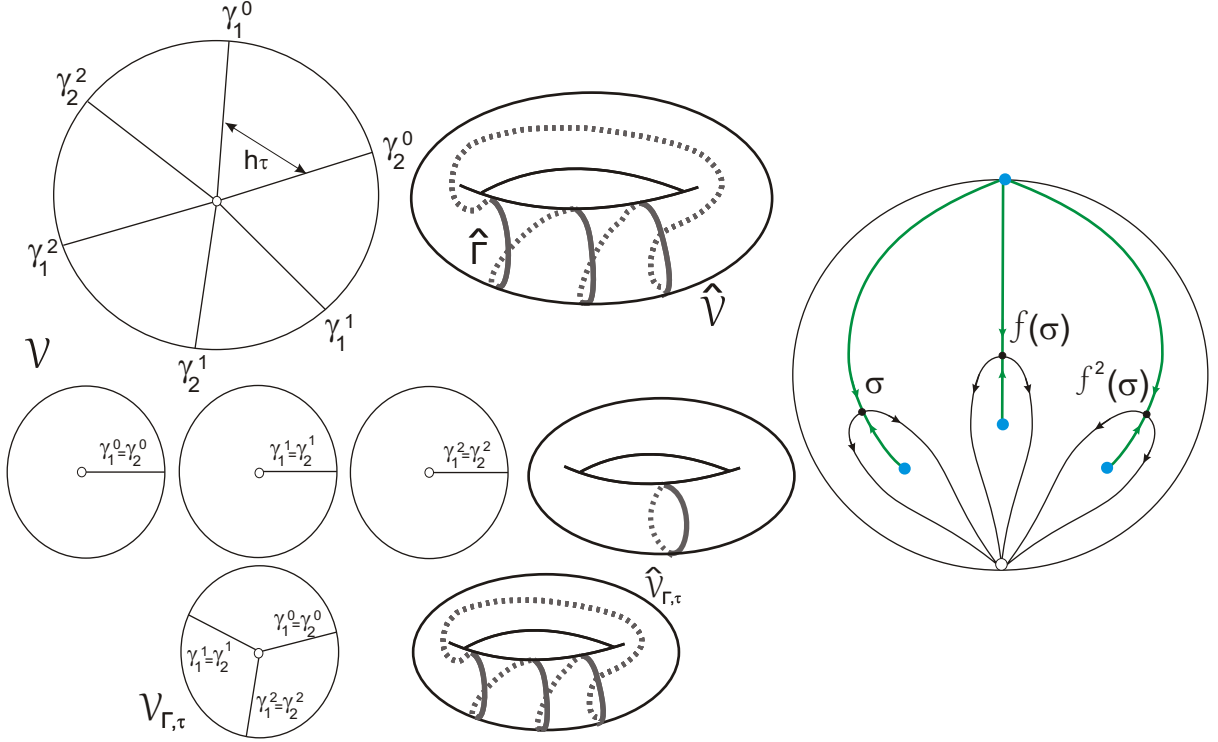

Figure 30: The *second* type of  $\mathcal{V}$ ,  $\Gamma$ ,  $h_\tau$  for  $m = 1, k = 3, n = 1, \tau = 0$ . Here  $\hat{\mathcal{V}}_{\Gamma, \tau}$  consists of two tori with  $m_{\Gamma, \tau, 1} = 3, m_{\Gamma, \tau, 2} = 1$  and two knots with 1 and 3 rotations as a projection of frame. On the left we can see realization of this part of dynamics on 2-sphere. Here blue points are a new attractor, which consists of one fixed component and other component of the period three and blue point with the union of three green arcs is an old attractor of the period one.

bottom). It follows from the definition of  $h_\tau$  that every connected component of the set  $\mathcal{V}_{\Gamma, \tau}$  is homeomorphic to  $\mathbb{S}^1 \times \mathbb{R}^+$ . As the homeomorphism  $h_\tau$  commutes with  $\phi_{m, k, n}$  (conjugates  $\phi_{m_1, k_1, n_1}$  with  $\phi_{m_2, k_2, n_2}$ ) there is a diffeomorphism  $\phi_{\Gamma, \tau} : \mathcal{V}_{\Gamma, \tau} \rightarrow \mathcal{V}_{\Gamma, \tau}$  which permutes the connected components.

Let  $\hat{\mathcal{V}}_{\hat{\Gamma}, \tau} = \mathcal{V}_{\Gamma, \tau} / \phi_{\Gamma, \tau}$  and  $p_{\hat{\mathcal{V}}_{\hat{\Gamma}, \tau}} : \mathcal{V}_{\Gamma, \tau} \rightarrow \hat{\mathcal{V}}_{\hat{\Gamma}, \tau}$  be the natural projection. By construction  $\hat{\mathcal{V}}_{\hat{\Gamma}, \tau}$  is obtained by regluing the closures of annuli in  $\hat{\mathcal{V}} \setminus \hat{\Gamma}$  along the boundary with respect to the projection of  $h_\tau$ . The set  $\hat{\mathcal{V}}_{\hat{\Gamma}, \tau}$  consists of one torus (resp. is a union of two tori) for the first and third types (resp. the second type). It means that  $\phi_{\Gamma, \tau}$  forms the unique orbit (resp. two orbits) from the connected components of the set  $\mathcal{V}_{\Gamma, \tau}$ . Denote by  $m_{\Gamma, \tau}$  its period (resp.  $m_{\Gamma, \tau, 1}, m_{\Gamma, \tau, 2}$  their periods) and by  $\eta_{\hat{\mathcal{V}}_{\hat{\Gamma}, \tau}}$  the corresponding epimorphisms. Thus  $\hat{\mathcal{V}}_{\hat{\Gamma}, \tau}$  models the basin of a new attractor which is the initial attractor with the stable separatrices of the saddle orbit and which has one periodic component of the period  $m_{\Gamma, \tau}$  (two periodic components of the periods  $m_{\Gamma, \tau, 1}, m_{\Gamma, \tau, 2}$ ).

We will say that  $\hat{\mathcal{V}}_{\hat{\Gamma}, \tau}$  is a *result of regluing  $\hat{\mathcal{V}}$  along  $\hat{\Gamma}$  with the parameter  $\tau$* . Thus  $\hat{\mathcal{V}}_{\hat{\Gamma}, \tau}$  is a torus for the first and third types and consists of two tori for the second type.

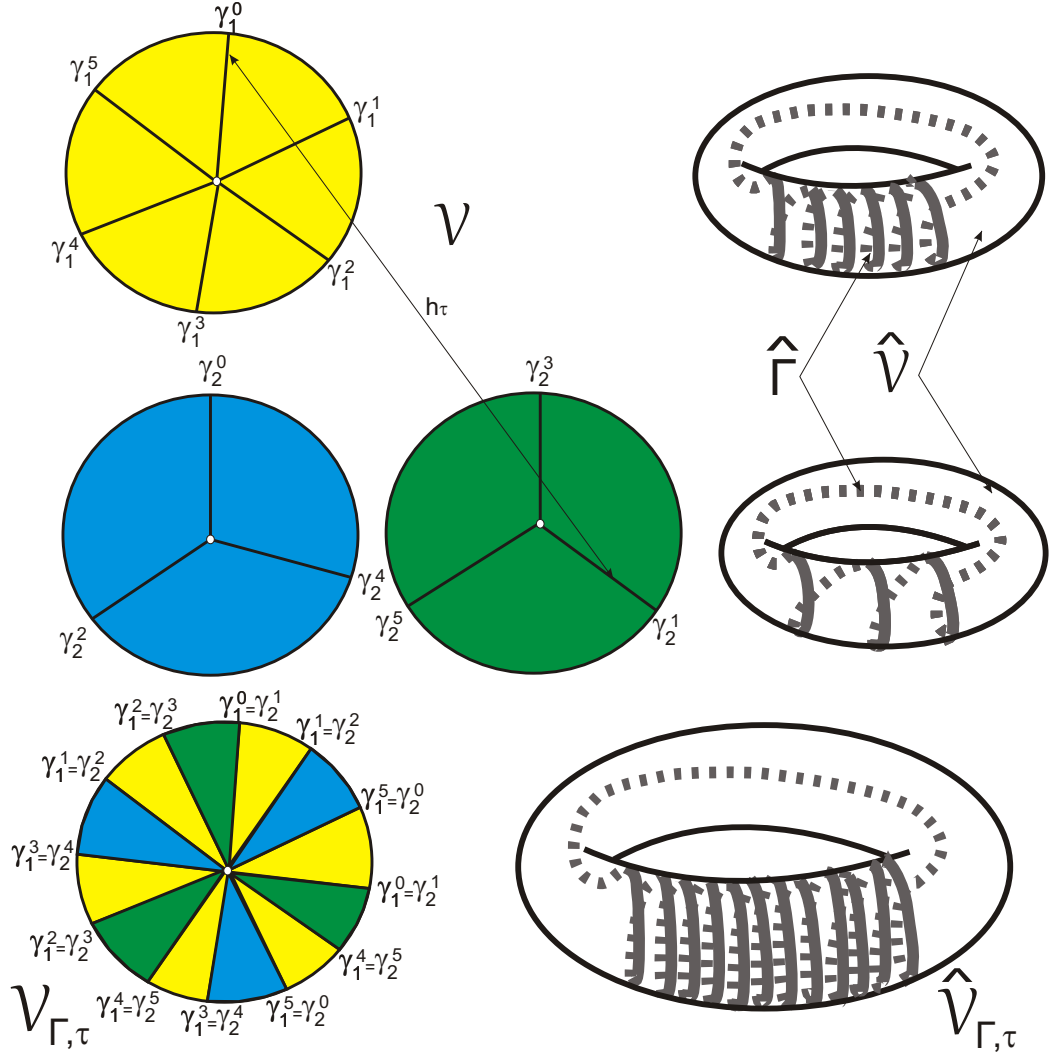

Figure 31: The *third* type of  $\mathcal{V}$ ,  $\Gamma$ ,  $h_\tau$  for  $m_1 = 1, k_1 = 6, m_2 = 2, k_2 = 3, n_1 = n_2 = 1, \tau = 5$ . Here  $\hat{\mathcal{V}}_{\Gamma, \tau}$  is a unique torus with  $m_{\Gamma, \tau} = 1$  and a knot with 12 rotations as a projection of frame. The dynamics can be represented on the surface of the genus 2.

**Cut & paste operations to obtain  $\mathcal{V}_{\hat{\mathcal{G}}, \mathcal{T}}$ .** Let  $\hat{\mathcal{V}}$  be pairwise disjoint tori  $\hat{V}_1, \dots, \hat{V}_l$  with a collection  $\eta_{\hat{V}}$  of epimorphisms  $\eta_1: \pi(\hat{V}_1) \rightarrow m_1\mathbb{Z}, \dots, \eta_l: \pi(\hat{V}_l) \rightarrow m_l\mathbb{Z}$ ,  $\hat{\Gamma}_1, \dots, \hat{\Gamma}_l \subset \hat{\mathcal{V}}$  be pairwise disjoint sets of the described above types with parameters  $\tau_1, \dots, \tau_l$  and

$$\hat{\mathcal{G}} = \bigcup_{i=1}^l \hat{\Gamma}_i, \quad \mathcal{T} = \{\tau_1, \dots, \tau_l\}.$$

We say that the manifold  $\hat{\mathcal{V}}_{\hat{\mathcal{G}}, \mathcal{T}}$  is a result of the regluing of  $\hat{\mathcal{V}}$  along  $\hat{\mathcal{G}}$  with the parameters  $\mathcal{T}$  if we execute the regluing along  $\hat{\Gamma}_i$  with parameter  $\tau_i$  for every  $i$ . Denote by  $p_{\hat{\mathcal{V}}_{\hat{\mathcal{G}}, \mathcal{T}}}: \hat{\mathcal{V}} \rightarrow \hat{\mathcal{V}}_{\hat{\mathcal{G}}, \mathcal{T}}$  the natural projection. Then  $\hat{\mathcal{V}}_{\hat{\mathcal{G}}, \mathcal{T}}$  again consists of a finite number tori on which the regluing

induces a collection of epimorphisms  $\eta_{\hat{\mathcal{V}}_{\hat{\mathcal{G}}}}$ . Notice that the result does not depend on the order in which one does the gluing.

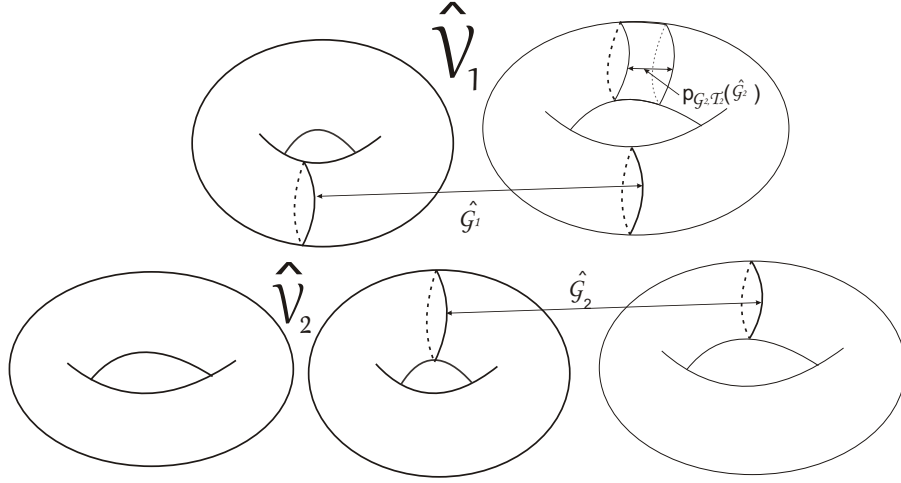

Figure 32: The collection  $(\hat{\mathcal{V}}_1, \eta_{\hat{\mathcal{V}}_1}, \hat{\mathcal{G}}_0, \mathcal{T}_0), (\hat{\mathcal{V}}_2, \eta_{\hat{\mathcal{V}}_2}, \hat{\mathcal{G}}_1, \mathcal{T}_1)$  is not decomposed because  $\hat{\mathcal{G}}_1$  has empty intersection with  $p_{\hat{\mathcal{G}}_2, \mathcal{T}_2}(\hat{\mathcal{G}}_2)$ .

### The notion of an abstract decomposed scheme.

**Definition 8.** We say that a sequence of collections  $(\hat{\mathcal{V}}_1, \eta_{\hat{\mathcal{V}}_1}, \hat{\mathcal{G}}_1, \mathcal{T}_1), \dots, (\hat{\mathcal{V}}_n, \eta_{\hat{\mathcal{V}}_n}, \hat{\mathcal{G}}_n, \mathcal{T}_n)$  is an *abstract decomposed scheme* if for every  $i \in \{2, \dots, n\}$  we have:

- 1)  $(\hat{\mathcal{V}}_i, \eta_{\hat{\mathcal{V}}_i})_{\hat{\mathcal{G}}_i, \mathcal{T}_i} = (\hat{\mathcal{V}}_{i-1}, \eta_{\hat{\mathcal{V}}_{i-1}})$ ;
- 2)  $\hat{\mathcal{G}}_{i-1}$  is transversal to  $\bigcup_{j=0}^{n-i} p_{\hat{\mathcal{G}}_i, \mathcal{T}_i} \circ \dots \circ p_{\hat{\mathcal{G}}_{i+j}, \mathcal{T}_{i+j}}(\hat{\mathcal{G}}_{i+j})$  and every component  $\hat{\Gamma}_{i-1, \ell}$  of  $\hat{\mathcal{G}}_{i-1}$  has nonempty intersection with  $p_{\hat{\mathcal{G}}_i, \mathcal{T}_i}(\hat{\mathcal{G}}_i)$  (see Figure 32 where this condition is not satisfied);
- 3) the set  $\hat{\mathcal{V}}_{i-1} \setminus \text{int} \left( \hat{\mathcal{G}}_i \cup \bigcup_{j=0}^{n-i} p_{\hat{\mathcal{G}}_{i-1}, \mathcal{T}_{i-1}} \circ \dots \circ p_{\hat{\mathcal{G}}_{i+j}, \mathcal{T}_{i+j}}(\hat{\mathcal{G}}_{i+j}) \right)$  does not contain curvilinear triangles as the connected components (see Figure 33 where this condition is failed).

Notice that that for arbitrary diffeomorphism  $f \in MS(M^2)$  the property 1)  $(\hat{\mathcal{V}}_i, \eta_{\hat{\mathcal{V}}_i})_{\hat{\mathcal{G}}_i, \mathcal{T}_i} = (\hat{\mathcal{V}}_{i-1}, \eta_{\hat{\mathcal{V}}_{i-1}})$  is clear from the discussion about cutting and pasting operation above. Property 2) corresponds to the fact that  $f$  is MS and 3) to the maximality of the linearising neighborhoods. Thus we get the following fact.

**Lemma 1.** *Each diffeomorphism  $f \in MS(M^2)$  induces an abstract decomposed scheme.*

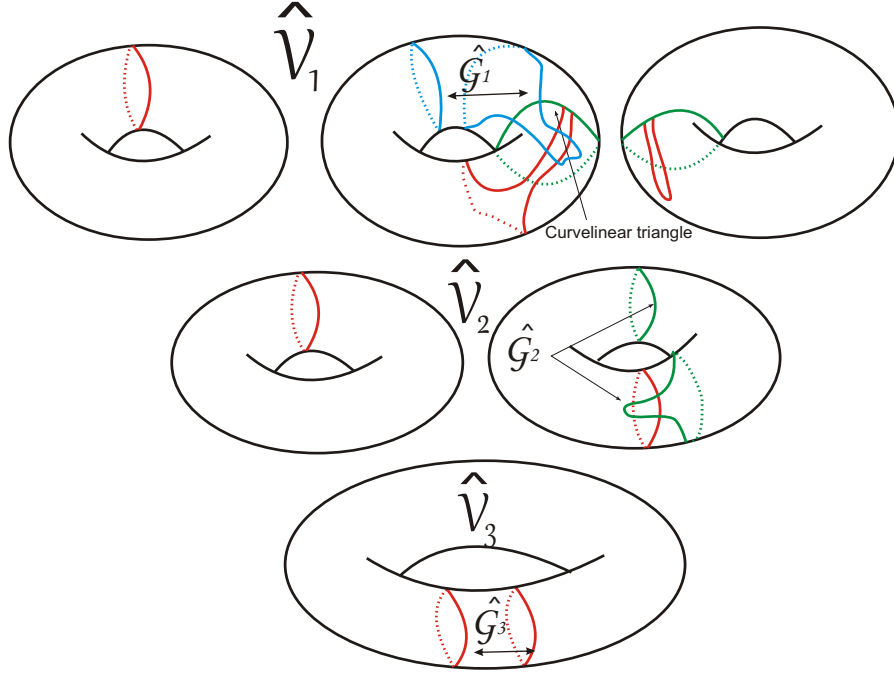

Figure 33: Here there is a curvilinear triangle and so this situation does not represent a abstract decomposed scheme according to Definition 8.

#### 4.4 Realisability of any abstract decomposed scheme: statement of Theorem 3

For an abstract decomposed collection  $(\hat{\mathcal{V}}_1, \eta_{\hat{\mathcal{V}}_1}, \hat{\mathcal{G}}_1, \mathcal{T}_1), \dots, (\hat{\mathcal{V}}_n, \eta_{\hat{\mathcal{V}}_n}, \hat{\mathcal{N}}_n, \mathcal{T}_n)$  let

$$\begin{aligned} \hat{\mathcal{V}}_0 &= (\hat{\mathcal{V}}_1)_{\hat{\mathcal{G}}_1, \mathcal{T}_1}, \\ \lambda_0 &= \sum_{\hat{\mathcal{V}}_j \subset \hat{\mathcal{V}}_0} m_j, \\ \lambda_1 &= \sum_{i=1}^{n-1} l_i \text{ where } l_i = \frac{1}{2} \sum_{\hat{\gamma}_j \subset \hat{\mathcal{G}}_i} m_j k_j, \\ \lambda_2 &= \sum_{\hat{\mathcal{V}}_j \subset \hat{\mathcal{V}}_n} m_j. \end{aligned}$$

**Definition 9.** The collection

$$S = (\hat{\mathcal{V}}, \eta_{\hat{\mathcal{V}}}, \bigcup_{i=1}^n \{\hat{U}_{i,\ell}, \ell = 1, \dots, r_i\})$$

is called a *realizable scheme* if there is an abstract decomposed scheme  $(\hat{\mathcal{V}}_1, \eta_{\hat{\mathcal{V}}_1}, \hat{\mathcal{G}}_1, \mathcal{T}_1), \dots, (\hat{\mathcal{V}}_n, \eta_{\hat{\mathcal{V}}_n}, \hat{\mathcal{G}}_n, \mathcal{T}_n)$  such that  $\lambda_0 - \lambda_1 + \lambda_2$  is even,  $\lambda_0 - \lambda_1 + \lambda_2 \leq 2$  and:



- 1)  $\hat{\mathcal{V}} = \hat{\mathcal{V}}_0$  and  $\eta_{\hat{\mathcal{V}}} = \eta_{\hat{\mathcal{V}}_0}$ ;
- 2)  $\hat{\mathcal{G}}_i$  consists of  $r_i$  components  $\hat{\Gamma}_{i,\ell}$ ,  $\ell = 1, \dots, r_i$  such that  $\hat{U}_{i,\ell}$  is a tubular neighborhood of  $p_{\hat{\mathcal{G}}_1, \tau_1} \circ \dots \circ p_{\hat{\mathcal{G}}_i, \tau_i}(\hat{\Gamma}_{i,\ell})$  for  $i \in \{1, \dots, n\}$ .

Notice that for the decomposed scheme of a diffeomorphism  $f \in MS(M^2)$  we have that  $\lambda_0$  is a number of the sink points,  $\lambda_1$  is a number of the saddle points,  $\lambda_2$  is a number of the source points. Thus  $\lambda_0 - \lambda_1 + \lambda_2$  is the euler characteristic of  $M^2$  equals  $2 - 2g$ , where  $g$  is the genus of the surface  $M^2$ . Moreover, for each  $i \in \{1, \dots, beh(f)\}$  the set  $\hat{\mathcal{U}}_i$  is a tubular neighborhood of the set  $p_{\hat{\mathcal{G}}_1, \tau_1} \circ \dots \circ p_{\hat{\mathcal{G}}_i, \tau_i}(\hat{\mathcal{G}}_i)$ . Thus we have the following fact.

**Lemma 2.** *The decomposed scheme associated to a diffeomorphism  $f \in MS(M^2)$  is an realizable in the sense above.*

**Theorem 3.** *For any realizable decomposed scheme  $S$  there is a diffeomorphism  $f_S \in MS(M^2)$  whose scheme is equivalent to  $S$  and so that the euler characteristic of the orientable surface is equal to  $\lambda_0 - \lambda_1 + \lambda_2$ .*

So MS orientation preserving surface diffeomorphisms can be fully classified by decomposed schemes (which automatically satisfy the properties of a realizable abstract decomposed scheme), and vice versa each such abstract decomposed scheme corresponds to a unique conjugacy class of a diffeomorphisms.

## 4.5 Examples of realizable abstract decomposed schemes and their realisations

**Example 9** (Figure 34). Consider the scheme  $S$  from Figure 34. Here  $\hat{\mathcal{V}} = \mathbb{T}^2$ ,  $n = 1$ ,  $m_{\hat{\mathcal{V}}} = 1$  and  $\hat{U}_i = \hat{N}_i$ ,  $i = 1, 2$  consist of two annuli on the torus  $\hat{\mathcal{V}}$  such that  $\eta_{\hat{\mathcal{V}}}(i_{\hat{N}_i^*}(\pi_1(\hat{N}_i))) = \mathbb{Z}$ . The set  $(\hat{\mathcal{V}})_{\hat{N}}$  consists of one torus. Thus  $\lambda_0 = 1$ ,  $\lambda_1 = 2$  and  $\lambda_2 = 1$ ,  $M_S = \mathbb{T}^2$ ,  $\Sigma_0 = \{\omega\}$ ,  $\Sigma_1 = \{\sigma_1, \sigma_2\}$ ,  $\nu_{\sigma_1} = \nu_{\sigma_2} = +$  and  $\Sigma_2 = \{\alpha\}$ . The interior of the square corresponds to the set  $\mathcal{V}^*$ , where  $f_S$  is the contraction to  $\omega$ . The torus is obtained by identifying the boundary of the circle as suggested by the labelling of  $\sigma_i$  and taking of the connected sum as suggested by the labelling of  $e_i$ .

**Example 10** (Figure 35). Consider the scheme  $S$  from Figure 35. Here  $\hat{\mathcal{V}} = \mathbb{T}^2$ ,  $n = 1$ ,  $m_{\hat{\mathcal{V}}} = 1$  and  $\hat{U} = \hat{N}$  consist of two annuli on the torus  $\hat{\mathcal{V}}$  such that  $\eta_{\hat{\mathcal{V}}}(i_{\hat{N}^*}(\pi_1(\hat{N}))) = 2\mathbb{Z}$ . The set  $(\hat{\mathcal{V}})_{\hat{N}}$  consists of two tori  $\hat{V}_{1,1}$  and  $\hat{V}_{1,2}$  such that  $m_{\hat{V}_{1,1}} = 1$  and  $m_{\hat{V}_{1,2}} = 2$ . Thus  $\lambda_0 = 1$ ,  $\lambda_1 = 2$  and  $\lambda_2 = 3$ ,  $M_S = \mathbb{S}^2$ ,  $\Sigma_0 = \{\omega\}$ ,  $\Sigma_1 = \{\sigma, f_S(\sigma)\}$ ,  $\nu_{\sigma} = +$  and  $\Sigma_2 = \{\alpha_1, f_S(\alpha_1), \alpha_2\}$ . The interior of the square corresponds to the set  $\mathcal{V}^*$ , where  $f_S$  is the contraction to  $\omega$ . The ambient sphere  $\mathbb{S}^2$  is obtained by identifying the boundary of the circle as suggested by the labelling of  $\sigma_i$  and taking of the connected sum as suggested by the labelling of  $e_i$ .

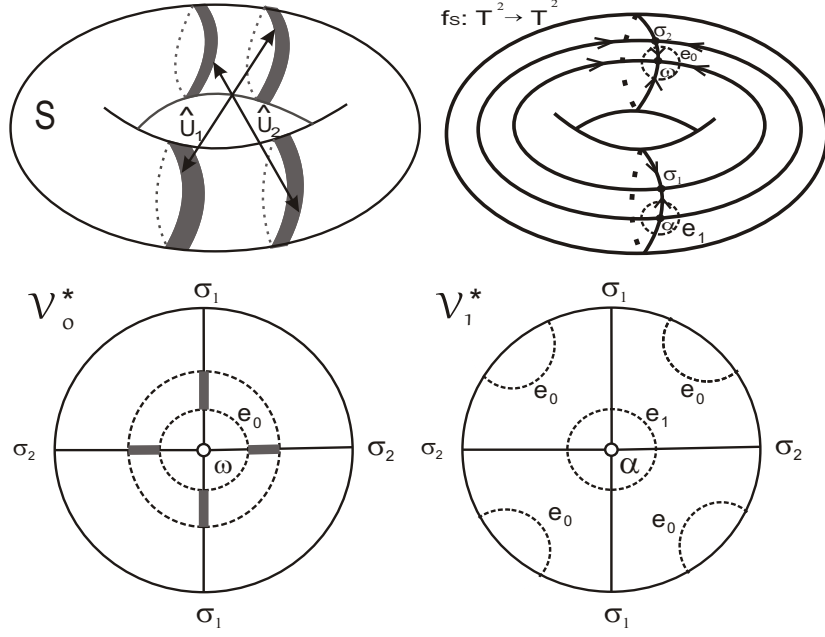

Figure 34: Schemes  $S$  and a phase portrait of the diffeomorphism  $f_S \in MS(M^2)$ .

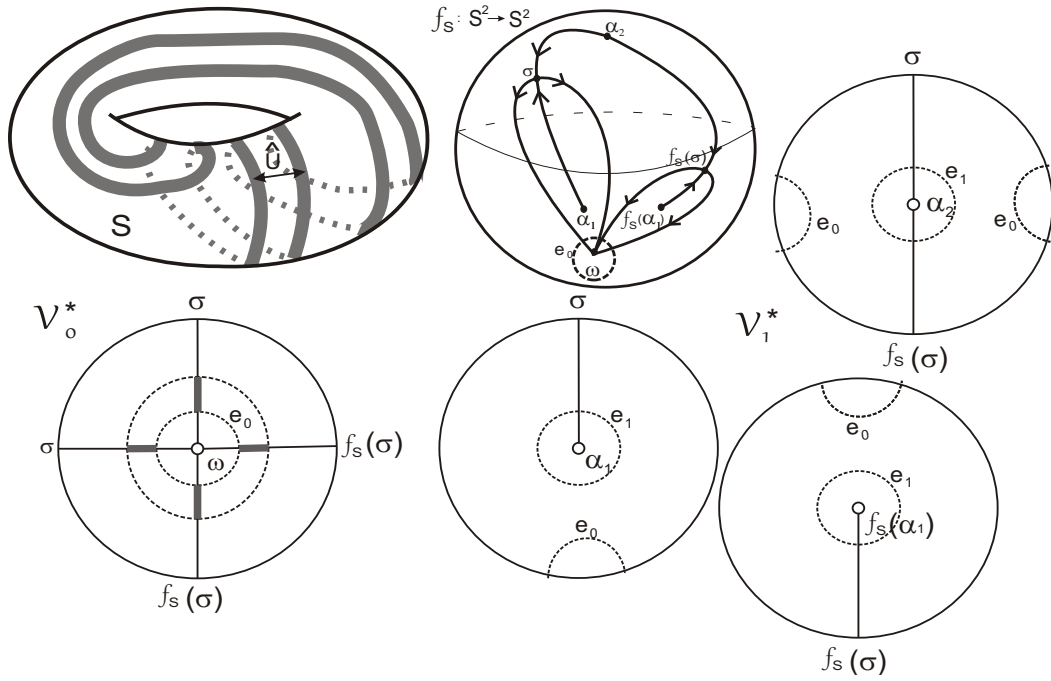

Figure 35: Schemes  $S$  and phase portraits of the diffeomorphisms  $f_S \in MS(M^2)$ .

**Example 11** (Figure 36). Consider the scheme  $S$  from Figure 36. Here  $\hat{V} = \hat{V}_1 \cup \hat{V}_2$ ,  $n = 1$ ,  $m_{\hat{V}_i} = 1$  and  $\hat{U} = \hat{N}$  consist of two annuli  $\hat{A}_i, i = 1, 2$  on the tori  $\hat{V}_i$  such that  $\eta_{\hat{V}_i}(i_{\hat{A}_i}^*(\pi_1(\hat{A}_i))) =$

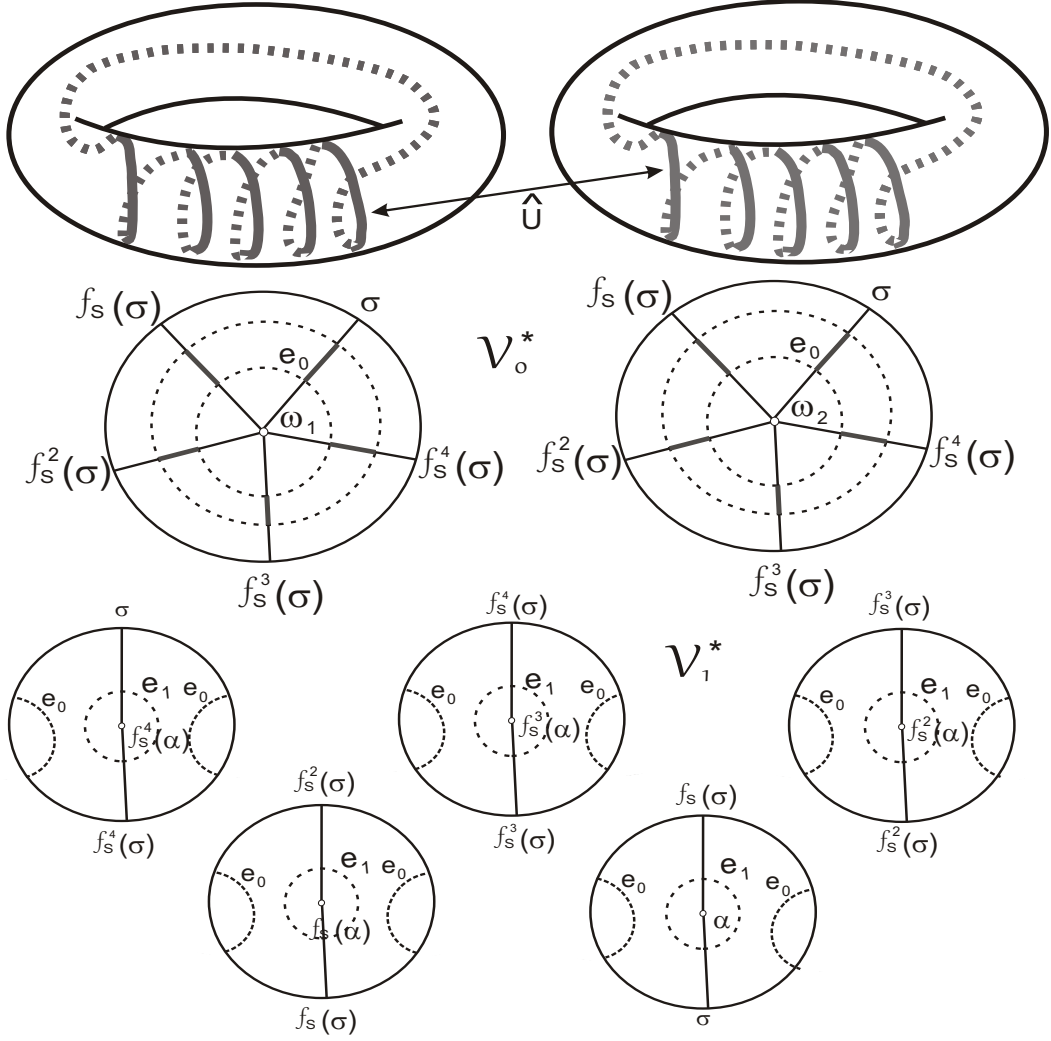

Figure 36: Schemes  $S$  and a phase portrait of the diffeomorphism  $f_S \in MS(M^2)$ .

$5\mathbb{Z}$ . The set  $(\hat{\mathcal{V}})_{\hat{N}}$  consists of one torus  $\hat{V}_{1,1}$  such that  $m_{\hat{V}_{1,1}} = 5$ . Thus  $\lambda_0 = 2$ ,  $\lambda_1 = 5$  and  $\lambda_2 = 5$ ,  $M_S = \mathbb{S}^2$ ,  $\Sigma_0 = \{\omega_1, \omega_2\}$ ,  $\Sigma_1 = \{\sigma, f_S(\sigma), f_S^2(\sigma), f_S^3(\sigma), f_S^4(\sigma)\}$ ,  $\nu_{\sigma_i} = +1, i = 1, 2, 3, 4, 5$  and  $\Sigma_2 = \{\alpha, f_S(\alpha), f_S^2(\alpha), f_S^3(\alpha), f_S^4(\alpha)\}$ . The interior of the punctured discs in the middle of the picture corresponds to the set  $\mathcal{V}^*$ , where  $f_S$  is the contractions to  $\omega_1, \omega_2$  in the composition with the  $1/5$  part of the revolution around  $\omega_1, \omega_2$ , accordingly. The ambient sphere  $\mathbb{S}^2$  is obtained by identifying the boundary of the circle as suggested by the labelling of  $\sigma_i$  and taking of the connected sum as suggested by the labelling of  $e_i$ .

**Example 12** (Figure 37). Consider the scheme  $S$  from Figure 37. Here  $\hat{\mathcal{V}} = \hat{V}_1 \cup \hat{V}_2$ ,  $n = 1$ ,  $m_{\hat{V}_i} = 1$  and  $\hat{U} = \hat{N}$  consist of two annuli  $\hat{A}_i, i = 1, 2$  on the tori  $\hat{V}_i$  such that  $\eta_{\hat{V}_i}(i_{\hat{A}_i}(\pi_1(\hat{A}_i))) = 5\mathbb{Z}$ . The set  $(\hat{\mathcal{V}})_{\hat{N}}$  consists of one torus  $\hat{V}_{1,1}$  such that  $m_{\hat{V}_{1,1}} = 5$ . Thus  $\lambda_0 = 2$ ,  $\lambda_1 = 5$  and  $\lambda_2 = 1$ ,  $M_S$  is the surface of the genus 2,  $\Sigma_0 = \{\omega_1, \omega_2\}$ ,  $\Sigma_1 = \{\sigma, f_S(\sigma), f_S^2(\sigma), f_S^3(\sigma), f_S^4(\sigma)\}$ ,

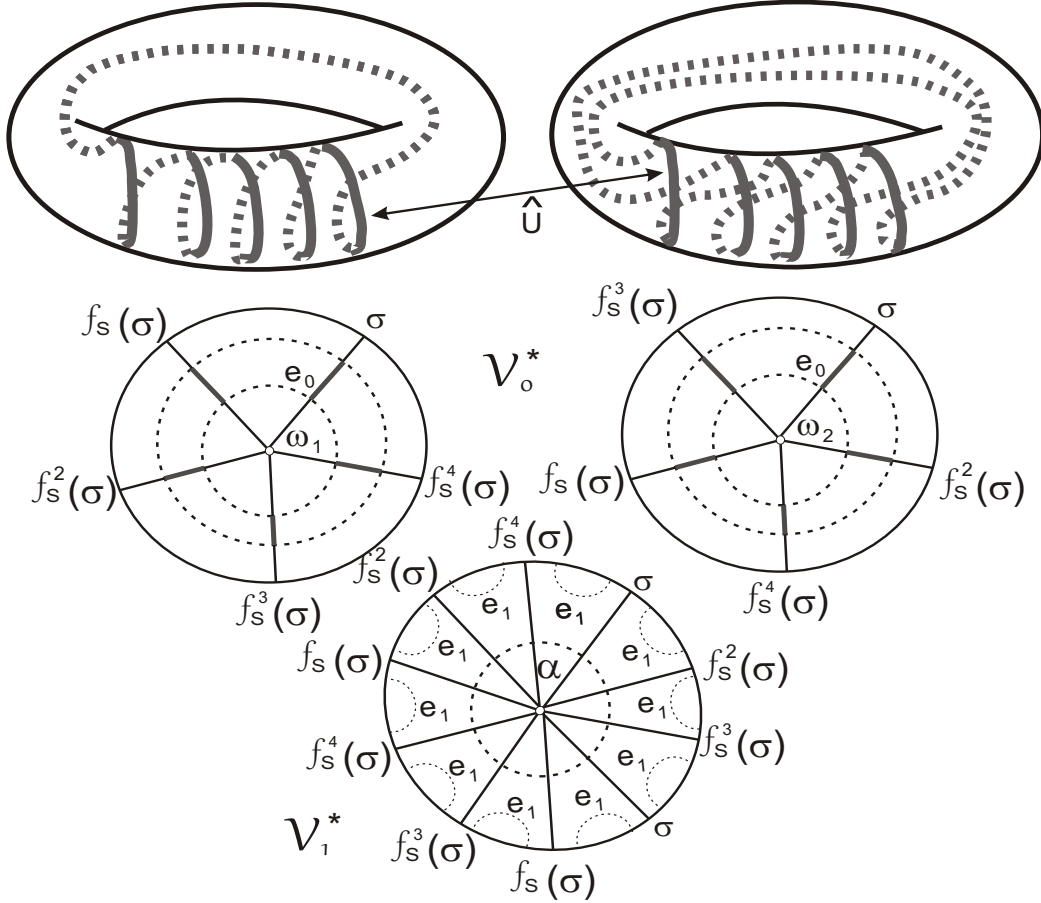

Figure 37: Schemes  $S$  and a phase portrait of the diffeomorphisms  $f_S \in MS(M^2)$ .

$\nu_{\sigma_i} = +1, i = 1, 2, 3, 4, 5$  and  $\Sigma_2 = \{\alpha\}$ . The interior of two punctured discs in the middle of the picture corresponds to the set  $\mathcal{V}^*$ , where  $f_S$  is the contractions to  $\omega_1, \omega_2$  in the composition with the  $1/5, 2/5$  part of the revolution around  $\omega_1, \omega_2$ , accordingly. The ambient surface of the genus 2 is obtained by identifying the boundary of the circle as suggested by the labelling of  $\sigma_i$  and taking of the connected sum as suggested by the labelling of  $e_i$ .

**Example 13** (Figure 38). Consider the scheme  $S$  from Figure 38. Here  $\hat{\mathcal{V}} = \hat{V}$ ,  $m_{\hat{V}} = 1$  and  $n = 3$ . Let us describe the decomposed sequence.

- The set  $\hat{V}_3$  consists of two tori, one of which contains two knots  $\hat{\mathcal{G}}_3$  such that  $\eta_{\hat{V}_3}(i_{\hat{\mathcal{G}}_3^*}(\pi_1(\hat{\mathcal{G}}_3))) = \mathbb{Z}$ .
- The set  $\hat{\mathcal{V}}_2 = (\hat{V}_3)_{\hat{\mathcal{G}}_3}$  consists of three tori  $\hat{V}_{1,1}, \hat{V}_{1,2}$  such that  $m_{\hat{V}_{1,j}} = 1$ . The set  $\hat{\mathcal{N}}_1$  consists of two annuli  $\hat{A}_{0,i}, i = 1, 2$  on the torus  $\hat{V}_{1,2}$  such that  $\eta_{\hat{V}_{1,2}}(i_{\hat{A}_{1,i}^*}(\pi_1(\hat{A}_{1,i}))) = \mathbb{Z}$ .
- The set  $\hat{\mathcal{V}}_2 = (\hat{V}_1)_{\hat{\mathcal{N}}_1}$  consists of three tori  $\hat{V}_{2,1}, \hat{V}_{2,2}, \hat{V}_{2,3}$  such that  $m_{\hat{V}_{2,j}} = 1$ . The set  $\hat{\mathcal{N}}_2$  consists of two annuli  $\hat{A}_{2,1}, \hat{A}_{2,2}$  on the tori  $\hat{V}_{2,2}, \hat{V}_{2,3}$  such that  $\eta_{\hat{V}_{2,j}}(i_{\hat{A}_{2,i}^*}(\pi_1(\hat{A}_{2,i}))) = \mathbb{Z}$ .

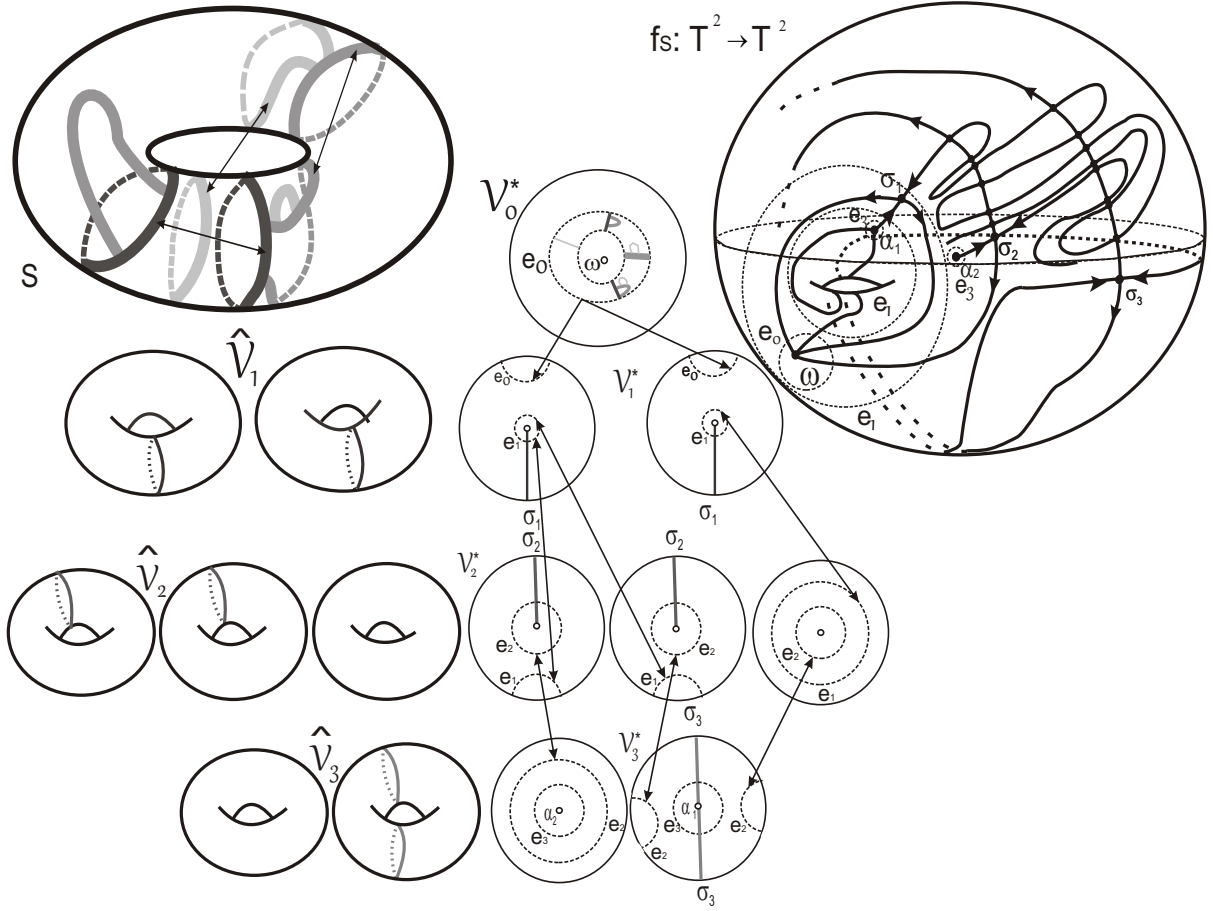

Figure 38: Schemes  $S$ , the decomposed sequence and a phase portraits of the diffeomorphisms  $f_S \in MS(M^2)$ .

- The set  $\hat{V}_3 = (\hat{V}_2)_{\mathcal{N}_2}$  consists of two tori  $\hat{V}_{3,1}, \hat{V}_{3,2}$  such that  $m_{\hat{V}_{3,j}} = 1$ .

Thus  $\lambda_0 = 1, \lambda_1 = 5$  and  $\lambda_2 = 2, M_S = \mathbb{T}^2, \Sigma_0 = \{\omega\}, \Sigma_1 = \{\sigma_1\}, \Sigma_2 = \{\sigma_2\}, \Sigma_3 = \{\sigma_3\}, \nu_{\sigma_i} = +, i = 1, 2, 3$  and  $\Sigma_4 = \{\alpha_1, \alpha_2\}$ . The ambient torus  $\mathbb{T}^2$  is obtained as a connected sum three copies of 2-sphere as suggested by the labelling of saddle points  $\sigma_i$  and the equators  $e_i$ .

## 5 Proof of Theorem 1: maximal systems of neighbourhoods

In this section we will proof Theorem 1. Let us give some notation before. Recall that we divide the set  $\Sigma$  of the saddle points by parts  $\Sigma = \Sigma_1 \cup \dots \cup \Sigma_{beh(f)-1}$ . For each  $i \in \{0, \dots, beh(f) - 1\}$  let us set

$$A_i = \bigcup_{j=0}^i W_j^u, \quad R_i = \bigcup_{j=i+1}^{beh(f)} W_j^s, \quad \mathcal{V}_i = M^2 \setminus (A_i \cup R_i).$$

Observe that  $A_i$  is an attractor,  $R_i$  is a repeller of  $f$  and  $f$  acts freely on  $\mathcal{V}_i$ . Set  $\hat{\mathcal{V}}_i = \mathcal{V}_i/f$  and denote the natural projection by

$$p_i : \mathcal{V}_i \rightarrow \hat{\mathcal{V}}_i.$$

Notice that  $\hat{\mathcal{V}}_0 = \hat{\mathcal{V}}_f$  and  $p_0 = p_f$ . It is proved, for example, in book [21] that each connected component of  $\hat{\mathcal{V}}_i$  is a closed orientable surface and  $p_i$  is a cover. We introduce the following notations:

- for  $j \in \{1, \dots, beh(f) - 1\}$ ,  $k \in \{0, \dots, beh(f) - 1\}$  let  $\hat{W}_{j,k}^s = p_k(W_j^s \cap \mathcal{V}_k)$ ,  $\hat{W}_{j,k}^u = p_k(W_j^u \cap \mathcal{V}_k)$ ;

-  $L^u = \bigcup_{i=1}^{beh(f)-1} W_i^u$ ,  $L^s = \bigcup_{i=1}^{beh(f)-1} W_i^s$ ,  $\hat{L}_i^u = p_i(L^u)$ ,  $\hat{L}_i^s = p_i(L^s)$ .

Before a proof of Theorem 1 we introduce a more strong than  $u$ -compatibility property for a neighborhood of a saddle point.

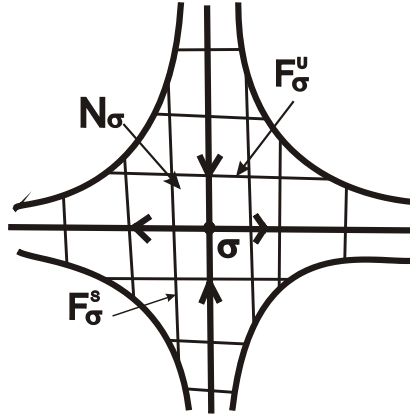

Figure 39: Linearizing neighborhood

**Definition 10** (The linearizing neighborhood). Let  $\sigma$  be a saddle periodic point for  $f$ . A neighborhood  $N_\sigma$  of the point  $\sigma$  with a one-dimensional foliation  $F_\sigma^u$  containing  $W_\sigma^u$  as a leaf and a one-dimensional foliation  $F_\sigma^s$  containing  $W_\sigma^s$  as a leaf, is called *linearizable* if there is a homeomorphism  $\mu_\sigma : N_\sigma \rightarrow N$  which conjugates the diffeomorphism  $f^{k\sigma}|_{N_\sigma}$  to the canonical diffeomorphism  $a_{\nu_\sigma}|_N$  and sends leaves of the foliation  $F_\sigma^u$  to leaves the foliation  $F^u$ , also sends leaves of the foliation  $F_\sigma^s$  to leaves the foliation  $F^s$  (see Figure 39).

For every point  $x \in N_\sigma$  denote by  $F_{\sigma,x}^u$ ,  $F_{\sigma,x}^s$  the unique leave of the foliation  $F_\sigma^u$ ,  $F_\sigma^s$ , accordingly, passing through the point  $x$ .

**Definition 11** (The compatible system of neighbourhoods). An  $f$ -invariant collection  $N_f$  of linearizable neighborhoods  $N_\sigma$  of all saddle points  $\sigma \in \Sigma$  is called *compatible* if the following properties are hold:

- 1)  $\mu_\sigma^{-1}(\partial N)$  does not contain heteroclinic points for any  $\sigma \in \Sigma$ ;

- 2) if  $W_{\sigma_1}^s \cap W_{\sigma_2}^u = \emptyset$  and  $W_{\sigma_1}^u \cap W_{\sigma_2}^s = \emptyset$  for  $\sigma_1, \sigma_2 \in \Sigma$  then  $N_{\sigma_1} \cap N_{\sigma_2} = \emptyset$ ;  
3) if  $W_{\sigma_1}^s \cap W_{\sigma_2}^u \neq \emptyset$  for  $\sigma_1, \sigma_2 \in \Sigma$  then  $(F_{\sigma_1, x}^u \cap N_{\sigma_2}) \subset F_{\sigma_2, x}^u$  and  $(F_{\sigma_2, x}^s \cap N_{\sigma_1}) \subset F_{\sigma_1, x}^s$  for  $x \in (N_{\sigma_1} \cap N_{\sigma_2})$  (see Figure 40).

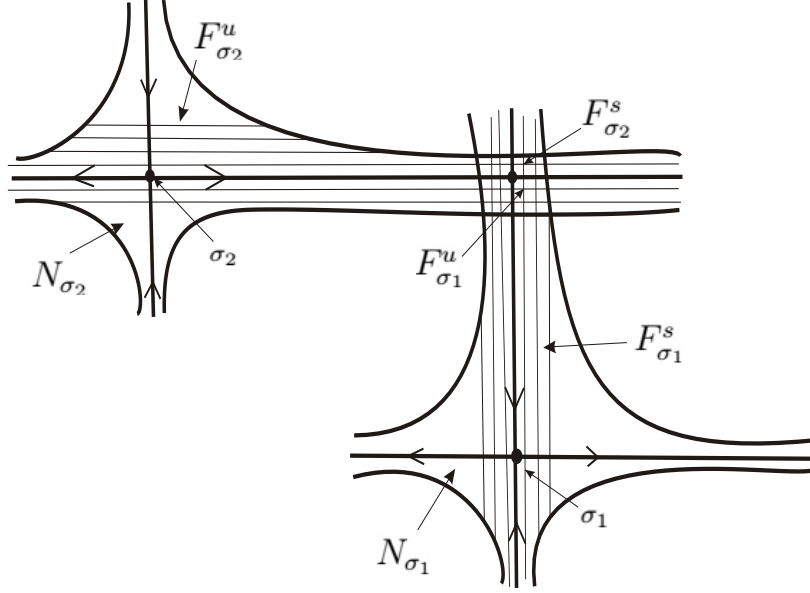

Figure 40: A compatible system of neighbourhoods

**Lemma 3.** *For every diffeomorphism  $f \in MS(M^2)$  there is a compatible system of neighbourhoods.*

**Proof:** The proof consists of three steps.

**Step 1.** Here, we prove the existence of  $f$ -invariant neighbourhoods  $Q_1^s, \dots, Q_{beh(f)-1}^s$  of the sets  $\Sigma_1, \dots, \Sigma_{beh(f)-1}$  respectively, equipped with one-dimensional  $f$ -invariant foliations  $F_1^u, \dots, F_{beh(f)-1}^u$  whose leaves are smooth such that the following properties hold for each  $i \in \{1, \dots, beh(f) - 1\}$ :

(i) the unstable manifolds  $W_i^u$  are leaves of the foliation  $F_i^u$  and each leaf of the foliation  $F_i^u$  is transverse to  $L^s$ ;

(ii) for any  $1 \leq i < k \leq beh(f) - 1$  and  $x \in Q_i^s \cap Q_k^s$ , we have the inclusion  $F_{k,x}^u \cap Q_i^s \subset F_{i,x}^u$ .

Let us prove this by a decreasing induction on  $i$  from  $i = beh(f) - 1$  to  $i = 1$ .

For  $i = beh(f) - 1$ , it follows from the definition of  $\mathcal{V}_{beh(f)-1}$  that  $(W_{beh(f)-1}^s \setminus \Sigma_{beh(f)-1}) \subset \mathcal{V}_{beh(f)-1}$ . Since  $f$  acts freely and properly on  $W_{beh(f)-1}^s$ , the quotient  $\hat{W}_{beh(f)-1, beh(f)-1}^s$  is a smooth submanifold of  $\hat{\mathcal{V}}_{beh(f)-1}$ ; it consists of finite number circles. The lamination  $\hat{L}_{beh(f)-1}^s$  accumulates on  $\hat{W}_{beh(f)-1, beh(f)-1}^s$ . Choose a closed tubular neighbourhood  $\hat{N}_{beh(f)-1}^s$  of  $\hat{W}_{beh(f)-1, beh(f)-1}^s$  in  $\hat{\mathcal{V}}_{beh(f)-1}$ ; denote its projection by  $\pi_{beh(f)-1}^u : \hat{N}_{beh(f)-1}^s \rightarrow \hat{W}_{beh(f)-1, beh(f)-1}^s$ . Its fibres form a segment foliation  $\{d_{beh(f)-1, x}^u \mid x \in \hat{W}_{beh(f)-1, beh(f)-1}^s\}$ . Since  $\hat{L}_{beh(f)-1}^s$  is a

$C^1$ -lamination containing  $\hat{W}_{beh(f)-1, beh(f)-1}^s$  as a leaf, if the tube  $\hat{N}_{beh(f)-1}^s$  is small enough, the fibres are transverse to  $\hat{L}_{beh(f)-1}^s$ .

Set  $Q_{beh(f)-1}^s := p_{beh(f)-1}^{-1}(\hat{N}_{beh(f)-1}^s) \cup W_{beh(f)-1}^u$ . This is a subset of  $M^2$  which carries a foliation  $F_{beh(f)-1}^u$  defined by pullpacking the fibres of  $\pi_{beh(f)-1}^u$  and by adding  $W_{beh(f)-1}^u$  as extra leaves. This is the wanted foliation satisfying (i) and (ii) for  $i = beh(f) - 1$ . Notice that the leaves of  $F_{beh(f)-1}^u$  are smooth.

For the induction we assume the construction is done for every  $j > i$  and we have to construct an  $f$ -invariant neighborhood  $Q_i^s$  of the saddle points from  $\Sigma_i$  carrying an  $f$ -invariant foliation  $F_i^u$  satisfying (i) and (ii). Moreover, by genericity the boundary  $\partial Q_j^s$ ,  $j > i$ , is assumed to avoid all heteroclinic points.

For  $j > i$ , let  $\hat{Q}_{j,i}^s := p_i(Q_j^s \cap \mathcal{V}_i)$  and  $\hat{F}_{j,i}^u := p_i(F_j^u \cap \mathcal{V}_i)$ . For the same reason as in the case  $i = beh(f) - 1$ , the set  $\hat{W}_{i,i}^s$  is a smooth submanifold of  $\hat{V}_i$  consisting of circles. Choose a tubular neighbourhood  $\hat{N}_i^s$  of  $\hat{W}_{i,i}^s$  with a projection  $\hat{\pi}_i^u : \hat{N}_i^s \rightarrow \hat{W}_{i,i}^s$  whose fibres are segments. Similarly,  $\hat{W}_{i+1,i}^u$  is a compact submanifold, consisting of a finite number circles.

The set  $\hat{L}_i^u$  is a compact lamination and its intersection with  $\hat{W}_{i,i}^s$  consists of a countable set of points which are the projections of the heteroclinic points belonging to the stable manifolds  $W_i^s$ . Actually, there is a hierarchy in  $\hat{L}_i^u \cap \hat{W}_{i,i}^s$  which we are going to describe in more details.

Set  $H_k := \hat{W}_{i+k,i}^u \cap \hat{W}_{i,i}^s$  for  $k > 0$ . Since  $\hat{W}_{i+1,i}^u$  is compact,  $H_1$  is a finite set:  $H_1 = \{h_1^1, \dots, h_{t(1)}^1\}$ . We are given neighbourhoods, called *boxes*,  $B_\ell^1$ ,  $\ell = 1, \dots, t(1)$ , about these points, namely, the connected components of  $\hat{Q}_{i+1,i}^s \cap \hat{N}_i^s$ . Due to the fact that  $\partial \hat{Q}_{i+1,i}^s$  contains no heteroclinic points,  $\partial \hat{Q}_{i+1,i}^s \cap W_{i,i}^s$  is isolated from  $\hat{L}_i^u$ . Therefore, if the tube  $\hat{N}_i^s$  is small enough,  $\hat{L}_i^u$  does not intersect  $\partial \hat{Q}_{i+1,i}^s \cap \hat{N}_i^s$ . Then, by shrinking  $Q_j^s$ ,  $j > i + 1$  if necessary, we may guarantee that  $\hat{Q}_{j,i}^s \cap \hat{N}_i^s$  is disjoint from  $\partial \hat{Q}_{i+1,i}^s \cap \hat{N}_i^s$ .

Since  $\hat{W}_{i+2,i}^u$  accumulates on  $W_{i+1,i}^u$ , there are only finitely many points of  $H_2$  outside of all boxes  $B_\ell^1$ ,  $\ell = 1, \dots, t(1)$ . Let  $\bar{H}_2 := \{h_1^2, \dots, h_{t(2)}^2\}$  be this finite set. The open set  $\hat{Q}_{i+2,i}^s$  is a neighbourhood of  $\bar{H}_2$ . The connected components of  $\hat{Q}_{i+2,i}^s \cap \hat{N}_i^s$  which contain points of  $\bar{H}_2$  will be the box  $B_\ell^2$  for  $\ell = 1, \dots, t(2)$ . We argue with  $B_\ell^2$  with respect to  $\hat{L}_i^u$  and the neighbourhoods  $\hat{Q}_{j,i}^s$ ,  $j > i + 1$ , in a similar manner as we do with  $B_\ell^1$ . And so on, until  $\bar{H}_n$ .

Due to the induction hypothesis, each above-mentioned box is foliated. Namely,  $B_\ell^1$  is foliated by  $\hat{F}_{i+1,i}^u$ ; the box  $B_\ell^2$  is foliated by  $\hat{F}_{i+2,i}^u$ , and so on. But the leaves are not contained in fibres of  $\hat{N}_i^s$ ; even more, not every leaf intersects  $W_{i,i}^s$ . We have to correct this situation in order to construct the foliation  $F_i^u$  satisfying the wanted conditions (i) and (ii).

For every  $j > i$ , the foliation  $F_j^u$  may be extended to the boundary  $\partial Q_j^s$  and a bit beyond. Once this is done, if  $\hat{N}_i^s$  is enough shrunk, each leaf of  $\hat{F}_{i+k,i}^u$  though  $x \in B_\ell^k$  intersects  $\hat{W}_{i,i}^s$  (it is understood that the boxes are intersected with the shrunk tube without changing their names). So, we have a projection along the leaves  $\pi_{k,\ell} : B_\ell^k \rightarrow \hat{W}_{i,i}^s$ ; but, the image of  $\pi_{k,\ell}$  is larger than  $B_\ell^k \cap \hat{W}_{i,i}^s$ . Then, we choose a small enlargement  $B_\ell'^k$  of  $B_\ell^k$  such that  $B_\ell'^k \setminus B_\ell^k$  is foliated by  $\hat{F}_{i+k,i}^u$  and avoids the lamination  $\hat{L}_i^u$ .

On  $B_\ell'^k \setminus B_\ell^k$  we have two projections: one is  $\hat{\pi}_i^u$  and the other one is  $\pi_{k,\ell}$ . We are going to



interpolate between both using a partition of unity (we do it for  $B_\ell^k$  but it is understood that it is done for all boxes). Let  $\phi : \hat{N}_i^s \rightarrow [0, 1]$  be a smooth function which equals 1 near  $B_\ell^k$  and whose support is contained in  $B_\ell^k$ . Define a global  $C^1$  retraction  $\hat{q} : \hat{N}_i^s \rightarrow \hat{W}_{i,i}^s$  by the formula

$$\hat{q}(x) = (1 - \phi(x))\hat{\pi}_i^u(x) + \phi(x)(\pi_{k,\ell}(x)).$$

Here, we use an affine manifold structure on each component of  $\hat{W}_{i,i}^s$  by identifying it with the circle  $\mathbb{S}^1 := \mathbb{R}/\mathbb{Z}$ . So, any positively weighted barycentric combination makes sense for a pair of points sufficiently close. When  $x \in \hat{W}_{i,i}^s$ , we have  $\hat{q}(x) = x$ . Then, by shrinking the tube  $\hat{N}_i^s$  once more if necessary we make  $\hat{q}$  be a fibration whose fibres are transverse to the lamination  $\hat{L}_i^s$  and we make each leaf of  $\hat{F}_{j,i}^u$ ,  $j > i$ , in every box  $B_\ell^k$  be contained in a fibre of  $\hat{q}$ . Henceforth, pullbacking that strip (and its fibration) by  $p_i$  and adding the unstable manifold  $W_i^u$  provide the wanted  $Q_i^s$  and its foliation  $F_i^u$  satisfying the required properties. So, the induction is proved.

We also have the existence of  $f$ -invariant neighborhoods  $Q_1^u, \dots, Q_{beh(f)-1}^u$  of the saddle points from  $\Sigma_1, \dots, \Sigma_{beh(f)-1}$  respectively, equipped with one-dimensional  $f$ -invariant foliations  $F_1^s, \dots, F_{beh(f)-1}^s$  with smooth leaves such that the following properties hold for each  $i \in \{1, \dots, beh(f) - 1\}$ :

(iii) the stable manifolds  $W_i^s$  are leaves of the foliation  $F_i^s$  and each leaf of the foliation  $F_i^s$  is transverse to  $L^u$ ;

(iv) for any  $1 \leq j < i$  and  $x \in Q_j^u \cap Q_i^u$ , we have the inclusion  $(F_{j,x}^s \cap Q_i^u) \subset F_{i,x}^s$ .

The proof is done by an increasing induction from  $i = 1$ ; it is skipped due to similarity to the previous one.

**Step 2.** We prove that for each  $i = 1, \dots, beh(f) - 1$  there exists an  $f$ -invariant neighborhood  $\tilde{N}_i$  of the set  $\Sigma_i$  which is contained in  $Q_i^s \cap Q_i^u$  and such that the restrictions of the foliations  $F_i^u$  and  $F_i^s$  to  $\tilde{N}_i$  are transverse.

For this aim, let us choose a fundamental domain  $K_i^s$  of the restriction of  $f$  to  $W_i^s \setminus \Sigma_i$  and take a tubular neighborhood  $N(K_i^s)$  of  $K_i^s$  whose segment fibres are contained in leaves of  $F_i^u$ . Due to property (i),  $F_i^u$  is transverse to  $W_i^s$ . Since  $F_i^s$  is a  $C^1$ -foliation, if  $N(K_i^s)$  is small enough, the foliations  $F_i^s$  and  $F_i^u$  have transverse intersection in  $N(K_i^s)$ . Set

$$\tilde{N}_i := W_i^u \bigcup_{k \in \mathbb{Z}} f^k(N(K_i^s)).$$

This is a neighborhood of  $\Sigma_i$ ; it satisfies condition (v) and the previous properties (i)–(iv) still hold.

**Step 3.** Let us show the existence of linearizable neighborhoods  $N_i \subset \tilde{N}_i$ ,  $i = 1, \dots, beh(f) - 1$ , for which the required foliation are the restriction to  $N_i$  of the foliation  $F_i^u$ .

Let  $\sigma \in \Sigma_i$  and  $\tilde{N}_\sigma$  be a connected component of  $\tilde{N}_i$  containing  $\sigma$ . There is a homeomorphism  $\varphi_\sigma^u : W_\sigma^u \rightarrow W_\sigma^u$  (resp.  $\varphi_\sigma^s : W_\sigma^s \rightarrow W_\sigma^s$ ) conjugating the diffeomorphisms  $f^{per} \sigma|_{W_\sigma^u}$  and  $a_{\nu_\sigma}|_{W_\sigma^u}$  (resp.  $f^{per} \sigma|_{W_\sigma^s}$  and  $a_{\nu_\sigma}|_{W_\sigma^s}$ ). In addition, for any point  $z \in \tilde{N}_\sigma$  there is unique pair of points  $z_s \in W_\sigma^s$ ,  $z_u \in W_\sigma^u$  such that  $z = F_{i,z_u}^s \cap F_{i,z_s}^u$ . We define a topological embedding  $\tilde{\mu}_\sigma : \tilde{N}_\sigma \rightarrow \mathbb{R}^2$  by the formula  $\tilde{\mu}_\sigma(z) = (x_1, x_2)$  where  $x_1 = \varphi_\sigma^u(z_u)$  and  $x_2 = \varphi_\sigma^s(z_s)$ . Choose  $t_0 \in (0, 1]$  such that  $\mathcal{N}^{t_0} \subset \tilde{\mu}_\sigma(\tilde{N}_\sigma)$  and  $\partial \mathcal{N}^{t_0}$  does not contain images with respect  $\tilde{\mu}_\sigma$  of heteroclinic points. Observe that  $a_{\nu_\sigma}|_{\mathcal{N}^{t_0}}$  is conjugate to  $a_{\nu_\sigma}|_{\mathcal{N}}$  by the suitable homothety  $h$ . Set  $N_\sigma = \tilde{\mu}_\sigma^{-1}(\mathcal{N}^{t_0})$  and

$\mu_\sigma = h\tilde{\mu}_\sigma : \mathbf{N}_\sigma \rightarrow \mathcal{N}$ . Then,  $\mathbf{N}_\sigma$  is the wanted neighbourhood with its linearizing homeomorphism  $\mu_\sigma$ .  $\diamond$

Let us prove that for every diffeomorphism  $f \in MS(M^2)$  there is a maximal  $u$ -compatible system of neighbourhoods.

**Proof:** To prove the theorem it remains to show how to do the constructed in Lemma 3 compatible system of neighborhoods  $\mathbf{N}_f$  by maximal.

Firstly define  $N_1 = \mathbf{N}_1$  and  $N_{beh(f)-1} = \mathbf{N}_{beh(f)-1}$  because there is no heteroclinic rectangle connected with saddle points from  $\Sigma_1$  and  $\Sigma_{beh(f)-1}$ . Let us describe a modification of  $\mathbf{N}_i$ ,  $i \in \{2, \dots, beh(f) - 2\}$  up to  $N_i$  which is a maximal.

For each  $i \in \{1, \dots, beh(f) - 1\}$ ,  $\sigma \in \Sigma_i$  let

$$\hat{\mathbf{N}}_\sigma = p_f(\mathbf{N}_\sigma), \hat{\mathbf{N}}_i = \bigcup_{\sigma \in \Sigma_i} \hat{\mathbf{N}}_\sigma, \hat{\mathbf{N}}_f = \bigcup_{\sigma \in \Sigma_i} \hat{\mathbf{N}}_i.$$

If the set  $\hat{\mathcal{V}}_f \setminus \hat{\mathbf{N}}_f$  does not contain a connected component whose boundary is a curvilinear triangle with sides  $l_1 \subset \hat{\mathbf{N}}_{i_1}$ ,  $l \subset \hat{\mathbf{N}}_i$ ,  $l_2 \subset \hat{\mathbf{N}}_{i_2}$  for some  $1 \leq i_1 < i < i_2 \leq beh(f) - 1$  then  $N_i = \mathbf{N}_i$  for every  $i \in \{2, \dots, beh(f) - 2\}$ . In the opposite case, for every such component  $\hat{\Delta}$  there are saddle points  $\sigma_1 \in \Sigma_{i_1}$ ,  $\sigma \in \Sigma_i$ ,  $\sigma_2 \in \Sigma_{i_2}$  such that  $W_{\sigma_1}^s \cap W_\sigma^u \neq \emptyset$ ,  $W_\sigma^s \cap W_{\sigma_2}^u \neq \emptyset$  and  $W_{\sigma_1}^s$ ,  $W_\sigma^u$ ,  $W_\sigma^s$ ,  $W_{\sigma_2}^u$  form a heteroclinic rectangle  $\Pi_\sigma$  for which the set  $\Delta = \Pi_\sigma \setminus (N_\sigma \cup N_{\sigma_1} \cup N_{\sigma_2})$  is a connected component of the preimage  $p_f^{-1}(\hat{\Delta})$ . Let  $N(\Pi_\sigma)$  be a neighborhood of  $\Pi_\sigma$  bonded by  $\mu_{\sigma_1}(\partial N^{1+\varepsilon})$ ,  $\mu_{\sigma_2}(\partial N^{1+\varepsilon})$ ,  $W_\sigma^s, W_\sigma^u$  for some small enough  $\varepsilon > 0$ . Let  $\mathbf{N}_\sigma^* = \mathbf{N}_\sigma \cup \bigcup_{k \in \mathbb{Z}} f^k(N(\Pi_\sigma))$ .

Due to compatibility of neighborhood  $\mathbf{N}_f$  we can construct on  $\mathbf{N}_\sigma^*$  a new unstable foliation  $\mathbf{F}_\sigma^{u*}$  which is compatible with the unstable foliations in all saddle neighborhoods. Let us show that this neighborhood is a linearizable.

For this aim it is enough to construct a homeomorphism  $g : \mathbf{N}_\sigma^* \rightarrow \mathbf{N}_\sigma$  sending the foliation  $\mathbf{F}_\sigma^{u*}$  to  $\mathbf{F}_\sigma^u$  and such that  $gf^{per(\sigma)} = f^{per(\sigma)}g$ . Notice that each connected component of the sets  $p_i(\mathbf{N}_\sigma^*)$  and  $p_i(\mathbf{N}_\sigma)$  is an annulus and  $p_i(\mathbf{N}_\sigma^*) \supset p_i(\mathbf{N}_\sigma)$ . Let us choose a neighborhood  $N(p_i(W_\sigma^s))$  of  $p_i(W_\sigma^s)$  such that  $N(p_i(W_\sigma^s)) \subset p_i(\mathbf{N}_\sigma)$ . Let us define a homeomorphism  $\hat{g} : p_i(\mathbf{N}_\sigma^*) \rightarrow p_i(\mathbf{N}_\sigma)$  such that  $\hat{g}|_{N(p_i(W_\sigma^s))} = id$ ,  $\hat{g}(p_i(\mathbf{N}_\sigma^*) \setminus N(p_i(W_\sigma^s))) = p_i(\mathbf{N}_\sigma) \setminus N(W_\sigma^s)$  and  $\hat{g}$  preserves leaves of the foliation  $p_i(\mathbf{F}_\sigma^{u*})$ . The required homeomorphism  $g$  is a lift of  $\hat{g}$  which is identity in a neighborhood of  $W_\sigma^s \cup W_\sigma^u$ .

Thus we get a new  $u$ -compatible system of neighbourhoods for which the set  $\hat{\mathcal{V}}_f \setminus (\bigcup_{p \in \Omega_f \setminus \sigma} \hat{\mathbf{N}}_p \cup$

$\hat{\mathbf{N}}_\sigma^*)$  contains less by 1 connected components. When we do the same operation for all such components  $\hat{\Delta}$  we get the desired maximal  $u$ -compatible system of neighborhoods.  $\diamond$

## 6 Proof of Theorem 2: classifying diffeomorphisms

In this section we prove Theorem 2, i.e., we prove that two diffeomorphisms  $f, f' \in MS(M^2)$  are topologically conjugate if and only if their schemes are equivalent.

**Proof:**

*Necessity.* Let  $f, f' \in MS(M^2)$  be two diffeomorphisms which are topologically conjugated by means of a homeomorphism  $h : M^2 \rightarrow M^2$ . The conjugating homeomorphism sends the invariant manifolds of the periodic points of  $f$  to corresponding objects of  $f'$ , preserving stability and periodicity, and therefore  $beh(f) = beh(f')$ ,  $k_f = k_{f'}$ . Thus  $h$  induces a maximal system of compatible neighborhoods  $\{h(N_\sigma), \sigma \in \Sigma\}$  for  $f'$  which is different from  $\mathcal{N}_{f'}$  in the general case. Then it remains to prove the following lemma.

**Lemma 4.** *The class of the equivalence of a scheme  $S_f$ ,  $f \in MS(M^2)$  does not depend on a choice of a maximal system of compatible neighborhoods.*

**Proof:** Let  $\mathcal{N}_f = \{N_1, \dots, N_{beh(f)-1}\}$  and  $\mathbf{N}_f = \{\mathbf{N}_1, \dots, \mathbf{N}_{beh(f)-1}\}$  be different maximal systems of compatible neighborhoods with the foliations  $F^u, \mathbf{F}^u$ , accordingly. Without loss of generality we can assume that  $\mathbf{N}_i \subset \text{int } N_i$  for each  $i \in \{1, \dots, beh(f) - 1\}$  (in the opposite case we can choose a maximal system  $\mathbb{N}_f = \{\mathbb{N}_1, \dots, \mathbb{N}_{beh(f)-1}\}$  such that  $\mathbb{N}_i \subset \text{int } N_i$  and  $\mathbb{N}_i \subset \text{int } \mathbf{N}_i$ ).

Let  $G_i = \bigcup_{j=1}^i N_j$ ,  $\mathbf{G}_i = \bigcup_{j=1}^i \mathbf{N}_j$ ,  $\hat{G}_i = p_f(G_i)$ ,  $\hat{\mathbf{G}}_i = p_f(\mathbf{G}_i)$  and  $\hat{G}_{i,j} = p_j(G_i)$ ,  $\hat{\mathbf{G}}_{i,j} = p_j(\mathbf{G}_i)$  for  $j \in \{1, \dots, beh(f) - 1\}$ . By the increasing induction on  $i$  from 1 to  $beh(f) - 1$  let us show that  $\hat{G}_i \setminus \hat{\mathbf{G}}_i$  is a direct product.

For  $i = 1$ ,  $\hat{G}_1$  and  $\hat{\mathbf{G}}_1$  are tubular neighborhoods of a finite number circles  $p_f(W_1^u)$ . As  $\hat{\mathbf{G}}_1 \subset \text{int } \hat{G}_1$  then, by the Annulus conjecture,  $\hat{G}_1 \setminus \hat{\mathbf{G}}_1$  is a direct product.

Supposing that the statement is true for  $i$  let us prove it for  $i + 1$ .

By assumption  $\hat{G}_i \setminus \hat{\mathbf{G}}_i$  is a direct product. As  $\hat{G}_{i,i} \setminus \text{int } \hat{\mathbf{G}}_{i,i} = p_i(p_f^{-1}(\hat{G}_i \setminus \text{int } \hat{\mathbf{G}}_i))$  then  $\hat{G}_{i,i} \setminus \text{int } \hat{\mathbf{G}}_{i,i}$  is a direct product. Let us show that the intersections of the circles  $\hat{W}_{i+1,i}^u$  with the sets  $\hat{G}_{i,i}$  and  $\hat{\mathbf{G}}_{i,i}$  consists of a finite number segments  $I_{1,i}, \dots, I_{n_i,i}$  and  $\mathbf{l}_{1,i}, \dots, \mathbf{l}_{n_i,i}$ , accordingly, such that  $\mathbf{l}_{j,i} \subset \text{int } I_{j,i}$  for each  $j \in \{1, \dots, n_i\}$ . It will imply that  $\hat{G}_{i+1} \setminus \hat{\mathbf{G}}_{i+1}$  is a direct product.

Let  $F_i^u$  be the corresponding foliation on  $\mathcal{N}_i$  associated to the foliations  $F_\sigma^u$ ,  $\sigma \in \Sigma_i$ . Indeed, the circles  $\hat{W}_{i,i}^s$  and  $\hat{W}_{i+1,i}^u$  have a transversal intersection along a finite number  $n_i^i$  points  $z_{1,i}^i, \dots, z_{n_i^i,i}^i$ ;  $\hat{N}_{i,i}$ ,  $\hat{\mathbf{N}}_{i,i}$  are tubular neighborhoods of the circles  $\hat{W}_{i,i}^s$  and every connected component of the intersections  $\hat{W}_{i+1,i}^u \cap \hat{N}_{i,i}$ ,  $\hat{W}_{i+1,i}^u \cap \hat{\mathbf{N}}_{i,i}$  is a leaf of the foliations  $p_i(F_i^u)$ ,  $p_i(\mathbf{F}_i^u)$ , accordingly. Hence, the each intersection  $\hat{W}_{i+1,i}^u \cap \hat{N}_{i,i}$  and  $\hat{W}_{i+1,i}^u \cap \hat{\mathbf{N}}_{i,i}$  consist of  $n_i^i$  segments  $I_{1,i}^i, \dots, I_{n_i^i,i}^i$  and  $\mathbf{l}_{1,i}^i, \dots, \mathbf{l}_{n_i^i,i}^i$ , passing through the points  $z_{1,i}^i, \dots, z_{n_i^i,i}^i$ , accordingly, such that  $\mathbf{l}_{j,i}^i \subset \text{int } I_{j,i}^i$  for each  $j \in \{1, \dots, n_i^i\}$ .

As the sets  $\hat{W}_{i-1,i}^s \setminus \hat{N}_{i,i}$  and  $\hat{W}_{i-1,i}^s \setminus \hat{\mathbf{N}}_{i,i}$  are compact then the intersections  $(\hat{W}_{i-1,i}^s \setminus \hat{N}_{i,i}) \cap \hat{W}_{i+1,i}^u$  and  $(\hat{W}_{i-1,i}^s \setminus \hat{\mathbf{N}}_{i,i}) \cap \hat{W}_{i+1,i}^u$  consist of a finite number points, which are the same due to properties of the maximal neighborhood, denote by  $z_{1,i}^{i-1}, \dots, z_{n_i^{i-1},i}^{i-1}$  these points. Similar to the arguments above, the each intersection  $\hat{W}_{i+1,i}^u \cap (\hat{N}_{i-1,i}^s \setminus \hat{N}_{i,i})$  and  $\hat{W}_{i+1,i}^u \cap (\hat{\mathbf{N}}_{i-1,i}^s \setminus \hat{\mathbf{N}}_{i,i})$  consist of  $n_i^{i-1}$  segments  $I_{1,i}^{i-1}, \dots, I_{n_i^{i-1},i}^{i-1}$  and  $\mathbf{l}_{1,i}^{i-1}, \dots, \mathbf{l}_{n_i^{i-1},i}^{i-1}$ , passing through the points  $z_{1,i}^{i-1}, \dots, z_{n_i^{i-1},i}^{i-1}$ , accordingly, such that  $\mathbf{l}_{j,i}^{i-1} \subset \text{int } I_{j,i}^{i-1}$  for each  $j \in \{1, \dots, n_i^{i-1}\}$ .

Similarly for every  $k \in \{1, \dots, i-2\}$  we have that each intersection  $\hat{W}_{i+1,i}^u \cap (\hat{N}_{k,i}^s \setminus \bigcup_{j=k+1}^i \hat{N}_{j,i})$

and  $\hat{W}_{i+1,i}^u \cap (\hat{N}_{k,i}^s \setminus \bigcup_{j=k+1}^i \hat{N}_{j,i})$  consist of  $n_i^k$  segments  $I_{1,i}^k, \dots, I_{n_i^k,i}^k$  and  $l_{1,i}^k, \dots, l_{n_i^k,i}^k$ , passing through the points  $z_{1,i}^k, \dots, z_{n_i^k,i}^k$ , accordingly, such that  $l_{j,i}^k \subset \text{int } I_{j,i}^k$  for each  $j \in \{1, \dots, n_i^k\}$ . Thus we get the required statement.

To finish the proof let us choose a tubular neighborhood  $\hat{U}_-$  of  $\partial \hat{G}_{beh(f)-1}$  and tubular neighborhood  $\hat{U}_+$  of  $\partial \hat{G}_{beh(f)-1}$  avoiding all  $p_f(W_\Sigma^u)$ . As  $\hat{G}_{beh(f)-1} \setminus \hat{G}_{beh(f)-1}$  is a direct product there is a homeomorphism  $\hat{\varphi} : \hat{V}_f \rightarrow \hat{V}_f$  which is identity on  $\hat{G}_{beh(f)-1} \setminus U_-$  and out of  $\hat{G}_{beh(f)-1} \cup U_+$  and such that  $\hat{\varphi}(\hat{G}_{beh(f)-1}) = G_{beh(f)-1}$ . It is easy to modify  $\varphi$  such that  $\hat{\varphi}(\hat{U}_\sigma) = \hat{U}_\sigma$ .  $\diamond$

*Sufficiency.* Let us prove the sufficiency of the condition in Theorem 2. Assume that the two diffeomorphisms  $f, f' \in MS(M^2)$  have equivalent schemes. The schemes  $S_f$  and  $S_{f'}$  of diffeomorphisms  $f, f' \in MS(M^2)$ , respectively, are said to be equivalent if there exist an orientation-preserving homeomorphism  $\hat{\varphi} : \hat{\mathcal{V}}_f \rightarrow \hat{\mathcal{V}}_{f'}$  such that:

- 1)  $\eta_{f'} \hat{\varphi}_* = \eta_f$ ;
- 2)  $\hat{\varphi}(\hat{U}_f) = \hat{U}_{f'}$ , moreover for every point  $\sigma \in \Sigma_i$  there is a point  $\sigma' \in \Sigma'_i$  such that  $\hat{\varphi}(\hat{U}_\sigma) = \hat{U}_{\sigma'}$  and  $\varphi(U_\sigma) = U_{\sigma'}$ .

In a sequence of lemmas we will construct a maximal system of compatible neighborhoods  $\{\mathbf{N}_1, \dots, \mathbf{N}_{beh(f)-1}\}$  for  $f$  such that  $\mathbf{N}_i \subset \text{int}(\mathcal{N}_i)$  for every  $i \in \{1, \dots, beh(f) - 1\}$  and a conjugating  $f$  with  $f'$  embedding  $\psi$  on the union of these neighborhoods such that  $\psi(\mathbf{D}) \subset \text{int}(\mathcal{D}')$ , where

$$\mathbf{D} = \bigcup_{i=1}^{beh(f)-1} \mathbf{N}_i, \quad \mathcal{D} = \bigcup_{i=1}^{beh(f)-1} \mathcal{N}_i, \quad \mathcal{D}' = \bigcup_{i=1}^{beh(f)-1} \mathcal{N}'_i.$$

Using Lemma 4 we can interpolate  $\psi$  on  $\bigcup_{i=1}^{beh(f)-1} \mathbf{N}_i$  with  $\varphi$  on  $\bigcup_{i=1}^{beh(f)-1} \mathcal{N}_i$  and get a homeomorphism  $h : M^2 \setminus (\Sigma_0 \cup \Sigma_{beh(f)}) \rightarrow M'^2 \setminus (\Sigma'_0 \cup \Sigma'_{beh(f)})$  conjugating  $f|_{M^2 \setminus (\Sigma_0 \cup \Sigma_{beh(f)})}$  with  $f'|_{M \setminus (\Sigma'_0 \cup \Sigma'_{beh(f)})}$ . Notice that  $M^2 \setminus (W_\Sigma^s \cup \Sigma_{beh(f)}) = W_{\Sigma_0}^s$  and  $M'^2 \setminus (W_{\Sigma'}^s \cup \Sigma'_{beh(f)}) = W_{\Sigma'_0}^s$ . Since  $h(W_\Sigma^s) = W_{\Sigma'}^s$ , then  $h(W_{\Sigma_0}^s \setminus \Sigma_0) = W_{\Sigma'_0}^s \setminus \Sigma'_0$ . Thus for each connected component  $A$  of  $W_{\Sigma_0}^s \setminus \Sigma_0$ , there is a sink  $\Omega \in \Sigma_0$  such that  $A = W_\Omega^s \setminus \omega$ . Similarly,  $h(A)$  is a connected component of  $W_{\Sigma'_0}^s \setminus \Sigma'_0$  such that  $h(A) = W_{\omega'}^s \setminus \omega'$  for a sink  $\omega' \in \Sigma'_0$ . Then we can continuously extend  $h$  to  $\Sigma_0$  by defining  $h(\omega) = \omega'$  for every  $\omega \in \Sigma_0$ . A similar extension of  $h$  to  $\Sigma_{beh(f)}$  finishes the proof of Theorem 2.

To construct the embedding  $\psi$ , firstly, similar to proof of Lemma 3, we can prove the existence in the neighborhoods  $\mathcal{N}_1, \dots, \mathcal{N}_{beh(f)-1}$  of  $f$ -invariant one-dimensional foliations  $F_1^s, \dots, F_{beh(f)-1}^s$  whose leaves are smooth and such that the following properties hold for each  $i \in \{1, \dots, beh(f) - 1\}$ :

- the stable manifolds  $W_i^s$  are leaves of the foliation  $F_i^s$  and the foliation  $F_i^s$  is transverse to the foliation  $F_i^u$ ;

- for any  $1 \leq i < k \leq beh(f) - 1$  and  $x \in \mathcal{N}_i \cap \mathcal{N}_k$ , we have the inclusion  $F_{i,x}^s \cap \mathcal{N}_k \subset F_{k,x}^s$ .

By property 2) of the equivalence of the schemes, we have that there is a one-to-one correspondence between the sets  $\Sigma_i$  and  $\Sigma'_i$  through the equality  $\varphi(U_\sigma) = U_{\sigma'}$ . For  $j > i$ , let us denote by  $\mathcal{J}_{i,j}^u$  the union of all connected components of  $W_j^u \cap \mathcal{N}_i$  which do not lie in  $\text{int } \mathcal{N}_k$  with

$i < k < j$ . Let  $\mathcal{J}_i^u = \bigcup_{j=i+1}^{beh(f)-1} \mathcal{J}_{i,j}^u$ . Also for  $j < i$ , let us denote by  $\mathcal{J}_{i,j}^s$  the union of all connected components of  $W_j^s \cap N_i$  which do not lie in  $int N_k$  with  $j < k < i$ . Let  $\mathcal{J}_i^s = \bigcup_{j=1}^{i-1} \mathcal{J}_{i,j}^s$ . Also we introduce the same sets  $\mathcal{J}_i^{ru}$  and  $\mathcal{J}_i^{rs}$  for  $f'$ . The embedding  $\varphi$  gives a one-to-one correspondence between the connected components  $J^u$  of  $\mathcal{J}_{i,j}^u$  and the connected components  $J'^u$  of  $\mathcal{J}_{i,j}^{ru}$  by the rule: there are exactly two connected components  $B_{J^u}$  of  $\partial U_i \cap U_j$  such that  $\partial J^u \subset B_{J^u}$  and the same for prime, then  $B_{J'^u} = \varphi(B_{J^u})$ .

**Lemma 5.** *There is a homeomorphism  $\psi^u : W_\Sigma^u \rightarrow W_{\Sigma'}^u$  consisting of conjugating homeomorphisms  $\psi_1^u : W_1^u \rightarrow W_1'^u, \dots, \psi_{beh(f)-1}^u : W_{beh(f)-1}^u \rightarrow W_{beh(f)-1}'^u$  such that:*

1)  $\psi_i^u(J^u) \subset J'^u$  for every segment  $J^u \subset \mathcal{J}_{j,i}^u, j < i$  and

$$\psi_i^u(F_{i,y}^s \cap W_i^u) = F_{i,\psi_i^u(y)}^{rs} \cap W_i'^u, \quad \text{for every } y \in J^u;$$

2)  $\psi_i^u(W_i^u \cap L^s \cap N_j) = W_i'^u \cap L'^s \cap N_j', j < i$ .

**Proof:** This statement is proved step by step from  $i = 1$  to  $i = beh(f) - 1$ .

First, take  $i = 1$ . Let  $\sigma \in \Sigma_1$  and  $\gamma_\sigma^u$  is the unstable separatrix of  $\sigma$ . Let us choose a point  $x \in \gamma_\sigma^u$ . Let  $a \in (F_{\sigma,x}^s \cap \partial U_\sigma)$ ,  $a' = \varphi(a)$ . Then the point  $F_{\sigma',a'}^{rs} \cap W_{\sigma'}^u$  belongs to the unstable separatrix of  $\sigma'$  which we denote by  $\gamma_{\sigma'}^u$ . Let us choose a point  $x' \in \gamma_{\sigma'}^u$  such that:

(\*) if  $F_{\sigma,x}^s \cap J^u \neq \emptyset$  for  $J^u \subset \mathcal{J}_1^u$  then  $F_{\sigma',x'}^{rs} \cap J'^u \neq \emptyset$  also.

Denote by  $I$  the segment  $[x, f^{per(\gamma_\sigma)}(x)] \subset \gamma_\sigma$ , by  $I'$  the segment  $[x', f^{per(\gamma_{\sigma'})}(x')] \subset \gamma_{\sigma'}$  and by  $\psi_I^u : I \rightarrow I'$  a homeomorphism such that  $\psi_I^u(x) = x'$ . After that we extend it up to a homeomorphism  $\psi_{\gamma_\sigma}^u : \gamma_\sigma \rightarrow \gamma_{\sigma'}$  by the formula

$$\psi_{\gamma_\sigma}^u(y) = f'^{n \cdot per(\gamma_{\sigma'})}(\psi_I^u(f^{n \cdot per(\gamma_\sigma)}(y))),$$

where  $f^{n \cdot per(\gamma_\sigma)}(y) \in I$ . Let us do the similar construction for each unstable separatrices of  $\Sigma_1$ , satisfying the condition  $\psi_{f(\gamma_\sigma)}^u = f' \psi_{\gamma_\sigma}^u f^{-1}$ . Then we get a homomorphism on  $W_1^u \setminus \Sigma_1$  which can be continuously extended up to the homeomorphism  $\psi_1^u : W_1^u \rightarrow W_1'^u$ . Due to (\*) we can define an embedding  $\psi_{J^u}^u$  on every  $J \subset \mathcal{J}_{1,j}^u, j > 1$  by the rule  $y' = \psi_{J^u}^u(y), y \in J^u$ , where

$$\psi_1^u(F_{1,y}^s \cap W_1^u) = F_{1,y'}^{rs} \cap W_1'^u.$$

For  $i = 2$  we do the similar construction for  $\psi_2^u$  assuming additionally that  $\psi_2^u|_{J^u} = \psi_{J^u}^u|_{J^u}$  for  $J^u \in \mathcal{J}_{1,2}^u$ . Also we can define an embedding  $\psi_{J^u}^u$  on every  $J^u \subset \mathcal{J}_{2,j}^u, j > 2$  by the rule  $y' = \psi_{J^u}^u(y), y \in J$ , where

$$\psi_2^u(F_{2,y}^s \cap W_2^u) = F_{2,y'}^{rs} \cap W_2'^u.$$

Continue this process we get the desired embeddings  $\psi_3^u, \dots, \psi_{beh(f)-1}^u$ .  $\diamond$

By the construction the homeomorphism  $\psi^u$  send the heteroclinic points of  $f$  to the heteroclinic points of  $f'$ . Then for every connected component  $J^s$  of  $\mathcal{J}_{i,j}^s$  passing through the point  $x \in W_i^u$  we will denote by  $J'^s$  a connected component of  $\mathcal{J}_{i,j}^{rs}$  passing through the point  $\psi_i^u(x) \in W_i'^u$ . Absolutely similar to proof of Lemma 5, but starting from  $i = beh(f) - 1$  to  $i = 1$ , we can prove the following result.

**Lemma 6.** *There is a homeomorphism  $\psi^s : W_\Sigma^s \rightarrow W_\Sigma'^s$  consisting of conjugating homeomorphisms  $\psi_1^s : W_1^s \rightarrow W_1'^s, \dots, \psi_{beh(f)-1}^s : W_{beh(f)-1}^s \rightarrow W_{beh(f)-1}'^s$  such that:*

1)  $\psi_i^s(J^s) \subset J'^s$  for every segment  $J^s \subset \mathcal{J}_{j,i}^s, j > i$  and

$$\psi_i^s(F_{i,y}^u \cap W_i^s) = F_{i,\psi_i^s(y)}^u \cap W_i'^s, \quad \text{for every } y \in J^u;$$

2)  $\psi^s|_{L^s \cap L^u} = \psi^u|_{L^s \cap L^u}$ .

Finitely for each  $i \in \{1, \dots, beh(f) - 1\}$  we construct an embedding  $\psi_i : \mathcal{N}_i \rightarrow \mathcal{N}_i'$  by the formula: for a point  $x = F_{i,x^u}^s \cap F_{i,x^s}^u, x^u \in W_i^u, x^s \in W_i^s$  we have  $\psi_i(x) = F_{i,\psi_i^u(x^u)}'^s \cap F_{i,\psi_i^s(x^s)}^u$ . It follows from Lemmas 5 and 6 that  $\psi_i(\mathcal{N}_i) \subset int(\mathcal{N}_i')$  and a map  $\psi$  composed by  $\psi_1, \dots, \psi_{beh(f)-1}$  is a homeomorphism. A choice of a maximal system of  $u$ -compatible neighborhoods with property  $\mathbf{N}_i \subset \mathcal{N}_i$  finishes the proof.  $\diamond$

## 7 Proof of Theorem 3: realizing diffeomorphisms

In this section we prove that for any abstract scheme  $S \in \mathcal{S}$  there is a diffeomorphism  $f \in MS(M^2)$  whose scheme is equivalent to the scheme  $S$ .

**Proof:** Let  $S = (\hat{\mathcal{V}}, \eta, \hat{\mathcal{U}})$  be an abstract scheme. Let us construct step by step a diffeomorphism  $f \in MS(M^2)$  such that the schemes  $S_f$  and  $S$  are equivalent.

**Step 1.** It follows from the definition of an abstract scheme that  $\hat{\mathcal{V}}$  is a disjoint union of the finite number 2-tori  $\hat{V}_1, \dots, \hat{V}_k$  with the map  $\eta_{\hat{\mathcal{V}}}$  composed from the non-trivial homomorphisms  $\eta_{\hat{V}_1}, \dots, \eta_{\hat{V}_k}$ . Then for each  $i \in \{1, \dots, k\}$  there is a number  $m_{\hat{V}_i} \in \mathbb{N}$  such that  $\hat{V}_i = ((\mathbb{R}^2 \setminus O) \times \mathbb{Z}_{m_{\hat{V}_i}})/b_i$ , where  $b_i : \mathbb{R}^2 \times \mathbb{Z}_{m_{\hat{V}_i}} \rightarrow \mathbb{R}^2 \times \mathbb{Z}_{m_{\hat{V}_i}}$  given by the formula

$$b_i(x_1, x_2, \lambda) = \begin{cases} (\frac{x_1}{2}, \frac{x_2}{2}, \lambda + 1), & \lambda \in \{1, \dots, m_{\hat{V}_i} - 1\}; \\ (\frac{x_1}{2}, \frac{x_2}{2}, 1), & \lambda = m_{\hat{V}_i} \end{cases}$$

and the natural projection  $p_i : (\mathbb{R}^2 \setminus O) \times \mathbb{Z}_{m_{\hat{V}_i}} \rightarrow \hat{V}_i$  induces the homomorphism  $\eta_{\hat{V}_i}$ . Denote by  $\mathcal{W}$  the disjoint union of  $\mathbb{R}^2 \times \mathbb{Z}_{m_{\hat{V}_1}}, \dots, \mathbb{R}^2 \times \mathbb{Z}_{m_{\hat{V}_k}}$  and by  $f_{\mathcal{W}}$  a diffeomorphism composed by  $a_1, \dots, a_r$ . Also denote by  $\mathcal{V}$  the disjoint union of  $(\mathbb{R}^2 \setminus O) \times \mathbb{Z}_{m_{\hat{V}_1}}, \dots, (\mathbb{R}^2 \setminus O) \times \mathbb{Z}_{m_{\hat{V}_k}}$  and by  $p_{\mathcal{V}} : \mathcal{V} \rightarrow \hat{\mathcal{V}}$  the natural projection.

**Step 2.** Let  $\hat{U}_1 = \bigcup_{j=1}^{n_1} \hat{U}_{1,j}$ . For each  $j \in \{1, \dots, n_1\}$  let  $U_{1,j} = p_{\mathcal{V}}^{-1}(\hat{U}_{1,j})$ . It follows from the definition of the abstract scheme that there are numbers  $m_{1,j} \in \mathbb{N}$ ,  $\nu_{1,j} \in \{-1, +1\}$ , a canonical neighborhood  $N$  and a diffeomorphism  $\mu_{1,j} : U_{1,j} \rightarrow N \times \mathbb{Z}_{m_{1,j}}$  which conjugate  $f_{\mathcal{W}}|_{U_{1,j}}$  with a diffeomorphism  $a_{1,j}|_{N \times \mathbb{Z}_{m_{1,j}}}$  given on  $N \times \mathbb{Z}_{m_{1,j}}$  by the formula

$$a_{1,j}(x_1, x_2, \lambda) = \begin{cases} (2x_1, \frac{x_2}{2}, \lambda + 1), & \lambda \in \{1, \dots, m_{1,j} - 1\}; \\ (\nu_{1,j} \cdot 2x_1, \nu_{1,j} \cdot \frac{x_2}{2}, 1), & \lambda = m_{1,j}. \end{cases}$$

Set  $A_{1,1} = \mathcal{W} \setminus \text{int}U_{1,1}$ ,  $B_{1,1} = N \times \mathbb{Z}_{m_{1,1}}$  and  $Q_{1,1} = A_{1,1} \cup_{\mu_{1,1}^{-1}} B_{1,1}$ ,  $\bar{Q}_{1,1} = A_{1,1} \cup B_{1,1}$ . Denote by  $p_{Q_{1,1}} : \bar{Q}_{1,1} \rightarrow Q_{1,1}$  the natural projection then projections  $p_{A_{1,1}} = p_{Q_{1,1}}|_{A_{1,1}}$ ,  $p_{B_{1,1}} = p_{Q_{1,1}}|_{B_{1,1}}$  induce structure of smooth connected orientable separable 3-manifold without boundary (possible non Hausdorff). Let us show that the space  $Q_{1,1}$  is Hausdorff.

For this aim it is enough to prove that a set  $E_{Q_{1,1}} = \{(x, y) \in \bar{Q}_{1,1} \times \bar{Q}_{1,1} : p_{Q_{1,1}}(x) = p_{Q_{1,1}}(y)\}$  is closed in  $\bar{Q}_{1,1} \times \bar{Q}_{1,1}$  (see, for example, a book [22] by Kosnevski). It is equivalent that  $(x, y) \in E_{Q_{1,1}}$  for any sequence  $(x_m, y_m) \in E_{Q_{1,1}}$  converging in the space  $\bar{Q}_{1,1} \times \bar{Q}_{1,1}$  to a point  $(x, y)$ . Without loss of generality we can suppose that all points of the sequence  $x_m$  ( $y_m$ ) belong to the same connected component of  $\bar{Q}_{1,1}$  as  $x$  ( $y$ ) (in the opposite case it is possible to consider a subsequence with such property). Let us consider four possibilities: 1)  $x_m, y_m \in A_{1,1}$ ; 2)  $x_m, y_m \in B_{1,1}$ ; 3)  $x_m \in A_{1,1}, y_m \in B_{1,1}$ ; 4)  $x_m \in B_{1,1}, y_m \in A_{1,1}$ .

In cases 1) and 2),  $x_m = y_m$ . Then  $x = y$  and, hence,  $(x, y) \in E_{Q_{1,1}}$ . In case 3)  $x_m \in A_{1,1}$ ,  $y_m \in B_{1,1}$ , hence  $y_m \in \partial N_{1,1}$  and  $x_m = \mu_{1,1}(y_m)$ . As  $\partial N_{1,1}$  is closed in  $\bar{Q}_{1,1}$  then, using continuation of the map  $\mu_{1,1}$ , we get next series of equalities:  $x = \lim_{m \rightarrow \infty} x_m = \lim_{m \rightarrow \infty} \mu_{1,1}(y_m) = \mu_{1,1}(\lim_{m \rightarrow \infty} (y_m)) = \mu_{1,1}(y)$ . Thus,  $(x, y) \in E_{Q_{1,1}}$ . In case 4) similar to above it is possible to prove that  $(x, y) \in E_{Q_{1,1}}$ .

Thus  $Q_{1,1}$  is smooth connected orientable 2-manifold without boundary. Set  $f_{A_{1,1}} = p_{A_{1,1}} f_{\mathcal{W}} p_{A_{1,1}}^{-1} : p_{A_{1,1}}(A_{1,1}) \rightarrow p_{A_{1,1}}(A_{1,1})$  and  $f_{B_{1,1}} = p_{B_{1,1}} a_{1,1} p_{B_{1,1}}^{-1} : p_{B_{1,1}}(B_{1,1}) \rightarrow p_{B_{1,1}}(B_{1,1})$ . By the construction the maps  $f_{A_{1,1}}$  and  $f_{B_{1,1}}$  are diffeomorphisms coinciding on set  $p_{A_{1,1}}(A_{1,1}) \cap p_{B_{1,1}}(B_{1,1})$ . Then a map  $f_{Q_{1,1}} : Q_{1,1} \rightarrow Q_{1,1}$  given by formula

$$f_{Q_{1,1}}(x) = \begin{cases} f_{A_{1,1}}(x), & x \in p_{A_{1,1}}(A_{1,1}); \\ f_{B_{1,1}}(x), & x \in p_{B_{1,1}}(B_{1,1}) \end{cases}$$

is a diffeomorphism of the manifold  $Q_{1,1}$ . By the construction non-wandering set of  $f_{Q_{1,1}}$  consists of unique saddle periodic orbit and  $r$  sink periodic orbits.

We will do the same operation with the all connected components of  $U_{1,j} \subset U_1$  to get a smooth connected orientable 2-manifold without boundary  $Q_{U_1}$  and a diffeomorphism  $f_{Q_{U_1}} : Q_{U_1} \rightarrow Q_{U_1}$  with a finite set  $\Sigma_1$  of the saddle periodic points and a finite set  $\Sigma_0$  of the sink periodic points.

Set  $\check{V} = (Q_{U_1} \setminus W_{\Sigma_1 \cup \Sigma_0}^u) / f_{Q_{U_1}}$  and denote by  $p_{\check{V}} : Q_{U_1} \setminus W_{\Sigma_1 \cup \Sigma_0}^u \rightarrow \check{V}$  the natural projection. Then the manifold  $\check{V}$  is equivalent to the manifold  $\hat{V}_{U_1} = \hat{V}_2$ .

Continuing this process we get a smooth connected orientable noncompact 2-manifold  $Q$  without boundary and a diffeomorphism  $f_Q : Q \rightarrow Q$  whose non-wandering set consists of finite set  $\Sigma$  of the saddle periodic hyperbolic orbits.

**Step 3.** Set  $C = Q \setminus W_{\Omega_{f_Q}}^u$ . Denote by  $\hat{C}$  the space of orbit of action  $f_Q$  on  $C$  and by  $p_{\hat{C}} : \hat{C} \rightarrow \hat{C}$  the natural projection. By the construction  $C$  is obtained by surgery of  $\hat{\mathcal{V}}_n$  along  $\hat{\mathcal{N}}_n$  and, hence, due to Proposition ??, it is homeomorphic to finite number (denote it  $k_u$ ) of copies of the torus. Similar to Step 1 for each connected component  $\hat{c}$  of  $\hat{C}$  there is a number

$m_{\hat{c}} \in \mathbb{N}$  and a diffeomorphism  $b_{\hat{c}} : \mathbb{R}^2 \times \mathbb{Z}_{m_{\hat{c}}} \rightarrow \mathbb{R}^2 \times \mathbb{Z}_{m_{\hat{c}}}$  given by the formula

$$b_{\hat{c}}(x_1, x_2, \lambda) = \begin{cases} (2x_1, 2x_2, \lambda + 1), \lambda \in \{1, \dots, m_{\hat{c}} - 1\}; \\ (2x_1, 2x_2, 1), \lambda = m_{\hat{c}} \end{cases}$$

such that  $f_Q|_{p_{\hat{c}}(\hat{c})}$  topologically conjugated with  $b_{\hat{c}}|_{(\mathbb{R}^2 \setminus O) \times \mathbb{Z}_{m_{\hat{c}}}}$  by means a diffeomorphism  $\mu_{\hat{c}}$ .

Denote by  $D_u$  a set composed by  $\mathbb{R}^2 \times \mathbb{Z}_{m_{\hat{c}}}$ ,  $\hat{c} \subset \hat{C}$ , by  $D'_u$  a set composed by  $(\mathbb{R}^2 \setminus O) \times \mathbb{Z}_{m_{\hat{c}}}$ ,  $\hat{c} \subset \hat{C}$ , by  $\mu_C : C \rightarrow D'_u$  the map composed by the homeomorphisms  $\mu_{\hat{c}}$ ,  $\hat{c} \subset \hat{C}$  and by  $b_C : D_u \rightarrow D'_u$  a map composed by  $b_{\hat{c}}$ ,  $\hat{c} \subset \hat{C}$ . Set  $M^2 = Q \cup_{\mu_C} D_u$ ,  $\bar{M}^2 = Q \cup D_u$  and denote by  $p_{M^2} : \bar{M}^2 \rightarrow M^2$  the natural projection. Like above a proof that the topological space  $M^2$  is smooth connected orientable 2-manifold without boundary reduces to checking that set  $E_{M^2} = \{(x, y) \in \bar{M}^2 \times \bar{M}^2 : p_{M^2}(x) = p_{M^2}(y)\}$  is closed in  $\bar{M}^2 \times \bar{M}^2$ , that is if a sequence  $(x_m, y_m) \in E_{M^2}$  converges in  $\bar{M}^2 \times \bar{M}^2$  to a point  $(x, y)$  then the point  $(x, y)$  belongs to  $E_{M^2}$ .

Consider four cases: 1)  $x_m, y_m \in Q$ ; 2)  $x_m, y_m \in D_u$ ; 3)  $x_m \in Q, y_m \in D_u$ ; 4)  $x_m \in D_u, y_m \in Q$ .

In cases 1) and 2),  $x_m = y_m$ . Then  $x = y$  and, hence,  $(x, y) \in E_{M^2}$ . In case 3)  $x_m \in Q, y_m \in D'_u, y_m = \mu_C(x_m)$  and there are two subcases: 3a)  $y \in D'_u$ ; 3b)  $y = O$ . In subcase 3a), like to above,  $x = \mu_C^{-1}(y)$  and, hence,  $(x, y) \in E_{M^2}$ . Show that case 3b) is impossible.

As  $y_m \in D'_u$  and  $y = O$  then the sequence  $x_m = \mu_C^{-1}(y_m)$  converges to  $x \in W_{\Sigma_1}^u \cup \Sigma_0$ . Then there is a sequence  $k_m \rightarrow +\infty$  such that  $f_Q^{-k_m}(x_m) \rightarrow z \in C$ . Thus  $b_C^{-k_m}(y_m) \rightarrow \mu_C^{-1}(z)$ . It is contradiction because  $b_C^{-k_m}(y_m) \rightarrow O$ .

The case 4) can be proved similarly to case 3).

Set  $p_Q = p_{M^2}|_Q, p_{D_u} = p_{M^2}|_{D_u}$  and  $f_{D_u} = p_{D_u} d_s p_{D_u}^{-1} : p_{D_u}(D_u) \rightarrow p_{D_u}(D_u)$ . Similar to above we can prove that a map  $f : M^2 \rightarrow M^2$  given by formula

$$f(x) = \begin{cases} f_Q(x), x \in p_Q(Q); \\ f_{D_u}(x), x \in p_{D_u}(D_u) \end{cases} \quad \text{is a diffeomorphism of the manifold } M^2 \text{ whose non-wandering}$$

set consists of  $k$  saddle periodic hyperbolic orbits and of  $k_s$  sink periodic hyperbolic orbits and of  $k_u$  source periodic hyperbolic orbits.

**Step 4.** In this step we show that the manifold  $M^2$  is compact and, hence, the diffeomorphism  $f$  belongs to the class  $MS(M^2)$  and its scheme by the construction is equivalent to the abstract scheme  $S$ .

For proof of compactness of  $M^2$  it is enough to show that any sequence  $\{x_n\} \in M^2$  has converging subsequence. If infinitely many members of  $\{x_n\}$  belong to  $\Omega_f$  the fact is obvious. Consider opposite case. By the construction  $M^2 = \bigcup_{p \in \Omega_f} W_p^s = \bigcup_{p \in \Omega_f} W_p^u$ . Up to consider a subsequence there is a point  $p_1 \in \Omega_f$  such that  $\{x_n\} \subset (W_{p_1}^s \setminus p_1)$ . Denote by  $K$  fundamental domain of the restriction of  $f$  to  $W_{p_1}^s \setminus p_1$ . Then for each member  $x_n$  of the sequence  $\{x_n\}$  there is an integer  $k_n$  such that  $y_n = f^{k_n}(x_n) \in K$ . Without loss of generality we can suppose that sequence  $\{y_n\} = \{f^{k_n}(x_n)\}$  converges to a point  $y \in K$  (in opposite case we can consider subsequence with such property). For the sequence  $\{k_n\}$  there are two possibilities:

- 1)  $\{k_n\}$  is bounded;
- 2)  $\{k_n\}$  is not bounded.



In case 1), up to consider a subsequence, the sequence  $\{k_n\}$  converges to an integer  $k$ . Then  $\lim_{n \rightarrow \infty} x_n = \lim_{n \rightarrow \infty} f^{-k_n}(y_n) = f^{-k}(y)$ . Thus a subsequence of  $\{x_n\}$  converges to  $f^{-k}(y) \in W_{p_1}^s$ .

In case 2), up to consider a subsequence,  $\{k_n\}$  converges to  $+\infty$  or  $-\infty$ . In case  $k_n \rightarrow -\infty$  a subsequence of  $\{x_n = f^{-k_n}(y_n)\}$  converges to  $p_1$ . In case  $k_n \rightarrow +\infty$ , up to consider a subsequence, there is a point  $p_2 \in \Omega_f$  such that  $\{x_n\} \subset (W_{p_2}^u \setminus p_2)$  and, hence, a subsequence of  $\{x_n = f^{-k_n}(y_n)\}$  converges to  $p_2$ .  $\diamond$

## References

- [1] A. Andronov and L. Pontryagin. Rough systems. Doklady Akademii Nauk SSSR. 1937. 14 (5): 247–250.
- [2] D.V. Anosov. Grubost geodezicheskikh potokov na kompaktnykh rimanovykh mnogoo-braznykh otritsatelnoi krivizny, Dokl. AN SSSR, 145 (1962), 707-709.
- [3] D.V. Anosov. Geodesic flows on closed Riemannian manifolds of negative curvature, Proc. Steklov Inst. Math., 90 (1967), 1–235.
- [4] F. Béguin, Smale diffeomorphisms of surfaces: an algorithm for the conjugacy problem, Preprint. (1999).
- [5] A.N. Bezdenezhykh and V.Z. Grines. Dynamical Properties and Topological Classification of Gradient-Like Diffeomorphisms on Two-Dimensional Manifolds I. Sel. Math. Sov. 1992. V. 11, 1, 1–11.
- [6] A.N. Bezdenezhykh and V.Z. Grines, Dynamical Properties and Topological Classification of Gradient-Like Diffeomorphisms on Two-Dimensional Manifolds II. Sel. Math. Sov. 1992. V. 11, 1, 13–17.
- [7] C. Bonatti and V. Grines, Knots as topological invariant for gradient-like diffeomorphisms of the sphere  $S^3$ , J. Dyn. Control Syst. 6:4 (2000), 579–602.
- [8] Ch. Bonatti, V.Z. Grines and R. Langevin. Dynamical system in dimension 2 and 3: conjugacy, invariants and classification, Computation and Applied Mathematics, Vol 20, N.1-2, 11-50, 2011.
- [9] C. Bonatti, V. Grines, V. Medvedev and E. Pecou. Topological classification of gradient-like diffeomorphisms on 3-manifolds, Journal: Topology , vol. 43, no. 2, pp. 369-391, 2004.
- [10] C. Bonatti, V. Z. Grines, and O. V. Pochinka. Classification of Morse-Smale diffeomorphisms with a finite set of heteroclinic orbits on 3-manifolds, Proc. Steklov Inst. Math. 250 (2005), 1–46.
- [11] C. Bonatti and R. Langevin, Difféomorphismes de Smale des surfaces. Asterisque. Societe mathematique de France. Paris. 1998, 250.

- [12] R. Bowen, Periodic points and measures for axiom A diffeomorphisms, Transactions of the American Math. Soc. —1971. — 154. —P. 337–397.
- [13] R. Bowen, Topological entropy and axiom A. 1970 Global Analysis (Proc. Sympos. Pure Math., Vol. XIV, Berkeley, Calif., 1968) pp. 23–41. Amer. Math. Soc., Providence.
- [14] A. Denjoy, Sur les courbes définies par les équations différentielles à la surface du tore. J. Math. Pure et Appl, 1932, 11, série 9, 333–375.
- [15] J. Franks. Knots, links and symbolic dynamics, Ann. of Math., 113 (1981) 529–552.
- [16] V. Grines. Topological classification of Morse-Smale diffeomorphisms with finite set of heteroclinic trajectories on surfaces. Math. Notes. 54(3), 881–889 (1993).
- [17] V.Z. Grines, E. Ya. Gurevich, V. S. Medvedev and O. V. Pochinka. On embedding a Morse-Smale diffeomorphism on a 3-manifold in a topological flow, Mat. Sb. 2012, 203:12, 81–104.
- [18] V.Z. Grines, S. K. Kapkaeva, O.V. Pochinka, A three-colour graph as a complete topological invariant for gradient-like diffeomorphisms of surfaces, Sbornik: Mathematics, 2014, 205:10, 1387–1412.
- [19] V. Grines, F. Laudenbach and O. Pochinka, Dynamically ordered energy function for Morse-Smale diffeomorphisms on 3-manifolds. Proc. Steklov Inst. Math. 278, 34–48 (2012).
- [20] V. Grines, D. Malyshev, O. Pochinka, S. Zinina. Efficient Algorithms for the Recognition of Topologically Conjugate Gradient-like Diffeomorphisms. Regular and Chaotic Dynamics, 2016, Vol. 21, No. 2, pp. 189–203.
- [21] Grines V., Medvedev T., Pochinka O. Dynamical Systems on 2- and 3-Manifolds. Springer International Publishing Switzerland, 2016.
- [22] Ch. Kosnevisky. Initial course of algebraic topology, Moscow. Mir. 1983. 304 pp.
- [23] R. Langevin, Quelques nouveaux invariants des difféomorphismes Morse-Smale d’une surface. Ann. Inst. Fourier (Grenoble) 43(1), 265–278 (1993).
- [24] E. Leontovich and A. Mayer. On trajectories defining qualitative structure of decomposition of the sphere into trajectories. Dokl. Akad. Nauk SSSR. 1937. 14 (5), 251–257.
- [25] E. Leontovich, and A. Mayer. On a scheme defining topological structure of decomposition into trajectories. Dokl. Akad. Nauk SSSR. 1955. 103 (4), 557–560.
- [26] R. Mañé, A proof of the  $C^1$  stability conjecture. Inst. Hautes études Sci. Publ. Math. No. 66 (1988), 161–210.
- [27] A.G. Mayer, Rough transformation of the circle to the circle. Uch. Zap. GGU. 1939. Gorky, Pub. GGU, 12, 215–229.

- [28] W. de Melo and S. van Strien, One dimensional dynamics, *Ergebnisse der Mathematik und ihrer Grenzgebiete, Volume 25*, Springer Verlag 1993.
- [29] K.R. Meyer, Energy functions for Morse-Smale systems. *Amer. J. Math.* pp. 1031–1040 (1968).
- [30] T. Mitryakova and O. Pochinka. On necessary and sufficient conditions for the topological conjugacy of surface diffeomorphisms with a finite number of orbits of heteroclinic tangency. *Proc. Steklov Inst. Math.* 270 (2010), no. 1, 194-215.
- [31] T. Mitryakova and O. Pochinka. Realization of Cascades on Surfaces with Finitely Many Moduli of Topological Conjugacy, *Matematicheskie Zametki*, 2013, Vol. 93, No. 6, pp. 902–919.
- [32] A. Oshemkov and V. Sharko. Classification of Morse-Smale flows on two-dimensional manifolds. *Mat. Sb.*, 189:8 (1998), 93-140.
- [33] J. Palis. On Morse-Smale dynamical systems, *Topology*. 1969. V. 8. 4. 385–404.
- [34] J. Palis and W. Melo. Geometrical theory of dynamical systems, Moscow. Mir. 1998. 301 pp.
- [35] J. Palis and S. Smale, Structural stability Theorems. *Proceedings of the Institute on Global Analysis*, American Math. Society. 1970. V. 14, 223-231.
- [36] M. Peixoto. On Structural Stability. *Annals of Math.*, 69, 199-222.
- [37] M. Peixoto, Structural stability on two-dimensional manifolds. *Topology*. 1962. V. 1, 2, 101-120.
- [38] M. Peixoto, Structural stability on two-dimensional manifolds (a further remarks). *Topology*. 1963. V. 2, 2, 179-180.
- [39] M. Peixoto, On the classification of flows on two-manifolds. *Dynamical systems Proc. Symp. held at the Univ.of Bahia, Salvador, Brasil*. 1971. M.Peixoto (ed.) N.Y.London: Acad. press. 1973, 389-419.
- [40] D. Pixton. Wild unstable manifolds, *Topology* 16:2 (1977), 167–172.
- [41] O. Pochinka, Diffeomorphisms with mildly wild frame of separatrices, *Univ. Iagel. Acta Math.* 47, 149–154 (2009).
- [42] H. Poincaré, Mémoire sur les courbes définies par une équation différentielle I, II, III, IV. *J. Math. Pures et Appl.* (1881), 7, 375-422, (1882), 8, 251-286, (1885), 1, 167-244, (1886), 2, 151-217.
- [43] D. Rolfsen, *Knots and links*. University of British Columbia, Math. Lecture Series 7 (1990).

- [44] Ya. G. Sinai. Markov partitions and U-diffeomorphisms, *Funktsional. Anal. i Prilozhen.*, 2:1 (1968), 64-89; 2:3 (1968), . 70–80.
- [45] S. Smale, Morse inequalities for a dynamical systems. *Bull. Am. math. Soc.* 1960. V. 66, 43-49.
- [46] M. Shub, Morse-Smale diffeomorphisms are unipotent on homology, *Proc. Symp. Dyn. Syst*, Salvador (1973), 489–491.
- [47] M. Shub and D. Sullivan, Homology theory and dynamical systems, *Topology*, 1975, 4, 109–132.
- [48] S. Smale, Generalized Poincare’s conjecture in dimensions greater than four, *Bull. Amer. Math. Soc.* (1960) **66**, 485–488.
- [49] S. Smale, On gradient dynamical systems, *Annals Math.* (1961) **74** 199–206.
- [50] S. Smale, Generalized Poincare’s conjecture in dimensions greater than four, *Annals Math.* (1961), **74**. 391–406.
- [51] S. Smale, A structurally stable differentiable homeomorphism with an infinite number of periodic points, Report on the Symposium on non-linear oscillations, Kiev Mathematical Institute, 1961.
- [52] S. Smale Diffeomorphisms with many periodic points, *Differential and Combinatorial Topology*. Princeton, NJ (1965), 63–80.
- [53] S. Smale, Differentiable dynamical systems, *Bull. Amer. Math. Soc.* 1967. **73**, No1, 741–817.
- [54] M.C. Sullivan. Visually building Smale flows on  $S^3$ , *Topology Appl.*, 106 (1) (2000), pp. 1–19.
- [55] I.Yu. Vlasenko. A complete topological invariant for Morse-Smale diffeomorphisms on two-dimensional manifolds. Parts I, II. Some questions of the modern mathematics. *Proceeding of Mathematical Institute of NAN Ukrain.* – Kiev. 1998. – V. 25. – 60–93.
- [56] M. Wada. Closed orbits of non-singular Morse-Smale flows on  $S^3$ , *J. Math. Soc. Japan*, 41(3) (1989) 405–413.