

A structural characterisation of $\text{Av}(1324)$ and new bounds on its growth rate

David Bevan

Department of Computer and Information Sciences
University of Strathclyde
Glasgow, UK

Robert Brignall

School of Mathematics and Statistics
The Open University
Milton Keynes, UK

Andrew Elvey Price*

School of Mathematics and Statistics
The University of Melbourne
Victoria, Australia

Jay Pantone

Department of Mathematics
Dartmouth College
Hanover, NH, USA

Abstract

We establish an improved lower bound of 10.271 for the exponential growth rate of the class of permutations avoiding the pattern 1324, and an improved upper bound of 13.5. These results depend on a new exact structural characterisation of 1324-avoiders as a subclass of an infinite staircase grid class, together with precise asymptotics of a small *domino* subclass whose enumeration we relate to West-two-stack-sortable permutations and planar maps. The bounds are established by carefully combining copies of the dominoes in particular ways consistent with the structural characterisation. The lower bound depends on concentration results concerning the substructure of a typical domino, the determination of exactly when dominoes can be combined in the fewest distinct ways, and technical analysis of the resulting generating function.

1 Introduction

The class of 1324-avoiding permutations is notoriously difficult to enumerate. The other permutation classes that avoid a single permutation of length 4 were enumerated explicitly in the 1990s (see Bóna [4] and Gessel [22]). In contrast, even the exponential growth rate of $\text{Av}(1324)$ remains to be determined exactly.

If $\sigma = \sigma(1)\dots\sigma(n)$ is a permutation of length n , written in one-line notation, and π is a permutation of length $k \leq n$, then we say that π is *contained* in σ if there is a subsequence i_1, \dots, i_k of $1, \dots, n$ such that $\pi(\ell) < \pi(m)$ if and only if $\sigma(i_\ell) < \sigma(i_m)$, for all $\ell, m \in [k]$, that is $\sigma(i_1)\dots\sigma(i_k)$ is *order isomorphic* to π . We say that $\sigma(i_1)\dots\sigma(i_k)$ is an *occurrence* of π in σ and, for

*The third author is supported by an Australian government research training program scholarship.

each $\ell \in [k]$, that $\sigma(i_\ell)$ acts as a $\pi(\ell)$ in this occurrence. For example, 425 is the only occurrence of 213 in 84672531; the entry 5 acts as a 3 in this occurrence of 213.

If π is not contained in σ , then σ avoids π . We use $\text{Av}(\pi)$ to denote the set consisting of all permutations that avoid π . Note that $\text{Av}(\pi)$ is a hereditary class, or *permutation class*, in the sense that whenever $\sigma \in \text{Av}(\pi)$ and τ is contained in σ , then $\tau \in \text{Av}(\pi)$.

The exponential *growth rate* of the class $\text{Av}(\pi)$ is

$$\text{gr}(\text{Av}(\pi)) = \lim_{n \rightarrow \infty} \sqrt[n]{|\text{Av}_n(\pi)|},$$

where $\text{Av}_n(\pi)$ denotes the set of permutations of length n that avoid π . This limit is known to exist as a consequence of the resolution of the Stanley-Wilf conjecture by Marcus and Tardos [25]. More generally, if \mathcal{A} is an infinite set of combinatorial objects, then the *growth rate* of \mathcal{A} is $\text{gr}(\mathcal{A}) = \limsup_{n \rightarrow \infty} \sqrt[n]{|\mathcal{A}_n|}$, where we use \mathcal{A}_n to denote the set of elements of \mathcal{A} with size n .

For an introduction to the enumerative theory of permutation classes, see Vatter's thorough exposition [30]. The topic is also presented in a broader context in the books by Bóna [7] and Kitaev [23].

	Lower	Upper
2004: Bóna [5]		288
2005: Bóna [6]	9	
2006: Albert et al. [1]	9.47	
2012: Claesson, Jelínek and Steingrímsson [13]		16
2014: Bóna [8]		13.93
2015: Bóna [9]		13.74
2015: Bevan [3]	9.81	
<i>This work</i>	10.27	13.5

Table 1: A chronology of lower and upper bounds for $\text{gr}(\text{Av}(1324))$

Our interest is in the growth rate of the class $\text{Av}(1324)$, the subject of a number of papers over the last decade and a half. For an entertaining essay placing the problem in a wider historical context, see [18]. The history of rigorous lower and upper bounds for $\text{gr}(\text{Av}(1324))$ is summarised in Table 1. In addition to these, Claesson, Jelínek and Steingrímsson [13] make a conjecture regarding the number of 1324-avoiders of each length that have a fixed number of inversions, which if proven would yield an improved upper bound of $e^{\pi\sqrt{2/3}} \approx 13.002$.

With the help of computers, $|\text{Av}_n(1324)|$ has been determined for all $n \leq 50$. Conway, Guttmann and Zinn-Justin [14, 15] have analysed the numbers and give a numerical estimate for $\text{gr}(\text{Av}(1324))$ of 11.600 ± 0.003 . They also conjecture that $|\text{Av}_n(1324)|$ behaves asymptotically as $A \cdot \mu^n \cdot \lambda^{\sqrt{n}} \cdot n^\alpha$, for certain estimated constants A , μ , λ and α . If this conjecture were proved, then as a consequence of [21, Theorem 9], it would imply that the counting sequence for 1324-avoiders is not P-recursive (i.e. does not satisfy a linear recurrence with polynomial coefficients), perhaps going some way to explain the difficulties faced in its enumeration.

Our contribution to the investigation of the 1324-avoiders is to establish new rigorous lower and upper bounds on $\text{gr}(\text{Av}(1324))$. These rely on a new structural characterisation of $\text{Av}(1324)$ as

a subclass of an infinite staircase grid class, which we present in the next section. In Section 3, we investigate pairs of adjacent cells in the staircase, which we call *dominoes*, and give an exact enumeration (Theorem 3.1). Together with a result concerning *balanced* dominoes, this is sufficient to deduce a new upper bound of 13.5 and a new lower bound of 10.125 on the growth rate of $\text{Av}(1324)$, which we present in the following two sections as Theorems 4.1 and 5.1.

The lower bound can be increased by investigating the structure of dominoes in greater detail. In Section 6, we prove two asymptotic concentration results, relating to *leaves* and *empty strips*. Section 7 then presents a refinement of our staircase construction, a lower bound on the number of ways of combining dominoes, and a technical analysis of the resulting generating function. This yields, in Theorem 7.1, a lower bound on $\text{gr}(\text{Av}(1324))$ of 10.271.

2 Staircase structure

In this section, we present a structural characterisation of $\text{Av}(1324)$ as a subclass of a larger permutation class. This class is a *staircase class*, which is a special case of an infinite grid class of permutations. We begin by defining finite and infinite grid classes.

Suppose that M is a $t \times u$ matrix of (possibly empty) permutation classes, where t is the number of columns and u the number of rows. An M -*gridding* of a permutation σ of length n is a pair of sequences $1 = c_1 \leq \dots \leq c_{t+1} = n + 1$ (the *column dividers*) and $1 = r_1 \leq \dots \leq r_{u+1} = n + 1$ (the *row dividers*) such that for all $k \in [t]$ and $\ell \in [u]$, the entries of σ whose indices are in $[c_k, c_{k+1})$ and values in $[r_\ell, r_{\ell+1})$ are order isomorphic to an element of $M_{k,\ell}$. Thus, an M -gridding of σ partitions the entries of σ , with one part for each cell in M . A permutation together with one of its M -griddings is called an M -*gridded permutation*.

The *grid class* of M , denoted $\text{Grid}(M)$, consists of all the permutations that have an M -gridding. We also use $\text{Grid}^\#(M)$ to denote the set of all M -gridded permutations, every permutation in $\text{Grid}(M)$ being present once with each of its M -griddings.

The definition of a grid class extends naturally for infinite matrices. If M is an infinite matrix of permutation classes, then the *infinite grid class* $\text{Grid}(M)$ consists of all the permutations that have an M' -gridding, for some finite submatrix M' of M .

Of direct interest to us are *staircase classes*, infinite grid classes that have a staircase structure (for more on staircase classes, see [2]). Given two permutation classes, \mathcal{C} and \mathcal{D} , the *descending* $(\mathcal{C}, \mathcal{D})$ *staircase* is the infinite grid class

$$\text{Grid} \begin{pmatrix} \mathcal{C} & & & \emptyset \\ \mathcal{D} & \mathcal{C} & & \\ & \mathcal{D} & \mathcal{C} & \\ \emptyset & & \ddots & \ddots \end{pmatrix},$$

in which \mathcal{C} occurs in each cell on the diagonal, \mathcal{D} occurs on the subdiagonal, and the remaining cells contain the empty permutation class \emptyset .

The class of 1324-avoiders is a subclass of the descending $(\text{Av}(213), \text{Av}(132))$ staircase. This staircase class is central to our analysis, and we call it simply *the staircase*. It is illustrated in Figure 1.

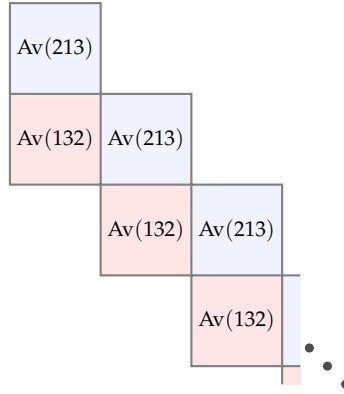

Figure 1: The descending $(\text{Av}(213), \text{Av}(132))$ staircase containing $\text{Av}(1324)$

Later, we make use of an important property of the cells in the staircase, which we introduce now. The *skew sum* of two permutations, denoted $\sigma \ominus \tau$, consists of a copy of σ positioned to the upper left of a copy of τ . Formally, given two permutations σ and τ with lengths k and ℓ respectively, their skew sum is the permutation of length $k + \ell$ consisting of a shifted copy of σ followed by τ :

$$(\sigma \ominus \tau)(i) = \begin{cases} \ell + \sigma(i) & \text{if } 1 \leq i \leq k, \\ \tau(i - k) & \text{if } k + 1 \leq i \leq k + \ell. \end{cases}$$

A permutation is *skew indecomposable* if it cannot be expressed as the skew sum of two shorter permutations. Note that every permutation has a unique representation as the skew sum of a sequence of skew indecomposable components. This representation is known as its *skew decomposition*. The permutation classes $\text{Av}(213)$ and $\text{Av}(132)$, used in the staircase, are both *skew closed*, in the sense that $\sigma \ominus \tau$ is in the class if both σ and τ are. The permutations in a skew closed class are precisely the skew sums of sequences of the skew indecomposable permutations in the class.

Proposition 2.1. $\text{Av}(1324)$ is contained in the descending $(\text{Av}(213), \text{Av}(132))$ staircase.

To prove this result, we describe how to construct an explicit gridding of any 1324-avoider in the staircase. Here, and elsewhere in our discussion, we identify a permutation σ with its *plot*, the set of points $(i, \sigma(i))$ in the Euclidean plane, and refer to its entries as *points*.

Proof. Consider any $\sigma \in \text{Av}(1324)$ of length n . We construct a gridding of σ in the staircase as follows. Let p_1 be the leftmost point of σ , and iteratively identify subsequent points p_2, \dots, p_k as follows. See Figure 2 for an illustration.

- If i is even, let p_i be the uppermost point of σ that acts as a 1 in an occurrence of 213 consisting only of points to the right of the column divider adjacent to p_{i-1} . Insert a row divider immediately above p_i . If no suitable point exists, terminate.
- If $i > 1$ is odd, let p_i be the leftmost point of σ that acts as a 2 in an occurrence of 132 consisting only of points below the row divider adjacent to p_{i-1} . Insert a column divider immediately to the left of p_i . If no suitable point exists, terminate.

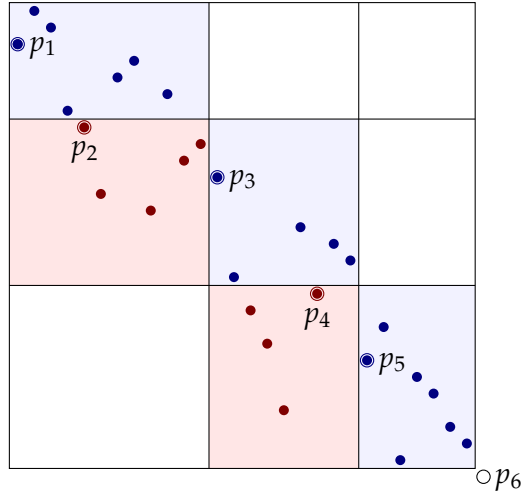

Figure 2: The greedy gridding of a 1324-avoider in the staircase

Since three points are required for an occurrence of 213 or 132, this process terminates after identifying k points, where $k \leq \lceil n/2 \rceil$. Finally, let p_{k+1} be a virtual point at $(n+1, 0)$, below and to the right of all points of σ .

By construction, if $i \in [2, k+1]$ is even, then the points of σ above p_i and to the right of the column divider adjacent to p_{i-1} avoid 213. Analogously, if $i \in [3, k+1]$ is odd, then the points of σ to the left of p_i and below the row divider adjacent to p_{i-1} avoid 132.

Furthermore, if $i \in [2, k]$ is even, then there are no points of σ below p_i and to the left of p_{i-1} , since any such point would form a 1324 with the 213 of which p_i acts as a 1. Analogously, if $i \in [3, k]$ is odd, then there are no points of σ to the right of p_i and above p_{i-1} , since any such point would form a 1324 with the 132 of which p_i acts as a 2.

Thus, the column and row dividers specify a valid M -gridding of σ , where M is a finite submatrix of the infinite matrix defining the staircase. \square

We call the gridding of a 1324-avoider σ constructed in the proof of Proposition 2.1 the *greedy gridding* of σ , because, as we descend the staircase, we place as many points of σ as possible in each subsequent cell. See Figure 3 for an illustration of the greedy gridding of a large permutation.¹

This structural characterisation has not been presented previously. However, the colouring approach used by Claesson, Jelínek and Steingrímsson in [13] and refined by Bóna in [8, 9] depends on the fact that $\text{Av}(1324)$ is a subclass of the *merge* of the permutation classes $\text{Av}(213)$ and $\text{Av}(132)$. Given two permutation classes \mathcal{C} and \mathcal{D} , their merge, written $\mathcal{C} \odot \mathcal{D}$, is the set of all permutations whose entries can be coloured blue and red so that the blue subsequence is order isomorphic to a member of \mathcal{C} and the red subsequence is order isomorphic to a member of \mathcal{D} .

¹The data for Figure 3 was provided by Einar Steingrímsson from the investigations he describes in [28, Footnote 4].

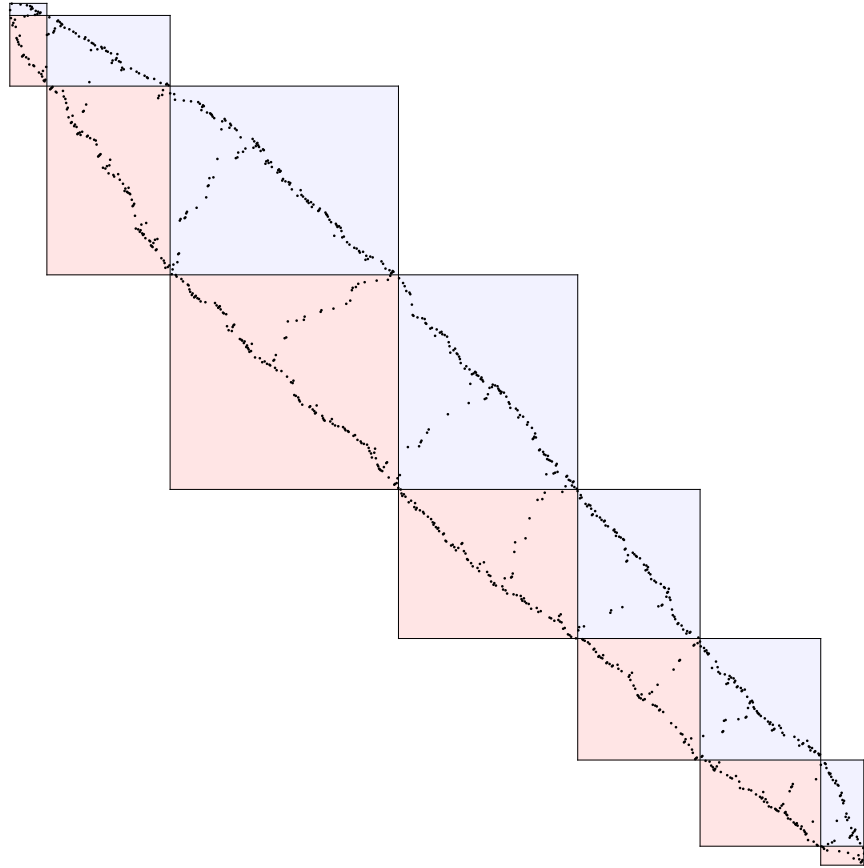

Figure 3: The greedy gridding of a 1324-avoider of length 1000

The descending staircase is contained in the merge $\text{Av}(213) \odot \text{Av}(132)$, since points gridded in the upper, $\text{Av}(213)$, cells collectively avoid 213, and the remaining points gridded in the lower, $\text{Av}(132)$, cells collectively avoid 132. Thus our new characterisation is a refinement of that used previously. However, the growth rate of the staircase and that of the merge are both 16 (see [2]), so Proposition 2.1 doesn't immediately yield any improvement over the upper bound in [13].

3 1324-avoiding dominoes

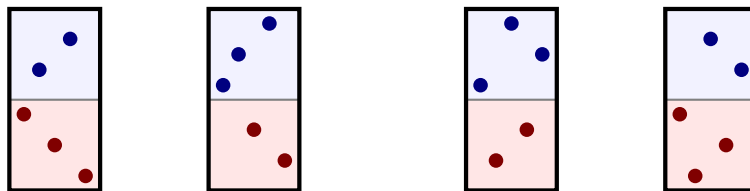
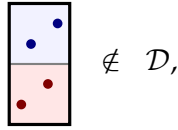

Figure 4: Four distinct small dominoes

To establish bounds on the growth rate of $\text{Av}(1324)$, we investigate pairs of adjacent cells in the griddings of 1324-avoiders in the staircase. We define a 1324-avoiding vertical *domino* to

be a two-cell *gridded permutation* in $\text{Grid}^{\#} \left(\begin{smallmatrix} \text{Av}(213) \\ \text{Av}(132) \end{smallmatrix} \right)$ whose underlying permutation avoids 1324. See Figure 4 for an illustration of four dominoes, the two at the left being distinct griddings of 34251, and the two at the right being distinct griddings of 31524. Let \mathcal{D} be the set of dominoes. It is important to note that



since \mathcal{D} consists of gridded 1324-avoiders. Moreover, within the grid class $\text{Grid} \left(\begin{smallmatrix} \text{Av}(213) \\ \text{Av}(132) \end{smallmatrix} \right)$, this is the *only* arrangement of points that must be avoided, since it is the only possible gridding of 1324 in the two cells. With the cell divider in any other position, either the top cell contains a 213 or the bottom cell contains a 132.

In this section we enumerate the gridded permutations in \mathcal{D} by placing them in bijection with certain arch configurations, proving the following theorem.

Theorem 3.1. *The number of n -point dominoes is $\frac{2(3n+3)!}{(n+2)!(2n+3)!}$. Consequently, $\text{gr}(\mathcal{D}) = 27/4$.*

This theorem, along with the result that *balanced* dominoes have the same growth rate (Proposition 3.6), gives us enough information to calculate improved upper and lower bounds for the growth rate of $\text{Av}(1324)$.

In order to prove Theorem 3.1, our first task is to establish a functional equation for the set of dominoes \mathcal{D} . We do this by representing dominoes as configurations consisting of an interleaved pair of arch systems, one for each of the two cells.

3.1 Arch systems

Let an n -point *arch system* consist of n points on a horizontal line together with zero or more noncrossing arcs, all on the same side of the line, connecting distinct pairs of points, such that no point is the left endpoint of more than one arc and no point is the right endpoint of more than one arc. See Figure 5. Note that these are not non-crossing *matchings*.

These arch systems are equinumerous with domino cells.² We make use of a bijection in which arcs correspond to occurrences of 12 in the cells, having the form $k(k+1)$ for some value k .

Proposition 3.2. *Both $\text{Av}_n(213)$ and $\text{Av}_n(132)$ are in bijection with n -point arch systems.*

Proof. We define a mapping Λ from $\text{Av}(213)$ and $\text{Av}(132)$ to arch systems. This mapping is illustrated in Figure 5. Given a 213-avoiding or 132-avoiding permutation σ of length n , let the points of the corresponding arch system $\Lambda(\sigma)$ be positioned at $1, \dots, n$ on the line. For each pair i, j with $1 \leq i < j \leq n$, connect the points at i and j with an arc if and only if $\sigma(j) = \sigma(i) + 1$.

²Despite being enumerated by the Catalan numbers, these specific arch systems are, rather surprisingly, not included in Stanley's book [27].

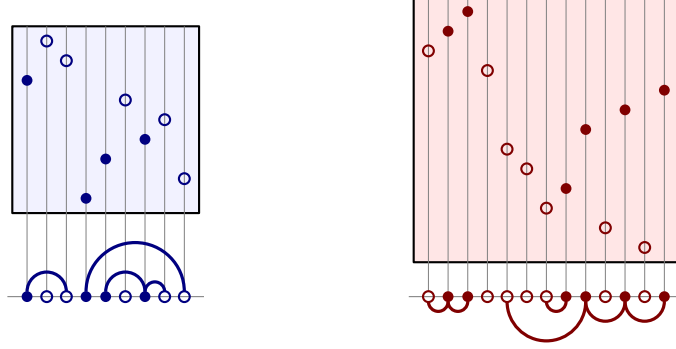

Figure 5: A 213-avoider and a 132-avoider with their arch systems

The result is a valid arch system. Crossing arcs could only result from an occurrence in σ of either 1324 or 3142, both of which contain both 213 and 132, and by construction no point can be the left endpoint of more than one arc or the right endpoint of more than one arc.

In the converse direction, we recursively define mappings Π_{213} and Π_{132} from arch systems to $\text{Av}(213)$ and $\text{Av}(132)$ respectively, such that for any arch system α , we have

$$\Lambda(\Pi_{213}(\alpha)) = \Lambda(\Pi_{132}(\alpha)) = \alpha. \quad (1)$$

Trivially, in both cases, we map the 0-point arch system to the empty permutation and the 1-point arch system to the singleton permutation 1.

Now, suppose α is the concatenation $\alpha_1\alpha_2$ of two nonempty arch systems. Then $\Pi_{213}(\alpha)$ is the skew sum $\Pi_{213}(\alpha_1) \ominus \Pi_{213}(\alpha_2)$, a copy of $\Pi_{213}(\alpha_1)$ being positioned to the upper left of $\Pi_{213}(\alpha_2)$. $\Pi_{132}(\alpha)$ is similar. Otherwise, $\Lambda(\Pi_{213}(\alpha))$ and $\Lambda(\Pi_{132}(\alpha))$ would have an arc connecting some point of α_1 to some point of α_2 .

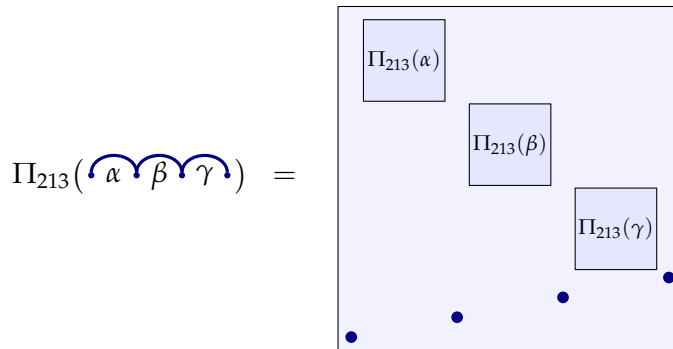

Figure 6: Mapping an arch system to a 213-avoider

Finally, suppose α is a sequence of k (possibly empty) arch systems, $\alpha_1, \dots, \alpha_k$, enclosed in k connected arcs, like $\alpha_1 \beta \dots \alpha_k$. Then $\Pi_{213}(\alpha)$ consists of $\Pi_{213}(\alpha_1 \dots \alpha_k)$ above the increasing permutation $12 \dots (k+1)$, where $\Pi_{213}(\alpha_i)$ is between i and $i+1$ for each i . See Figure 6 for an illustration. To satisfy (1), the endpoints of the arcs must map to consecutive increasing values in the permutation, and each $\Pi_{213}(\alpha_i)$ must be above $\Pi_{213}(\alpha_{i+1})$. To avoid creating an occurrence

of 213, each nonempty $\Pi_{213}(\alpha_i)$ must be above i and $i + 1$. Analogously, to avoid creating a 132, $\Pi_{132}(\alpha)$ consists of $\Pi_{132}(\alpha_1 \dots \alpha_k)$ below an increasing permutation of length $k + 1$. \square

As an aside, we note that the proof of Proposition 3.2 can easily be adapted to establish that in $\text{Av}_n(213)$ and $\text{Av}_n(132)$ each permutation is uniquely determined by the set consisting of the pairs of values comprising its ascents.

3.2 Arch configurations

A domino is comprised of a 213-avoiding top cell and a 132-avoiding bottom cell. Thus, by Proposition 3.2, corresponding to each domino is an *arch configuration* consisting of an interleaved pair of arch systems. See Figure 7 for an illustration. In the figures, the arch system for the top cell is shown above the line, and that for the bottom cell is below the line. Isolated points are marked with a short strut to indicate to which arch system they belong.

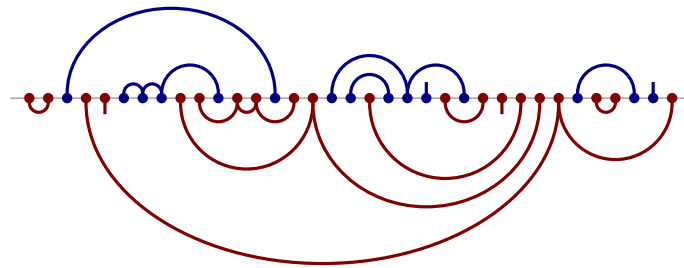
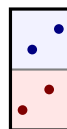





Figure 7: The arch configuration for a domino

Recall that the only restriction on the cells in a domino is that the following arrangement of points (forming a 1324) must be avoided.



The arch configuration corresponding to this is . Indeed, avoiding this pattern of arcs in an arch configuration is equivalent to avoiding 1324 in a domino.

Proposition 3.3. *The set \mathcal{D} of dominoes is in bijection with arch configurations that do not contain the pattern .*

Proof. By the bijection used in the proof of Proposition 3.2, an arch configuration contains an occurrence of  if and only if the corresponding pair of cells contains an occurrence of 1324 of the form $k\ell(k + 1)(\ell + 1)$, for values k and ℓ such that $\ell > k + 1$. So, if an arch configuration contains , the corresponding gridded permutation contains 1324.

For the converse, it suffices to show that if a permutation gridded in $\text{Grid}\left(\begin{smallmatrix} \text{Av}(213) \\ \text{Av}(132) \end{smallmatrix}\right)$ contains an occurrence of 1324, then it contains some, possibly distinct, occurrence of 1324 that has the

form $k\ell(k+1)(\ell+1)$. Suppose $abcd$ is an occurrence of 1324, gridded in $\text{Grid}\left(\begin{smallmatrix} \text{Av}^{(213)} \\ \text{Av}^{(132)} \end{smallmatrix}\right)$, where $a < b < c < d$. Then a and b are in the bottom, 132-avoiding, cell. Consider the set of values in the interval $I = \{a, a+1, \dots, b-1\}$. These must all occur to the left of b , otherwise a 132 would be formed. Let $a+i$, where $i \geq 0$, be the greatest element of I that occurs to the left of c ; this value must exist since a itself occurs before c . Then $(a+i)c(a+i+1)d$ is an occurrence of 1324 in which the first and third values differ by one.

Applying an analogous argument to the interval $J = \{c+1, \dots, d-1, d\}$ then yields $j \geq 0$ such that $(a+i)(d-j-1)(a+i+1)(d-j)$ is an occurrence of 1324 with the required form. \square

To enumerate dominoes, we construct a functional equation for arch configurations, which we then solve. We build arch configurations from left to right. A vertical line positioned between two points of an arch configuration may intersect some arcs. We call the partial arch configuration to the left of such a line an *arch prefix*; any arcs intersected by the line are *open*.

Let \mathcal{A} be the set of arch prefixes with no open *upper* arcs, and let $A(v) = A(z, v)$ be the ordinary generating function for \mathcal{A} , in which z marks points and v marks open *lower* arcs. Thus, $A(0) = A(z, 0)$ is the generating function for the set of dominoes \mathcal{D} .

Proposition 3.4. *The generating function $A(v) = A(z, v)$, for the set \mathcal{A} of arch prefixes with no open upper arcs, in which z marks points and v marks open lower arcs, satisfies the functional equation*

$$A(v) = \frac{1}{1 - zA(v)} + z(1+v) \left(A(v) + \frac{A(v) - A(0)}{v} \right). \quad (2)$$

Proof. There are six possible ways in which a non-empty element of \mathcal{A} can be decomposed, depending on its rightmost point. These are illustrated in Figure 8.

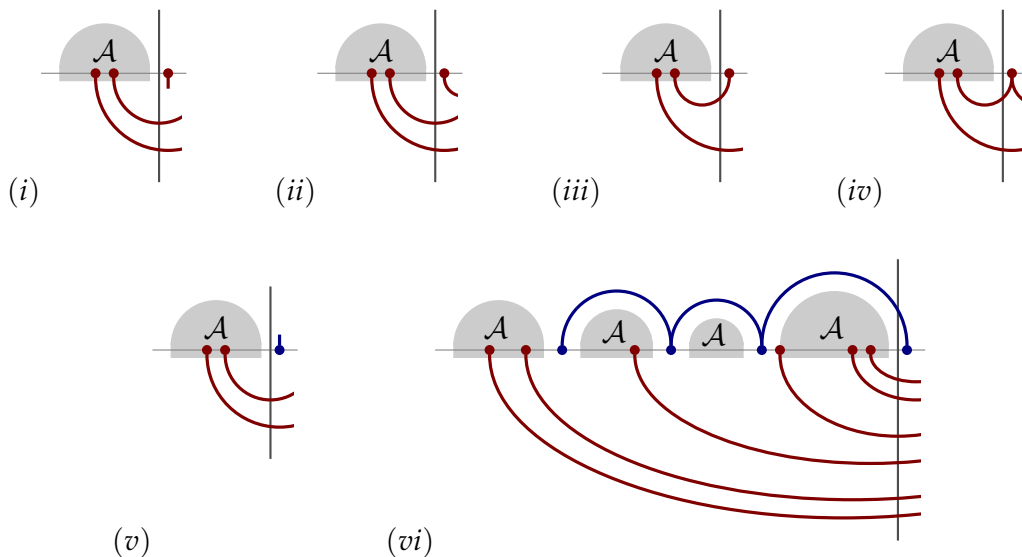

Figure 8: The six ways of decomposing a non-empty arch prefix in \mathcal{A}

If the rightmost point belongs to the lower arch system, then there are four cases: (i) an isolated point, (ii) the left endpoint of an arc, (iii) the right endpoint of an arc, and (iv) both the left and right endpoint of an arc. These contribute the following terms to the functional equation for $A(v)$:

$$(i) \ zA(v) \quad (ii) \ zvA(v) \quad (iii) \ zv^{-1}(A(v) - A(0)) \quad (iv) \ z(A(v) - A(0)).$$

If the rightmost point belongs to the upper arch system, then, since there are no open upper arcs, it is either (v) an isolated point, or else (vi) the right endpoint of an arc. In the former case, this contributes $zA(v)$ to the functional equation for $A(v)$. In the latter case, the arch prefix decomposes into a connected sequence of one or more upper arcs, each enclosing an element of \mathcal{A} (possibly empty), preceded by a further initial element of \mathcal{A} (also possibly empty). This makes a contribution of

$$\frac{z^2 A(v)^2}{1 - zA(v)}$$

to the functional equation for $A(v)$.

Summing these terms, including a term for the empty prefix, and simplifying, yields the functional equation in the statement of the proposition. \square

3.3 The enumeration of dominoes

To complete the proof of Theorem 3.1, we employ resultant methods to eliminate the variables v and $A(v)$ from the functional equation (2). This yields a minimal polynomial for $A(0)$ which we then use to derive the closed-form formula for the number of dominoes and their exponential growth rate.

Proof of Theorem 3.1. Clearing denominators from (2) and moving all terms to one side yields

$$0 = P(A(v), A(0), z, v)$$

where P is the polynomial

$$P(x, y, z, v) = (zv - z^2(1 + v)^2)x^2 + z^2(1 + v)xy + (z(1 + v)^2 - v)x - z(1 + v)y + v.$$

The presence of the term x^2 indicates that the kernel method does not apply here. Instead, we use a more general method of Bousquet-Mélou and Jehanne [11] which says that $A(v)$ and v can be eliminated from the functional equation via *iterated discriminants*. Specifically, define

$$Q(y, z) = \text{discrim}_v(\text{discrim}_x(P(x, y, z, v))).$$

Then it follows that the minimal polynomial for $A(0)$ is one of the irreducible factors of $Q(y, z)$. Performing the calculation, we find that

$$Q(y, z) = -256z^8 R_1(y, z)^2 R_2(y, z),$$

where

$$\begin{aligned} R_1(y, z) &= z^3 y^2 + z(1 - 4z)y + 4z - 1, \\ R_2(y, z) &= z^4 y^3 + 2z^2(3z + 1)y^2 + (12z^2 - 10z + 1)y + 8z - 1. \end{aligned}$$

The two series solutions of $0 = R_1(y, z)$ begin $y = z^{-1} + O(1)$ and $y = -z^{-2} + O(z^{-1})$, which do not match the known initial terms of $A(0)$. Therefore, it is R_2 that is a minimal polynomial for $A(0)$.

We verify that, for each n , the coefficient of z^n in the series expansion of $A(0)$ is given by

$$\frac{2(3n + 3)!}{(n + 2)!(2n + 3)!}$$

by using *Mathematica* [31].

```
minpoly[y_] := z^4 y^3 + 2z^2(3z + 1)y^2 + (12z^2 - 10z + 1)y + 8z - 1
series = Sum[2(3n + 3)!/((n + 2)!(2n + 3)!) z^n, {n, 0, Infinity}]
(2(-1 - 3z + Hypergeometric2F1[-2/3, -1/3, 1/2, 27z/4]))/(3z^2)

minpoly[series] // FunctionExpand // Simplify
0
```

The first command assigns the known minimal polynomial for $A(0)$ to the variable `minpoly`. The second command creates the power series that we want to verify is equal to $A(0)$; *Mathematica* deduces a nice form for this. The final command substitutes the power series into the minimal polynomial and simplifies. The result is 0, so the power series satisfies the minimal polynomial. Since the initial terms of the power series coincide with those of $A(0)$ and not with those of the other roots of R_2 , this completes the proof of the first part of Theorem 3.1.

To derive the growth rate, note that the exponential growth rate of an algebraic generating function (and, in fact, a complete asymptotic expansion) can be derived from the minimal polynomial using the method outlined by Flajolet and Sedgewick [20, Note VII.36]. The exponential growth rate must be the reciprocal of one of the roots of the discriminant of the minimal polynomial with respect to y . Since

$$\text{discrim}_y(z^4 y^3 + 2z^2(3z + 1)y^2 + (12z^2 - 10z + 1)y + 8z - 1) = -z^5(27z - 4)^3,$$

and with the knowledge that algebraic generating functions for combinatorial sequences are analytic at the origin [24, Proposition 3.1], we conclude that the exponential growth rate for the power series of $A(0)$ is $27/4 = 6.75$. \square

The counting sequence for dominoes is [A000139](#) in *OEIS* [29]. Among other things, this enumerates West-two-stack-sortable permutations [32], rooted nonseparable planar maps [12] and a class of branching polyominoes known as *fighting fish* [16, 17, 19]. So far, we have not been able to establish a bijection between dominoes and any of these structures.

Problem 3.5. Find a bijection between 1324-avoiding dominoes and another combinatorial class known to be equinumerous.

3.4 Balanced dominoes

We say that a domino is *balanced* if its top cell contains the same number of points as its bottom cell. Let \mathcal{B} be the set of balanced dominoes and \mathcal{B}_m be the set of balanced dominoes having a total of $2m$ points, m points in each cell. We define the growth rate of balanced dominoes to be $\text{gr}(\mathcal{B}) = \lim_{m \rightarrow \infty} \sqrt[2m]{|\mathcal{B}_m|}$. We prove that the growth rate of *balanced* dominoes is the same as that of *all* dominoes.

Proposition 3.6. *The growth rate of balanced dominoes is $27/4$.*

In the proof, we use two elementary manipulations of dominoes. Given a domino σ , let the 180° rotation of σ be denoted $\hat{\sigma}$. This is itself a valid domino. Also, given two dominoes σ and τ , define $\sigma \otimes \tau$ to be the domino whose arch configuration is produced by concatenating the arch configurations of σ and τ .

Proof of Proposition 3.6. Let $d(t, b)$ denote the number of $(t + b)$ -point dominoes with t points in the top cell and b points in the bottom cell. For a given m , let t_m be a value of t that maximises $d(t, m - t)$. Let $d_{\max} = d(t_m, m - t_m)$ be this maximal value. Since $0 \leq t \leq m$, there are only $m + 1$ possible choices for t_m . Hence by the pigeonhole principle,

$$d_{\max} \geq \frac{|\mathcal{D}_m|}{m + 1}.$$

Let σ and τ be any two m -point dominoes with t_m points in the top cell and $m - t_m$ points in the bottom cell. Consider the domino $\rho = \sigma \otimes \hat{\tau}$, whose arch configuration is constructed by concatenating the arch configuration of σ and the arch configuration of the 180° rotation of τ . This is a balanced domino in \mathcal{B}_m . Moreover, σ and τ can be recovered from ρ simply by splitting its arch configuration into two halves. Thus,

$$|\mathcal{B}_m| \geq d_{\max}^2 \geq \frac{|\mathcal{D}_m|^2}{(m + 1)^2}.$$

Since it is also the case that $|\mathcal{D}_{2m}| \geq |\mathcal{B}_m|$, it follows, by taking the $2m$ th root, and the limit as m tends to infinity, that $\text{gr}(\mathcal{B}) = \text{gr}(\mathcal{D}) = 27/4$. \square

4 An upper bound

In this section, we use the results of Section 3 to establish a new upper bound on the growth rate of the 1324-avoiders. Our upper bound follows from the fact that we can split a 1324-avoider, gridded in the staircase, in such a way as to produce a domino.

Theorem 4.1. *The growth rate of $\text{Av}(1324)$ is at most $27/2 = 13.5$.*

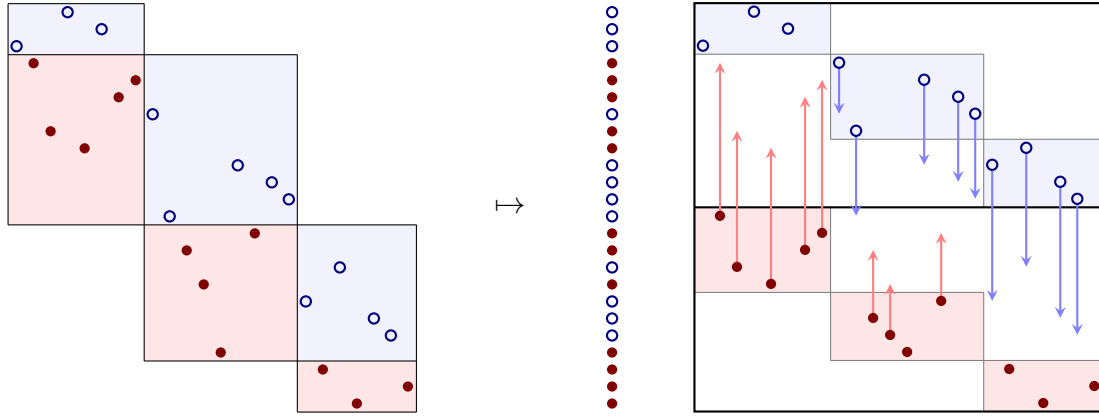

Figure 9: Mapping a greedy-gridded 1324-avoider to a binary word and a domino

Proof. We define an injection from $\text{Av}_n(1324)$ into the Cartesian product $\{\circ, \bullet\}^n \times \mathcal{D}_n$, for every $n \geq 1$, each permutation being mapped to a pair consisting of a binary word (over the alphabet $\{\circ, \bullet\}$) and a domino. See Figure 9 for an illustration. Given a 1324-avoider σ , let $\sigma^\#$ be the greedy gridding of σ in the descending ($\text{Av}(213)$, $\text{Av}(132)$) staircase.

The binary word is constructed by reading the points of σ from top to bottom and recording a ring (\circ) if the point is in an upper, $\text{Av}(213)$, cell of $\sigma^\#$, and recording a disk (\bullet) if it is in a lower, $\text{Av}(132)$, cell.

The domino is constructed by placing all the points from the upper cells of $\sigma^\#$ in the top cell of the domino, retaining their horizontal positions, and similarly placing the points from the lower cells of $\sigma^\#$ in the bottom cell of the domino. The result is a valid domino since the points gridded in the upper cells of $\sigma^\#$ collectively avoid 213, the points gridded in the lower cells collectively avoid 132 and no additional occurrence of 1324 can be created by splitting $\sigma^\#$ in this way.

This mapping is an injection, because the original permutation σ can be recovered from the domino by repositioning the points vertically according to the information in the binary word, as illustrated by the arrows in Figure 9.

Since there are 2^n binary words of length n and, by Theorem 3.1, the growth rate of the set of dominoes \mathcal{D} is $27/4$, the union of the Cartesian products has growth rate $2 \times 27/4 = 13.5$. The existence of the injection establishes that this value is an upper bound on the growth rate of $\text{Av}(1324)$. \square

The use of an arbitrary binary word to record the vertical interleaving of the points is very rudimentary. One would hope that the approach could be refined by recording this information as decorations on the domino in such a way as to yield a tighter upper bound, but we have not been able to do so.

5 An initial lower bound

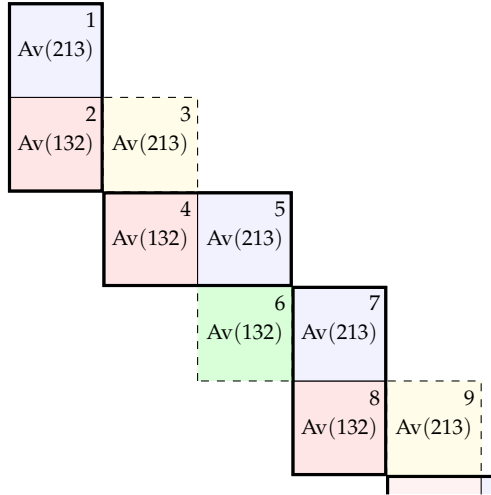

Figure 10: The decomposition of the staircase into dominoes and connecting cells

Our lower bounds depend on exploiting a specific partitioning of the staircase. We decompose the staircase into an alternating sequence of dominoes and individual *connecting cells*. See Figure 10 for an illustration. In the figure, dominoes are bordered by thick black lines and connecting cells have dashed borders. Specifically, if we number the cells $1, 2, \dots$, descending from the top left, as in the figure, then the decomposition is as follows. For each $j \geq 0$:

- Cells numbered $6j + 1$ and $6j + 2$ form a (vertical) domino.
- Cells numbered $6j + 3$ are connecting cells avoiding 213.
- Cells numbered $6j + 4$ and $6j + 5$ form a domino reflected about the line $y = x$ (a *horizontal domino*). The left cell avoids 132 and the right cell avoids 213.
- Cells numbered $6j + 6$ are connecting cells avoiding 132.

Observe that any occurrence of 1324 in the staircase is contained in a pair of adjacent cells, with two points in each cell. By definition, dominoes avoid 1324. So, to avoid 1324 in this decomposition of the staircase, it is only necessary to guarantee that an occurrence of 1324 is not created from two points in a connecting cell and two points in an adjacent domino cell.

Recall that every permutation has a unique representation as the skew sum of a sequence of skew indecomposable components. For brevity, we will refer to a skew indecomposable component simply as a *component*. To ensure that there is no occurrence of 1324, it is sufficient to require that every point in a domino cell is positioned *between* the components in the adjacent connecting cells. For example, if a domino cell is to the right of a connecting cell, then this restriction ensures that there is no occurrence of 132 in which the 13 is in the connecting cell and the 2 is in the domino cell. See Figure 11 for an illustration of a 132-avoiding connecting cell and its adjacent domino cells.

This construction enables us to establish a new lower bound on the growth rate of 1324-avoiders.

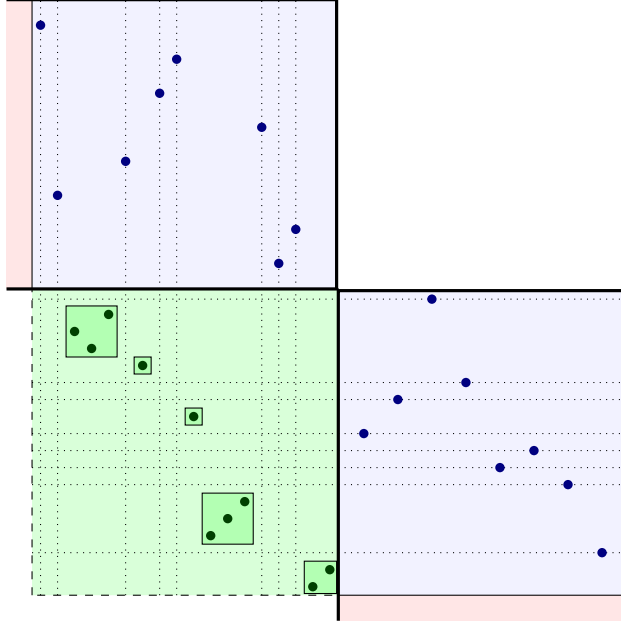

Figure 11: Interleaving the skew indecomposable components in a connecting cell with the points in the two adjacent domino cells

Theorem 5.1. *The growth rate of $\text{Av}(1324)$ is at least $81/8 = 10.125$.*

To prove this, we take an approach similar to that used by Bevan in [3].

Proof. For each $k \geq 1$, let \mathcal{P}_k be the set of gridded permutations, gridded in the first $3k$ cells of the staircase, decomposed as described above, with every point in a domino cell positioned between the skew indecomposable components in adjacent connecting cells, satisfying the following three conditions.

- Each domino cell contains $14k$ points.
- Each connecting cell contains $8k$ points.
- The permutation in each connecting cell has $7k$ skew indecomposable components.

Each element of \mathcal{P}_k is a gridded $36k^2$ -point permutation. The number of these gridded permutations is exactly

$$|\mathcal{P}_k| = |\mathcal{B}_{14k}|^k |\mathcal{C}_{8k,7k}|^k \binom{21k}{14k}^{2k-1},$$

where \mathcal{B}_n is, as before, the set of balanced dominoes with n points in each cell, and $\mathcal{C}_{n,c}$ is the set of n -point 213-avoiders (or 132-avoiders) with c skew indecomposable components. The final binomial coefficient counts the number of possible ways of interleaving $14k$ points in a domino cell with $7k$ skew indecomposable components in an adjacent connecting cell.

From Proposition 3.6, we know that $|\mathcal{B}_n| = (27/4)^{2n} \cdot \theta(n)$, where $\lim_{n \rightarrow \infty} \sqrt[n]{\theta(n)} = 1$. It is also known that $|\mathcal{C}_{n,c}| = \frac{c}{n} \binom{2n-c-1}{n-1}$, since $\mathcal{C}_{n,c}$ is equinumerous with the number of n -vertex Catalan forests with c trees (see [20] Example III.8).

Thus, using Stirling's approximation to determine the asymptotics of the binomial coefficients,

$$\begin{aligned} \lim_{k \rightarrow \infty} |\mathcal{P}_k|^{1/36k^2} &= \lim_{k \rightarrow \infty} \left[\left(\frac{27}{4} \right)^{28k^2} \theta(14k)^k \cdot \left(\frac{7}{8} \right)^k \binom{9k-1}{8k-1} \cdot \binom{21k}{14k}^{2k-1} \right]^{1/36k^2} \\ &= \frac{3^{7/3}}{4^{7/9}} \cdot \frac{3^{1/2}}{2^{2/3}} \cdot \frac{3^{7/6}}{2^{7/9}} = \frac{81}{8}. \end{aligned}$$

Since any n -point permutation can be gridded in j cells is at most $\binom{n+j-1}{j-1}$ ways, the number of ways of gridding a $36k^2$ -point permutation in $3k$ cells is no more than $(6k)^{6k}$. Hence,

$$|\text{Av}_{36k^2}(1324)| \geq |\mathcal{P}_k| \cdot (6k)^{-6k},$$

and thus $81/8$ is a lower bound on the growth rate of $\text{Av}(1324)$. \square

6 Domino substructure

To improve the lower bound of Theorem 5.1, we investigate the structure of dominoes in greater detail. Specifically we prove two concentration results. We say that a sequence of random variables X_1, X_2, \dots is *asymptotically concentrated at μ* if, for any $\varepsilon > 0$, for all sufficiently large n ,

$$\mathbb{P}[|X_n - \mu| \leq \varepsilon] > 1 - \varepsilon.$$

We consider two substructures, which we call *leaves* and *empty strips*, definitions of which are given below. For both, we determine the expected number in an n -point domino cell and establish that their proportion is concentrated at its mean. As a consequence, almost all dominoes contain “many” leaves and “many” empty strips. Thus, when we refine our staircase construction in the next section, we make use of dominoes that have lots of leaves and lots of empty strips.

6.1 Leaves

Recall that the right-to-left maxima of a permutation are those entries having no larger entry to the right. Similarly, left-to-right minima are those entries having no smaller entry to the left. We say that a point in the top, 213-avoiding, cell of a domino is a *leaf* if it is a right-to-left maximum of the permutation. Analogously, a point in the bottom, 132-avoiding, cell of a domino is a leaf if it is a left-to-right minimum of the permutation. (These correspond to leaves of the acyclic *Hasse graphs* of the cells; see [3, 10].) In Figure 5 on page 8, the leaves are shown as rings.

Recall, from Proposition 3.2, our bijection between domino cells and arch systems. Under this bijection, leaves in a 213-avoiding cell correspond exactly to points which are not the left ends of arcs, and leaves in a 132-avoiding cell correspond to points which are not the right ends of

arcs (see Figure 5). Thus, adapting Proposition 3.4, if $A(v, t) = A(z, v, t)$ satisfies the functional equation

$$A(v, t) = 1 + \frac{ztA(v, t)}{1 - zA(v, t)} + z(1 + v) \left(A(v, t) + \frac{A(v, t) - A(0, t)}{v} \right),$$

then $A(0, t) = A(z, 0, t)$ is the bivariate generating function for dominoes in which z marks points and t marks leaves in the top cell.

We want to know how many leaves we can expect to find in a domino cell. We calculate the expected number explicitly.

Proposition 6.1. *The total number of leaves in the top cells of all n -point dominoes is*

$$\frac{5(3n + 1)!}{(n - 1)!(2n + 3)!}.$$

Consequently, the expected number of leaves in an n -point domino is asymptotically $5n/9$.

In this and subsequent proofs, we use $\partial_x f$ to denote the partial derivative $\partial f / \partial x$.

Proof. The total number of leaves in the top cells of all n -point dominoes is given by the coefficient of z^n in $\partial_t A(0, t)|_{t=1}$. To calculate this, we use the same technique as in the proof of Theorem 3.1, finding a minimal polynomial $P_1(y, z, t)$ of degree 7 in y for $A(0, t)$, that is too long to display here.

Differentiating the equation $0 = P_1(y, z, t)$ with respect to t yields $0 = P_2(y, \partial_t y, z, t)$, where P_2 is a polynomial. We wish now to eliminate y from P_2 so that a minimal polynomial for $\partial_t A(0, t)$ remains. This is achieved by computing the resultant of P_1 and P_2 with respect to their first arguments. We find that

$$\text{Res}(P_1(y, z, t), P_2(y, y_1, z, t), y) = Q(z, t)R(y_1, z, t),$$

where $Q(z, t)$ is a polynomial only in z and t , and R is irreducible.

We conclude therefore that $R(y, z, t)$ is a minimal polynomial for $\partial_t A(0, t)$. Substituting $t = 1$ shows that $R(y, z, 1)$ factors into two terms, one of which must be a minimal polynomial for $\partial_t A(0, t)|_{t=1}$. By computing initial terms in the power series expansion of the roots of each factor, we deduce that $\partial_t A(0, t)|_{t=1}$ is a root of

$$z^3 y^3 + 5z^2 y^2 + (5z - 1)y + z.$$

It can be verified that the coefficient of z^n in the power series expansion of $\partial_t A(0, t)|_{t=1}$ is

$$\frac{5(3n + 1)!}{(n - 1)!(2n + 3)!}.$$

using *Mathematica* as in the proof of Theorem 3.1, or otherwise. Therefore, the expected number of leaves in the top cell of a domino with n points is

$$\frac{\frac{5(3n+1)!}{(n-1)!(2n+3)!}}{\frac{2(3n+3)!}{(n+2)!(2n+3)!}} = \frac{5n(n+2)}{6(3n+2)},$$

from which it follows by symmetry that the expected number of leaves in an n -point domino is asymptotically $5n/9$. \square

The sequence of coefficients of the power series for $\partial_t A(0, t)|_{t=1}$ is [A102893](#) in *OEIS* [29]. This has been shown by Noy [26] to count the number of noncrossing trees on a circle with $n+1$ edges and root degree at least 2. It would be interesting to find a bijection between these objects and the leaves of 1324-avoiding dominoes.

We need to show that the proportion of points that are leaves is asymptotically concentrated. We calculate the variance directly.

Proposition 6.2. *The proportion of leaves in the top cell of an n -point domino is asymptotically concentrated at its mean.*

Proof. Let E_n be the expected number of leaves in the top cell of an n -point domino, given by Proposition 6.1, and let V_n be the variance of the number of leaves in the top cell of an n -point domino. As described in Flajolet and Sedgewick [20, Proposition III.2],

$$V_n = \frac{[z^n] \partial_{tt} A(0, t)|_{t=1}}{[z^n] A(0, 1)} + E_n - E_n^2.$$

We start by determining $\partial_{tt} A(0, t)|_{t=1}$. The minimal polynomial for $\partial_{tt} A(0, t)|_{t=1}$ is computed from the minimal polynomial for $\partial_t A(0, t)$ using the same method as in the proof of Proposition 6.1. One finds that $0 = T(\partial_{tt} A(0, t)|_{t=1}, z)$, where

$$\begin{aligned} T(y, z) = & z^3(27z - 4)(64z^2 - 31z + 4)y^3 \\ & - 2z^2(27z - 4)(16z^3 + 39z^2 - 22z + 3)y^2 \\ & + 4(36z^6 + 186z^5 + 118z^4 - 243z^3 + 102z^2 - 17z + 1)y \\ & - 8z^2(z^4 + 8z^3 + 15z^2 - 8z + 1). \end{aligned}$$

The coefficient $[z^n] \partial_{tt} A(0, t)|_{t=1}$ is the total number of ordered pairs of distinct leaves in the top cells of n -point dominoes. Since this is more than the total number of leaves and no more than the square of that number, by Proposition 6.1 the dominant singularity of $\partial_{tt} A(0, t)|_{t=1}$ is $4/27$.

The minimal polynomial $T(y, z)$ allows us to compute the Puiseux expansion of $\partial_{tt} A(0, t)|_{t=1}$ at $z = 4/27$:

$$\partial_{tt} A(0, t)|_{t=1} = \frac{25}{144} \frac{1}{\sqrt{4/27-z}} + O(1).$$

It follows from [20, Theorem VI.1] that

$$[z^n] \partial_{tt} A(0, t)|_{t=1} = \frac{25}{96} \sqrt{\frac{3}{\pi}} \left(\frac{27}{4}\right)^n n^{-1/2} \left(1 + O\left(\frac{1}{n}\right)\right).$$

Using Stirling's Approximation, we find

$$[z^n]A(0,1) = |\mathcal{D}_n| = \frac{2(3n+3)!}{(n+2)!(2n+3)!} = \frac{27}{8} \sqrt{\frac{3}{\pi}} \left(\frac{27}{4}\right)^n n^{-5/2} \left(1 + O\left(\frac{1}{n}\right)\right).$$

Thus,

$$\frac{[z^n]\partial_{tt}A(0,t)|_{t=1}}{[z^n]A(0,1)} = \frac{\frac{25}{96} \sqrt{\frac{3}{\pi}} \left(\frac{27}{4}\right)^n n^{-1/2} \left(1 + O\left(\frac{1}{n}\right)\right)}{\frac{27}{8} \sqrt{\frac{3}{\pi}} \left(\frac{27}{4}\right)^n n^{-5/2} \left(1 + O\left(\frac{1}{n}\right)\right)} = \frac{25}{324} n^2 + O(n).$$

Therefore, the variance is

$$\left(\frac{25}{324} n^2 + O(n)\right) + \left(\frac{5}{18} n + O(1)\right) - \left(\frac{25}{324} n^2 + O(n)\right) = O(n).$$

As the variance is at most linear in n , the standard deviation is $O(\sqrt{n})$. Since the order of the standard deviation is strictly smaller than the order of the expected value, by Chebyshev's inequality the proportion of leaves is concentrated at its mean. \square

6.2 Empty strips

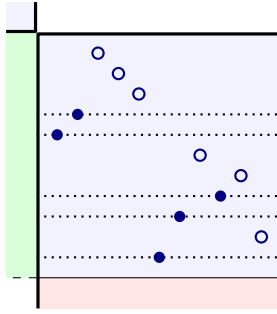

Figure 12: Strips in a domino cell

In a vertical domino, we consider the cells to be divided into horizontal *strips* by their non-leaf points. For example, in Figure 12 the cell is divided into six horizontal strips by its five non-leaf points. We are interested in the number of such strips which contain no leaves, which we call *empty strips*. In Figure 12 there are three empty strips.

By the bijection between domino cells and arch systems in Proposition 3.2, empty strips in a 213-avoiding cell correspond to arcs to the left of points that are both the left and right endpoint of an arc (see Figure 5). An empty strip is also possible at the bottom of the cell (but not at the top, the uppermost point always being leaf). This possibility does not affect the asymptotics, so we just count *medial* empty strips.

Thus, adapting Proposition 3.4, if $A(v,s) = A(z,v,s)$ satisfies the functional equation

$$A(v,s) = 1 + zA(v,s) + \frac{z^2 A(v,s)^2}{1 - zsA(v,s)} + z(1+v) \left(A(v,s) + \frac{A(v,s) - A(0,s)}{v} \right),$$

then $A(0, s) = A(z, 0, s)$ is the bivariate generating function for dominoes in which z marks points and s marks medial empty strips in the top cell.

How many empty strips can we expect to find in a domino cell? We calculate the expected number exactly.

Proposition 6.3. *The total number of medial empty strips in the top cells of all n -point dominoes is*

$$\frac{10(3n)!}{(n-3)!(2n+4)!}.$$

Consequently, the expected number of empty strips in an n -point domino cell is asymptotically $5n/27$.

Proof. The total number of medial empty strips in the top cells of all n -point dominoes is given by the coefficient of z^n in $\partial_s A(0, s)|_{s=1}$. Using the same approach as in the proof of Proposition 6.1, we can deduce that $\partial_s A(0, s)|_{s=1}$ is a root of the equation

$$z^4 y^3 - (15z + 2)z^2 y^2 - (10z^3 - 25z^2 + 10z - 1)y - z^3,$$

and verify that the coefficient of z^n in the power series expansion of $\partial_s A(0, s)|_{s=1}$ is exactly

$$\frac{10(3n)!}{(n-3)!(2n+4)!}.$$

Therefore, the expected number of medial empty strips in the top cell of a domino with n points is

$$\frac{\frac{10(3n)!}{(n-3)!(2n+4)!}}{\frac{2(3n+3)!}{(n+2)!(2n+3)!}} = \frac{5n(n-1)(n-2)}{6(3n+1)(3n+2)},$$

from which it follows by symmetry that the expected number of empty strips in an n -point domino is asymptotically $5n/27$. \square

The sequence of coefficients of the power series of $\partial_s A(0, s)|_{s=1}$ is [A233657](#) in *OEIS* [29]. These are the two-parameter Fuss–Catalan (or Raney) numbers with parameters $p = 3$ and $r = 10$. It would be interesting to find a bijection between medial empty strips in 1324-avoiding dominoes and some other combinatorial class enumerated by this sequence.

Again, we need a concentration result, so we determine the variance.

Proposition 6.4. *The proportion of empty strips in the top cell of an n -point domino is asymptotically concentrated at its mean.*

Proof. As before, the minimal polynomial for $\partial_{ss} A(0, s)|_{s=1}$ is computed from the minimal polynomial for $\partial_s A(0, s)$. It is a root of the cubic

$$\begin{aligned} & z^4(27z - 4)(64z^2 - 31z + 4)y^3 \\ & - 2z^2(27z - 4)(64z^4 - 1388z^3 + 534z^2 - 23z - 8)y^2 \\ & - 4(1536z^8 - 22676z^7 + 82275z^6 - 112651z^5 + 72411z^4 - 24430z^3 + 4471z^2 - 421z + 16)y \\ & - 8z^4(64z^5 - 719z^4 + 1371z^3 - 918z^2 + 213z - 16). \end{aligned}$$

This allows us to compute the Puiseux expansion of $\partial_{ss}A(0, s)|_{s=1}$ at $z = 4/27$:

$$\partial_{ss}A(0, s)|_{s=1} = \frac{25}{1296} \frac{1}{\sqrt{4/27-z}} + O(1).$$

It follows that

$$[z^n]\partial_{ss}A(0, s)|_{s=1} = \frac{25}{864} \sqrt{\frac{3}{\pi}} \left(\frac{27}{4}\right)^n n^{-1/2} \left(1 + O\left(\frac{1}{n}\right)\right).$$

Thus,

$$\frac{[z^n]\partial_{ss}A(0, s)|_{s=1}}{[z^n]A(0, 1)} = \frac{\frac{25}{864} \sqrt{\frac{3}{\pi}} \left(\frac{27}{4}\right)^n n^{-1/2} \left(1 + O\left(\frac{1}{n}\right)\right)}{\frac{27}{8} \sqrt{\frac{3}{\pi}} \left(\frac{27}{4}\right)^n n^{-5/2} \left(1 + O\left(\frac{1}{n}\right)\right)} = \frac{25}{2916} n^2 + O(n).$$

Therefore, the variance is

$$\left(\frac{25}{2916} n^2 + O(n)\right) + \left(\frac{5}{54} n + O(1)\right) - \left(\frac{25}{2916} n^2 + O(n)\right) = O(n).$$

The result follows by Chebyshev's inequality. \square

6.3 Dominoes with many leaves and many empty strips

As a consequence of these concentration results, sets of dominoes with many leaves and many empty strips have the same growth rate as the set of all dominoes. For $\alpha, \beta \in [0, 1]$, let $\mathcal{D}_n^{\alpha, \beta}$ be the set of n -point dominoes with at least $\alpha n/2$ leaves in each cell and at least $\beta n/2 + 1$ empty strips in each cell. Let $\mathcal{D}^{\alpha, \beta} = \bigcup_n \mathcal{D}_n^{\alpha, \beta}$. The use of $\beta n/2 + 1$, rather than $\beta n/2$, is explained in the proof of Proposition 6.6 below.

Corollary 6.5. *If $\alpha < 5/9$ and $\beta < 5/27$, then $\text{gr}(\mathcal{D}^{\alpha, \beta}) = 27/4$.*

Proof. By Propositions 6.1 and 6.2, for sufficiently large n , at least four fifths of n -point dominoes have $\alpha n/2$ or more leaves in their top cell, and, by symmetry, at least four fifths have $\alpha n/2$ or more leaves in their bottom cell. Let β' be in the open interval $(\beta, 5/27)$. Then, for sufficiently large n , we have $\beta' n/2 \geq \beta n/2 + 1$ and so, applying Propositions 6.3 and 6.4 with β' , at least four fifths of n -point dominoes have $\beta n/2 + 1$ or more empty strips in their top cell, and at least four fifths have $\beta n/2 + 1$ or more empty strips in their bottom cell. Hence asymptotically, at least one fifth of all dominoes are in $\mathcal{D}^{\alpha, \beta}$. The result follows from Theorem 3.1. \square

An analogous result holds for sets of *balanced* dominoes with many leaves and many empty strips. Let $\mathcal{B}_m^{\alpha, \beta}$ be the set of $2m$ -point balanced dominoes, with at least αm leaves in each cell and at least $\beta m + 1$ empty strips in each cell, and let $\mathcal{B}^{\alpha, \beta} = \bigcup_m \mathcal{B}_m^{\alpha, \beta}$.

Proposition 6.6. *If $\alpha < 5/9$ and $\beta < 5/27$, then $\text{gr}(\mathcal{B}^{\alpha, \beta}) = 27/4$.*

The proof mirrors that of Proposition 3.6.

Proof. For suitable values of the parameters, let $\mathcal{L}(t, b, \ell_{\top}, \ell_{\text{B}}, e_{\top}, e_{\text{B}})$ denote the set of $(t + b)$ -point dominoes with t points in the top cell, b points in the bottom cell, ℓ_{\top} leaves in the top cell, ℓ_{B} leaves in the bottom cell, e_{\top} empty strips in the top cell and e_{B} empty strips in the bottom cell. For a given m , let \mathcal{L}_m be some such set whose size is maximal subject to the conditions $t + b = m$, $\ell_{\top}, \ell_{\text{B}} \geq \alpha m/2$ and $e_{\top}, e_{\text{B}} \geq \beta m/2 + 1$. Note that $\mathcal{L}_m \subseteq \mathcal{D}_m^{\alpha, \beta}$. Since $0 \leq t, \ell_{\top}, \ell_{\text{B}}, e_{\top}, e_{\text{B}} \leq m$, there are at most $(m + 1)^5$ possible choices for the parameters. Hence by the pigeonhole principle,

$$|\mathcal{L}_m| \geq \frac{|\mathcal{D}_m^{\alpha, \beta}|}{(m + 1)^5}.$$

Let σ and τ be any two m -point dominoes from \mathcal{L}_m . Consider the domino $\rho = \sigma \otimes \tau$, whose arch configuration is constructed by concatenating the arch configuration of σ and the arch configuration of the 180° rotation of τ . This domino has m points in each cell and $\ell_{\top} + \ell_{\text{B}} \geq \alpha m$ leaves in each cell. If the top cell of σ has an empty strip at the bottom, then this combines with the non-empty strip at the bottom of the bottom cell of τ , in which case the top cell of ρ has $e_{\top} + e_{\text{B}} - 1$ empty strips. Otherwise it has $e_{\top} + e_{\text{B}}$ empty strips. In either case, this is at least $\beta m + 1$. An analogous argument applies to the bottom cell, so ρ is a balanced domino in $\mathcal{B}_m^{\alpha, \beta}$.

Moreover, σ and τ can be recovered from ρ simply by splitting its arch configuration into two halves. Thus,

$$|\mathcal{B}_m^{\alpha, \beta}| \geq |\mathcal{L}_m|^2 \geq \frac{|\mathcal{D}_m^{\alpha, \beta}|^2}{(m + 1)^{10}}.$$

Since it is also the case that $|\mathcal{D}_{2m}^{\alpha, \beta}| \geq |\mathcal{B}_m^{\alpha, \beta}|$, it follows, by taking the $2m$ th root, and the limit as m tends to infinity, that $\text{gr}(\mathcal{B}^{\alpha, \beta}) = \text{gr}(\mathcal{D}^{\alpha, \beta}) = 27/4$. \square

7 A better lower bound

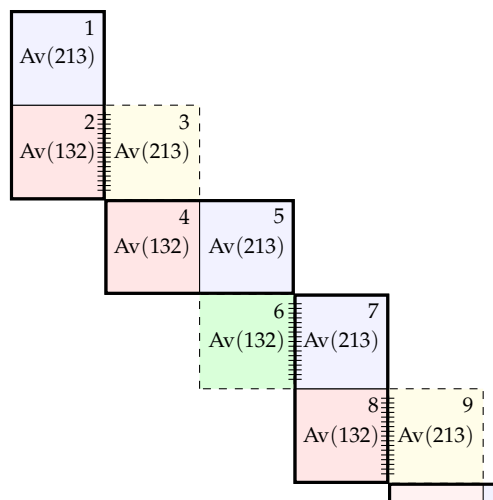

Figure 13: The decomposition of the staircase into dominoes and connecting cells

In this final section, we modify the construction used to prove Theorem 5.1 to yield an improved lower bound. We make use of exactly the same decomposition of the staircase, which we reproduce here in Figure 13. However, we change the rules concerning the permitted interleaving of points between the cells. We also exploit the additional properties of dominoes established in Section 6.

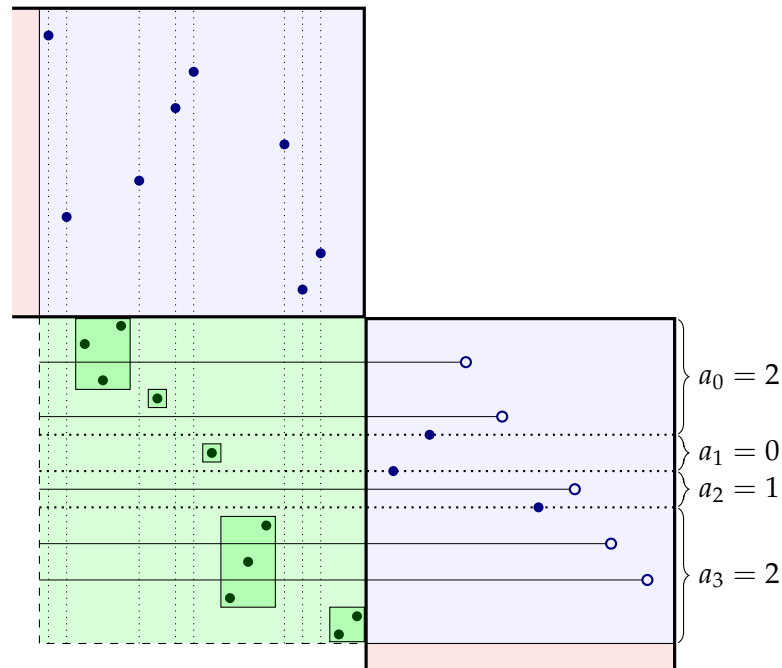

Figure 14: Interleaving the points in a connecting cell with those in two domino cells

Recall that in our earlier construction, we ensure that there is no occurrence of 1324 by requiring every point in a domino cell to be positioned between the components in the adjacent connecting cells, as illustrated in Figure 11. For our improved lower bound, we relax this restriction in the case of domino cells *to the left or right of a connecting cell*. In this case, we require only that *non-leaves* in a domino cell are positioned between the components. Leaves may be positioned arbitrarily. See Figure 14 for an illustration of a 132-avoiding connecting cell and its adjacent domino cells. In the domino cell to the right, leaves are shown as rings and non-leaves as disks.

This still prevents any occurrence of 1324. For example, if a domino cell is to the right of a connecting cell, then this restriction ensures that in any occurrence of 132 with the 13 in the connecting cell and the 2 in the domino cell the 2 is a leaf, so there can be no point to its upper right to complete a 1324. In Figure 13, this greater freedom is shown using small lines between connecting cells and horizontally adjacent domino cells. Observe that this flexibility *only* applies to the cells of vertical dominoes in the decomposition. We could similarly relax the restriction in the case of domino cells above and below a connecting cell. However, this results in a structure we have been unable to analyse.

This refined construction enables us to establish an improved lower bound on the growth rate of 1324-avoiders.

Theorem 7.1. *The growth rate of $\text{Av}(1324)$ is at least 10.271012.*

7.1 Horizontally interleaved connecting cells

Let us consider how a connecting cell can be interleaved with a horizontally adjacent domino cell. We want to enumerate diagrams like the lower two cells of Figure 14, where the points in the domino cell at the right have been erased, but the horizontal lines, solid for leaves and dotted for non-leaves, have been retained to record the positions of the points relative to the points in the connecting cell. Let us call these configurations *horizontally interleaved connecting cells*.

We begin with the generating function for connecting cells,

$$H(z, q) = \frac{1}{1 - qQ(z)} = \frac{2}{2 - q + q\sqrt{1 - 4z}}, \quad (3)$$

where z marks points, q marks components, and $Q(z) = \frac{1}{2}(1 - \sqrt{1 - 4z})$ is the generating function for components of a connecting cell.

As described in Section 6.2, the non-leaves of a vertical domino cell divide it and the adjacent connecting cell into horizontal strips. Suppose that such a domino cell has ℓ leaves and r non-leaves. The r non-leaves divide the cell into $r + 1$ horizontal strips, each containing a certain number of leaves. Let a_i denote the number of leaves in the i th strip from the top, for $i = 0, \dots, r$, so $a_0 + \dots + a_r = \ell$. See Figure 14 for an illustration.

The generating function for the possibilities in the i th strip is given by

$$H_{a_i}(z, q) = \Omega_{a_i}[H(z, q)], \quad (4)$$

where each Ω_j is a linear operator given by

$$\Omega_j[z^n] = \binom{n+j}{j} z^n,$$

or equivalently,

$$\Omega_j[F(z)] = \frac{1}{j!} \frac{\partial^j}{\partial z^j} (z^j F(z)). \quad (5)$$

Hence, for a fixed sequence $(a_i)_{i=0}^r$ of strip sizes, the generating function for horizontally interleaved connecting cells, counting once each possible way of interleaving with the contents of the horizontally adjacent domino cell, is given by

$$\prod_{i=0}^r H_{a_i}(z, q). \quad (6)$$

We cannot work directly with this expression, since it would require us to keep track of all the strip sizes. So, in order to establish a lower bound, we seek to minimise the above expression over all sequences a_0, \dots, a_r such that $a_0 + \dots + a_r = \ell$. With the next two propositions we

demonstrate that such a minimum exists for any fixed r and ℓ , in the sense that every coefficient of (6) is minimised for the same sequence a_0, \dots, a_r . More specifically, we prove that this minimum occurs when no two terms of the sequence differ by more than 1. We call such a sequence *equitable*.

In our refinement of the staircase, a certain number of the strips are required to be empty. With this additional requirement, for a lower bound, we thus need an equitable distribution of the leaves among the rest of the strips.

The following proposition is framed in the general setting of partially ordered rings, though for our purposes these are always rings of formal power series with real coefficients. Recall that a *partially ordered ring* (R, \leq) , is a (commutative) ring R together with a partial order \leq on the elements of R such that if $a, b, c \in R$ then $a \leq b$ if and only if $a + c \leq b + c$, and $a, b \geq 0$ implies $ab \geq 0$. Given such a ring (R, \leq) , we define $(R[[q]], \leq)$ to be the ring of formal power series over R equipped with the partial order defined by $h(q) \geq 0$ if and only if every coefficient of $h(q)$ is in $R_{\geq 0} = \{r \in R : r \geq 0\}$.

A sequence a_0, a_1, \dots in (R, \leq) is *log-convex* if, for every pair of integers i, j with $0 \leq i < j$, we have $a_i a_{j+1} \geq a_{i+1} a_j$.

Proposition 7.2. *Let (R, \leq) be a partially ordered ring and let a_0, a_1, \dots be a log-convex sequence in $R_{\geq 0}$. Furthermore, let $F(z) = a_0 + a_1 z + \dots$ be the generating function of this sequence. Then the sequence $\Omega_0[F(z)], \Omega_1[F(z)], \dots$ is log-convex in the partially ordered ring $(R[[z]], \leq)$.*

Proof. We just need to show that for each $k \geq 0$ and each $a > b \geq 0$,

$$[z^k] \left(\Omega_{a+1}[F(z)] \Omega_b[F(z)] - \Omega_a[F(z)] \Omega_{b+1}[F(z)] \right) \geq 0.$$

This coefficient can be computed as

$$\begin{aligned} & \sum_{j=0}^k \binom{a+1+j}{j} a_j \binom{b+k-j}{k-j} a_{k-j} - \sum_{j=0}^k \binom{a+j}{j} a_j \binom{b+1+k-j}{k-j} a_{k-j} \\ &= \sum_{j=0}^k \left(\binom{a+1+j}{j} \binom{b+k-j}{k-j} - \binom{b+1+j}{j} \binom{a+k-j}{k-j} \right) a_j a_{k-j} \\ &= \sum_{j=0}^k \sum_{i=0}^j \left(\binom{a+i}{i} \binom{b+k-j}{k-j} - \binom{b+i}{i} \binom{a+k-j}{k-j} \right) a_j a_{k-j} \\ &= \sum_{j=0}^k \sum_{i=0}^{k-j} \left(\binom{a+i}{i} \binom{b+j}{j} - \binom{b+i}{i} \binom{a+j}{j} \right) a_j a_{k-j} \\ &= \sum_{j=0}^k \sum_{i=0}^{\min(j-1, k-j)} \left(\binom{a+i}{i} \binom{b+j}{j} - \binom{b+i}{i} \binom{a+j}{j} \right) (a_j a_{k-j} - a_i a_{k-i}). \end{aligned}$$

Now, the coefficient of $a_j a_{k-j} - a_i a_{k-i}$ in each summand, namely

$$\binom{a+i}{i} \binom{b+j}{j} - \binom{b+i}{i} \binom{a+j}{j},$$

is negative, since $i < j$ and $a > b$. Also, since $i \leq k - j$, we have $a_i a_{k-i} \geq a_j a_{k-j}$. Hence each summand is nonnegative and the entire sum is positive, which implies that the sequence $\Omega_0[F(z)], \Omega_1[F(z)], \dots$ is log-convex in $(\mathbb{R}[[z]], \leq)$. \square

We now apply this to the enumeration of horizontally interleaved connecting cells.

Proposition 7.3. *Let*

$$H(z, q) = \frac{2}{2 - q + q\sqrt{1 - 4z}} = h_0(q) + zh_1(q) + z^2h_2(q) + \dots$$

be the generating function for connecting cells where z marks points and q marks components. Then the sequence of polynomials $h_0(q), h_1(q), \dots$ is log-convex in $(\mathbb{R}[[q]], \leq)$. Consequently, the sequence $H(z, q), H_1(z, q), H_2(z, q), \dots$ is log-convex in $(\mathbb{R}[[z, q]], \leq)$.

Proof. Since the generating function $H(z, q)$ satisfies the equation

$$H(z, q) = 1 + z \frac{q^2 H(z, q) - qH(z, 1)}{q - 1},$$

it follows that for each $i \geq 1$,

$$h_i(q) = \frac{q^2 h_{i-1}(q) - qh_{i-1}(1)}{q - 1} = \frac{q^2 h_{i-1}(q) - qc_{i-1}}{q - 1},$$

where $c_n = \binom{2n}{n} / (n + 1)$ is the n th Catalan number. Rearranging this gives the equation

$$h_{i-1}(q) = \frac{(q - 1)h_i(q) + qc_{i-1}}{q^2}.$$

We need to prove that if $j > i \geq 1$ then we have $h_{i-1}(q)h_j(q) \geq h_i(q)h_{j-1}(q)$. This happens if and only if

$$\frac{(q - 1)h_i(q) + qc_{i-1}}{q^2} h_j(q) \geq \frac{(q - 1)h_j(q) + qc_{j-1}}{q^2} h_i(q),$$

which simplifies to

$$c_{i-1}h_j(q) - c_{j-1}h_i(q) \geq 0.$$

One can easily prove by induction, or otherwise, that

$$h_i(q) = \sum_{k=1}^i h_{i,k} q^k, \text{ where } h_{i,k} = \frac{k}{2i - k} \binom{2i - k}{i}.$$

It suffices to demonstrate that $c_{i-1}h_{j,k} - c_{j-1}h_{i,k} \geq 0$ whenever $j > i \geq k \geq 1$. By transitivity, we only need consider the case $j = i + 1$, when it is readily confirmed that the required inequality holds:

$$c_{i-1}h_{i+1,k} - c_i h_{i,k} = \frac{k(k-1)(k-2)(2i-2)!(2i-k-1)!}{(i+1)!i!(i-1)!(i-k+1)!} \geq 0, \text{ if } i \geq k \geq 1.$$

Hence, the sequence $h_0(q), h_1(q), \dots$ is log-convex in $(\mathbb{R}[[q]], \leq)$. Consequently, by Proposition 7.2, the sequence $H(z, q), H_1(z, q), H_2(z, q), \dots$ is log-convex in $(\mathbb{R}[[z, q]], \leq)$. \square

Thus, as claimed above, among all sequences a_0, \dots, a_r which satisfy $a_0 + \dots + a_r = \ell$, the minimum value of every coefficient of

$$\prod_{i=0}^r H_{a_i}(z, q)$$

is achieved by *equitable* sequences, that is in which $|a_i - a_j| \leq 1$ for every $i, j \in \{0, \dots, r\}$. This, therefore, is what we apply to the non-empty strips to give a lower bound for the number of horizontally interleaved connecting cells.

7.2 Refining the staircase

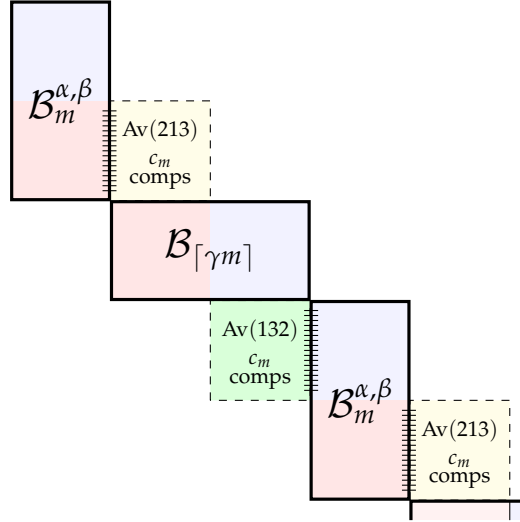

Figure 15: The scheme used to calculate the improved lower bound

We are now ready to describe more precisely how we modify our construction so as to yield an improved lower bound. This description is accompanied by Figure 15. Recall that $\mathcal{B}^{\alpha, \beta} = \bigcup_m \mathcal{B}_m^{\alpha, \beta}$, where $\mathcal{B}_m^{\alpha, \beta}$ consists of dominoes in which each cell has m points, at least αm leaves and at least $\beta m + 1$ empty strips. Let $\alpha, \beta > 0$ be sufficiently small that $\mathcal{B}^{\alpha, \beta}$ has exponential growth rate $27/4$. By Proposition 6.6, we may choose any $\alpha < 5/9$ and $\beta < 5/27$. We also require that $\alpha \geq 11/20$ and $\beta \geq 7/40$.

For fixed values of parameters α, β, γ and κ , and sufficiently large k and m , let $\mathcal{P}_{k, m}$ be the set of gridded permutations, gridded in the first $6k + 2$ cells of the staircase, satisfying the following conditions.

- Each non-leaf in a cell of a vertical domino is positioned between components of the horizontally adjacent connecting cell.
- Each point in a cell of a horizontal domino is positioned between components of the vertically adjacent connecting cell.
- Each vertical domino is an element of $\mathcal{B}_m^{\alpha, \beta}$.

- Each horizontal domino is a balanced domino with $\lceil \gamma m \rceil$ points in each cell, for some $\gamma > 0$ to be chosen later.
- Each connecting cell has c_m components, where $\lim_{m \rightarrow \infty} c_m/m = \kappa$, for some $\kappa > 0$; the value of κ and the sequence (c_m) are to be chosen later.

Note that each domino cell contains a fixed number of points (either m or $\lceil \gamma m \rceil$). However, the number of points in a connecting cell is not fixed, although its number of skew indecomposable components, c_m , is.

We begin by establishing a lower bound for the enumeration of horizontally interleaved connecting cells in $\mathcal{P}_{k,m}$. At least $\lceil \alpha m \rceil$ of the points are leaves, and at least $\lceil \beta m \rceil + 1$ of the strips are empty. Note first that changing a non-leaf to a leaf can only increase the number of ways of performing the interleaving. So, for a lower bound, we may assume there are exactly $\lceil \alpha m \rceil$ leaves. Note also that, since $\alpha > 1/2$, an equitable distribution of leaves among the strips allocates at least one leaf to each strip. Hence, any increase in the number of empty strips can only make the distribution less equitable. So, for a lower bound, we may assume there are exactly $\lceil \beta m \rceil + 1$ empty strips.

With these assumptions, given α in the interval $[11/20, 5/9)$, β in the interval $[7/40, 5/27)$ and $m \geq 32$, an equitable distribution of the leaves among the non-empty strips consists of

- $e_0(m) = \lceil \beta m \rceil + 1$ empty strips,
- $e_2(m) = 3m - 4 \lceil \alpha m \rceil - 3 \lceil \beta m \rceil$ two-leaf strips, and
- $e_3(m) = 3 \lceil \alpha m \rceil + 2 \lceil \beta m \rceil - 2m$ three-leaf strips.

The expressions for $e_2(m)$ and $e_3(m)$ are the solutions of the equations

$$\begin{aligned} 2e_2(m) + 3e_3(m) &= \lceil \alpha m \rceil, \\ e_0(m) + e_2(m) + e_3(m) &= m - \lceil \alpha m \rceil + 1, \end{aligned}$$

for the total number of leaves and the total number of strips, respectively. The bounds on α , β and m ensure that each of the $e_j(m)$ is nonnegative.

Thus, since the number of components in each connecting cell is exactly c_m ,

$$J_m(z) = [q^{c_m}] \left(H(z, q)^{e_0(m)} H_2(z, q)^{e_2(m)} H_3(z, q)^{e_3(m)} \right) \quad (7)$$

is a lower bound for the generating function of horizontally interleaved connecting cells in $\mathcal{P}_{k,m}$.

To understand the asymptotics of $J_m(z)$ for large m , we use the following general result, concerning the exponential growth rate of combinatorial objects whose generating function has coefficients of the form $[x^{(\kappa+o(1))n}] \prod_{j=1}^r F_j(x)^{(\alpha_j+o(1))n}$, for some fixed $\alpha_1, \dots, \alpha_r$ and κ .

Lemma 7.4. *Let $\alpha_1, \dots, \alpha_r$ and κ be positive constants. For each $j \in [r]$, let $F_j(x)$ be a power series with radius of convergence ρ_j . For each j , suppose that $a_{j,1}, a_{j,2}, \dots$ is a sequence of positive integers such that $\lim_{n \rightarrow \infty} a_{j,n}/n = \alpha_j$, and that there is some positive x_0 , smaller than every ρ_j , satisfying*

$$x_0 \sum_{j=1}^r \alpha_j \frac{F_j'(x_0)}{F_j(x_0)} = \kappa.$$

Then there exists a sequence of positive integers c_1, c_2, \dots such that $\lim_{n \rightarrow \infty} c_n/n = \kappa$, for which

$$\lim_{n \rightarrow \infty} \left([x^{c_n}] \prod_{j=1}^r F_j(x)^{a_{j,n}} \right)^{1/n} = x_0^{-\kappa} \prod_{j=1}^r F_j(x_0)^{\alpha_j}.$$

This lemma is rather easier to understand and its proof easier to follow when $r = 1$. Unfortunately, we need the more general version.

Proof. For each j , define the probability generating function

$$G_j(x) = \frac{F_j(x_0 x)}{F_j(x_0)}.$$

This definition is valid because $x_0 < \rho_j$.

The corresponding expected value is $\mu_j = G_j'(1) = x_0 F_j'(x_0) / F_j(x_0)$, so

$$\sum_{j=1}^r \alpha_j \mu_j = \kappa.$$

For each j , let X_j be a random variable with probability generating function G_j . For each $n > 0$, let Y_n be the random variable defined by adding $a_{j,n}$ independent samples from X_j for each j . Then the expected value λ_n of Y_n is given by

$$\lambda_n = \sum_{j=1}^r a_{j,n} \mu_j.$$

Moreover, it follows from the law of large numbers that if $\varepsilon > 0$, then the probability $p_{\varepsilon,n}$ that Y_n lies in the interval $(\lambda_n(1 - \varepsilon), \lambda_n(1 + \varepsilon))$ converges to 1 as n tends to infinity. In terms of generating functions, this means

$$\lim_{n \rightarrow \infty} \sum_{c \in (\lambda_n(1 - \varepsilon), \lambda_n(1 + \varepsilon))} [x^c] \prod_{j=1}^r G_j(x)^{a_{j,n}} = \lim_{n \rightarrow \infty} p_{\varepsilon,n} = 1. \quad (8)$$

For each pair ε, n , let $c(\varepsilon, n)$ be the value in the interval $(\lambda_n(1 - \varepsilon), \lambda_n(1 + \varepsilon))$ which maximises

$$[x^{c(\varepsilon, n)}] \prod_{j=1}^r G_j(x)^{a_{j,n}}.$$

Then, by (8), we have

$$\liminf_{n \rightarrow \infty} 2\varepsilon \lambda_n [x^{c(\varepsilon, n)}] \prod_{j=1}^r G_j(x)^{a_{j,n}} \geq 1.$$

It follows that

$$\lim_{n \rightarrow \infty} \left([x^{c(\varepsilon, n)}] \prod_{j=1}^r G_j(x)^{a_{j,n}} \right)^{1/n} = 1.$$

Therefore, we can choose a sequence c_1, c_2, \dots by setting $c_n = c(\varepsilon_n, n)$ in such a way that

$$\lim_{n \rightarrow \infty} \varepsilon_n = 0 \quad \text{and} \quad \lim_{n \rightarrow \infty} \left([x^{c_n}] \prod_{j=1}^r G_j(x)^{a_{j,n}} \right)^{1/n} = 1.$$

We now show that this sequence satisfies the desired properties. First note that c_n lies in the interval $(\lambda_n(1 - \varepsilon_n), \lambda_n(1 + \varepsilon_n))$, so the ratio c_n/λ_n converges to 1. Moreover,

$$\lim_{n \rightarrow \infty} \lambda_n/n = \lim_{n \rightarrow \infty} \sum_{j=1}^r a_{j,n} \mu_j/n = \sum_{j=1}^r \alpha_j \mu_j = \kappa.$$

Hence, the ratio c_n/n converges to κ . Finally,

$$\begin{aligned} \lim_{n \rightarrow \infty} \left([x^{c_n}] \prod_{j=1}^r F_j(x)^{a_{j,n}} \right)^{1/n} &= \lim_{n \rightarrow \infty} \left([x^{c_n}] \prod_{j=1}^r G_j(x/x_0)^{a_{j,n}} \prod_{j=1}^r F_j(x_0)^{a_{j,n}} \right)^{1/n} \\ &= x_0^{-\kappa} \lim_{n \rightarrow \infty} \left([x^{c_n}] \prod_{j=1}^r G_j(x)^{a_{j,n}} \right)^{1/n} \prod_{j=1}^r F_j(x_0)^{\alpha_j} \\ &= x_0^{-\kappa} \prod_{j=1}^r F_j(x_0)^{\alpha_j}. \quad \square \end{aligned}$$

Let us apply this lemma to $J_m(z)$, as defined in (7). For any fixed z_0 , there exists a sequence of positive integers c_1, c_2, \dots such that $\lim_{m \rightarrow \infty} c_m/m = \kappa$, for which

$$\lim_{m \rightarrow \infty} J_m(z_0)^{1/m} = q_0^{-\kappa} H(z_0, q_0)^\beta H_2(z_0, q_0)^{3-4\alpha-3\beta} H_3(z_0, q_0)^{3\alpha+2\beta-2}, \quad (9)$$

where $q_0 = q_0(z_0)$ satisfies

$$\beta \frac{\frac{d}{dq} H(z_0, q)}{H(z_0, q)} \Big|_{q=q_0} + (3 - 4\alpha - 3\beta) \frac{\frac{d}{dq} H_2(z_0, q)}{H_2(z_0, q)} \Big|_{q=q_0} + (3\alpha + 2\beta - 2) \frac{\frac{d}{dq} H_3(z_0, q)}{H_3(z_0, q)} \Big|_{q=q_0} = \frac{\kappa}{q_0}, \quad (10)$$

as long as q_0 is less than the radius of convergence in q of the $H_j(z_0, q)$. Note that each $H_j(z, q)$ can be determined explicitly from the definitions in (3), (4) and (5).

7.3 Enumerating the refined staircase

The first $6k + 2$ cells of the staircase consist of a total of $k + 1$ vertical dominoes, each in $\mathcal{B}_m^{\alpha, \beta}$, a total of k horizontal dominoes, each in $\mathcal{B}_{\lceil \gamma m \rceil}$, and $2k$ connecting cells. Thus, for sufficiently large m , the generating function for $\mathcal{P}_{k,m}$ is bounded below by

$$F_{k,m}(z) = \left| \mathcal{B}_m^{\alpha, \beta} \right|^{k+1} z^{2m(k+1)} \left| \mathcal{B}_{\lceil \gamma m \rceil} \right|^k z^{2\lceil \gamma m \rceil k} J_m(z)^{2k} \binom{\lceil \gamma m \rceil + c_m}{c_m}^{2k},$$

where the final binomial coefficient counts the number of possible ways of interleaving the $\lceil \gamma m \rceil$ points in a horizontal domino cell with the c_m components in a vertically adjacent connecting cell.

Let $A(z)$ be the generating function for $\text{Av}(1324)$, and for each k , let $A_k(z)$ be the generating function for the set of 1324-avoiding gridded permutations in the first $6k + 2$ cells of the (original) staircase. Thus, for any fixed k and m , and all n ,

$$[z^n]F_{k,m}(z) \leq [z^n]A_k(z) \leq \binom{n+6k+1}{6k+1}[z^n]A(z).$$

So, since the binomial coefficient is a polynomial in n , it follows from the second inequality that the radius of convergence of $A_k(z)$ is at least that of $A(z)$.

Hence, for any k , and any fixed z_0 within the radius of convergence of $A(z)$, the value of $F_{k,m}(z_0)$ is bounded above by $A_k(z_0)$ for every m . So $\limsup_{m \rightarrow \infty} F_{k,m}(z_0)^{1/m} \leq 1$, and as a consequence,

$$\lim_{k \rightarrow \infty} \left(\limsup_{m \rightarrow \infty} F_{k,m}(z_0)^{1/m} \right)^{1/2k} \leq 1.$$

By Propositions 3.6 and 6.6, equation (9) and Stirling's approximation, the left side of this inequality is equal to

$$G(z_0) = \left(\frac{27z_0}{4} \right)^{1+\gamma} q_0^{-\kappa} H(z_0, q_0)^\beta H_2(z_0, q_0)^{3-4\alpha-3\beta} H_3(z_0, q_0)^{3\alpha+2\beta-2} \frac{(\gamma + \kappa)^{\gamma+\kappa}}{\gamma^\gamma \kappa^\kappa},$$

for some appropriate sequence c_1, c_2, \dots , where q_0 is defined by (10).

To prove Theorem 7.1, it now suffices to find suitable values of $\alpha, \beta, \gamma, \kappa$ and z_0 , for which $G(z_0) > 1$ and such that q_0 satisfying (10) is less than the radius of convergence in q of the $H_j(z_0, q)$. Any such z_0 lies outside the radius of convergence of $A(z)$ and so $1/z_0$ is a lower bound on the growth rate of $\text{Av}(1324)$. We thus seek z_0 as small as possible.

Using $\alpha = 5/9 - 10^{-8}$, $\beta = 5/27 - 10^{-8}$, $\gamma \approx 0.951509$ and $\kappa \approx 0.496339$, we may take the value of z_0 to be approximately 0.097361383. Then $q_0 \approx 2.917054$ and the radius of convergence of the $H_j(z_0, q)$ is about 9.15, so q_0 is in the required range, and $G(z_0) > 1$. Therefore $1/z_0 \approx 10.271012$ is a lower bound on the growth rate of $\text{Av}(1324)$.³

7.4 Improving the lower bound further

How might this result be improved? Firstly, if we determined the expected proportion of k -leaf strips for $k \geq 1$, and established that their distribution was concentrated, then that would affect the optimal distribution of points between the strips, leading to a better bound. It is possible to modify the functional equation for dominoes to record k -leaf strips, for any k , but the result is complicated and it has not been possible to analyse the result, even for $k = 1$.

Secondly, as mentioned at the beginning of Section 7, we could relax our construction to permit leaves in vertically adjacent domino cells to be positioned arbitrarily, like the leaves in horizontally adjacent domino cells are. Due to the complex interaction between the interleaving of

³An alternative approach to analysing the refined staircase suggests that we could take the lower bound to be an algebraic number with a minimal polynomial of degree 104, whose value is approximately 10.27101292824530.

points in two directions, we have not been able to determine a lower bound for the number of possibilities. It seems likely that the one-dimensional solution in which leaves are distributed equitably between the strips does not carry over to interleaving in two directions.

Finally, if we established (a lower bound on) the growth rate of the set of permutations gridded in the first three cells of the staircase, then we could decompose the staircase into three-celled *trominoes* to yield a new bound. However, enumerating trominoes seems to require some new ideas.

Acknowledgements

For a while, Theorem 3.1 was just a conjecture based on numerical evidence. We are grateful to Vince Vatter, who was asked by the first two authors to present this conjecture in the problem session at the Permutation Patterns 2016 conference, which they were unable to attend.

References

- [1] ALBERT, M. H., ELDER, M., RECHNITZER, A., WESTCOTT, P., AND ZABROCKI, M. On the Stanley–Wilf limit of 4231-avoiding permutations and a conjecture of Arratia. *Adv. in Appl. Math.* 36, 2 (2006), 95–105.
- [2] ALBERT, M. H., PANTONE, J., AND VATTER, V. On the growth of merges and staircases of permutation classes. *Preprint. arXiv:1608.06969* (2016).
- [3] BEVAN, D. Permutations avoiding 1324 and patterns in Łukasiewicz paths. *J. London Math. Soc.* 92, 1 (2015), 105–122.
- [4] BÓNA, M. Exact enumeration of 1342-avoiding permutations: a close link with labeled trees and planar maps. *J. Combin. Theory Ser. A* 80, 2 (1997), 257–272.
- [5] BÓNA, M. A simple proof for the exponential upper bound for some tenacious patterns. *Adv. in Appl. Math.* 33, 1 (2004), 192–198.
- [6] BÓNA, M. The limit of a Stanley–Wilf sequence is not always rational, and layered patterns beat monotone patterns. *J. Combin. Theory Ser. A* 110, 2 (2005), 223–235.
- [7] BÓNA, M. *Combinatorics of Permutations*, second ed. Discrete Mathematics and its Applications. CRC Press, 2012.
- [8] BÓNA, M. A new upper bound for 1324-avoiding permutations. *Combin. Probab. Comput.* 23, 5 (2014), 717–724.
- [9] BÓNA, M. A new record for 1324-avoiding permutations. *Eur. J. Math.* 1, 1 (2015), 198–206.
- [10] BOUSQUET-MÉLOU, M., AND BUTLER, S. Forest-like permutations. *Ann. Comb.* 11, 3–4 (2007), 335–354.

- [11] BOUSQUET-MÉLOU, M., AND JEHANNE, A. Polynomial equations with one catalytic variable, algebraic series and map enumeration. *J. Combin. Theory Ser. B* 96, 5 (2006), 623–672.
- [12] BROWN, W. G. Enumeration of non-separable planar maps. *Canad. J. Math.* 15 (1963), 526–545.
- [13] CLAESSEON, A., JELÍNEK, V., AND STEINGRÍMSSON, E. Upper bounds for the Stanley–Wilf limit of 1324 and other layered patterns. *J. Combin. Theory Ser. A* 119, 8 (2012), 1680–1691.
- [14] CONWAY, A. R., AND GUTTMANN, A. J. On 1324-avoiding permutations. *Adv. in Appl. Math.* 64 (2015), 50–69.
- [15] CONWAY, A. R., GUTTMANN, A. J., AND ZINN-JUSTIN, P. 1324-avoiding permutations revisited. *Preprint. arXiv:1709.01248* (2017).
- [16] DUCHI, E., GUERRINI, V., RINALDI, S., AND SCHAEFFER, G. Fighting fish. *J. Phys. A* 50, 2 (2017).
- [17] DUCHI, E., GUERRINI, V., RINALDI, S., AND SCHAEFFER, G. Fighting fish: enumerative properties. *Sém. Lothar. Combin.* 78B (2017), Art. 43, 12 pp.
- [18] EGGE, E. S. Defying God: the Stanley-Wilf conjecture, Stanley-Wilf limits, and a two-generation explosion of combinatorics. In *A century of advancing mathematics*. Math. Assoc. America, Washington, DC, 2015, pp. 65–82.
- [19] FANG, W. Fighting fish and two-stack sortable permutations. *Preprint. arXiv:1711.05713* (2017).
- [20] FLAJOLET, P., AND SEDGEWICK, R. *Analytic combinatorics*. Cambridge University Press, 2009.
- [21] GARRABRANT, S., AND PAK, I. Words in linear groups, random walks, automata and P-recursiveness. *J. Combin. Algebra* 1, 2 (2017), 127–144.
- [22] GESSEL, I. M. Symmetric functions and P-recursiveness. *J. Combin. Theory Ser. A* 53, 2 (1990), 257–285.
- [23] KITAEV, S. *Patterns in Permutations and Words*. Springer, 2011.
- [24] KLAZAR, M. Bell numbers, their relatives, and algebraic differential equations. *J. Combin. Theory Ser. A* 102, 1 (2003), 63–87.
- [25] MARCUS, A., AND TARDOS, G. Excluded permutation matrices and the Stanley–Wilf conjecture. *J. Combin. Theory Ser. A* 107, 1 (2004), 153–160.
- [26] NOY, M. Enumeration of noncrossing trees on a circle. *Discrete Math.* 180, 1 (1998), 301–313.
- [27] STANLEY, R. P. *Catalan Numbers*. Cambridge Univ. Press, 2015.
- [28] STEINGRÍMSSON, E. Some open problems on permutation patterns. In *Surveys in Combinatorics 2013*, vol. 409 of *London Math. Soc. Lecture Note Ser.* Cambridge Univ. Press, 2013, pp. 239–263.

- [29] THE OEIS FOUNDATION INC. The On-Line Encyclopedia of Integer Sequences. Published electronically at <https://oeis.org>.
- [30] VATTER, V. Permutation classes. In *The Handbook of Enumerative Combinatorics*, M. Bóna, Ed. CRC Press, 2015, pp. 753–833.
- [31] WOLFRAM RESEARCH, INC. Mathematica. Version 10.3. www.wolfram.com/mathematica, 2015.
- [32] ZEILBERGER, D. A proof of Julian West’s conjecture that the number of two-stack-sortable permutations of length n is $2(3n)!/((n+1)!(2n+1)!)$. *Discrete Math.* 102, 1 (1992), 85–93.