

Finding branch-decompositions of matroids, hypergraphs, and more*

Jisu Jeong^{†1}, Eun Jung Kim^{‡2}, and Sang-il Oum^{§†34}

¹NAVER AI LAB, NAVER Clova, NAVER Corporation, Seongnam, 13561, South Korea

²Université Paris-Dauphine, PSL Research University, CNRS, UMR 7243, LAMSADE, 75016,
Paris, France

³Discrete Mathematics Group, Institute for Basic Science (IBS), Daejeon, 34126, South Korea

⁴Department of Mathematical Sciences, KAIST, Daejeon, 34141, South Korea

E-mail addresses: jisujeong89@gmail.com, eunjungkim78@gmail.com, sangil@ibs.re.kr

October 28, 2021

Abstract

Given n subspaces of a finite-dimensional vector space over a fixed finite field \mathbb{F} , we wish to find a “branch-decomposition” of these subspaces of width at most k that is a subcubic tree T with n leaves mapped bijectively to the subspaces such that for every edge e of T , the sum of subspaces associated to the leaves in one component of $T - e$ and the sum of subspaces associated to the leaves in the other component have the intersection of dimension at most k . This problem includes the problems of computing branch-width of \mathbb{F} -represented matroids, rank-width of graphs, branch-width of hypergraphs, and carving-width of graphs.

We present a fixed-parameter algorithm to construct such a branch-decomposition of width at most k , if it exists, for input subspaces of a finite-dimensional vector space over \mathbb{F} . Our algorithm is analogous to the algorithm of Bodlaender and Kloks (1996) on tree-width of graphs. To extend their framework to branch-decompositions of vector spaces, we developed highly generic tools for branch-decompositions on vector spaces. The only known previous fixed-parameter algorithm for branch-width of \mathbb{F} -represented matroids was due to Hliněný and Oum (2008) that runs in time $O(n^3)$ where n is the number of elements of the input \mathbb{F} -represented matroid. But their method is highly indirect. Their algorithm uses the nontrivial fact by Geelen et al. (2003) that the number of forbidden minors is finite and uses the algorithm of Hliněný (2006) on checking monadic second-order formulas on \mathbb{F} -represented matroids of small branch-width. Our result does not depend on such a fact and is completely self-contained, and yet matches their asymptotic running time for each fixed k .

Keywords: branch-width, rank-width, carving-width, matroid, fixed-parameter tractability

*An extended abstract of this paper appeared in [11].

[†]Supported by the National Research Foundation of Korea (NRF) grant funded by the Korea government (MSIT) (No. NRF-2017R1A2B4005020).

[‡]Supported by the French National Research Agency (ANR) under No.: ANR-17-CE23-0010 and No.: ANR-18-CE40-0025-01.

[§]Supported by the Institute for Basic Science (IBS-R029-C1).

1 Introduction

Let \mathbb{F} be a finite field and r be a positive integer. A *subspace arrangement* \mathcal{V} is a multiset of subspaces of \mathbb{F}^r , which can be represented by an $r \times m$ matrix M with an ordered partition $\mathcal{I} = \{I_1, I_2, \dots, I_n\}$ of $\{1, 2, \dots, m\}$ such that for every $1 \leq i \leq n$ the i th element of \mathcal{V} is the column space of the submatrix of M induced by the columns in I_i . Here, an *ordered partition* $\mathcal{I} = \{I_1, I_2, \dots, I_n\}$ of $\{1, 2, \dots, m\}$ is a partition of $\{1, 2, \dots, m\}$ such that $x < y$ for all $x \in I_i, y \in I_j$ with $i < j$. We remark that subspace arrangements can be regarded as representable *partitioned matroids* used in [8]. A partitioned matroid is a matroid equipped with a partition of its ground set.

Robertson and Seymour [18] introduced the notion of branch-width for graphs, hypergraphs, and more generally, for connectivity functions. We are going to define the branch-width of a subspace arrangement as follows. First, a tree is *subcubic* if every node has degree at most 3. We define a *leaf* of a tree as a node of degree at most 1. A *branch-decomposition* of \mathcal{V} is a pair (T, \mathcal{L}) of a subcubic tree T with no degree-2 nodes and a bijective function \mathcal{L} from the set of all leaves of T to \mathcal{V} . For a node v of T and an edge e incident with v , let us write $A_v(T - e)$ to denote the set of all leaves of T in the component of $T - e$ containing v . For a branch-decomposition (T, \mathcal{L}) of \mathcal{V} and each edge $e = uv$ of T , we define the *width* of e to be

$$\dim\left(\left(\sum_{x \in A_u(T-e)} \mathcal{L}(x)\right) \cap \left(\sum_{y \in A_v(T-e)} \mathcal{L}(y)\right)\right).$$

The *width* of (T, \mathcal{L}) is the maximum width of all edges of T . (If T has no edges, then the width of (T, \mathcal{L}) is 0.) The *branch-width* of \mathcal{V} is the minimum k such that there exists a branch-decomposition of \mathcal{V} having width at most k .

Here is our main theorem.

Theorem 1.1. *Let \mathbb{F} be a finite field, let r be a positive integer, and let k be a nonnegative integer. Let $\mathcal{V} = \{V_1, V_2, \dots, V_n\}$ be a subspace arrangement in \mathbb{F}^r where each V_i is given by its spanning set of d_i vectors and $m = \sum_{i=1}^n d_i$. In time $O(rm^2 + (k+1)rmn + k^3n^3 + f(|\mathbb{F}|, k)n^2)$ for some function f , one can either find a branch-decomposition of \mathcal{V} having width at most k or confirm that no such branch-decomposition exists.*

Various width parameters of discrete structures have been introduced and used for algorithmic and structural applications. One popular way of creating a width parameter of a discrete structure is to define it as the branch-width of some connectivity function defined on that discrete structure. Theorem 1.1 immediately gives rise to analogous algorithms for many of them, such as carving-width of graphs, rank-width of graphs, and branch-width of graphs, hypergraphs, and matroids. We will give a brief overview of each application. Later Section 2 will discuss these applications and necessary definitions in detail.

- **Branch-width of matroids represented over a finite field \mathbb{F} .** Let $\mathcal{V} = \{V_1, V_2, \dots, V_n\}$ be a subspace arrangement in \mathbb{F}^r . If each V_i is the span of a vector v_i in \mathbb{F}^r for each $i = 1, 2, \dots, n$, then \mathcal{V} can be identified with the matroid M represented by the vectors v_1, v_2, \dots, v_n . Furthermore, branch-width and branch-decompositions of M are precisely branch-width and branch-decompositions of \mathcal{V} , respectively.
- **Rank-width of graphs.** Rank-width, introduced by Oum and Seymour [14], is a width parameter of graphs expressing how easy it is to decompose a graph into a tree-like struc-

ture, called a *rank-decomposition*, while keeping every edge cut to have a small “complexity,” called the *width* of a rank-decomposition, where the complexity is measured by the matrix rank function. It will be shown in Section 2 that each vertex of a graph G can be associated with a subspace of dimension at most 2 so that the subspace arrangement \mathcal{V} consisting of all subspaces associated with the vertices of G has branch-width $2k$ if and only if G has rank-width k . Furthermore, a branch-decomposition of \mathcal{V} of width $2k$ corresponds to a rank-decomposition of G of width k .

- **Branch-width of graphs and hypergraphs.** Let $\mathbb{F} = GF(2)$ be the binary field and let $\{v_1, v_2, \dots, v_n\}$ be the standard basis of \mathbb{F}^n . For a hypergraph G with n vertices v_1, v_2, \dots, v_n , we associate each edge e with the span of the vertices incident with e . Let \mathcal{V} be the subspace arrangement consisting of all subspaces associated with the edges of G . Then it is straightforward to show that branch-width and branch-decomposition of G are precisely branch-width and branch-decomposition of \mathcal{V} , respectively.
- **Carving-width of graphs.** Seymour and Thomas [19] introduced carving-width of graphs. Let $\mathbb{F} = GF(2)$ be the binary field and let $\{e_1, e_2, \dots, e_m\}$ be the standard basis of \mathbb{F}^m . For a graph G with edges e_1, e_2, \dots, e_m , we associate each vertex v with the span of the edges incident with v . If \mathcal{V} is the subspace arrangement consisting of all subspaces associated with the vertices of G , then carving-width and carving of G are precisely branch-width and branch-decomposition of \mathcal{V} , respectively.

For the first two applications, the analogous theorems were proved earlier by Hliněný and Oum [8]. However, their approach was completely indirect; they use a nontrivial fact shown by Geelen et al. [6] that the class of matroids of branch-width at most k has finitely many forbidden minors, each having at most $O(6^k)$ elements. Then they use a monadic second-order formula to describe whether a matroid contains a fixed minor and use the dynamic programming algorithm to decide a monadic second-order formula aided by a given branch-decomposition of bounded width. So far this describes the decision algorithm of Hliněný [7] that decides whether branch-width is at most k . On top of this algorithm, Hliněný and Oum use a sophisticated reduction to modify the input and use the decision algorithm repeatedly to recover a branch-decomposition. Roughly speaking, this reduction attaches a gadget to the input matroid and this step requires extending the underlying finite field to an extension field, because this gadget is not representable if the underlying field is too small. As the list of forbidden minors is unknown, their algorithm should generate the list of minor-minimal matroids having branch-width larger than k . Thus, even for small values of k , it would be practically impossible to implement their algorithm. Contrary to the previous algorithm, our algorithm does not depend on the finiteness of obstructions and yet matches their asymptotic running time for each fixed k .

We do not know any previous analogous theorems for branch-width of hypergraphs. For branch-width of graphs, Thilikos and Bodlaender [20] posted a 50-page technical report in 2000 proving that for every fixed k , one can check in linear time whether a graph has branch-width at most k and, if so, output a branch-decomposition of minimum width. This work was presented at a conference in 1997 [2]. For carving-width of graphs, the conference paper of Thilikos, Serna, and Bodlaender [21] presented a linear-time algorithm for each fixed k that determines whether the carving-width of an input graph G is at most k and, if so, constructs a carving of G with minimum carving-width.

Let us turn our attention to the ingredients of our algorithm. We aim to solve the following problem.

BRANCH-WIDTH

Parameters: A finite field \mathbb{F} and an integer k .

Input: An $r \times m$ matrix M over \mathbb{F} with an ordered partition $\mathcal{I} = \{I_1, I_2, \dots, I_n\}$ of $\{1, 2, \dots, m\}$ and an integer k .

Output: A branch-decomposition (T, \mathcal{L}) of width at most k of a subspace arrangement \mathcal{V} consisting of the column space of the submatrix of M induced by the columns in I_i for each i or a confirmation that the branch-width of \mathcal{V} is larger than k .

We develop the framework inspired by the approach of Bodlaender and Kloks [1] on their work on tree-width. (A similar framework was also given independently by Lagergren and Arnborg [13].) They created a linear-time algorithm that can find a tree-decomposition of width at most k or confirm that the tree-width of an input graph is larger than k for each fixed k . They used dynamic programming based on a given tree-decomposition of bounded width. For the dynamic programming, they designed a special encoding of all possible tree-decompositions of width at most k that can arise from certain parts of a graph.

Our algorithm also uses a dynamic programming approach based on a given branch-decomposition of small width. Then, how do we generate a branch-decomposition of small width in the first place? For this purpose, we use the technique called the iterative compression, a technique initiated by Reed, Smith, and Vetta [17]. This technique reduces a problem to a “compression version” of the problem so that iteratively solving the compression version leads to a solution to the original problem. For our purpose, we consider the following compression version of the problem BRANCH-WIDTH.

BRANCH-WIDTH COMPRESSION

Parameters: A finite field \mathbb{F} and an integer k .

Input: An $r \times m$ matrix M over \mathbb{F} with an ordered partition $\mathcal{I} = \{I_1, I_2, \dots, I_n\}$ of $\{1, 2, \dots, m\}$, a branch-decomposition (T', \mathcal{L}') of \mathcal{V} of width at most $2k$, and an integer k , where \mathcal{V} is a subspace arrangement of the column spaces of the submatrix of M induced by the columns in I_i for each i .

Output: A branch-decomposition (T, \mathcal{L}) of width at most k of a subspace arrangement \mathcal{V} or a confirmation that the branch-width of \mathcal{V} is larger than k .

The next proposition is a simple proof of how the iterative compression solves the original problem BRANCH-WIDTH. The detailed analysis is in the proof of Theorem 1.1.

Proposition 1.2. BRANCH-WIDTH *can be solved by solving* BRANCH-WIDTH COMPRESSION *at most $n - 2$ times.*

Proof sketch. Let V_i be the column space of the submatrix of M induced by I_i for each $i = 1, 2, \dots, n$ and let $\mathcal{V} = \{V_1, V_2, \dots, V_n\}$. We may assume that $n \geq 2$. Let $\mathcal{V}_i = \{V_1, V_2, \dots, V_i\}$ and let M_i be the submatrix of M consisting of the columns in $I_1 \cup I_2 \cup \dots \cup I_i$ for each $i = 2, 3, \dots, n$. Note that M_i with a partition $\mathcal{I}_i = \{I_1, I_2, \dots, I_i\}$ corresponds to \mathcal{V}_i . We will later show that we may assume $|I_i| \leq k$ by preprocessing in Subsection 7.2.

For $i = 2$, there is only one branch-decomposition (T_2, \mathcal{L}_2) of \mathcal{V}_2 . If it has width larger than k , then we can stop, because the branch-width of \mathcal{V}_i is less than or equal to the branch-width of \mathcal{V} . So we may assume that (T_2, \mathcal{L}_2) has width at most k .

Now let us assume that $i \in \{3, 4, \dots, n\}$ and suppose that we have a branch-decomposition $(T_{i-1}, \mathcal{L}_{i-1})$ of \mathcal{V}_{i-1} with width at most k . Let us obtain T'_i from T_{i-1} by adding a leaf v adjacent to a new node created by subdividing one edge arbitrary. We extend \mathcal{L}_{i-1} to create \mathcal{L}'_i by mapping v to V_i . Then (T'_i, \mathcal{L}'_i) is a branch-decomposition of \mathcal{V}_i and it can be easily shown that (T'_i, \mathcal{L}'_i) has width at most $2k$, because $\dim V_i \leq k$ by the outcome of preprocessing. Now we use BRANCH-WIDTH COMPRESSION to find a branch-decomposition (T_i, \mathcal{L}_i) of width at most k for \mathcal{V}_i , or confirm that the branch-width of \mathcal{V}_i is larger than k . If the branch-width of \mathcal{V}_i is larger than k , then so is the branch-width of \mathcal{V} and therefore we can stop.

We repeat this for all $i \in \{3, 4, \dots, n\}$ and then (T_n, \mathcal{L}_n) is a branch-decomposition of width at most k for \mathcal{V} . We called BRANCH-WIDTH COMPRESSION at most $n - 2$ times to solve BRANCH-WIDTH. \square

Therefore, our algorithm focuses on solving BRANCH-WIDTH COMPRESSION, in which we are given a branch-decomposition of width at most $2k$. We use a dynamic programming approach, taking advantage of having a tree-like structure of the given branch-decomposition. To use a branch-decomposition for dynamic programming, we need a concept of a “boundary,” that plays the role of a bag in a tree-decomposition. For a branch-decomposition (T, \mathcal{L}) of \mathcal{V} and an edge e of T , we consider the boundary B as the intersection of the sum of subspaces associated to the leaves in one component of $T - e$ and the sum of subspaces associated to the leaves of the other component of $T - e$. As the branch-width is at most k , the boundary B has dimension at most k . Furthermore we restrict our attention to the finite field \mathbb{F} and so the number of subspaces of B is finite. For the convenience of dynamic programming on branch-decompositions, we define *transcripts* of a branch-decomposition in Section 3, which is essentially a precomputed list of bases and linear transformations useful for computing with boundaries.

As usual, we need a data structure to store partial solutions that may be extended to a branch-decomposition of width at most k , if it exists. We have two important aspects here.

First of all, we will restrict our search to a smaller set of branch-decompositions. Namely, if (T', \mathcal{L}') is a given branch-decomposition of width at most $2k$ in BRANCH-WIDTH COMPRESSION, then the algorithm will find a branch-decomposition of width at most k which is “well-behaved” with respect to the given decomposition (T', \mathcal{L}') , which we call *totally pure with respect to* (T', \mathcal{L}') . To prove that this smaller search space is sufficient to certify that branch-width is at most k , in Section 4 we introduce two operations, fork and split, that can modify a branch-decomposition of width k into another branch-decomposition of width at most k . By using these operations, we will show that if there is a branch-decomposition of width at most k , then there is a branch-decomposition of width at most k that is “well-behaved” (totally pure) with respect to (T', \mathcal{L}') .

Second, we will define a *B-namu* in Section 3, which will be a data structure to express partial solutions. Here, B is going to be the boundary for some edge in (T', \mathcal{L}') . A *B-namu* is, roughly speaking, a subcubic tree whose incidences are decorated by subspaces of B and whose edges are labeled by a nonnegative integer so that it represents the “shadow” of a branch-decomposition of width at most k on B . We will define an operation τ on *B-namus* that will compress a *B-namu* into a “compact” *B-namu* and prove that there are only finitely many compact *B-namus* of width at most k , when B has bounded dimension and \mathbb{F} is a finite field. This operation τ on *B-namus* contains the operation to compress an integer sequence introduced by Bodlaender and Kloks [1] for their work on tree-decompositions.

In the previous work [10], the authors found a similar algorithm for path-decompositions of a subspace arrangement. A path-decomposition of a subspace arrangement is a linearized variant

of a branch-decomposition that restricts the subcubic trees to caterpillar trees. They defined B -trajectories, analogous to B -namus of this paper. Here are the key technical differences.

First, we improve the running time of an algorithm computing transcripts. They also use transcripts for the algorithms, though this name was not introduced. But their algorithm to compute a transcript was slow and so inevitably they presented two approaches, one that is self-contained but only giving the running time $O(n^4)$ based on iterative compressions and the other giving the running time $O(n^3)$ but using an earlier result of Hliněný and Oum [8]. If we adapt our new method to the result of [10], we also get an $O(n^3)$ -time algorithm for path-decompositions of subspace arrangements based on iterative compressions.

Second, the concept of totally pure branch-decompositions was not needed in [10]. For our algorithms, we sometimes insert a whole subtree into a branch-decomposition and we had to make sure that our algorithm finds at least one branch-decomposition of width at most k if it exists. That was guaranteed by proving that the operations of fork and split to modify a branch-decomposition do not increase the width. For path-decompositions, there was no need to define such a concept.

This paper is organized as follows. Section 2 will explain several applications of Theorem 1.1 to various width parameters such as branch-width of matroids, graphs and hypergraphs, rank-width of graphs, and carving-width of graphs. Recall that by Proposition 1.2, at the heart of designing an efficient algorithm for BRANCH-WIDTH lies an algorithm for BRANCH-WIDTH COMPRESSION. In Section 3, we present an overview of the algorithm for BRANCH-WIDTH COMPRESSION along with key technical notions for this algorithm. Section 4 introduces the notion of totally pure branch-decompositions and proves that totally pure branch-decompositions of optimum width exist. Section 5 proves properties of B -namus for a subspace B of \mathbb{F}^r . Section 6 establishes the correctness of the algorithm in Section 3 using results from Sections 4 and 5. Section 7 describes our main algorithm for solving BRANCH-WIDTH. This section encompasses the preprocessing step, manipulating the data structure, computing transcripts, and analyzing the running time of the algorithm in Section 3 and culminates in the exposition of the algorithm for BRANCH-WIDTH based on iterative applications of the algorithm in Section 3 as a subroutine.

2 Applications

In this section, we will describe how our main theorem, Theorem 1.1, can be applied to various width parameters of graphs, hypergraphs, and matroids easily. To introduce various width parameters efficiently, we first define the branch-width of a connectivity function. First of all, for a finite set E , a *connectivity function* $f : 2^E \rightarrow \mathbb{Z}$ is a function such that

- (i) $f(X) = f(E - X)$ for all $X \subseteq E$,
- (ii) $f(X) + f(Y) \geq f(X \cap Y) + f(X \cup Y)$ for all $X, Y \subseteq E$,
- (iii) $f(\emptyset) = 0$.

The *branch-decomposition* of E is a pair (T, \mathcal{L}) of a subcubic tree without degree-2 nodes and a bijection \mathcal{L} from the set of all leaves of T to E . The *width* of (T, \mathcal{L}) is the maximum of $f(A_e)$ for all edges e of T and a partition (A_e, B_e) of E induced by leaves in distinct components of $T - e$ with \mathcal{L} . The *branch-width* of f is the minimum width of all possible branch-decompositions of E . (If T has no edges, then we define its width to be 0.)

For a set X of vectors, $\langle X \rangle$ denotes the span of X and we may write $\langle x \rangle$ instead of $\langle X \rangle$ if $X = \{x\}$ for convenience. For a set \mathcal{V} of subspaces, we denote $\langle \mathcal{V} \rangle = \sum_{V \in \mathcal{V}} V$.

2.1 Application to branch-width of matroids

A *matroid* M is a pair (E, \mathcal{I}) of a finite set E and a set \mathcal{I} of subsets of E such that

(I1) $\emptyset \in \mathcal{I}$,

(I2) if $X \in \mathcal{I}$ and $Y \subseteq X$, then $Y \in \mathcal{I}$,

(I3) if $X, Y \in \mathcal{I}$ and $|X| < |Y|$, then $Y - X$ has an element e such that $X \cup \{e\} \in \mathcal{I}$.

We call E a *ground set* and \mathcal{I} a set of *independent sets*. See the book of Oxley [16] for more terminology on matroids. For a subset X of E , the *rank* $r_M(X)$ is the maximum size of an independent subset of X and the *connectivity function* of a matroid M is defined by

$$\lambda_M(X) = r_M(X) + r_M(E - X) - r_M(E).$$

It is easy to verify that λ_M is a connectivity function on E .

A *branch-decomposition* of a matroid $M = (E, \mathcal{I})$ is a branch-decomposition of E . The *width* of a branch-decomposition (T, \mathcal{L}) of M is measured by λ_M . The *branch-width* of a matroid M is the branch-width of λ_M .

For a matrix A over a field \mathbb{F} , let $E(A)$ be the set of all column vectors of A and let $\mathcal{I}(A)$ be the set of all linearly independent subsets of $E(A)$. Then it is known that $M(A) = (E(A), \mathcal{I}(A))$ is a matroid, which is called a *vector matroid*. We say that a matroid M is \mathbb{F} -*representable* if $M = M(A)$ for some matrix A over a field \mathbb{F} , and such A is an \mathbb{F} -*representation* of M . Let us say that a matroid is \mathbb{F} -*represented* if it is given with its \mathbb{F} -representation.

A vector matroid $M = M(A)$ on the ground set $E = \{v_1, v_2, \dots, v_n\} \subseteq \mathbb{F}^r$ is associated with a subspace arrangement $\mathcal{V}_M = \{\langle v_1 \rangle, \langle v_2 \rangle, \dots, \langle v_n \rangle\}$. For a subset X of E , $r_M(X) = \dim \langle X \rangle$. Thus, for each subset X of E ,

$$\begin{aligned} \lambda_M(X) &= \dim \langle X \rangle + \dim \langle E - X \rangle - \dim \langle E \rangle \\ &= \dim(\langle X \rangle \cap \langle E - X \rangle). \end{aligned}$$

Therefore, the branch-width of M is equal to the branch-width of \mathcal{V}_M .

As a corollary of Theorem 1.1, we have the following.

Theorem 2.1. *Let k be an integer. Given an input n -element matroid represented by an $r \times n$ matrix over a finite field \mathbb{F} with $r \leq n$, we can find its branch-decomposition of width at most k or confirm that its branch-width is larger than k in time $f(k, |\mathbb{F}|)n^3$ for some function f .*

2.2 Application to rank-width of graphs

We review the definition of rank-width. For a graph $G = (V, E)$, let A_G be the adjacency matrix $(m_{ij})_{i,j \in V}$ over the binary field $GF(2)$ such that

$$m_{ij} = \begin{cases} 1 & \text{if } i \text{ is adjacent to } j \text{ in } G, \\ 0 & \text{otherwise.} \end{cases}$$

For an $|A| \times |B|$ matrix M and $X \subseteq A$ and $Y \subseteq B$, we denote $M[X, Y]$ a submatrix of M induced by rows in X and columns in Y . The *cut-rank function* ρ_G of a graph G is a function on subsets X of V such that

$$\rho_G(X) = \text{rank}(A_G[X, V - X]).$$

Oum and Seymour [15] showed that the cut-rank function of a graph is a connectivity function on its vertex set. A *rank-decomposition* of a graph is a branch-decomposition of V . The *rank-width* of G is the branch-width of ρ_G .

Let $\mathbb{F} = GF(2)$ be the binary field and let $\{e_1, e_2, \dots, e_n\}$ be the standard basis of \mathbb{F}^n . In other words, e_i is the 0-1 vector in \mathbb{F}^n such that the j th entry is 1 if and only if $j = i$.

For a graph G with a vertex set $V(G) = \{1, 2, \dots, n\}$ and $i \in V(G)$, let v_i be the sum of all vectors e_j for all j adjacent to i in G . In other words, v_i is the i th column vector of A_G . For all $i = 1, 2, \dots, n$, let V_i be the subspace of \mathbb{F}^n spanned by $\{v_i, e_i\}$. The following lemma in [10] gives the relation between the rank-width of a graph G and the branch-width of a subspace arrangement $\{V_1, V_2, \dots, V_n\}$.

Lemma 2.2 ([10, Lemma 8.1]). *Let G be a graph and V_i be a subspace defined as above for each $i \in V(G)$. Then for $X \subseteq V(G)$,*

$$\dim\left(\left(\sum_{i \in X} V_i\right) \cap \left(\sum_{j \in V(G) - X} V_j\right)\right) = 2\rho_G(X).$$

By Lemma 2.2, we can deduce the following.

Theorem 2.3. *Given an input n -vertex graph G , we can find a rank-decomposition of width at most k or confirm that the rank-width of G is larger than k in time $f(k)n^3$ for some function f .*

Proof assuming Theorem 1.1. For a given graph G with a vertex set $V(G) = \{1, 2, \dots, n\}$, we define a subspace V_i for each $i \in \{1, 2, \dots, n\}$ as above, which can be done in time $O(n^2)$. Let $\mathcal{V} = \{V_1, V_2, \dots, V_n\}$. By Lemma 2.2, the branch-width of \mathcal{V} is precisely twice the rank-width of G .

By applying Theorem 1.1, we can find a branch-decomposition (T, \mathcal{L}) of \mathcal{V} of width at most $2k$ or confirm that the branch-width of \mathcal{V} is larger than $2k$ in time $O(n \cdot (2n)^2 + (2k + 1) \cdot n \cdot 2n \cdot n + (2k)^3 \cdot n^3 + f(2, 2k) \cdot n^2) = g(k)n^3$ for some function g .

If we have a branch-decomposition (T, \mathcal{L}) of \mathcal{V} of width at most $2k$, then we can convert it to a rank-decomposition (T, \mathcal{L}') of G of width at most k by constructing \mathcal{L}' so that $\mathcal{L}(v) = V_i$ if and only if $\mathcal{L}'(v) = i$. This completes the proof. \square

We remark that our method here can be extended naturally for \mathbb{F} -rank-width, a concept introduced by Kanté and Rao [12]. According to the terminology of [12], we may state as follows.

Theorem 2.4. *Let \mathbb{F} be a finite field and $\mathbb{F}^* = \mathbb{F} \setminus \{0\}$. Let k be an integer. For an input n -vertex \mathbb{F}^* -graph, we can either find an \mathbb{F} -rank-decomposition of width at most k or confirm that its \mathbb{F} -rank-width is larger than k in time $f(|\mathbb{F}|, k)n^3$ for some function f .*

Clique-width of graphs Rank-width was introduced by Oum and Seymour [14] to augment the notion of clique-width, another width parameter defined by Courcelle and Olariu [3]. Clique-width is defined as the minimum k such that G can be expressed as a k -expression, which also describes a tree-like structure of graphs.

For a positive integer k , a k -expression is an algebraic expression that consists of the following operations on graphs whose vertices are labeled by integers in $\{1, 2, \dots, k\}$.

- \cdot_i : a graph with a single vertex labeled by $i \in \{1, 2, \dots, k\}$.
- $G_1 \oplus G_2$: the disjoint union of two vertex-labeled graphs G_1 and G_2 .
- $\eta_{i,j}(G)$ with $i \neq j$: adding an edge from each pair of a vertex of label i and a vertex of label j .
- $\rho_{i \rightarrow j}(G)$: relabeling all vertices of label i to label j .

The *clique-width* of a graph G is the minimum k such that there is a k -expression representing G after ignoring labels of the vertices [3]. Fellows, Rosamond, Rotics, and Szeider [5] showed that it is NP-hard to compute the clique-width.

Oum and Seymour [14] designed an algorithm that, in time $O(n^2)$, converts a rank-decomposition of width k of an input n -vertex graph into a $(2^{k+1} - 1)$ -expression and, conversely, converts a k -expression into a rank-decomposition of width at most k . Using this fact, we deduce the following corollary from Theorem 2.3.

Corollary 2.5. *For an input n -vertex graph G and a positive integer k , in time $f(k)n^3$ for some function f , we can find a $(2^{k+1} - 1)$ -expression of G or confirm that G has clique-width larger than k .*

2.3 Application to branch-width of graphs and hypergraphs

A *branch-decomposition* of a hypergraph $G = (V, E)$ is a branch-decomposition of E . For a subset X of E , we define $\beta_G(X)$ as the number of vertices incident with both an edge in X and an edge not in X . The *branch-width* of G is the branch-width of β_G .

Lemma 2.6. *Let G be a hypergraph on n vertices and m edges having no parallel edges. If the branch-width of G is at most k , then $m \leq 2^{2k}n$.*

Proof. We proceed by induction on n . We may assume that G has no isolated vertex. Let (T, \mathcal{L}) be a branch-decomposition of G of width at most k . For each edge e of T , we have a partition (A_e, B_e) of $E(G)$ induced by the partition of the leaves of $T - e$ and \mathcal{L} . Let M_e be the set of vertices of G incident with both an edge in A_e and an edge in B_e . Let L_e be the set of vertices of G incident with an edge in A_e but no edge in B_e . Let R_e be the set of vertices of G incident with an edge in B_e but no edge in A_e . As the width of (T, \mathcal{L}) is at most k , $|M_e| \leq k$ for all $e \in E(T)$.

Suppose that T has an edge e such that $1 \leq |L_e| \leq k$. Let $v \in L_e$. Then every edge incident with v is a subset of $L_e \cup M_e$. As G has no parallel edges, there are at most 2^{2k} such edges containing v because $|L_e \cup M_e| \leq 2k$. Let H be the subhypergraph of G obtained by deleting v and all edges incident with v . As the branch-width of H is at most k , by the induction hypothesis, $m - 2^{2k} \leq |E(H)| \leq 2^{2k}|V(H)| = 2^{2k}(n - 1)$. Thus we may assume that $L_e = \emptyset$ or

$|L_e| \geq k+1$ for each edge e of T . By symmetry, we may also assume that $R_e = \emptyset$ or $|R_e| \geq k+1$ for every edge e of T .

If $L_e = R_e = \emptyset$ for some edge e of T , then G has at most k vertices and therefore $m \leq 2^k \leq 2^{2k}n$. So we may assume that T has no such edge e .

Let e be an edge of T such that A_e is minimal if L_e is nonempty or B_e is minimal if R_e is nonempty among all sets A_f for which L_f is nonempty and all sets B_f for which R_f is nonempty. By symmetry, we may assume that L_e is nonempty and A_e is minimal. Let x be the end of e so that A_e is the set of all edges of G corresponding by \mathcal{L} to leaves in the component of $T - e$ containing x .

If x is a leaf of T , then for a vertex v in L_e , G has only one edge incident with v . Let H be the subhypergraph of G obtained by deleting v and its unique incident edge. Then H has branch-width at most k and so by the induction hypothesis, $m - 1 = |E(H)| \leq 2^{2k}|V(H)| = 2^{2k}(n - 1)$.

Thus, we may assume that x is not a leaf of T . Let f, g be two edges incident with x other than e . Let us assume that $A_f \cup A_g = A_e$ and $B_f \cap B_g = B_e$. As the width of f is at most k , there are at most k vertices of G incident with both an edge in A_f and an edge in A_g . Note that if a vertex v is in L_e , then either $v \in L_f \cup L_g$ or v is incident with both an edge in A_f and an edge in A_g . As $|L_e| \geq k+1$, either $L_f \neq \emptyset$ or $L_g \neq \emptyset$. By symmetry, we may assume that $L_f \neq \emptyset$. However, A_f is a proper subset of A_e , contradicting the minimality assumption. \square

Using Theorem 1.1, we deduce the following.

Theorem 2.7. *Let k be an integer. Given an input hypergraph G with n vertices, we can either find a branch-decomposition of G whose width is at most k or confirm that the branch-width of G is greater than k in time $f(k)n^3$ for some function f .*

Proof assuming Theorem 1.1. If G has parallel edges A, B with $|A| = |B| > k$, then we conclude that the branch-width of G is greater than k . If G contains parallel edges A, B with $|A| = |B| \leq k$, then we consider $G - B$, which is a hypergraph obtained from G by deleting the edge B . We may assume that G has at least three edges. If $G - B$ has branch-width greater than k , then the branch-width of G is also greater than k . If $G - B$ has a branch-decomposition (T, \mathcal{L}) of width at most k , then it is easy to construct a branch-decomposition of G from (T, \mathcal{L}) by introducing a node v with $\mathcal{L}(v) = B$, subdividing an edge incident with $\mathcal{L}^{-1}(A)$ in T , and joining v and the subdividing node. Thus, we may assume that G has no parallel edges.

Let m be the number of all edges in G . We may assume that $m \leq 2^{2k}n$ because otherwise we conclude that the branch-width of G is greater than k by Lemma 2.6.

Let $V = \{v_1, v_2, \dots, v_n\}$ be the vertex set of G and $E = \{E_1, E_2, \dots, E_m\}$ be the edge set of G . Let $\mathbb{F} = GF(2)$ be the binary field and let $\{e_1, e_2, \dots, e_n\}$ be the standard basis of \mathbb{F}^n . Let $\mathcal{V} = \{V_1, V_2, \dots, V_m\}$ be a subspace arrangement of subspaces of \mathbb{F}^n such that for every $i = 1, 2, \dots, m$, V_i is the span of all e_j such that v_j is incident with E_i and also incident with some $E_{i'}$ with $i' \neq i$. Note that \mathcal{V} can be constructed in time $O(m \cdot n \cdot m) = O(2^{4k}n^3)$. We may assume that $\dim V_i \leq k$ for every $i = 1, 2, \dots, m$ because otherwise $\dim \left(V_i \cap \left(\sum_{j \neq i} V_j \right) \right) = \dim V_i > k$ and then we can conclude that the branch-width of G is greater than k .

It is easy to see that for each subset X of E ,

$$\dim \left(\left(\sum_{E_i \in X} V_i \right) \cap \left(\sum_{E_i \in E-X} V_i \right) \right) = \beta_G(X)$$

because V_i is the span of some e_j 's that represent the vertices in E_i and such e_j 's are linearly independent. Thus, the branch-width of \mathcal{V} is equal to the branch-width of G . So we can run

the algorithm in Theorem 1.1. The time complexity is, for some functions g and f ,

$$O(n \cdot (k2^{2k}n)^2 + (k+1) \cdot n \cdot k2^{2k}n \cdot 2^{2k}n + k^3 \cdot (2^{2k}n)^3 + g(2,k)(2^{2k}n)^2) = f(k)n^3. \quad \square$$

2.4 Application to carving-width of graphs

For a graph $G = (V, E)$ and a subset X of V , we define $\gamma_G(X)$ as the number of edges incident with both a vertex in X and a vertex not in X . The *carving* of a graph G is the branch-decomposition of V . The *carving-width* of a graph G is the branch-width of γ_G .

We can deduce the following theorem from Theorem 1.1.

Theorem 2.8. *Let k be an integer. Given an input n -vertex graph G , we can either find a carving of G whose width is at most k or confirm that the carving-width of G is greater than k in time $f(k)n^3$ for some function f .*

Proof assuming Theorem 1.1. Let $V = \{v_1, v_2, \dots, v_n\}$ be the vertex set of G and $E = \{f_1, f_2, \dots, f_m\}$ be the edge set of G . We may assume that the degree of each vertex is at most k so that $m \leq kn/2$. Otherwise, the carving-width of G is greater than k . Let $\mathbb{F} = GF(2)$ be the binary field. Let $\mathcal{V} = \{V_1, V_2, \dots, V_n\}$ be a subspace arrangement of subspaces of \mathbb{F}^m such that for every $i = 1, 2, \dots, n$,

$$V_i = \langle \{e_j : f_j \text{ is incident with } v_i\} \rangle,$$

where $\{e_1, e_2, \dots, e_m\}$ is the standard basis of \mathbb{F}^m . Then it is easy to see that for each subset X of V ,

$$\dim\left(\left(\sum_{v_i \in X} V_i\right) \cap \left(\sum_{v_i \in V-X} V_i\right)\right) = \gamma_G(X)$$

because V_i represents the neighbors of v_i . Thus the carving-width of G is equal to the branch-width of \mathcal{V} and the carving of G of width at most k corresponds to the branch-decomposition of \mathcal{V} of width at most k . Then we obtain our algorithm from the algorithm of Theorem 1.1. \square

3 The key step of the algorithm

This section aims to provide the key step of the algorithm for BRANCH-WIDTH COMPRESSION. Our algorithm for computing a branch-decomposition of \mathcal{V} of width k deploys dynamic programming on a precomputed branch-decomposition (T^b, \mathcal{L}^b) of \mathcal{V} of width at most θ . For the dynamic programming, we will need to take advantage of this structure to design efficient algorithms.

Let (T^b, \mathcal{L}^b) be a branch-decomposition of a subspace arrangement \mathcal{V} . Though we define T^b to have no degree-2 nodes in the definition of a branch-decomposition, we will sometimes relax this definition by allowing T^b to have a special node, called the *root*, of degree 2 or 0. To be precise, a *rooted binary tree* is a rooted tree such that every nonroot node has degree 1 or 3 and the root has degree at most 2. We may assume that T^b is a rooted binary tree by picking an arbitrary edge e and subdividing e to create a degree-2 root node \mathfrak{r} , and a branch-decomposition (T^b, \mathcal{L}^b) with such tree T^b will be called a *rooted branch-decomposition*. We may orient each edge of T^b toward the root \mathfrak{r} and assume that T^b is a rooted binary directed tree.

Dynamic programming algorithms on a tree-decomposition by Bodlaender and Kloks [1] benefit from the small width by encoding solutions with respect to the bags. While the bags are explicit in a given tree-decomposition, a branch-decomposition of a subspace arrangement does not provide an easy-to-handle metric for encoding solutions to our problem. In order to

make it more useful, we will need some extra information. For a node v of T^b , let \mathcal{V}_v be the set of all elements of \mathcal{V} associated with v and its descendants by \mathcal{L} . The *boundary space* B_v at v is defined as $B_v = \langle \mathcal{V}_v \rangle \cap \langle \mathcal{V} - \mathcal{V}_v \rangle$. We shall encode partial branch-decompositions of \mathcal{V}_v with respect to the boundary spaces B_v of a given branch-decomposition (T^b, \mathcal{L}^b) . In order to describe it, we need to introduce B -namu and relevant terminology to manipulate B -namu, which will be given in Subsections 3.1–3.4.

Meanwhile, we need to know B_v for each node v of a given branch-decomposition (T^b, \mathcal{L}^b) in advance. Moreover, the information relating the boundary space at a node and at its parent node will be necessary, which is captured by the notion of a *transcript*, which will be introduced in Subsection 3.5. After Subsection 3.5, we are ready to present the key step of our algorithm for BRANCH-WIDTH COMPRESSION in Subsection 3.6. We postpone all proofs of properties to later sections and focus on presenting the algorithm.

3.1 Namu

For a tree T , an *incidence* is a pair (v, e) of a node v of T and an edge e incident with v . Let $\mathcal{I}(T)$ be the union of $\{(*, \emptyset), (0, \emptyset)\}$ and the set of all incidences of T . Let \mathbb{F} be a field, let r be a positive integer, and let B be a subspace of \mathbb{F}^r . Let $A(T)$ be the set of all leaves of a tree T and recall that for an incidence (u, e) of a tree T , $A_u(T - e)$ is the set of all leaves of T in the component of $T - e$ containing u .

What is the essence of a branch-decomposition (T, \mathcal{L}) of a subspace arrangement \mathcal{V} with respect to B ? From (T, \mathcal{L}) , we can define a function α from $\mathcal{I}(T)$ to the set of all subspaces of B , a function λ from the union of $\{\emptyset\}$ and the set of all edges of T to the set of integers, and a subspace U of B as follows:

- for each node v of T and an edge e incident with v ,

$$\alpha(v, e) = B \cap \sum_{x \in A_v(T - e)} \mathcal{L}(x),$$

- for each edge $e = uv$ of T ,

$$\lambda(e) = \dim \left(\sum_{x \in A_u(T - e)} \mathcal{L}(x) \cap \sum_{y \in A_v(T - e)} \mathcal{L}(y) \right),$$

- $U = B \cap \sum_{x \in A(T)} \mathcal{L}(x)$, and
- $\alpha(*, \emptyset) = U$, $\alpha(0, \emptyset) = \{0\}$, and $\lambda(\emptyset) = 0$.

Such a quadruple (T, α, λ, U) is called the *canonical B -namu* of a branch-decomposition (T, \mathcal{L}) of a subspace arrangement \mathcal{V} . This motivates us to define a B -namu. “Namu” is a tree in Korean.

A B -namu Γ is a quadruple (T, α, λ, U) of

- a tree T of maximum degree at most 3 having at least one node,
- a function α from $\mathcal{I}(T)$ to the set of all subspaces of B ,
- a function λ from the union of $\{\emptyset\}$ and the set of all edges of T to the set of integers, and

- a subspace U of B

such that

- (i) for every two-edge path v_0, e_1, v_1, e_2, v_2 in T , $\alpha(v_0, e_1)$ is a subspace of $\alpha(v_1, e_2)$,
- (ii) for all incidences (v, e) of T , $\alpha(v, e)$ is a subspace of U ,
- (iii) $\alpha(*, \emptyset) = U$, $\alpha(0, \emptyset) = \{0\}$, and $\lambda(\emptyset) = 0$,
- (iv) for every edge $e = uv$ of T , $\lambda(e) \geq \dim(\alpha(v, e) \cap \alpha(u, e))$.

Our idea of defining a function on incidences of a tree is from the definition of a tree-labeling in Robertson and Seymour [18]. While a tree-labeling maps an incidence to a subset of the ground set, the function α in the canonical B -namu (T, α, λ, U) maps an incidence to a subspace of U . Note that if (T, α, λ, U) is a canonical B -namu of a branch-decomposition (T, \mathcal{L}) of \mathcal{V} , then for every edge $e = uv$ of T , we have

$$\lambda(e) \geq \dim\left(B \cap \sum_{x \in A_u(T-e)} \mathcal{L}(x) \cap \sum_{y \in A_v(T-e)} \mathcal{L}(y)\right) = \dim(\alpha(v, e) \cap \alpha(u, e)),$$

which meets the condition (iv) of the definition of a B -namu.

The *width* of a B -namu $\Gamma = (T, \alpha, \lambda, U)$ is the maximum of $\lambda(e)$ over all edges $e = uv$ of T . (If T has no edges, then the width of Γ is defined to be 0.) For a B -namu $\Gamma = (T, \alpha, \lambda, U)$, we denote $T(\Gamma) = T$ and call it the *tree in* Γ .

Let $\Gamma_1 = (T_1, \alpha_1, \lambda_1, U_1)$, $\Gamma_2 = (T_2, \alpha_2, \lambda_2, U_2)$ be two B -namus. We say that two B -namus Γ_1, Γ_2 are *equal*, denoted as $\Gamma_1 = \Gamma_2$, if T_1 is equal to T_2 , $\alpha_1(v, e) = \alpha_2(v, e)$ for every incidence (v, e) in T_1 , $\lambda_1(e) = \lambda_2(e)$ for every edge e in T_1 , and $U_1 = U_2$.

Two B -namus $\Gamma_1 = (T_1, \alpha_1, \lambda_1, U_1)$ and $\Gamma_2 = (T_2, \alpha_2, \lambda_2, U_2)$ are *isomorphic* if $U_1 = U_2$ and there is an isomorphism ϕ from T_1 to T_2 such that $\alpha_1(v, e) = \alpha_2(\phi(v), \phi(e))$ and $\lambda_1(e) = \lambda_2(\phi(e))$ for every incidence (v, e) in T_1 . A B -namu $(T', \alpha', \lambda', U)$ is a *subdivision* of a B -namu $\Gamma = (T, \alpha, \lambda, U)$ if T' is a subdivision of T , $\alpha'(v', e') = \alpha(v, e)$, and $\lambda'(e') = \lambda(e)$ for every incidence (v', e') of T' and its corresponding incidence (v, e) of T .

For two B -namus $\Gamma_1 = (T_1, \alpha_1, \lambda_1, U_1)$ and $\Gamma_2 = (T_2, \alpha_2, \lambda_2, U_2)$, we say that $\Gamma_1 \leq \Gamma_2$ if

- $T_1 = T_2$, $\alpha_1 = \alpha_2$, $U_1 = U_2$ and
- $\lambda_1(e) \leq \lambda_2(e)$ for every edge e of T_1 .

For two B -namus Γ_1 and Γ_2 , we say that $\Gamma_1 \preceq \Gamma_2$ if there exist a B -namu Γ'_1 isomorphic to a subdivision of Γ_1 and a B -namu Γ'_2 isomorphic to a subdivision of Γ_2 such that $\Gamma'_1 \leq \Gamma'_2$.

For two subspaces B and B' with $B' \subseteq B$, we define a B' -namu obtained from a B -namu as follows. We define the *projection* $\Gamma|_{B'}$ of a B -namu $\Gamma = (T, \alpha, \lambda, U)$ on B' as the B' -namu $(T, \alpha', \lambda', U')$ such that

- $U' = U \cap B'$,
- $\alpha'(v, e) = \alpha(v, e) \cap B'$ for all incidences (v, e) of T , and
- $\lambda'(e) = \lambda(e)$ for all edges e of T .

Note that the width of $\Gamma|_{B'}$ is equal to the width of Γ .

3.2 Compact B -namus

In the previous subsection, we defined the data structure B -namu to store partial solutions at a node v of a given branch-decomposition (T^b, \mathcal{L}^b) . Naively, we can store all partial solutions that can be potentially extended to an optimal branch-decomposition of \mathcal{V} . However, if we use the canonical B -namu to represent a partial solution at a node v , then this representation can be arbitrarily large and there can be too many canonical B -namus to be stored. In order to bound the size and the number of partial solutions at each node v of T^b , we deploy two strategies; first we narrow down the search space of all branch-decompositions of \mathcal{V}_v to the “well-behaved” branch-decompositions, and second we compress B -namus of such well-behaved branch-decompositions to so-called compact B -namus. The former is captured by the notion of totally pure branch-decomposition with respect to (T^b, \mathcal{L}^b) , which will be explored in the next section. In this subsection, we focus on the latter notion.

For a B -namu, we define two operations. First, we introduce the notion of *compressing* a B -namu $\Gamma = (T, \alpha, \lambda, U)$. If there exists a two-edge path v_0, e_1, v_1, e_2, v_2 in T such that

- (i) the degree of v_1 is 2 in T ,
- (ii) $\alpha(v_0, e_1) = \alpha(v_1, e_2)$, $\alpha(v_1, e_1) = \alpha(v_2, e_2)$, and
- (iii) $\lambda(e_1) = \lambda(e_2)$,

then *compressing* Γ by the path v_0, e_1, v_1, e_2, v_2 is an operation to obtain a new B -namu $\Gamma' = (T', \alpha', \lambda', U)$ such that

- T' is a tree obtained from T by contracting e_1 ,
- $\alpha'(v, e) = \alpha(v, e)$ for each incidence (v, e) in T with $e \neq e_1$, and
- $\lambda'(e) = \lambda(e)$ for each edge $e \neq e_1$ of T .

If there exists a path $v_0, e_1, v_1, e_2, v_2, \dots, e_n, v_n$ in T with $n \geq 3$ such that

- (i) the degree of v_i is 2 for every $1 \leq i \leq n-1$,
- (ii) $\alpha(v_{i-1}, e_i) = \alpha(v_i, e_{i+1})$, $\alpha(v_i, e_i) = \alpha(v_{i+1}, e_{i+1})$ for every $1 \leq i \leq n-1$, and
- (iii) $\lambda(e_1) \leq \lambda(e_j) \leq \lambda(e_n)$ for every $2 \leq j \leq n-1$,

then *compressing* Γ by the path $v_0, e_1, v_1, e_2, v_2, \dots, e_n, v_n$ is an operation to obtain a new B -namu $\Gamma' = (T', \alpha', \lambda', U)$ such that

- T' is a tree obtained from T by contracting all edges e_2, \dots, e_{n-1} ,
- $\alpha'(v, e) = \alpha(v, e)$ for each incidence (v, e) in T with $e \notin \{e_2, \dots, e_{n-1}\}$,
- $\lambda'(e) = \lambda(e)$ for each edge e of T with $e \notin \{e_2, \dots, e_{n-1}\}$.

Second, we introduce the notion of *trimming* a B -namu $\Gamma = (T, \alpha, \lambda, U)$. In order to define trimming, we introduce a few terminology. Let $\Gamma = (T, \alpha, \lambda, U)$ be a B -namu. An edge uv of T is called *degenerate* in Γ if

$$\alpha(u, uv) = \alpha(v, uv).$$

We say an edge uv of T *guards* an end v in Γ if

$$\alpha(v, uv) \subsetneq \alpha(u, uv).$$

An edge of T is *guarding* in Γ if it guards one of its ends. A node w of T is *blocked* by an edge e in Γ if w is not an end of e and e guards its end closer to w in T . An edge f of T is *blocked* by an edge e if at least one of the ends of f is blocked by e in Γ . A path xyz of length 2 in T is called a *blocking path* in Γ if

$$\alpha(x, xy) = \alpha(y, yz) \text{ and } \alpha(z, zy) = \alpha(y, yx)$$

and neither xy nor yz is degenerate or guarding in Γ . A node v of T is *blocked* by a blocking path xyz in Γ if $v \neq y$ and $T - x - z$ has a path from v to y . An edge e of T is *blocked* by a blocking path xyz in Γ if some end of e is blocked by xyz . A node v or an edge e said to be *blocked* in Γ if it is blocked by some guarding edge or some blocking path in Γ . We omit “in Γ ” if it is clear from the context.

Trimming Γ is an operation to obtain a new B -namu $(T', \alpha', \lambda', U)$ by one of the following.

- (1) If T has degenerate edges, then T' is a tree with a single node u .
- (2) If T has no degenerate edges, then T' is a tree obtained by removing all blocked nodes, and
 - $\alpha'(v, e) = \alpha(v, e)$ for every incidence (v, e) of T' , and
 - $\lambda'(e) = \lambda(e)$ for every edge e of T' .

We define the *trim* of Γ , denoted by $\text{trim}(\Gamma)$, as the B -namu obtained by trimming Γ . We say that a B -namu Γ is *trimmed* if $\Gamma = \text{trim}(\Gamma)$. Note that $\text{trim}(\Gamma)$ has no blocked nodes.

We define the *compactification* of Γ , denoted by $\tau(\Gamma)$, as the B -namu obtained from $\text{trim}(\Gamma)$ by repeatedly applying compressing until no further compressing can be applied.

Proposition 3.1. *The compactification of a B -namu Γ is well defined.*

Proof. The order of compressing does not change the resulting B -namu $\tau(\Gamma)$. □

We say that a B -namu Γ is *compact* if $\Gamma = \tau(\Gamma)$. Let $U_k(B)$ be the set of all compact B -namus Γ of width at most k such that $V(T(\Gamma)) = \{1, 2, \dots, n\}$ for some integer n .

3.3 A sum of B -namus

At each internal node of T^b , we want to compute partial solutions using the partial solutions computed at its two children. In this subsection, we introduce the operation *sum* of B -namus to combine two partial solutions.

For two subcubic trees T and T^* , a *T -model in T^** is a subtree η of T^* isomorphic to a subdivision of T . For brevity we regard η as a function from $E(T^*) \cup \{\emptyset\}$ to $E(T) \cup \{\emptyset\}$ such that $\eta(\emptyset) = \emptyset$, $\eta(e) = \emptyset$ if e is not in $E(\eta)$, and $\eta(e) = f$ if e is on the path of η obtained by subdividing f . For a T -model η in T^* , we define $\bar{\eta}: V(T) \rightarrow V(T^*)$ so that $\bar{\eta}(v) = w$ if a node w in η is a branch node corresponding to v . See Figure 1 for an illustration.

A T -model η in T^* induces a function $\vec{\eta}: \mathcal{I}(T^*) \rightarrow \mathcal{I}(T)$ as follows.

- For an incidence (v, e) of T^* , if $\eta(e) \neq \emptyset$, then let \bar{v} be a branch node with the minimum distance to v in $T^* - e$ and let v' be the node of T such that $\bar{\eta}(v') = \bar{v}$. Then $\vec{\eta}(v, e) = (v', \eta(e))$.

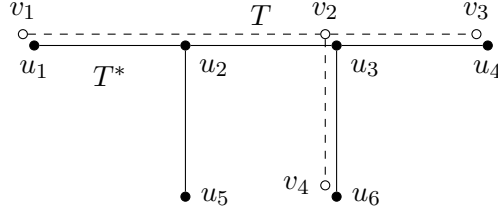

Figure 1: A function η is a T -model in T^* if $\eta(u_1u_2) = \eta(u_2u_3) = v_1v_2$, $\eta(u_3u_4) = v_2v_3$, $\eta(u_3u_6) = v_2v_4$, and $\eta(u_2u_5) = \eta(\emptyset) = \emptyset$. Nodes u_1, u_3, u_4, u_6 are branch nodes in η . Dashed lines represent T and solid lines represent T^* .

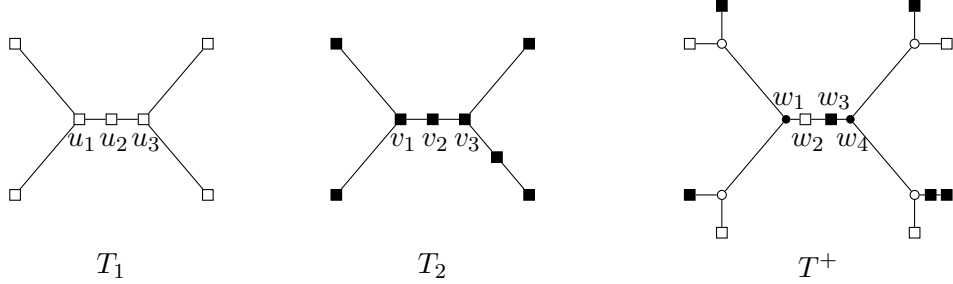

Figure 2: Trees T_1 , T_2 , and T^+ that give a (T_1, T_2) -model (η_1, η_2) in T^+ such that $\eta_1(w_1w_2) = u_1u_2$, $\eta_1(w_2w_3) = \eta_1(w_3w_4) = u_2u_3$, $\eta_2(w_1w_2) = \eta_2(w_2w_3) = v_1v_2$, $\eta_2(w_3w_4) = v_2v_3$. In T^+ , the nodes represented by \circ are the subdividing nodes described in (i).

- For an incidence (v, e) of T^* , if $\eta(e) = \emptyset$, then let C_v be the component $T^* - e$ containing v and

$$\vec{\eta}(v, e) = \begin{cases} (0, \emptyset) & \text{if } C_v \text{ has no node in } \bar{\eta}(V(T)), \\ (*, \emptyset) & \text{otherwise.} \end{cases}$$

- $\vec{\eta}(0, \emptyset) = (0, \emptyset)$ and $\vec{\eta}(*, \emptyset) = (*, \emptyset)$.

Let $\eta^{-1}(e) = \{e' : \eta(e') = e\}$ be the preimage of e . Then for an edge e of T , $\eta^{-1}(e)$ is a path in T^* . A B -namu $\Gamma^* = (T^*, \alpha^*, \lambda^*, U^*)$ is an *extension* of a B -namu $\Gamma = (T, \alpha, \lambda, U)$ if there exists a T -model η in T^* such that $U^* = U$, $\alpha^*(v, e) = \alpha(\vec{\eta}(v, e))$, $\lambda^*(e) = \lambda(\eta(e))$ for every incidence (v, e) of T^* with $\eta(e) \neq \emptyset$. In this case, we say that η *extends* Γ to Γ^* .

For three subcubic trees T_1 , T_2 , and T^+ , a (T_1, T_2) -model in T^+ is a pair (η_1, η_2) of a T_1 -model η_1 and a T_2 -model η_2 in T^+ satisfying the following:

- For each $i = 1, 2$, if two edges $e \in E(\eta_i)$ and $f \in E(T^+) \setminus E(\eta_i)$ share a node v of T^+ , then v is a subdividing node of η_i .
- $A(T^+)$ is the disjoint union of $\bar{\eta}_1(A(T_1))$ and $\bar{\eta}_2(A(T_2))$.
- If v has degree at most 2 in T^+ , then it is a branch node in exactly one of η_1 and η_2 .

Figure 2 illustrates the definition of a (T_1, T_2) -model in T^+ .

Lemma 5.5. Given two B -namus $\Gamma_1 = (T_1, \alpha_1, \lambda_1, U_1)$, $\Gamma_2 = (T_2, \alpha_2, \lambda_2, U_2)$, and a (T_1, T_2) -model (η_1, η_2) in a tree T^+ , we define α^+ , λ^+ , and U^+ as follows:

- (i) $U^+ = U_1 + U_2$,
- (ii) $\alpha^+ = \alpha_1 \circ \vec{\eta}_1 + \alpha_2 \circ \vec{\eta}_2$,
- (iii) $\lambda^+(\emptyset) = 0$, and
- (iv) for all $e = uv \in E(T)$,

$$\begin{aligned} \lambda^+(e) = & \lambda_1 \circ \eta_1(e) + \lambda_2 \circ \eta_2(e) - \dim(\alpha_1(\vec{\eta}_1(v, e)) \cap \alpha_2(\vec{\eta}_2(v, e))) \\ & - \dim(\alpha_1(\vec{\eta}_1(u, e)) \cap \alpha_2(\vec{\eta}_2(u, e))) + \dim(U_1 \cap U_2). \end{aligned}$$

Then $\Gamma^+ = (T^+, \alpha^+, \lambda^+, U^+)$ is a B -namu.

Such Γ^+ is called the *sum* of Γ_1 and Γ_2 by (η_1, η_2) , and we will denote by $\Gamma^+ = \Gamma_1 +_{(\eta_1, \eta_2)} \Gamma_2$. We say that (η_1, η_2) *co-extends* Γ_1 and Γ_2 to Γ^+ . A B -namu Γ^+ is simply called a *sum* of Γ_1 and Γ_2 if there exists a $(T(\Gamma_1), T(\Gamma_2))$ -model (η_1, η_2) in $T(\Gamma^+)$ such that $\Gamma^+ = \Gamma_1 +_{(\eta_1, \eta_2)} \Gamma_2$. Given B -namus Γ_1 and Γ_2 , let us denote by $\Gamma_1 \oplus \Gamma_2$ the set of all sums of Γ_1 and Γ_2 .

3.4 k -safe extensions of a B -namu

For a nonnegative integer k , a B -namu $\Gamma' = (T', \alpha', \lambda', U')$ is a k -safe extension of a B -namu $\Gamma = (T, \alpha, \lambda, U)$ if there exists a T -model η in T' such that

- $U' = U$, $\alpha'(v, e) = \alpha(\vec{\eta}(v, e))$, $\lambda'(e) = \lambda(\eta(e))$ for every incidence (v, e) of T' with $\eta(e) \neq \emptyset$ and
- $\lambda'(e) + \dim U' - \dim \alpha'(v, e) \leq k$ for every incidence (v, e) of T' with $\vec{\eta}(v, e) = (*, \emptyset)$.

3.5 Transcript

A *transcript* of (T, \mathcal{L}) is a pair $\Lambda = (\{\mathfrak{B}_v\}_{v \in V(T)}, \{\mathfrak{B}'_v\}_{v \in V(T)})$ of sets of ordered bases \mathfrak{B}_v and \mathfrak{B}'_v of subspaces $B_v = \langle \mathfrak{B}_v \rangle$ and $B'_v = \langle \mathfrak{B}'_v \rangle$ of \mathbb{F}^r , respectively, such that

- the first $|\mathfrak{B}_v|$ elements of \mathfrak{B}'_v are precisely \mathfrak{B}_v for each node v ,
- $\langle \mathfrak{B}_v \rangle = \langle \mathcal{V}_v \rangle \cap \langle \mathcal{V} - \mathcal{V}_v \rangle$ for each node v ,
- $\langle \mathfrak{B}'_v \rangle = \langle \mathfrak{B}_{w_1} \rangle + \langle \mathfrak{B}_{w_2} \rangle$ for each node v having two children w_1 and w_2 ,
- $\langle \mathfrak{B}'_v \rangle = \langle \mathfrak{B}_v \rangle$ for each leaf v .

If a node w of T is a parent of a node v of T , then there exists the unique $|\mathfrak{B}'_w| \times |\mathfrak{B}_v|$ matrix T_v over \mathbb{F} such that

$$T_v[x]_{\mathfrak{B}_v} = [x]_{\mathfrak{B}'_w}$$

for all $x \in \mathfrak{B}_v$. This matrix T_v is called the *transition matrix* of Λ at a node v . (For the root node τ , let T_τ be the null matrix.) The *order* of a transcript Λ is the maximum of $|\mathfrak{B}'_v|$ for all nodes v .

The next theorem states that a transcript of a given branch-decomposition can be efficiently computed, which is a prerequisite to preparing the input of the algorithm in the next subsection.

Algorithm 1 Constructing the full sets

```

1: procedure FULL-SET( $\mathcal{V}, k, (T^b, \mathcal{L}^b), \{T_v\}_{v \in V(T^b)}$ )
2:   repeat
3:     choose an unmarked node  $x$  of  $T^b$  farthest from the root
4:     if  $x$  is a leaf then
5:       let  $\Delta_x = (T, \alpha, \lambda, U)$  be the  $B_x$ -namu such that  $T$  is a tree having a single node
       and  $U = B_x$ 
6:       we represent  $U$  by the  $|\mathfrak{B}_x| \times |\mathfrak{B}_x|$  identity matrix
7:        $\mathcal{F}_x \leftarrow \{\Delta_x\}$  ▷ Initialization
8:     else if  $x$  is an internal node with two children  $x_1$  and  $x_2$  then
9:       convert representations of subspaces in  $\mathcal{F}_{x_1}$  and  $\mathcal{F}_{x_2}$  to representations with re-
       spect to  $\mathfrak{B}'_x$  by using  $T_{x_1}$  and  $T_{x_2}$ 
10:       $\mathcal{F}_x^+ \leftarrow \mathcal{F}_{x_1} \oplus \mathcal{F}_{x_2}$  ▷ Join
11:       $\mathcal{F}_x^S \leftarrow \mathcal{F}_x^+|_{B_x}$  ▷ Shrink
12:       $\mathcal{F}_x^T \leftarrow \{\text{trim}(\Gamma) : \Gamma \in \mathcal{F}_x^S \text{ and } \Gamma \text{ is a } k\text{-safe extension of } \text{trim}(\Gamma)\}$  ▷ Trim
13:       $\mathcal{F}_x \leftarrow \{\Delta \in U_k(B_x) : \Gamma' \preceq \Delta \text{ for some } \Gamma' \in \mathcal{F}_x^T\}$  ▷ Compare
14:     end if
15:     mark  $x$ 
16:   until all nodes in  $T$  are marked
17: end procedure

```

Theorem 7.8. Let \mathcal{V} be a subspace arrangement of \mathbb{F}^r represented by an $r \times m$ matrix M in reduced row echelon form with no zero rows such that each $V \in \mathcal{V}$ has dimension at most θ . Let $n = |\mathcal{V}|$. Given a rooted branch-decomposition (T, \mathcal{L}) of \mathcal{V} , in time $O(\theta^3 n^2)$, Algorithm 2 correctly computes a basis of $\langle \mathcal{V}_v \rangle \cap \langle \mathcal{V} - \mathcal{V}_v \rangle$ for all nodes v of T or confirms that (T, \mathcal{L}) has width larger than θ . In addition, if (T, \mathcal{L}) has width at most θ , then we can compute the transcript $\Lambda = (\{\mathfrak{B}_v\}, \{\mathfrak{B}'_v\})$ of (T, \mathcal{L}) with its transition matrices in time $O(\theta^3 n^2)$.

3.6 The main algorithm

We present the key step of the algorithm for BRANCH-WIDTH COMPRESSION assuming the following are given:

- a rooted branch-decomposition (T^b, \mathcal{L}^b) of \mathcal{V} of width at most θ ,
- a set of transition matrices $\{T_v\}_{v \in V(T^b)}$ of some transcript Λ of (T^b, \mathcal{L}^b) .

The algorithm does not need to look at Λ . We note that the above input can be represented in $O(\theta^2 \cdot |V(T^b)| \cdot \log|\mathbb{F}|)$ space.

For a leaf ℓ of T^b and a subspace $V = \mathcal{L}^b(\ell)$, a branch-decomposition (T, \mathcal{L}) of \mathcal{V}_ℓ is unique up to isomorphism of T . Let $\Delta_\ell = (T, \alpha, \lambda, U)$ be the canonical B_ℓ -namu of (T, \mathcal{L}) of $\mathcal{V}_\ell = \{V\}$. Since T has no edge, it is clear that $\alpha(*, \emptyset) = U$, $\alpha(0, \emptyset) = \{0\}$, $\lambda(\emptyset) = 0$, and $U = B_\ell$. Let $\mathcal{F}_\ell = \{\Delta_\ell\}$.

Let x be a node of T^b with two children x_1, x_2 such that \mathcal{F}_{x_1} and \mathcal{F}_{x_2} are already computed. We will describe how to compute \mathcal{F}_x . For two sets \mathcal{R}_1 and \mathcal{R}_2 of B -namus, we define $\mathcal{R}_1 \oplus \mathcal{R}_2$ as the set

$$\bigcup_{\Gamma_1 \in \mathcal{R}_1, \Gamma_2 \in \mathcal{R}_2} \Gamma_1 \oplus \Gamma_2.$$

Note that for two children x_1 and x_2 of a node x in T^b , when we compute $\mathcal{F}_{x_1} \oplus \mathcal{F}_{x_2}$ from a set \mathcal{F}_{x_1} of B_{x_1} -namus and a set \mathcal{F}_{x_2} of B_{x_2} -namus, we regard \mathcal{F}_{x_1} and \mathcal{F}_{x_2} as the sets of $(B_{x_1} + B_{x_2})$ -namus. Thus, $\mathcal{F}_{x_1} \oplus \mathcal{F}_{x_2}$ is well defined.

If B' is a subspace of B , then we define $\mathcal{R}|_{B'}$ as the set of projections $\Gamma|_{B'}$ for all $\Gamma \in \mathcal{R}$. Let \mathcal{F}_x^T be the set of all B_x -namus $\Gamma' = \text{trim}(\Gamma)$ for all $\Gamma \in (\mathcal{F}_{x_1} \oplus \mathcal{F}_{x_2})|_{B_x}$ such that Γ is a k -safe extension of Γ' . Let

$$\mathcal{F}_x = \{\Delta \in U_k(B_x) : \Gamma' \preceq \Delta \text{ for some } \Gamma' \in \mathcal{F}_x^T\}.$$

We summarize the procedure to compute \mathcal{F}_x for all nodes x of T^b in Algorithm 1. The following proposition implies that Algorithm 1 correctly decides whether there exists a branch-decomposition of an input subspace arrangement \mathcal{V} having width at most k .

Proposition 6.1. Let k be a nonnegative integer. Let (T^b, L^b) be a rooted branch-decomposition of a subspace arrangement \mathcal{V} , and for each node x of T^b , let \mathcal{F}_x be the set computed by Algorithm 1. The branch-width of \mathcal{V} is at most k if and only if $\mathcal{F}_r \neq \emptyset$ at the root node r of T^b .

Though Proposition 6.1 holds without any assumptions on the input size, to achieve the running time claimed in Theorem 1.1, we will preprocess the input to make sure that all the subspaces given in the input have small dimension. This will be discussed in Subsection 7.2.

4 Pure branch-decompositions

Let us start this section with a few terminology on branch-decompositions. We are going to assume that a subspace arrangement \mathcal{V} and its rooted branch-decomposition (T^b, \mathcal{L}^b) are given. Generally (T^b, \mathcal{L}^b) would have width larger than k , as our goal is to find a branch-decomposition of width at most k .

For two nodes x, y of T^b , we say that $x \leq y$ if either $x = y$ or x is a descendant of y . Clearly \leq is a partial order on $V(T^b)$. We write $x < y$ if $x \leq y$ and $x \neq y$. For a node x of T^b , let \mathcal{V}_x be the set of all subspaces $\mathcal{L}^b(\ell)$ where ℓ is a leaf of T^b with $\ell \leq x$ and let $B_x = \langle \mathcal{V}_x \rangle \cap \langle \mathcal{V} - \mathcal{V}_x \rangle$.

Let (T, \mathcal{L}) be a branch-decomposition of $\mathcal{V}_0 \subseteq \mathcal{V}$. For an edge uv of a tree T and a node w of T , we say that the ordered pair (u, v) *points toward* w if the unique path of T from u to w visits v . Note that this implies $w \neq u$. We define $\mathcal{L}(T, u, v)$ to be the set of all $\mathcal{L}(w)$ for each leaf w of T such that (u, v) points toward w . In addition, if $\mathcal{V}_x \subseteq \mathcal{V}_0$ for a node x of T^b , then we write $\mathcal{L}_x(T, u, v) = \mathcal{L}(T, u, v) \cap \mathcal{V}_x$ and $\lambda_x^{(T, \mathcal{L})}(uv) = \dim \langle \mathcal{L}_x(T, u, v) \rangle \cap \langle \mathcal{L}_x(T, v, u) \rangle$.

For an edge uv of T and a node x of T^b with $\mathcal{V}_x \subseteq \mathcal{V}_0$, we say that the ordered pair (u, v) is *x -mixed* if $\mathcal{L}(T, u, v) \cap \mathcal{V}_x \neq \emptyset$ and $\mathcal{L}(T, u, v) \cap (\mathcal{V}_0 - \mathcal{V}_x) \neq \emptyset$. For $\mathcal{S} \subseteq \mathcal{V}_0$, an edge uv of T is said to *cut* \mathcal{S} if $\mathcal{L}(T, u, v) \cap \mathcal{S} \neq \emptyset$ and $\mathcal{L}(T, v, u) \cap \mathcal{S} \neq \emptyset$. Note that uv does *not* cut \mathcal{S} if and only if $\mathcal{S} \subseteq \mathcal{L}(T, u, v)$ or $\mathcal{S} \subseteq \mathcal{L}(T, v, u)$. We say that uv is *x -crossing* if both (u, v) and (v, u) are x -mixed, or equivalently uv cuts both \mathcal{V}_x and $\mathcal{V}_0 - \mathcal{V}_x$.

For a node x of T^b with $\mathcal{V}_x \subseteq \mathcal{V}_0$, we say that an edge uv of T is *x -degenerate* if

$$\langle \mathcal{L}_x(T, u, v) \rangle \cap B_x = \langle \mathcal{L}_x(T, v, u) \rangle \cap B_x.$$

We define the concept of x -degenerate branch-decompositions recursively as follows. We say that (T, \mathcal{L}) is *x -degenerate* if T has an x -degenerate edge uv such that

- uv cuts \mathcal{V}_x and

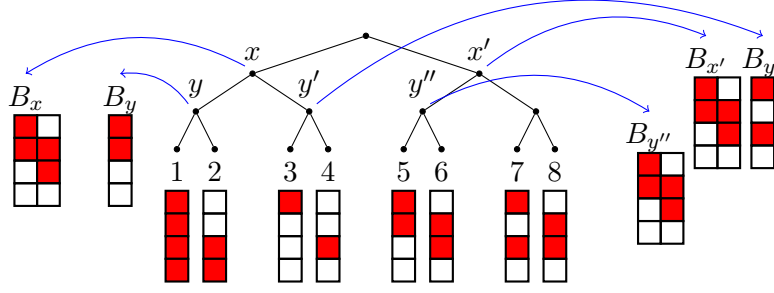

Figure 3: An example of a rooted branch-decomposition (T^b, \mathcal{L}^b) of $\mathcal{V} = \{V_1, V_2, \dots, V_8\}$ and the boundary spaces $B_x, B_y, B_{y'}$. Each grid represents the column space of the 0-1 matrix over the binary field in which the red box corresponds to 1 and the white box corresponds to 0.

- for all $y < x$, if (T, \mathcal{L}) is y -degenerate, then uv does not cut \mathcal{V}_y .

For an x -degenerate branch-decomposition, such an edge uv is said to be *improper* x -degenerate. An x -degenerate edge is *proper* if it is not improper. Note that if x is a leaf of T^b , then (T, \mathcal{L}) is not x -degenerate, because T has no edge cutting \mathcal{V}_x . We say that (T, \mathcal{L}) is *x -disjoint* if $\mathcal{V}_0 = \mathcal{V}_x$ or T has an edge uv such that $\mathcal{L}(T, u, v) = \mathcal{V}_x$ and v is incident with an improper x -degenerate edge.

We say that an edge uv of T *x -guards its end* v if

$$\langle \mathcal{L}_x(T, u, v) \rangle \cap B_x \subsetneq \langle \mathcal{L}_x(T, v, u) \rangle \cap B_x.$$

We say an edge is *x -guarding* if it x -guards one of its ends. Note that $\mathcal{L}_x(T, v, u) \neq \emptyset$. An edge uv that x -guards v is called *improper* x -guarding if v has two neighbors v_1, v_2 in $T - uv$ such that both $\mathcal{L}_x(T, v, v_1)$ and $\mathcal{L}_x(T, v, v_2)$ are nonempty and (u, v) is x -mixed. An x -guarding edge is *proper* if it is not improper. A node w of T is *x -blocked* by an x -guarding edge e if (1) e x -guards an end v having two neighbors v_1, v_2 in $T - e$ such that both $\mathcal{L}_x(T, v, v_1)$ and $\mathcal{L}_x(T, v, v_2)$ are nonempty, (2) $w \neq v$, and (3) the component of $T - e$ containing w contains v . An edge f of T is *x -blocked* by an x -guarding edge e if at least one end of f is x -blocked by e .

A 2-edge path uvw of T is an *x -blocking path* if

$$\begin{aligned} \langle \mathcal{L}_x(T, u, v) \rangle \cap B_x &= \langle \mathcal{L}_x(T, v, w) \rangle \cap B_x, \\ \langle \mathcal{L}_x(T, w, v) \rangle \cap B_x &= \langle \mathcal{L}_x(T, v, u) \rangle \cap B_x, \end{aligned}$$

and neither uv nor vw is x -degenerate or x -guarding. We say that v is the *center* of the path uvw . An x -blocking path uvw is *improper* if v has a neighbor t in $T - u - w$ such that (v, t) is x -mixed and $\mathcal{L}_x(T, v, u), \mathcal{L}_x(T, v, w), \mathcal{L}_x(T, v, t)$ are nonempty. An x -blocking path is *proper* if it is not improper. A node z of T is called *x -blocked* by an x -blocking path uvw if $z \neq v$ and the path from v to z has neither u nor w . An edge f of T is *x -blocked* by an x -blocking path uvw if at least one end of f is x -blocked by uvw . A node or an edge of T is said to be *x -blocked* if it is x -blocked by an x -blocking path or an x -guarding edge.

We observe that if uvw is an x -blocking path in T and t is the neighbor of v other than u

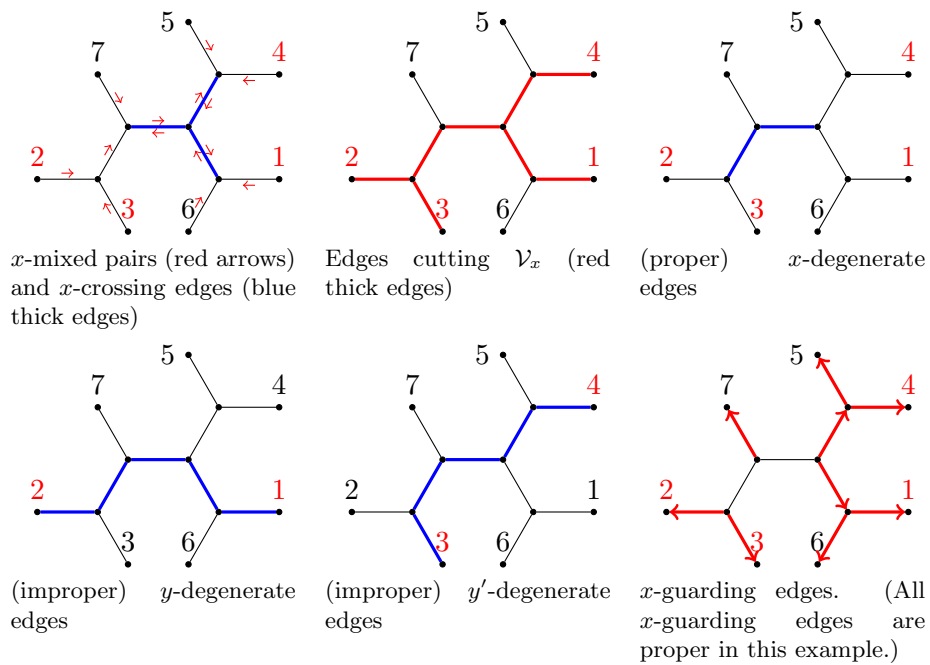

Figure 4: The first example of x -mixed pairs, x -crossing edges, edges cutting $\mathcal{V}_x = \{V_1, V_2, V_3, V_4\}$, and x -guarding edges when $\mathcal{V}_0 = \{V_1, V_2, \dots, V_7\}$ from Figure 3. All y -degenerate edges are improper y -degenerate and all y' -degenerate edges are improper y' -degenerate. But all x -degenerate edges are proper x -degenerate. In this example, (T, \mathcal{L}) is y -degenerate and y' -degenerate, but not x -degenerate. No node of T is x -blocked by an x -guarding edge. There is no x -blocking path.

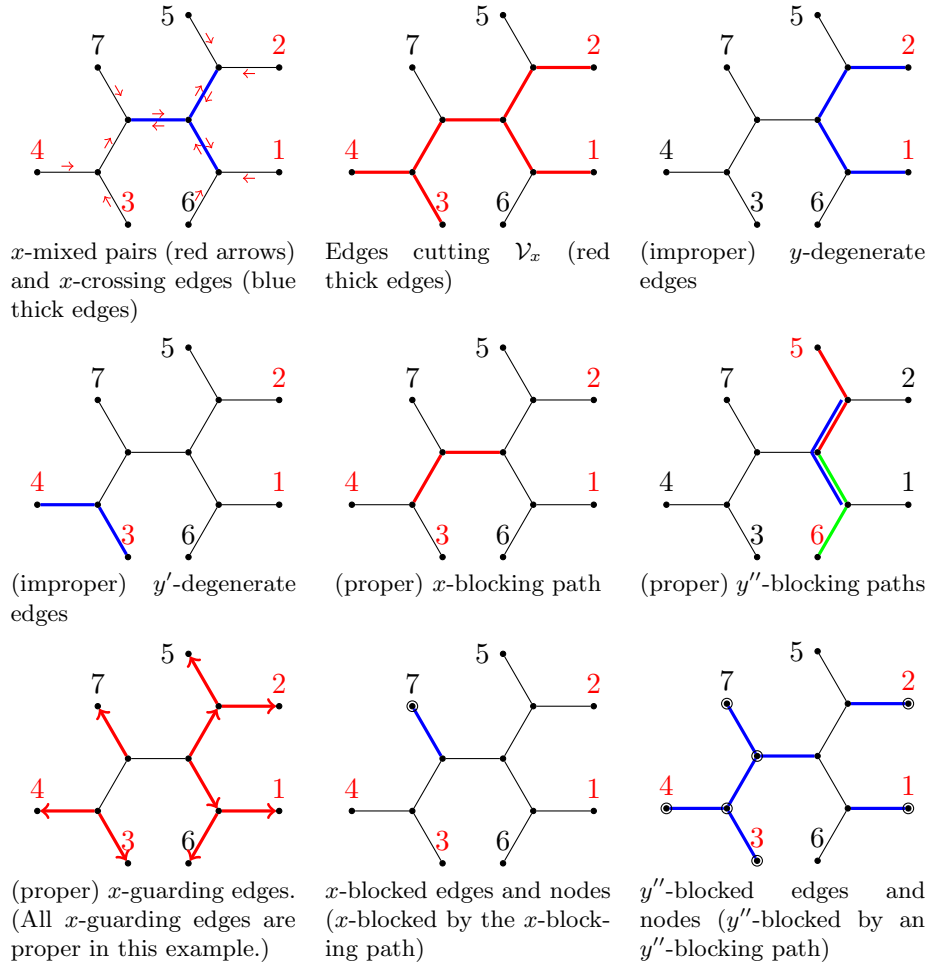

Figure 5: The second example of various terms on a branch-decomposition (T, \mathcal{L}) where $\mathcal{V}_x = \{V_1, V_2, V_3, V_4\}$ and $\mathcal{V}_0 = \{V_1, V_2, \dots, V_7\}$ from Figure 3. No edge is x -degenerate. In this example, (T, \mathcal{L}) is y -degenerate and y' -degenerate, but not x -degenerate. All y -degenerate edges are improper y -degenerate and all y' -degenerate edges are improper y' -degenerate. Every x -guarding edge is proper. Also (T, \mathcal{L}) is y' -disjoint but not y -disjoint. By definition, (T, \mathcal{L}) is x -pure and y' -pure, but not y -pure, and therefore it is not totally pure with respect to (T^b, \mathcal{L}^b) .

and w , then vt x -guards t as

$$\begin{aligned}
\langle \mathcal{L}_x(T, v, t) \rangle \cap B_x &= \langle \mathcal{L}_x(T, u, v) \cap \mathcal{L}_x(T, w, v) \rangle \cap B_x \\
&\subseteq \langle \mathcal{L}_x(T, u, v) \rangle \cap \langle \mathcal{L}_x(T, w, v) \rangle \cap B_x \\
&= \langle \mathcal{L}_x(T, v, u) \rangle \cap \langle \mathcal{L}_x(T, v, w) \rangle \cap B_x \\
&\subseteq \langle \mathcal{L}_x(T, v, u) \rangle \cap B_x + \langle \mathcal{L}_x(T, v, w) \rangle \cap B_x \\
&\subseteq \langle \mathcal{L}_x(T, v, u) \cup \mathcal{L}_x(T, v, w) \rangle \cap B_x = \langle \mathcal{L}_x(T, t, v) \rangle \cap B_x
\end{aligned}$$

and equality holds if and only if $\langle \mathcal{L}_x(T, v, u) \rangle \cap B_x \subseteq \langle \mathcal{L}_x(T, v, w) \rangle \cap B_x$ or $\langle \mathcal{L}_x(T, v, w) \rangle \cap B_x \subseteq \langle \mathcal{L}_x(T, v, u) \rangle \cap B_x$, which is impossible since neither uv nor vw is x -degenerate or x -guarding. We remark that if v is a node of T having three neighbors v_1, v_2, v_3 , then at most one of $v_1vv_2, v_2vv_3, v_3vv_1$ is an x -blocking path. Otherwise, say v_1vv_2 and v_2vv_3 are x -blocking. Then $\langle \mathcal{L}_x(T, v_2, v) \rangle \cap B_x = \langle \mathcal{L}_x(T, v, v_3) \rangle \cap B_x \subseteq \langle \mathcal{L}_x(T, v_1, v) \rangle \cap B_x = \langle \mathcal{L}_x(T, v, v_2) \rangle \cap B_x$, which implies that an edge vv_2 is x -degenerate or x -guards v .

We say that (T, \mathcal{L}) is x -pure if the following hold.

- If (T, \mathcal{L}) is not x -degenerate, then all x -blocking paths and all x -guarding edges of T are proper.
- If (T, \mathcal{L}) is x -degenerate, then (T, \mathcal{L}) is x -disjoint.

We will see later that if (T, \mathcal{L}) is x -degenerate, then every edge of T is either x -degenerate or x -guarding.

We say that a branch-decomposition (T, \mathcal{L}) of \mathcal{V}_0 is *totally pure with respect to (T^b, \mathcal{L}^b)* if (T, \mathcal{L}) is x -pure for all nodes x of T^b with $\mathcal{V}_x \subseteq \mathcal{V}_0$. We omit “with respect to (T^b, \mathcal{L}^b) ” if it is clear from the context. See Figures 4 and 5 for examples. Our goal is to prove that if the branch-width of a subspace arrangement is at most k , then there exists a totally pure branch-decomposition of the subspace arrangement whose width is at most k .

Here are useful operations that would transform a branch-decomposition of width k into an x -pure branch-decomposition of width at most k .

4.1 Fork

Suppose that (T, \mathcal{L}) is a branch-decomposition of \mathcal{V}_0 , x is a node of T^b with $\mathcal{V}_x \subseteq \mathcal{V}_0$, and v is a node of T having three neighbors v_1, v_2, v_3 such that v_1vv_2 is an improper x -blocking path, and $\lambda_x^{(T, \mathcal{L})}(vv_1) \geq \lambda_x^{(T, \mathcal{L})}(vv_2)$.

Now we describe the operation called *forking*. First let T^{vv_3} be the component of $T - vv_3$ containing v_3 , regarded as a rooted binary tree with the root v_3 . *Smoothing* a degree-2 node w is to contract one of the edges incident with w . Let $T_x^{vv_3}$ be the minimal subtree of T^{vv_3} that contains every leaf of T^{vv_3} mapped to a subspace in \mathcal{V}_x by \mathcal{L} . Let the root of $T_x^{vv_3}$ be the node of $T_x^{vv_3}$ closest to v_3 in T^{vv_3} . Let $T^{v, x}$ be the rooted binary tree obtained from $T_x^{vv_3}$ by smoothing degree-2 nonroot nodes if necessary. Let $T_{\bar{x}}^{vv_3}$ be the minimal subtree of T^{vv_3} that contains every leaf of T^{vv_3} mapped to a subspace in $\mathcal{V}_0 - \mathcal{V}_x$ by \mathcal{L} . Let the root of $T_{\bar{x}}^{vv_3}$ be the node of $T_{\bar{x}}^{vv_3}$ closest to v_3 in T^{vv_3} such that every subspace in $\mathcal{V}_0 - \mathcal{V}_x$ corresponds to a leaf of $T_{\bar{x}}^{vv_3}$ and the root of $T_{\bar{x}}^{vv_3}$ is the closest node to v_3 in T^{vv_3} . Let $T^{v, \bar{x}}$ be the rooted binary tree obtained from $T_{\bar{x}}^{vv_3}$ by smoothing degree-2 nonroot nodes if necessary.

Then, *forking at v by \mathcal{V}_x* is an operation to obtain a new branch-decomposition (T', \mathcal{L}) from (T, \mathcal{L}) by deleting all nodes x -blocked by v_1vv_2 , subdividing the edge vv_2 to create a degree-2

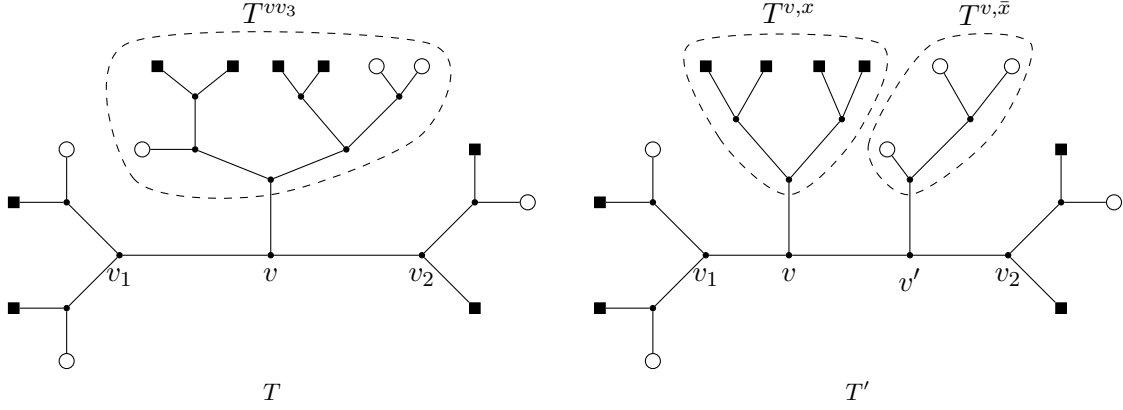

Figure 6: Constructing T' by forking at v by \mathcal{V}_x . ■ represents a leaf node mapped to an element of \mathcal{V}_x by \mathcal{L} and ○ represents a leaf node mapped to an element of $\mathcal{V}_0 - \mathcal{V}_x$ by \mathcal{L} .

node v' , making the disjoint union with $T^{v,x}$ and $T^{v,\bar{x}}$, and adding edges joining v with the root of $T^{v,x}$ and v' with the root of $T^{v,\bar{x}}$. See Figure 6.

Proposition 4.1. *If a branch-decomposition (T', \mathcal{L}) is obtained from a branch-decomposition (T, \mathcal{L}) by forking at v by \mathcal{V}_x , then the width of (T', \mathcal{L}) is at most the width of (T, \mathcal{L}) .*

For this proposition, we present the following lemmas.

Lemma 4.2. *Let $L_1, L_2, R_1, R_2, X_1, X_2, Y_1, Y_2$ be subspaces of \mathbb{F}^r and $S_1 = L_1 + R_1 + Y_1$ and $S_2 = L_2 + R_2 + Y_2$. If $(X_1 + Y_1) \cap (S_2 + X_2) \subseteq (L_1 + R_1) \cap (S_2 + X_2)$, then*

$$\begin{aligned} \dim(X_1 \cap (S_1 + S_2 + X_2)) &\leq \dim((X_1 + X_2) \cap (S_1 + S_2)), \\ \dim(X_2 \cap (S_1 + S_2 + X_1)) &\leq \dim((X_1 + X_2) \cap (S_1 + S_2)). \end{aligned}$$

Proof. For the first inequality, $\dim(X_1 \cap (S_1 + S_2 + X_2)) - \dim((X_1 + X_2) \cap (S_1 + S_2)) = \dim X_1 + \dim(S_1 + S_2) + \dim X_2 - \dim(S_1 + S_2) \cap X_2 - \dim(X_1 + X_2) - \dim(S_1 + S_2) = \dim(X_1 \cap X_2) - \dim((S_1 + S_2) \cap X_2) \leq 0$ because $X_1 \cap X_2 \subseteq (X_1 + Y_1) \cap (S_2 + X_2) \cap X_2 \subseteq (L_1 + R_1) \cap (S_2 + X_2) \cap X_2 \subseteq S_1 \cap X_2 \subseteq (S_1 + S_2) \cap X_2$.

For the second inequality, $\dim(X_2 \cap (S_1 + S_2 + X_1)) - \dim((X_1 + X_2) \cap (S_1 + S_2)) = \dim(X_2 \cap X_1) - \dim((S_1 + S_2) \cap X_1) \leq 0$ because $X_1 \cap X_2 \subseteq X_1 \cap (X_1 + Y_1) \cap (S_2 + X_2) \subseteq X_1 \cap (L_1 + R_1) \cap (S_2 + X_2) \subseteq X_1 \cap (L_1 + R_1) \subseteq X_1 \cap (S_1 + S_2)$. \square

Lemma 4.3 ([10, Lemma 3.18]). *For finite-dimensional subspaces X_1, X_2, Y_1, Y_2 ,*

$$\begin{aligned} &\dim((X_1 + X_2) \cap (Y_1 + Y_2)) \\ &= \dim(X_1 \cap Y_1) + \dim(X_2 \cap Y_2) - \dim(X_1 \cap X_2) - \dim(Y_1 \cap Y_2) \\ &\quad + \dim((X_1 + Y_1) \cap (X_2 + Y_2)). \end{aligned}$$

Lemma 4.4. *Let $L_1, L_2, R_1, R_2, Z_1, Z_2$ be subspaces of \mathbb{F}^r such that*

$$\begin{aligned} L_1 \cap (L_2 + R_2 + Z_2) &= (L_1 + Z_1) \cap (L_2 + R_2 + Z_2), \\ R_1 \cap (L_2 + R_2 + Z_2) &= (R_1 + Z_1) \cap (L_2 + R_2 + Z_2), \\ \dim(L_1 \cap (Z_1 + R_1)) &\geq \dim((L_1 + Z_1) \cap R_1). \end{aligned}$$

Then $\dim((L_1 + L_2) \cap (R_1 + R_2 + Z_1 + Z_2)) \geq \dim((L_1 + L_2 + Z_1) \cap (R_1 + R_2 + Z_2))$.

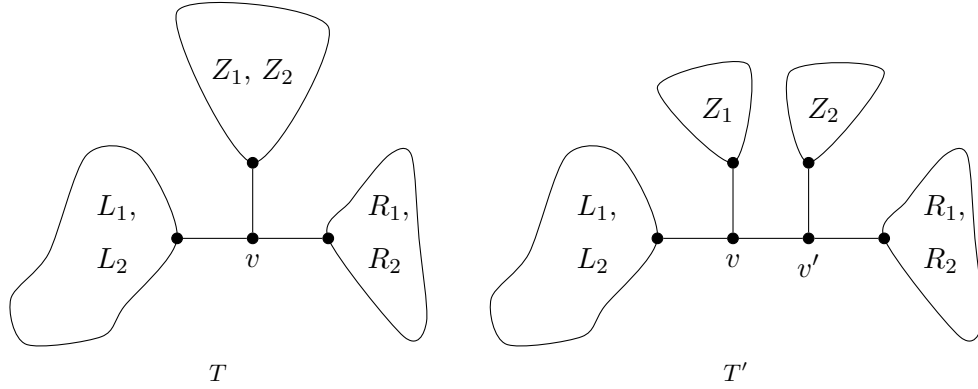

Figure 7: The subspaces from T and T' .

Proof. By the hypothesis, we have $(L_1 + Z_1) \cap L_2 = (L_1 + Z_1) \cap (L_2 + R_2 + Z_2) \cap L_2 = L_1 \cap (L_2 + R_2 + Z_2) \cap L_2 = L_1 \cap L_2$ and similarly $R_1 \cap (R_2 + Z_2) = R_1 \cap (L_2 + R_2 + Z_2) \cap (R_2 + Z_2) = (R_1 + Z_1) \cap (L_2 + R_2 + Z_2) \cap (R_2 + Z_2) = (R_1 + Z_1) \cap (R_2 + Z_2)$. By Lemma 4.3, we have

$$\begin{aligned}
& \dim((L_1 + Z_1 + L_2) \cap (R_1 + R_2 + Z_2)) \\
&= \dim((L_1 + Z_1) \cap R_1) + \dim(L_2 \cap (R_2 + Z_2)) \\
&\quad - \dim((L_1 + Z_1) \cap L_2) - \dim(R_1 \cap (R_2 + Z_2)) \\
&\quad + \dim((L_1 + Z_1 + R_1) \cap (L_2 + R_2 + Z_2)) \\
&= \dim((L_1 + Z_1) \cap R_1) + \dim(L_2 \cap (R_2 + Z_2)) \\
&\quad - \dim(L_1 \cap L_2) - \dim((R_1 + Z_1) \cap (R_2 + Z_2)) \\
&\quad + \dim((L_1 + Z_1 + R_1) \cap (L_2 + R_2 + Z_2)) \\
&\leq \dim(L_1 \cap (Z_1 + R_1)) + \dim(L_2 \cap (R_2 + Z_2)) \\
&\quad - \dim(L_1 \cap L_2) - \dim((R_1 + Z_1) \cap (R_2 + Z_2)) \\
&\quad + \dim((L_1 + Z_1 + R_1) \cap (L_2 + R_2 + Z_2)) \\
&= \dim((L_1 + L_2) \cap (R_1 + Z_1 + R_2 + Z_2)). \quad \square
\end{aligned}$$

Proof of Proposition 4.1. Let v_1, v_2, v_3 be the neighbors of v such that v_1vv_2 is an improper x -blocking path and $\lambda_x^{(T, \mathcal{L})}(vv_1) \geq \lambda_x^{(T, \mathcal{L})}(vv_2)$. Let $L_1 = \langle \mathcal{L}_x(T, v, v_1) \rangle$, $L_2 = \langle \mathcal{L}(T, v, v_1) - \mathcal{V}_x \rangle$, $R_1 = \langle \mathcal{L}_x(T, v, v_2) \rangle$, $R_2 = \langle \mathcal{L}(T, v, v_2) - \mathcal{V}_x \rangle$, $Z_1 = \langle \mathcal{L}_x(T, v, v_3) \rangle$, $Z_2 = \langle \mathcal{L}(T, v, v_3) - \mathcal{V}_x \rangle$. Let v' be the new node of T' on the path from v to v_2 . See Figure 7.

For an edge e' of T' , if e' is in $T' - V(T^{v,x}) - V(T^{v,\bar{x}}) - vv'$, then there exists the corresponding edge e of T such that the width of e' is equal to the width of e .

Now we show that the width of vv' is at most the width of vv_1 in T . Since v_1vv_2 is an x -blocking path,

$$(L_1 + Z_1) \cap B_x = L_1 \cap B_x \text{ and } (R_1 + Z_1) \cap B_x = R_1 \cap B_x.$$

Then, by taking the intersection with $L_2 + R_2 + Z_2$, we have

$$\begin{aligned}
(L_1 + Z_1) \cap (L_2 + R_2 + Z_2) \cap B_x &= L_1 \cap (L_2 + R_2 + Z_2) \cap B_x \text{ and} \\
(R_1 + Z_1) \cap (L_2 + R_2 + Z_2) \cap B_x &= R_1 \cap (L_2 + R_2 + Z_2) \cap B_x.
\end{aligned}$$

As $(L_1 + Z_1) \subseteq \langle \mathcal{V}_x \rangle$ and $(L_2 + R_2 + Z_2) \subseteq \langle \mathcal{V}_0 - \mathcal{V}_x \rangle$, we deduce that $L_1 \cap (L_2 + R_2 + Z_2) \subseteq (L_1 + Z_1) \cap (L_2 + R_2 + Z_2) \subseteq \langle \mathcal{V}_x \rangle \cap \langle \mathcal{V}_0 - \mathcal{V}_x \rangle \subseteq B_x$. Thus, we have $(L_1 + Z_1) \cap (L_2 + R_2 + Z_2) = (L_1 + Z_1) \cap (L_2 + R_2 + Z_2) \cap B_x = L_1 \cap (L_2 + R_2 + Z_2) \cap B_x = L_1 \cap (L_2 + R_2 + Z_2)$. Similarly we obtain

$$(R_1 + Z_1) \cap (L_2 + R_2 + Z_2) = R_1 \cap (L_2 + R_2 + Z_2).$$

We can also see that

$$\dim(L_1 \cap (Z_1 + R_1)) = \lambda_x^{(T, \mathcal{L})}(vv_1) \geq \lambda_x^{(T, \mathcal{L})}(vv_2) = \dim((L_1 + Z_1) \cap R_1).$$

Thus the conditions for Lemma 4.4 hold. Then Lemma 4.4 implies that the width of vv' is at most the width of v_1v in T .

We claim that for an edge e' in $E(T'[V(T^{v,x}) \cup \{v\}])$, the width of e' is at most the width of some edge in $E(T[V(T^{vv_3}) \cup \{v\}])$. Let $e' = x'y'$ where z' is closer to v than y' . By the construction of T' , there exists an edge $e = zy$, which is x -blocked by v_1vv_2 , in $E(T[V(T^{vv_3}) \cup \{v\}])$ such that $\mathcal{L}_x(T, z, y) = \mathcal{L}_x(T', z', y')$.

Let $X_1 = \langle \mathcal{L}_x(T, z, y) \rangle$, $X_2 = \langle \mathcal{L}(T, z, y) - \mathcal{V}_x \rangle$, $Y_1 = \langle \mathcal{L}_x(T, v, v_3) - \mathcal{L}_x(T, z, y) \rangle$, $Y_2 = \langle \mathcal{L}(T, v, v_3) - \mathcal{L}(T, z, y) - \mathcal{V}_x \rangle$. Note that $X_1 + Y_1 = Z_1$ and $X_2 + Y_2 = Z_2$. Then, we observe that $Z_1 \cap (L_2 + R_2 + Z_2) \subseteq (L_1 + Z_1) \cap (L_2 + R_2 + Z_2) = L_1 \cap (L_2 + R_2 + Z_2)$ and similarly $Z_1 \cap (L_2 + R_2 + Z_2) \subseteq R_1 \cap (L_2 + R_2 + Z_2)$. Thus,

$$Z_1 \cap (L_2 + R_2 + Z_2) \subseteq L_1 \cap R_1 \cap (L_2 + R_2 + Z_2) \subseteq (L_1 + R_1) \cap (L_2 + R_2 + Z_2).$$

So the condition for Lemma 4.2 holds. And Lemma 4.2 shows that the width of e' is at most the width of e .

Similarly, it is easy to show that the claim is true for an edge e' in $E(T'[V(T^{v,\bar{x}}) \cup \{v'\}])$. \square

4.2 Split

Suppose again that (T, \mathcal{L}) is a branch-decomposition of \mathcal{V}_0 , x is a node of T^b with $\mathcal{V}_x \subseteq \mathcal{V}_0$, and an edge uv of T x -guards v improperly or uv is improper x -degenerate. Under those circumstances, if (u, v) is x -mixed, we define an operation called *splitting*. Similar to the definitions for forking, we define T^{uv} to be the component of $T - uv$ containing v , regarded as a rooted binary tree with the root v . Let T_x^{uv} be the minimal subtree of T^{uv} that contains every leaf of T^{uv} mapped to a subspace in \mathcal{V}_x by \mathcal{L} . Let the root of T_x^{uv} be the node of T_x^{uv} closest to v in T^{uv} . Let $T^{v,x}$ be the rooted binary tree obtained from T_x^{uv} by smoothing degree-2 nonroot nodes if necessary. Let $T_{\bar{x}}^{uv}$ be the minimal subtree of T_{uv} that contains every leaf of T^{uv} mapped to a subspace in $\mathcal{V}_0 - \mathcal{V}_x$ by \mathcal{L} . Let the root of $T_{\bar{x}}^{uv}$ be the node of $T_{\bar{x}}^{uv}$ closest to v in T^{uv} such that every subspace in $\mathcal{V}_0 - \mathcal{V}_x$ corresponds to a leaf of $T_{\bar{x}}^{uv}$ and the root of $T_{\bar{x}}^{uv}$ is the closest node to v in T^{uv} . Let $T^{v,\bar{x}}$ be the rooted binary tree obtained from $T_{\bar{x}}^{uv}$ by smoothing degree-2 nonroot nodes if necessary.

Splitting at uv by \mathcal{V}_x is an operation to transform (T, \mathcal{L}) to another branch-decomposition (T', \mathcal{L}) by deleting all nodes in the component of $T - v$ not containing u , making the disjoint union with $T^{v,x}$ and $T^{v,\bar{x}}$, adding an edge joining v with the root of $T^{v,x}$ and an edge joining v with the root of $T^{v,\bar{x}}$. See Figures 8 and 9.

We prove that splitting does not increase the width.

Proposition 4.5. *If a branch-decomposition (T', \mathcal{L}) is obtained from a branch-decomposition (T, \mathcal{L}) by splitting uv by \mathcal{V}_x , then the width of (T', \mathcal{L}) is less than or equal to the width of (T, \mathcal{L}) .*

Proof. This is immediate from Lemma 4.2. \square

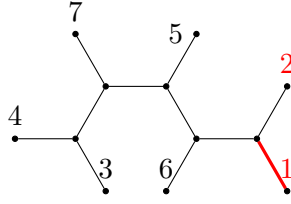

Figure 8: A branch-decomposition (T', \mathcal{L}') obtained from (T, \mathcal{L}) by splitting an improper y -degenerate edge in (T, \mathcal{L}) from Figure 5. Then (T', \mathcal{L}') is y -pure, y' -pure, x -pure, and y'' -pure and therefore (T', \mathcal{L}') is totally pure with respect to (T^b, \mathcal{L}^b) .

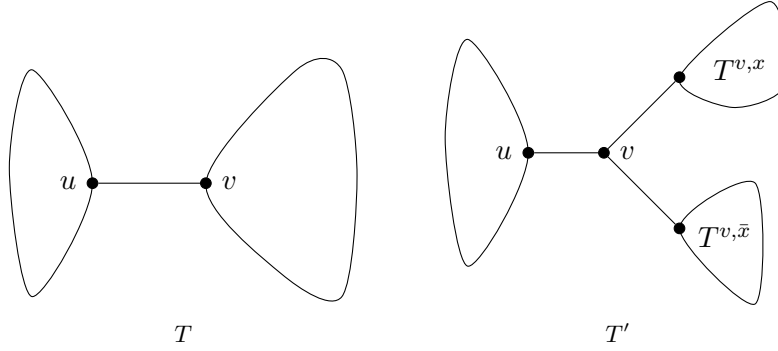

Figure 9: Constructing T' by splitting at uv by \mathcal{V}_x .

4.3 Pure branch-decompositions exist

Our goal is to prove the following proposition.

Proposition 4.6. *Let (T^b, \mathcal{L}^b) be a rooted branch-decomposition of a subspace arrangement \mathcal{V} and let $\mathcal{V}_0 \subseteq \mathcal{V}$. If the branch-width of \mathcal{V}_0 is at most k , then \mathcal{V}_0 has a branch-decomposition of width at most k that is totally pure with respect to (T^b, \mathcal{L}^b) .*

To prove this proposition, we need some lemmas.

Lemma 4.7. *Let x, y be nodes of T^b with $x \leq y$. If L is a subspace of $\langle \mathcal{V}_x \rangle$, then*

$$L \cap B_y \subseteq L \cap B_x.$$

Proof. Since $B_x = \langle \mathcal{V}_x \rangle \cap \langle \mathcal{V} - \mathcal{V}_x \rangle$ and $L \subseteq \langle \mathcal{V}_x \rangle \subseteq \langle \mathcal{V}_y \rangle$, we see that $L \cap B_x = L \cap \langle \mathcal{V} - \mathcal{V}_x \rangle$ and $L \cap B_y = L \cap \langle \mathcal{V} - \mathcal{V}_y \rangle$. As $\langle \mathcal{V} - \mathcal{V}_y \rangle \subseteq \langle \mathcal{V} - \mathcal{V}_x \rangle$, we have $L \cap B_y \subseteq L \cap B_x$. \square

Lemma 4.8. *Let x, y be nodes of T^b with $x \leq y$. Let (T, \mathcal{L}) be a branch-decomposition of \mathcal{V}_0 with $\mathcal{V}_y \subseteq \mathcal{V}_0$. If $\mathcal{L}_y(T, u, v) \subseteq \mathcal{V}_x$ and an edge $e = uv$ of T is x -degenerate or x -guards v , then e is y -degenerate or y -guards v .*

Proof. Let $L_x = \langle \mathcal{L}_x(T, u, v) \rangle$, $R_x = \langle \mathcal{L}_x(T, v, u) \rangle$, $L_y = \langle \mathcal{L}_y(T, u, v) \rangle$, and $R_y = \langle \mathcal{L}_y(T, v, u) \rangle$. We will show that if $L_x \cap B_x \subseteq R_x \cap B_x$, then $L_y \cap B_y \subseteq R_y \cap B_y$. Since $\mathcal{L}_y(T, u, v) \subseteq \mathcal{V}_x$ and $\mathcal{V}_x \subseteq \mathcal{V}_y$, we have $L_x = L_y$ and $R_x \subseteq R_y$. By Lemma 4.7, $L_y \cap B_y \subseteq L_x \cap B_x$. Since $L_x \cap B_x \subseteq R_x \cap B_x$ and $R_x \subseteq R_y$, we have $L_y \cap B_y \subseteq R_y$. Thus, $L_y \cap B_y \subseteq R_y \cap B_y$. \square

Lemma 4.9. *Let x be a node of T^b and let (T, \mathcal{L}) be a branch-decomposition of \mathcal{V}_0 such that $\mathcal{V}_x \subseteq \mathcal{V}_0$. Let $v_0v_1 \cdots v_\ell$ be a path in T . If v_0v_1 x -guards v_1 or v_0v_1 is x -degenerate, then $v_{\ell-1}v_\ell$ x -guards v_ℓ or $v_{\ell-1}v_\ell$ is x -degenerate.*

Proof. It is easy to see that $\mathcal{L}_x(T, v_{\ell-1}, v_\ell) \subseteq \mathcal{L}_x(T, v_0, v_1)$ and $\mathcal{L}_x(T, v_1, v_0) \subseteq \mathcal{L}_x(T, v_\ell, v_{\ell-1})$. Thus,

$$\langle \mathcal{L}_x(T, v_{\ell-1}, v_\ell) \rangle \cap B_x \subseteq \langle \mathcal{L}_x(T, v_\ell, v_{\ell-1}) \rangle \cap B_x$$

because $\langle \mathcal{L}_x(T, v_0, v_1) \rangle \cap B_x \subseteq \langle \mathcal{L}_x(T, v_1, v_0) \rangle \cap B_x$. \square

Lemma 4.10. *Let x, y be nodes of T^b with $y \not\leq x$. Let (T, \mathcal{L}) be a branch-decomposition of \mathcal{V}_0 with $\mathcal{V}_x \cup \mathcal{V}_y \subseteq \mathcal{V}_0$. Let pq be an edge of T such that $\mathcal{L}(T, p, q) \subseteq \mathcal{V}_x$ and it either x -guards q or is x -degenerate. If (q, p) points toward a node u of T and a branch-decomposition (T', \mathcal{L}) is obtained from (T, \mathcal{L}) by either forking at u by \mathcal{V}_y or splitting at an edge uv of T by \mathcal{V}_y , then T' has an edge $p'q'$ such that $\mathcal{L}(T', p', q') = \mathcal{L}(T, p, q)$. Furthermore, $q' = q$.*

Proof. We first claim that for two nodes u and v of T , if (u, v) is y -mixed, then $(u, v) \neq (p, q)$. Suppose not. If $x < y$, then $\mathcal{L}(T, u, v) = \mathcal{L}(T, p, q) \subseteq \mathcal{V}_x \subseteq \mathcal{V}_y$, which contradicts that (u, v) is y -mixed. If x and y are incomparable, then $\mathcal{L}(T, u, v) \subseteq \mathcal{V}_x \subseteq \mathcal{V}_0 - \mathcal{V}_y$, which also contradicts that (u, v) is y -mixed.

Suppose that (T', \mathcal{L}) is obtained from (T, \mathcal{L}) by splitting at uv by \mathcal{V}_y . Let T_q be the component of $T - pq$ containing q . Note that $(u, v) \neq (p, q)$ because (u, v) is y -mixed. As $(u, v) \neq (p, q)$ and (q, p) points toward u , we know that T_q is contained either in the component of $T - uv$ containing v or in the component of $T - uv$ containing u . In the former case, after splitting, T_q is a subtree of T_y^{uv} if $x < y$, and T_q is a subtree of T_y^{uv} if x, y are incomparable.

Then the statement trivially follows from $\mathcal{L}(T, p, q) \subseteq \mathcal{V}_x$. In the latter case, note that the component of $T' - uv$ containing u is identical to the component of $T - uv$ containing u , and the statement follows.

If (T', \mathcal{L}) is obtained by forking at u , then let v be the unique neighbor of u which does not lie on the y -blocking path. We remark that (u, v) is y -mixed and uv cuts \mathcal{V}_y . Thus similarly we can see that the statement holds. \square

Lemma 4.11. *Let x, y be nodes of T^b with $y \not\leq x$. Let (T, \mathcal{L}) be a branch-decomposition of \mathcal{V}_0 with $\mathcal{V}_x \cup \mathcal{V}_y \subseteq \mathcal{V}_0$. Let (T', \mathcal{L}) be a branch-decomposition obtained from (T, \mathcal{L}) by either forking at u by \mathcal{V}_y or splitting at uv by \mathcal{V}_y . If (T, \mathcal{L}) is x -disjoint, then (T', \mathcal{L}) is x -disjoint.*

Proof. If (T', \mathcal{L}) is obtained by forking, then let v_1uv_2 be an improper y -blocking path and let v be the neighbor of u other than v_1 and v_2 . Then we observe that uv y -guards v and uv cuts \mathcal{V}_y . Note that if (T', \mathcal{L}) is obtained by splitting at uv , then uv also cuts \mathcal{V}_y . We also remark that (u, v) is y -mixed in both cases.

Since (T, \mathcal{L}) is x -disjoint and $\mathcal{V}_0 \neq \mathcal{V}_x$, there exists an edge pq of T such that $\mathcal{L}(T, p, q) = \mathcal{V}_x$ and q is incident with an improper x -degenerate edge. If (v, u) points toward p and (p, q) points toward v , then $\mathcal{L}(T, u, v) \subseteq \mathcal{L}(T, p, q) = \mathcal{V}_x$. Then either $\mathcal{L}(T, u, v) \subseteq \mathcal{V}_y$ or $\mathcal{L}(T, u, v) \subseteq \mathcal{V}_0 - \mathcal{V}_y$, depending on whether $x < y$ or x, y are incomparable, contradicting that (u, v) is y -mixed. If (q, p) points toward v , then, by Lemma 4.10, there exists an edge $p'q'$ of T' such that $\mathcal{L}(T', p', q') = \mathcal{V}_x$ and q' is incident with an improper x -degenerate edge. That is, (T', \mathcal{L}) is x -disjoint as desired.

Now we assume that (u, v) points toward p and (p, q) points toward u . If x and y are incomparable, then we have $\mathcal{L}(T, v, u) \subseteq \mathcal{L}(T, p, q) = \mathcal{V}_x \subseteq \mathcal{V}_0 - \mathcal{V}_y$. This contradicts the

fact that uv cuts \mathcal{V}_y . Hence, we assume that $x < y$. Since q is incident with an improper x -degenerate edge, if (T', \mathcal{L}) is obtained by forking at u , then by Lemmas 4.8 and 4.9, uv_1 is either y -guarding or y -degenerate, a contradiction. Now we may further assume that (T', \mathcal{L}) is obtained by splitting at uv . If $(p, q) = (v, u)$, then clearly (T', \mathcal{L}) is x -disjoint as desired. If $(p, q) \neq (v, u)$, then again by applying Lemmas 4.8 and 4.9, we know that uv y -guards u or uv is y -degenerate. Since uv y -guards v , uv can only be y -degenerate, which must be improper. On the other hand, uv cuts \mathcal{V}_x because $\mathcal{L}(T, p, q) = \mathcal{V}_x$ and $(p, q) \neq (v, u)$. This is a contradiction to the fact that uv is an improper y -degenerate edge because (T, \mathcal{L}) is x -degenerate. \square

For a branch-decomposition (T, \mathcal{L}) of a subspace arrangement \mathcal{V}_0 , a subset \mathcal{V}' of \mathcal{V}_0 is said to *induce* a branch-decomposition (T', \mathcal{L}') if a subdivision of T' is the minimal subtree of T containing all leaves in $\mathcal{L}^{-1}(\mathcal{V}')$ and \mathcal{L}' is the restriction of \mathcal{L} on \mathcal{V}' . We write $(T', \mathcal{L}') = (T, \mathcal{L})|_{\mathcal{V}'}$ if (T', \mathcal{L}') is induced by \mathcal{V}' from (T, \mathcal{L}) .

Lemma 4.12. *Let x, y be nodes of T^b with $y \not\leq x$. Let (T, \mathcal{L}) be a branch-decomposition of \mathcal{V}_0 with $\mathcal{V}_x \cup \mathcal{V}_y \subseteq \mathcal{V}_0$ and (T', \mathcal{L}') be a branch-decomposition obtained from (T, \mathcal{L}) by either forking at v by \mathcal{V}_y or splitting at uv by \mathcal{V}_y . Then $(T, \mathcal{L})|_{\mathcal{V}_x} = (T', \mathcal{L}')|_{\mathcal{V}_x}$.*

Proof. If $x \leq y$, then by the construction of T' , subspaces of \mathcal{V}_0 mapped by the leaves of $T^{v, \bar{y}}$ are not in \mathcal{V}_y and thus not in \mathcal{V}_x because $\mathcal{V}_0 - \mathcal{V}_y \subseteq \mathcal{V}_0 - \mathcal{V}_x$. Therefore, it is clear by definition that $(T, \mathcal{L})|_{\mathcal{V}_x} = (T', \mathcal{L}')|_{\mathcal{V}_x}$.

If x and y are incomparable, then subspaces of \mathcal{V}_0 mapped by the leaves of $T^{v, y}$ are in \mathcal{V}_y and thus not in \mathcal{V}_x because $\mathcal{V}_y \subseteq \mathcal{V}_0 - \mathcal{V}_x$. Therefore, $(T, \mathcal{L})|_{\mathcal{V}_x} = (T', \mathcal{L}')|_{\mathcal{V}_x}$. \square

Corollary 4.13. *Let x, y be nodes of T^b with $y \not\leq x$. Let (T, \mathcal{L}) be a branch-decomposition of \mathcal{V}_0 with $\mathcal{V}_x \cup \mathcal{V}_y \subseteq \mathcal{V}_0$ and (T', \mathcal{L}') be a branch-decomposition obtained from (T, \mathcal{L}) by either forking at v by \mathcal{V}_y or splitting at uv by \mathcal{V}_y . Then (T, \mathcal{L}) is x -degenerate if and only if (T', \mathcal{L}') is x -degenerate.*

Proof. It follows immediately from Lemma 4.12 and the definition of x -degenerate branch-decompositions. \square

For a node x of T^b with $\mathcal{V}_x \subseteq \mathcal{V}_0$, if $(T', \mathcal{L}') = (T, \mathcal{L})|_{\mathcal{V}_x}$, then by definition, there exists a canonical injection $\phi_x : V(T') \rightarrow V(T)$ such that for every leaf ℓ of T' , $\mathcal{L}'(\ell) = \mathcal{L}(\phi_x(\ell))$. We say that a node v of T is an x -branch node if ϕ_x maps a node of T' to v , and such v is said to *correspond* to $\phi_x^{-1}(v)$. An edge e of T is said to *correspond* to an edge $f = ab$ of T' if e is on the unique path of T from $\phi_x^{-1}(a)$ to $\phi_x^{-1}(b)$. Observe that if an edge uv of T corresponds to ab of T' and (u, v) points toward $\phi_x^{-1}(b)$, then $\mathcal{L}_x(T, u, v) = \mathcal{L}'(T', a, b)$ by definition of (T', \mathcal{L}') .

Lemmas 4.14 and 4.15 will show that if (T, \mathcal{L}) is x -pure and (T', \mathcal{L}') is obtained from (T, \mathcal{L}) by either forking or splitting, then (T', \mathcal{L}') is also x -pure.

Lemma 4.14. *Let x, y be nodes of T^b with $y \not\leq x$. Let (T, \mathcal{L}) be a branch-decomposition of \mathcal{V}_0 with $\mathcal{V}_x \cup \mathcal{V}_y \subseteq \mathcal{V}_0$. Let (T', \mathcal{L}') be a branch-decomposition obtained from (T, \mathcal{L}) by either forking at u by \mathcal{V}_y for the center u of an improper y -blocking path, or splitting at uv by \mathcal{V}_y for an edge uv of T y -guarding v improperly. If (T, \mathcal{L}) is x -pure, then (T', \mathcal{L}') is x -pure.*

Proof. If (T, \mathcal{L}) is x -degenerate, then (T, \mathcal{L}) is x -disjoint. By Lemma 4.11 and Corollary 4.13, (T', \mathcal{L}') is x -disjoint and x -degenerate, which implies that (T', \mathcal{L}') is x -pure. So we assume that (T, \mathcal{L}) is not x -degenerate.

Let v be the neighbor of u that is not on the improper y -blocking path when (T', \mathcal{L}') is obtained by forking at u . Then for both cases, forking at u and splitting at uv , we observe that

- uv y -guards v ,
- uv cuts \mathcal{V}_y , and
- (u, v) is y -mixed, which implies $\mathcal{L}_y(T, u, v) \neq \mathcal{L}(T, u, v)$.

First, we will show that every x -guarding edge in (T', \mathcal{L}) is proper. Suppose an edge $p'q'$ of T' x -guards q' improperly. Let $(T_x, \mathcal{V}_x) = (T', \mathcal{L})|_{\mathcal{V}_x}$. Since $p'q'$ is improper, q' is an x -branch node of T' and thus there exists a node q_x of T_x with $\phi'(q_x) = q'$ where ϕ' is the canonical injection from the set of all nodes of T_x to the set of all nodes of T' . Let p_xq_x be the edge of T_x such that an edge $p'q'$ of T' corresponds to p_xq_x . By Lemma 4.12, $(T, \mathcal{L})|_{\mathcal{V}_x} = (T_x, \mathcal{V}_x)$. For the canonical injection ϕ from the set of all nodes of T_x to the set of all nodes of T , let $q = \phi(q_x)$ and let pq be the edge of T corresponding to an edge p_xq_x of T_x . Then we observe that pq x -guards q so that it is proper because (T, \mathcal{L}) is x -pure. And thus, we have $\mathcal{L}(T, p, q) \subseteq \mathcal{V}_x$.

We will consider cases depending on the locations of u, v, p, q in T . If an edge uv is in the component of $T - pq$ containing p , then by Lemma 4.10, $\mathcal{L}(T', p', q') = \mathcal{L}(T, p, q) \subseteq \mathcal{V}_x$, and so $p'q'$ is proper, which is a contradiction. Suppose uv is not in the component of $T - pq$ containing p . If x and y are incomparable, then it is also a contradiction because uv cuts \mathcal{V}_y and $\mathcal{L}(T, u, v) \subseteq \mathcal{L}(T, p, q) \subseteq \mathcal{V}_x$. Thus we assume $x < y$. If (v, u) points toward p , then it is a contradiction because $\mathcal{L}_y(T, u, v) \neq \mathcal{L}(T, u, v)$ and $\mathcal{L}(T, u, v) \subseteq \mathcal{L}(T, p, q) \subseteq \mathcal{V}_x$. If (u, v) points toward p , then by Lemmas 4.8 and 4.9, vu y -guards u or is y -degenerate because pq x -guards q . It is a contradiction because uv y -guards v . Therefore, we conclude that $p'q'$ is proper, which implies that every x -guarding edge in (T', \mathcal{L}) is proper.

It remains to show that every x -blocking path in (T', \mathcal{L}) is proper. Suppose $p'_1p'p'_2$ is an improper x -blocking path in T' and q' is a neighbor of p' other than p'_1 and p'_2 . Let $(T_x, \mathcal{V}_x) = (T', \mathcal{L})|_{\mathcal{V}_x}$. Since $p'_1p'p'_2$ is improper, p' is an x -branch node of T' and thus there exists p_x with $\phi'(p_x) = p'$ where ϕ' is the canonical injection from the set of all nodes of T_x to the set of all nodes of T' . Let p_xq_x be the edge of T_x such that an edge $p'q'$ of T' corresponds to p_xq_x . By Lemma 4.12, let $(T, \mathcal{L})|_{\mathcal{V}_x} = (T_x, \mathcal{V}_x)$. For the canonical injection ϕ from the set of all nodes of T_x to the set of all nodes of T , let $p = \phi(p_x)$ and let pq be the edge of T corresponding to an edge p_xq_x of T_x . Similarly, p_1p and pp_2 are the edges of T corresponding to the edges of T_x incident with p_x . Then p_1pp_2 is an x -blocking path in T by Lemma 4.12. Since (T, \mathcal{L}) is x -pure, we observe that $\mathcal{L}(T, p, q) \subseteq \mathcal{V}_x$. We also observe that pq x -guards q . It is a contradiction because uv y -guards v . Therefore, $p'_1p'p'_2$ is proper, which implies that every x -blocking path in (T', \mathcal{L}) is proper. This completes the proof. \square

Let y be a node of T^b and (T, \mathcal{L}) be a branch-decomposition of \mathcal{V}_0 with $\mathcal{V}_y \subseteq \mathcal{V}_0$. We say that an improper y -degenerate edge uv of T is y -acceptable if either uv is y -crossing, or $\mathcal{V}_0 - \mathcal{V}_y \subseteq \mathcal{L}(T, u, v)$ and there is no edge $ab \neq uv$ of T such that $\mathcal{V}_0 - \mathcal{V}_y \subseteq \mathcal{L}(T, a, b) \subseteq \mathcal{L}(T, u, v)$.

Lemma 4.15. *Let x, y be nodes of T^b with $y \not\leq x$. Let (T, \mathcal{L}) be a branch-decomposition of \mathcal{V}_0 with $\mathcal{V}_x \cup \mathcal{V}_y \subseteq \mathcal{V}_0$. Let (T', \mathcal{L}) be a branch-decomposition of \mathcal{V}_0 obtained from (T, \mathcal{L}) by splitting at a y -acceptable edge uv by \mathcal{V}_y . If (T, \mathcal{L}) is x -pure, then (T', \mathcal{L}) is x -pure.*

Proof. First, consider the case when (T, \mathcal{L}) is x -degenerate. Then (T, \mathcal{L}) is x -disjoint and by Lemma 4.11, (T', \mathcal{L}) is x -disjoint. Thus (T', \mathcal{L}) is x -pure because it is x -degenerate by Corollary 4.13.

Now suppose that uv is an edge of $T[V(T_q) \cup \{p\}]$, where T_q is the component of $T - pq$ containing q . If $(p, q) = (u, v)$ or uv is an edge of T_q such that (v, u) points toward q , then

$\mathcal{L}(T, u, v) \subseteq \mathcal{L}(T, p, q) = \mathcal{V}_x$. Recall that $\mathcal{V}_x \subseteq \mathcal{V}_y$ or $\mathcal{V}_x \cap \mathcal{V}_y = \emptyset$, depending on whether $x < y$ or x, y are incomparable nodes of T^b , and therefore we have $\mathcal{L}(T, u, v) \subseteq \mathcal{V}_y$ or $\mathcal{L}(T, u, v) \cap \mathcal{V}_y = \emptyset$. This, however, contradicts to the assumption that (u, v) is y -mixed, which is the requirement for splitting at uv . Therefore, we conclude that either $(p, q) = (v, u)$ or uv is an edge of T_q such that (u, v) points toward q . Now observe that $\mathcal{L}(T, v, u) \subseteq \mathcal{L}(T, p, q) \subseteq \mathcal{V}_x$. This means that $x < y$: indeed, if x, y are incomparable, then $\mathcal{L}(T, v, u) \cap \mathcal{V}_y = \emptyset$, which contradicts that uv cuts \mathcal{V}_y as an improper y -degenerate edge.

Since uv is an improper y -degenerate edge and (T, \mathcal{L}) is x -degenerate, uv does not cut \mathcal{V}_x . Therefore, we deduce that $(p, q) = (v, u)$. Observe that splitting at uv by \mathcal{V}_y keeps T_q intact, that is, T_q is identical to a subtree of T' . It follows that (T', \mathcal{L}) is x -disjoint as desired. This establishes the case when (T, \mathcal{L}) is x -degenerate.

Second, we consider the case when (T, \mathcal{L}) is not x -degenerate. Suppose that the statement does not hold. That is, T' has an improper x -guarding edge or an improper x -blocking path. We take an edge $p'q'$ of T' as follows: in the former case, $p'q'$ is an edge of T' improperly x -guarding q' . In the latter case, we take p' so that it is the center of an improper x -blocking path and $p'q'$ is an edge incident with p' that is not on the x -blocking path. Notice that $p'q'$ x -guards q' in both cases. Since (p', q') is x -mixed and $\mathcal{L}_x(T', q', p') \neq \emptyset$ in both cases, $p'q'$ cuts \mathcal{V}_x . Therefore, $p'q'$ corresponds to an edge f of $(T', \mathcal{L})|_{\mathcal{V}_x}$.

Now we shall choose an edge of T corresponding to f of $(T', \mathcal{L})|_{\mathcal{V}_x}$. Clearly, T has an edge corresponding to f because $(T, \mathcal{L})|_{\mathcal{V}_x} = (T', \mathcal{L})|_{\mathcal{V}_x}$. Note that in the case when $p'q'$ is an improper x -guarding edge, q' is an x -branch node by definition. When $p'q'$ is chosen as an edge incident with an improper x -blocking path, p' is an x -branch node by definition. We choose pq so that q and q' correspond to the same node of $(T, \mathcal{L})|_{\mathcal{V}_x}$ in the former case, and p and p' correspond to the same node of $(T, \mathcal{L})|_{\mathcal{V}_x}$ in the latter case. Once p or q is fixed, pq is uniquely determined by the condition that pq and $p'q'$ correspond to f . Observe that pq is x -guarding in the former case and it must be proper as (T, \mathcal{L}) is x -pure. If $p'q'$ is chosen from an improper x -blocking path of T' , then p is the center of an x -blocking path of T , which must be proper, and pq is the edge incident with p that is not on this x -blocking path. Therefore, pq x -guards q . Since (p', q') is x -mixed and $\mathcal{L}_x(T', p', q') = \mathcal{L}_x(T, p, q)$ while (p, q) is not x -mixed in T , it follows that $\mathcal{L}(T, p, q) \subseteq \mathcal{V}_x$. This also implies that q is an x -branch node.

Suppose that u is a node of the component of $T - pq$ containing p . For $\mathcal{L}(T, p, q) \subseteq \mathcal{V}_x$, we can apply Lemma 4.10 and deduce that T' contains an edge $p''q''$ such that $\mathcal{L}(T, p, q) = \mathcal{L}(T', p'', q'')$ and $q'' = q$. Then q'' is an x -branch node of T' which correspond to the same node of $(T, \mathcal{L})|_{\mathcal{V}_x}$ as q , implying $q'' = q'$ because $\mathcal{L}(T', p'', q'') \subseteq \mathcal{V}_x$. It follows that $p''q'' = p'q'$ as $\mathcal{L}_x(T', p', q') = \mathcal{L}_x(T, p, q) = \mathcal{L}_x(T', p'', q'')$. Now, $\mathcal{L}(T', p', q') = \mathcal{L}(T', p'', q'') \subseteq \mathcal{V}_x$, which contradicts the choice of $p'q'$.

Therefore, uv is either an edge of T_q , where T_q is the component of $T - pq$ containing q , or $(p, q) = (v, u)$. Especially, if uv is an edge of T_q then (u, v) must point toward q since otherwise (u, v) is not y -mixed. Also similarly as in the previous case, we have $x < y$.

Let $P = w_0w_1 \cdots w_s$ be the unique path of T from $p = w_0$ to $u = w_s$ and recall that the first edge is pq and the last edge is uv . We claim that every edge on P is an improper y -degenerate edge. Lemma 4.9 and the existence of uv such that (u, v) pointing toward q imply that every edge $w_{i-1}w_i$ y -guards w_{i-1} or $w_{i-1}w_i$ is y -degenerate. On the other hand, $pq = w_0w_1$ x -guards $q = w_1$. By Lemma 4.9, every edge $w_{i-1}w_i$ x -guards w_i or is x -degenerate, and thus $w_{i-1}w_i$ y -guards w_i or is y -degenerate due to Lemma 4.8. It follows that every edge on P is y -degenerate, including pq . Now, recall that uv is y -acceptable and uv is not y -crossing due to $\mathcal{L}(T, v, u) \subseteq \mathcal{V}_x$.

Therefore, uv is an improper y -degenerate edge such that $\mathcal{L}(T, u, v)$ is a minimal set containing $\mathcal{V}_0 - \mathcal{V}_y$. We conclude that $(p, q) = (v, u)$ and (T', \mathcal{L}) is obtained by splitting at $uv = qp$. It is easy to see that $q' = q$ and $\mathcal{L}(T', p', q') = \mathcal{L}(T, p, q) \subseteq \mathcal{V}_x$. However, this contradicts the choice of $p'q'$. \square

Lemma 4.16. *Let y be a node of T^b and let (T, \mathcal{L}) be a branch-decomposition of a subspace arrangement \mathcal{V}_0 such that $\mathcal{V}_y \subseteq \mathcal{V}_0$ and (T, \mathcal{L}) is not y -degenerate. By repeatedly applying forking if it has an improper y -blocking path, and applying splitting if it has an improper y -guarding edge to (T, \mathcal{L}) , we can construct a branch-decomposition that has neither improper y -blocking paths nor improper y -guarding edges.*

Proof. Suppose (T, \mathcal{L}) has an improper y -blocking path or an improper y -guarding edge. We are going to show that if we apply forking or splitting to (T, \mathcal{L}) , then the number of improper y -blocking paths and improper y -guarding edges must decrease strictly.

Let v_1v_2 be an improper y -blocking path in (T, \mathcal{L}) . Let (T', \mathcal{L}) be a branch-decomposition obtained from (T, \mathcal{L}) by forking at v by \mathcal{V}_y such that v' is the new node in T' created by subdividing vv_2 . Let us consider the number of improper y -blocking paths and improper y -guarding edges in T' as follows.

- Let V_1 and V_2 be the set of all nodes in the components of $T - v$ containing v_1 and v_2 , respectively. The total number of improper y -blocking paths and improper y -guarding edges in $T'[V_1 \cup \{v\}]$ and $T'[V_2 \cup \{v'\}]$ is equal to the number of those in $T[V_1 \cup \{v\}]$ and $T[V_2 \cup \{v\}]$.
- By the construction of T' , all y -blocking paths and all y -guarding edges in $T'[V(T^{v,\bar{y}}) \cup \{v, v', v_2\}]$ are proper because a subspace mapped from a nonroot leaf of $T^{v,\bar{y}}$ by \mathcal{L} is not in \mathcal{V}_y . Note that edges vv' and $v'v_2$ of T' are not y -guarding because v_1vv_2 in T is y -blocking.
- For a y -blocking path p_1pp_2 in $T'[V(T^{v,y}) \cup \{v\}]$, if p_3 is the neighbor of p other than p_1 and p_2 , then (p, p_3) does not point toward v by Lemma 4.9 because vv_3 y -guards v_3 . Thus, every y -blocking path in $T'[V(T^{v,y}) \cup \{v\}]$ is proper because a subspace mapped from a nonroot leaf of $T^{v,\bar{y}}$ by \mathcal{L} is in \mathcal{V}_y . Similarly, every y -guarding edge in $T'[V(T^{v,y}) \cup \{v\}]$ is proper.
- As v_1vv' is a y -blocking path, neither v_1vv_3 nor $v'vv_3$ in T' is a y -blocking path where v_3 is the root of $T^{v,y}$.

The number of improper y -blocking paths and improper y -guarding edges should decrease strictly because v_1vv_2 in T is improper but neither v_1vv' nor $vv'v_2$ is proper.

Similarly, it is easy to check that the number of improper y -blocking paths and improper y -guarding edges decreases strictly when we apply splitting to (T, \mathcal{L}) . This completes the proof. \square

Finally we give the proof of Proposition 4.6 that is our goal of this section.

Proof of Proposition 4.6. We may assume that $|\mathcal{V}_0| \geq 2$. For a branch-decomposition (T, \mathcal{L}) of \mathcal{V}_0 , let

$$S_{(T, \mathcal{L})} = \{x \in V(T^b) : \mathcal{V}_x \subseteq \mathcal{V}_0 \text{ and } (T, \mathcal{L}) \text{ is } z\text{-pure for all } z \leq x\}.$$

We choose a branch-decomposition (T, \mathcal{L}) of \mathcal{V}_0 having width at most k so that $|S_{(T, \mathcal{L})}|$ is maximal. If (T, \mathcal{L}) is totally pure with respect to (T^b, \mathcal{L}^b) , then we are done. If (T, \mathcal{L}) is not

totally pure with respect to (T^b, \mathcal{L}^b) , then there exists a node y of T^b with $\mathcal{V}_y \subseteq \mathcal{V}_0$ such that $y \notin S_{(T, \mathcal{L})}$ and two children of y are in $S_{(T, \mathcal{L})}$.

First let us consider the case when (T, \mathcal{L}) is y -degenerate.

- If T has an improper y -degenerate edge $u'v'$ such that $\mathcal{V}_0 - \mathcal{V}_y \subseteq \mathcal{L}(T, u', v')$, then choose a y -acceptable edge uv of T . And then we apply splitting at uv by \mathcal{V}_y to (T, \mathcal{L}) so that we obtain a new branch-decomposition (T', \mathcal{L}) .
- If there is no such edge, then there must exist an improper y -degenerate edge ab that is y -crossing. We apply splitting at ab by \mathcal{V}_y to (T, \mathcal{L}) so that we obtain a new branch-decomposition (T'', \mathcal{L}) . Let c be the root of $T^{b,y}$. We claim that cb is an improper y -degenerate edge such that $\mathcal{V}_0 - \mathcal{V}_y \subseteq \mathcal{L}(T'', c, b)$. Let d be the neighbor of b other than a and c , so that d is the root of $T^{b,\bar{y}}$. Then $\mathcal{L}_y(T'', b, d) = \emptyset$. Thus, $\mathcal{L}_y(T'', b, a) = \mathcal{L}_y(T'', c, b)$ and $\mathcal{L}_y(T'', a, b) = \mathcal{L}_y(T'', b, c)$. This proves the claim because ab is an improper y -degenerate edge. And then we choose a y -acceptable edge uv of T'' . Now we apply splitting at uv by \mathcal{V}_y to (T'', \mathcal{L}) so that we obtain a new branch-decomposition (T', \mathcal{L}) .

By the construction of (T', \mathcal{L}) , (T', \mathcal{L}) is y -disjoint. Note that (T, \mathcal{L}) is y -degenerate if and only if (T', \mathcal{L}) is y -degenerate because $(T, \mathcal{L})|_{\mathcal{V}_y} = (T', \mathcal{L})|_{\mathcal{V}_y}$. This implies that (T', \mathcal{L}) is y -pure because (T', \mathcal{L}) is y -degenerate. Then $S_{(T', \mathcal{L})} \supseteq S_{(T, \mathcal{L})} \cup \{y\}$ by Lemma 4.15, which contradicts the maximality of $S_{(T, \mathcal{L})}$. Note that (T', \mathcal{L}) has width at most k by Proposition 4.5.

If (T, \mathcal{L}) is not y -degenerate, then there exists an improper y -blocking path or an improper y -guarding edge. By repeatedly applying forking if it has an improper y -blocking path and applying splitting if it has an improper y -guarding edge to (T, \mathcal{L}) , we can construct a new branch-decomposition (T', \mathcal{L}) that has neither improper y -blocking paths nor improper y -guarding edges by Lemma 4.16. Note that (T, \mathcal{L}) is y -degenerate if and only if (T', \mathcal{L}) is y -degenerate because $(T, \mathcal{L})|_{\mathcal{V}_y} = (T', \mathcal{L})|_{\mathcal{V}_y}$. Thus (T', \mathcal{L}) is not y -degenerate and so it is y -pure. Also, for a node x of T^b with $y \not\leq x$, if (T, \mathcal{L}) is x -pure, then (T', \mathcal{L}) is x -pure by Lemma 4.14. Note that the resulting branch-decomposition has width at most k by Propositions 4.1 and 4.5. Then $S_{(T', \mathcal{L})} \supseteq S_{(T, \mathcal{L})} \cup \{y\}$, which contradicts the maximality of $S_{(T, \mathcal{L})}$. \square

The following lemma will be used later.

Lemma 4.17. *Let x_1 and x_2 be two children of a node x in T^b . Let (T, \mathcal{L}) be a branch-decomposition of \mathcal{V}_x . If (T, \mathcal{L}) is totally pure with respect to (T^b, \mathcal{L}^b) , then $(T, \mathcal{L})|_{\mathcal{V}_{x_i}}$ is totally pure with respect to (T^b, \mathcal{L}^b) for each $i = 1, 2$.*

Proof. By symmetry, it suffices to show that $(T, \mathcal{L})|_{\mathcal{V}_{x_1}}$ is y -pure for every node y of T^b with $y \leq x_1$. Trivially, $(T, \mathcal{L})|_{\mathcal{V}_{x_1}}$ is x_1 -pure.

Let $(T', \mathcal{L}') = (T, \mathcal{L})|_{\mathcal{V}_{x_1}}$ and let y be a node of T^b with $y < x_1$. As $(T', \mathcal{L}')|_{\mathcal{V}_y}$ is equal to $(T, \mathcal{L})|_{\mathcal{V}_y}$, (T', \mathcal{L}') is y -degenerate if and only if (T, \mathcal{L}) is y -degenerate.

If (T, \mathcal{L}) is y -degenerate, then (T, \mathcal{L}) is y -disjoint so that T has an edge uv such that $\mathcal{L}(T, u, v) = \mathcal{V}_y$ and v is incident with an improper y -degenerate edge. By the construction of T' , T' contains an edge $u'v'$, which corresponds to an edge uv of T , such that $\mathcal{L}'(T', u', v') = \mathcal{V}_y$ and v' is incident with an improper y -degenerate edge. So (T', \mathcal{L}') is y -disjoint and thus y -pure because (T', \mathcal{L}') is y -degenerate.

If (T, \mathcal{L}) is not y -degenerate, then all y -blocking paths and all y -guarding edges of T are proper because (T, \mathcal{L}) is y -pure. For each y -blocking path P' in (T', \mathcal{L}') , there exists the corresponding y -blocking path P in (T, \mathcal{L}) . As P' is in (T', \mathcal{L}') and P is proper, if p is the center of

P and q is the neighbor of p that is not on P , then (p, q) is not y -mixed. Thus, we can conclude that P' is proper. Similarly, it is easy to see that every y -guarding edge in (T', \mathcal{L}') is proper. This completes the proof because (T', \mathcal{L}') is not y -degenerate. \square

5 Properties of namus

In this section we review the properties of B -namus which will be pivotal for proving the correctness of Algorithm 1 and analyzing its time complexity.

5.1 Typical sequences

We review the notion of *typical sequences* proposed by Bodlaender and Kloks [1]. Let $s = a_1, a_2, \dots, a_n$ be a sequence of integers. Let $\tau(s)$ be a subsequence of s obtained by applying the following two operations as many as possible. (i) Delete a_{i+1}, \dots, a_{j-1} if there exist $i < j$ such that $a_i \leq a_k \leq a_j$ or $a_i \geq a_k \geq a_j$ for all k with $i \leq k \leq j$. (ii) Remove a_k if $a_k = a_{k+1}$ for some k . For example, if $s = 1, 2, 5, 3, 4, 2, 4, 4$, then $\tau(s) = 1, 5, 2, 4$. We say that a sequence s is *typical* if $s = \tau(s)$. The following lemmas give upper bounds for the length of a typical sequence and the number of typical sequences consisting of integers in $\{0, \dots, k\}$.

Lemma 5.1 ([1, Lemma 3.3]). *The length of a typical sequence consisting of integers in $\{0, \dots, k\}$ is at most $2k + 1$.*

5.2 Compact B -namus

In Subsection 3.1, B -namus are introduced. We will show that for a vector space B of small dimension over a finite field \mathbb{F} , each compact B -namu of width at most k has small size and the number of such B -namus is bounded by a function of k .

The authors introduced the notion of *B -trajectories* in [10], which can be seen as a linear version of B -namus related to path-decompositions. The following lemma can be easily deduced from Lemma 10 in [10], which uses Lemma 5.1.

Lemma 5.2. *Let \mathbb{F} be a field and let B be a subspace of \mathbb{F}^r of dimension θ . If Γ is a compact B -namu of width at most k , then the diameter of $T(\Gamma)$ is at most $(2\theta + 1)(2k + 1)$.*

Lemma 5.3. *Let d be an odd integer. If T is a subcubic tree of diameter at most d , then the number of edges in T is at most $2^{(d+3)/2} - 3$.*

Proof. We may assume that the diameter of T is exactly d . Let e be the middle edge in a longest path of T . There are two components in $T - e$ and each component is a rooted tree of height $(d - 1)/2$ such that each vertex has at most two children. It follows that each component of $T - e$ has at most $2 + 4 + \dots + 2^{(d-1)/2} = 2 \times (2^{(d-1)/2} - 1)$ edges. Therefore, the number of edges in T is at most

$$4 \times \left(2^{(d-1)/2} - 1\right) + 1 = 2^{(d+3)/2} - 3. \quad \square$$

Lemma 5.4. *Let \mathbb{F} be a finite field and let B be a subspace of \mathbb{F}^r of dimension θ . If Γ is a compact B -namu of width at most k , then the number of edges in $T(\Gamma)$ is at most $2^{2\theta k + \theta + k + 2} - 3$. Furthermore, the set $U_k(B)$ contains at most $f(k, \theta, |\mathbb{F}|)$ elements and can be generated from B in $g(k, \theta, |\mathbb{F}|)$ steps for some functions f and g .*

Proof. Let $\Gamma = (T, \alpha, \lambda, U) \in U_k(B)$. By Lemmas 5.2 and 5.3, the number of edges in T is at most $2^{2\theta k + \theta + k + 2} - 3$. Therefore, the number of subcubic trees on the node set $\{1, \dots, n\}$ for some $n \leq 2^{2\theta k + \theta + k + 2} - 2$ is bounded by some function of k and θ .

Let $q = |\mathbb{F}|$. Note that U is a subspace of B and there exist $\sum_{i=0}^{\theta} \binom{\theta}{i}_q$ subspaces of B where $\binom{\theta}{i}_q = \frac{(q^\theta - 1)(q^{\theta-1} - 1) \dots (q^{\theta-i+1} - 1)}{(q^i - 1)(q^{i-1} - 1) \dots (q - 1)}$ for $i \leq \theta$, which is known as Gaussian binomial coefficients.

Given a fixed ordered basis \mathfrak{B} of B , we explain how to generate all subspaces of B of dimension i in the claimed running time. A subspace B' of B with a fixed ordered basis \mathfrak{B}' can be represented a $\theta \times i$ matrix $M_{\mathfrak{B}, \mathfrak{B}'}$ over \mathbb{F} , where each column represents the coordinate vector of an element of \mathfrak{B}' with respect to \mathfrak{B} . We note that two matrices $M_{\mathfrak{B}, \mathfrak{B}'}$ and $M_{\mathfrak{B}, \mathfrak{B}''}$ represent the same subspace if and only if $M_{\mathfrak{B}, \mathfrak{B}'} = M_{\mathfrak{B}, \mathfrak{B}''} A$ for some $i \times i$ invertible matrix A over \mathbb{F} . By enumerating all possible independent columns of $M_{\mathfrak{B}, \mathfrak{B}'}$ and all $i \times i$ invertible matrices over \mathbb{F} , we get representations of distinct subspaces exactly as many as the Gaussian binomial coefficients. That is, by sieving out matrices representing the same subspace, we can obtain all (and distinct) subspaces of B as $\theta \times i$ matrices over \mathbb{F} .

We first fix a subcubic tree T on the node set $\{1, \dots, n\}$ for some integer $n \leq 2^{2\theta k + \theta + k + 2} - 2$ and fix a subspace U of B . For every incidence (v, e) in T , we assign a subspace $\alpha(v, e)$ of U . For every edge e in T , assign a nonnegative integer $\lambda(e)$ with $\lambda(e) \leq k$. For every two-edge path xyz in T , we check whether $\alpha(x, xy)$ is a subspace of $\alpha(y, yz)$. Lastly, we check whether $\lambda(e) \geq \dim(\alpha(v, e) \cap \alpha(u, e))$ for every edge $e = uv$ of T . If they hold, then (T, α, λ, U) is a B -namu.

Since the number of incidences in T and the number of subspaces of U are at most some function of k, θ, q , we conclude that $|U_k(B)|$ is at most $f(k, \theta, q)$ for some function f of k, θ, q . Also, the set $U_k(B)$ can be computed in time $g(k, \theta, q)$ for some function g of k, θ, q . \square

5.3 A sum of B -namus

In Subsection 3.3, we defined the sum of two B -namus by a (T_1, T_2) -model in a tree. We provide the missing proof that this sum is well defined.

Lemma 5.5. *Given two B -namus $\Gamma_1 = (T_1, \alpha_1, \lambda_1, U_1)$, $\Gamma_2 = (T_2, \alpha_2, \lambda_2, U_2)$, and a (T_1, T_2) -model (η_1, η_2) in a tree T^+ , we define α^+ , λ^+ , and U^+ as follows:*

- (i) $U^+ = U_1 + U_2$,
- (ii) $\alpha^+ = \alpha_1 \circ \vec{\eta}_1 + \alpha_2 \circ \vec{\eta}_2$,
- (iii) $\lambda^+(\emptyset) = 0$, and
- (iv) for all $e = uv \in E(T)$,

$$\begin{aligned} \lambda^+(e) = & \lambda_1 \circ \eta_1(e) + \lambda_2 \circ \eta_2(e) - \dim(\alpha_1(\vec{\eta}_1(v, e)) \cap \alpha_2(\vec{\eta}_2(v, e))) \\ & - \dim(\alpha_1(\vec{\eta}_1(u, e)) \cap \alpha_2(\vec{\eta}_2(u, e))) + \dim(U_1 \cap U_2). \end{aligned}$$

Then $\Gamma^+ = (T^+, \alpha^+, \lambda^+, U^+)$ is a B -namu.

Proof. It suffices to verify that $\lambda^+(e) \geq \dim(\alpha^+(u, e) \cap \alpha^+(v, e))$, which is the fourth condition

of the definition of a B -namu. By Lemma 4.3,

$$\begin{aligned}
& \dim(\alpha^+(u, e) \cap \alpha^+(v, e)) \\
&= \dim\left(\left(\alpha_1(\vec{\eta}_1(u, e)) + \alpha_2(\vec{\eta}_2(u, e))\right) \cap \left(\alpha_1(\vec{\eta}_1(v, e)) + \alpha_2(\vec{\eta}_2(v, e))\right)\right) \\
&= \dim(\alpha_1(\vec{\eta}_1(u, e)) \cap \alpha_1(\vec{\eta}_1(v, e))) + \dim(\alpha_2(\vec{\eta}_2(u, e)) \cap \alpha_2(\vec{\eta}_2(v, e))) \\
&\quad - \dim(\alpha_1(\vec{\eta}_1(u, e)) \cap \alpha_2(\vec{\eta}_2(u, e))) - \dim(\alpha_1(\vec{\eta}_1(v, e)) \cap \alpha_2(\vec{\eta}_2(v, e))) \\
&\quad + \dim\left(\left(\alpha_1(\vec{\eta}_1(u, e)) + \alpha_1(\vec{\eta}_1(v, e))\right) \cap \left(\alpha_2(\vec{\eta}_2(u, e)) + \alpha_2(\vec{\eta}_2(v, e))\right)\right),
\end{aligned}$$

and hence,

$$\begin{aligned}
& \lambda^+(e) - \dim(\alpha^+(u, e) \cap \alpha^+(v, e)) \\
&\geq \lambda_1(\eta_1(e)) \\
&\quad - \dim(\alpha_1(\vec{\eta}_1(u, e)) \cap \alpha_1(\vec{\eta}_1(v, e))) + \lambda_2(\eta_2(e)) - \dim(\alpha_2(\vec{\eta}_2(u, e)) \cap \alpha_2(\vec{\eta}_2(v, e))) \\
&\quad + \dim(U_1 \cap U_2) - \dim\left(\left(\alpha_1(\vec{\eta}_1(u, e)) + \alpha_1(\vec{\eta}_1(v, e))\right) \cap \left(\alpha_2(\vec{\eta}_2(u, e)) + \alpha_2(\vec{\eta}_2(v, e))\right)\right) \\
&\geq 0. \quad \square
\end{aligned}$$

For algorithms, it is necessary to bound the size of the set $\Gamma_1 \oplus \Gamma_2$. For this, the next lemma places an upper bound on the size of a sum of two B -namus.

Lemma 5.6. *Let T_1 , T_2 , and T be three subcubic trees. If there exists a (T_1, T_2) -model in T , then*

$$|V(T)| = \begin{cases} |V(T_1)| + |V(T_2)| + 2 & \text{if } |V(T_1)| \geq 2, |V(T_2)| \geq 2, \\ |V(T_1)| + |V(T_2)| & \text{if } |V(T_1)| = 1, |V(T_2)| = 1, \\ |V(T_1)| + |V(T_2)| + 1 & \text{otherwise.} \end{cases}$$

Proof. It is trivial if $|V(T_1)| = 1$ or $|V(T_2)| = 1$. So we may assume $|V(T_1)| \geq 2$, $|V(T_2)| \geq 2$. Let (η_1, η_2) be a (T_1, T_2) -model in T . By condition (ii) of a (T_1, T_2) -model, the number of degree-1 nodes in T is $|A(T_1)| + |A(T_2)|$. Since T is subcubic, T contains $|A(T_1)| + |A(T_2)| - 2$ nodes of degree 3. Every degree-2 node in T is a branch node in exactly one of η_1 and η_2 by condition (iii), and thus the number of degree-2 nodes in T is $|V(T_1)| - |A(T_1)| - (|A(T_1)| - 2) + |V(T_2)| - |A(T_2)| - (|A(T_2)| - 2)$. To sum up, we have

$$|V(T)| = |V(T_1)| + |V(T_2)| + 2. \quad \square$$

Using Lemma 5.6, we can bound the size of the set $\Gamma_1 \oplus \Gamma_2$ for the sets of compact B -namus.

Lemma 5.7. *Let B be a subspace of \mathbb{F}^r of dimension at most θ and let Γ_1, Γ_2 be compact B -namus of width at most k . Then the set $\Gamma_1 \oplus \Gamma_2$ contains at most $2^{2(2\theta k + \theta + k + 3)}$ B -namus. Furthermore, the number of sum operations needed to generate the set $\Gamma_1 \oplus \Gamma_2$ is bounded by a function depending only on θ and k .*

Proof. For each $i = 1, 2$, let $\Gamma_i = (T_i, \alpha_i, \lambda_i, U_i)$ and n_i be the number of leaves of T_i . By Lemma 5.4, T_i has at most $2^{2\theta k + \theta + k + 2} - 2$ nodes and therefore

$$n_i \leq 2^{2\theta k + \theta + k + 1},$$

because $2n_i - 2 \leq |V(T_i)|$ as T_i is subcubic. If $n_1 = 1$ or $n_2 = 1$, then it is trivial. So let us assume that $n_1 > 1$ and $n_2 > 1$.

To enumerate all $\Gamma = (T, \alpha, \lambda, U) \in \Gamma_1 \oplus \Gamma_2$, we will enumerate all subcubic trees T on $|V(T_1)| + |V(T_2)| + 2$ labeled nodes with $n_1 + n_2$ labeled leaves. Then we map the first n_1 leaves of T to the leaves of T_1 in the given order and the last n_2 leaves of T to the leaves of T_2 . If this mapping of leaves induces a (T_1, T_2) -model (η_1, η_2) in T , then compute Γ so that (η_1, η_2) co-extends Γ_1 and Γ_2 to Γ .

Observe that T has precisely $|V(T_1)| + |V(T_2)| + 2 \leq 2^{2\theta k + \theta + k + 3} - 2$ nodes by Lemma 5.6. There are at most $F(\theta, k)$ labeled subcubic trees with $|V(T_1)| + |V(T_2)| + 2$ nodes and exactly $n_1 + n_2$ leaves for some function $F(\theta, k)$. (As the number of n -node labeled trees is n^{n-2} , $F(\theta, k) \leq (2^{2\theta k + \theta + k + 3} - 2)^{2^{2\theta k + \theta + k + 3} - 4}$ trivially.) We try to map the first n_1 leaves (in the ordering of node labels) of T to the leaves of T_1 by η_1 and the other n_2 leaves of T to the leaves of T_2 by η_2 and check if this induces a (T_1, T_2) -model. Thus, the number of B -namus in $\Gamma_1 \oplus \Gamma_2$ is at most

$$F(\theta, k) < 2^{(2\theta k + \theta + k + 3)2^{2\theta k + \theta + k + 3}} \leq 2^{2^{2(2\theta k + \theta + k + 3)}}.$$

Clearly $\Gamma_1 \oplus \Gamma_2$ can be generated in time depending only on θ and k by following the steps of this proof. \square

Lemma 5.8. *Let Γ_1 and Γ_2 be two B -namus and $\Gamma \in \Gamma_1 \oplus \Gamma_2$. Then the width of Γ_1 is at most the width of Γ .*

Proof. Let $\Gamma = (T, \alpha, \lambda, U)$, $\Gamma_1 = (T_1, \alpha_1, \lambda_1, U_1)$, and $\Gamma_2 = (T_2, \alpha_2, \lambda_2, U_2)$. We may assume that $|V(T_1)| > 1$ or $|V(T_2)| > 1$. Let (η_1, η_2) be a (T_1, T_2) -model in T co-extending Γ_1 and Γ_2 to Γ . Then for each edge f of T_1 , T has an edge $e = uv$ such that $\eta_1(e) = f$. It is enough to show that $\lambda_1(f) \leq \lambda(e)$. Since $\alpha = \alpha_1 \circ \vec{\eta}_1 + \alpha_2 \circ \vec{\eta}_2$, by Lemma 4.3, we obtain

$$\begin{aligned} & \dim \alpha(u, e) \cap \alpha(v, e) \\ &= \dim \alpha_1(\vec{\eta}_1(u, e)) \cap \alpha_1(\vec{\eta}_1(v, e)) + \dim \alpha_2(\vec{\eta}_2(u, e)) \cap \alpha_2(\vec{\eta}_2(v, e)) \\ & \quad - \dim \alpha_1(\vec{\eta}_1(u, e)) \cap \alpha_2(\vec{\eta}_2(u, e)) - \dim \alpha_1(\vec{\eta}_1(v, e)) \cap \alpha_2(\vec{\eta}_2(v, e)) \\ & \quad + \dim(\alpha_1(\vec{\eta}_1(u, e)) + \alpha_1(\vec{\eta}_1(v, e))) \cap (\alpha_2(\vec{\eta}_2(u, e)) + \alpha_2(\vec{\eta}_2(v, e))). \end{aligned}$$

After rearranging terms, we have

$$\begin{aligned} \lambda(e) &= \lambda_1(\eta_1(e)) + \lambda_2(\eta_2(e)) - \dim \alpha_1(\vec{\eta}_1(v, e)) \cap \alpha_2(\vec{\eta}_2(v, e)) \\ & \quad - \dim \alpha_1(\vec{\eta}_1(u, e)) \cap \alpha_2(\vec{\eta}_2(u, e)) + \dim U_1 \cap U_2 \\ &= \lambda_1(\eta_1(e)) \\ & \quad + \dim \alpha(u, e) \cap \alpha(v, e) - \dim \alpha_1(\vec{\eta}_1(u, e)) \cap \alpha_1(\vec{\eta}_1(v, e)) \\ & \quad + \lambda_2(\eta_2(e)) - \dim \alpha_2(\vec{\eta}_2(u, e)) \cap \alpha_2(\vec{\eta}_2(v, e)) + \dim U_1 \cap U_2 \\ & \quad - \dim(\alpha_1(\vec{\eta}_1(u, e)) + \alpha_1(\vec{\eta}_1(v, e))) \cap (\alpha_2(\vec{\eta}_2(u, e)) + \alpha_2(\vec{\eta}_2(v, e))) \\ &\geq \lambda_1(\eta_1(e)) = \lambda_1(f). \end{aligned} \quad \square$$

Lemma 5.9. *Let \mathcal{V}_1 and \mathcal{V}_2 be subspace arrangements of subspaces of \mathbb{F}^r . Let (T, \mathcal{L}) be a branch-decomposition of $\mathcal{V}_1 \dot{\cup} \mathcal{V}_2$ and let $(T_i, \mathcal{L}_i) = (T, \mathcal{L})|_{\mathcal{V}_i}$ for $i = 1, 2$. If η_1 is a T_1 -model in T and η_2 is a T_2 -model in T , then (η_1, η_2) is a (T_1, T_2) -model in T .*

Proof. Clearly, the set of all leaves $A(T)$ is a disjoint union of $\vec{\eta}_1(A(T_1))$ and $\vec{\eta}_2(A(T_2))$ since \mathcal{L} is a bijection from $A(T)$ to $\mathcal{V}_1 \dot{\cup} \mathcal{V}_2$. Hence, (i) in the definition of a (T_1, T_2) -model is satisfied. Note that T does not have a node of degree 2, and each leaf v is a leaf in exactly one of η_1 and η_2 due to (i). Therefore, (ii) is trivial. See Figure 10 for an illustration. \square

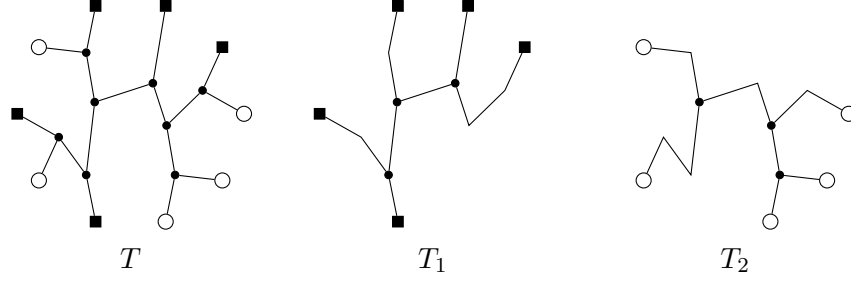

Figure 10: Constructing T_1 and T_2 in the proof of Lemma 5.9. ■ represents a leaf node mapped to an element of \mathcal{V}_1 by \mathcal{L} and ○ represents a leaf node mapped to an element of \mathcal{V}_2 by \mathcal{L} .

Lemma 5.10 ([10, Lemma 3.17]). *Let \mathcal{V}_1 and \mathcal{V}_2 be subspace arrangements of subspaces of \mathbb{F}^r , and let B be a subspace of \mathbb{F}^r . If $(\langle \mathcal{V}_1 \rangle + B) \cap (\langle \mathcal{V}_2 \rangle + B) = B$, then*

$$(X \cap B) + (Y \cap B) = (X + Y) \cap B$$

for every subspace X of $\langle \mathcal{V}_1 \rangle$ and every subspace Y of $\langle \mathcal{V}_2 \rangle$.

Lemma 5.11. *Let \mathcal{V}_1 and \mathcal{V}_2 be subspace arrangements of subspaces of \mathbb{F}^r and B be a subspace of \mathbb{F}^r . Let Δ be the canonical B -namu of a branch-decomposition (T, \mathcal{L}) of $\mathcal{V}_1 \dot{\cup} \mathcal{V}_2$, and for $i = 1, 2$, let Δ_i be the canonical B -namu of $(T_i, \mathcal{L}_i) = (T, \mathcal{L})|_{\mathcal{V}_i}$. If $(\langle \mathcal{V}_1 \rangle + B) \cap (\langle \mathcal{V}_2 \rangle + B) = B$, then Δ is a sum of Δ_1 and Δ_2 . Furthermore, $\Delta = \Delta_1 +_{(\eta_1, \eta_2)} \Delta_2$ if η_i is the T_i -model in T for $i = 1, 2$.*

Proof. Let $\Delta = (T, \alpha, \lambda, U)$ and $\Delta_i = (T_i, \alpha_i, \lambda_i, U_i)$ for $i = 1, 2$. Let η_i be a T_i -model in T for $i = 1, 2$. By Lemma 5.9, (η_1, η_2) is a (T_1, T_2) -model in T . Let $\Delta^+ = (T, \alpha^+, \lambda^+, U^+)$ be a B -namu such that (η_1, η_2) co-extends Δ_1 and Δ_2 to Δ^+ . That is,

$$\begin{aligned} \alpha^+ &= \alpha_1 \circ \vec{\eta}_1 + \alpha_2 \circ \vec{\eta}_2, \\ U^+ &= U_1 + U_2, \\ \lambda^+(\emptyset) &= 0, \quad \text{and} \\ \lambda^+(e) &= \lambda_1(\eta_1(e)) + \lambda_2(\eta_2(e)) + \dim(U_1 \cap U_2) \\ &\quad - \dim(\alpha_1(\vec{\eta}_1(v, e)) \cap \alpha_2(\vec{\eta}_2(v, e))) - \dim(\alpha_1(\vec{\eta}_1(u, e)) \cap \alpha_2(\vec{\eta}_2(u, e))) \end{aligned}$$

for all $e = uv \in E(T)$.

The proof is completed by showing that $\Delta^+ = \Delta$. First, by Lemma 5.10,

$$U = B \cap \sum_{X \in \mathcal{V}_1 \dot{\cup} \mathcal{V}_2} X = B \cap \sum_{X \in \mathcal{V}_1} X + B \cap \sum_{X \in \mathcal{V}_2} X = U_1 + U_2 = U^+.$$

Note that here we use the assumption that $(\langle \mathcal{V}_1 \rangle + B) \cap (\langle \mathcal{V}_2 \rangle + B) = B$ to apply Lemma 5.10.

Second, let us prove that $\alpha(v, e) = \alpha^+(v, e)$ for each incidence (v, e) of T . Observe that

$$\begin{aligned} \alpha(v, e) &= B \cap \sum_{x \in A_v(T-e)} \mathcal{L}(x) = B \cap \left(\sum_{\substack{x \in A_v(T-e) \\ \mathcal{L}(x) \in \mathcal{V}_1}} \mathcal{L}(x) + \sum_{\substack{x \in A_v(T-e) \\ \mathcal{L}(x) \in \mathcal{V}_2}} \mathcal{L}(x) \right) \\ &= B \cap \sum_{\substack{x \in A_v(T-e) \\ \mathcal{L}(x) \in \mathcal{V}_1}} \mathcal{L}(x) + B \cap \sum_{\substack{x \in A_v(T-e) \\ \mathcal{L}(x) \in \mathcal{V}_2}} \mathcal{L}(x) \quad \text{by Lemma 5.10.} \end{aligned}$$

To complete the proof for this case, we claim that for each $i \in \{1, 2\}$,

$$\alpha_i(\eta_i(v, e)) = B \cap \sum_{\substack{x \in A_v(T-e) \\ \mathcal{L}(x) \in \mathcal{V}_i}} \mathcal{L}(x).$$

Let u be the end of e other than v . If $\vec{\eta}_i(v, e) = (0, \emptyset)$, then there is no $x \in A_v(T-e)$ such that $\mathcal{L}(x) \in \mathcal{V}_i$ and therefore $B \cap \sum_{\substack{x \in A_v(T-e) \\ \mathcal{L}(x) \in \mathcal{V}_i}} \mathcal{L}(x) = \{0\} = \alpha_i(0, \emptyset)$. If $\vec{\eta}_i(v, e) = (*, \emptyset)$, then $A_v(T-e)$ contains every leaf mapped to a member of \mathcal{V}_i and so $B \cap \sum_{\substack{x \in A_v(T-e) \\ \mathcal{L}(x) \in \mathcal{V}_i}} \mathcal{L}(x) = B \cap \sum_{X \in \mathcal{V}_i} X = U_i = \alpha(*, \emptyset)$. If $\eta_i(e) \neq \emptyset$, then say $\vec{\eta}_i(v, e) = (v', e')$. We can rewrite

$$\alpha_i(\vec{\eta}_i(v, e)) = B \cap \sum_{x \in A_{v'}(T_i - e')} \mathcal{L}_i(x) = B \cap \sum_{x \in A_{v'}(T_i - e')} \mathcal{L}(x) = B \cap \sum_{\substack{x \in A_v(T-e) \\ \mathcal{L}(x) \in \mathcal{V}_i}} \mathcal{L}(x).$$

This proves the claim and so we conclude that

$$\alpha = \alpha_1 \circ \vec{\eta}_1 + \alpha_2 \circ \vec{\eta}_2 = \alpha^+.$$

Finally, let us prove that $\lambda(e) = \lambda^+(e)$ for each edge e of T . Suppose $\eta_1(e) \neq \emptyset$ and $\eta_2(e) \neq \emptyset$. Let u, v be the ends of e and let $(v_i, e_i) = \vec{\eta}_i(v, e)$, $(u_i, e_i) = \vec{\eta}_i(u, e)$ for $i = 1, 2$ where e_i is an edge of T_i and v_i, u_i are two ends of e_i . For $i = 1, 2$, let

$$\begin{aligned} L_i &= \sum_{\substack{x \in A_v(T-e) \\ \mathcal{L}(x) \in \mathcal{V}_i}} \mathcal{L}_i(x), & R_i &= \sum_{\substack{x \in A_u(T-e) \\ \mathcal{L}(x) \in \mathcal{V}_i}} \mathcal{L}_i(x), \\ L'_i &= \sum_{x \in A_{v_i}(T_i - e_i)} \mathcal{L}_i(x), & R'_i &= \sum_{x \in A_{u_i}(T_i - e_i)} \mathcal{L}_i(x). \end{aligned}$$

Note that $L_i = L'_i$, $R_i = R'_i$, and $L_i, R_i \subseteq \langle \mathcal{V}_i \rangle$ for $i = 1, 2$. Also, we have $L_1 \cap L_2 \subseteq (L_1 + R_1) \cap (L_2 + R_2) \subseteq (\langle \mathcal{V}_1 \rangle + B) \cap (\langle \mathcal{V}_2 \rangle + B) = B$. Then by Lemma 4.3

$$\begin{aligned} \lambda(e) &= \dim((L_1 + L_2) \cap (R_1 + R_2)) \\ &= \dim(L_1 \cap R_1) + \dim(L_2 \cap R_2) - \dim(L_1 \cap L_2) - \dim(R_1 \cap R_2) \\ &\quad + \dim((L_1 + R_1) \cap (L_2 + R_2)) \\ &= \lambda_1(e_1) + \lambda_2(e_2) - \dim(L'_1 \cap L'_2 \cap B) - \dim(R'_1 \cap R'_2 \cap B) \\ &\quad + \dim((L'_1 + R'_1) \cap (L'_2 + R'_2) \cap B) \\ &= \lambda_1(e_1) + \lambda_2(e_2) - \dim(\alpha_1(v_1, e_1) \cap \alpha_2(v_2, e_2)) - \dim(\alpha_1(u_1, e_1) \cap \alpha_2(u_2, e_2)) \\ &\quad + \dim(U_1 \cap U_2) \\ &= \lambda^+(e). \end{aligned}$$

Suppose exactly one of $\eta_1(e)$ or $\eta_2(e)$ is \emptyset . Without loss of generality, we assume that $\eta_1(e) = \emptyset$. Let $\eta_1(v, e) = (*, \emptyset)$, $\eta_1(u, e) = (0, \emptyset)$, $\eta_2(v, e) = (v_2, e_2)$, and $\eta_2(u, e) = (u_2, e_2)$. We define $L''_1 = \sum_{x \in A(T)} \mathcal{L}(x)$, $R''_1 = \emptyset$, and let $L_1, R_1, L_2, L'_2, R_2, R'_2$ as above so that $L_1 = L''_1$, $R_1 = R''_1$, $L_2 = L'_2$, and $R_2 = R'_2$. Note that $\lambda_1(\eta_1(e)) = \lambda_1(\emptyset) = 0$, $\alpha_1(\vec{\eta}_1(u, e)) = \{0\}$ and

$L''_1, R''_1 \subseteq \langle \mathcal{V}_1 \rangle$. Then by Lemma 4.3

$$\begin{aligned}
\lambda(e) &= \dim((L_1 + L_2) \cap (R_1 + R_2)) \\
&= \dim(L_1 \cap R_1) + \dim(L_2 \cap R_2) - \dim(L_1 \cap L_2) - \dim(R_1 \cap R_2) \\
&\quad + \dim((L_1 + R_1) \cap (L_2 + R_2)) \\
&= \dim(L''_1 \cap R''_1) + \dim(L'_2 \cap R'_2) - \dim(L''_1 \cap L'_2) - \dim(R''_1 \cap R'_2) \\
&\quad + \dim((L''_1 + R''_1) \cap (L'_2 + R'_2)) \\
&= \dim(L'_2 \cap R'_2) - \dim(L''_1 \cap L'_2 \cap B) + \dim((L''_1 + R''_1) \cap (L'_2 + R'_2) \cap B) \\
&= \lambda_2(e_2) - \dim(\alpha_1(v_1, e_1) \cap \alpha_2(v_2, e_2)) + \dim(U_1 \cap U_2) \\
&= \lambda_1(\eta_1(e)) + \lambda_2(\eta_2(e)) - \dim(\alpha_1(\vec{\eta}_1(v, e)) \cap \alpha_2(\vec{\eta}_2(v, e))) \\
&\quad - \dim(\alpha_1(\vec{\eta}_1(u, e)) \cap \alpha_2(\vec{\eta}_2(u, e))) + \dim(U_1 \cap U_2) \\
&= \lambda^+(e).
\end{aligned}$$

Suppose $\eta_1(e) = \eta_2(e) = \emptyset$. If $\eta_i(e) = \emptyset$ for some $i = 1, 2$, then all leaves x of T with $\mathcal{L}(x) \in \mathcal{V}_i$ are in one component of $T - e$. As $A(T)$ is the disjoint union of $\vec{\eta}_1(A(T_1))$ and $\vec{\eta}_2(A(T_2))$ for two ends u, v of e , we may assume that all elements in \mathcal{V}_1 are mapped from the leaves in the component of $T - e$ containing u and all elements in \mathcal{V}_2 are mapped from the leaves in the component of $T - e$ containing v . Then $\lambda_1(\eta_1(e)) = \lambda_2(\eta_2(e)) = 0$, and $\alpha(\vec{\eta}_1(v, e)) = \alpha(\vec{\eta}_2(u, e)) = \{0\}$. Thus, $\lambda^+ = \lambda_1(\eta_1(e)) + \lambda_2(\eta_2(e)) - \dim(\alpha_1(\vec{\eta}_1(v, e)) \cap \alpha_2(\vec{\eta}_2(v, e))) - \dim(\alpha_1(\vec{\eta}_1(u, e)) \cap \alpha_2(\vec{\eta}_2(u, e))) + \dim(U_1 \cap U_2) = \dim(U_1 \cap U_2) = \lambda(e)$. This completes the proof. \square

5.4 Comparing two B -namus

The following lemmas are trivial by definitions.

Lemma 5.12. *The binary relations \leq and \preceq on B -namus are transitive.*

Lemma 5.13. *If $\Gamma_1 \preceq \Gamma_2$, then the width of Γ_1 is at most the width of Γ_2 .*

The following lemma is analogous to Lemma 3.9 of [1].

Lemma 5.14. *If Γ is a B -namu, then $\tau(\Gamma) \preceq \text{trim}(\Gamma)$ and $\text{trim}(\Gamma) \preceq \tau(\Gamma)$.*

Lemma 5.15. *If $\Gamma_1 \preceq \Gamma_2$, then $\text{trim}(\Gamma_1) \preceq \text{trim}(\Gamma_2)$.*

Proof. It is enough to prove that if $\Gamma_1^* = (T_1^*, \alpha_1^*, \lambda_1^*, U)$ and $\Gamma_2^* = (T_2^*, \alpha_2^*, \lambda_2^*, U)$ are subdivisions of Γ_1 and Γ_2 , respectively, such that $\Gamma_1^* \leq \Gamma_2^*$, then $\text{trim}(\Gamma_1) \preceq \text{trim}(\Gamma_2)$. It is easy to see that $\text{trim}(\Gamma_1^*) \leq \text{trim}(\Gamma_2^*)$ because $T_1^* = T_2^*$ and $\alpha_1^* = \alpha_2^*$.

We will show that $\text{trim}(\Gamma_1^*)$ is a subdivision of $\text{trim}(\Gamma_1)$. Let $\eta^* = T_1^*$ be a $T(\Gamma_1)$ -model in T_1^* . Let $\text{trim}(\Gamma_1^*) = (T'_1, \alpha'_1, \lambda'_1, U)$ and $\text{trim}(\Gamma_1) = (T_1, \alpha_1, \lambda_1, U)$. Let η be a function defined on $E(T'_1) \cup \{\emptyset\}$ by $\eta(e) = \eta^*(e)$. It is enough to show that η is a T_1 -model in T'_1 . In other words, if e is an edge of T'_1 , then $\eta^*(e)$ is an edge of T_1 . Suppose not. If $\eta^*(e)$ is not an edge of T_1 , then it is removed by trimming Γ_1 . Since Γ_1^* is a subdivision of Γ_1 , the edge e , as an edge of T_1^* , is also removed by trimming Γ_1^* . This contradicts the fact that e is an edge of T'_1 , which is the tree in $\text{trim}(\Gamma_1^*)$. Therefore, $\text{trim}(\Gamma_1^*)$ is a subdivision of $\text{trim}(\Gamma_1)$ and similarly $\text{trim}(\Gamma_2^*)$ is a subdivision of $\text{trim}(\Gamma_2)$. So $\text{trim}(\Gamma_1) \preceq \text{trim}(\Gamma_2)$ because $\text{trim}(\Gamma_1^*) \leq \text{trim}(\Gamma_2^*)$. \square

Let us discuss the time complexity when we check whether $\Delta \preceq \Gamma$ for given two B -namus Δ and Γ . It can be checked in time $f(|V(T(\Delta))|, |V(T(\Gamma))|, \dim(B), |\mathbb{F}|)$ for some function f . The following lemma gives the upper bound of the size of a subdivision of Γ .

Lemma 5.16. *Let Γ_1 and Γ_2 be two B -namus. If $\Gamma_1 \preceq \Gamma_2$, then there exist a B -namu Γ_1^* isomorphic to a subdivision of Γ_1 and a B -namu Γ_2^* isomorphic to a subdivision of Γ_2 satisfying that $\Gamma_1^* \leq \Gamma_2^*$ and*

$$|V(T(\Gamma_1^*))| \leq |V(T(\Gamma_1))| + |V(T(\Gamma_2))| + 2.$$

Proof. We may assume that both $T(\Gamma_1)$ and $T(\Gamma_2)$ have at least one edge. We may assume that there exist a subdivision $\Gamma_1^* = (T, \alpha_1, \lambda_1, U_1)$ of Γ_1 and a subdivision $\Gamma_2^* = (T, \alpha_2, \lambda_2, U_2)$ of Γ_2 such that $\Gamma_1^* \leq \Gamma_2^*$. Assume that $|E(T)|$ is chosen to be minimum. Let $T_1 = T(\Gamma_1)$ and $T_2 = T(\Gamma_2)$. Let η_1 be a T_1 -model in T extending Γ_1 to Γ_1^* and let η_2 be a T_2 -model in T extending Γ_2 to Γ_2^* .

We first claim that there exists no edge e of T such that $\eta_1(e) = \eta_2(e) = \emptyset$ and e is incident with some leaf ℓ of T . Suppose not. Let Γ'_1 be a B -namu $(T - \ell, \alpha'_1, \lambda'_1, U_1)$ where $\alpha'_1(v, f) = \alpha_1(v, f)$ for all incidences (v, f) of $T - \ell$ and $\lambda'_1(f) = \lambda_1(f)$ for all edges f of $T - \ell$. Similarly, we define Γ'_2 . Then Γ'_1 is a subdivision of Γ_1 and Γ'_2 is a subdivisions of Γ_2 satisfying that $\Gamma'_1 \leq \Gamma'_2$. It is a contradiction because $|E(T)|$ is chosen to be minimum. Thus, we may assume that there is no such edge in T .

We also claim that there exist no two edges e_1, e_2 of T such that $\eta_1(e_1) = \eta_1(e_2), \eta_2(e_1) = \eta_2(e_2)$, and e_1, e_2 share a degree-2 node. Suppose not. Let Γ''_1 be a B -namu $(T/e_2, \alpha''_1, \lambda''_1, U_1)$ where $\alpha''_1(v, f) = \alpha_1(v, f)$ for all incidences (v, f) of T/e_2 and $\lambda''_1(f) = \lambda_1(f)$ for all edges f of T/e_2 . Similarly, we define Γ''_2 . Then Γ''_1 is a subdivision of Γ_1 and Γ''_2 is a subdivision of Γ_2 satisfying that $\Gamma''_1 \leq \Gamma''_2$. It is a contradiction because $|E(T)|$ is chosen to be minimum. Thus, we may assume that there are no such two edges in T .

By the first claim, we deduce that $|A(T)| \leq |A(T_1)| + |A(T_2)|$. Note that for a subcubic tree T , the number of degree-3 nodes in T is $|A(T)| - 2$. By the second claim, every degree-2 node of T is a branch node in η_1 or a branch node in η_2 . Since the number of degree-2 nodes in T_i is $|V(T_i)| - |A(T_i)| - (|A(T_i)| - 2)$ for $i = 1, 2$, the number of degree-2 nodes in T is at most

$$|V(T_1)| + |V(T_2)| - 2|A(T_1)| - 2|A(T_2)| + 4.$$

Thus, the number of nodes in T is at most

$$\begin{aligned} & (|A(T_1)| + |A(T_2)|) + (|V(T_1)| + |V(T_2)| - 2|A(T_1)| - 2|A(T_2)| + 4) \\ & \quad + (|A(T_1)| + |A(T_2)| - 2) = |V(T_1)| + |V(T_2)| + 2. \quad \square \end{aligned}$$

For two B -namus Γ_1 and Γ_2 with $\Gamma_1 \preceq \Gamma_2$, we say that the tree $T(\Gamma_1^*)$ in Lemma 5.16 *ensures* $\Gamma_1 \preceq \Gamma_2$.

Let \mathbb{F} be a fixed finite field and B be a subspace of \mathbb{F}^r . For given two B -namus Δ and Γ , in order to check whether $\Delta \preceq \Gamma$, we need to find a B -namu Δ^* isomorphic to a subdivision of Δ and a B -namu Γ^* isomorphic to a subdivision of Γ such that $\Delta^* \leq \Gamma^*$. By Lemma 5.16, it is enough to consider finitely many subdivisions of Δ and Γ . Thus, the number of comparison operations needed to check whether $\Delta \preceq \Gamma$ is bounded by some function of $|V(T(\Delta))|, |V(T(\Gamma))|, \dim(B)$, and $|\mathbb{F}|$.

Lemma 5.17. *Let \mathbb{F} be a finite field, let r be a positive integer, and let B be a subspace of \mathbb{F}^r . For two B -namus Δ and Γ , we can decide whether $\Delta \preceq \Gamma$ by executing at most*

$f(|V(T(\Delta))|, |V(T(\Gamma))|, \dim(B), |\mathbb{F}|)$ comparison operations (on integers and on subspaces of B) for some function f .

Proposition 5.18. *Let $\Gamma_1, \Gamma_2, \Gamma'_1$ and Γ'_2 be B -namus. If $\Gamma'_1 \preceq \Gamma_1$ and $\Gamma'_2 \preceq \Gamma_2$, then for every $\Gamma \in \Gamma_1 \oplus \Gamma_2$, there exists $\Gamma' \in \Gamma'_1 \oplus \Gamma'_2$ such that $\Gamma' \preceq \Gamma$.*

To prove this proposition, we use the following lemmas.

Lemma 5.19. *Let $\Gamma_1, \Gamma'_1, \Gamma_2$ be B -namus such that $\Gamma'_1 \leq \Gamma_1$. If $\Gamma_1 +_{(\eta_1, \eta_2)} \Gamma_2$ is the sum of Γ_1 and Γ_2 by (η_1, η_2) , then $\Gamma'_1 +_{(\eta_1, \eta_2)} \Gamma_2$ is well defined and $\Gamma'_1 +_{(\eta_1, \eta_2)} \Gamma_2 \leq \Gamma_1 +_{(\eta_1, \eta_2)} \Gamma_2$.*

Proof. Let $\Gamma_1 = (T_1, \alpha_1, \lambda_1, U_1)$ and $\Gamma'_1 = (T'_1, \alpha'_1, \lambda'_1, U_1)$. From $\Gamma_1 \leq \Gamma'_1$, we may assume that $T_1 = T'_1$ and $\alpha_1 = \alpha'_1$. Let $T_2 = T(\Gamma_2)$. Then (η_1, η_2) is a (T'_1, T_2) -model in T as well. Thus, $\Gamma'_1 +_{(\eta_1, \eta_2)} \Gamma_2$ is well defined.

By Lemma 5.5 and the fact that $\lambda'_1(e) \leq \lambda_1(e)$ for all edges e of $T_1 = T'_1$, it is easy to check that $\Gamma'_1 +_{(\eta_1, \eta_2)} \Gamma_2 \leq \Gamma_1 +_{(\eta_1, \eta_2)} \Gamma_2$. \square

Lemma 5.20. *Let Γ_1, Γ_2 be B -namus and Γ'_1 be a subdivision of Γ_1 . Then for every sum Γ of Γ_1 and Γ_2 , there is a sum Γ' of Γ'_1 and Γ_2 such that Γ' is a subdivision of Γ .*

Proof. Let $\Gamma_1 = (T_1, \alpha_1, \lambda_1, U_1)$, $\Gamma_2 = (T_2, \alpha_2, \lambda_2, U_2)$, $\Gamma'_1 = (T'_1, \alpha'_1, \lambda'_1, U'_1)$. See Figure 11 for a diagram. We use induction on $|V(T'_1)| - |V(T_1)|$. If $|V(T'_1)| = |V(T_1)|$, then it is trivial. We may assume that Γ'_1 is obtained from Γ_1 by subdividing one edge v_1v_3 of T_1 . Let v_2 be the new node of T'_1 created by subdividing v_1v_3 . Let $\Gamma = \Gamma_1 +_{(\eta_1, \eta_2)} \Gamma_2 = (T, \alpha, \lambda, U)$. Let u_1u_3 be an edge of T such that $\eta_1(u_1u_3) = v_1v_3$. Let T' be a subdivision of T obtained by subdividing u_1u_3 once, and denote by u_2 the new node.

Let us define functions $\rho_1 : E(T') \cup \{\emptyset\} \rightarrow E(T'_1) \cup \{\emptyset\}$ and $\rho_2 : E(T') \cup \{\emptyset\} \rightarrow E(T'_2) \cup \{\emptyset\}$ as follows.

$$\rho_1(e) = \begin{cases} v_1v_2 & \text{if } e = u_1u_2, \\ v_2v_3 & \text{if } e = u_2u_3, \\ \eta_1(e) & \text{otherwise,} \end{cases} \quad \text{and} \quad \rho_2(e) = \begin{cases} \eta_2(u_1u_3) & \text{if } e = u_1u_2 \text{ or } e = u_2u_3, \\ \eta_2(e) & \text{otherwise.} \end{cases}$$

We claim that (ρ_1, ρ_2) is a (T'_1, T_2) -model in T' . Since (η_1, η_2) is a (T_1, T_2) -model in T , it is enough to check the third condition for u_2 whose degree is 2 in T' . It is also clear because u_2 is a branch node in η'_1 but not in η'_2 .

The proof is completed by proving that the sum $\Gamma' = (T', \alpha', \lambda', U')$ of Γ'_1 and Γ_2 by (ρ_1, ρ_2) is a subdivision of Γ . It is clear that $\alpha'(v, e) = \alpha(v, e)$ and $\lambda'(e) = \lambda(e)$ if e is neither u_1u_2 nor u_2u_3 . We claim that $\alpha'(u_1, u_1u_2) = \alpha'(u_2, u_2u_3) = \alpha(u_1, u_1u_3)$ and $\lambda'(u_1u_2) = \lambda'(u_2u_3) = \lambda(u_1u_3)$. We observe that

$$\begin{aligned} \alpha'(u_1, u_1u_2) &= \alpha'_1(\vec{\rho}_1(u_1, u_1u_2)) + \alpha_2(\vec{\rho}_2(u_1, u_1u_2)) \\ &= \alpha'_1(v_1, v_1v_2) + \alpha_2(\vec{\eta}_2(u_1, u_1u_3)) \\ &= \alpha_1(v_1, v_1v_3) + \alpha_2(\vec{\eta}_2(u_1, u_1u_3)), \\ \alpha'(u_2, u_2u_3) &= \alpha'_1(\vec{\rho}_1(u_2, u_2u_3)) + \alpha_2(\vec{\rho}_2(u_2, u_2u_3)) \\ &= \alpha'_1(v_2, v_2v_3) + \alpha_2(\vec{\eta}_2(u_1, u_1u_3)) \\ &= \alpha_1(v_1, v_1v_3) + \alpha_2(\vec{\eta}_2(u_1, u_1u_3)), \quad \text{and} \\ \alpha_1(v_1, v_1v_3) + \alpha_2(\vec{\eta}_2(u_1, u_1u_3)) &= \alpha_1(\vec{\eta}_1(u_1, u_1u_3)) + \alpha_2(\vec{\eta}_2(u_1, u_1u_3)) = \alpha(u_1, u_1u_3). \end{aligned}$$

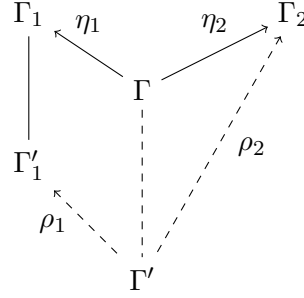

Figure 11: A diagram for Lemma 5.20. Solid lines represent given functions (models) and dashed lines represent functions to be constructed.

Also, since $\lambda'_1(\rho_1(u_1u_2)) = \lambda'_1(v_1v_2) = \lambda_1(v_1v_3) = \lambda_1(\eta_1(u_1u_3))$, we have

$$\begin{aligned}
\lambda'(u_1u_2) &= \lambda'_1(\rho_1(u_1u_2)) + \lambda_2(\rho_2(u_1u_2)) - \dim(\alpha_1(\vec{\rho}_1(u_1, u_1u_2)) \cap \alpha_2(\vec{\rho}_2(u_1, u_1u_2))) \\
&\quad - \dim(\alpha_1(\vec{\rho}_1(u_2, u_1u_2)) \cap \alpha_2(\vec{\rho}_2(u_2, u_1u_2))) + \dim(U'_1 \cap U_2) \\
&= \lambda_1(\eta_1(u_1u_3)) + \lambda_2(\eta_2(u_1u_3)) - \dim(\alpha_1(\vec{\eta}_1(u_1, u_1u_3)) \cap \alpha_2(\vec{\eta}_2(u_1, u_1u_3))) \\
&\quad - \dim(\alpha_1(\vec{\eta}_1(u_3, u_1u_3)) \cap \alpha_2(\vec{\eta}_2(u_3, u_1u_3))) + \dim(U_1 \cap U_2) \\
&= \lambda(u_1u_3).
\end{aligned}$$

Similarly, we have $\lambda'(u_2u_3) = \lambda(u_1u_3)$. □

Lemma 5.21. *Let Γ_1, Γ_2 be B -namus and Γ'_1 be a subdivision of Γ_1 . Then for every sum Γ' of Γ'_1 and Γ_2 , there is a sum Γ of Γ_1 and Γ_2 such that Γ' is a subdivision of Γ .*

Proof. This lemma can be proved similarly to the proof of Lemma 5.20. □

Proof of Proposition 5.18. Since \preceq is transitive by Lemma 5.12 and $\Gamma_1 \oplus \Gamma_2 = \Gamma_2 \oplus \Gamma_1$, it is enough to prove this proposition for the case that $\Gamma'_2 = \Gamma_2$. Let Γ''_1 be a B -namu isomorphic to a subdivision of Γ'_1 and Γ^*_1 be a B -namu isomorphic to a subdivision of Γ_1 such that $\Gamma''_1 \leq \Gamma^*_1$. We may assume that Γ''_1 is a subdivision of Γ'_1 and Γ^*_1 is a subdivision of Γ_1 . From Lemma 5.20, there is a sum of Γ^*_1 and Γ_2 , say, $\Gamma^*_1 +_{(\eta_1, \eta_2)} \Gamma_2$, which is a subdivision of Γ . Note that $\Gamma^*_1 +_{(\eta_1, \eta_2)} \Gamma_2 \preceq \Gamma$. By Lemma 5.19, $\Gamma''_1 +_{(\eta_1, \eta_2)} \Gamma_2 \leq \Gamma^*_1 +_{(\eta_1, \eta_2)} \Gamma_2$. By Lemma 5.21, there is $\Gamma' \in \Gamma''_1 \oplus \Gamma_2$ such that $\Gamma''_1 +_{(\eta_1, \eta_2)} \Gamma_2$ is a subdivision of Γ' . Note that $\Gamma' \preceq \Gamma^*_1 +_{(\eta_1, \eta_2)} \Gamma_2$. Now,

$$\Gamma' \preceq \Gamma''_1 +_{(\eta_1, \eta_2)} \Gamma_2 \leq \Gamma^*_1 +_{(\eta_1, \eta_2)} \Gamma_2 \preceq \Gamma. \quad \square$$

Lemma 5.22. *Let B be a subspace of \mathbb{F}^r and B' be a subspace of B . Let Γ_1 and Γ_2 be B -namus. If $\Gamma_1 \preceq \Gamma_2$, then $\Gamma_1|_{B'} \preceq \Gamma_2|_{B'}$.*

Proof. Let $\Gamma'_1 = (T'_1, \alpha'_1, \lambda'_1, U'_1)$ and $\Gamma'_2 = (T'_2, \alpha'_2, \lambda'_2, U'_2)$ be B -namus isomorphic to subdivisions of $\Gamma_1 = (T_1, \alpha_1, \lambda_1, U_1)$ and $\Gamma_2 = (T_2, \alpha_2, \lambda_2, U_2)$, respectively, such that $\Gamma'_1 \leq \Gamma'_2$. From $\Gamma'_1 \leq \Gamma'_2$, for every incidence (v, e) of $T'_1 = T'_2$ we have $\alpha'_1(v, e) \cap B' = \alpha'_2(v, e) \cap B'$ and $\lambda'_1(e) \leq \lambda'_2(e)$. Clearly, we have $U'_1 = U_1 \cap B' = U_2 \cap B' = U'_2$. Therefore, $\Gamma'_1|_{B'} \leq \Gamma'_2|_{B'}$.

It is easy to see that $\Gamma'_1|_{B'}$ and $\Gamma'_2|_{B'}$ are B' -namus isomorphic to subdivisions of $\Gamma_1|_{B'}$ and $\Gamma_2|_{B'}$. This completes the proof. □

By definition, we can deduce the following lemma.

Lemma 5.23. *Let Γ_1 and Γ_2 be B -namus such that $\Gamma_1 \preceq \Gamma_2$. If Γ_2 is a k -safe extension of $\text{trim}(\Gamma_2)$, then Γ_1 is a k -safe extension of $\text{trim}(\Gamma_1)$.*

Proof. Let $\Gamma_1 = (T_1, \alpha_1, \lambda_1, U)$ and $T'_1 = T(\text{trim}(\Gamma_1))$. Let $\eta_1 = T'_1$ be a T'_1 -model in T_1 and let (v_1, e_1) be an incidence of T_1 with $\vec{\eta}_1(v_1, e_1) = (*, \emptyset)$. We will show that

$$\lambda_1(e_1) + \dim U - \dim \alpha_1(v_1, e_1) \leq k,$$

which proves that Γ_1 is a k -safe extension of $\text{trim}(\Gamma_1)$.

Since $\Gamma_1 \preceq \Gamma_2$, there exist B -namus Γ'_1 and Γ'_2 that are subdivisions of Γ_1 and $\Gamma_2 = (T_2, \alpha_2, \lambda_2, U)$, respectively, such that $\Gamma'_1 \leq \Gamma'_2$. We may assume that Γ'_1 is a subdivision of Γ_1 and Γ'_2 is a subdivision of Γ_2 . Let $T = T(\Gamma'_1) = T(\Gamma'_2)$. Let $\eta_2 = T(\text{trim}(\Gamma_2))$ be a $T(\text{trim}(\Gamma_2))$ -model in T_2 . Let e be an edge of T that corresponds to e_1 of T_1 and let e_2 be the edge of T_2 corresponding to e . By definition, since e_1 is removed by trimming Γ_1 , we deduce that e_2 is removed by trimming Γ_2 . Thus, $\lambda_2(e_2) + \dim U - \dim \alpha_2(v_2, e_2) \leq k$ for an end v_2 of e_2 with $\vec{\eta}_2(v_2, e_2) = (*, \emptyset)$. Since $\lambda_1(e_1) \leq \lambda_2(e_2)$ and $\alpha_1(v_1, e_1) = \alpha_2(v_2, e_2)$, we have $\lambda_1(e_1) + \dim U - \dim \alpha_1(v_1, e_1) \leq k$. \square

5.5 Witnesses

Labeling In order to describe a subcubic tree with no degree-2 node containing a subdivision of a subcubic tree T , we define a *labeling* of T as a mapping ζ defined on the union of the set of nodes of degree at most 2 and the set of the incidences of T such that

- for each node v of degree at most 2 in T , $\zeta(v)$ is a rooted binary tree with the root v satisfying that
$$\deg_{\zeta(v)}(v) = 0 \text{ or } \deg_{\zeta(v)}(v) = 3 - \max(\deg_T(v), 1),$$
- for each incidence (v, e) of T , $\zeta(v, e)$ is a sequence $(T_1, T_2, \dots, T_{\ell_{v,e}})$ of rooted binary trees whose roots have degree 1 where $\ell_{v,e} \geq 0$.

We say that an edge or a node is *in* ζ if it is in $\zeta(u)$ or $\zeta(v, e)$ for some node u or some incidence (v, e) of T .

Before moving on, let us explain the intuition behind a labeling. Suppose that a subcubic tree G contains a subdivision T' of a subcubic tree T such that $E(T) \neq \emptyset$ and every node in T' incident with an edge in $E(G) - E(T')$ has degree 3 in G . We define $\zeta(v)$ to be the component of $G - E(T')$ seen as a rooted binary tree having v as the root. For each edge uv of T , G has a path P_{uv} from u to v , as T' is a subdivision of T . We arbitrarily split the path P_{uv} into two subpaths $P_{u,uv}$ and $P_{v,uv}$ containing u and v , respectively, so that they share exactly one edge. Then we define $\zeta(u, uv)$ as the sequence of components of $G - E(T')$ having internal nodes in $P_{u,uv}$ as roots in which we ignore components having only one node. Thus, roughly speaking, a labeling of T expresses how the “hidden” rooted binary trees are attached to T .

We say that v is a *leaf* of a labeling ζ of T if it is

- a nonroot leaf of $\zeta(v)$ for some node $v \in V(T)$ of degree at most 2,
- an isolated root of $\zeta(v)$ for some leaf v of T , or
- a nonroot leaf of a rooted binary tree in $\zeta(v, e)$ for some incidence (v, e) of T .

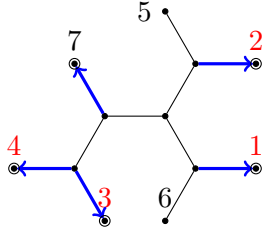

Figure 12: x -protected edges and nodes from the example of Figure 5.

\mathcal{V} -labeling For a subspace arrangement \mathcal{V} , a \mathcal{V} -labeling of a subcubic tree T is a pair (ζ, \mathcal{L}) of a labeling ζ of T and a bijection from the set of leaves of ζ to \mathcal{V} . Note that $\zeta(v, e)$ can be the empty sequence.

For a \mathcal{V} -labeling (ζ, \mathcal{L}) of a subcubic tree T , its *canonical branch-decomposition* $(\mathbb{T}(\zeta), \mathcal{L})$ consists of a tree $\mathbb{T}(\zeta)$ and a bijection \mathcal{L} where $\mathbb{T}(\zeta)$ is obtained from T by

- (i) subdividing each edge uv of T $|\zeta(u, uv)| + |\zeta(v, uv)|$ times,
- (ii) attaching the i th rooted binary tree in $\zeta(u, uv)$ whose root is identified with the i th new subdividing internal node on the path from u to v for each incidence (u, uv) of T and $1 \leq i \leq |\zeta(u, uv)|$,
- (iii) attaching $\zeta(v)$ for all $v \in V(T)$ of degree at most 2 whose root is identified with v , and
- (iv) smoothing v for each $v \in V(T)$ with $\deg_T(v) = 2$ and $|V(\zeta(v))| = 1$.

We remark that the set of leaves of $\mathbb{T}(\zeta)$ is equal to the set of leaves of ζ and $(\mathbb{T}(\zeta), \mathcal{L})$ is a branch-decomposition if T has at least one edge and a rooted branch-decomposition if T has no edges. By (iv), if an edge $e = uv$ of $\mathbb{T}(\zeta)$ is not in ζ , then e corresponds to a path P_e in T from u to v such that $\zeta(w)$ has only one node for every internal node w of P_e . Furthermore for each $v \in V(T)$, $\zeta(v)$ is a subtree of $\mathbb{T}(\zeta)$, and for each incidence (v, e) of T , $\zeta(v, e)$ is a subtree of $\mathbb{T}(\zeta)$.

Let (T^b, \mathcal{L}^b) be a rooted branch-decomposition of \mathcal{V} and $\mathcal{V}_0 \subseteq \mathcal{V}$. We say that a \mathcal{V}_0 -labeling (ζ, \mathcal{L}) of a subcubic tree T is *totally pure with respect to* (T^b, \mathcal{L}^b) if its canonical branch-decomposition is totally pure with respect to (T^b, \mathcal{L}^b) . For a node x of T^b with $\mathcal{V}_x \subseteq \mathcal{V}_0$ and an edge uv in a branch-decomposition (T, \mathcal{L}) of \mathcal{V}_0 , we say (u, v) is *x -protected* in (T, \mathcal{L}) if

- uv is x -blocked and uv x -guards v , or
- there exists a node z of T^b with $z \leq x$ such that uv cuts \mathcal{V}_z , (T, \mathcal{L}) is z -degenerate, and $\mathcal{L}(T, u, v) \subseteq \mathcal{V}_z$.

An edge uv of T is *x -protected* in (T, \mathcal{L}) if (u, v) or (v, u) is x -protected in (T, \mathcal{L}) . A node v of T is *x -protected* in (T, \mathcal{L}) if (u, v) is x -protected in (T, \mathcal{L}) for some neighbor u of v in T . See Figure 12 for an example.

Lemma 5.24. *Let x be a node of T^b and let (T, \mathcal{L}) be a branch-decomposition of \mathcal{V}_0 with $\mathcal{V}_x \subseteq \mathcal{V}_0$. For two nodes p and q of T , if neither p nor q is x -protected and v is a node on the unique path from p to q , then v is not x -protected.*

Proof. We may assume that $v \neq p$ and $v \neq q$. Suppose that (u, v) is x -protected in (T, \mathcal{L}) for a neighbor u of v . As v is an internal node of the path from p to q , (u, v) points toward p or q . Assume that (u, v) points toward q . Let q' be the neighbor of q on P . If uv is x -blocked and uv x -guards v , then $q'q$ is x -blocked and $q'q$ x -guards q because (u, v) points toward q . If there exists a node z of T^b with $z \leq x$ such that uv cuts \mathcal{V}_z , (T, \mathcal{L}) is z -degenerate, and $\mathcal{L}(T, u, v) \subseteq \mathcal{V}_z$, then $\mathcal{L}(T, q', q) \subseteq \mathcal{V}_z$ and $q'q$ cuts \mathcal{V}_z because (u, v) points toward q . Therefore, q is x -protected, which is a contradiction. \square

For convenience, let us define a few notations to denote a subspace associated to a node or an incidence. For a \mathcal{V} -labeling (ζ, \mathcal{L}) of a subcubic tree T and a node v of T of degree at most 2, let

$$\Sigma_\zeta(v) = \langle \{\mathcal{L}(w) : w \text{ is a node in } \zeta(v) \text{ that is a leaf of } \zeta\} \rangle.$$

For an incidence (v, e) of T and $i \in \{1, \dots, |\zeta(v, e)|\}$, let

$$\Sigma_\zeta(v, e, i) = \langle \{\mathcal{L}(w) : w \text{ is a nonroot leaf of the } i\text{th tree in } \zeta(v, e)\} \rangle.$$

For an incidence (u, uv) of T and $i \in \{0, 1, \dots, |\zeta(u, uv)|\}$, let $L_\zeta(u, uv, i)$ be the sum of

- (i) all $\Sigma_\zeta(w)$ for all nodes w in the component of $T - uv$ containing u with $\deg_T(w) \leq 2$,
- (ii) all $\Sigma_\zeta(w, e, j)$ for all incidences (w, e) in the component of $T - uv$ containing u and all $1 \leq j \leq |\zeta(w, e)|$, and
- (iii) all $\Sigma_\zeta(u, uv, j)$ for all $j \leq i$,

and let $R_\zeta(u, uv, i)$ be the sum of

- (i) all $\Sigma_\zeta(u, uv, j)$ for all $i < j \leq |\zeta(u, uv)|$, and
- (ii) $L_\zeta(v, uv, |\zeta(v, uv)|)$.

Witness For a node x of T^b and a vector space B containing B_x , we say that a \mathcal{V}_x -labeling (ζ, \mathcal{L}) of a subcubic tree T is a *witness* of a B -namu $\Gamma = (T, \alpha, \lambda, U)$ in B if all of the following hold.

- (i) For each incidence (u, uv) of T and $0 \leq i \leq |\zeta(u, uv)|$,

$$\begin{aligned} \alpha(u, uv) &= L_\zeta(u, uv, 0) \cap B = R_\zeta(v, uv, 0) \cap B, \\ \lambda(uv) &\geq \dim(L_\zeta(u, uv, i) \cap R_\zeta(u, uv, i)). \end{aligned}$$

- (ii) $U = \langle \mathcal{V}_x \rangle \cap B$.
- (iii) (ζ, \mathcal{L}) is totally pure with respect to (T^b, \mathcal{L}^b) .
- (iv) Every edge in ζ is x -protected in $(\mathbb{T}(\zeta), \mathcal{L})$.

A \mathcal{V}_x -labeling (ζ, \mathcal{L}) of T is said to be k -safe if

$$\dim(\langle L_t \rangle \cap \langle \mathcal{V}_x - L_t \rangle) + \dim B_x - \dim(\langle \mathcal{V}_x - L_t \rangle \cap B_x) \leq k$$

for every nonroot node t in ζ , where $L_t = \{\mathcal{L}(w) : w \text{ is a leaf that is a descendant of } T \text{ or } w = t\}$. Let us call this inequality the *k-safe inequality*. We note that if Γ has width at most k and (ζ, \mathcal{L}) is a k -safe witness of Γ , then $(\mathbb{T}(\zeta), \mathcal{L})$ is a branch-decomposition of width at most k because $\dim B_x - \dim(\langle \mathcal{V}_x - L_t \rangle \cap B_x) \geq 0$.

Join For two disjoint subspace arrangements \mathcal{V}_1 and \mathcal{V}_2 , let (ζ_1, \mathcal{L}_1) be a \mathcal{V}_1 -labeling of a subcubic tree T_1 and let (ζ_2, \mathcal{L}_2) be a \mathcal{V}_2 -labeling of a subcubic tree T_2 . Given a (T_1, T_2) -model (η_1, η_2) in a tree T , we define the *sum* (ζ, \mathcal{L}) of (ζ_1, \mathcal{L}_1) and (ζ_2, \mathcal{L}_2) by (η_1, η_2) , denoted as $(\zeta_1, \mathcal{L}_1) +_{(\eta_1, \eta_2)} (\zeta_2, \mathcal{L}_2)$, as follows. For each node v of degree at most 2 in T , let

$$\zeta(v) = \begin{cases} \zeta_1(v_1) & \text{if } v = \bar{\eta}_1(v_1), \\ \zeta_2(v_2) & \text{if } v = \bar{\eta}_2(v_2). \end{cases}$$

For two sequences s_1 and s_2 , let $s_1 s_2$ denote the concatenation of s_1 and s_2 . For each incidence (v, e) in T , let

$$\zeta(v, e) = \begin{cases} \zeta_1(\bar{\eta}_1(v, e))\zeta_2(\bar{\eta}_2(v, e)) & \text{if } v \text{ is a branch node in both } \eta_1 \text{ and } \eta_2, \\ \zeta_1(\bar{\eta}_1(v, e)) & \text{if } v \text{ is a branch node in only } \eta_1, \\ \zeta_2(\bar{\eta}_2(v, e)) & \text{if } v \text{ is a branch node in only } \eta_2, \\ \text{the empty sequence} & \text{otherwise.} \end{cases}$$

We define \mathcal{L} as a function from the set of all leaves of ζ to $\mathcal{V}_1 \cup \mathcal{V}_2$ such that

$$\mathcal{L}(\ell) = \begin{cases} \mathcal{L}_1(\ell) & \text{if } \ell \text{ is a leaf of } \zeta_1, \\ \mathcal{L}_2(\ell) & \text{if } \ell \text{ is a leaf of } \zeta_2. \end{cases}$$

Trivially (ζ, \mathcal{L}) is a $\mathcal{V}_1 \cup \mathcal{V}_2$ -labeling of T and the set of edges in ζ is precisely the union of the set of edges in ζ_1 or ζ_2 .

Lemma 5.25. *Let (T^b, \mathcal{L}^b) be a rooted branch-decomposition of a subspace arrangement \mathcal{V} and let x be a node of T^b with two children x_1 and x_2 . Let T_1, T_2, T be subcubic trees such that there exists a (T_1, T_2) -model (η_1, η_2) in T . Let (ζ_i, \mathcal{L}_i) be a \mathcal{V}_{x_i} -labeling of T_i for $i = 1, 2$. If*

- (ζ_i, \mathcal{L}_i) is totally pure with respect to (T^b, \mathcal{L}^b) for every $i = 1, 2$,
- every y -protected edge in $(\mathbb{T}(\zeta_i), \mathcal{L}_i)$ is in ζ_i for every $i = 1, 2$ and every node $y \leq x_i$ of T^b ,

then the following hold.

(i) The sum (ζ, \mathcal{L}) of (ζ_1, \mathcal{L}_1) and (ζ_2, \mathcal{L}_2) by (η_1, η_2) is totally pure with respect to (T^b, \mathcal{L}^b) .

(ii) Every y -protected edge in $(\mathbb{T}(\zeta), \mathcal{L})$ is in ζ for every node $y < x$ of T^b .

Proof. For each $y < x$, every y -protected edge is in ζ_1 or ζ_2 and by the construction of ζ , such an edge is in ζ as well.

It remains to prove that $(\mathbb{T}(\zeta), \mathcal{L})$ is totally pure with respect to (T^b, \mathcal{L}^b) . Since $(\mathbb{T}(\zeta), \mathcal{L})$ is trivially x -pure, it suffices to prove that $(\mathbb{T}(\zeta), \mathcal{L})$ is y -pure for each node $y < x$ of T^b . We may assume $y \leq x_1$ by symmetry. We rely on the fact that $(\mathbb{T}(\zeta), \mathcal{L})$ is y -degenerate if and only if $(\mathbb{T}(\zeta_1), \mathcal{L}_1)$ is y -degenerate by the definition of y -degenerate branch-decompositions.

Let us first consider the case that $(\mathbb{T}(\zeta), \mathcal{L})$ is not y -degenerate. Let uv be a y -blocked edge of $(\mathbb{T}(\zeta), \mathcal{L})$. We may assume that uv y -guards v . If uv is in ζ , then it is in ζ_1 or ζ_2 and so (u, v) is not y -mixed because both $(\mathbb{T}(\zeta_1), \mathcal{L}_1)$ and $(\mathbb{T}(\zeta_2), \mathcal{L}_2)$ are totally pure. Thus we may assume that uv is not in ζ . Then uv corresponds to a path P from u to v in T . Let e be an edge incident with u in P and let $u'v' = \eta_1(e) \in E(\mathbb{T}(\zeta_1))$ where $\bar{\eta}_1(u, e) = (u', u'v')$. Because $(\mathbb{T}(\zeta_1), \mathcal{L}_1)$ is

totally pure with respect to (T^b, \mathcal{L}^b) and (u', v') is y -protected in $(\mathbb{T}(\zeta_1), \mathcal{L}_1)$, it follows that $u'v'$ is in ζ_1 by the assumption. However, this contradicts our assumption that uv is not in ζ .

Now it remains to consider the case that $(\mathbb{T}(\zeta), \mathcal{L})$ is y -degenerate. Then $(\mathbb{T}(\zeta_1), \mathcal{L}_1)$ is y -degenerate and so it is y -disjoint. Then every edge of $T(\zeta_1)$ cutting \mathcal{V}_z is y -protected and therefore it is in ζ_1 by the assumption. So, $(\mathbb{T}(\zeta), \mathcal{L})$ is y -disjoint by its construction. \square

Lemma 5.26. *Let (T^b, \mathcal{L}^b) be a rooted branch-decomposition of a subspace arrangement \mathcal{V} and let x be a node of T^b with two children x_1 and x_2 . Let T_1, T_2, T be subcubic trees such that there exists a (T_1, T_2) -model (η_1, η_2) in T . Let (ζ_i, \mathcal{L}_i) be a \mathcal{V}_{x_i} -labeling of T_i for $i = 1, 2$. If (ζ_1, \mathcal{L}_1) and (ζ_2, \mathcal{L}_2) are k -safe, then so is the sum (ζ, \mathcal{L}) of (ζ_1, \mathcal{L}_1) and (ζ_2, \mathcal{L}_2) by (η_1, η_2) .*

Proof. By symmetry between \mathcal{V}_{x_1} and \mathcal{V}_{x_2} , it is enough to prove that for each $L \subseteq \mathcal{V}_{x_1} \subseteq \mathcal{V}_x$,

$$\begin{aligned} \dim(\langle L \rangle \cap \langle \mathcal{V}_{x_1} - L \rangle) + \dim B_{x_1} - \dim(\langle \mathcal{V}_{x_1} - L \rangle \cap B_{x_1}) \\ = \dim(\langle L \rangle \cap \langle \mathcal{V}_x - L \rangle) + \dim B_x - \dim(\langle \mathcal{V}_x - L \rangle \cap B_x). \end{aligned} \quad (1)$$

First observe that $\langle \mathcal{V}_{x_1} - L \rangle \cap B_{x_1} = \langle \mathcal{V}_{x_1} - L \rangle \cap \langle \mathcal{V} - \mathcal{V}_{x_1} \rangle$ and $\langle \mathcal{V}_x - L \rangle \cap B_x = \langle \mathcal{V}_x - L \rangle \cap \langle \mathcal{V} - \mathcal{V}_x \rangle$. Now, we claim that both sides of (1) are equal to

$$\dim(\langle L \rangle \cap \langle \mathcal{V} - L \rangle).$$

To see that, we use Lemma 4.3. First we take $\langle \mathcal{V} - L \rangle = \langle \mathcal{V}_{x_1} - L \rangle + \langle \mathcal{V} - \mathcal{V}_{x_1} \rangle$. Then by Lemma 4.3,

$$\begin{aligned} \dim(\langle L \rangle \cap \langle \mathcal{V} - L \rangle) &= \dim(\langle \langle L \rangle + 0 \rangle \cap (\langle \mathcal{V}_{x_1} - L \rangle + \langle \mathcal{V} - \mathcal{V}_{x_1} \rangle)) \\ &= \dim(\langle L \rangle \cap \langle \mathcal{V}_{x_1} - L \rangle) - \dim(\langle \mathcal{V}_{x_1} - L \rangle \cap \langle \mathcal{V} - \mathcal{V}_{x_1} \rangle) \\ &\quad + \dim(\langle \langle L \rangle + \langle \mathcal{V}_{x_1} - L \rangle \rangle \cap \langle \mathcal{V} - \mathcal{V}_{x_1} \rangle) \\ &= \dim(\langle L \rangle \cap \langle \mathcal{V}_{x_1} - L \rangle) + \dim B_{x_1} - \dim(\langle \mathcal{V}_{x_1} - L \rangle \cap B_{x_1}). \end{aligned}$$

Now we take $\langle \mathcal{V} - L \rangle = \langle \mathcal{V}_x - L \rangle + \langle \mathcal{V} - \mathcal{V}_x \rangle$. By the same method as above with Lemma 4.3, we deduce that

$$\begin{aligned} \dim(\langle L \rangle \cap \langle \mathcal{V} - L \rangle) &= \dim(\langle \langle L \rangle + 0 \rangle \cap (\langle \mathcal{V}_x - L \rangle + \langle \mathcal{V} - \mathcal{V}_x \rangle)) \\ &= \dim(\langle L \rangle \cap \langle \mathcal{V}_x - L \rangle) - \dim(\langle \mathcal{V}_x - L \rangle \cap \langle \mathcal{V} - \mathcal{V}_x \rangle) \\ &\quad + \dim(\langle \langle L \rangle + \langle \mathcal{V}_x - L \rangle \rangle \cap \langle \mathcal{V} - \mathcal{V}_x \rangle) \\ &= \dim(\langle L \rangle \cap \langle \mathcal{V}_x - L \rangle) + \dim B_x - \dim(\langle \mathcal{V}_x - L \rangle \cap B_x). \end{aligned} \quad \square$$

We prove a lemma on boundary spaces.

Lemma 5.27. *Let (T^b, \mathcal{L}^b) be a rooted branch-decomposition of a subspace arrangement \mathcal{V} and let x be a node of T^b with two children x_1 and x_2 . Let $B_{x_i} = \langle \mathcal{V}_{x_i} \rangle \cap \langle \mathcal{V} - \mathcal{V}_{x_i} \rangle$ for $i = 1, 2$. Then*

$$\begin{aligned} \langle \mathcal{V}_{x_1} \rangle \cap (B_{x_1} + B_{x_2}) &= B_{x_1}, \\ \langle \mathcal{V}_{x_2} \rangle \cap (B_{x_1} + B_{x_2}) &= B_{x_2}, \\ (\langle \mathcal{V}_{x_1} \rangle + B_{x_1} + B_{x_2}) \cap (\langle \mathcal{V}_{x_2} \rangle + B_{x_1} + B_{x_2}) &= B_{x_1} + B_{x_2}. \end{aligned}$$

Proof. Let us first prove that $\langle \mathcal{V}_{x_i} \rangle \cap (B_{x_1} + B_{x_2}) = B_{x_i}$. By symmetry, it is enough to prove for $i = 1$. Since B_{x_1} is a subspace of $\langle \mathcal{V}_{x_1} \rangle$,

$$B_{x_1} = \langle \mathcal{V}_{x_1} \rangle \cap B_{x_1} \subseteq \langle \mathcal{V}_{x_1} \rangle \cap (B_{x_1} + B_{x_2}).$$

As $B_{x_1} \subseteq \langle \mathcal{V} - \mathcal{V}_{x_1} \rangle$ and $B_{x_2} \subseteq \langle \mathcal{V}_{x_2} \rangle \subseteq \langle \mathcal{V} - \mathcal{V}_{x_1} \rangle$, we have

$$\langle \mathcal{V}_{x_1} \rangle \cap (B_{x_1} + B_{x_2}) \subseteq \langle \mathcal{V}_{x_1} \rangle \cap \langle \mathcal{V} - \mathcal{V}_{x_1} \rangle = B_{x_1}.$$

This proves that $\langle \mathcal{V}_{x_i} \rangle \cap (B_{x_1} + B_{x_2}) = B_{x_i}$ for $i = 1, 2$.

Now let us prove the last equation. Since $(\langle \mathcal{V}_{x_1} \rangle + B_{x_1} + B_{x_2}) \cap (\langle \mathcal{V}_{x_2} \rangle + B_{x_1} + B_{x_2}) \supseteq (B_{x_1} + B_{x_2})$, the proof is completed by showing that the dimensions of both sides are equal. Note that $B_{x_1} \cap B_{x_2} = \langle \mathcal{V}_{x_1} \rangle \cap \langle \mathcal{V} - \mathcal{V}_{x_1} \rangle \cap \langle \mathcal{V}_{x_2} \rangle \cap \langle \mathcal{V} - \mathcal{V}_{x_2} \rangle = \langle \mathcal{V}_{x_1} \rangle \cap \langle \mathcal{V}_{x_2} \rangle$ and therefore

$$\begin{aligned} & \dim((\langle \mathcal{V}_{x_1} \rangle + B_{x_1} + B_{x_2}) \cap (\langle \mathcal{V}_{x_2} \rangle + B_{x_1} + B_{x_2})) \\ &= \dim((\langle \mathcal{V}_{x_1} \rangle + B_{x_2}) \cap (\langle \mathcal{V}_{x_2} \rangle + B_{x_1})) \\ &= \dim \langle \mathcal{V}_{x_1} \rangle + \dim B_{x_2} - \dim(\langle \mathcal{V}_{x_1} \rangle \cap B_{x_2}) \\ &\quad + \dim \langle \mathcal{V}_{x_2} \rangle + \dim B_{x_1} - \dim(\langle \mathcal{V}_{x_2} \rangle \cap B_{x_1}) - \dim(\langle \mathcal{V}_{x_1} \rangle + \langle \mathcal{V}_{x_2} \rangle) \\ &= \dim \langle \mathcal{V}_{x_1} \rangle + \dim \langle \mathcal{V}_{x_2} \rangle - \dim(\langle \mathcal{V}_{x_1} \rangle \cap \langle \mathcal{V}_{x_2} \rangle) - \dim(\langle \mathcal{V}_{x_1} \rangle + \langle \mathcal{V}_{x_2} \rangle) \\ &\quad + \dim B_{x_1} + \dim B_{x_2} - \dim(\langle \mathcal{V}_{x_1} \rangle \cap \langle \mathcal{V}_{x_2} \rangle) \\ &= \dim(B_{x_1} + B_{x_2}). \end{aligned} \quad \square$$

Proposition 5.28. *Let (T^b, \mathcal{L}^b) be a branch-decomposition of a subspace arrangement \mathcal{V} and let x be a node of T^b with two children x_1 and x_2 . For each $i = 1, 2$, let $\Gamma_i = (T_i, \alpha_i, \lambda_i, U_i)$ be a B_{x_i} -namu and (ζ_i, \mathcal{L}_i) be a \mathcal{V}_{x_i} -labeling of T_i witnessing Γ_i in B_{x_i} . Let Γ be a $(B_{x_1} + B_{x_2})$ -namu that is the sum of Γ_1 and Γ_2 by a (T_1, T_2) -model (η_1, η_2) . Let (ζ, \mathcal{L}) be the sum of (ζ_1, \mathcal{L}_1) and (ζ_2, \mathcal{L}_2) by (η_1, η_2) .*

If every y -protected edge in $(\mathbb{T}(\zeta_i), \mathcal{L}_i)$ is in ζ_i for each $i = 1, 2$ and every node $y \leq x_i$ of T^b , then (ζ, \mathcal{L}) is a witness of Γ in $B_{x_1} + B_{x_2}$ and every y -protected edge in $(\mathbb{T}(\zeta), \mathcal{L})$ is in ζ for every node $y < x$ of T^b . In addition, if both (ζ_1, \mathcal{L}_1) and (ζ_2, \mathcal{L}_2) are k -safe, then so is (ζ, \mathcal{L}) .

Proof. Let $\Gamma = (T, \alpha, \lambda, U)$ and $B = B_{x_1} + B_{x_2}$. Lemma 5.26 already showed that if both (ζ_1, \mathcal{L}_1) and (ζ_2, \mathcal{L}_2) are k -safe, then so is (ζ, \mathcal{L}) . Lemma 5.25 implies that (ζ, \mathcal{L}) is totally pure with respect to (T^b, \mathcal{L}^b) and every y -protected edge of $(\mathbb{T}(\zeta), \mathcal{L})$ is in ζ for every node $y < x$ of T^b .

Now it remains to show that (ζ, \mathcal{L}) is a witness of Γ in $B_{x_1} + B_{x_2}$. We need to check four properties (i)–(iv) in the definition of a witness. First of all, we have seen that (iii) holds. For (ii), by Lemmas 5.27 and 5.10,

$$\begin{aligned} U &= U_1 + U_2 = (\langle \mathcal{V}_{x_1} \rangle \cap B_{x_1}) + (\langle \mathcal{V}_{x_2} \rangle \cap B_{x_2}) \\ &= (\langle \mathcal{V}_{x_1} \rangle + \langle \mathcal{V}_{x_2} \rangle) \cap (B_{x_1} + B_{x_2}) = \langle \mathcal{V}_x \rangle \cap B, \end{aligned}$$

and so (ζ, \mathcal{L}) and Γ satisfy (ii).

To see (i), observe that for each incidence (u, e) of T ,

$$L_\zeta(u, e, 0) = L_{\zeta_1}(\vec{\eta}_1(u, e), 0) + L_{\zeta_2}(\vec{\eta}_2(u, e), 0).$$

By Lemmas 5.27 and 5.10, we deduce that

$$L_\zeta(u, e, 0) \cap B = L_{\zeta_1}(\vec{\eta}_1(u, e), 0) \cap B + L_{\zeta_2}(\vec{\eta}_2(u, e), 0) \cap B.$$

As $L_{\zeta_i}(\vec{\eta}_i(u, e), 0) \subseteq \langle \mathcal{V}_{x_i} \rangle$ and $\langle \mathcal{V}_{x_i} \rangle \cap B = B_{x_i}$ for each $i = 1, 2$, we deduce that

$$L_{\zeta}(u, e, 0) \cap B = L_{\zeta_1}(\vec{\eta}_1(u, e), 0) \cap B_{x_1} + L_{\zeta_2}(\vec{\eta}_2(u, e), 0) \cap B_{x_2},$$

and since (ζ_i, \mathcal{L}_i) is a witness of Γ_i for $i = 1, 2$ and $\Gamma = \Gamma_1 +_{(\eta_1, \eta_2)} \Gamma_2$, we have $L_{\zeta}(u, e, 0) \cap B = \alpha_1(\vec{\eta}_1(u, e)) + \alpha_2(\vec{\eta}_2(u, e)) = \alpha(u, e)$. Similarly, we have $R_{\zeta}(v, e, 0) \cap B = \alpha(u, e)$.

For $i \in \{0, \dots, |\zeta(u, e)|\}$, by the construction, there exist $i_1 \in \{0, \dots, |\zeta_1(\vec{\eta}_1(u, e))|\}$ and $i_2 \in \{0, \dots, |\zeta_2(\vec{\eta}_2(u, e))|\}$ such that $L_{\zeta}(u, e, i) = L_{\zeta_1}(\vec{\eta}_1(u, e), i_1) + L_{\zeta_2}(\vec{\eta}_2(u, e), i_2)$, and $R_{\zeta}(u, e, i) = R_{\zeta_1}(\vec{\eta}_1(u, e), i_1) + R_{\zeta_2}(\vec{\eta}_2(u, e), i_2)$. For $j = 1, 2$, let

$$L_j = L_{\zeta_j}(\vec{\eta}_j(u, e), i_j) \text{ and } R_j = R_{\zeta_j}(\vec{\eta}_j(u, e), i_j).$$

By Lemma 4.3,

$$\begin{aligned} \dim(L_{\zeta}(u, e, i) \cap R_{\zeta}(u, e, i)) &= \dim((L_1 + L_2) \cap (R_1 + R_2)) \\ &= \dim(L_1 \cap R_1) + \dim(L_2 \cap R_2) - \dim(L_1 \cap L_2) - \dim(R_1 \cap R_2) \\ &\quad + \dim((L_1 + R_1) \cap (L_2 + R_2)). \end{aligned}$$

For $j = 1, 2$, as (ζ_j, \mathcal{L}_j) is a witness of Γ_j , we have $\dim(L_j \cap R_j) \leq \lambda_j(\eta_j(e))$ and $U_j = \langle \mathcal{V}_{x_j} \rangle \cap B_{x_j}$. Also note that $L_1 \cap L_2 = (L_1 \cap B_{x_1}) \cap (L_2 \cap B_{x_2}) = \alpha_1(\vec{\eta}_1(u, e)) \cap \alpha_2(\vec{\eta}_2(u, e))$ and similarly $R_1 \cap R_2 = \alpha_1(\vec{\eta}_1(v, e)) \cap \alpha_2(\vec{\eta}_2(v, e))$ where v is an end of e other than u . Furthermore $(L_1 + R_1) \cap (L_2 + R_2) \subseteq B_{x_j}$ for each $j = 1, 2$, and so $(L_1 + R_1) \cap (L_2 + R_2) = (L_1 + R_1) \cap B_{x_1} \cap (L_2 + R_2) \cap B_{x_2} = U_1 \cap U_2$. Thus, we deduce that $\dim(L_{\zeta}(u, e, i) \cap R_{\zeta}(u, e, i)) \leq \lambda_1(\eta_1(e)) + \lambda_2(\eta_2(e)) - \dim(\alpha_1(\vec{\eta}_1(u, e)) \cap \alpha_2(\vec{\eta}_2(u, e))) - \dim(\alpha_1(\vec{\eta}_1(v, e)) \cap \alpha_2(\vec{\eta}_2(v, e))) + \dim(U_1 \cap U_2) = \lambda(e)$. This proves (i).

Finally let us verify (iv). We claim that every edge in ζ is an x -protected edge in $(\mathbb{T}(\zeta), \mathcal{L})$. If $(\mathbb{T}(\zeta), \mathcal{L})$ is x -degenerate, every edge of $(\mathbb{T}(\zeta), \mathcal{L})$ is x -protected and the claim trivially holds. Hence we may assume that $(\mathbb{T}(\zeta), \mathcal{L})$ is not x -degenerate. Note that every edge e in ζ is either in ζ_1 or ζ_2 and thus e is x_i -protected in $(\mathbb{T}(\zeta_i), \mathcal{L})$ for $i = 1$ or 2 . By symmetry, we may assume that $i = 1$.

If e is x_1 -blocked by an x_1 -blocking path or an x_1 -guarding edge in $(\mathbb{T}(\zeta_1), \mathcal{L}_1)$, then by construction of $(\mathbb{T}(\zeta), \mathcal{L})$, it can be easily seen that e is either x -blocked by an x -blocking path or an x -guarding edge in $(\mathbb{T}(\zeta), \mathcal{L})$ by Lemma 4.8. Therefore, e is x -protected.

If there exists $y \leq x_1$ such that $(\mathbb{T}(\zeta), \mathcal{L})$ is y -degenerate, $e = uv$ cuts \mathcal{V}_y in $(\mathbb{T}(\zeta_1), \mathcal{L}_1)$ and $\mathcal{L}_1(\mathbb{T}(\zeta_1), u, v) \subseteq \mathcal{V}_y$, then it is clear that $e = uv$ cuts \mathcal{V}_y in $(\mathbb{T}(\zeta), \mathcal{L})$ and $\mathcal{L}(\mathbb{T}(\zeta), u, v) \subseteq \mathcal{V}_y$ from the construction of $(\mathbb{T}(\zeta), \mathcal{L})$ because $(\mathbb{T}(\zeta), \mathcal{L})$ is totally pure with respect to (T^b, \mathcal{L}^b) . Hence, e is x -protected. This completes the proof that (ζ, \mathcal{L}) is a witness of Γ in $B_{x_1} + B_{x_2}$. \square

Shrink It is easy to obtain a witness of $\Gamma|_{B'}$ in B' if we have a witness of a B -namu Γ in B from the following lemma.

Proposition 5.29. *Let (T^b, \mathcal{L}^b) be a branch-decomposition of a subspace arrangement \mathcal{V} and let x be a node of T^b . Let (ζ, \mathcal{L}) be a witness of a B -namu Γ in B . If $B' \subseteq B$, then (ζ, \mathcal{L}) is also a witness of $\Gamma|_{B'}$ in B'*

Proof. We only need to check (i) and (ii) in the definition of a witness and it is trivial. \square

Trim Let (ζ, \mathcal{L}) be a \mathcal{V}_0 -labeling of a tree T having at least one edge.

For an edge e of $\mathbb{T}(\zeta)$ that is not in ζ , we say (ζ', \mathcal{L}) is the \mathcal{V}_0 -labeling induced by an edge e from (ζ, \mathcal{L}) if there is a tree T' with exactly one node v such that ζ' is a labeling of T' where $\zeta'(v)$ is the rooted binary tree obtained from $\mathbb{T}(\zeta)$ by subdividing e to create a new degree-2 node v , which will be the root of $\zeta'(v)$.

For a subtree T' of T with $|E(T')| \geq 1$, we say that (ζ', \mathcal{L}) is the \mathcal{V}_0 -labeling induced by T' from (ζ, \mathcal{L}) if it satisfies all of the following.

- For each incidence (v, e) of T' , $\zeta'(v, e) = \zeta(v, e)$.
- For each node v of T' whose degree is at most 2, we define $\zeta'(v) = \zeta(v)$ if $\zeta(v)$ contains only one node, and otherwise, we define $\zeta'(v)$ as the component of $\mathbb{T}(\zeta) - E'$ containing v , where E' is the set of all edges of $\mathbb{T}(\zeta)$ corresponding to an edge in T' . The set E' is well defined because $\mathbb{T}(\zeta)$ contains a subdivision of T and T' is a subtree of T . The graph $\mathbb{T}(\zeta) - E'$ has a node v because $\zeta(v)$ has at least two nodes and so v was not smoothed in the construction of $\mathbb{T}(\zeta)$.

Observe that the \mathcal{V}_0 -labeling induced by T' when $E(T') = \{e\}$ is different from the \mathcal{V}_0 -labeling induced by an edge e . The latter will be applied in order to represent an x -degenerate branch-decomposition (T, \mathcal{L}) with a \mathcal{V}_0 -labeling of a single node. By definition, if (ζ', \mathcal{L}) is induced by a subtree T' from a \mathcal{V}_0 -labeling (ζ, \mathcal{L}) , then (ζ', \mathcal{L}) is a \mathcal{V}_0 -labeling of T' and $\mathbb{T}(\zeta) = \mathbb{T}(\zeta')$. Furthermore, for each node v of T of degree at most 2, $\zeta(v)$ is a subtree of some $\zeta'(w)$ for some $w \in V(T')$ and for each incidence (v, e) of T , either there exists a node w of T' such that all rooted binary trees in $\zeta(v, e)$ are subtrees of some $\zeta'(w)$ or there exists an incidence (w, f) of T' such that all rooted binary trees in $\zeta(v, e)$ are subtrees of rooted binary trees in $\zeta'(w, f)$.

Proposition 5.30. *Let (T^b, \mathcal{L}^b) be a branch-decomposition of a subspace arrangement \mathcal{V} and let x be a node of T^b . Let (ζ, \mathcal{L}) be a witness of a B_x -namu Γ in B_x such that all y -protected edges of $(\mathbb{T}(\zeta), \mathcal{L})$ are in ζ for every node $y < x$ of T^b . Let (ζ', \mathcal{L}) be the \mathcal{V}_x -labeling induced by $T(\text{trim}(\Gamma))$ if Γ has no degenerate edge and a \mathcal{V}_x -labeling induced by an x -degenerate edge of $(\mathbb{T}(\zeta), \mathcal{L})$ that is not in ζ if Γ has a degenerate edge.*

Then (ζ', \mathcal{L}) is a witness of $\text{trim}(\Gamma)$ in B_x and all y -protected edges of $(\mathbb{T}(\zeta'), \mathcal{L})$ are in ζ' for every node y of T^b with $y \leq x$. Furthermore, if (ζ, \mathcal{L}) is k -safe and Γ is a k -safe extension of $\text{trim}(\Gamma)$, then (ζ', \mathcal{L}) is k -safe.

Proof. First suppose that Γ has a degenerate edge and (ζ', \mathcal{L}) is a \mathcal{V}_x -labeling of $T(\text{trim}(\Gamma))$ induced by e from (ζ, \mathcal{L}) for an x -degenerate edge e of $(\mathbb{T}(\zeta), \mathcal{L})$ that is not in ζ . Note that such e exists because Γ has a degenerate edge and (ζ, \mathcal{L}) is a witness of Γ in B_x . Then $(\mathbb{T}(\zeta'), \mathcal{L})$ is a rooted branch-decomposition obtained from $(\mathbb{T}(\zeta), \mathcal{L})$ by subdividing e . Let e_1, e_2 be the edges of $\mathbb{T}(\zeta')$ obtained from e by subdividing e . As $T(\text{trim}(\Gamma))$ has only one node, (i) in the definition of a witness trivially holds for (ζ', \mathcal{L}) . Also (ii) is trivial. As (ζ, \mathcal{L}) is totally pure with respect to (T^b, \mathcal{L}^b) , so is (ζ', \mathcal{L}) , proving (iii) in the definition of a witness. We claim that $(\mathbb{T}(\zeta'), \mathcal{L})$ is x -degenerate. If not, then in $(\mathbb{T}(\zeta), \mathcal{L})$, e cuts \mathcal{V}_y for some $y < x$ where $(\mathbb{T}(\zeta), \mathcal{L})$ is y -degenerate. However, this means that e is y -protected because $(\mathbb{T}(\zeta), \mathcal{L})$ is y -pure. This contradicts the assumption that every y -protected edge in $(\mathbb{T}(\zeta), \mathcal{L})$ is in ζ . This proves the claim and we conclude that every edge of $\mathbb{T}(\zeta')$ is x -protected, and so (iv) holds and furthermore every x -protected edge of $(\mathbb{T}(\zeta'), \mathcal{L})$ is in ζ trivially. Thus, we proved that if Γ has a degenerate edge, then (ζ', \mathcal{L}) is a witness of $\text{trim}(\Gamma)$ and every y -protected edge of $(\mathbb{T}(\zeta'), \mathcal{L})$ is in ζ' for all $y \leq x$.

Now let us assume that Γ has no degenerate edge. We claim that (ζ', \mathcal{L}) is a witness of $\text{trim}(\Gamma)$. By definition, $T(\zeta) = T(\zeta')$ and so (ζ', \mathcal{L}) is totally pure, proving (iii) for (ζ', \mathcal{L}) . By the definition of the trim operation, (i) and (ii) hold.

Every edge e in ζ' either is in ζ or is in T that is removed by trimming Γ . For the former case, it is x -protected because (ζ, \mathcal{L}) is a witness of Γ . For the latter case, a removed edge is blocked in Γ and so it is x -protected. This proves that (ζ', \mathcal{L}) is a witness of $\text{trim}(\Gamma)$ in B_x .

It remains to show that if (ζ, \mathcal{L}) is k -safe and Γ is a k -safe extension of $\text{trim}(\Gamma)$, then (ζ', \mathcal{L}) is k -safe. This follows trivially from the definition of k -safe extensions. \square

Comparison For a \mathcal{V}_0 -labeling (ζ, \mathcal{L}) of T , a subdivision T' of T induces a \mathcal{V}_0 -labeling (ζ', \mathcal{L}) as follows. For each node v of T' having degree at most 2, we define $\zeta'(v) = \zeta(v)$ if v is present in T and otherwise $\zeta'(v)$ as the tree having only one vertex v . For each edge uv of T , let $P = v_0v_1 \cdots v_p$ be a path from u to v in T' . We define $\zeta'(v_0, v_0v_1) = \zeta(u, uv)$ and $\zeta'(v_p, v_{p-1}v_p) = \zeta(v, uv)$ and for all other incidences (w, e) in P , $\zeta'(w, e)$ is the empty sequence. We simply say that such a \mathcal{V}_0 -labeling (ζ', \mathcal{L}) is a *subdivision* of (ζ, \mathcal{L}) induced by T' .

From the definition of a subdivision, it is easy to observe the following.

Lemma 5.31. *Let (ζ, \mathcal{L}) be a \mathcal{V}_0 -labeling of T and let T' be a subdivision of T . If (ζ', \mathcal{L}) is a subdivision of (ζ, \mathcal{L}) induced by T' , then $(\mathbb{T}(\zeta'), \mathcal{L}) = (\mathbb{T}(\zeta), \mathcal{L})$ and the set of edges in ζ is equal to the set of edges in ζ' .*

Conversely, if (ζ', \mathcal{L}) is a \mathcal{V}_0 -labeling of T' and T' is a subdivision of T'' , then (ζ', \mathcal{L}) induces a \mathcal{V}_0 -labeling (ζ'', \mathcal{L}) by T'' as follows. First we orient edges of T'' arbitrarily. For each node v of T'' , we define $\zeta''(v) = \zeta'(v)$. For each edge uv of T'' , if uv is oriented toward v , then we define $\zeta''(v, uv)$ to be the empty sequence and we define $\zeta''(u, uv)$ as follows. Let P be the path $v_0v_1 \cdots v_p$ in T' from u to v . Then $\zeta''(u, uv)$ is the concatenation of the following for $i = 1, 2, \dots, p$ in the order:

- $\zeta'(v_{i-1}, v_{i-1}v_i)(\zeta'(v_i, v_{i-1}v_i))^{-1}$,
- a sequence $(\zeta'(v_i))$ of length 1 if $i < p$ and $\zeta'(v_i)$ has more than one node.

Here we use the notation $(\zeta'(v_i, v_{i-1}v_i))^{-1}$ to denote the inverted sequence. Again, we can easily observe the following lemma.

Lemma 5.32. *Let (ζ, \mathcal{L}) be a \mathcal{V}_0 -labeling of T' and let T' be a subdivision of T'' . If (ζ', \mathcal{L}) induces a \mathcal{V}_0 -labeling (ζ'', \mathcal{L}) by T'' , then $(\mathbb{T}(\zeta'), \mathcal{L}) = (\mathbb{T}(\zeta), \mathcal{L})$ and the set of edges in ζ is equal to the set of edges in ζ' .*

If a tree T ensures $\Gamma_1 \preceq \Gamma_2$ for two B -namus $\Gamma_1 = (T_1, \alpha_1, \lambda_1, U)$ and $\Gamma_2 = (T_2, \alpha_2, \lambda_2, U)$, then T is isomorphic to a subdivision of T_1 and also isomorphic to a subdivision of T_2 . By the above construction, a \mathcal{V}_0 -labeling (ζ, \mathcal{L}) of T_1 induces a \mathcal{V}_0 -labeling (ζ', \mathcal{L}) of T , which in turn induces a \mathcal{V}_0 -labeling (ζ'', \mathcal{L}) of T_2 . We say that (ζ'', \mathcal{L}) is *induced* by T from (ζ, \mathcal{L}) .

Proposition 5.33. *Let (T^b, \mathcal{L}^b) be a branch-decomposition of a subspace arrangement \mathcal{V} and let x be a node of T^b . Let Γ_1 and Γ_2 be B_x -namus such that $\Gamma_1 \preceq \Gamma_2$. Let T be a tree ensuring $\Gamma_1 \preceq \Gamma_2$.*

If a \mathcal{V}_x -labeling (ζ_1, \mathcal{L}) is a witness of Γ_1 in B_x and all y -protected edges of $(\mathbb{T}(\zeta_1), \mathcal{L})$ are in ζ_1 for every node y of T^b with $y \leq x$, then a \mathcal{V}_x -labeling (ζ_2, \mathcal{L}) of $T(\Gamma_2)$ induced by T from (ζ_1, \mathcal{L}) is a witness of Γ_2 in B_x and all y -protected edges of $(\mathbb{T}(\zeta_2), \mathcal{L})$ are in ζ_2 for every node y of T^b with $y \leq x$. In addition, if (ζ_1, \mathcal{L}) is k -safe, then so is (ζ_2, \mathcal{L}) .

Proof. Let $\Gamma_1 = (T_1, \alpha_1, \lambda_1, U)$ and $\Gamma_2 = (T_2, \alpha_2, \lambda_2, U)$. We may assume, by applying the isomorphism, that T is a subdivision of T_1 as well as a subdivision of T_2 . Let (ζ, \mathcal{L}) be the subdivision of (ζ_1, \mathcal{L}) induced by T so that (ζ, \mathcal{L}) induces (ζ_2, \mathcal{L}) . Let $\Gamma = (T, \alpha, \lambda, U)$ be the subdivision of Γ_1 .

It is easy to see from the definition that (ζ, \mathcal{L}) is a witness of Γ in B_x . By Lemma 5.31, the set of edges in ζ_1 is equal to the set of edges in ζ and $(\mathbb{T}(\zeta), \mathcal{L}) = (\mathbb{T}(\zeta_1), \mathcal{L})$. In particular, this implies that for each node $y \leq x$ of T^b , every y -protected edge of $(\mathbb{T}(\zeta), \mathcal{L})$ is in ζ and if (ζ_1, \mathcal{L}) is k -safe, then so is (ζ, \mathcal{L}) .

Let us check that (ζ_2, \mathcal{L}) satisfies the conditions of the definition of witnesses. For each incidence (u, uv) of T_2 , T has a corresponding incidence $(u', u'v')$ such that $L_{\zeta_2}(u, uv, 0) = L_{\zeta}(u', u'v', 0)$. As $\alpha(u', u'v') = \alpha_2(u, uv)$ by $\Gamma \preceq \Gamma_2$ and $\alpha(u', u'v') = L_{\zeta}(u', u'v', 0) \cap B_x$, we deduce that $\alpha_2(u, uv) = L_{\zeta_2}(u, uv, 0) \cap B_x$. Similarly $\alpha_2(u, uv) = R_{\zeta_2}(u, uv, 0) \cap B_x$.

For each incidence (u, uv) of T_2 and $0 \leq i \leq |\zeta_2(u, uv)|$, there exists an edge $u'v'$ of T and $i' \in \{0, \dots, |\zeta(u', u'v')|\}$ such that (u, uv) corresponds to $(u', u'v')$ in T , $L_{\zeta_2}(u, uv, i) = L_{\zeta}(u', u'v', i')$, and $R_{\zeta_2}(u, uv, i) = R_{\zeta}(u', u'v', i')$. As $\Gamma \preceq \Gamma_2$, we have

$$\begin{aligned} \lambda_2(uv) &\geq \lambda(u'v') \geq \dim(L_{\zeta}(u', u'v', i') \cap R_{\zeta}(u', u'v', i')) \\ &= \dim(L_{\zeta_2}(u, uv, i) \cap R_{\zeta_2}(u, uv, i)). \end{aligned}$$

By Lemma 5.32, $(\mathbb{T}(\zeta), \mathcal{L}) = (\mathbb{T}(\zeta_2), \mathcal{L})$ and the set of all edges in ζ is equal to the set of all edges in ζ_2 . This implies that (iii) and (iv) in the definition of a witness hold, all y -protected edges of $(\mathbb{T}(\zeta_2), \mathcal{L})$ are in ζ_2 for every node y of T^b with $y \leq x$, and if (ζ, \mathcal{L}) is k -safe, then so is (ζ_2, \mathcal{L}) . This completes the proof. \square

6 Correctness of Algorithm 1

For a B -namu $\Gamma = (T, \alpha, \lambda, U)$ and a subtree T' of T , we say that a B -namu $\Gamma' = (T', \alpha', \lambda', U)$ is *induced by T' from Γ* if $\alpha'(v, e) = \alpha(v, e)$ and $\lambda'(e) = \lambda(e)$ for every incidence (v, e) of T' .

For a finite field \mathbb{F} and a positive integer r , let \mathcal{V} be a subspace arrangement of subspaces of \mathbb{F}^r . Let (T^b, \mathcal{L}^b) be a rooted branch-decomposition of \mathcal{V} and let k be a nonnegative integer. For a node x of T^b and a branch-decomposition (T, \mathcal{L}) of \mathcal{V}_x , the *reduced B_x -namu of (T, \mathcal{L})* is the B_x -namu induced by a subtree T' of T from the canonical B_x -namu of (T, \mathcal{L}) where T' is obtained by the following rule.

- If (T, \mathcal{L}) is x -degenerate, then T' is a subtree having only one node of T .
- If (T, \mathcal{L}) is not x -degenerate, then T' is a subtree of T obtained by deleting all nodes v such that (u, v) is x -protected in (T, \mathcal{L}) .

For a node x of T^b and a branch-decomposition (T, \mathcal{L}) of \mathcal{V}_x , we say that (T, \mathcal{L}) is *k -safe with respect to x* if for every edge uv of T such that (u, v) is x -protected,

$$\dim \left(\sum_{s \in A_v(T-uv)} \mathcal{L}(s) \cap \sum_{t \in A_u(T-uv)} \mathcal{L}(t) \right) + \dim B_x - \dim \left(B_x \cap \sum_{t \in A_u(T-uv)} \mathcal{L}(t) \right) \leq k.$$

For each node x of T^b , we define *the full set at x of width k with respect to (T^b, \mathcal{L}^b)* as the set of all Γ in $U_k(B_x)$ such that $\Delta \preceq \Gamma$ for the reduced B_x -namu Δ of some branch-decomposition

(T, \mathcal{L}) of \mathcal{V}_x having width at most k which is k -safe with respect to x , and totally pure with respect to (T^b, \mathcal{L}^b) . We write it $\text{FS}_k(x; T^b, \mathcal{L}^b)$ or $\text{FS}_k(x)$ for brevity. In this section, we aim to show that the full set is precisely the set computed in Algorithm 1.

Proposition 6.12. For every node x of T^b , $\text{FS}_k(x)$ is equal to \mathcal{F}_x in Algorithm 1.

Proposition 6.12 combined with Proposition 4.6 allows us to show that Algorithm 1 is correct.

Proposition 6.1. *Let k be a nonnegative integer. Let (T^b, \mathcal{L}^b) be a rooted branch-decomposition of a subspace arrangement \mathcal{V} and for each node x of T^b , let \mathcal{F}_x be the set computed by Algorithm 1. The branch-width of \mathcal{V} is at most k if and only if $\mathcal{F}_r \neq \emptyset$ at the root node r of T^b .*

Proof. By Proposition 4.6, if the branch-width of \mathcal{V} is at most k , then \mathcal{V} has a branch-decomposition (T, \mathcal{L}) of width at most k that is totally pure with respect to (T^b, \mathcal{L}^b) . Note that (T, \mathcal{L}) is k -safe with respect to the root r of T^b because $B_r = \{0\}$. Let Δ be the reduced B_r -namu of (T, \mathcal{L}) . Then $\tau(\Delta)$ is in $\text{FS}_k(r)$ because $\Delta \preceq \tau(\Delta)$. By Proposition 6.12, $\text{FS}_k(r) = \mathcal{F}_r$ and thus \mathcal{F}_r is nonempty.

If $\Gamma \in \mathcal{F}_r$, then $\Gamma \in \text{FS}_k(r)$ by Proposition 6.12. So there exists a branch-decomposition of $\mathcal{V}_r = \mathcal{V}$ whose width is at most k . \square

The following proposition gives a relation between full sets and witnesses.

Proposition 6.2. *Let (T^b, \mathcal{L}^b) be a branch-decomposition of a subspace arrangement \mathcal{V} and let x be a node of T^b and $\Gamma \in U_k(B_x)$. Then $\Gamma \in \text{FS}_k(x)$ if and only if there exists a k -safe \mathcal{V}_x -labeling (ζ, \mathcal{L}) of $T(\Gamma)$ that is a witness of Γ in B_x such that every y -protected edge in $(\mathbb{T}(\zeta), \mathcal{L})$ is in ζ for every node $y \leq x$ of T^b .*

Proof. For the forward direction, suppose a B_x -namu Γ is in $\text{FS}_k(x)$. Then, by definition, there exists a branch-decomposition (T, \mathcal{L}) of \mathcal{V}_x such that

- the width of (T, \mathcal{L}) is at most k ,
- (T, \mathcal{L}) is k -safe with respect to x ,
- (T, \mathcal{L}) is totally pure with respect to (T^b, \mathcal{L}^b) , and
- $\Delta \preceq \Gamma$ for the reduced B_x -namu Δ of (T, \mathcal{L}) .

Let $T' = T(\Delta)$ be a subtree of T . For every incidence (v, e) of T' , let $\zeta(v, e)$ be the empty sequence, and for every node v of degree at most 2 in T' , let $\zeta(v)$ be the component of $T - E(T')$ containing v , viewed as a rooted binary tree with the root v . Then, it is clear that (ζ, \mathcal{L}) is a \mathcal{V}_x -labeling of T' . Furthermore $T = \mathbb{T}(\zeta)$ if (T, \mathcal{L}) is not x -degenerate and $\mathbb{T}(\zeta)$ is obtained from T by subdividing an improper x -degenerate edge if (T, \mathcal{L}) is x -degenerate. By definition, it is easy to see that (ζ, \mathcal{L}) is a witness of Δ in B_x . Because (T, \mathcal{L}) is k -safe with respect to x , by definition, the k -safe inequality holds for every edge in ζ , and so (ζ, \mathcal{L}) is k -safe.

For a node y of T^b with $y \leq x$ and a y -protected edge uv in $(\mathbb{T}(\zeta), \mathcal{L})$, if uv is y -blocked and uv y -guards v , then by Lemma 4.8, uv is x -blocked and uv x -guards v because $(\mathbb{T}(\zeta), \mathcal{L})$ is y -pure. So (u, v) is x -protected in $(\mathbb{T}(\zeta), \mathcal{L})$. If there exists a node z of T^b with $z \leq y$ such that uv cuts \mathcal{V}_z , (T, \mathcal{L}) is z -degenerate, and $\mathcal{L}(\mathbb{T}(\zeta), u, v) \subseteq \mathcal{V}_z$, then (u, v) is x -protected in $(\mathbb{T}(\zeta), \mathcal{L})$ because $z \leq y \leq x$. Thus, every y -protected edge in $(\mathbb{T}(\zeta), \mathcal{L})$ is x -protected in $(\mathbb{T}(\zeta), \mathcal{L})$ and so it is in ζ because of the definitions of T' and ζ .

As $\Delta \preceq \Gamma$, by Proposition 5.33, there exists a k -safe \mathcal{V}_x -labeling (ζ', \mathcal{L}) of $T(\Gamma)$ that is a witness of Γ in B_x . This completes the proof of the forward direction.

It remains to prove the backward direction. Suppose a B_x -namu $\Gamma = (T, \alpha, \lambda, U)$ is in $U_k(B_x)$ and a k -safe \mathcal{V}_x -labeling (ζ, \mathcal{L}) of T is a witness of Γ in B_x . By the definition of witnesses, $(\mathbb{T}(\zeta), \mathcal{L})$ is k -safe with respect to x and totally pure with respect to (T^b, \mathcal{L}^b) . Since (ζ, \mathcal{L}) is k -safe and Γ has width at most k , the width of $(\mathbb{T}(\zeta), \mathcal{L})$ is at most k .

Let Δ be the reduced B_x -namu of $(\mathbb{T}(\zeta), \mathcal{L})$. It remains to show that $\Delta \preceq \Gamma$. If $(\mathbb{T}(\zeta), \mathcal{L})$ is x -degenerate, then both $T(\Delta)$ and T have only one node and so $\Delta \preceq \Gamma$. Suppose $(\mathbb{T}(\zeta), \mathcal{L})$ is not x -degenerate. Then, by definition, $T(\Delta)$ is a subtree of $\mathbb{T}(\zeta)$ obtained by deleting all nodes v such that (u, v) is x -protected in $(\mathbb{T}(\zeta), \mathcal{L})$. Since every x -protected edge in $(\mathbb{T}(\zeta), \mathcal{L})$ is in ζ and the condition (iv) of witnesses holds, an edge is x -protected in $(\mathbb{T}(\zeta), \mathcal{L})$ if and only if the edge is in ζ . Recall that $\mathbb{T}(\zeta)$ is obtained from T by

- (i) subdividing each edge uv of T $|\zeta(u, uv)| + |\zeta(v, uv)|$ times,
- (ii) attaching the i th rooted binary tree in $\zeta(u, uv)$ whose root is identified with the i th new subdividing internal node on the path from u to v for each incidence (u, uv) of T and $1 \leq i \leq |\zeta(u, uv)|$,
- (iii) attaching $\zeta(v)$ for all $v \in V(T)$ of degree at most 2 whose root is identified with v , and
- (iv) smoothing v for each $v \in V(T)$ with $\deg_T(v) = 2$ and $|V(\zeta(v))| = 1$.

Therefore, $T(\Delta)$ is a tree obtained from T by subdividing each edge uv of T $|\zeta(u, uv)| + |\zeta(v, uv)|$ times and smoothing w for each node $w \in V(T)$ with $\deg_T(w) = 2$ and $|V(\zeta(w))| = 1$. Note that if a node w of T has exactly two neighbors w_1 and w_2 in T and $|V(\zeta(w))| = 1$, then we have $\alpha(w_1, w_1w) = \alpha(w, ww_2)$ and $\alpha(w, w_1w) = \alpha(w_2, ww_2)$. Since both Δ and Γ are induced from the canonical B_x -namu of $(\mathbb{T}(\zeta), \mathcal{L})$, we observe that $\Delta \preceq \Gamma$. This completes the proof. \square

6.1 At a leaf node

Proposition 6.3. *Let ℓ be a leaf of T^b with $V = \mathcal{L}^b(\ell)$ and let k be a nonnegative integer. Let $\Delta_\ell = (T, \alpha, \lambda, B_\ell)$ be the B_ℓ -namu such that T is a tree with $V(T) = \{1\}$. Then $\text{FS}_k(\ell) = \{\Delta_\ell\}$.*

Proof. Trivially, Δ_ℓ is in $\text{FS}_k(\ell)$.

If $\Gamma \in \text{FS}_k(\ell)$, then there exists a branch-decomposition (T, \mathcal{L}) of $\mathcal{V}_\ell = \{V\}$ such that $\Delta \preceq \Gamma$ for the reduced B_x -namu Δ of (T, \mathcal{L}) . Since $\Gamma \in U_k(B_\ell)$, $V(T(\Gamma)) = \{1\}$ and so $V(T) = \{1\}$. Thus, (T, \mathcal{L}) is the unique branch-decomposition of $\{V\}$, which implies that $\Delta = \Delta_\ell$. As $T(\Delta_\ell)$ has no edge, $\Delta_\ell \preceq \Gamma$ implies that $\Delta_\ell = \Gamma$. Therefore, $\text{FS}_k(\ell) = \{\Delta_\ell\}$. \square

6.2 At an internal node

For a subspace B of \mathbb{F}^r and a set \mathcal{R} of B -namus, the set $\text{up}_k(\mathcal{R}, B)$ is the collection of all B -namus $\Gamma \in U_k(B)$ with $\text{trim}(\Gamma') \preceq \Gamma$ for some $\Gamma' \in \mathcal{R}$ such that Γ' is a k -safe extension of $\text{trim}(\Gamma')$. In the following two propositions, we prove that

$$\text{FS}_k(x) = \text{up}_k((\text{FS}_k(x_1) \oplus \text{FS}_k(x_2))|_{B_x}, B_x)$$

if x has two children x_1 and x_2 in T^b . First, we prove the inclusion in one direction.

Proposition 6.4. *Let x_1 and x_2 be two children of a node x in T^b and let k be a nonnegative integer. If $\Gamma \in \text{up}_k((\text{FS}_k(x_1) \oplus \text{FS}_k(x_2))|_{B_x}, B_x)$, then $\Gamma \in \text{FS}_k(x)$.*

Proof. Since $\Gamma \in \text{up}_k((\text{FS}_k(x_1) \oplus \text{FS}_k(x_2))|_{B_x}, B_x)$, there exist $\Gamma_1 \in \text{FS}_k(x_1)$, $\Gamma_2 \in \text{FS}_k(x_2)$, and their sum Γ^+ such that $\text{trim}(\Gamma^+|_{B_x}) \preceq \Gamma$ and $\Gamma^+|_{B_x}$ is a k -safe extension of $\text{trim}(\Gamma^+|_{B_x})$. By Proposition 6.2, for each $i = 1, 2$, there exists a k -safe \mathcal{V}_{x_i} -labeling (ζ_i, \mathcal{L}_i) that is a witness of Γ_i in B_{x_i} such that every y -protected edge in $(\mathbb{T}(\zeta_i), \mathcal{L}_i)$ is in ζ_i for every node $y \leq x_i$ of T^b . Then, by Propositions 5.28, 5.29, 5.30, and 5.33, we can find a k -safe \mathcal{V}_x -labeling (ζ, \mathcal{L}) such that it is a witness of Γ in B_x and $(\mathbb{T}(\zeta), \mathcal{L})$ is in ζ for every node $y \leq x$ of T^b . By Proposition 6.2, Γ is in the full set at x of width k with respect to (T^b, \mathcal{L}^b) . \square

For the other inclusion, we will prove the following proposition.

Proposition 6.5. *Let x_1 and x_2 be two children of a node x in T^b and let k be a nonnegative integer. If $\Gamma \in \text{FS}_k(x)$, then $\Gamma \in \text{up}_k((\text{FS}_k(x_1) \oplus \text{FS}_k(x_2))|_{B_x}, B_x)$.*

In order to prove Proposition 6.5, we need some lemmas.

Lemma 6.6. *Let B, B' be subspaces of \mathbb{F}^r . Let (T, \mathcal{L}) be a branch-decomposition of a subspace arrangement \mathcal{V} . Let Γ and Γ' be the canonical B -namu and B' -namu of (T, \mathcal{L}) , respectively. If $\langle \mathcal{V} \rangle \cap B' \subseteq B$ and $\langle \mathcal{V} \rangle \cap B \subseteq B'$, then $\Gamma = \Gamma'$.*

Proof. Let $\Gamma = (T, \alpha, \lambda, U)$ and $\Gamma' = (T, \alpha', \lambda', U')$. Let $e = uv$ be an edge of T . Then by definition

$$\lambda(uv) = \dim \left(\sum_{x \in A_u(T-e)} \mathcal{L}(x) \cap \sum_{y \in A_v(T-e)} \mathcal{L}(y) \right) = \lambda'(uv).$$

By the symmetry of B and B' , it is enough to show that for each incidence (v, e) of T , $\alpha(v, e) \subseteq \alpha'(v, e)$, and $U \subseteq U'$. Because $\mathcal{L}(x)$ is in \mathcal{V} for every leaf x of T , we have

$$\begin{aligned} \alpha(v, e) &= B \cap \sum_{x \in A_v(T-e)} \mathcal{L}(x) = B \cap \langle \mathcal{V} \rangle \cap \sum_{x \in A_v(T-e)} \mathcal{L}(x) \\ &\subseteq B' \cap \sum_{x \in A_v(T-e)} \mathcal{L}(x) = \alpha'(v, e), \\ U &= B \cap \sum_{x \in A(T)} \mathcal{L}(x) = B \cap \langle \mathcal{V} \rangle \cap \sum_{x \in A(T)} \mathcal{L}(x) \subseteq B' \cap \sum_{x \in A(T)} \mathcal{L}(x) = U', \end{aligned}$$

which complete the proof. \square

Lemma 6.7. *Let x_1 and x_2 be two children of a node x in T^b . Let (T, \mathcal{L}) be a branch-decomposition of \mathcal{V}_x and let $(T_i, \mathcal{L}_i) = (T, \mathcal{L})|_{\mathcal{V}_{x_i}}$ for every $i = 1, 2$. If Γ^+ is the canonical $(B_{x_1} + B_{x_2})$ -namu of (T, \mathcal{L}) and Γ_i is the canonical B_{x_i} -namu of (T_i, \mathcal{L}_i) for every $i = 1, 2$, then*

- $\Gamma^+|_{B_x}$ is the canonical B_x -namu of (T, \mathcal{L}) ,
- Γ_i is the canonical $(B_{x_1} + B_{x_2})$ -namu of (T_i, \mathcal{L}_i) for every $i = 1, 2$, and
- Γ^+ is a sum of Γ_1 and Γ_2 .

Proof. It is easy to check by definition that $\Gamma^+|_{B_x}$ is the canonical B_x -namu of (T, \mathcal{L}) .

By Lemma 5.27, $\langle \mathcal{V}_{x_1} \rangle \cap (B_{x_1} + B_{x_2}) \subseteq B_{x_1}$. Then, by Lemma 6.6, Γ_1 is the canonical $(B_{x_1} + B_{x_2})$ -namu of (T_1, \mathcal{L}_1) and Γ_2 is the canonical $(B_{x_1} + B_{x_2})$ -namu of (T_2, \mathcal{L}_2) .

We have $(\langle \mathcal{V}_{x_1} \rangle + B_{x_1} + B_{x_2}) \cap (\langle \mathcal{V}_{x_2} \rangle + B_{x_1} + B_{x_2}) = B_{x_1} + B_{x_2}$ by Lemma 5.27. Thus, by Lemma 5.11, Γ^+ is a sum of Γ_1 and Γ_2 . \square

Lemma 6.8. *Let x_1 and x_2 be two children of a node x in T^b . Let (T, \mathcal{L}) be a branch-decomposition of \mathcal{V}_x that is totally pure with respect to (T^b, \mathcal{L}^b) and let $(T_i, \mathcal{L}_i) = (T, \mathcal{L})|_{\mathcal{V}_{x_i}}$ for every $i = 1, 2$. If (T, \mathcal{L}) is k -safe with respect to x , then (T_i, \mathcal{L}_i) is k -safe with respect to x_i for every $i = 1, 2$.*

Proof. Let uv be an edge of T_1 such that (u, v) is x_1 -protected in (T_1, \mathcal{L}_1) . We claim that there exists an edge $u'v'$ of T corresponding to uv such that (u', v') is x -protected in (T, \mathcal{L}) . If there exists a node z of T^b such that $z \leq x_1$, (T_1, \mathcal{L}_1) is z -degenerate, uv cuts \mathcal{V}_z , and $\mathcal{L}(T_1, u, v) \subseteq \mathcal{V}_z$, then (u, v) itself is x -protected in (T, \mathcal{L}) because $z \leq x$, (T, \mathcal{L}) is z -degenerate, and $\mathcal{L}(T, u, v) \subseteq \mathcal{V}_z$. If uv is x_1 -blocked and uv x_1 -guards v , then there exists an edge $u'v'$ of T such that $u'v'$ x_1 -guards v' and $\mathcal{L}(T, u', v') \subseteq \mathcal{V}_{x_1}$ because (T, \mathcal{L}) is x_1 -pure. By Lemma 4.8, (u', v') is x -protected in (T, \mathcal{L}) , which completes the proof of the claim.

Let $\Gamma^+ = (T, \alpha, \lambda, U)$ be the canonical $(B_{x_1} + B_{x_2})$ -namu of (T, \mathcal{L}) and let $\Gamma_i = (T_i, \alpha_i, \lambda_i, U_i)$ be the canonical B_{x_i} -namu of (T_i, \mathcal{L}_i) for every $i = 1, 2$. By Lemma 6.7, $\Gamma^+ = \Gamma_1 +_{(\eta_1, \eta_2)} \Gamma_2$. If $e = uv$ is an edge of T_1 such that (u, v) is x_1 -protected in (T_1, \mathcal{L}_1) and $e' = u'v'$ is the edge corresponding to uv as above, then $\alpha_2(\vec{\eta}_2(u', e')) = U_2$, $\alpha_2(\vec{\eta}_2(v', e')) = \{0\}$, $U_1 = B_{x_1}$, $U_2 = B_{x_2}$, and $\alpha_1(u, e) \subseteq B_{x_1} \subseteq B_{x_2} + B_x$. Therefore,

$$\begin{aligned}
& \dim\left(\sum_{s \in A_{v'}(T-e')} \mathcal{L}(s) \cap \sum_{t \in A_{u'}(T-e')} \mathcal{L}(t)\right) + \dim(\langle \mathcal{V}_x \rangle \cap B_x) - \dim(B_x \cap \sum_{t \in A_{u'}(T-e')} \mathcal{L}(t)) \\
&= \lambda(e') + \dim(U \cap B_x) - \dim(\alpha(u', e') \cap B_x) \\
&= \lambda_1(\eta_1(e')) + \lambda_2(\eta_2(e')) + \dim((U_1 + U_2) \cap B_x) \\
&\quad - \dim\left(\left(\alpha_1(\vec{\eta}_1(u', e')) + \alpha_2(\vec{\eta}_2(u', e'))\right) \cap B_x\right) \\
&\quad + \dim(U_1 \cap U_2) - \dim(\alpha_1(\vec{\eta}_1(v', e')) \cap \alpha_2(\vec{\eta}_2(v', e'))) \\
&\quad - \dim(\alpha_1(\vec{\eta}_1(u', e')) \cap \alpha_2(\vec{\eta}_2(u', e'))) \\
&= \lambda_1(e) - \dim \alpha_1(u, e) - \dim U_2 + \dim(\alpha_1(u, e) + U_2) + \dim U_1 + \dim U_2 \\
&\quad - \dim(U_1 + U_2) - \dim((\alpha_1(u, e) + U_2) \cap B_x) + \dim((U_1 + U_2) \cap B_x) \\
&= \lambda_1(e) - \dim \alpha_1(u, e) + \dim U_1 - \dim(\alpha_1(u, e) + U_2 + B_x) + \dim(U_1 + U_2 + B_x) \\
&= \lambda_1(e) - \dim \alpha_1(u, e) + \dim U_1.
\end{aligned}$$

As (T, \mathcal{L}) is k -safe with respect to x , we have

$$\begin{aligned}
k &\geq \dim\left(\sum_{s \in A_{v'}(T-e')} \mathcal{L}(s) \cap \sum_{t \in A_{u'}(T-e')} \mathcal{L}(t)\right) + \dim(\langle \mathcal{V}_x \rangle \cap B_x) - \dim\left(B_x \cap \sum_{t \in A_{u'}(T-e')} \mathcal{L}(t)\right) \\
&= \lambda_1(e) - \dim \alpha_1(u, e) + \dim U_1.
\end{aligned}$$

This implies that (T_1, \mathcal{L}_1) is k -safe with respect to x_1 . Similarly, (T_2, \mathcal{L}_2) is k -safe with respect to x_2 . \square

Lemma 6.9. *Let x_1 be a child of a node x in T^b . Let (T, \mathcal{L}) be a branch-decomposition of \mathcal{V}_x that is totally pure with respect to (T^b, \mathcal{L}^b) and let $(T_1, \mathcal{L}_1) = (T, \mathcal{L})|_{\mathcal{V}_{x_1}}$. For a node v of T_1 , if v is x_1 -protected in (T_1, \mathcal{L}_1) , then v is also x_1 -protected in (T, \mathcal{L}) .*

Proof. Let uv be an edge of T_1 such that (u, v) is x_1 -protected in (T_1, \mathcal{L}_1) . Then, by the construction of T_1 , u and v are nodes of T . If u, v are adjacent in T , then it is obvious that (u, v) is x_1 -protected in (T, \mathcal{L}) . Thus, we may assume that u, v are not adjacent. Let p be the neighbor of v closer to u and q be the neighbor of p not on the path from u to v .

If uv is x_1 -blocked and x_1 -guards v in (T_1, \mathcal{L}_1) , then pv is x_1 -blocked and x_1 -guards v in (T, \mathcal{L}) . Thus, v is x_1 -protected in (T, \mathcal{L}) .

We may assume that there exists a node z of T^b with $z \leq x_1$ such that uv cuts \mathcal{V}_z in (T_1, \mathcal{L}_1) , (T_1, \mathcal{L}_1) is z -degenerate, and $\mathcal{L}_1(T_1, u, v) \subseteq \mathcal{V}_z$. As (T_1, \mathcal{L}_1) is z -degenerate, so is (T, \mathcal{L}) . Since (T, \mathcal{L}) is z -pure, it is z -disjoint and thus T has an edge ww' such that $\mathcal{L}(T, w', w) = \mathcal{V}_z$. If $p \neq w$, then $\mathcal{L}(T, p, q) \subseteq \mathcal{V}_z \subseteq \mathcal{V}_{x_1}$ and so p is a node of T_1 . This means that uv is not an edge of T_1 and thus it is a contradiction. If $p = w$, then an edge $wv = pv$ of T cuts \mathcal{V}_z in (T, \mathcal{L}) , (T, \mathcal{L}) is z -degenerate, and $\mathcal{L}(T, p, v) \subseteq \mathcal{V}_z \subseteq \mathcal{V}_{x_1}$. So, (p, v) is x_1 -protected in (T, \mathcal{L}) . \square

Lemma 6.10. *Let x_1 and x_2 be two children of a node x in T^b . Let (T, \mathcal{L}) be a branch-decomposition of \mathcal{V}_x that is totally pure with respect to (T^b, \mathcal{L}^b) and let $(T_i, \mathcal{L}_i) = (T, \mathcal{L})|_{\mathcal{V}_{x_i}}$ for every $i = 1, 2$. For every $i = 1, 2$, let P_i be the set of all x_i -protected nodes v in (T_i, \mathcal{L}_i) . If T' is the subtree of T obtained by removing all nodes in $P_1 \cup P_2$ and Γ' is the $(B_{x_1} + B_{x_2})$ -namu induced by T' from the canonical $(B_{x_1} + B_{x_2})$ -namu of (T, \mathcal{L}) , then $\text{trim}(\Gamma'|_{B_x})$ is equal to the reduced B_x -namu of (T, \mathcal{L}) .*

Proof. Note that by Lemmas 5.24 and 6.9, a graph T' of T obtained by removing all nodes in $P_1 \cup P_2$ is a tree. Let Δ be the reduced B_x -namu of (T, \mathcal{L}) . By Lemma 6.7, $\Gamma'|_{B_x}$ is induced by T' from the canonical B_x -namu of (T, \mathcal{L}) . So it is enough to show that $T(\text{trim}(\Gamma'|_{B_x}))$ is equal to $T(\Delta)$.

If (T, \mathcal{L}) is x -degenerate, then it is trivial because both trees have only one node. Therefore, we may assume that (T, \mathcal{L}) is not x -degenerate. Recall that $V(T) - V(T(\Delta))$ is the set of all x -protected nodes v in (T, \mathcal{L}) . By definition, $V(T) - V(T(\Gamma'|_{B_x}))$ is the set of all nodes v that is x_1 -protected in (T_1, \mathcal{L}_1) or x_2 -protected in (T_2, \mathcal{L}_2) , and $V(T(\Gamma'|_{B_x})) - V(T(\text{trim}(\Gamma'|_{B_x})))$ is the set of all nodes v such that v is blocked in $\Gamma'|_{B_x}$. Since (T, \mathcal{L}) is not x -degenerate, for a node v of T , v is x -protected in (T, \mathcal{L}) if and only if

- v is x_1 -protected in (T_1, \mathcal{L}_1) , or
- v is x_2 -protected in (T_2, \mathcal{L}_2) , or
- an edge uv of T is x -blocked and x -guards v .

Therefore, $V(T) - V(T(\Delta))$ is equal to $V(T) - V(T(\text{trim}(\Gamma'|_{B_x})))$. This completes the proof. \square

Lemma 6.11. *Let x_1 and x_2 be two children of a node x in T^b . Let (T, \mathcal{L}) be a branch-decomposition of \mathcal{V}_x that is totally pure with respect to (T^b, \mathcal{L}^b) and k -safe with respect to x and let $(T_i, \mathcal{L}_i) = (T, \mathcal{L})|_{\mathcal{V}_{x_i}}$ for every $i = 1, 2$. Let Δ_i be the reduced B_{x_i} -namu of (T_i, \mathcal{L}_i) for every $i = 1, 2$. If Γ' is the $(B_{x_1} + B_{x_2})$ -namu defined in Lemma 6.10, then there exists $\Delta^+ \in \tau(\Delta_1) \oplus \tau(\Delta_2)$ such that $\Delta^+ \preceq \Gamma'$ and $\Delta^+|_{B_x}$ is a k -safe extension of $\text{trim}(\Delta^+|_{B_x})$.*

Proof. We will first show that Γ' is a sum of Δ_1 and Δ_2 . By Lemma 6.7, the canonical $(B_{x_1} + B_{x_2})$ -namu Γ^+ of (T, \mathcal{L}) is a sum of the canonical B_{x_1} -namu Γ_1 of (T_1, \mathcal{L}_1) and the canonical B_{x_2} -namu Γ_2 of (T_2, \mathcal{L}_2) . We remark that, by definition, Γ' is induced from Γ^+ and Δ_i is induced from Γ_i for each $i = 1, 2$. By Lemma 6.9, for a node v of T_1 , if v is x_1 -protected in (T_1, \mathcal{L}_1) , then v is x_1 -protected in (T, \mathcal{L}) . And for an edge uv of T , if (u, v) is x_1 -protected in (T, \mathcal{L}) , then it is clear that uv does not cut \mathcal{V}_{x_2} in (T, \mathcal{L}) . Thus, $V(T) - V(T(\Gamma'))$ is the disjoint union of $V(T_1) - V(T(\Delta_1))$ and $V(T_2) - V(T(\Delta_2))$. So we conclude that Γ' is a sum of Δ_1 and Δ_2 .

Since Δ_1 and Δ_2 are trimmed, by Lemma 5.14 and Proposition 5.18, there exists $\Delta^+ \in \tau(\Delta_1) \oplus \tau(\Delta_2)$ such that $\Delta^+ \preceq \Gamma'$.

Now we will show that $\Gamma'|_{B_x} = (T', \alpha', \lambda', U')$ is a k -safe extension of $\text{trim}(\Gamma'|_{B_x})$. By Lemma 6.7, $\Gamma'|_{B_x}$ is induced from the canonical B_x -namu of (T, \mathcal{L}) . If e is an edge of $T(\Gamma'|_{B_x})$ that is removed by trimming $\Gamma'|_{B_x}$, then e is x -protected in (T, \mathcal{L}) . If u, v are the ends of e and (u, v) is x -protected, then

$$\lambda'(e) + \dim U' - \dim \alpha'(u, e) \leq k$$

because (T, \mathcal{L}) is k -safe. Thus, $\Gamma'|_{B_x}$ is a k -safe extension of $\text{trim}(\Gamma'|_{B_x})$.

Since $\Delta^+ \preceq \Gamma'$, by Lemmas 5.22 and 5.23, we conclude that $\Delta^+|_{B_x}$ is a k -safe extension of $\text{trim}(\Delta^+|_{B_x})$. \square

Here we give the proof of Proposition 6.5.

Proof of Proposition 6.5. By definition, there exists a branch-decomposition (T, \mathcal{L}) of \mathcal{V}_x such that

- the width of (T, \mathcal{L}) is at most k ,
- (T, \mathcal{L}) is k -safe with respect to x ,
- (T, \mathcal{L}) is totally pure with respect to (T^b, \mathcal{L}^b) , and
- $\Delta \preceq \Gamma$ for the reduced B_x -namu Δ of (T, \mathcal{L}) .

For every $i = 1, 2$, let $(T_i, \mathcal{L}_i) = (T, \mathcal{L})|_{\mathcal{V}_{x_i}}$ and let Δ_i be the reduced B_{x_i} -namu of (T_i, \mathcal{L}_i) . We first claim that $\tau(\Delta_1) \in \text{FS}_k(x_1)$. Since the width of (T_1, \mathcal{L}_1) is at most the width of (T, \mathcal{L}) , the width of (T_1, \mathcal{L}_1) is at most k . By Lemma 4.17, (T_1, \mathcal{L}_1) is totally pure with respect to (T^b, \mathcal{L}^b) . Also, by Lemma 6.8, (T_1, \mathcal{L}_1) is k -safe with respect to x_1 . It is clear that $\Delta_1 = \text{trim}(\Delta_1) \preceq \tau(\Delta_1)$ by Lemma 5.14. Since $\tau(\Delta_1) \in U_k(B_{x_1})$, we conclude that $\tau(\Delta_1) \in \text{FS}_k(x_1)$. Similarly, $\tau(\Delta_2) \in \text{FS}_k(x_2)$.

Let T' be the subgraph of T obtained by removing all nodes v that is x_1 -protected in (T_1, \mathcal{L}_1) or is x_2 -protected in (T_2, \mathcal{L}_2) . Note that such v is a node of T by Lemma 6.9 and T' is a tree by Lemma 5.24. Let Γ' be the $(B_{x_1} + B_{x_2})$ -namu induced by T' from the canonical $(B_{x_1} + B_{x_2})$ -namu of (T, \mathcal{L}) . By Lemma 6.11, there exists $\Delta^+ \in \tau(\Delta_1) \oplus \tau(\Delta_2)$ such that $\Delta^+ \preceq \Gamma'$ and $\Delta^+|_{B_x}$ is a k -safe extension of $\text{trim}(\Delta^+|_{B_x})$. By Lemmas 5.15 and 5.22, $\Delta^+ \preceq \Gamma'$ implies that $\text{trim}(\Delta^+|_{B_x}) \preceq \text{trim}(\Gamma'|_{B_x})$. By Lemma 6.10, $\text{trim}(\Gamma'|_{B_x}) = \Delta$. Then, by Lemma 5.12 together with $\Delta \preceq \Gamma$, we conclude that $\text{trim}(\Delta^+|_{B_x}) \preceq \Gamma$. Therefore, since $\Delta^+|_{B_x}$ is a k -safe extension of $\text{trim}(\Delta^+|_{B_x})$, Γ is in $\text{up}_k((\text{FS}_k(x_1) \oplus \text{FS}_k(x_2))|_{B_x}, B_x)$. \square

Now we are ready to prove Proposition 6.12.

Proposition 6.12. *For every node x of T^b , $\text{FS}_k(x)$ is equal to \mathcal{F}_x in Algorithm 1.*

Proof. We use induction on the number of steps executed by FULL-SET($\mathcal{V}, k, (T^b, \mathcal{L}^b), \{T_v\}_{v \in V(T^b)}$). For a leaf node, it is trivial by Proposition 6.3. From line 10 to line 13, we observe that if x is an internal node with two children x_1 and x_2 in T^b , then $\mathcal{F}_x = \text{up}_k((\mathcal{F}_{x_1} \oplus \mathcal{F}_{x_2})|_{B_x}, B_x)$. By the induction hypothesis and by Propositions 6.4 and 6.5, we conclude that $\mathcal{F}_x = \text{FS}_k(x)$. \square

7 The algorithm

In this section we present an algorithm to perform the following task.

BRANCH-WIDTH

Parameters: A finite field \mathbb{F} and an integer k .

Input: An $r \times m$ matrix M over \mathbb{F} with an ordered partition $\mathcal{I} = \{I_1, I_2, \dots, I_n\}$ of $\{1, 2, \dots, m\}$ and an integer k .

Output: A branch-decomposition (T, \mathcal{L}) of width at most k of a subspace arrangement \mathcal{V} consisting of the column space of $M[I_i]$ for each i or a confirmation that the branch-width of \mathcal{V} is larger than k .

If such a branch-decomposition exists, then we say that (M, \mathcal{I}, k) is a YES instance. Otherwise, it is a NO instance.

7.1 Basic operations

Let \mathbb{F} be a field and r be a positive integer. The *sum* of two subspaces X and Y of \mathbb{F}^r is denoted by $X + Y$ and is defined as $\{\mathbf{x} + \mathbf{y} : \mathbf{x} \in X, \mathbf{y} \in Y\}$. Let B and B' be two subspaces of \mathbb{F}^r such that $B' \subseteq B$, where B comes with a fixed ordered basis \mathfrak{B} . We say that a $\dim B \times \dim B'$ matrix $M_{B,B'}$ over \mathbb{F} *represents* B' with respect to \mathfrak{B} if the i th column of $M_{B,B'}$ is the coordinate vector of the i th element of *some* fixed ordered basis \mathfrak{B}' of B' with respect to \mathfrak{B} . Let \mathfrak{C} be a basis of a subspace C such that $\mathfrak{B} \subseteq \mathfrak{C}$. Then there exists the unique $|\mathfrak{C}| \times |\mathfrak{B}|$ matrix P over \mathbb{F} such that

$$P[x]_{\mathfrak{B}} = [x]_{\mathfrak{C}}$$

for all $x \in \langle \mathfrak{B} \rangle$. (For a vector x in a vector space with a basis \mathfrak{B} over a field \mathbb{F} , $[x]_{\mathfrak{B}}$ denotes the coordinate vector with respect to the basis \mathfrak{B} , which is a $|\mathfrak{B}| \times 1$ matrix over \mathbb{F} .) This matrix P is called the *transition matrix* from \mathfrak{B} to \mathfrak{C} .

Given two matrices $M_{B,B'}$ and $M_{B,B''}$ representing two subspaces B' and B'' of B with respect to \mathfrak{B} , we can do the following operations; let $d := \dim B$:

- We can decide whether $B' \subseteq B''$ with $O(d^3)$ elementary field operations on \mathbb{F} . Note that $B' \subseteq B''$ if and only if the column space of $M_{B,B'}$ is contained in the column space of $M_{B,B''}$, or equivalently, the basis of B' is contained in the column space of $M_{B,B''}$. The latter holds if and only if the equation $M_{B,B''}X = M_{B,B'}$ is feasible. The equation can be solved with $O(d^3)$ elementary field operations on \mathbb{F} .
- We can compute the sum $B' + B''$, whose output is a matrix representing it, with $O(d^3)$ elementary field operations on \mathbb{F} . This can be done by computing the basis of the column vectors in the matrix $[M_{B,B'} \quad M_{B,B''}]$.

- We can compute the matrix representing $B' \cap B''$ with $O(d^3)$ elementary field operations on \mathbb{F} . The basis $\begin{bmatrix} M_x \\ M_y \end{bmatrix}$ of the null space of $[M_{B,B'} \quad -M_{B,B''}]$ can be computed using Gaussian elimination so that $M_{B,B'}M_x - M_{B,B''}M_y = 0$. Then the matrix representing $B' \cap B''$ with respect to \mathfrak{B} can be obtained from $M_{B,B'}M_x$ by repeatedly removing a column if it is spanned by other columns. The last step can be done by finding a maximal set of linearly independent column vectors of $M_{B,B'}M_x$, which can be done by reducing it to reduced row echelon form and taking columns with leading 1 of some row.

In particular, if \mathfrak{B}' is a basis of B' and $\mathfrak{B}' \subseteq \mathfrak{B}$, then the matrix representing $B' \cap B''$ with respect to \mathfrak{B}' can be easily obtained as follows: First, we obtain a matrix representation of $B' \cap B''$ with respect to \mathfrak{B} . Second, we discard rows corresponding to $\mathfrak{B} - \mathfrak{B}'$ in that matrix representation.

- If $M_{B,B'}$ is a matrix representing the subspace B' of $\langle \mathfrak{B} \rangle$ with respect to \mathfrak{B} , and P is a transition matrix from \mathfrak{B} to \mathfrak{C} , $PM_{B,B'}$ equals the matrix $M_{C,B'}$ representing B' with respect to \mathfrak{C} .

7.2 Preprocessing

We will first describe the preprocessing steps to reduce the input size. The subspace arrangement of n subspaces is given by an $r \times m$ matrix where r and m could be arbitrary large. Our aim here is to reduce r and m or confirm that branch-width is larger than k . Eventually we will convert the input into a smaller one with $r \leq m \leq kn$, described in the proof of Theorem 1.1 by using the following two lemmas. Furthermore we will convert M into the reduced row echelon form, which is crucial for our algorithm for computing the transcript of a branch-decomposition in Theorem 7.8.

Lemma 7.1 (row reduction lemma). *Let \mathbb{F} be a finite field. Given an $r \times m$ matrix M over \mathbb{F} with an ordered partition $\mathcal{I} = \{I_1, I_2, \dots, I_n\}$ of $\{1, 2, \dots, m\}$, let M' be the matrix obtained from the reduced row echelon form of M by removing zero rows. Let $\mathcal{V} = \{\text{col}(M[I_1]), \dots, \text{col}(M[I_n])\}$ and $\mathcal{V}' = \{\text{col}(M'[I_1]), \dots, \text{col}(M'[I_n])\}$.*

Then (M, \mathcal{I}, k) is a YES instance with a branch-decomposition (T, \mathcal{L}) if and only if (M', \mathcal{I}, k) is a YES instance with (T, \mathcal{L}') where \mathcal{L}' maps a leaf v to $\text{col}(M'[I_i])$ whenever \mathcal{L} maps v to $\text{col}(M[I_i])$. Moreover in time $O(rm^2)$, we can find M' and a subset B of $\{1, 2, \dots, m\}$ representing all columns of M' having the leading 1 entry of some row such that $M'[B]$ is the identity matrix.

Proof. Let M'' be the reduced echelon form of M . Then $M'' = EM$ for some invertible matrix E . Let $T_E : \mathbb{F}^r \rightarrow \mathbb{F}^r$ be a linear transformation such that $T_E(x) = Ex$. Then T_E is one-to-one and onto, and so $T_E(M[X]) = M''[X]$ for all $X \subseteq \{1, 2, \dots, m\}$. So it is clear that (M, \mathcal{I}, k) is a YES instance with a branch-decomposition (T, \mathcal{L}) if and only if (M'', \mathcal{I}, k) is a YES instance with the corresponding (T, \mathcal{L}') . We can remove zero rows in M'' to obtain M' without changing any outcome. The set B is indeed the set of column indices to apply pivot operation for finding the reduced row echelon form, thus is easy to be obtained in the algorithm. It is well known that we can get M'' and B in time $O(rm^2)$. \square

Lemma 7.2 (column reduction lemma). *Let \mathbb{F} be a finite field and let k be a nonnegative integer. Let $n \geq 2$. Let M be an $r \times m$ matrix over \mathbb{F} in reduced row echelon form with an*

ordered partition $\mathcal{I} = \{I_1, I_2, \dots, I_n\}$ of $\{1, 2, \dots, m\}$. Let V_i be the column space of $M[I_i]$ for every i .

In time $O((k+1)rmn)$, we can either find an $r \times m'$ matrix M' over \mathbb{F} and an ordered partition $\mathcal{I}' = \{I'_1, I'_2, \dots, I'_n\}$ of $\{1, 2, \dots, m'\}$ such that

- (i) the column vectors of $M'[I'_i]$ are linearly independent for every $i \in \{1, 2, \dots, n\}$,
- (ii) $|I'_i| \leq \min(|I_i|, k)$ for every $i \in \{1, 2, \dots, n\}$,
- (iii) $\text{col}(M'[I'_i]) \subseteq \text{col}(M'[\{1, 2, \dots, m'\} - I'_i])$ for every $i \in \{1, 2, \dots, n\}$,
- (iv) for all k , (M, \mathcal{I}, k) is a YES instance with a branch-decomposition (T, \mathcal{L}) if and only if (M', \mathcal{I}', k) is a YES instance with a branch-decomposition (T, \mathcal{L}') , where \mathcal{L}' maps a leaf v to $\text{col}(M'[I'_i])$ whenever \mathcal{L} maps v to $\text{col}(M[I_i])$ for every $i \in \{1, 2, \dots, n\}$,

or find $i \in \{1, 2, \dots, n\}$ such that $\dim(V_i \cap (\sum_{j \neq i} V_j)) > k$.

Proof. We may assume that M has no zero rows by deleting such rows. Let B be the set of indices of columns having the leading 1 of some row. Since M is in reduced row echelon form with no zero rows, $M[B]$ is an identity matrix.

We aim to construct a new $r \times m'$ matrix M' with an ordered partition $\mathcal{I}' = \{I'_1, I'_2, \dots, I'_n\}$ such that for each $i = 1, 2, \dots, n$, the set of the column vectors in $M'[I'_i]$ is a basis of $V'_i = V_i \cap (\sum_{j \neq i} V_j)$.

- If we find such a matrix M' with \mathcal{I}' , then (iii) and (iv) hold. To see this, we claim that for all nonempty disjoint subsets X and Y of $\{1, 2, \dots, n\}$, $(\sum_{i \in X} V_i) \cap (\sum_{j \in Y} V_j) = (\sum_{i \in X} V'_i) \cap (\sum_{j \in Y} V'_j)$. This is because if $a \in (\sum_{i \in X} V_i) \cap (\sum_{j \in Y} V_j)$, then $a = \sum_{i \in X} a_i$ for some $a_i \in V_i$ and yet $a \in \sum_{j \in Y} V_j$ and therefore for each $i \in X$, $a_i = a - \sum_{j \in X, j \neq i} a_j \in \sum_{j \neq i} V_j$. Thus, $a_i \in V'_i$ and so $a \in (\sum_{i \in X} V'_i)$. Similarly $a \in (\sum_{j \in Y} V'_j)$. This proves the claim and it immediately implies (iv). In addition, by taking $X = \{i\}$ and $Y = \{1, 2, \dots, n\} - \{i\}$, we obtain $V'_i \subseteq V_i \cap (\sum_{j \neq i} V_j) = V'_i \cap \sum_{j \neq i} V'_j \subseteq \sum_{j \neq i} V'_j$ and so (iii) holds.
- If we find an index i such that $\dim(V_i \cap (\sum_{j \neq i} V_j)) > k$, then we can stop. This means that (ii) holds if $\dim(V_i \cap (\sum_{j \neq i} V_j)) \leq k$ for all i .

Let $E = \{1, 2, \dots, m\}$. For each i , a basis of $\text{col}(M[I_i]) \cap \text{col}(M[E - I_i])$ can be found by computing a column basis of $M[B - I_i, I_i - B]$ and a column basis of $M[B \cap I_i, E - (I_i \cup B)]$ by Lemma 7.4. Since we can always stop if those column bases have more than k vectors, these two column bases can be found in time $O((k+1)rm)$ for each $i = 1, 2, \dots, n$. Thus the total running time is $O((k+1)rmn)$. \square

7.3 Data structure

Given an input matrix, we will apply the preprocessing in Subsection 7.2 as follows: We first apply the algorithm in Lemma 7.1 and then apply the algorithm in Lemma 7.2, and then finally reapply the algorithm in Lemma 7.1. After these steps, we may assume that the subspace arrangement $\mathcal{V} = \{V_1, V_2, \dots, V_n\}$ is represented as an $r \times m$ matrix M and an ordered partition $\mathcal{I} = \{I_1, I_2, \dots, I_n\}$ of $\{1, 2, \dots, m\}$ such that

- $r \leq m \leq kn$,

- M is in reduced row echelon form with no zero rows,
- for each $i \in \{1, 2, \dots, n\}$, the column vectors of $M[I_i]$ are linearly independent, V_i is a column space of $M[I_i]$, and $|I_i| \leq k$.

In a branch-decomposition (T, \mathcal{L}) of \mathcal{V} , although \mathcal{L} is a mapping from the set of all leaves to \mathcal{V} , we implement \mathcal{L} as a mapping to $\{1, 2, \dots, n\}$ so that \mathcal{L} refers the index of the corresponding subspace in \mathcal{V} . When we carry out a computation on the actual subspaces V_i of \mathcal{V} , we read the basis of V_i stored as the column vectors of $M[I_i]$. Throughout the entire algorithm, we read $M[I_i]$ only in two cases: one for preprocessing, the other for computing the transcript. Therefore, we assume that (T, \mathcal{L}) is represented using $O(n \log n)$ space.

For a subspace B over \mathbb{F} and a B -namu (T, α, λ, U) , we represent $B' = \alpha(v, e)$ as a matrix $M_{B, B'}$ having $\dim B$ rows and $\dim B'$ columns; see Subsection 7.1 for details. The subspace U of B is represented in the same way. Therefore, every B -namu (T, α, λ, U) of width at most k admits a representation of size

$$O(|V(T)| ((\dim B)^2 \log |\mathbb{F}| + \log(k+1))).$$

7.4 Computing a transcript of a branch-decomposition

Recall that Algorithm 1 requests a given branch-decomposition (T^b, \mathcal{L}^b) and a transcript Λ of (T^b, \mathcal{L}^b) ; see the definition of transcripts in Subsection 3.5. In this subsection, we describe how to compute a transcript Λ in time $O(\theta^3 n^2)$ when a branch-decomposition (T^b, \mathcal{L}^b) of width at most θ is given.

Every transcript satisfies the properties in the following proposition.

Proposition 7.3. *Let (T^b, \mathcal{L}^b) be a rooted branch-decomposition of a subspace arrangement \mathcal{V} . Let $\Lambda = (\{\mathfrak{B}_v\}_{v \in V(T^b)}, \{\mathfrak{B}'_v\}_{v \in V(T^b)})$ be a transcript of (T^b, \mathcal{L}^b) . Then the following hold.*

(1) *If a node w is a parent of a node v of T^b , then $\langle \mathfrak{B}_v \rangle \subseteq \langle \mathfrak{B}'_w \rangle$.*

(2) *For each node v of T^b ,*

$$\langle \mathfrak{B}_v \rangle = \langle \mathcal{V}_v \rangle \cap \langle \mathcal{V} - \mathcal{V}_v \rangle \subseteq \langle \mathfrak{B}'_v \rangle,$$

and if \mathfrak{r} is the root of T^b , then $\mathfrak{B}_{\mathfrak{r}} = \emptyset$.

(3) *For each node v with two children w_1 and w_2 ,*

$$\begin{aligned} \langle \mathcal{V}_{w_i} \rangle \cap \langle \mathfrak{B}'_v \rangle &= \langle \mathfrak{B}_{w_i} \rangle \text{ for all } i = 1, 2, \\ (\langle \mathcal{V}_{w_1} \rangle + \langle \mathfrak{B}'_v \rangle) \cap (\langle \mathcal{V}_{w_2} \rangle + \langle \mathfrak{B}'_v \rangle) &= \langle \mathfrak{B}'_v \rangle. \end{aligned}$$

Proof. By definition, (1) and (2) are trivial. By Lemma 5.27, (3) holds. \square

Let M be an $r \times m$ matrix of rank r such that column vectors are indexed by E and there exists a subset B of E such that the submatrix of M induced by the columns in B is the identity matrix. We may also assume that the rows of M are indexed by B as well. Let us write $M[X, Y]$ to denote a submatrix of M induced by rows in X and columns in Y . For simplicity, we also write $M[X]$ to denote $M[B, X]$. For a matrix M , let $\text{col}(M)$ be the column space of M , that is, the span of all column vectors of M . For a subset X of B , let I_X be the $r \times r$ diagonal matrix whose rows and columns are indexed by B such that the diagonal entry at $v \in B$ is 1 if $v \in X$ and 0 otherwise.

We aim to construct a quadratic time algorithm to find a basis of $\text{col}(M[X]) \cap \text{col}(M[Y])$ for all partitions (X, Y) appearing in the branch decomposition. First, observe the following lemma, which is folklore. Cunningham and Geelen [4] presented essentially the same claim in Section 3 with a proof but unfortunately the statement of their claim is incorrect, which is probably a typo.

Lemma 7.4. *Let M, B be given as above. If (X, Y) is a partition of E , then*

$$\dim(\text{col}(M[X]) \cap \text{col}(M[Y])) = \text{rank } M[B \cap Y, X - B] + \text{rank } M[B \cap X, Y - B].$$

Furthermore if $P \subseteq X - B$ is a column basis of $M[B \cap Y, X - B]$ and $Q \subseteq Y - B$ is a column basis of $M[B \cap X, Y - B]$, then the disjoint union of the column vectors of $I_{B \cap Y} M[P]$ and the column vectors of $I_{B \cap X} M[Q]$ form a basis of $\text{col}(M[X]) \cap \text{col}(M[Y])$.

Proof. After rearranging columns and rows, we may write

$$M = \begin{array}{c} B \cap X \\ B \cap Y \end{array} \begin{pmatrix} & B \cap X & & B \cap Y & & X - B & & Y - B \\ 1 & & & & & & & \\ & 1 & & & & 0 & & M_{11} & & M_{12} \\ & & \ddots & & & & & & & \\ & & & 1 & & & & & & \\ & & & & 1 & & & & & \\ & 0 & & & & 1 & & & & M_{21} & & M_{22} \\ & & & & & & \ddots & & & & & \\ & & & & & & & & & & & 1 \end{pmatrix}.$$

We may assume $M_{11} = 0$ and $M_{22} = 0$ because $\text{col}(M[X])$ and $\text{col}(M[Y])$ are preserved. Then it follows easily that $\text{col}(M[X]) \cap \text{col}(M[Y])$ is spanned by $M[(X \cup Y) - B]$ and its dimension is equal to the rank of $\begin{pmatrix} 0 & M_{12} \\ M_{21} & 0 \end{pmatrix}$, that is, the sum of $\text{rank}(M_{21})$ and $\text{rank}(M_{12})$. If P is a column basis of M_{21} and Q is a column basis of M_{12} , then the basis of $M[(X \cup Y) - B]$ is the column vectors of $M[P \cup Q]$ (assuming that $M_{11} = 0$ and $M_{22} = 0$). This completes the proof. \square

Lemma 7.5. *Let M, B be given as above and let (X, Y) be a partition of E . If R is a row basis of $M[B \cap X, Y - B]$ and Q is a column basis of $M[R, Y - B]$, then Q is a column basis of $M[B \cap X, Y - B]$.*

In addition, if $|R| \leq \theta$, then Q can be computed in time $O(\theta^2 m)$.

Proof. Columns in Q of $M[R, Y - B]$ span all column vectors of $M[R, Y - B]$. As rows in R of $M[B \cap X, Y - B]$ span all row vectors of $M[B \cap X, Y - B]$, columns in Q of $M[B \cap X, Y - B]$ also span all column vectors of $M[B \cap X, Y - B]$. As $|R| \leq \theta$, a column basis of $M[R, Y - B]$ can be computed in time $O(\theta^2 m)$. \square

Lemma 7.6. *Let M, B be given as above. Let (X, Y) be a partition of E such that $|X| \leq \theta$. Then in time $O(\theta^2 m)$, we can find a column basis P of $M[B \cap Y, X - B]$ and a row basis R of $M[B \cap X, Y - B]$.*

Proof. As $M[B \cap Y, X - B]$ has at most k columns, its column basis P can be found in time $O(\theta^2 r)$. Similarly, $M[B \cap X, Y - B]$ has at most θ rows and so its row basis can be found in time $O(\theta^2 m)$. Note that $r \leq m$. \square

Lemma 7.7. *Let M, B be given as above. Let $(X_1 \cup X_2, Y)$ be a partition of E . Suppose that*

- $P_1 \subseteq X_1 - B$ is a column basis of $M[B \cap (Y \cup X_2), X_1 - B]$ and $R_1 \subseteq B \cap X_1$ is a row basis of $M[B \cap X_1, (Y \cup X_2) - B]$,
- $P_2 \subseteq X_2 - B$ is a column basis of $M[B \cap (Y \cup X_1), X_2 - B]$ and $R_2 \subseteq B \cap X_2$ is a row basis of $M[B \cap X_2, (Y \cup X_1) - B]$.

Let P be a column basis of $M[B \cap Y, P_1 \cup P_2]$ and let R be a row basis of $M[R_1 \cup R_2, Y - B]$. Then P is a column basis of $M[B \cap Y, (X_1 \cup X_2) - B]$ and R is a row basis of $M[B \cap (X_1 \cup X_2), Y - B]$.

In addition, if $|P_i| + |R_i| \leq \theta$ for each $i = 1, 2$, then in time $O(\theta^2 m)$, we can either find P and R or confirm that $|P| + |R| > \theta$.

Proof. The columns in P_i of $M[B \cap Y, X_i - B]$ span all column vectors of $M[B \cap Y, X_i - B]$ for each $i = 1, 2$. Therefore the columns in $P_1 \cup P_2$ of $M[B \cap Y, (X_1 \cup X_2) - B]$ span all column vectors of $M[B \cap Y, (X_1 \cup X_2) - B]$. Similarly, the rows in R_i of $M[B \cap X_i, Y - B]$ span all row vectors of $M[B \cap X_i, Y - B]$ for each $i = 1, 2$. So, the rows in $R_1 \cup R_2$ of $M[B \cap (X_1 \cup X_2), Y - B]$ span all row vectors of $M[B \cap (X_1 \cup X_2), Y - B]$. The conclusion on P and R follows easily.

As $|B \cap Y| \leq r$ and $|P_1 \cup P_2| \leq 2\theta$, P can be computed in time $O(\theta^2 r)$. Similarly as $|R_1 \cup R_2| \leq 2\theta$ and $|Y - B| \leq m$, R can be computed in time $O(\theta^2 m)$. Note that $r \leq m$. \square

Let \mathcal{V} be a subspace arrangement of \mathbb{F}^r . Let M be an $r \times m$ matrix in reduced row echelon form with a partition \mathcal{I} of the column index set E of M such that $|\mathcal{V}| = |\mathcal{I}|$, $m = \sum_{V \in \mathcal{V}} \dim V$, and for each $V \in \mathcal{V}$, there exists the unique $I \in \mathcal{I}$ with $V = \text{col}(M[I])$. We assume that M has no zero rows by deleting such rows. Let $B \subseteq E$ be the indices such that $M[B]$ is the identity matrix. As we did in the beginning of this section, we assume that rows of M are indexed by B .

Let (T^b, \mathcal{L}^b) be a rooted branch-decomposition of \mathcal{V} . For each node v of T , let E_v be the subset of E indexing every column vector that corresponds to a vector in a basis of some $V \in \mathcal{V}_v$. For each node v of T^b , let E_v be the union of all $I \in \mathcal{I}$ satisfying that $\text{col}(M[I]) = V$ for some $V \in \mathcal{V}_v$.

Given a rooted branch-decomposition (T^b, \mathcal{L}^b) of \mathcal{V} , we want to construct a transcript $\Lambda = (\{\mathfrak{B}_v\}, \{\mathfrak{B}'_v\})$ with its transition matrices $\{T_v\}$. First we need to compute a basis of $\langle \mathcal{V}_v \rangle \cap \langle \mathcal{V} - \mathcal{V}_v \rangle$, that is,

$$\text{col}(M[E_v]) \cap \text{col}(M[E - E_v])$$

for each node v of T^b . For this step, Theorem 7.8 shows that Algorithm 2 correctly computes a basis of $\text{col}(M[E_v]) \cap \text{col}(M[E - E_v])$ for all nodes v of T^b if (T^b, \mathcal{L}^b) has width at most θ . Cunningham and Geelen [4, Section 3] presented an algorithm to do essentially the same task but its running time is cubic. Our algorithm runs in quadratic time.

Theorem 7.8. *Let \mathcal{V} be a subspace arrangement of \mathbb{F}^r represented by an $r \times m$ matrix M in reduced row echelon form with no zero rows such that each $V \in \mathcal{V}$ has dimension at most θ . Let $n = |\mathcal{V}|$. Given a rooted branch-decomposition (T^b, \mathcal{L}^b) of \mathcal{V} , in time $O(\theta^3 n^2)$, Algorithm 2 correctly computes a basis of $\langle \mathcal{V}_v \rangle \cap \langle \mathcal{V} - \mathcal{V}_v \rangle$ for all nodes v of T^b or confirms that (T^b, \mathcal{L}^b) has width larger than θ . In addition, if (T^b, \mathcal{L}^b) has width at most θ , then we can compute the transcript $\Lambda = (\{\mathfrak{B}_v\}, \{\mathfrak{B}'_v\})$ of (T^b, \mathcal{L}^b) with its transition matrices in time $O(\theta^3 n^2)$.*

To prove Theorem 7.8, we need the following lemma giving us a subroutine for finding bases.

Algorithm 2 Finding a basis for each boundary space in a rooted branch-decomposition (T^b, \mathcal{L}^b) of a subspace arrangement \mathcal{V} of subspaces of dimension at most θ or confirming that the branch-width is larger than θ

Ensure: M is an $r \times m$ matrix representing \mathcal{V} in reduced row echelon form, and E and its subset B are given as in the beginning of Section 7.4

```

1: procedure BASES( $(T^b, \mathcal{L}^b), \mathcal{V}, \theta$ )
2:   repeat
3:     choose an unmarked node  $v$  of  $T^b$  farthest from the root
4:     let  $E_v$  be the subset of  $E$ , indexing all columns corresponding to some  $V \in \mathcal{V}_v$ 
5:     if  $v$  is a leaf then
6:       compute a column basis  $P_v$  of  $M[B - E_v, E_v - B]$ 
7:       compute a row basis  $R_v$  of  $M[E_v \cap B, E - (E_v \cup B)]$ 
8:     else
9:       let  $w_1, w_2$  be two children of  $v$  in  $T^b$ 
10:      compute a column basis  $P_v$  of  $M[B - E_v, P_{w_1} \cup P_{w_2}]$ 
11:      compute a row basis  $R_v$  of  $M[R_{w_1} \cup R_{w_2}, E - (E_v \cup B)]$ 
12:    end if
13:    if  $|P_v| + |R_v| > \theta$  then
14:      stop
15:    end if
16:    compute a column basis  $Q_v$  of  $M[R_v, E - (E_v \cup B)]$ 
17:    let  $B_v$  be the set of the column vectors in  $I_{B-E_v}M[P_v]$  and  $I_{B \cap E_v}M[Q_v]$ 
18:    mark  $v$ 
19:  until all nodes in  $T^b$  are marked
20: end procedure

```

Lemma 7.9. *Let B, B_1, B_2 be subspaces of \mathbb{F}^r given by their ordered bases $\mathfrak{B}, \mathfrak{B}_1, \mathfrak{B}_2$, respectively, such that $B \subseteq B_1 + B_2$ and $\dim B \leq \theta$, $\dim B_1 \leq \theta$, $\dim B_2 \leq \theta$. Then in time $O(\theta^2 r)$, we can find an ordered basis \mathfrak{B}' of $B_1 + B_2$ that extends \mathfrak{B} and matrices T_1 and T_2 (transition matrices) such that $T_1[x]_{\mathfrak{B}_1} = [x]_{\mathfrak{B}'}$ for all $x \in \mathfrak{B}_1$ and $T_2[y]_{\mathfrak{B}_2} = [y]_{\mathfrak{B}'}$ for all $y \in \mathfrak{B}_2$.*

Proof. Consider an $r \times (|\mathfrak{B}| + |\mathfrak{B}_1| + |\mathfrak{B}_2|)$ matrix M consisting of column vectors in $\mathfrak{B}, \mathfrak{B}_1$, and \mathfrak{B}_2 . We find a column basis \mathfrak{B}' of M extending \mathfrak{B} in time $O(\theta^2 r)$.

By symmetry, it is enough to show how to compute the transition matrices T_1 such that

$$T_1[x]_{\mathfrak{B}_1} = [x]_{\mathfrak{B}'}$$

for all $x \in \mathfrak{B}_1$. This step is included in the proof of [10, Proposition 5.3] but we include its proof for the completeness. Let $\mathfrak{B}_1 = \{b_1, b_2, \dots, b_\ell\} \subseteq \mathbb{F}^r$. If $x = b_j$, then $T_1[b_j]_{\mathfrak{B}_1} = T_1 e_j$ is the j th column vector of T_1 , which is equal to the coordinate of b_j with respect to \mathfrak{B}' . So,

$$(\mathfrak{B}')T_1 = (\mathfrak{B}_1),$$

where (\mathfrak{B}') is an $r \times |\mathfrak{B}'|$ matrix whose column vectors are \mathfrak{B}' and similarly (\mathfrak{B}_1) is an $r \times |\mathfrak{B}_1|$ matrix corresponding to \mathfrak{B}_1 . This matrix equation can be solved in time $O(\theta^2 r)$. \square

Proof of Theorem 7.8. Let E be the set indexing the columns of M and let $B \subseteq E$ be a subset such that $M[B]$ is an $r \times r$ identity matrix. Note that $r \leq m$ because r is equal to the rank of M and $m = \sum_{V \in \mathcal{V}} \dim V \leq \theta n$ because each $V \in \mathcal{V}$ has dimension at most θ . Let \mathfrak{B}_v be a basis of $\langle \mathcal{V}_v \rangle \cap \langle \mathcal{V} - \mathcal{V}_v \rangle$.

For each leaf v of T^b , we can compute P_v and R_v in time $O(\theta^2 m) \leq O(\theta^3 n)$ by Lemma 7.6. For each internal node v of T^b , we can compute P_v and R_v in time $O(\theta^2 m) \leq O(\theta^3 n)$ by Lemma 7.7. For each node v , after computing P_v and R_v , we can compute Q_v in time $O(\theta^2 m) \leq O(\theta^3 n)$ by Lemma 7.5 and using that we can output \mathfrak{B}_v in time $O(\theta r) \leq O(\theta^2 n)$ by Lemma 7.4. Since there are $O(n)$ nodes of T^b , it takes $O(\theta^3 n^2)$ time to compute \mathfrak{B}_v for all nodes v of T^b .

When we are given a basis \mathfrak{B}_v for each node v of T^b , computing the transcript with its transition matrices can be done in time $O(\theta^2 r n) \leq O(\theta^3 n^2)$ by Lemma 7.9. \square

7.5 Running time analysis of Algorithm 1

We recall how our algorithm works at each operation in $\text{FULL-SET}(\mathcal{V}, k, (T^b, \mathcal{L}^b))$ of Algorithm 1 and discuss the time complexity.

Initialization: At line 7, for a leaf node x , the set \mathcal{F}_x^L is $\{\Delta_x\}$ as in Proposition 6.3.

Join: Note that for each $i = 1, 2$, the size of \mathcal{F}_{x_i} is at most some function of $k, \theta, |\mathbb{F}|$ by Lemma 5.4 because \mathcal{F}_{x_i} is a subset of $U_k(B_{x_i})$. At line 10, by Lemma 5.7, the set $\mathcal{F}_{x_1} \oplus \mathcal{F}_{x_2}$ can be computed in time $f_1(k, \theta)$ elements for some function f_1 .

Shrink: At line 11, computing $\mathcal{F}_x^+|_{B_x}$ takes at most $f_2(k, \theta)$ steps for some function f_2 because the number of all elements in \mathcal{F}_x^+ is at most some function of k, θ .

Trim: At line 12, for every $\Gamma \in \mathcal{F}_x^S$, we test whether Γ is a k -safe extension of $\text{trim}(\Gamma)$ and if so put $\text{trim}(\Gamma)$ into \mathcal{F}_x^T . Note that testing whether a B -namu is a k -safe extension of its trim and trimming Γ' can be done in time $f_3(k, \theta, |\mathbb{F}|)$ for some function f_3 .

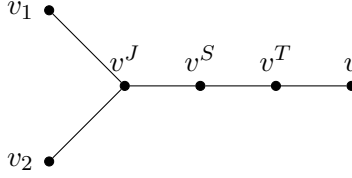

Figure 13: A subtree of T^c for an internal node v with two children v_1 and v_2 .

Compare: At line 13, a B_x -namu Γ is in \mathcal{F}_x if and only if $\Gamma \in U_k(B_x)$ and $\text{trim}(\Gamma') \preceq \Gamma$ for some B_x -namu $\Gamma' \in \mathcal{F}_x^T$. Thus, for each $\Gamma' \in \mathcal{F}_x^T$ and each $\Gamma \in U_k(B_x)$, we test whether $\text{trim}(\Gamma') \preceq \Gamma$. Note that $|\mathcal{F}_x^T|$ is at most some function of k and θ , and for $\Gamma' \in \mathcal{F}_x^T$, the number of edges in $T(\Gamma')$ bounded by some function of k and $|\mathbb{F}|$ by Lemma 5.6 because it comes from a sum of two compact B -namus of width at most k . By Lemmas 5.4 and 5.17, \mathcal{F}_x can be computed in time $f_4(k, \theta, |\mathbb{F}|)$ for some function f_4 .

Now we summarize the observations as follows. Note that the number of nodes in T^b is $O(|\mathcal{V}|)$.

Proposition 7.10. *Let (T^b, \mathcal{L}^b) be a rooted branch-decomposition of \mathcal{V} of width at most θ for some nonnegative integer θ . In Algorithm 1, the procedure $\text{FULL-SET}(\mathcal{V}, k, (T^b, \mathcal{L}^b), \{T_v\}_{v \in V(T^b)})$ runs in time $f(k, \theta, |\mathbb{F}|) \cdot |\mathcal{V}|$ for some function f .*

7.6 Constructing a branch-decomposition of \mathcal{V}

We illustrate how to construct a branch-decomposition of \mathcal{V} when we have a nonempty full set at the root node of T^b in Algorithm 1.

Composition trees. For each node x of T^b , Algorithm 1 constructs \mathcal{F}_x if x is a leaf and constructs \mathcal{F}_x^+ , \mathcal{F}_x^S , \mathcal{F}_x^T , and \mathcal{F}_x otherwise. In order to describe the B -namus in $\mathcal{F} \in \{\mathcal{F}_x, \mathcal{F}_x^+, \mathcal{F}_x^S, \mathcal{F}_x^T\}$, we will use a *composition tree* T^c obtained from T^b . The concept of a composition tree was introduced in [10], which we modified slightly for our problem. Note that Algorithm 1 runs along a given rooted binary tree T^b whose every internal node has degree 3 except the root. Here is the definition of a composition tree T^c . (See Figure 13.)

- The node set of T^c is the disjoint union of $\{v^J, v^S, v^T, v\}$ for each internal node v of T^b and $\{v\}$ for each leaf v of T^b .
- For each internal node v of T^b and its two children v_1 and v_2 in T^b , v_1v^J , v_2v^J , v^Jv^S , v^Sv^T , v^Tv are the edges in a subtree of T^c induced by a node set $\{v_1, v_2, v^J, v^S, v^T, v\}$.

We remark that T^c can be obtained from T^b by subdividing every edge that is not incident with a leaf twice. Each node of T^c corresponds to each operation in Algorithm 1. There are five kinds of nodes in T^c .

- (1) *Compare nodes:* nodes v of T^c for all internal nodes v of T^b . Note that the root is a compare node.
- (2) *Trim nodes:* nodes v^T of T^c for all internal nodes v of T^b .
- (3) *Shrink nodes:* nodes v^S of T^c for all internal nodes v of T^b .
- (4) *Join nodes:* nodes v^J of T^c for all internal nodes v of T^b .

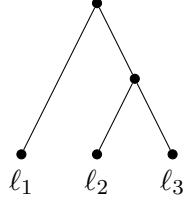

Figure 14: A rooted binary tree T .

(5) *Leaf nodes*: leaves v of T^c .

Evidence. Each operation in Algorithm 1 constructs the set $\mathcal{F} \in \{\mathcal{F}_x, \mathcal{F}_x^+, \mathcal{F}_x^S, \mathcal{F}_x^T\}$. Each B -namu Γ in \mathcal{F} is associated with *evidence* that certifies why Γ is in \mathcal{F} . When we run Algorithm 1, we store the evidence of each B -namu $\Gamma \in \mathcal{F}$ at each operation as follows.

Case 1: (Initialization) $\mathcal{F} = \mathcal{F}_x$ for a leaf x of T^b .

We store an index i such that $V_i = \mathcal{L}^b(x)$.

Case 2: (Join) $\mathcal{F} = \mathcal{F}_x^+$ for an internal node x of T^b with two children x_1 and x_2 . Note that x_1 and x_2 are compare nodes or leaf nodes.

For every $\Gamma \in \mathcal{F}_x^+$, we store $\Gamma_1 \in \mathcal{F}_{x_1}$, $\Gamma_2 \in \mathcal{F}_{x_2}$, and a $(T(\Gamma_1), T(\Gamma_2))$ -model (η_1, η_2) in $T(\Gamma)$ such that $\Gamma = \Gamma_1 +_{(\eta_1, \eta_2)} \Gamma_2$.

Case 3: (Shrink) $\mathcal{F} = \mathcal{F}_x^S$ for an internal node x of T^b .

For every $\Gamma \in \mathcal{F}_x^S$, we store $\Gamma' \in \mathcal{F}_x^+$ such that $\Gamma = \Gamma'|_{B_x}$.

Case 4: (Trim) $\mathcal{F} = \mathcal{F}_x^T$ for an internal node x of T^b .

For every $\Gamma \in \mathcal{F}_x^T$, we store $\Gamma' \in \mathcal{F}_x^S$ such that $\Gamma = \text{trim}(\Gamma')$.

Case 5: (Compare) $\mathcal{F} = \mathcal{F}_x$ for an internal node x of T^b .

For every $\Gamma \in \mathcal{F}_x$, we store $\Gamma' \in \mathcal{F}_x^T$ with $\Gamma' \preceq \Gamma$, a tree T ensuring $\Gamma' \preceq \Gamma$, a $T(\Gamma')$ -model in T , and a $T(\Gamma)$ -model in T .

We remark that all evidence has bounded size by Lemmas 5.4 and 5.7.

Let $\mathcal{V} = \{V_1, V_2, \dots, V_{|\mathcal{V}|}\}$ be a subspace arrangement and let (T^b, \mathcal{L}^b) be its rooted branch-decomposition of width at most θ , which are inputs of Algorithm 1. If r is the root of T^b and \mathcal{F}_r is nonempty after running Algorithm 1, then let $\Gamma_r \in \mathcal{F}_r$. Afterward, we can find, in time $O(|V(T^b)|)$, the evidence corresponding to Γ_r at each node of the composition tree T^c by backtracking from the root r to the leaves. The evidence corresponding to Γ_r is B -namus, and they are stored at all nodes of T^c so that Γ_r can be constructed by joining, shrinking, trimming, and comparing using them. These will be used for Algorithm 3.

Postorder traversal. We will use the *postorder traversal* to express a branch-decomposition of a subspace arrangement. For a branch-decomposition (T, \mathcal{L}) of a subspace arrangement, if the postorder traversal visits a leaf of T , then we print (the index of) the corresponding subspace, and if it visits an internal node of T , then we print $*$. For example, if T is a rooted binary tree in Figure 14 and $\mathcal{L}(\ell_i) = V_i$ for all $i = 1, 2, 3$, then 1, 2, 3, *, * represents (T, \mathcal{L}) .

Correctness. Let Γ_x be the B -namu that is the evidence at a node x of T^c with respect to $\Gamma_r \in \mathcal{F}_r$. Here we describe the five functions PRINTNODE, PRINTINC, PRINTINCREV, PRINTSUBTREE, and PRINTSUBMID, which are used in Algorithm 3.

(1) PRINTNODE(x, v)

Input A node x of T^c and a node v of $T(\Gamma_x)$.

Output A sequence of rooted binary trees whose leaves are labeled by indices of \mathcal{V}_x .

Return The number of output rooted binary trees.

(2) PRINTINC(x, v, e), PRINTINCREV(x, v, e)

Input A node x of T^c and an incidence (v, e) of $T(\Gamma_x)$.

Output A sequence of rooted binary trees whose leaves are labeled by indices of \mathcal{V}_x .

Return The number of output rooted binary trees.

(3) PRINTSUBTREE(x, u, v), PRINTSUBTREEMID(x, u, v)

Input A node x of T^c and two adjacent nodes u, v of $T(\Gamma_x)$.

Output A rooted binary tree whose leaves are labeled by indices of \mathcal{V}_x .

Return 1 if the output is nonempty, and 0 otherwise.

Based on a composition tree T^c and the evidence Γ_x at each node x of T^c with respect to the element Γ_r in \mathcal{F}_r , we will run Algorithm 3 to print a branch-decomposition of \mathcal{V} of width at most k (using a postorder traversal). Proposition 7.12 will show that Algorithm 3 can generate a branch-decomposition of \mathcal{V} correctly using the concept of witnesses introduced in Subsection 5.5.

For each node x of T^c and the corresponding node x' of T^b , let $\mathcal{V}_x = \mathcal{V}_{x'}$ and we define $B_x = B_{x'_1} + B_{x'_2}$ if x is a join node in T^c and x'_1, x'_2 are two children of x' in T^b , and $B_x = B_{x'}$ otherwise. We define (ζ_x, \mathcal{L}_x) as follows.

- For each node v of $T(\Gamma_x)$ having degree at most 2, we define $\zeta_x(v)$ as the tree rooted at v obtained by taking the disjoint union of v and the trees output by PRINTNODE(x, v) and adding edges between v and roots of trees in PRINTNODE(x, v).
- For each incidence (v, e) of $T(\Gamma_x)$, we define $\zeta_x(v, e)$ as the sequence of disjoint trees output by PRINTINC(x, v, e).
- Let \mathcal{L}_x be the canonical mapping from the set of leaves of ζ_x to \mathcal{V}_x .

It is not difficult to see that (ζ_x, \mathcal{L}_x) is a \mathcal{V}_x -labeling of $T(\Gamma_x)$. Lemma 7.11 shows that (ζ_x, \mathcal{L}_x) is a k -safe witness of Γ_x in B_x , from which Proposition 7.12 follows.

Lemma 7.11. *For every node x of a composition tree T^c and the evidence Γ_x at x , (ζ_x, \mathcal{L}_x) is a \mathcal{V}_x -labeling of $T(\Gamma_x)$ and is a k -safe witness of Γ_x in B_x . Furthermore, for the node x' of T^b corresponding to x ,*

- (1) *if x is a join node or a shrink node, then every z -protected edge in $(\mathbb{T}(\zeta_x), \mathcal{L}_x)$ is in ζ_x for every node $z < x'$ of T^b ,*
- (2) *if x is a trim node or compare node, then every z -protected edge in $(\mathbb{T}(\zeta_x), \mathcal{L}_x)$ is in ζ_x for every node $z \leq x'$ of T^b .*

Proof. We use induction on the number of descendants of a node x in T^c . Let Γ_x be the evidence at x and let $T_x = T(\Gamma_x)$.

First, if x is a leaf node of T^c , then T_x has a single node and (ζ_x, \mathcal{L}_x) is a \mathcal{V}_x -labeling of T_x and is a k -safe witness of Γ_x in B_x .

If x is a join node with two children y_1 and y_2 in T^c , then y_i is a leaf node or a compare node for every $i = 1, 2$. Let $\Gamma_x = \Gamma_{y_1} +_{(\eta_1, \eta_2)} \Gamma_{y_2}$ for the evidence Γ_{y_1} and Γ_{y_2} at y_1 and y_2 , respectively. For a node v of degree 2 in T_x , by definition, v is a branch node in exactly one of η_1 and η_2 . Thus, $\text{PRINTNODE}(x, u)$ is either $\text{PRINTNODE}(y_1, u_1)$ if $u = \bar{\eta}_1(u_1)$ or $\text{PRINTNODE}(y_2, u_2)$ if $u = \bar{\eta}_2(u_2)$. For an incidence (v, e) of T_x , $\text{PRINTINC}(x, v, e)$ calls $\text{PRINTINC}(y_1, \bar{\eta}_1(v, e))$ or $\text{PRINTINC}(y_2, \bar{\eta}_2(v, e))$ (it may call none of them and return 0) from line 53 to line 58. Then, we observe that (ζ_x, \mathcal{L}_x) is the sum of $(\zeta_{y_1}, \mathcal{L}_{y_1})$ and $(\zeta_{y_2}, \mathcal{L}_{y_2})$ by (η_1, η_2) . Trivially, (ζ_x, \mathcal{L}_x) is a \mathcal{V}_x -labeling of T_x . By the induction hypothesis and Proposition 5.28, (ζ_x, \mathcal{L}_x) is a k -safe witness of Γ_x in B_x and every z -protected edge in $(\mathbb{T}(\zeta_x), \mathcal{L}_x)$ is in ζ_x for every node $z < x'$ of T^b .

Let y be the child of x in T^c and Γ_y be the evidence at y . Let $T_y = T(\Gamma_y)$.

If x is a shrink node, then for each node u of degree at most 2 in T_x and each incidence (v, e) of T_x ,

$$\text{PRINTNODE}(x, u) = \text{PRINTNODE}(y, u) \text{ and } \text{PRINTINC}(x, v, e) = \text{PRINTINC}(y, v, e).$$

Clearly, we have $(\zeta_x, \mathcal{L}_x) = (\zeta_y, \mathcal{L}_y)$ and \mathcal{L}_x is a \mathcal{V}_x -labeling of T_x . Thus, by the induction hypothesis and Proposition 5.29, (ζ_x, \mathcal{L}_x) is a k -safe witness of Γ_x in B_x and since y is a join node, every z -protected edge in $(\mathbb{T}(\zeta_x), \mathcal{L}_x) = (\mathbb{T}(\zeta_y), \mathcal{L}_y)$ is in $\zeta_x = \zeta_y$ for every node $z < x'$ of T^b .

If x is a trim node, then for each incidence (v, e) of T_x ,

$$\text{PRINTINC}(x, v, e) = \text{PRINTINC}(y, v, e).$$

Note that T_x is a subtree of $T(\Gamma_y)$. If T_x has at least two nodes, then for a node v with $\deg_{T_y}(v) = \deg_{T_x}(v)$, $\text{PRINTNODE}(x, v) = \text{PRINTNODE}(y, v)$. If $\deg_{T_y}(v) \neq \deg_{T_x}(v) = 1$ and w is the neighbor of v in T_y , but not a neighbor of v in T_x , then $\text{PRINTNODE}(x, v)$ calls $\text{PRINTSUBTREE}(y, v, w)$, and if $\deg_{T_y}(v) \neq \deg_{T_x}(v) = 2$ and w, w' are the neighbors of v in T_y that are not neighbors of v in T_x , then $\text{PRINTNODE}(x, v)$ calls both $\text{PRINTSUBTREE}(y, v, w)$ and $\text{PRINTSUBTREE}(y, v, w')$. In Algorithm 3, it is easy to observe that the output of $\text{PRINTINCREV}(y, v, e)$ is the reversed sequence of the output of $\text{PRINTINC}(y, v, e)$ by comparing two functions $\text{PRINTINC}(y, v, e)$ and $\text{PRINTINCREV}(y, v, e)$. Thus, we observe that, from line 129 to line 142 of Algorithm 3, the function $\text{PRINTSUBTREE}(y, v, w)$ outputs

$$\mathbb{T}(\zeta_y)[S \cup V(\zeta(v, vw)) \cup V(\zeta(w, vw))],$$

where S is the set of all nodes in the component $\mathbb{T}(\zeta_y) - v$ containing w . This implies that, by the induction hypothesis, (ζ_x, \mathcal{L}_x) is a \mathcal{V}_x -labeling induced by T_x from (ζ_y, \mathcal{L}_y) . By Proposition 5.30, (ζ_x, \mathcal{L}_x) is a k -safe witness of Γ_x in B_x and every z -protected edge in $(\mathbb{T}(\zeta_x), \mathcal{L}_x)$ is in ζ_x for every node $z \leq x'$ of T^b .

If T_x has only one node, then $\text{PRINTNODE}(x, v)$ calls $\text{PRINTSUBTREEMID}(y, u, v)$ and $\text{PRINTSUBTREEMID}(y, v, u)$ for an improper y -degenerate edge uv in Γ_y . In Algorithm 3, we can easily observe that the function $\text{PRINTSUBTREEMID}(y, u, v)$ outputs $\mathbb{T}(\zeta_y)[S' \cup V(\zeta(v, uv))]$ where S' is the set of all nodes in the component $\mathbb{T}(\zeta_y) - u$ containing v . So $\text{PRINTNODE}(x, v)$ will output a rooted binary tree obtained from $T(\zeta_y)$ by subdividing uv . Then, by the induction hypothesis,

(ζ_x, \mathcal{L}_x) is a \mathcal{V}_x -labeling induced by uv from (ζ_y, \mathcal{L}_y) . By Proposition 5.30, (ζ_x, \mathcal{L}_x) is a k -safe witness of Γ_x in B_x and every z -protected edge in $(\mathbb{T}(\zeta_x), \mathcal{L}_x)$ is in ζ_x for every node $z \leq x'$ of T^b .

We assume that x is a compare node. For a node v of T_x of degree at most 2, $\text{PRINTNODE}(x, v)$ calls $\text{PRINTNODE}(y, v')$ if there exists a node v' of T_y corresponding to v and returns 0 otherwise. From line 63 to line 83, for each incidence (v, e) of T_x , $\text{PRINTINC}(x, v, e)$ will output a sequence of rooted binary trees in ζ_y that correspond to (v, e) with respect to $\Gamma_y \preceq \Gamma_x$. More precisely, it matches with the construction of a \mathcal{V}_x -labeling of $T(\Gamma_x)$ induced by T from (ζ_y, \mathcal{L}_y) where T is a tree ensuring $\Gamma_y \preceq \Gamma_x$. Then, by the induction hypothesis and Proposition 5.33, (ζ_x, \mathcal{L}_x) is a \mathcal{V}_x -labeling that is k -safe witness of Γ_x in B_x and every z -protected edge in $(\mathbb{T}(\zeta_x), \mathcal{L}_x)$ is in ζ_x for every node $z < x'$ of T^b . This completes the proof. \square

Proposition 7.12. *Let \mathcal{V} be a subspace arrangement and k be a nonnegative integer. Let (T^b, \mathcal{L}^b) be a given rooted branch-decomposition of width θ with the root r and let $\{T_v\}_{v \in V(T^b)}$ be the given set of transition matrices. If \mathcal{F}_r in Algorithm 1 with an input $(\mathcal{V}, k, (T^b, \mathcal{L}^b), \{T_v\}_{v \in V(T^b)})$ is nonempty, then a (rooted) branch-decomposition of \mathcal{V} of width at most k can be constructed by Algorithm 3 in time $f(k, \theta, |\mathbb{F}|) \cdot |\mathcal{V}|$ for some function f .*

Proof. From line 2 to line 5, Algorithm 3 outputs the tree rooted at v obtained by taking the disjoint union of v and the trees output by $\text{PRINTNODE}(r, v)$ and adding edges between v and roots of trees in $\text{PRINTNODE}(r, v)$, where v is the unique node of $T(\Gamma_r)$. The tree is nonempty because \mathcal{F}_r is nonempty. By definition, it is equal to $\zeta_r(v)$ and by Lemma 7.11, the \mathcal{V}_r -labeling (ζ_r, \mathcal{L}_r) is a k -safe witness of Γ_r in B_r . Thus, $(\mathbb{T}(\zeta_r), \mathcal{L}_r)$ is a branch-decomposition of \mathcal{V}_r whose width is at most k . As $T(\Gamma_r)$ has only one node v and $\mathcal{V}_r = \mathcal{V}$, $(\zeta_r(v), \mathcal{L}_r)$ itself is a (rooted) branch-decomposition of \mathcal{V} having width at most k , which means that Algorithm 3 prints a (rooted) branch-decomposition of \mathcal{V} of width at most k .

The running time of Algorithm 3 is $f(k, \theta, |\mathbb{F}|) \cdot |\mathcal{V}|$ for some function f because the number of nodes of T^c is $O(|V(T^b)|) = O(|\mathcal{V}|)$ and the size of the evidence at each node of T^c is at most $h(k, \theta, |\mathbb{F}|)$ for some function h by Lemmas 5.4 and 5.7. \square

7.7 Summary

The following theorem summarizes the procedure and the time complexity of our main algorithm for a subspace arrangement.

Theorem 1.1. *Let \mathbb{F} be a finite field, let r be a positive integer, and let k be a nonnegative integer. Let $\mathcal{V} = \{V_1, V_2, \dots, V_n\}$ be a subspace arrangement in \mathbb{F}^r where each V_i is given by its spanning set of d_i vectors and $m = \sum_{i=1}^n d_i$. In time $O(rm^2 + (k+1)rmn + k^3n^3 + f(|\mathbb{F}|, k)n^2)$ for some function f , one can either*

- find a branch-decomposition of \mathcal{V} having width at most k or
- confirm that no such branch-decomposition exists.

Proof. We may assume that $n > 1$ because otherwise there is no branch-decomposition and the branch-width is 0 by convention. We preprocess the input, given as an $r \times m$ matrix M over a fixed finite field \mathbb{F} with an ordered partition $\mathcal{I} = \{I_1, I_2, \dots, I_n\}$ of $\{1, 2, \dots, m\}$ and an integer k such that $V_i = \text{col}(M[I_i])$ for every i , as follows. We apply the reductions of Lemmas 7.1 and

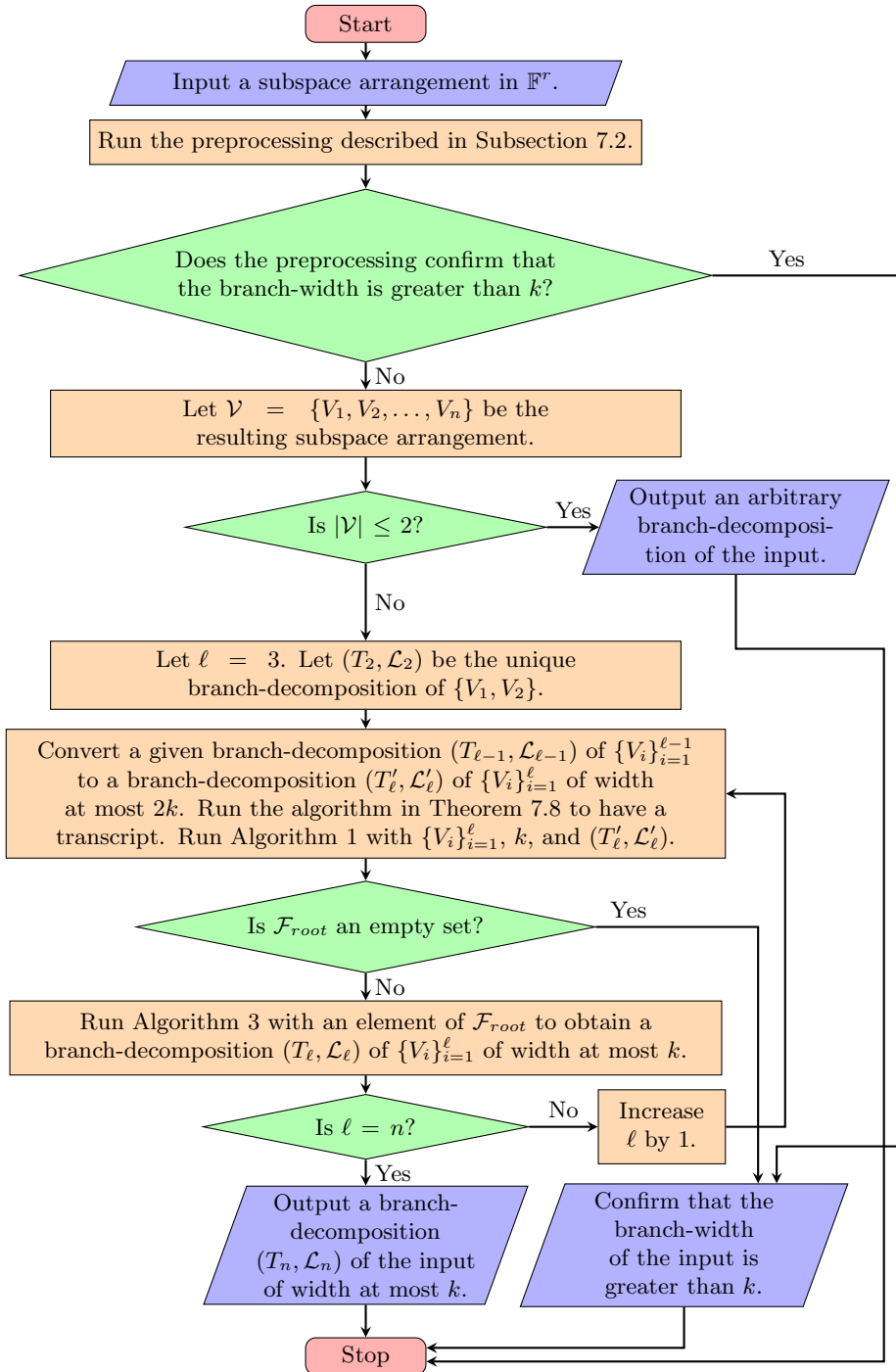

Figure 15: A flowchart for the algorithm in Theorem 1.1.

7.2 and then the reduction of Lemma 7.1 again. Let M' be the resulting $r' \times m'$ matrix and \mathcal{I}' be the resulting ordered partition $\mathcal{I}' = \{I'_1, I'_2, \dots, I'_n\}$ of $\{1, 2, \dots, m'\}$. By Lemmas 7.1 and 7.2, it is straightforward to verify that

- (i) $r' \leq m' \leq kn$,
- (ii) M' is in reduced row echelon form with no zero rows,
- (iii) for each i , the column vectors of $M'[I'_i]$ are linearly independent and $|I'_i| \leq k$,
- (iv) $\text{col}(M'[I'_i]) \subseteq \text{col}(M'[\{1, 2, \dots, m'\} - I'_i])$,
- (v) (M, \mathcal{I}, k) is a YES instance with a branch-decomposition (T, \mathcal{L}) if and only if (M', \mathcal{I}', k) is a YES instance with (T, \mathcal{L}') where \mathcal{L}' maps a leaf v to $\text{col}(M'[I'_i])$ whenever \mathcal{L} maps v to $\text{col}(M[I_i])$,

and otherwise, we confirm that the branch-width of \mathcal{V} exceeds k . We may assume that $k > 0$ because if $I'_i = \emptyset$ for all i , then every branch-decomposition has width 0. We notice that the running time of preprocessing requires $O(rm^2 + (k+1)rmn)$. Henceforth, we assume that the $M = M'$, $\mathcal{I} = \mathcal{I}'$, $V_i = \text{col}(M'[I'_i])$ to simplify notations.

We may also assume that $\dim V_i \neq 0$ for all i because otherwise we delete all such V_i and later we can extend a branch-decomposition of $\mathcal{V} - \{V_i\}$ to that of \mathcal{V} of the same width easily. After the preprocessing, if $n = 1$, then an arbitrary branch-decomposition has width 0 and so we simply output an arbitrary branch-decomposition of \mathcal{V} . If $n = 2$, then the branch-width is at most k because $\dim V_i \leq k$ for each $i = 1, 2$ by (iii). Thus we may assume that $n \geq 3$.

We will apply iterative compression on $\mathcal{V}_i = \{V_1, \dots, V_i\}$ for $i = 3, \dots, n$. We initially start with a trivial branch-decomposition (T_2, \mathcal{L}_2) of $\mathcal{V}_2 = \{V_1, V_2\}$ having width at most k such that T_2 is a tree with two nodes. We carry out a COMPRESSION STEP for each $i = 3, \dots, n$ iteratively as follows. (See Figure 15 for a flowchart.)

- (1) By adding a new leaf v to T_{i-1} and extending \mathcal{L}_{i-1} to map v to V_i , we create a branch-decomposition (T'_i, \mathcal{L}'_i) of \mathcal{V}_i . Note that the width of (T'_i, \mathcal{L}'_i) is at most $2k$ because $(T_{i-1}, \mathcal{L}_{i-1})$ has width at most k and V_i has dimension at most k .
- (2) We use the algorithm in Theorem 7.8 to compute transition matrices $\{T_v\}_{v \in V(T'_i)}$ of the transcript corresponding to (T'_i, \mathcal{L}'_i) in time $O(k^3 n^2)$. Note that the submatrix $M[I_1 \cup I_2 \cup \dots \cup I_i]$ is already in reduced row echelon form and so we can apply Theorem 7.8 by ignoring zero rows.
- (3) We compute the full set for \mathcal{V}_i by using Algorithm 1 with an input $(\mathcal{V}_i, k, (T'_i, \mathcal{L}'_i), \{T_v\}_{v \in V(T'_i)})$ in time $f_1(k, 2k, |\mathbb{F}|)i$ for some function f_1 by Proposition 7.10. If the full set at the root is empty, then the branch-width of \mathcal{V}_i is larger than k . If so, we conclude that the branch-width of \mathcal{V} is larger than k and stop.
- (4) If the full set at the root is nonempty, then we run Algorithm 3 to obtain a branch-decomposition (T_i, \mathcal{L}_i) of width at most k in time $f_2(k, 2k, |\mathbb{F}|)i$ for some function f_2 by Proposition 7.12.

If this algorithm finds (T_n, \mathcal{L}_n) , then (T_n, \mathcal{L}_n) is a branch-decomposition of \mathcal{V} having width at most k . For each i , (1)–(4) runs in at most $O(k^3 n^2) + f(k, |\mathbb{F}|)n$ time for some function f and therefore the total running time of this step is $O(k^3 n^3) + f(k, |\mathbb{F}|)n^2$. \square

Algorithm 3 Print a branch-decomposition of width at most k

```
1: procedure DECOMPOSITION( $r$ )
2:    $\alpha \leftarrow$  PRINTNODE( $r$ , the unique node of  $T(\Gamma_r)$ )
3:   if  $\alpha \geq 2$  then
4:     print '*' ( $\alpha - 1$ ) times
5:   end if
6: end procedure
7: function PRINTNODE( $x, v$ )
8:   if  $x$  is a leaf node then
9:     print  $i \in \{1, 2, \dots, |\mathcal{V}|\}$  such that  $x$  corresponds to  $V_i$ 
10:    return 1
11:  else if  $x$  is a join node then
12:    let  $y_1$  and  $y_2$  be two children of  $x$  in  $T^c$ 
13:    if the degree of  $v$  in  $T(\Gamma_x)$  is at most 2 then
14:      if  $v$  is a branch node in  $\eta_1$  then
15:        let  $v'$  be a node of  $T(\Gamma_{y_1})$  such that  $\bar{\eta}_1(v') = v$ 
16:        return PRINTNODE( $y_1, v'$ )
17:      else
18:        let  $v'$  be a node of  $T(\Gamma_{y_2})$  such that  $\bar{\eta}_2(v') = v$ 
19:        return PRINTNODE( $y_2, v'$ )
20:      end if
21:    end if
22:    return 0
23:  end if
24:  let  $y$  be the child of  $x$  in  $T^c$ 
25:  if  $x$  is a compare node then
26:    if there exists the node  $v'$  of  $T(\Gamma_y)$  corresponding to  $v$  then
27:      return PRINTNODE( $y, v'$ )
28:    end if
29:    return 0
30:  else if  $x$  is a shrink node then
31:    return PRINTNODE( $y, v$ )
32:  else if  $x$  is a trim node and  $T(\Gamma_x)$  has at least two nodes then
33:     $\alpha \leftarrow 0$ 
34:    if  $\deg_{T(\Gamma_y)}(v) = \deg_{T(\Gamma_x)}(v)$  then
35:       $\alpha \leftarrow \alpha +$  PRINTNODE( $y, v$ )
36:    else
37:      for each edge  $vw$  incident with  $v$  in  $T(\Gamma_y)$  do
38:        if  $vw$  is not in  $T(\Gamma_x)$  then
39:           $\alpha \leftarrow \alpha +$  PRINTSUBTREE( $y, v, w$ )
40:        end if
41:      end for
42:    end if
43:    return  $\alpha$ 
```

```

44:   else if  $x$  is a trim node and  $T(\Gamma_x)$  has only one node then
45:     let  $uv$  be a degenerate edge of  $\Gamma_y$ 
46:     return PRINTSUBTREEMID( $y, u, v$ )+PRINTSUBTREEMID( $y, v, u$ )
47:   end if
48: end function
49: function PRINTINC( $x, v, e$ )
50:   if  $x$  is a join node then
51:     let  $y_1$  and  $y_2$  be two children of  $x$  in  $T^c$ 
52:      $\alpha \leftarrow 0$ 
53:     for  $i = 1$  to  $2$  do
54:       if  $v$  is a branch-node in  $\eta_i$  and  $e' = \eta_i(e)$  is an edge of  $T(\Gamma_{y_i})$  then
55:         let  $v'$  be a node of  $T(\Gamma_{y_i})$  such that  $\bar{\eta}_i(v') = v$ 
56:          $\alpha \leftarrow \alpha + \text{PRINTINC}(y_i, v', e')$ 
57:       end if
58:     end for
59:     return  $\alpha$ 
60:   end if
61:   let  $y$  be the child of  $x$  in  $T^c$ 
62:   if  $x$  is a compare node then
63:     let  $w$  be the end of  $e$  other than  $v$ 
64:     if  $v < w$  (according to the canonical linear ordering of  $V(T(\Gamma_x))$ ) then
65:       let  $v_0v_1 \cdots v_\ell$  be the path from  $v$  to  $w$  in the tree ensuring  $\Gamma_x \preceq \Gamma_y$ 
66:        $\alpha \leftarrow 0$ 
67:       for  $i = 1$  to  $\ell$  do
68:         if  $v_{i-1}$  is a branch node in the subdivision of  $T(\Gamma_y)$  then
69:           let  $v'_{i-1}$  be the node of  $T(\Gamma_y)$  corresponding to  $v_{i-1}$ 
70:           let  $e'$  be the edge incident with  $v'_{i-1}$  that corresponds to  $v_{i-1}v_i$ 
71:            $\alpha \leftarrow \alpha + \text{PRINTINC}(y, v'_{i-1}, e')$ 
72:         end if
73:         if  $v_i$  is a branch node in the subdivision of  $T(\Gamma_y)$  then
74:           let  $v'_i$  be the node of  $T(\Gamma_y)$  corresponding to  $v_i$ 
75:           let  $e'$  be the edge incident with  $v'_i$  that corresponds to  $v_{i-1}v_i$ 
76:            $\alpha \leftarrow \alpha + \text{PRINTINCREV}(y, v'_i, e')$ 
77:         if  $i < \ell$  then
78:            $\alpha \leftarrow \alpha + \text{PRINTNODE}(y, v'_i)$ 
79:         end if
80:       end if
81:     end for
82:     return  $\alpha$ 
83:   end if
84: end if
85:   if  $x$  is a trim node or a shrink node then
86:     return PRINTINC( $y, v, e$ )
87:   end if
88: end function
89: function PRINTINCREV( $x, v, e$ )

```

```

90:   if  $x$  is a join node then
91:     let  $y_1$  and  $y_2$  be two children of  $x$  in  $T^c$ 
92:      $\alpha \leftarrow 0$ 
93:     for  $i = 2$  to  $1$  do
94:       if  $v$  is a branch-node in  $\eta_i$  and  $e' = \eta_i(e)$  is an edge of  $T(\Gamma_{y_i})$  then
95:         let  $v'$  be a node of  $T(\Gamma_{y_i})$  such that  $\bar{\eta}_i(v') = v$ 
96:          $\alpha \leftarrow \alpha + \text{PRINTINCREV}(y_i, v', e')$ 
97:       end if
98:     end for
99:     return  $\alpha$ 
100:  end if
101:  let  $y$  be the child of  $x$  in  $T^c$ 
102:  if  $x$  is a compare node then
103:    let  $w$  be the end of  $e$  other than  $v$ 
104:    if  $v < w$  (according to the canonical linear ordering of  $V(T(\Gamma_x))$ ) then
105:      let  $v_0v_1 \cdots v_\ell$  be the path from  $v$  to  $w$  in the tree ensuring  $\Gamma_x \preceq \Gamma_y$ 
106:       $\alpha \leftarrow 0$ 
107:      for  $i = \ell$  to  $1$  do
108:        if  $v_i$  is a branch node in the subdivision of  $T(\Gamma_y)$  then
109:          if  $i < \ell$  then
110:             $\alpha \leftarrow \alpha + \text{PRINTNODE}(y, v'_i)$ 
111:          end if
112:          let  $v'_i$  be the node of  $T(\Gamma_y)$  corresponding to  $v_i$ 
113:          let  $e'$  be the edge incident with  $v'_i$  that corresponds to  $v_{i-1}v_i$ 
114:           $\alpha \leftarrow \alpha + \text{PRINTINC}(y, v'_i, e')$ 
115:        end if
116:        if  $v_{i-1}$  is a branch node in the subdivision of  $T(\Gamma_y)$  then
117:          let  $v'_{i-1}$  be the node of  $T(\Gamma_y)$  corresponding to  $v_{i-1}$ 
118:          let  $e'$  be the edge incident with  $v'_{i-1}$  that corresponds to  $v_{i-1}v_i$ 
119:           $\alpha \leftarrow \alpha + \text{PRINTINCREV}(y, v'_{i-1}, e')$ 
120:        end if
121:      end for
122:      return  $\alpha$ 
123:    end if
124:  end if
125:  if  $x$  is a trim node or a shrink node then
126:    return  $\text{PRINTINCREV}(y, v, e)$ 
127:  end if
128: end function
129: function PRINTSUBTREE( $x, u, v$ )
130:    $\alpha \leftarrow \text{PRINTINC}(x, u, uv)$ 
131:    $\alpha \leftarrow \alpha + \text{PRINTINCREV}(x, v, uv)$ 
132:   for each neighbor  $w$  of  $v$  with  $w \neq u$  do
133:      $\alpha \leftarrow \alpha + \text{PRINTSUBTREE}(x, v, w)$ 
134:   end for
135:    $\alpha \leftarrow \alpha + \text{PRINTNODE}(x, v)$ 

```

```

136:   if  $\alpha \geq 1$  then
137:       print '*' ( $\alpha - 1$ ) times
138:       return 1
139:   else
140:       return 0
141:   end if
142: end function
143: function PRINTSUBTREEMID( $x, u, v$ )
144:    $\alpha \leftarrow$  PRINTINCREV( $x, v, uv$ )
145:   for each neighbor  $w$  of  $v$  with  $w \neq u$  do
146:        $\alpha \leftarrow \alpha +$  PRINTSUBTREE( $x, v, w$ )
147:   end for
148:    $\alpha \leftarrow \alpha +$  PRINTNODE( $x, v$ )
149:   if  $\alpha \geq 1$  then
150:       print '*' ( $\alpha - 1$ ) times
151:       return 1
152:   else
153:       return 0
154:   end if
155: end function

```

References

- [1] Hans L. Bodlaender and Ton Kloks, *Efficient and constructive algorithms for the pathwidth and treewidth of graphs*, J. Algorithms **21** (1996), no. 2, 358–402. MR 1405685 (98g:68122)
- [2] Hans L. Bodlaender and Dimitrios M. Thilikos, *Constructive linear time algorithms for branchwidth*, Automata, languages and programming (Bologna, 1997), Lecture Notes in Comput. Sci., vol. 1256, Springer, Berlin, 1997, pp. 627–637. MR 1616221
- [3] Bruno Courcelle and Stephan Olariu, *Upper bounds to the clique width of graphs*, Discrete Appl. Math. **101** (2000), no. 1-3, 77–114. MR 2001e:68145
- [4] William H. Cunningham and Jim Geelen, *On integer programming and the branch-width of the constraint matrix*, Proceedings of the 13th International IPCO Conference, Ithaca, NY, USA, June 25-27, 2007 (M. Fishetti and D. Williamson, eds.), Lecture Notes in Computer Science, vol. 4513, 2007, pp. 158–166.
- [5] Michael R. Fellows, Frances A. Rosamond, Udi Rotics, and Stefan Szeider, *Clique-width is NP-complete*, SIAM J. Discrete Math. **23** (2009), no. 2, 909–939.
- [6] James F. Geelen, A. M. H. Gerards, Neil Robertson, and Geoff Whittle, *On the excluded minors for the matroids of branch-width k* , J. Combin. Theory Ser. B **88** (2003), no. 2, 261–265. MR 1 983 357
- [7] Petr Hliněný, *Branch-width, parse trees, and monadic second-order logic for matroids*, J. Combin. Theory Ser. B **96** (2006), no. 3, 325–351. MR 2220663 (2007a:68050)

- [8] Petr Hliněný and Sang-il Oum, *Finding branch-decompositions and rank-decompositions*, SIAM J. Comput. **38** (2008), no. 3, 1012–1032. MR 2421076
- [9] Jisu Jeong, Eun Jung Kim, and Sang-il Oum, *Constructive algorithm for path-width of matroids*, Proceedings of the Twenty-Seventh Annual ACM-SIAM Symposium on Discrete Algorithms (SODA 2016) (Philadelphia, PA, USA), Society for Industrial and Applied Mathematics, 2016, pp. 1695–1704.
- [10] ———, *The “art of trellis decoding” is fixed-parameter tractable*, IEEE Trans. Inform. Theory **63** (2017), no. 11, 7178–7205, An extended abstract appeared in a conference proceeding [9].
- [11] ———, *Finding branch-decompositions of matroids, hypergraphs, and more*, Proc. 45th Int. Coll. on Automata, Languages and Programming (ICALP 2018), vol. 80:1–80:14, 2018.
- [12] Mamadou Moustapha Kanté and Michael Rao, *The rank-width of edge-coloured graphs*, Theory Comput. Syst. **52** (2013), no. 4, 599–644. MR 3038515
- [13] Jens Lagergren and Stefan Arnborg, *Finding minimal forbidden minors using a finite congruence*, Automata, languages and programming (Madrid, 1991), Lecture Notes in Comput. Sci., vol. 510, Springer, Berlin, 1991, pp. 532–543. MR 1129933
- [14] Sang-il Oum and Paul Seymour, *Approximating clique-width and banch-width*, J. Combin. Theory Ser. B **96** (2006), no. 4, 514–528.
- [15] ———, *Testing branch-width*, J. Combin. Theory Ser. B **97** (2007), no. 3, 385–393.
- [16] James Oxley, *Matroid theory*, second ed., Oxford Graduate Texts in Mathematics, vol. 21, Oxford University Press, Oxford, 2011. MR 2849819
- [17] Bruce A. Reed, Kaleigh Smith, and Adrian Vetta, *Finding odd cycle transversals*, Oper. Res. Lett. **32** (2004), no. 4, 299–301.
- [18] Neil Robertson and Paul D. Seymour, *Graph minors. X. Obstructions to tree-decomposition*, J. Combin. Theory Ser. B **52** (1991), no. 2, 153–190. MR 1110468
- [19] Paul D. Seymour and Robin Thomas, *Call routing and the ratcatcher*, Combinatorica **14** (1994), no. 2, 217–241. MR 1289074
- [20] Dimitrios M. Thilikos and Hans L. Bodlaender, *Constructive linear time algorithms for branchwidth*, Tech. Report UU-CS 2000-38, Universiteit Utrecht, 2000.
- [21] Dimitrios M. Thilikos, Maria J. Serna, and Hans L. Bodlaender, *Constructive linear time algorithms for small cutwidth and carving-width*, Algorithms and computation (Taipei, 2000), Lecture Notes in Comput. Sci., vol. 1969, Springer, Berlin, 2000, pp. 192–203. MR 1858364