

MINIMAL COLORING NUMBER ON MINIMAL DIAGRAMS FOR \mathbb{Z} -COLORABLE LINKS

KAZUHIRO ICHIHARA AND ERI MATSUDO

ABSTRACT. It was shown that any \mathbb{Z} -colorable link has a diagram which admits a non-trivial \mathbb{Z} -coloring with at most four colors. In this paper, we consider minimal numbers of colors for non-trivial \mathbb{Z} -colorings on minimal diagrams of \mathbb{Z} -colorable links. We show, for any positive integer N , there exists a minimal diagram of a \mathbb{Z} -colorable link such that any \mathbb{Z} -coloring on the diagram has at least N colors. On the other hand, it is shown that certain \mathbb{Z} -colorable torus links have minimal diagrams admitting \mathbb{Z} -colorings with only four colors.

1. INTRODUCTION

One of the most well-known invariants of knots and links would be the Fox n -coloring for an integer $n \geq 2$. For example, the tricolorability is much often used to prove that the trefoil is non-trivial.

However, some of links are known to admit no such non-trivial n -colorings. A particular class of such links is the links with 0 determinants. (See [2] for example.) For such a link, it can be defined a \mathbb{Z} -coloring as follows, which is a natural generalization to the Fox n -coloring.

Let L be a link and D a regular diagram of L . We consider a map γ from the set of the arcs of D to \mathbb{Z} . If γ satisfies the condition $2\gamma(a) = \gamma(b) + \gamma(c)$ at each crossing of D with the over arc a and the under arcs b and c , then γ is called a \mathbb{Z} -coloring on D . A \mathbb{Z} -coloring which assigns the same integer to all the arcs of the diagram is called the *trivial \mathbb{Z} -coloring*. A link is called \mathbb{Z} -colorable if it has a diagram admitting a non-trivial \mathbb{Z} -coloring. Throughout this paper, we often call the integers appearing the image of a \mathbb{Z} -coloring *colors*.

For the Fox n -coloring, the minimal number of colors has been studied in details. Actually, the minimal numbers of colors for n -colorable knots and links behave interestingly, and are often hard to determine.

On the other hand, for \mathbb{Z} -colorable links, the following was shown by the second author in [4] and by Meiqiao Zhang, Xianan Jin and Qingying Deng in [5] independently, based on the result given in [3].

Theorem. *The minimal coloring number of any non-splittable \mathbb{Z} -colorable link is equal to 4.*

Here the *minimal coloring number* of a diagram D of a \mathbb{Z} -colorable link L is defined as the minimal number of the colors for all non-trivial \mathbb{Z} -colorings on D , and the *minimal coloring number* of L is defined as the minimum of the minimal

Date: May 11, 2022.

2010 Mathematics Subject Classification. 57M25.

Key words and phrases. \mathbb{Z} -coloring, link, minimal diagram.

coloring numbers of diagrams representing the link L . Note that the minimal coloring number of any splittable \mathbb{Z} -colorable link is equal to 2.

Now we remark that the proofs in both [4] and [5] are quite algorithmic. Therefore the obtained diagrams in the proofs admitting a \mathbb{Z} -coloring with four colors are often very complicated.

In view of this, in this paper, we consider the minimal coloring numbers of *minimal diagrams* of \mathbb{Z} -colorable links, that is, the diagrams representing the link with least number of crossings. Remark that there are many minimal diagrams for each link in general.

First we show the following.

Theorem 1.1. *For any positive integer N , there exists a non-splittable \mathbb{Z} -colorable link with a minimal diagram admitting only \mathbb{Z} -colorings with at least N colors.*

In fact, the examples are given by families of pretzel links; $P(n, -n, n, -n, \dots, n, -n)$ with at least 4 strands, $P(-n, n+1, n(1-n))$ with a positive integer n . These will be treated in Section 2.

On the other hand, by considering some particular subfamily, as a corollary, we have the following.

Corollary 1.2. *There exists an infinite family of \mathbb{Z} -colorable pretzel links each of which has a minimal diagram admitting a \mathbb{Z} -coloring with only four colors.*

Also such examples are given by \mathbb{Z} -colorable torus links as follows.

Theorem 3.1. *For even integer $n > 2$ and non-zero integer p , the torus link $T(pn, n)$ has a minimal diagram admitting a \mathbb{Z} -coloring with only four colors.*

2. PRETZEL LINKS

In this section, we prove the next theorem.

Theorem 2.1. *For an even number $n \geq 2$, the pretzel link $P(n, -n, \dots, n, -n)$ with at least 4 strands has a minimal diagram admitting only \mathbb{Z} -colorings with $n+2$ colors.*

Here a *pretzel link* $P(a_1, \dots, a_n)$ is defined as a link admitting a diagram consisting rational tangles corresponding to $1/a_1, 1/a_2, \dots, 1/a_n$ located in line. See Figure 1.

Proof of Theorem 2.1. The pretzel link $P(n, -n, \dots, n, -n)$ is \mathbb{Z} -colorable since its determinant is 0 for the link. See [1] for example. Also, in [3], an example of \mathbb{Z} -coloring for the link is given.

Let D be the diagram of $P(n, -n, \dots, n, -n)$ illustrated in Figure 1. This D is a minimal diagram of the link due to the result in [8].

As shown in [3], without changing the number of the colors, we may assume that the minimum of the colors for γ is 0, and the arc colored by 0 cannot cross over the arcs colored by the other colors. Thus, due to symmetry, we can set the color of the arc x_1 as 0, and the color of the x_2 as $a > 0$ in Figure 1, since γ is assumed to be non-trivial.

Here recall that the colors of the arcs around some twists appear as an arithmetic sequence as in Figure 2.

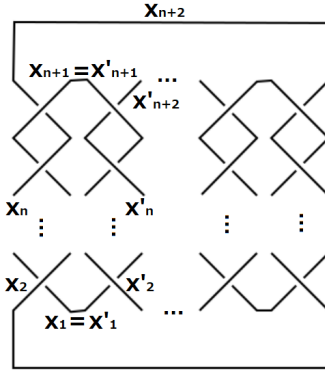

FIGURE 1.

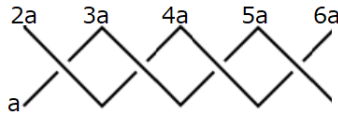

FIGURE 2.

For $x_1, x_2, \dots, x_n, x_{n+1}, x_{n+2}$, we see the color of $x_i (i = 1, 2, \dots, n, n+1, n+2)$ is equal to $(i-1)a$. That is, x_{n+1} is colored by na , x_{n+2} is colored by $(n+1)a$.

For $x'_1 (= x_1), x'_2, \dots, x'_n, x'_{n+1} (= x_{n+1}), x'_{n+2}$, since x'_1 is colored by 0 and x_{n+1} is colored by na under γ , we see the color of $x'_i (i = 1, 2, \dots, n, n+1, n+2)$ is equal to $(i-1)a$.

In the same way, we can show that D_m is colored by γ as illustrated by Figure 3.

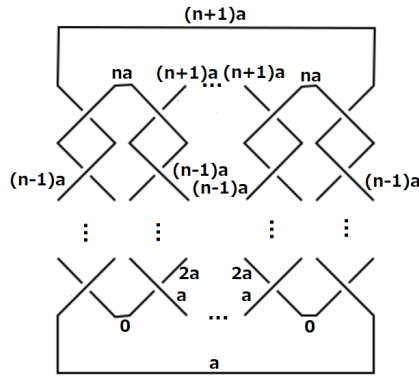

FIGURE 3.

Then the colors of γ are $0, a, 2a, \dots, (n+1)a$. That is, the minimal coloring number of D_m is equal to $n+2$. \square

Proof of Corollary 1.2. We consider the pretzel link $P(2, -2, 2, -2, \dots, 2, -2)$. The diagram depicted in Figure 4 is a minimal diagram by [8]. On the other hand, the \mathbb{Z} -coloring given in the figure has only four colors $\{0, 1, 2, 3\}$.

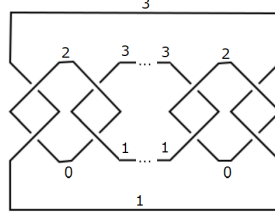

FIGURE 4.

\square

Next we consider the pretzel link $P(-n, 1+n, n(1+n))$ for a positive integer n , and show the following.

Theorem 2.2. *For a positive integer n , the pretzel link $P(-n, n+1, n(1-n))$ has a minimal diagram admitting only \mathbb{Z} -colorings with $n^2 + 3n + 1$ colors.*

Such pretzel links are all \mathbb{Z} -colorable by [1] for example.

Remark that the diagram has $n^2 + 3n + 1$ crossings, and so, all the arcs in the diagram are colored by different colors.

Proof of Theorem 2.2. Let D be a diagram illustrated by Figure 5. It is a minimal diagram of $P(-n, n+1, n(1-n))$ as in the previous cases.

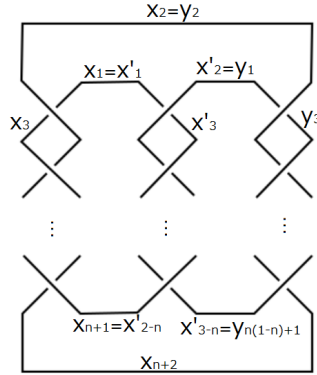

FIGURE 5.

Suppose that a \mathbb{Z} -coloring γ on D is given. As shown in [3], without changing the number of the colors, we may assume that the minimum of the colors for γ is

0, and the arc colored by 0 cannot cross over the arcs colored by the other colors. Thus, on the diagram D , there only two arcs x_1 and x_{n+2} which can be colored by 0. Then, due to symmetry, we may assume that the color of the arc x_1 is 0. Set the color of x_2 as a and the color of x'_2 as b in Figure 6. Note that a and b are both non-zero, for γ is assumed to be non-trivial.

For $x_1, x_2, \dots, x_n, x_{n+1}, x_{n+2}$, we see the color of x_i under γ is equal to $(i-1)a$. Similarly, for $x'_1(=x_1), x'_2, \dots, x'_{1-n}, x'_{2-n}(=x_{n+1})$, we see the color of x'_i is equal to $(i-1)b$. From x_{n+1} and x'_{2-n} express the same arc, we see that $na = (1-n)b$. Since n and $1-n$ are co-prime, we obtain $(a, b) = (1-n, n)$ for $a, b > 0$. Then x'_{2-n} is colored by $n^2 + 2n$, and, for the arcs $y_1(=x'_1), y_2(=x_2), y_3, \dots, y_{n(1-n)+1}$, we see that the color of y_i is equal to $n+i-1$ under γ from the color of y_1 is n and the color of y_2 is $n+1$.

Consequently γ is illustrated by Figure 6, and the minimal coloring number of D is equal to $n^2 + 3n + 1$.

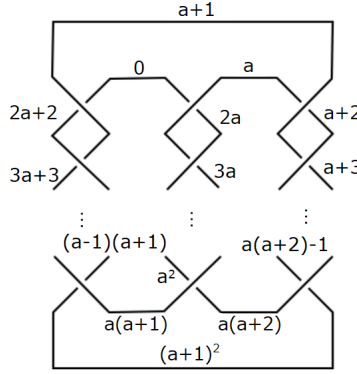

FIGURE 6.

□

3. TORUS LINKS

In this section, we consider *torus links*, that is, the links isotoped onto the standardly embedded torus in the 3-space. By $T(a, b)$, we mean the torus link running a times meridionally and b times longitudinally.

Theorem 3.1. *For even integer $n > 2$ and non-zero integer p , the torus link $T(pn, n)$ has a minimal diagram admitting a \mathbb{Z} -coloring with only four colors.*

Proof. Let D be the standard diagram of $T(pn, n)$ illustrated by Figure 7. This D has the least number of crossings for the torus link, that is well-known. See [6] for example.

In the following, we will find a \mathbb{Z} -coloring on D by assigning colors on the arcs of D .

Note that the link has n components running horizontally with p times twistings as shown in D . In a local view, we see n horizontal parallel arcs in D . There are pn such sets of parallel arcs in D . See Figure 8.

Take a set of such parallel arcs, and assign the colors as $X_1 = {}^t(1, 0, \dots, 0, 1)$.

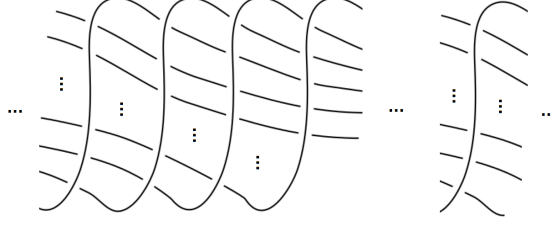

FIGURE 7.

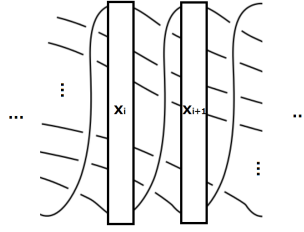

FIGURE 8.

Then, by considering the condition of the \mathbb{Z} -coloring, we can find a matrix

$$A = \begin{pmatrix} 0 & \cdots & \cdots & 0 & 1 \\ -1 & 0 & \cdots & 0 & 2 \\ 0 & \ddots & \ddots & \vdots & 2 \\ \vdots & \ddots & \ddots & 0 & \vdots \\ 0 & \cdots & 0 & -1 & 2 \end{pmatrix}$$

such that AX_1 gives a set of colors for the right adjacent set of parallel arcs to the prescribed one. Set AX_1 as X_2 and repeat this procedure. In fact, we obtain $X_2 = AX_1 = {}^t(1, 1, 2, \dots, 2)$.

In the same way, we have $X_4 = A^2X_2 = {}^t(2, 2, 1, 1, 2, \dots, 2)$ as the colors for the 4th set of parallel arcs from the first one. By repeating further, we obtain that $X_n = (A^2)^{(n-2)/2}X_2 = {}^t(2, \dots, 2, 1, 1)$, since n is even. Moreover we see $X_{n+1} = AX_n = {}^t(1, 0, \dots, 0, 1)$. That is, $X_1 = X_{n+1}$ holds.

Since there are pn such sets of parallel arcs in D , this implies that an appropriate set of colors on all the arcs in D , equivalently, a \mathbb{Z} -coloring on D , can be found.

Furthermore, we have $X_3 = AX_2 = {}^t(2, 3, 3, \dots, 2)$, $X_5 = A^2X_3 = {}^t(2, 2, 2, 3, 3, 2, \dots, 2)$, and by repeating further, we obtain $X_{n-1} = (A^2)^{(n-2)/2}X_3 = {}^t(2, \dots, 2, 3, 3, 2)$.

It concludes that the colors of this \mathbb{Z} -coloring is $\{0, 1, 2, 3\}$, that is, the \mathbb{Z} -coloring is four colored. \square

REFERENCES

- [1] O. T. Dasbach, D. Futer, E. Kalfagianni, X.-S. Lin, and N. W. Stoltzfus, Alternating sum formulae for the determinant and other link invariants, *J. Knot Theory Ramifications* **19** (2010), no. 6, 765–782.

- [2] K. Ichihara and E. Matsudo, A lower bound on minimal number of colors for links, *Kobe J. Math.* **33** (2016), no. 1-2, 53–60.
- [3] K. Ichihara and E. Matsudo, Minimal coloring number for \mathbb{Z} -colorable links, *J. Knot Theory Ramifications* **26** (2017), no. 4, 1750018, 23 pp.
- [4] E. Matsudo, Minimal coloring number for \mathbb{Z} -colorable links II, preprint, arXiv:1705.07567v3 .
- [5] M. Zhang, X. Jin, and Q. Deng, The Minimal Coloring Number Of Any Non-splittable \mathbb{Z} -colorable Link Is Four, preprint, arXiv:1706.08837.
- [6] A. Kawauchi, *Lectures on knot theory*, Monograph in Japanese, 2007, Kyoritsu Shuppan Co. Ltd.
- [7] W. B. R. Lickorish, *An introduction to knot theory*, Graduate Texts in Mathematics, 175, Springer, New York, 1997.
- [8] W. B. R. Lickorish and M. B. Thistlethwaite, Some links with nontrivial polynomials and their crossing-numbers, *Comment. Math. Helv.* **63** (1988), no. 4, 527–539.

DEPARTMENT OF MATHEMATICS, COLLEGE OF HUMANITIES AND SCIENCES, NIHON UNIVERSITY,
3-25-40 SAKURAJOSUI, SETAGAYA-KU, TOKYO 156-8550, JAPAN
E-mail address: `ichihara@math.chs.nihon-u.ac.jp`

GRADUATE SCHOOL OF INTEGRATED BASIC SCIENCES, NIHON UNIVERSITY, 3-25-40 SAKURAJOSUI,
SETAGAYA-KU, TOKYO 156-8550, JAPAN
E-mail address: `cher16001@g.nihon-u.ac.jp`