

Computing twisted Alexander polynomials for Montesinos links

Haimiao Chen *

Mathematics, Beijing Technology and Business University, Beijing, China

Abstract

In recent years, twisted Alexander polynomial has been playing an important role in low-dimensional topology. For a class of links, namely Montesinos links, we present an efficient method to compute the twisted Alexander polynomial associated to any linear representation. In particular, formulas for multi-variable Alexander polynomials of these links can be easily derived.

Keywords: linear representation, twisted Alexander polynomial, multi-variable Alexander polynomial, Montesinos link

MSC2010: 57M25, 57M27

1 Introduction

Twisted Alexander polynomial (TAP for short) was first proposed by Lin [20] and Wada [28] independently. Given a link $L \subset S^3$. To each linear representation ρ of $\pi_1(L) := \pi_1(S^3 - L)$ is associated the TAP $\Delta_{L,\rho}$. People have found TAP to be extremely useful in low-dimensional topology.

Friedl and Vidussi [8] showed that TAP can detect the unknot and the Hopf link. They also constructed a pair of knots with the same HOMFLY polynomial, Khovanov and knot Floer homology, but distinguished by TAP.

As a classical result of Fox and Milnor [7], if K is slice, then the ordinary Alexander polynomial can be written as $f(t)f(t^{-1})$ for some f . Generalized to TAP, more slice obstructions of such kind were obtained. Kirk and Livingston [17] showed that some knots (e.g. 8_{17}) are not concordant to their inverses. Herald, Kirk and Livingston [12] showed that 16 of the knots with no more than 12 crossings are not slice; this could not be done before.

Fibredness can also be detected via TAP. Kitano and Morifuji [18] proved that if K is fibered, then $\Delta_{K,\rho}$ is monic of degree $4g(K) - 2$ (where $g(K)$ is the genus of K) for any nonabelian $\rho : \pi_1(K) \rightarrow \mathrm{SL}(2, \mathbb{F})$ for any field \mathbb{F} . Closely related is the following

*Email: chenhm@math.pku.edu.cn. This work is supported by NSFC (Grant No. 11401014)

Conjecture 1.1 (Dunfield, Friedl and Jackson, 2012). *If K is a hyperbolic knot and $\rho_0 : \pi(K) \rightarrow \mathrm{SL}(2, \mathbb{C})$ is a lift of the discrete and faithful representation defining the hyperbolic metric, then $\Delta_{K, \rho_0} = 4g(K) - 2$. Furthermore, K is fibered if and only if Δ_{K, ρ_0} is monic.*

The following result of Friedl and Vidussi [10] is remarkable: a knot K is fibered if and only if there exist a, b (which can be expressed in terms of invariants of K) such that $\deg \Delta_{K, \rho} = a|G| + b$ for any representation ρ factoring through a finite group G .

Another topic attracting much attention is the existence of epimorphisms between knot groups. Denote $K \geq K'$ if there exists $\pi(K) \twoheadrightarrow \pi(K')$. This was known to define a partial order among prime knots. As shown in [19], if $\varphi : \pi(K) \rightarrow \pi(K')$ is an epimorphism, then $\Delta_{K, \rho \circ \varphi} / \Delta_{K', \rho} \in R[t^{\pm 1}]$ for any $\rho : \pi(K') \rightarrow \mathrm{GL}(d, R)$.

TAP as a function on character variety is interesting and deserves further study.

For more applications of TAP, see [6, 9, 11, 13, 27] and the references therein.

TAP is usually thought of as a non-abelian, yet manageable invariant. TAPs of twist knots for nonabelian $\mathrm{SL}(2, \mathbb{C})$ -representations were computed in [21] and found interesting applications. Hoste and Shanahan [14] computed $\Delta_{K, \rho}$ for a class of 2-bridge knots K and for ρ factorizing through a dihedral group. Morifuji and Tran [22] computed TAPs associated to parabolic $\mathrm{SL}(2, \mathbb{C})$ -representations of double twist knots and verified Conjecture 1.1. Tran [26] derived formulas for $\Delta_{K, \rho}$, when K is a torus knot or a twist knot, and ρ is the adjoint representation associated to an $\mathrm{SL}(2, \mathbb{C})$ -representation. Besides, there are few computations for families of links or of representations seen in the literature. Indeed, unlike the ordinary Alexander polynomial, in general there is no “skein relation” to use. For a link with m crossings and a d -dimensional linear representation, to obtain TAP by definition, one needs to compute the determinant of a $(m-1)d \times (m-1)d$ matrix, which is a tremendous job.

For Montesinos links L , we present a practical method for deriving a “universal” formula for the TAP associated to any linear representation. Given a d -dimensional linear representation ρ , the computation of $\Delta_{L, \rho}$ can be reduced to those among $d \times d$ -matrices. This method will be helpful for knot theorists to do computations, and promote studying TAP. After all, Montesinos links, especially double twist links and pretzel links, are usually taken as examples to support general results, sometimes a new conjecture, as done in [1, 22, 23]. Specialized to the trivial representation, multi-variable Alexander polynomials can be quickly computed, which may be beneficial to the realization problem of Alexander polynomials (see [24] Section 9). Furthermore, till now the relation \geq between Montesinos knots is little understood, so is “1-domination” which is an enhance of \geq ; see [2]. We expect TAP to be helpful to these problems.

Acknowledgement

This work is supported by NSFC-11401014 and NSFC-11501014.

2 Preliminary

Notation 2.1. For a (not necessarily commutative) ring R , let R^\times denote the set of invertible elements. For positive integers d, d' , let $\mathcal{M}_d^{d'}(R)$ denote the set of $d \times d'$ matrices with entries in R . Let $\mathcal{M}_d(R) = \mathcal{M}_d^d(R)$.

Given $A \in \mathcal{M}_d^{d'}(R)$. Let $A_{-i} \in \mathcal{M}_{d-1}^{d'}(R)$ (resp. $A^{-j} \in \mathcal{M}_d^{d'-1}(R)$) be the matrix obtained by deleting the i -th row (resp. j -th column) of A . For a ring homomorphism $\psi : R \rightarrow R'$ and $A \in \mathcal{M}_d^{d'}(R)$, let $\psi(A) \in \mathcal{M}_d^{d'}(R')$ denote the matrix obtained from A by replacing each entry with its image under ψ .

For $k \in \mathbb{Z}$ and $a \in R^\times$, put

$$[k]_a = \begin{cases} 1 + a + \cdots + a^{k-1}, & k > 0, \\ 0, & k = 0, \\ -a^k(1 + a + \cdots + a^{|k|-1}), & k < 0. \end{cases}$$

Given a group homomorphism $\sigma : G \rightarrow H$, let $\check{\sigma} : \mathbb{Z}G \rightarrow \mathbb{Z}H$ denote the canonical linear extension, which is a ring homomorphism.

For two elements g, h of a group, let $g.h = ghg^{-1}$.

2.1 Twisted Alexander polynomial

Suppose L is an oriented link with n components. Choose a planar diagram for L . Numerating arbitrarily, let $\alpha_1, \dots, \alpha_m$ be the directed arcs, and $\kappa_1, \dots, \kappa_m$ the crossings. Let F_m be the free group generated by $\tilde{x}_1, \dots, \tilde{x}_m$, with \tilde{x}_i corresponding to α_i . With the ‘‘over presentation’’ (see [5] Chapter VI) for $\pi = \pi_1(L)$, each positive crossing as in Figure 1 (a) gives rise to a relator $\tilde{x}_j \tilde{x}_k \tilde{x}_j^{-1} \tilde{x}_\ell^{-1}$, and each negative crossing as in Figure 1 (b) gives rise to a relator $\tilde{x}_j^{-1} \tilde{x}_k \tilde{x}_j \tilde{x}_\ell^{-1}$. Let $\phi : F_m \twoheadrightarrow \pi$ be the quotient map, and let $x_j = \phi(\tilde{x}_j)$. Let $\widetilde{M} \in \mathcal{M}_m(\mathbb{Z}F_m)$ be the matrix whose (i, j) -entry is $\partial \tilde{r}_i / \partial \tilde{x}_j$ (the Fox derivative), and let $M = \check{\phi}(\widetilde{M}) \in \mathcal{M}_m(\mathbb{Z}\pi)$.

Let

$$\alpha : \pi \twoheadrightarrow H_1(S^3 - L) \cong \mathbb{Z}^n = \langle t_1, \dots, t_n \rangle$$

denote the abelianization, with t_k the image of the k -th meridian.

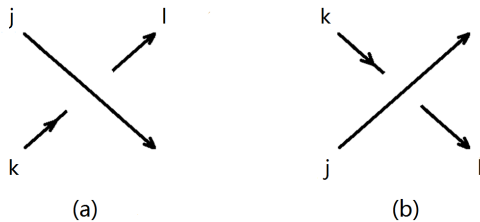

Figure 1: (a) a positive crossing $(\alpha_j, \alpha_k, \alpha_\ell)$; (b) a negative crossing $(\alpha_j, \alpha_k, \alpha_\ell)$

Given an integral domain R , let $R[\mathbf{t}^\pm] = R[t_1^{\pm 1}, \dots, t_n^{\pm 1}]$. For $f_1, f_2 \in R[\mathbf{t}^\pm]$, denote $f_1 \doteq f_2$ if $f_2 = \epsilon t_1^{e_1} \cdots t_n^{e_n} f_1$ with $\epsilon \in R^\times, e_1, \dots, e_n \in \mathbb{Z}$; clearly \doteq is

an equivalence relation. Given a representation $\rho : \pi \rightarrow \mathrm{GL}(d, R)$, there is a ring homomorphism $\mathbb{Z}\pi \rightarrow \mathcal{M}_d(R[\mathbf{t}^\pm])$ sending $\sum_i k_i a_i$ to $\sum_i k_i \bar{a}_i$, where \bar{a} is the image of a under the composite

$$\pi \xrightarrow{\alpha \times \rho} \mathbb{Z}^n \times \mathrm{GL}(d, R) \hookrightarrow R[\mathbf{t}^{\pm 1}] \times \mathcal{M}_d(R) \rightarrow \mathcal{M}_d(R[\mathbf{t}^\pm]). \quad (1)$$

According to [28], the *twisted Alexander polynomial* is defined to be

$$\Delta_{L, \rho} \doteq \frac{\det \left(\overline{M_{-i}^{-j}} \right)}{\det(1 - \bar{x}_j)},$$

with the understanding that, up to equivalence, the right-hand-side of \doteq is independent of all the choices. Also, it turns out that the right-hand-side lies in $R[\mathbf{t}^\pm]$.

It is known that, when $\rho = \rho_0$ is the (1-dimensional) trivial representation,

$$\Delta_{L, \rho_0} \doteq \begin{cases} \Delta_L / (t - 1), & n = 1, \\ \Delta_L, & n \geq 2, \end{cases} \quad (2)$$

where Δ_L is the multi-variable Alexander polynomial.

2.2 Montesinos tangle and Montesinos link

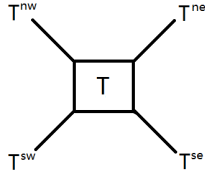

Figure 2: A tangle diagram with four ends

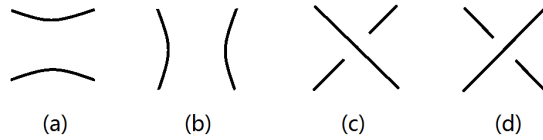

Figure 3: Four tangles in \mathcal{T}_2^2 : (a) $[0]$, (b) $[\infty]$, (c) $[1]$, (d) $[-1]$

Let \mathcal{T}_2^2 denote the set of tangles T with four ends $T^{nw}, T^{ne}, T^{sw}, T^{se}$, as in Figure 2. The simplest ones are shown in Figure 3. Defined on \mathcal{T}_2^2 are horizontal composition $+$ and vertical composition $*$, as illustrated in Figure 4.

For $k \neq 0$, the horizontal composite of $|k|$ copies of $[1]$ (resp. $[-1]$) is denoted by $[k]$ if $k > 0$ (resp. $k < 0$), and the vertical composite of $|k|$ copies of $[1]$ (resp.

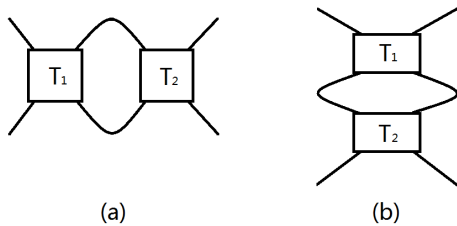

Figure 4: (a) $T_1 + T_2$; (b) $T_1 * T_2$

$[-1]$) is denoted by $[1/k]$ if $k > 0$ (resp. $k < 0$). For $k_1, \dots, k_r \in \mathbb{Z}$, the *rational tangle* $[[k_1], \dots, [k_r]]$ by definition is

$$\begin{cases} [k_1] * [1/k_2] + \dots + [k_r], & \text{if } 2 \nmid r, \\ [1/k_1] + [k_2] * \dots + [k_r], & \text{if } 2 \mid r. \end{cases}$$

Its *fraction* is given by the continued fraction $[[k_1, \dots, k_r]] \in \mathbb{Q}$, which is defined inductively as

$$[[k_1]] = k_1; \quad [[k_1, \dots, k_j]] = k_j + 1/[[k_1, \dots, k_{j-1}]], \quad j \geq 2.$$

Denote $[[k_1], \dots, [k_r]]$ as $[p/q]$ when its fraction equals p/q .

Note that we may define a linear ordering \prec on the set of crossings as follows: if κ is in $[k_i]$ and κ' is in $[k_{i'}]$, then $\kappa \prec \kappa'$ if either $i < i'$, or $i = i'$ is odd and κ lies on the left of κ' , or $i = i'$ is even and κ lies above κ' .

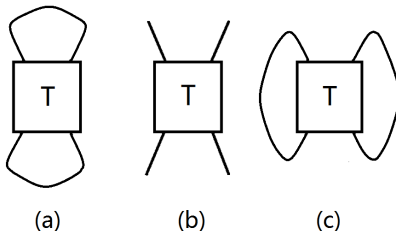

Figure 5: (a) the numerator $N(T)$; (b) a tangle T ; (c) the denominator $D(T)$

A *Montesinos tangle* is one of the form $[p_1/q_1] * \dots * [p_r/q_r]$.

Each $T \in \mathcal{T}_2^2$ gives rise to two links: the *numerator* $N(T)$ and the *denominator* $D(T)$; see Figure 5. For $p/q \in \mathbb{Q}$, the link $N([p/q])$ is called a *rational link* or *2-bridge link*. In particular, $N([[k_1], [k_2]])$ is called a *double twist link*, and $N([[k_1], [k_2], [k_3]])$ is called a *triple twist link*. A link of the form $D([p_1/q_1] * \dots * [p_s/q_s])$ is called a *Montesinos link* and denoted by $M(p_1/q_1, \dots, p_s/q_s)$; in particular, $M(p_1, \dots, p_s)$ is a *pretzel link*.

3 The method and illustrating examples

Notation 3.1. For a crossing $\kappa_i = (\alpha_j, \alpha_k, \alpha_\ell)$ as given in Figure 1, denote j, k, ℓ by $\bar{i}, \underline{i}, i'$, respectively.

If κ_i is positive, so that $\tilde{r}_i = \tilde{x}_{\bar{i}}\tilde{x}_{\underline{i}}\tilde{x}_{i'}^{-1}$, then

$$\left[\frac{\partial \tilde{r}_i}{\partial \tilde{x}_{\bar{i}}}, \frac{\partial \tilde{r}_i}{\partial \tilde{x}_{\underline{i}}}, \frac{\partial \tilde{r}_i}{\partial \tilde{x}_{i'}} \right] = [1 - \tilde{x}_{\bar{i}}\tilde{x}_{\underline{i}}\tilde{x}_{i'}^{-1}, \tilde{x}_{\bar{i}}, -\tilde{x}_{\bar{i}}\tilde{x}_{\underline{i}}\tilde{x}_{i'}^{-1}],$$

hence

$$\check{\phi} \left[\frac{\partial \tilde{r}_i}{\partial \tilde{x}_{\bar{i}}}, \frac{\partial \tilde{r}_i}{\partial \tilde{x}_{\underline{i}}}, \frac{\partial \tilde{r}_i}{\partial \tilde{x}_{i'}} \right] D(1 - x_{\bar{i}}, 1 - x_{\underline{i}}, 1 - x_{i'}) = (1 - x_{i'})[1 - x_{\bar{i}}, x_{\bar{i}}, -1],$$

where $D(a_1, a_2, a_3)$ denotes the 3×3 diagonal matrix with diagonal entries a_i .

If κ_i is negative so that $\tilde{r}_i = \tilde{x}_{\bar{i}}^{-1}\tilde{x}_{\underline{i}}\tilde{x}_{i'}^{-1}$, then

$$\left[\frac{\partial \tilde{r}_i}{\partial \tilde{x}_{\bar{i}}}, \frac{\partial \tilde{r}_i}{\partial \tilde{x}_{\underline{i}}}, \frac{\partial \tilde{r}_i}{\partial \tilde{x}_{i'}} \right] = [-\tilde{x}_{\bar{i}}^{-1} + \tilde{x}_{\bar{i}}^{-1}\tilde{x}_{\underline{i}}, \tilde{x}_{\bar{i}}^{-1}, -\tilde{x}_{\bar{i}}^{-1}\tilde{x}_{\underline{i}}\tilde{x}_{i'}^{-1}],$$

hence

$$\check{\phi} \left[\frac{\partial \tilde{r}_i}{\partial \tilde{x}_{\bar{i}}}, \frac{\partial \tilde{r}_i}{\partial \tilde{x}_{\underline{i}}}, \frac{\partial \tilde{r}_i}{\partial \tilde{x}_{i'}} \right] D(1 - x_{\bar{i}}, 1 - x_{\underline{i}}, 1 - x_{i'}) = (1 - x_{i'})[1 - x_{\bar{i}}^{-1}, x_{\bar{i}}^{-1}, -1].$$

Consequently,

$$MD = D'Q, \tag{3}$$

where

- (i) $D \in \mathcal{M}_m(\mathbb{Z}\pi)$ is diagonal with the j -th diagonal entry $1 - x_{\bar{i}}$;
- (ii) $D' \in \mathcal{M}_m(\mathbb{Z}\pi)$ is diagonal with the i -th diagonal entry $1 - x_{\underline{i}}$;
- (iii) $Q_{i,\bar{i}} = 1 - x_{\bar{i}}^\epsilon$, $Q_{i,\underline{i}} = x_{\underline{i}}^\epsilon$, $Q_{i,i'} = -1$, where $\epsilon = 1$ (resp. $\epsilon = -1$) if κ_i is positive (resp. negative), and $Q_{i,j} = 0$ for $j \notin \{\bar{i}, \underline{i}, i'\}$.

As a consequence of (3), for any i, j , one has $M_{\bar{i}}^{-j} D_{\bar{j}}^{-j} = (D')_{\bar{i}}^{-i} Q_{\bar{i}}^{-j}$, so that

$$\Delta_{L,\rho} \doteq \frac{\det \left(\overline{M_{\bar{i}}^{-j}} \right)}{\det(1 - \overline{x_j})} \doteq \frac{\det \left(\overline{Q_{\bar{i}}^{-j}} \right)}{\det(1 - \overline{x_{\bar{i}}})} \doteq \frac{\det \left(\overline{Q_{\bar{i}}^{-j}} \right)}{\det(1 - \overline{x_{i'}})}, \tag{4}$$

the second equality following from that $x_{i'}$ is conjugate to $x_{\bar{i}}$.

We shall do row transformations to convert Q into another matrix which is highly simplified. To speak conveniently, introduce formal variables $\xi_j, j = 1, \dots, m$. Each row of Q corresponds to an equation $\sum_{j=1}^m Q_{i,j} \xi_j = 0$, and doing row-transformations are equivalent to re-writing equations of such kind.

Convention 3.2. When presenting a tangle T , we actually regard it as part of some link L which has been or will be manifested, so each directed arc in T represents an element of $\pi_1(S^3 - L)$.

3.1 Computing TAP for rational links

Suppose $L = N(T)$, with $T = [[k_1], \dots, [k_r]]$.

Let $m = |k_1| + \dots + |k_r|$, so that T has m crossings and $m+2$ arcs. Numerate the crossings according to the linear ordering \prec given in Section 2.2. Let $\alpha_1 = [k_1]^{\text{nw}}$, $\alpha_2 = [k_1]^{\text{sw}}$ (c.f. Figure 2 for the meaning of T^{nw} , etc); for $j \geq 3$, recursively let α_j denote the unique arc such that $\{\iota(j-2), \iota'(j-2)\} = \{j, j'\}$ for some $j' < j$. Suppose $\alpha_{j^{\text{ne}}} = T^{\text{ne}}$, $\alpha_{j^{\text{sw}}} = T^{\text{sw}}$, $\alpha_{j^{\text{se}}} = T^{\text{se}}$; put $j^{\text{nw}} = 1$.

Introduce for each α_j a formal variable ξ_j ; also let $\xi^{\text{ne}} = \xi_{j^{\text{ne}}}$, etc. Define $Q_T \in \mathcal{M}_m^{m+2}(\mathbb{Z}\pi)$ by setting each row to fit the condition (iii) following (3). Then recursively, each ξ_j can be written as $(1 - b_j)\xi_1 + b_j\xi_2$ for some $b_j \in \mathbb{Z}\pi$. As an effect on matrices, via row-additions and row-multiplications with scalar $-x_i^{\pm 1}$, Q_T can be converted into

$$UQ_T = \begin{bmatrix} 1 - b_3 & b_3 & -1 & & \\ \vdots & \vdots & & \ddots & \\ 1 - b_{m+2} & b_{m+2} & & & -1 \end{bmatrix},$$

where $U \in \text{GL}(d, \mathbb{Z}\pi)$ is the matrix corresponding to row transformations; clearly $\det(U) \in (\mathbb{Z}\pi)^\times$.

Then UQ can be obtained from UQ_T by deleting the j^{ne} -th and j^{se} -columns and modifying the $(j^{\text{ne}} - 2)$ -th and $(j^{\text{se}} - 2)$ -th rows, which are equivalent to imposing $\xi^{\text{ne}} = \xi^{\text{nw}} = \xi_1$ and $\xi^{\text{se}} = \xi^{\text{sw}}$. Hence the $(j^{\text{ne}} - 2)$ -th row of UQ is $(-b^{\text{ne}}, b^{\text{ne}}, 0, \dots, 0)$, and the $(j^{\text{se}} - 2)$ -th row is $(b^{\text{sw}} - b^{\text{se}}, b^{\text{se}} - b^{\text{sw}}, 0, \dots, 0)$, where $b^{\text{ne}} = b_{j^{\text{ne}}}$ and so on. This shows

$$\det(\overline{Q_{-i_0}^{-1}}) \doteq \det(\overline{(UQ)_{-i_0}^{-1}}) = \det(\overline{b^{\text{ne}}}), \quad (5)$$

where $i_0 = m$ (resp. $i_0 = m - 1$) if $k_r > 0$ (resp. $k_r < 0$). Thus by (4),

$$\Delta_{N(T), \rho} \doteq \frac{\det(\overline{b^{\text{ne}}})}{\det(1 - \overline{x^{\text{se}}})}. \quad (6)$$

We show how to find $b^{\text{sw}}, b^{\text{ne}}, b^{\text{se}}$. For $k \in \mathbb{Z}$ and $a, b \in \pi \subset \mathbb{Z}\pi$, put

$$u_k(a, b) = \begin{cases} [\ell]_{ab} a(1 - b), & k = 2\ell, \\ [\ell + 1]_{ab} a - [\ell]_{ab} ab, & k = 2\ell + 1, \end{cases}$$

$$G_k(a, b) = \begin{bmatrix} 1 - u_k(a, b) & u_k(a, b) \\ 1 - u_{k-1}(a, b) & u_{k-1}(a, b) \end{bmatrix}.$$

In particular,

$$u_1(a, b) = a, \quad u_0(a, b) = 0, \quad u_{-1}(a, b) = 1, \quad u_{-2}(a, b) = 1 - b^{-1},$$

$$G_1(a, b) = \begin{bmatrix} 1 - a & a \\ 1 & 0 \end{bmatrix}, \quad G_{-1}(a, b) = \begin{bmatrix} 0 & 1 \\ b^{-1} & 1 - b^{-1} \end{bmatrix}.$$

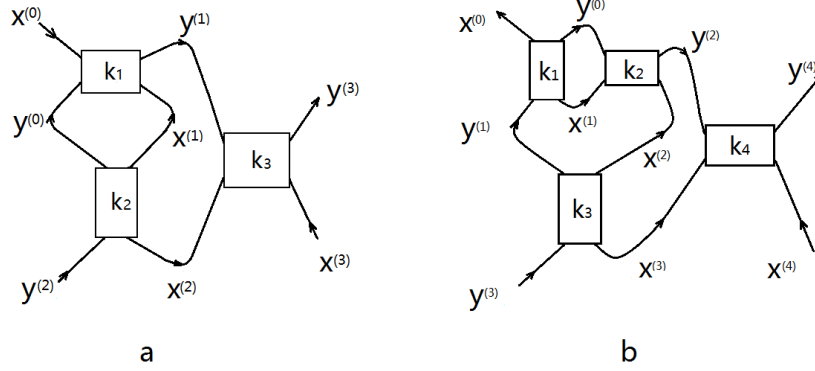

Figure 6: The “conventional labeling” of a rational tangle: (a) when r is odd; (b) when r is even

Notation 3.3. For a rational tangle $T = [[k_1], \dots, [k_r]]$, introduce the “conventional labeling” for some of the arcs; see Figure 6.

Lemma 3.4. Set $\eta_{y^{(0)}} = 1$, $\eta_{y^{(1)}} = u_{k_1}(x^{(0)}, y^{(0)})$, $\eta_{x^{(1)}} = u_{k_1-1}(x^{(0)}, y^{(0)})$. For $j \geq 2$, recursively compute $\eta_{x^{(j)}}$, $\eta_{y^{(j)}}$ via

$$\begin{bmatrix} \eta_{y^{(j)}} \\ \eta_{x^{(j)}} \end{bmatrix} = G_{k_j} \begin{bmatrix} \eta_{y^{(j-2)}} \\ \eta_{x^{(j-1)}} \end{bmatrix}.$$

Then $b^{\text{ne}} = \eta_{y^{(r)}}$, $b^{\text{sw}} = \eta_{y^{(r-1)}}$, $b^{\text{se}} = \eta_{x^{(r)}}$.

Proof. For each crossing, let ξ^{nw} denote the variable associated to the northwest arc, and so on. Adopt the following abbreviations:

$$\xi^{\text{w}} = \begin{bmatrix} \xi^{\text{nw}} \\ \xi^{\text{sw}} \end{bmatrix}, \quad \xi^{\text{e}} = \begin{bmatrix} \xi^{\text{ne}} \\ \xi^{\text{se}} \end{bmatrix}, \quad \xi^{\text{n}} = \begin{bmatrix} \xi^{\text{nw}} \\ \xi^{\text{ne}} \end{bmatrix}, \quad \xi^{\text{s}} = \begin{bmatrix} \xi^{\text{sw}} \\ \xi^{\text{se}} \end{bmatrix}.$$

For a positive crossing shown in Figure 7, $\xi_\ell = (1 - x_j)\xi_j + x_j\xi_k$, so in case (a), (b), (c), (d), respectively,

$$\begin{aligned} \xi^{\text{e}} &= \begin{bmatrix} 1 - x_j & x_j \\ 1 & 0 \end{bmatrix} \xi^{\text{w}}, & \xi^{\text{s}} &= \begin{bmatrix} 1 - x_j^{-1} & x_j^{-1} \\ 1 & 0 \end{bmatrix} \xi^{\text{n}}, \\ \xi^{\text{e}} &= \begin{bmatrix} 1 - x_j^{-1} & x_j^{-1} \\ 1 & 0 \end{bmatrix} \xi^{\text{w}}, & \xi^{\text{s}} &= \begin{bmatrix} 1 - x_j & x_j \\ 1 & 0 \end{bmatrix} \xi^{\text{n}}, \\ \xi^{\text{e}} &= \begin{bmatrix} 0 & 1 \\ x_j^{-1} & 1 - x_j^{-1} \end{bmatrix} \xi^{\text{w}}, & \xi^{\text{s}} &= \begin{bmatrix} 0 & 1 \\ x_j^{-1} & 1 - x_j^{-1} \end{bmatrix} \xi^{\text{n}}, \\ \xi^{\text{e}} &= \begin{bmatrix} 0 & 1 \\ x_j & 1 - x_j \end{bmatrix} \xi^{\text{w}}, & \xi^{\text{s}} &= \begin{bmatrix} 0 & 1 \\ x_j & 1 - x_j \end{bmatrix} \xi^{\text{n}}. \end{aligned}$$

For a negative crossing shown in Figure 8, $\xi_\ell = (1 - x_j^{-1})\xi_j + x_j^{-1}\xi_k$, so in case

(a), (b), (c), (d), respectively,

$$\begin{aligned} \xi^e &= \begin{bmatrix} 1 - x_j^{-1} & x_j^{-1} \\ 1 & 0 \end{bmatrix} \xi^w, & \xi^s &= \begin{bmatrix} 1 - x_j & x_j \\ 1 & 0 \end{bmatrix} \xi^n, \\ \xi^e &= \begin{bmatrix} 1 - x_j & x_j \\ 1 & 0 \end{bmatrix} \xi^w, & \xi^s &= \begin{bmatrix} 1 - x_j^{-1} & x_j^{-1} \\ 1 & 0 \end{bmatrix} \xi^n, \\ \xi^e &= \begin{bmatrix} 0 & 1 \\ x_j & 1 - x_j \end{bmatrix} \xi^w, & \xi^s &= \begin{bmatrix} 0 & 1 \\ x_j & 1 - x_j \end{bmatrix} \xi^n, \\ \xi^e &= \begin{bmatrix} 0 & 1 \\ x_j^{-1} & 1 - x_j^{-1} \end{bmatrix} \xi^w, & \xi^s &= \begin{bmatrix} 0 & 1 \\ x_j^{-1} & 1 - x_j^{-1} \end{bmatrix} \xi^n. \end{aligned}$$

Using these repeatedly, we can obtain $\begin{bmatrix} \xi_{y^{(j)}} \\ \xi_{x^{(j)}} \end{bmatrix} = G_{k_j} \begin{bmatrix} \xi_{y^{(j-2)}} \\ \xi_{x^{(j-1)}} \end{bmatrix}$.

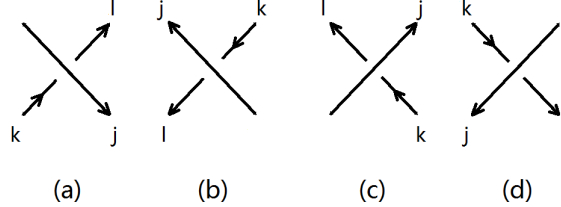

Figure 7: Four possibilities of a positive crossing

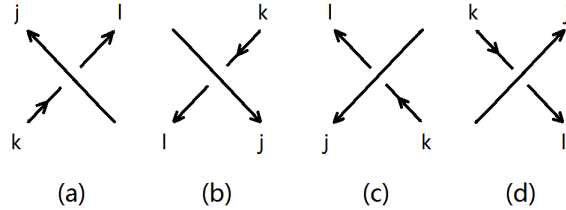

Figure 8: Four possibilities of a negative crossing

□

Example 3.5. Let K be the triple twist knot $N([2h_1], [2h_2], [2h_3 + 1])$ as shown in Figure 9 (a). Apply Lemma 3.4 to compute

$$\begin{aligned} \eta_y &= 1, & \eta_{y_1} &= u_{2h_1}(x, y) = [h_1]_{xy}(x - xy), & \eta_{x_1} &= u_{2h_1-1}(x, y) = w_1 + 1, \\ \begin{bmatrix} \eta_{y_2} \\ \eta_{x_2} \end{bmatrix} &= G_{2h_2}(y, x_1^{-1}) \begin{bmatrix} \eta_y \\ \eta_{x_1} \end{bmatrix} &= \begin{bmatrix} 1 + [h_2]_{yx_1^{-1}}(y - yx_1^{-1})w_1 \\ 1 + (w_2 + 1)w_1 \end{bmatrix}, \\ \begin{bmatrix} \eta_{y_3} \\ \eta_{x_3} \end{bmatrix} &= G_{2h_3+1}(y_1, x_2) \begin{bmatrix} \eta_{y_1} \\ \eta_{x_2} \end{bmatrix} &= \begin{bmatrix} z(w_2w_1 + (xy)^{h_1}) + [h_1]_{xy}(x - xy) \\ \star \end{bmatrix}. \end{aligned}$$

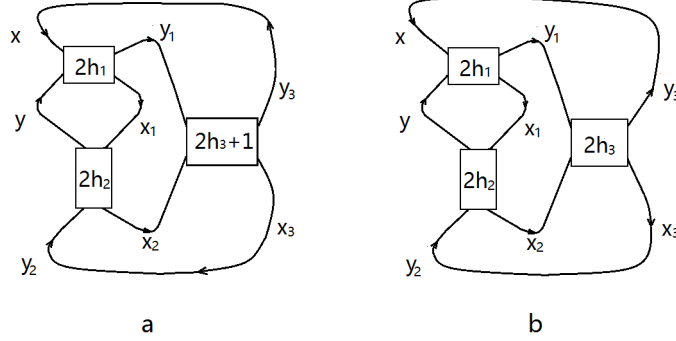

Figure 9: (a) The triple twist knot $N([[2h_1], [2h_2], [2h_3 + 1]])$; (b) The triple twist link $N([[2h_1], [2h_2], [2h_3]])$

where $w_1 = [h_1]_{xy}(x-1)$, $w_2 = [h_2]_{yx_1^{-1}}(y-1)$, $z = [h_3 + 1]_{y_1x_2y_1} - [h_3]_{y_1x_2y_1x_2}$, and \star denotes something irrelevant to us. By (6),

$$\Delta_{L,\rho} \doteq \frac{\det(\bar{\eta}_{y_3})}{\det(1 - \bar{x}^{se})} = \frac{\det(\bar{z}(\bar{w}_2\bar{w}_1 + (\bar{xy})^{h_1}) + [h_1]_{\bar{xy}}(\bar{x} - \bar{xy}))}{\det(1 - \bar{x})} \doteq \frac{\det([h_3 + 1]_{\bar{y}_1\bar{x}_2\bar{y}_1} - [h_3]_{\bar{y}_1\bar{x}_2\bar{y}_1x_2})([h_2]_{\bar{y}x_1^{-1}}(\bar{y} - 1)[h_1]_{\bar{xy}}(\bar{x} - 1) + (\bar{xy})^{h_1}) + [h_1]_{\bar{xy}}(\bar{x} - \bar{xy}))}{\det(1 - \bar{x})}.$$

In particular, setting $\bar{x} = \bar{x}_1 = \bar{x}_2 = \bar{y} = \bar{y}_1 = t$, we obtain the ordinary Alexander polynomial (referring to (2)):

$$\Delta_K \doteq ([h_3 + 1]_{t^2} - t[h_3]_{t^2})(h_2(t-1)^2[h_1]_{t^2} + t^{2h_1}) + (1-t)[h_1]_{t^2}.$$

As a special case, $N([2], [2], [3])$ (with $h_1 = h_2 = h_3 = 1$) is the knot 7_5 , so

$$\Delta_{7_5,\rho} \doteq \frac{\det(\bar{y}_1(1 + \bar{x}_2\bar{y}_1 - \bar{x}_2)(1 - \bar{x} - \bar{y} + \bar{y}\bar{x} + \bar{x}\bar{y}) + \bar{x}(1 - \bar{y}))}{\det(1 - \bar{x})}. \quad (7)$$

In particular, the ordinary Alexander polynomial

$$\Delta_{7_5} \doteq 2t^4 - 4t^3 + 5t^2 - 4t + 2.$$

It is easy to see that

$$\pi(7_5) = \langle x, y \mid (x_2y_1)^2 = yx_2y_1x_2 \rangle, \quad \text{with } y_1 = (xy).x, \quad x_2 = (yx).y.$$

Due to $\Delta_{7_5}(2) \equiv 0 \pmod{7}$, there are homomorphisms

$$\tau_{\pm} : \pi(7_5) \rightarrow \mathbb{Z}_7 \rtimes_2 \mathbb{Z}_3 = \langle \alpha, \beta \mid \alpha^7 = \beta^3 = 1, \beta\alpha = \alpha^2\beta \rangle$$

sending x to $\beta^{\pm 1}$ and y to $\alpha\beta^{\pm 1}$. Let $\zeta = e^{2\pi i/7}$, and let $\psi : \mathbb{Z}_7 \rtimes_2 \mathbb{Z}_3 \rightarrow \text{SL}(3, \mathbb{C})$ denote the representation sending α, β to A, B , respectively, where

$$A = \begin{bmatrix} \zeta & 0 & 0 \\ 0 & \zeta^2 & 0 \\ 0 & 0 & \zeta^4 \end{bmatrix}, \quad B = \begin{bmatrix} 0 & 1 & 0 \\ 0 & 0 & 1 \\ 1 & 0 & 0 \end{bmatrix}.$$

Let $\rho_{\pm}^{7_5} : \pi(7_5) \rightarrow \text{SL}(3, \mathbb{C})$ be the composite $\psi \circ \tau_{\pm}$. We can compute $\overline{y_1} = tA^{\mp 2}B^{\pm 1}$, $\overline{x_2} = tA^{1 \pm 2}B^{\pm 1}$, and then by (7),

$$\Delta_{\tau_5, \rho_{\pm}^{7_5}} \doteq t^9 - 5t^6 + 5t^3 - 1. \quad (8)$$

Example 3.6. Let L be the triple twist link $N([[2h_1], [2h_2], [2h_3]])$ as shown in Figure 9 (b). Similarly as in the previous Example,

$$\Delta_{L, \rho} \doteq \frac{\det([h_3]_{\overline{y_1 x_2}}(\overline{y_1} - \overline{y_1 x_2})(\overline{w_2 w_1} + (\overline{xy})^{h_1}) + [h_1]_{\overline{xy}}(\overline{x} - \overline{xy}))}{\det(1 - \overline{x_3})} \doteq \frac{\det([h_3]_{\overline{y_1 x_2}}(\overline{y_1} - \overline{y_1 x_2})([h_2]_{\overline{y x_1^{-1}}}(\overline{y} - 1)[h_1]_{\overline{xy}}(\overline{x} - 1) + (\overline{xy})^{h_1}) + [h_1]_{\overline{xy}}(\overline{x} - \overline{xy}))}{\det(1 - \overline{y})}.$$

The multi-variable Alexander polynomial can be easily found by setting $\overline{x} = \overline{y_1} = t_1$ and $\overline{y} = \overline{x_1} = \overline{x_2} = t_2$:

$$\Delta_L \doteq [h_1]_{t_1 t_2} [h_3]_{t_1 t_2} (h_2(t_1 - 1)(t_2 - 1) + t_1 t_2 - 1) + [h_1]_{t_1 t_2} + [h_3]_{t_1 t_2}.$$

3.2 Computing TAP for Montesinos links

Suppose $L = D(T)$, $T = T_1 * \dots * T_s$, ($s \geq 2$), where each T_k is a rational tangle. Let m_k be the number of crossings in T_k , and let $m = m_1 + \dots + m_s$.

For each k , set up Q_{T_k} similarly as in the previous subsection, and introduce b_k^{ne} , etc. Apply the map (1) to everything. To conveniently talk about row-transformations on $\overline{Q_{T_k}}$, we introduce the variables $\overline{\xi}_{k,j}$ and $\overline{\xi}_k^{\text{ne}}$, etc; in particular, $\overline{\xi}_{k,1} = \overline{\xi}_k^{\text{nw}}$.

Suppose $\overline{b_1^{\text{ne}}}, \dots, \overline{b_s^{\text{ne}}}$ are all invertible. Re-write

$$\overline{\xi}_k^{\text{ne}} = (1 - \overline{b_k^{\text{ne}}})\overline{\xi}_{k,1} + \overline{b_k^{\text{ne}}}\overline{\xi}_{k,2} = (1 - \overline{b_k^{\text{ne}}})\overline{\xi}_k^{\text{nw}} + \overline{b_k^{\text{ne}}}\overline{\xi}_{k,2}$$

as

$$\overline{\xi}_{k,2} = (1 - \overline{b_k^{\text{ne}}})^{-1}\overline{\xi}_k^{\text{nw}} + \overline{b_k^{\text{ne}}})^{-1}\overline{\xi}_k^{\text{ne}}. \quad (9)$$

Substituting $\overline{\xi}_{k,2}$ everywhere, we can write each $\overline{\xi}_{k,j}$ as a linear combination of $\overline{\xi}_k^{\text{nw}}$ and $\overline{\xi}_k^{\text{ne}}$; in particular,

$$\begin{bmatrix} \overline{\xi}_k^{\text{sw}} \\ \overline{\xi}_k^{\text{se}} \\ \overline{\xi}_k \end{bmatrix} = \begin{bmatrix} 1 - \overline{b_k^{\text{sw}} b_k^{\text{ne}}})^{-1} & \overline{b_k^{\text{sw}} b_k^{\text{ne}}})^{-1} \\ 1 - \overline{b_k^{\text{se}} b_k^{\text{ne}}})^{-1} & \overline{b_k^{\text{se}} b_k^{\text{ne}}})^{-1} \end{bmatrix} \begin{bmatrix} \overline{\xi}_k^{\text{nw}} \\ \overline{\xi}_k^{\text{ne}} \end{bmatrix}.$$

The effect on $\overline{Q_{T_k}}$ is to multiply some $\overline{U}_k \in \text{GL}(m_k, \mathcal{M}(d, R[\mathbf{t}^{\pm}]))$ on the left. Note that $\det(\overline{U}_k) \doteq \det(\overline{b_k^{\text{ne}}})^{-1}$, as we have multiplied $\overline{b_k^{\text{ne}}})^{-1}$ to derive (9).

Since $\overline{\xi}_k^{\text{nw}} = \overline{\xi}_{k-1}^{\text{sw}}$ and $\overline{\xi}_k^{\text{ne}} = \overline{\xi}_{k-1}^{\text{se}}$ for $k = 2, \dots, s$, by further substituting, we can re-write each $\overline{\xi}_{k,j}$ as a linear combination of $\overline{\xi}_1^{\text{nw}}$ and $\overline{\xi}_1^{\text{ne}}$. Hence there exist

$\bar{U} \in \text{GL}(m, \mathcal{M}(d, R[\mathbf{t}^\pm]))$ with $\det(\bar{U}) \doteq \prod_{k=1}^s \det(\bar{b}_k^{\text{ne}})^{-1}$ and $\bar{V} \in \text{GL}(m+2, \mathbb{Z})$ which represents switching the columns corresponding to $\alpha_{1,2}$ and α_1^{ne} , such that

$$\overline{UQ_TV} = \begin{pmatrix} \star & -I(m-2) & \\ B & & -I(2) \end{pmatrix};$$

the last two rows respectively express $\bar{\xi}_s^{\text{sw}}$ and $\bar{\xi}_s^{\text{se}}$ as a linear combination of $\bar{\xi}_1^{\text{nw}}$ and $\bar{\xi}_1^{\text{ne}}$, i.e., $\begin{bmatrix} \bar{\xi}_s^{\text{sw}} \\ \bar{\xi}_s^{\text{se}} \end{bmatrix} = B \begin{bmatrix} \bar{\xi}_1^{\text{nw}} \\ \bar{\xi}_1^{\text{ne}} \end{bmatrix}$, so that

$$B = \begin{bmatrix} 1 - \bar{b}_s^{\text{sw}} \bar{b}_s^{\text{ne}-1} & \bar{b}_s^{\text{sw}} \bar{b}_s^{\text{ne}-1} \\ 1 - \bar{b}_s^{\text{se}} \bar{b}_s^{\text{ne}-1} & \bar{b}_s^{\text{se}} \bar{b}_s^{\text{ne}-1} \end{bmatrix} \cdots \begin{bmatrix} 1 - \bar{b}_1^{\text{sw}} \bar{b}_1^{\text{ne}-1} & \bar{b}_1^{\text{sw}} \bar{b}_1^{\text{ne}-1} \\ 1 - \bar{b}_1^{\text{se}} \bar{b}_1^{\text{ne}-1} & \bar{b}_1^{\text{se}} \bar{b}_1^{\text{ne}-1} \end{bmatrix} = \begin{bmatrix} 1 - \bar{c} & \bar{c} \\ \star & \star \end{bmatrix},$$

where $\bar{c} = \bar{p}_1 + \bar{p}_2 \bar{q}_1 + \cdots + \bar{p}_s \bar{q}_{s-1} \cdots \bar{q}_1$, and

$$\bar{p}_k = \bar{b}_k^{\text{sw}} \bar{b}_k^{\text{ne}-1}, \quad \bar{q}_k = (\bar{b}_k^{\text{se}} - \bar{b}_k^{\text{sw}}) \bar{b}_k^{\text{ne}-1}.$$

Equating $\bar{\xi}_s^{\text{sw}}$ with $\bar{\xi}_1^{\text{nw}}$, similarly as done when deriving (5), we deduce

$$\det(\overline{Q_{-m}^{-1}}) \doteq \det(\bar{c}) \cdot \prod_{k=1}^s \det(\bar{b}_k^{\text{ne}}). \quad (10)$$

Hence

$$\Delta_{L,\rho} \doteq \frac{\prod_{k=1}^s \det(\bar{b}_k^{\text{ne}})}{\det(1 - x^{\text{se}})} \det(\bar{p}_1 + \bar{p}_2 \bar{q}_1 + \cdots + \bar{p}_s \bar{q}_{s-1} \cdots \bar{q}_1). \quad (11)$$

In particular, when $s = 3$,

$$\Delta_{L,\rho} \doteq \frac{\det(\bar{b}_2^{\text{ne}}) \det(\bar{b}_3^{\text{ne}})}{\det(1 - x^{\text{se}})} \det \left(\bar{b}_1^{\text{sw}} + (\bar{b}_2^{\text{sw}} + \bar{b}_3^{\text{sw}} \bar{b}_3^{\text{ne}-1} (\bar{b}_2^{\text{se}} - \bar{b}_2^{\text{sw}})) \bar{b}_2^{\text{ne}-1} (\bar{b}_1^{\text{se}} - \bar{b}_1^{\text{sw}}) \right). \quad (12)$$

Remark 3.7. Note that $D(T_1 * \cdots * T_s)$ is not changed when T_1, \dots, T_s are cyclically permuted, so the sub-indices in (11), (12) can be cyclically permuted.

In particular, if $b_i^{\text{sw}} = 1$ for some $i \in \{1, 2, 3\}$, then with cyclical notation, (12) is simplified to

$$\Delta_{L,\rho} \doteq \frac{\det(\bar{b}_{i-1}^{\text{ne}})}{\det(1 - x^{\text{se}})} \det \left(\bar{b}_{i+1}^{\text{ne}} + (\bar{b}_i^{\text{se}} - 1) (\bar{b}_{i+1}^{\text{sw}} + \bar{b}_{i-1}^{\text{sw}} \bar{b}_{i-1}^{\text{ne}-1} (\bar{b}_{i+1}^{\text{se}} - \bar{b}_{i+1}^{\text{sw}})) \right). \quad (13)$$

This will be used frequently in the following examples.

To deal with the “degenerate” case when \bar{b}_k^{ne} is not invertible for some k , we may imitate the physical “regularization” by introducing auxiliary variables ϵ_k that commute with everything. Replace \bar{b}_k^{ne} by $\bar{b}_k^{\text{ne}} + \epsilon_k$, and proceed as above, we can obtain an equation like (10), which is now an equation between polynomials in $\epsilon_1, \dots, \epsilon_n$. Setting $\epsilon_1 = \cdots = \epsilon_n = 0$ and dividing by $\det(1 - x_{\bar{m}})$ results in an expression for $\Delta_{L,\rho}$.

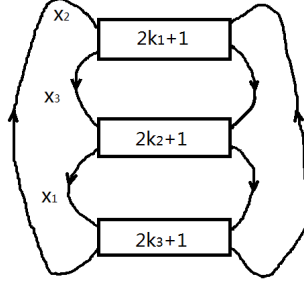

Figure 10: The pretzel knot $P(2k_1 + 1, 2k_2 + 1, 2k_3 + 1)$

Remark 3.8. We believe that each $\overline{b_k^{\text{ne}}}$ is always invertible, but temporarily cannot prove this.

Example 3.9. Let $K = P(2k_1 + 1, 2k_2 + 1, 2k_3 + 1)$. It is easy to see that

$$b_1^{\text{se}} = u_{2k_1}(x_2, x_3^{-1}), \quad b_2^{\text{se}} = u_{2k_2}(x_3, x_1^{-1}), \quad b_3^{\text{ne}} = u_{2k_2+1}(x_3, x_1^{-1}),$$

and $b_i^{\text{sw}} = 1$, $i = 1, 2, 3$. Let

$$z_i = [k_i]_{x_{i+1}x_{i-1}^{-1}} x_{i+1}(1 - x_{i-1}^{-1}) - 1, \quad w_i = [k_i + 1]_{x_{i+1}x_{i-1}^{-1}}(x_{i+1} - 1) + 1.$$

Then by (13),

$$\Delta_{K,\rho} \doteq \frac{\det(\overline{w_3})}{\det(1 - \overline{x_1})} \det(\overline{w_2} + \overline{z_1}(1 + \overline{w_3}^{-1}\overline{z_2})). \quad (14)$$

In particular, the ordinary Alexander polynomial is

$$\Delta_K \doteq 1 + (1 + k_1 + k_2 + k_3 + k_1k_2 + k_2k_3 + k_1k_3)(t + t^{-1} - 2).$$

Consider the case $k_1 = k_2 = k_3 = 1$. Then

$$\overline{z_1} = t\rho(x_2) - \rho(x_2x_3^{-1}) - 1, \quad (15)$$

$$\overline{z_2} = t\rho(x_3) + t\rho(x_3x_1^{-1}) - 1, \quad (16)$$

$$\overline{w_2} = t\rho(x_3) + t\rho(x_3x_1^{-1}x_3) + \rho(x_3x_1^{-1}), \quad (17)$$

$$\overline{w_3} = t\rho(x_1) + t\rho(x_1x_2^{-1}x_1) - \rho(x_1x_2^{-1}). \quad (18)$$

The results of [4] enable us to easily construct irreducible 2-dimensional representations of $\pi(K)$. For instance, the assignment

$$x_1 \mapsto \begin{bmatrix} 1 & 1 \\ 0 & 1 \end{bmatrix}, \quad x_2 \mapsto \begin{bmatrix} 1 & 0 \\ -3 & 1 \end{bmatrix}, \quad x_3 \mapsto \begin{bmatrix} 2 & 1 \\ -1 & 0 \end{bmatrix}$$

defines a representation $\rho : \pi(K) \rightarrow \text{SL}(2, \mathbb{F}_{11})$, as can be checked using (16)–(18) of [4]. By (14) and (15)–(18), we can compute

$$\Delta_{P(3,3,3),\rho} \doteq \frac{(t+2)(t+4)(t^2+3t-2)}{(t-1)^2} \in \mathbb{F}_{11}(t).$$

Example 3.10. Consider $M(-2, 5/2, 2k+1)$ with $k \geq 5$. This family of knots is interesting, in that it forms the final piece to be completed in the problem of exceptional surgery on arborescent knots (see [15]).

For a fixed k , write $K := M(-2, 5/2, 2k+1) = D(T_1 * T_2 * T_3)$, with $T_1 = [-2]$, $T_2 = [5/2]$, $T_3 = [2k+1]$.

Clearly,

$$b_1^{\text{sw}} = 1, \quad b_1^{\text{se}} = [-1]_{x^{-1}y^{-1}}(x^{-1} - 1) + 1 = yx - y + 1, \quad (19)$$

$$b_3^{\text{sw}} = 1, \quad b_3^{\text{ne}} = [k+1]_{y'x}y' - [k]_{y'x}y'x. \quad (20)$$

For $T_2 = [[2], [2]]$,

$$\begin{aligned} \eta_{y^{(0)}} &= 1, & \eta_{y^{(1)}} &= u_2(y^{-1}, z') = y^{-1}(1 - z'), & \eta_{x^{(1)}} &= u_1(y^{-1}, z') = y^{-1}, \\ \begin{bmatrix} \eta_{y^{(2)}} \\ \eta_{x^{(2)}} \end{bmatrix} &= G_2(z', z^{-1}) \begin{bmatrix} \eta_{y^{(0)}} \\ \eta_{x^{(1)}} \end{bmatrix} = \begin{bmatrix} 1 - z' + z'z^{-1} & z' - z'z^{-1} \\ 1 - z' & z' \end{bmatrix} \begin{bmatrix} 1 \\ y^{-1} \end{bmatrix} \\ &= \begin{bmatrix} y \cdot (1 - z + (y')^{-1}y + zy^{-1} - (y')^{-1}) \\ 1 - y \cdot z + yzy^{-2} \end{bmatrix}, \end{aligned}$$

where we have used $z' = y \cdot z$ and $y' = z \cdot y$. Hence

$$b_2^{\text{sw}} = y^{-1}(1 - z') = (1 - z)y^{-1}, \quad b_2^{\text{se}} = 1 - y \cdot z + yzy^{-2}, \quad (21)$$

$$b_2^{\text{ne}} = y \cdot (1 - z + (y')^{-1}y + zy^{-1} - (y')^{-1}). \quad (22)$$

Then, noticing $\det(\overline{b_1^{\text{se}}} - 1) \doteq \det(1 - \overline{x})$ and plugging in (19), (20), (21), (22), we obtain $\Delta_{K, \rho}$ via (13):

$$\begin{aligned} \Delta_{K, \rho} &\doteq \det \left(([k+1]_{\overline{y'x}\overline{y'}} - [k]_{\overline{y'x}\overline{y'x}}) ((\overline{x} - 1)^{-1}(1 + \overline{y'}^{-1}\overline{y} - \overline{y'}^{-1} - \overline{z} + \overline{z}\overline{y}^{-1}) + 1 - \overline{z}) \right. \\ &\quad \left. + \overline{y} - \overline{y}\overline{z} + \overline{y} \cdot \overline{z} + \overline{z} - 1 \right). \end{aligned} \quad (23)$$

Specializing ρ to the trivial representation ρ_0 , so that $\overline{x} = \overline{y} = \overline{z} = \overline{y'} = t$, we find the ordinary Alexander polynomial:

$$\Delta_K \doteq (t-1)\Delta_{K, \rho_0} \doteq (t^3 - t^2 - 2t + 1)[2k+1]_{-t} + (t-1)(t^2 - 3t + 1).$$

For variousness, let us consider *trace-free* $\text{SU}(2)$ -representations, which by definition are those sending meridians to matrices with vanishing traces. Such representations were classified up to conjugacy by the author in [3]. Take arbitrary integers n_1, n_2, n_3, n , and put

$$\begin{aligned} \theta &= \frac{10(2k+1)\pi}{9-2k} \left(2n+3 - \frac{2n_1+1}{-2} - \frac{4n_2+1}{5} - \frac{2n_3+1}{2k+1} \right), \\ \theta_1 &= \frac{\theta + (2n_1+1)\pi}{-2}, \quad \theta_2 = -\frac{\theta + (2n_2+3)\pi}{5}, \quad \theta_3 = \frac{2(k-n_3)\pi - \theta}{2k+1}, \end{aligned}$$

then we can construct a trace-free representation $\rho : \pi(K) \rightarrow \text{SU}(2)$ such that

$$\rho(x) = J, \quad \rho(y) = R_{\theta_1}J, \quad \rho(y') = -R_{\theta_3}J, \quad \rho(z) = R_{\theta_1 - \theta_2}J,$$

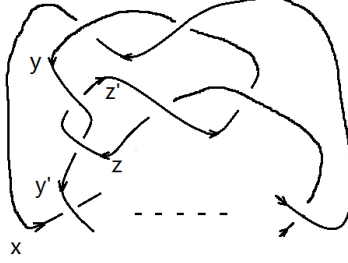

Figure 11: The knot $M(-2, 5/2, 2k+1)$

where

$$J = \begin{bmatrix} i & 0 \\ 0 & -i \end{bmatrix}, \quad R_\alpha = \begin{bmatrix} \cos \alpha & -\sin \alpha \\ \sin \alpha & \cos \alpha \end{bmatrix}.$$

One can directly verify that this assignment indeed defines a representation.

Abbreviate R_{θ_i} to R_i . Using the property $JR_\alpha = R_{-\alpha}J$, we easily obtain

$$\begin{aligned} [k+1]_{\overline{y'x}y'} - [k]_{\overline{y'x}y'} &= -\sum_{j=0}^k t^{2j+1} R_3^{j+1} J - \sum_{j=1}^k t^{2j} R_3^j, \\ \overline{y} - \overline{y}z + \overline{y}.\overline{z} + \overline{z} - 1 &= t^2 R_2 - I + t(1 + 2 \cos \theta_2) R_1 J, \\ (\overline{x} - 1)^{-1} (1 + \overline{y'}^{-1} \overline{y} - \overline{y'}^{-1} - \overline{z}) + 1 - \overline{z} &= \frac{-1}{t^2 + 1} (R_2^{-1} + R_3^{-1} - t^2 I + t^2 R_2 R_1^{-1} \\ &\quad - R_3 R_1^{-1} + (t^3 R_1 R_2^{-1} - t^{-1} R_3 + tI - t R_1 R_3^{-1} + t R_2) J). \end{aligned}$$

With a few more efforts, $\Delta_{K,\rho}$ can be found by (23) to be the determinant of

$$\begin{aligned} R_2 - \frac{t^{2k}}{t^2 + 1} R_3^k (I - t^2 R_2^{-1} + (1 + 2 \cos \theta_2) R_3 R_2^{-1}) + \frac{1}{t} \left((1 + 2 \cos \theta_2) R_1 + R_3 R_2 \right. \\ \left. - \sum_{j=0}^k t^{2j} R_3^j R_1 - \frac{t^{2k+2}}{t^2 + 1} R_3^{k+2} (R_2 - t^{-2} I + (1 + 2 \cos \theta_2) R_3^{-1} R_2) \right) J, \end{aligned}$$

which is a little long, so we choose not to write it down.

Example 3.11. Let $K = M(7/3, 2, 7/2)$, which is the mirror of 12a_0423 in the knot table. Write $K = D(T_1 * T_2 * T_3)$, with $T_1 = [[3], [2]]$, $T_2 = [2]$, $T_3 = [[2], [3]]$. Use x, y, z to express other elements:

$$x' = z^{-1}.x, \quad y' = (xy^{-1}x).y, \quad z' = (xz)^{-1}.z, \quad w = (xy^{-1}).x.$$

Computing routinely,

$$\begin{aligned}
b_1^{\text{sw}} &= u_3(x, y^{-1}) = x(1 + y^{-1}x - y^{-1}), \\
\begin{bmatrix} b_1^{\text{ne}} \\ b_1^{\text{se}} \end{bmatrix} &= G_2(y^{-1}, w^{-1}) \begin{bmatrix} 1 \\ u_2(x, y^{-1}) \end{bmatrix} = \begin{bmatrix} 1 + y^{-1}(1 - w^{-1})(x - xy^{-1} - 1) \\ \star \end{bmatrix}, \\
b_2^{\text{se}} &= y', \\
b_3^{\text{sw}} &= u_2(x', z') = x'(1 - z'), \\
\begin{bmatrix} b_3^{\text{ne}} \\ b_3^{\text{se}} \end{bmatrix} &= G_3(z', z^{-1}) \begin{bmatrix} 1 \\ x' \end{bmatrix} = \begin{bmatrix} 1 + z'(1 + z^{-1}z' - z^{-1})(x' - 1) \\ 1 + z'(1 - z^{-1})(x' - 1) \end{bmatrix}.
\end{aligned}$$

Then $\Delta_{K, \rho}$ can be obtained via (13) by plugging in these.

Specialized to $\rho = \rho_0$,

$$\overline{b_1^{\text{sw}}} = 2t - 1, \quad \overline{b_2^{\text{se}}} = t, \quad \overline{b_3^{\text{sw}}} = t - t^2, \quad t^2 \overline{b_1^{\text{ne}}} = \overline{b_3^{\text{ne}}} = \overline{b_3^{\text{se}}} - \overline{b_3^{\text{sw}}} = 2t^2 - 3t + 2,$$

leading us to the ordinary Alexander polynomial

$$\Delta_K \doteq (2t^2 - 3t + 2)(2t^4 - 4t^3 + 5t^2 - 4t + 2) \doteq (2t^2 - 3t + 2)\Delta_{7_5}.$$

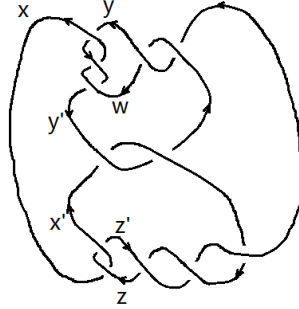

Figure 12: The knot $M(7/3, 2, 7/2)$

Similarly as Example 3.5, we can consider representations $\pi(K) \rightarrow \mathbb{Z}_7 \rtimes_2 \mathbb{Z}_3$. The relations of $\pi(K)$ are

$$(wy)^{-1}.y = (z'z^{-1}).z', \quad y^{-1}.w = (y'x').y',$$

from which it follows that $x \mapsto \beta$, $y \mapsto \alpha^a \beta$, $z \mapsto \alpha^b \beta$ defines a nonabelian representation $\pi(K) \rightarrow \mathbb{Z}_7 \rtimes_2 \mathbb{Z}_3$ if and only if $b \equiv a \not\equiv 0 \pmod{7}$. Let $\rho_a^K : \pi(K) \rightarrow \text{SL}(3, \mathbb{C})$ denote the composite of this representation with ψ (given in Example 3.5). With the help of Mathematica, we compute

$$\begin{aligned}
\Delta_{K, \rho_a^K} \doteq & \frac{1}{t^3 - 1} \left(t^{18} - (2\zeta^{5a} + 3\zeta^{4a} + \zeta^{3a} + 4\zeta^{2a} + 3\zeta^a + 5)t^{15} + (11\zeta^{5a} + 2\zeta^{4a} \right. \\
& + 10\zeta^{3a} + 10\zeta^{2a} + 7\zeta^a + 8)t^{12} - (4\zeta^{5a} + 3\zeta^{4a} + 8\zeta^{3a} + 6\zeta^{2a} - \zeta^a)t^9 - \\
& \left. (4\zeta^{5a} + \zeta^{3a} + 5\zeta^{2a} + 3\zeta^a + 9)t^6 + (\zeta^{5a} + 2\zeta^{3a} + 3\zeta^{2a} + 2\zeta^a + 2)t^3 + 1 \right).
\end{aligned}$$

Assume there exists an epimorphism $\phi : \pi(K) \twoheadrightarrow \pi(7_5)$. Then either $\rho_+^{7_5} \circ \phi$ or $\rho_-^{7_5} \circ \phi$ is conjugate to ρ_a^K for some a . However, compared with (8) we see that $\Delta_{7_5, \rho_{\pm}^{7_5}} \nmid \Delta_{K, \rho_a^K}$. Thus there does not exist an epimorphism $\pi(K) \twoheadrightarrow \pi(7_5)$.

References

- [1] A. Aso, *Twisted Alexander polynomials of $(-2, 3, 2n + 1)$ -pretzel knots*. arXiv: 1803.06470.
- [2] M. Boileau, S. Boyer, D. Rolfsen, S.-C. Wang, *1-dominance of knots*. arXiv:1511.07073.
- [3] H.-M. Chen, *Trace-free $SL(2, \mathbb{C})$ -representations of Montesinos links*. J. Knot Theor. Ramif. 27 (2018), no. 8, 1850050 (10 pages).
- [4] H.-M. Chen, *Character varieties of odd classical pretzel knots*. Int. J. Math. 29 (2018), no. 9, 1850060 (15 pages).
- [5] R.H. Crowell, R. Fox, *Introduction to knot theory*. Graduate Texts in Mathematics 57, Springer-Verlag, New York, Heidelberg, Berlin, 1977.
- [6] J. Dubois, S. Friedl, W. Lück, *Three flavors of twisted invariants of knots*. arXiv:1410.6924.
- [7] R.H. Fox, J.W. Milnor, *Singularities of 2-spheres in 4-space and cobordism of knots*. Osaka J. Math. 3 (1966), 257–267.
- [8] S. Friedl, S. Vidussi, *Nontrivial Alexander polynomials of knots and links*. Bull. Lond. Math. Soc. 39 (2007), 614–622.
- [9] S. Friedl, S. Vidussi, *A survey of twisted Alexander polynomials*. Proceedings of the conference ‘The mathematics of knots: theory and application’, Heidelberg, December, 2008.
- [10] S. Friedl, S. Vidussi, *Twisted Alexander polynomials detect fibered 3-manifolds*. Ann. Math. 173 (2011), 1587–1643.
- [11] H. Goda, *Twisted Alexander invariants and hyperbolic volume*. arXiv: 1604.07490.
- [12] C. Herald, P. Kirk, C. Livingston, *Metabelian representations, twisted Alexander polynomials, knot slicing, and mutation*. Math. Z. 265 (2010), no. 4, 925–949.
- [13] J.A. Hillman, C. Livingston, S. Naik, *Twisted Alexander polynomials of periodic knots*. Algebr. Geom. Topol. 6 (2006), 145–169.
- [14] J. Hoste, P.D. Shanahan, *Twisted Alexander polynomials of 2-bridge knots*. J. Knot Theor. Ramif. 22 (2013), no. 1, 1250138 (29 pages).

- [15] K. Ichihara, H. Masai, *Exceptional surgeries on alternating knots*. arXiv: 1310.3472.
- [16] W.B.R. Lickorish, *An introduction to knot theory*. Graduate Texts in Mathematics Vol. 175, Springer-Verlag New York Berlin Heidelberg, 1997.
- [17] P. Kirk, C. Livingston, *Twisted knot polynomials: inversion, mutation and concordance*. *Topology* 38 (1999), no. 3, 663–671.
- [18] T. Kitano, T. Morifuji, *Divisibility of twisted Alexander polynomials and fibered knots*. *Ann. Scuola Norm. Sup. Pisa Cl. Sci. (5)* 4 (2005), 179–186.
- [19] T. Kitano, M. Suzuki, M. Wada, *Twisted Alexander polynomials and surjectivity of a group homomorphism*. *Algebr. Geom. Topol.* 5 (2005), 1315–1324.
- [20] X.-S. Lin, *Representations of knot groups and twisted Alexander polynomials*. *Acta Math. Sin (Engl. Ser.)* 17 (2001), 361–380.
- [21] T. Morifuji, *Twisted Alexander polynomials of twist knots for nonabelian representations*. *Bull. Sci. Math.* 132 (2008), 439–453.
- [22] T. Morifuji, A.T. Tran, *Twisted Alexander polynomial of 2-bridge knots for parabolic representations*. *Pacific J. Math.* 269 (2014), no. 2, 433–451.
- [23] T. Morifuji, A.T. Tran, *Twisted Alexander polynomials of hyperbolic links*. *Publ. Res. Inst. Math. Sci.* 53 (2017), no. 3, 395–418.
- [24] A. Stoimenow, *Realizing Alexander polynomials by hyperbolic links*. *Expo. Math.* 28 (2010), 133–178.
- [25] D.S. Silver, S.G. Williams, *Twisted Alexander invariants of twisted links*. *J. Knot Theor. Ramif.* 21 (2012), no. 11, 1250118 (17 pages).
- [26] A.T. Tran, *Twisted Alexander polynomials with the adjoint action for some classes of knots*. *J. Knot Theor. Ramif.* 23 (2014), no. 10, 1450051 (10 pages).
- [27] A.T. Tran, Y. Yamaguchi, *Higher dimensional twisted Alexander polynomials for metabelian representations*. *Topology Appl.* 229 (2017), 42–54.
- [28] M. Wada, *Twisted Alexander polynomial for finitely presentable groups*. *Topology* 33 (1994), no. 2, 241–256.