

2-ASSOCIAHEDRA

NATHANIEL BOTTMAN

ABSTRACT. For any $r \geq 1$ and $\mathbf{n} \in \mathbb{Z}_{\geq 0}^r \setminus \{\mathbf{0}\}$ we construct a poset $W_{\mathbf{n}}$ called a *2-associahedron*. The 2-associahedra arose in symplectic geometry, where they are expected to control maps between Fukaya categories of different symplectic manifolds. We prove that the completion $\widehat{W}_{\mathbf{n}}$ is an abstract polytope of dimension $|\mathbf{n}| + r - 3$. There are forgetful maps $W_{\mathbf{n}} \rightarrow K_r$, where K_r is the $(r - 2)$ -dimensional associahedron, and the 2-associahedra specialize to the associahedra (in two ways) and to the multiplihedra. In an appendix, we work out the 2- and 3-dimensional associahedra in detail.

CONTENTS

1.	Introduction	1
2.	The definition of K_r and some basic properties	6
3.	Construction of the 2-associahedra $W_{\mathbf{n}}$	13
4.	$\widehat{W}_{\mathbf{n}}$ is an abstract polytope	24
	Appendix A. 2- and 3-dimensional 2-associahedra	32
	References	40

1. INTRODUCTION

Ma'u–Wehrheim–Woodward proposed in [MWW] that a Lagrangian correspondence $M_1 \xrightarrow{L_{12}} M_2$ between symplectic manifolds should induce an A_{∞} -functor $\mathrm{Fuk}(M_1) \xrightarrow{\Phi(L_{12})} \mathrm{Fuk}(M_2)$ between Fukaya categories, where $\Phi(L_{12})$ is defined by counting pseudoholomorphic quilted disks. In his thesis [B2], the author suggested extending this proposal by counting witch balls, which are pseudoholomorphic quilted spheres. The underlying domain moduli spaces (described in §1.1) are stratified topological spaces, and the poset indexing the strata has interesting combinatorial structure, similarly to how the Stasheff polytopes have strata indexed by posets of rooted ribbon trees, i.e. the associahedra. In this paper we define this underlying poset, which we call a *2-associahedron*.

In §3 we give two equivalent definitions of the 2-associahedra $W_{\mathbf{n}}$, for $r \geq 1$ and $\mathbf{n} \in \mathbb{Z}_{\geq 0}^r \setminus \{\mathbf{0}\}$: in the first, the elements are *stable tree-pairs* $T_b \xrightarrow{f} T_s$, where T_b is a rooted ribbon tree with alternating dashed and solid edges and T_s is a rooted ribbon tree; in the second, the elements are *2-bracketings*. 2-bracketings are similar to ordinary bracketings (here called *1-bracketings*) of $1\ 2 \cdots r$, which index the associahedron K_r . Pictorially, a 2-bracketing takes the following form: place the numbers $1\ 2 \cdots r$ on the bottom row, and above i place n_i letters in a vertical column. Bracket $1\ 2 \cdots r$, then bracket the letters according to the rules recorded in Def. 3.9. (Examples of 2-bracketings are shown in Fig. 1 and in the extensive collection of examples in §A.) We formulate the equivalence of these definitions in our first theorem:

Theorem 1.1. *For any $r \geq 1$ and $\mathbf{n} \in \mathbb{Z}_{\geq 0}^r \setminus \{\mathbf{0}\}$, $W_{\mathbf{n}}^{\mathrm{tree}}$ and $W_{\mathbf{n}}^{\mathrm{br}}$ are isomorphic posets.*

SCHOOL OF MATHEMATICS, INSTITUTE FOR ADVANCED STUDY, 1 EINSTEIN DR, PRINCETON, NJ 08540
E-mail address: nbottman@math.ias.edu.

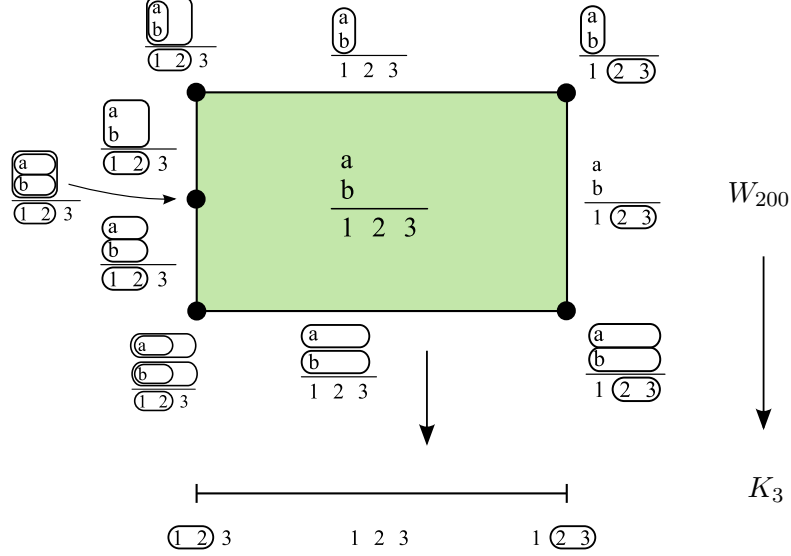

FIGURE 1. In the 2-bracketing model, the forgetful map $\pi: W_{200} \rightarrow K_3$ remembers only the underlying 1-bracketing.

An important link between the 2-associahedra and associahedra is given by a forgetful map $W_{\mathbf{n}} \rightarrow K_r$, which can be defined very easily in terms of the 2-bracketing definition of 2-associahedra: simply forget everything about a given 2-bracketing except for the underlying 1-bracketing of $1\ 2 \cdots r$. In Fig. 1, an example of this forgetful map is shown.

The following theorem collects the main features of the 2-associahedra.

Theorem 1.2. *For any $r \geq 1$ and $\mathbf{n} \in \mathbb{Z}_{\geq 0}^r \setminus \{\mathbf{0}\}$, the 2-associahedron $W_{\mathbf{n}}$ is a poset, the collection of which satisfies the following properties:*

(ABSTRACT POLYTOPE) *For $\mathbf{n} \neq (1)$, $\widehat{W}_{\mathbf{n}} := W_{\mathbf{n}} \cup \{F_{-1}\}$ is an abstract polytope of dimension $|\mathbf{n}| + r - 3$.*

(FORGETFUL) *$W_{\mathbf{n}}$ is equipped with forgetful maps $\pi: W_{\mathbf{n}} \rightarrow K_r$, which are surjective maps of posets.*

(RECURSIVE) *For any stable tree-pair $2T = T_b \xrightarrow{f} T_s \in W_{\mathbf{n}}^{\text{tree}}$, there is an inclusion of posets*

$$(1) \quad \Gamma_{2T}: \prod_{\substack{\alpha \in V_{\text{comp}}^1(T_b), \\ \text{in}(\alpha) = (\beta)}} W_{\#\text{in}(\beta)}^{\text{tree}} \times \prod_{\rho \in V_{\text{int}}(T_s)} \prod_{\substack{\alpha \in V_{\text{comp}}^{\geq 2}(T_b) \cap f^{-1}\{\rho\}, \\ \text{in}(\alpha) = (\beta_1, \dots, \beta_{\#\text{in}(\rho)})}}^{K_{\#\text{in}(\rho)}} W_{\#\text{in}(\beta_1), \dots, \#\text{in}(\beta_{\#\text{in}(\alpha)})}^{\text{tree}} \hookrightarrow W_{\mathbf{n}}^{\text{tree}},$$

where the superscript on one of the product symbols indicates that it is a fiber product with respect to the maps described in (FORGETFUL). This inclusion is a poset isomorphism onto $\text{cl}(2T) = (F_{-1}, 2T]$.

1.1. Relationship to witch curves. The author was led to define and study 2-associahedra because they are the posets corresponding to degenerations in the moduli space $\overline{2\mathcal{M}}_{\mathbf{n}}$ of *witch curves*. These moduli spaces will be defined and studied in [B1], but here we sketch the definition of $\overline{2\mathcal{M}}_{\mathbf{n}}$ in order to motivate the definition of the 2-associahedra. We begin by defining the uncompactified

moduli space:

$$(2) \quad 2\mathcal{M}_{\mathbf{n}} := \left\{ \begin{array}{l|l} (x_1, \dots, x_r) \in \mathbb{R}^r & x_1 < \dots < x_r \\ (y_{11}, \dots, y_{1n_1}) \in \mathbb{R}^{n_1} & y_{11} < \dots < y_{1n_1} \\ \vdots & \vdots \\ (y_{r1}, \dots, y_{rn_r}) \in \mathbb{R}^{n_r} & y_{r1} < \dots < y_{rn_r} \end{array} \right\} / \mathbb{R}^2 \rtimes \mathbb{R}_{>0} =: X/G.$$

We view an element of X as describing a configuration of r vertical lines in \mathbb{R}^2 with x -positions x_1, \dots, x_r , along with n_i marked points on the i -th line with y -positions y_{i1}, \dots, y_{in_i} . (By identifying $\mathbb{R}^2 \cup \{\infty\} \simeq S^2$, we can also view an element of X as a configuration of marked circles on S^2 , where all the circles intersect tangentially at the south pole.) We view G as the group of affine-linear transformations of the plane which consist of a translation and a positive dilation, which we can extend to define an action of G on X .

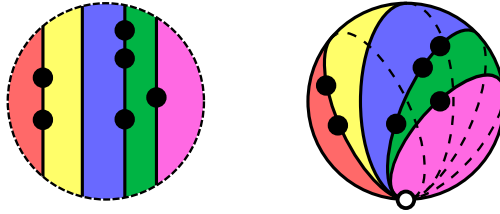
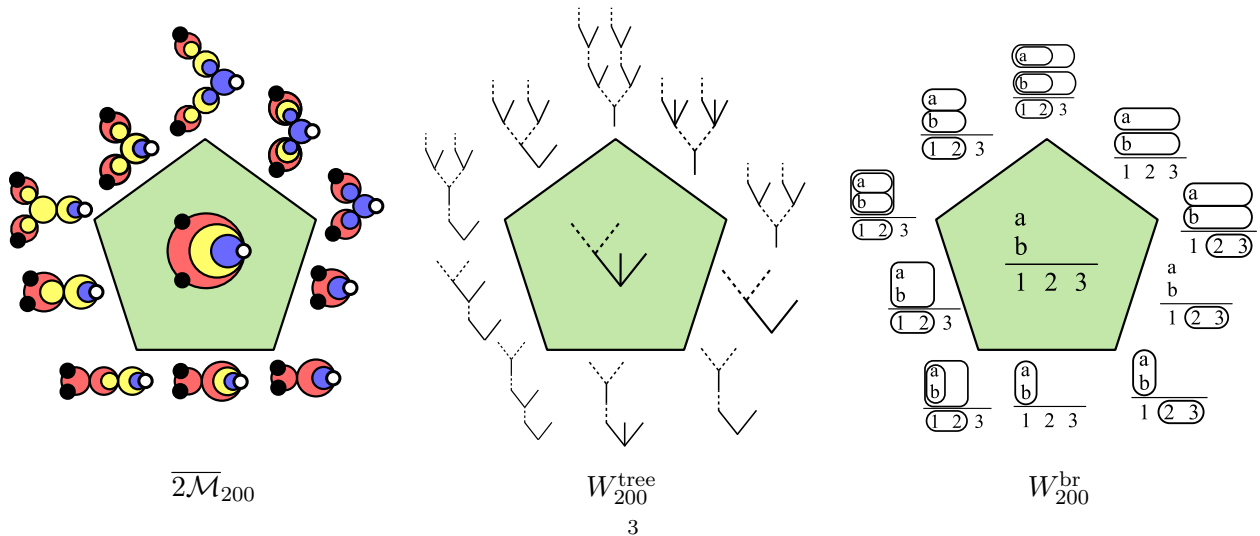

FIGURE 2. Two views of a witch curve in the main stratum $2\mathcal{M}_{\mathbf{n}} \subset \overline{2\mathcal{M}_{\mathbf{n}}}$: on the left, as \mathbb{R}^2 with marked lines; and on the right, as S^2 with marked circles.

$2\mathcal{M}_{\mathbf{n}}$ is not compact: points on a single line can collide, or lines can collide, or these two phenomena can take place simultaneously. We compactify $2\mathcal{M}_{\mathbf{n}}$ to $\overline{2\mathcal{M}_{\mathbf{n}}}$ like so: when a collection of lines collide, then wherever the marked points on these lines are as this collision happens, we bubble off another configuration of lines and points. To define $\overline{2\mathcal{M}_{\mathbf{n}}}$ precisely, we need to specify the allowed degenerations, and this is where the 2-assiahedra come in: the elements of $W_{\mathbf{n}}$ correspond to the allowed degenerations in $\overline{2\mathcal{M}_{\mathbf{n}}}$. We illustrate this in the following figure: on the left is the compactified moduli space $\overline{2\mathcal{M}_{200}}$, and in the middle and on the right are two presentations of W_{200} . (On the left, we are identifying configurations of lines and points in the plane with configurations of vertical lines in the right half-plane, which can in turn be identified with configurations of circles on a disk, all of which intersect tangentially at a point on the boundary. In W_{200}^{tree} , we have omitted the seam tree T_s , which can be inferred from the bubble trees.)



This discussion is parallel to the construction of $\overline{\mathcal{M}}_r$ as the compactification of

$$(3) \quad \mathcal{M}_r := \{(x_1, \dots, x_r) \in \mathbb{R}^r \mid x_1 < \dots < x_r\} / \mathbb{R} \rtimes \mathbb{R}_{>0},$$

where the allowed degenerations are in bijection with the associahedron K_r .

1.2. Future directions. The construction of the 2-associahedra suggests several potential directions:

- In the upcoming paper [B1], the author plans to show that the 2-associahedra have modular realizations in terms of witch curves; these realizations are stratified topological spaces. This fits into a larger project of constructing invariants of collections of Lagrangian correspondences, defined by counting pseudoholomorphic quilts whose domains are witch curves. More progress toward this goal can be found in [BW], where a version of Gromov compactness for these quilts is proven using the analysis in [B3].
- The associahedra have by now several realizations as convex polytopes, including a realization as the secondary polytopes of certain planar polygons. It is natural to wonder whether the 2-associahedra can also be realized as convex polytopes, in particular as secondary or fiber polytopes (a possibility suggested by Gabriel Kerr). Realizability as convex polytopes is not clearly relevant for applications to symplectic geometry, but a realization as secondary or fiber polytopes could suggest additional structure relevant to the study of Fukaya categories.
- It is natural to ask whether there is a notion of “ m -associahedra” for all $m \geq 1$. The author believes that this concept should be relatively straightforward to define, but he does not have a need for this generalization and therefore has no plans to investigate this.
- The author has conjectured that a cellular model for the little 2-disks operad can be built by gluing together copies of $W_{1\dots 1}$. If this is true, it suggests a way of defining a homotopy Gerstenhaber structure on symplectic cohomology involving only finitely many operations of any given arity.
- Analogously to how an A_∞ -category is the same thing as a category over the operad of associahedra, the author plans to define a notion of A_∞ -2-category as a 2-category over the relative 2-operad of 2-associahedra.

1.3. Glossary of notation, and conventions.

notation	interpretation	page first defined
$[\alpha, \beta]$	path from α to β in a tree	p. 6
$\alpha(\beta, \gamma, \delta)$	single vertex in $[\beta, \gamma] \cap [\gamma, \delta] \cap [\delta, \beta]$	p. 19
$\alpha(B)$	vertex corresponding to 1-bracket B	p. 9
$\alpha(\mathbf{2B})$	vertex corresponding to 2-bracket $\mathbf{2B}$	p. 19
B	1-bracket	p. 8
$B(\alpha)$	1-bracket corresponding to vertex α	p. 8
\mathcal{B}	1-bracketing	p. 8
$\mathbf{2B} = (B, (2B_i))$	2-bracket	p. 17
$\mathbf{2B}(\alpha)$	2-bracket corresponding to vertex α	p. 18
$(\mathcal{B}, 2\mathcal{B})$	2-bracketing	p. 17
K_r	associahedron, $K_r = K_r^{\text{br}} = K_r^{\text{tree}}$	p. 10
K_r^{br}	poset of 1-bracketings of r	p. 8
K_r^{tree}	poset of rooted ribbon trees with r leaves	p. 6
$T_{\alpha\beta}$	those vertices γ with $[\alpha, \gamma] \ni \beta$	p. 6
$2T = T_b \xrightarrow{f} T_s$	stable tree-pair (with bubble tree T_b and seam tree T_s)	p. 15
$W_{\mathbf{n}}$	2-associahedron, $W_{\mathbf{n}} = W_{\mathbf{n}}^{\text{br}} = W_{\mathbf{n}}^{\text{tree}}$	p. 24
$W_{\mathbf{n}}^{\text{br}}$	poset of 2-bracketings of \mathbf{n}	p. 18
$W_{\mathbf{n}}^{\text{tree}}$	poset of stable tree-pairs of type \mathbf{n}	p. 15

The following convention applies throughout this paper:

Unless otherwise specified, r will denote a positive integer, and \mathbf{n} will denote an element of $\mathbb{Z}_{\geq 0}^r \setminus \{\mathbf{0}\}$. By $|\mathbf{n}|$ we will denote the sum $\sum_{i=1}^r n_i$. For X_1, \dots, X_ℓ posets, each equipped with a map $f_i: X_i \rightarrow Y$ to another poset, we define and denote the *fiber product of X_1, \dots, X_ℓ over Y* like so:

$$(4) \quad \prod_{1 \leq i \leq \ell}^Y X_i := \left\{ (x_1, \dots, x_\ell, y) \in \prod_{1 \leq i \leq \ell} X_i \times Y \mid \forall i: f_i(x_i) = y \right\}.$$

Note that when $\ell = 0$, the “empty fiber product over Y ” is Y itself, and that when $\ell = 1$ and $f_1: X_1 \rightarrow Y$ is surjective, this fiber product can be identified with X_1 .

1.4. Acknowledgments. The ideas presented in this paper evolved over the course of several years, and the author is grateful to a number of people for their insight and support. This project began in 2014, while the author was a graduate student at MIT under the supervision of Katrin Wehrheim; the author is grateful for Prof. Wehrheim’s support throughout this project. Conversations with Satyan Devadoss greatly helped in the development of the definition of $W_{\mathbf{n}}$. Stefan Forcey pointed out the notion of abstract polytope. David Feldman and Nick Sheridan made suggestions that improved the exposition. The author thanks Mohammed Abouzaid, Helmut Hofer, Jacob Lurie, Paul Seidel, and James Stasheff for encouragement.

The ideas in this paper were developed while the author was a graduate student at MIT, then a postdoctoral researcher at Northeastern University, and finally a member at the Institute for Advanced Study and a postdoctoral researcher at Princeton University. The author was supported by an NSF Graduate Research Fellowship and an NSF Mathematical Sciences Postdoctoral Research Fellowship.

2. THE DEFINITION OF K_r AND SOME BASIC PROPERTIES

In this section we define the associahedra K_r and prove the analogues of Thms. 1.1 and 1.2. We will use K_r later in this paper; besides, the ideas in this section will shed light on the techniques we will use to prove Thms. 1.1 and 1.2.

2.1. Two constructions of K_r : in terms of rooted ribbon trees, and in terms of 1-bracketings. In this subsection we will define two posets K_r^{tree} and K_r^{br} , then show that they are isomorphic. We begin by recalling the definition of a tree.

Definition 2.1. A *tree* is a finite set T and a relation $E \subset T \times T$ satisfying these axioms:

(SYMMETRY) If $\alpha E \beta$, then $\beta E \alpha$.

(ANTIREFLEXIVITY) If $\alpha E \beta$, then $\alpha \neq \beta$.

(CONNECTEDNESS) If α, β are distinct vertices, then there exist $\gamma_1, \dots, \gamma_k \in T$ with $\gamma_1 = \alpha$, $\gamma_k = \beta$, and $\gamma_i E \gamma_{i+1}$ for every i .

(NO CYCLES) If $\gamma_1, \dots, \gamma_k$ are vertices with $\gamma_i E \gamma_{i+1}$ and $\gamma_i \neq \gamma_{i+2}$ for all i , then $\gamma_1 \neq \gamma_k$.

We can now define the model K_r^{tree} .

Definition 2.2. A *rooted ribbon tree* (RRT) is a tree T with a choice of a root $\alpha_{\text{root}} \in T$ and a cyclic ordering of the edges incident to each vertex; we orient such a tree toward the root. We say that a vertex α of an RRT T is *interior* if the set $\text{in}(\alpha)$ of its incoming neighbors is nonempty, and we denote the set of interior vertices of T by T_{int} . An RRT T is *stable* if every interior vertex has at least 2 incoming edges. We define K_r^{tree} to be the set of all isomorphism classes of stable rooted ribbon trees with r leaves.

We denote the i -th leaf of an RRT T by λ_i^T . For any $\alpha, \beta \in T$, $T_{\alpha\beta}$ denotes those vertices γ such that the path $[\alpha, \gamma]$ from α to γ passes through β . We denote $T_\alpha := T_{\alpha_{\text{root}}\alpha}$.

The following lemma provides a useful alternate characterization of RRTs.

Lemma 2.3. *An RRT is equivalent to the following data:*

- a finite set V of vertices with a distinguished element α_{root} ;
- for every $\alpha \in V$, a sequence $\text{in}(\alpha) \subset V$ such that:
 - (1) for every $\alpha \in V$, $\text{in}(\alpha) \not\ni \alpha_{\text{root}}$;
 - (2) for every $\alpha \neq \alpha_{\text{root}}$ there exists a unique vertex β with $\text{in}(\beta) \ni \alpha$; and
 - (3) if $\alpha_1, \dots, \alpha_\ell$ is a sequence in V with $\ell \geq 2$ and $\alpha_j \in \text{in}(\alpha_{j+1})$ for every j , then $\alpha_1 \neq \alpha_\ell$.

Moreover, the RRT is stable if and only if for every $\alpha \in V$, $\#\text{in}(\alpha) \neq 1$.

Proof. Throughout this proof, we will abbreviate $\alpha \in \text{in}(\beta)$ by $\alpha \prec \beta$.

Step 1: Given an RRT, we show that its vertices together with their incoming neighbors satisfy (1–3).

Fix an RRT T . Clearly its root α_{root} is not an incoming neighbor of any vertex, so (1) holds. It is also clear that any $\alpha \neq \alpha_{\text{root}}$ is an incoming neighbor of exactly one vertex, since otherwise the (NO CYCLES) property would not hold; therefore (2) holds. Finally, if $\alpha_1 \prec \dots \prec \alpha_\ell$ is a sequence of vertices with $\ell \geq 2$, then $\text{dist}(\alpha_j, \alpha_{\text{root}}) = \text{dist}(\alpha_{j+1}, \alpha_{\text{root}}) + 1$ for every j , so $\alpha_1 \neq \alpha_\ell$.

Step 2: Given a finite set $V \ni \alpha_{\text{root}}$ and sequences $\text{in}(\alpha)$ for $\alpha \in V$ that satisfy (1–3), we produce an RRT having V as its vertices and $\text{in}(\alpha)$ as the incoming neighbors of α , ordered according to the order of $\text{in}(\alpha)$.

Given this data, define a tree T by

$$(5) \quad V(T) := V, \quad \alpha E \beta \iff \alpha \prec \beta \text{ or } \beta \prec \alpha.$$

This relation is clearly symmetric, and its antireflexivity follows from the $\ell = 2$ case of (3).

To prove (CONNECTEDNESS), we will show that every vertex is connected to α_{root} . Fix $\alpha \in V \setminus \{\alpha_{\text{root}}\}$, and define a path like so: set $\alpha_1 := \alpha$, and for $j \geq 1$ with $\alpha_j \neq \alpha_{\text{root}}$, set α_{j+1} to be the unique vertex with $\alpha_j \prec \alpha_{j+1}$. By (3), this path is nonoverlapping, so since V is finite, this path will eventually terminate at α_{root} .

To prove (NO CYCLES), consider a path $\alpha_1, \dots, \alpha_\ell$ with $\ell \geq 3$ and $\alpha_j \neq \alpha_{j+2}$ for every j ; we must show $\alpha_1 \neq \alpha_\ell$. If there exists j with $\alpha_j \succ \alpha_{j+1} \prec \alpha_{j+2}$, then (2) implies $\alpha_j = \alpha_{j+2}$, in contradiction to our assumption. Therefore we must either have (a) $\alpha_1 \prec \dots \prec \alpha_\ell$, (b) $\alpha_1 \succ \dots \succ \alpha_\ell$, or (c) $\alpha_1 \prec \dots \prec \alpha_j \prec \alpha_{j+1} \succ \alpha_{j+2} \succ \dots \succ \alpha_\ell$. In cases (a) and (b), (3) implies $\alpha_1 \neq \alpha_\ell$. In case (c), suppose $\alpha_1 = \alpha_\ell$. (2) implies that the paths (β_j) resp. (γ_j) defined by $\beta_1 := \alpha_1$ and $\beta_{j+1} \succ \beta_j$ resp. $\gamma_1 := \alpha_\ell$ and $\gamma_{j+1} \succ \gamma_j$ coincide, hence $\alpha_j = \alpha_{j+2}$, a contradiction. In all cases we have shown $\alpha_1 \neq \alpha_\ell$, hence (NO CYCLES) holds.

Clearly Steps 1 and 2 are inverse to one another. The stability criterion is also obvious. \square

Definition 2.4. For T a stable RRT in K_r^{tree} , we define its *dimension* $d(T) \in \mathbb{Z}_{\geq 0}$ like so:

$$(6) \quad d(T) := r - \#T_{\text{int}} - 1.$$

Remark 2.5. Note that K_1^{tree} has a single element, the RRT \bullet with a single vertex and no edges; its dimension is zero.

Lemma 2.6. Fix an RRT $T \in K_r^{\text{tree}}$.

(a) The dimension can be re-expressed using this formula:

$$(7) \quad d(T) = \sum_{\alpha \in T_{\text{int}}} (\#\text{in}(\alpha) - 2).$$

(b) If $r \geq 2$, the dimension satisfies the inequality $0 \leq d(T) \leq r - 2$.

Proof. (a) (7) is the result of substituting into (6) the following identity:

$$(8) \quad \sum_{\alpha \in T_{\text{int}}} \#\text{in}(\alpha) = \#T_{\text{int}} + r - 1.$$

This follows by noting that $\sum_{\alpha \in T_{\text{int}}} \#\text{in}(\alpha)$ counts the vertices in T that are an incoming neighbor of another vertex in T . This set is the complement of the root of T , hence has cardinality $\#T_{\text{int}} + r - 1$.

(b) The inequality $d(T) \geq 0$ follows from (7) and the stability hypothesis on T ; the inequality $d(T) \leq r - 2$ follows immediately from (6). \square

We now define moves that can be performed on stable RRTs. As we will show, each move decreases the dimension d by one. Fix a stable RRT T . Here is the general description of a legal move that can be performed on T : choose $\alpha \in T_{\text{int}}$ and a consecutive subset $(\gamma_{p+1}, \dots, \gamma_{p+l}) \subset (\gamma_1, \dots, \gamma_k) = \text{in}(\alpha)$ where l satisfies $2 \leq l < k$ (necessary to preserve stability). The corresponding move consists of modifying the incoming edges of α like so:

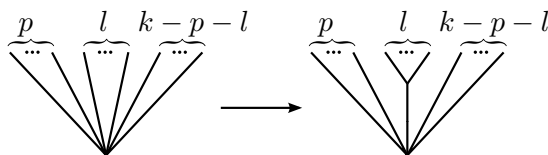

Lemma 2.7. If T is a stable RRT and T' is the result of performing a move on T , then $d(T') = d(T) - 1$.

Proof. If T has r leaves, then we have $d(T) = r - \#T_{\text{int}} - 1$. When we perform a move on T , the number of leaves remains the same and one new interior node is created, so d decreases by one. \square

Definition-Lemma 2.8. Define K_r^{tree} as a poset by declaring $T' < T$ if there is a finite sequence of moves that transforms T into T' .

Proof. We must check that this defines a partial order on K_r . The reflexivity property follows from Lemma 2.7. Transitivity is immediate. \square

Recall that a **tree homomorphism** is a map $f: T \rightarrow \tilde{T}$ such that $f^{-1}\{\tilde{\alpha}\}$ is a tree for every $\tilde{\alpha} \in \tilde{T}$, and $\alpha E \beta$ implies that either $f(\alpha) = f(\beta)$ or $f(\alpha) \tilde{E} f(\beta)$. An **RRT homomorphism** is a tree homomorphism $f: T \rightarrow \tilde{T}$ that sends leaves to leaves, root to root, interior vertices to interior vertices, and respects the cyclic orderings of edges and also the orientation in the sense that $\beta \in \text{in}(\alpha)$ implies either $f(\beta) = f(\alpha)$ or $f(\beta) \in \text{in}(f(\alpha))$. If \tilde{T} is the result of performing a sequence of moves on a stable RRT T , then there is a surjective RRT homomorphism $\tilde{T} \rightarrow T$ gotten by contracting the edges added to T to form \tilde{T} . As the next lemma shows, all surjective homomorphisms of stable RRTs can be obtained in this fashion.

Lemma 2.9. If $f: \tilde{T} \rightarrow T$ is a surjective homomorphism of stable RRTs, then \tilde{T} can be obtained from T by applying a finite sequence of moves, and f is the map that contracts the new edges that were added to T to form \tilde{T} .

Proof. We begin by showing that T and \tilde{T} have the same number of leaves, and that f satisfies $f(\lambda_i^T) = \lambda_i^{\tilde{T}}$ for all i . For this, it suffices to show that f is injective on leaves. Suppose that for some $i \neq j$, $f(\lambda_i^T) = f(\lambda_j^T)$. The preimage of every vertex in \tilde{T} is connected, so the outgoing neighbor of λ_i^T must also be sent to $f(\lambda_i^T)$. This contradicts the hypothesis that f sends interior vertices to interior vertices.

We prove the lemma by induction on $\#\tilde{T} - \#T$. If \tilde{T} and T have the same number of vertices, then they are isomorphic and the claim is trivially true. Next, suppose we have proven the claim as long as the inequality $\#\tilde{T} - \#T \leq k$ holds, and suppose that \tilde{T}, T satisfy $\#\tilde{T} = \#T + k + 1$. Choose an edge $\tilde{\alpha} \tilde{E} \tilde{\beta}$ with $f(\tilde{\alpha}) = f(\tilde{\beta})$, and assume that $\tilde{\beta}$ is further from the root than $\tilde{\alpha}$. Define T' to be the stable RRT gotten by contracting $\tilde{\alpha} \tilde{E} \tilde{\beta}$ in \tilde{T} . Then \tilde{T} can be obtained from T' by making a single move. Moreover, $f: \tilde{T} \rightarrow T$ can be factored as $\tilde{T} \rightarrow T' \rightarrow T$, where $\tilde{T} \rightarrow T'$ is the map that contracts $\tilde{\alpha} \tilde{E} \tilde{\beta}$, and $g: T' \rightarrow T$ is defined by

$$(9) \quad g(\tilde{\gamma}) := \begin{cases} f(\tilde{\alpha}), & \tilde{\gamma} \in \{\tilde{\alpha}, \tilde{\beta}\}, \\ f(\tilde{\gamma}), & \text{otherwise.} \end{cases}$$

By induction, $g: T' \rightarrow T$ is the result of applying finitely many moves to T , so we have proven the claim by induction. \square

Another way to characterize a stable RRT is as a *1-bracketing* of $\{1, \dots, r\}$. Each 1-bracket corresponds to the RRT's local structure at a particular interior vertex.

Definition 2.10. A *1-bracket* of r is a nonempty consecutive subset $B \subset \{1, \dots, r\}$. A *1-bracketing* of r is a collection \mathcal{B} of 1-brackets of r satisfying these properties:

(BRACKETING) If $B, B' \in \mathcal{B}$ have $B \cap B' \neq \emptyset$, then either $B \subset B'$ or $B' \subset B$.

(ROOT AND LEAVES) \mathcal{B} contains $\{1, \dots, r\}$ and $\{i\}$ for every i .

We denote the set of all 1-bracketings of r by K_r^{br} , and define a partial order by defining $\mathcal{B}' < \mathcal{B}$ if \mathcal{B}' is a proper subcollection of \mathcal{B} .

Definition 2.11. Fix a stable tree $T \in K_r^{\text{tree}}$. A *T-bracket* is a 1-bracket B of r with the property that for some $\alpha \in T$, $B =: B(\alpha)$ is the set of indices i for which T_α contains λ_i .

Note that since T is stable, the T -brackets are in bijective correspondence with the vertices of T .

Proposition 2.12. *The function $\nu: K_r^{\text{tree}} \rightarrow K_r^{\text{br}}$ that sends a stable RRT T to the set of T -brackets is an isomorphism of posets.*

Proof. Step 1: If T is a stable RRT with r leaves, then $\nu(T)$ is a 1-bracketing of r .

We have $B(\alpha_{\text{root}}) = \{1, \dots, r\}$ and $B(\lambda_i^T) = \{i\}$, so $\nu(T)$ contains $\{1, \dots, r\}$ and $\{i\}$ for every i . Clearly every $B(\alpha) \in \nu(T)$ is nonempty and consecutive. Finally, if $\alpha, \beta \in T$ have neither $\alpha \in T_\beta$ nor $\beta \in T_\alpha$, then $B(\alpha) \cap B(\beta) = \emptyset$: indeed, if $i \in B(\alpha) \cap B(\beta)$, then the path from λ_i to α_{root} passes through both α and β . On the other hand, if $\beta \in T_\alpha$, then $B(\beta) \subset B(\alpha)$.

Step 2: We define a putative inverse $\tau: K_r^{\text{br}} \rightarrow K_r^{\text{tree}}$.

Given $\mathcal{B} \in K_r^{\text{br}}$, we will define $\tau(\mathcal{B})$ via Lemma 2.3. Define

$$(10) \quad V := \mathcal{B} \ni \{1, \dots, r\} =: \alpha_{\text{root}}, \quad B' \in \text{in}(B) \iff (B' \subsetneq B \text{ and } \nexists B'' \in \mathcal{B} : B' \subsetneq B'' \subsetneq B),$$

and denote the vertex corresponding to $B \in \mathcal{B}$ by $\alpha(B)$. Any distinct $\alpha(B'), \alpha(B'') \in \text{in}(\alpha(B))$ must have $B' \cap B'' = \emptyset$, since otherwise one of B' and B'' would be properly contained in the other; we may therefore order $\text{in}(\alpha(B))$ by declaring that $\alpha(B'), \alpha(B'') \in \text{in}(\alpha(B))$ have $\alpha(B') <_{\alpha(B)} \alpha(B'')$ if and only if $i' < i''$ for all $i' \in B', i'' \in B''$.

We now verify conditions (1–3) from Lemma 2.3. To prove (1), note that for any $\alpha(B) \in V$ and $\alpha(B') \in \text{in}(\alpha(B))$, B' is a proper subset of B ; therefore $\text{in}(\alpha(B))$ does not contain $\alpha(\{1, \dots, r\}) = \alpha_{\text{root}}$. For (2), fix $\alpha(B) \in V \setminus \{\alpha_{\text{root}}\}$ and define $\Sigma := \{B' \in \mathcal{B} \mid B' \supsetneq B\}$. Then Σ contains $\{1, \dots, r\}$, hence is nonempty. Moreover, if $B', B'' \in \Sigma$ are distinct and minimal with respect to inclusion, then $B' \cap B'' \supset B \neq \emptyset$; therefore one of B', B'' must contain the other, a contradiction to minimality. This shows that Σ contains a unique minimal element, which is the unique B' with $\text{in}(\alpha(B')) \ni \alpha(B)$; this establishes (2). Finally, if $\alpha(B^1), \dots, \alpha(B^\ell) \in V$ is a sequence with $\ell \geq 2$ and $\alpha(B^j) \in \text{in}(\alpha(B^{j+1}))$ for every j , then $B^1 \subsetneq B^\ell$, hence $\alpha(B^1) \neq \alpha(B^\ell)$.

It is clear that $\tau(\mathcal{B})$ is stable and that $\{i\}$ is the i -th leaf of $\tau(\mathcal{B})$.

Step 3: We show that ν and τ are inverse bijections.

First, fix $T \in K_r^{\text{tree}}$; we claim $T \simeq \tau(\nu(T))$. There is an obvious identification of vertices, which identifies root with root. Next, we must show that the edge relations on the vertices T are the same, which is to say that $\beta \in \text{in}(\alpha)$ is equivalent to $B(\beta) \subsetneq B(\alpha)$ and the nonexistence of $\gamma \in T$ with $B(\beta) \subsetneq B(\gamma) \subsetneq B(\alpha)$.

Fix $\beta \in \text{in}(\alpha)$. Certainly $B(\beta) \subset B(\alpha)$, and this containment is proper by the stability of T . (Indeed, define an outgoing path by setting $\delta_1 := \alpha$, choosing δ_2 to be an incoming neighbor of α other than β , and inductively defining δ_{i+1} to be an incoming neighbor of δ_i as long as $\text{in}(\delta_i)$ is not empty. This path will terminate, by condition (3) in Lemma 2.3. Moreover, this path does not include β : if it did, it would by (2) have $\delta_i = \alpha$ for some $i \geq 2$, which is impossible by (3). If λ_j is the leaf at which this path terminates, then $j \in B(\alpha) \setminus B(\beta)$.) Suppose that there exists γ with $B(\beta) \subsetneq B(\gamma) \subsetneq B(\alpha)$, and choose $i \in B(\beta)$. Since $B(\alpha), B(\beta), B(\gamma)$ all contain i , the path $[\lambda_i, \alpha_{\text{root}}]$ must contain α, β, γ . The containments $B(\beta) \subsetneq B(\gamma) \subsetneq B(\alpha)$ now imply that the path $\beta = \delta_1, \delta_2, \dots, \delta_\ell = \alpha$ from β to α is oriented toward the root and has $\delta_i = \gamma$ for some $i \in [2, \ell - 1]$. Without loss of generality we may assume $i = 2$. Then $\beta \in \text{in}(\gamma)$, so β cannot lie in $\text{in}(\alpha)$, a contradiction.

Conversely, suppose $B(\beta) \subsetneq B(\alpha)$ and that there does not exist γ with $B(\beta) \subsetneq B(\gamma) \subsetneq B(\alpha)$. An argument similar to the one in the previous paragraph yields $\beta \in \text{in}(\alpha)$.

Second, fix $\mathcal{B} \in K_r^{\text{br}}$; we claim $\mathcal{B} = \nu(\tau(\mathcal{B}))$. To prove this, it suffices to show that $\alpha(\{i\}) \in T_{\alpha(B)}$ if and only if $i \in B$. Suppose $\alpha(\{i\}) \in T_{\alpha(B)}$. This means that there is a sequence of 1-brackets $\{i\} = B_1, B_2, \dots, B_\ell = B$ in \mathcal{B} such that for every i , either (a) $B_i \subsetneq B_{i+1}$ and there exists no

$B' \in \mathcal{B}$ with $B_i \subsetneq B' \subsetneq B_{i+1}$, or (b) the same holds but with B_i and B_{i+1} interchanged. In fact, an argument similar to the one made in the proof of (NO CYCLES) in Lemma 2.3 implies that for every i it is (a) that holds. Therefore i lies in B . Conversely, suppose $i \in B$. Define a sequence in \mathcal{B} by setting $B_1 := B$ and, as long as B_i is not equal to $\{i\}$, defining B_{i+1} to be the largest element of \mathcal{B} satisfying $B_i \supsetneq B_{i+1} \supsetneq \{i\}$. This defines a non-self-intersecting path in $\tau(\mathcal{B})$ that begins at $\alpha(B)$ and terminates at the i -th leaf, which proves the backwards direction of the assertion that $\alpha(\{i\}) \in T_{\alpha(B)}$ is equivalent to $i \in B$.

Step 4: We show that ν and τ respect the partial orders on K_r^{tree} and K_r^{br} .

First, we show that if $T' < T$, then $\nu(T') < \nu(T)$. By Lemma 2.8, we may assume without loss of generality that T' is the result of performing a single move on T . Denote by $\alpha \in T$ the vertex at which the move is performed, so that T' is produced from T by introducing a new incoming neighbor of α . We may therefore regard $V(T)$ as a subset of $V(T')$. If β is a vertex of T , and $B(\beta)$ resp. $B'(\beta)$ denote the indices of the leaves in T_β resp. in T'_β , then $B(\beta) = B'(\beta)$. Therefore $\nu(T') < \nu(T)$.

Second, we show that if $\mathcal{B}' < \mathcal{B}$, then $\tau(\mathcal{B}') < \tau(\mathcal{B})$. Define a map $f: \tau(\mathcal{B}') \rightarrow \tau(\mathcal{B})$ like so:

$$(11) \quad f(\alpha(B')) := \alpha(\min\{B \in \mathcal{B} \mid B \supset B'\}),$$

where the minimum is taken with respect to inclusion. By (ROOT AND LEAVES), the set over which we are taking the minimum contains $\{1, \dots, r\}$, hence is nonempty; therefore f is well-defined. I claim that f is a surjective homomorphism of stable RRTs. Again by (ROOT AND LEAVES), f sends $\lambda_i^{T'}$ to λ_i^T ; since \mathcal{B} is a subcollection of \mathcal{B}' , f is surjective. It remains to show that the preimage under f of each vertex in T is connected. Fix $B \in \mathcal{B}$; it suffices to show that for any $B' \in \mathcal{B}'$ with $f(\alpha(B')) = \alpha(B)$, the path from $\alpha(B')$ to $\alpha(B)$ in $\tau(\mathcal{B}')$ is contained in $f^{-1}\{\alpha(B)\}$. This is apparent from the definition of f , so we may conclude that f is a surjective morphism of stable RRTs, hence $\tau(\mathcal{B}') < \tau(\mathcal{B})$ by Lemma 2.9. \square

By this lemma, we may define $K_r := K_r^{\text{tree}} = K_r^{\text{br}}$.

2.2. \widehat{K}_r is an abstract polytope of dimension $r - 2$. In this subsection we prove the following proposition.

Proposition 2.13. *The associahedron K_r is a poset, and the associahedra satisfy the following properties:*

(ABSTRACT POLYTOPE) For $r \geq 2$, $\widehat{K}_r := K_r \cup \{F_{-1}\}$ is an abstract polytope of dimension $r - 2$.

(RECURSIVE) For any $T \in K_r^{\text{tree}}$, there is an inclusion of posets

$$(12) \quad \gamma_T: \prod_{\alpha \in T_{\text{int}}} K_{\#\text{in}(\alpha)}^{\text{tree}} \hookrightarrow K_r^{\text{tree}},$$

which restricts to a poset isomorphism onto $\text{cl}(T) = (F_{-1}, T]$.

We begin by establishing (RECURSIVE).

Definition-Lemma 2.14. Fix $r \geq 2$ and $T \in K_r^{\text{tree}}$. Define a map

$$(13) \quad \gamma_T: \prod_{\alpha \in T_{\text{int}}} K_{\#\text{in}(\alpha)}^{\text{tree}} \rightarrow K_r^{\text{tree}}$$

by sending $(T^\beta)_{\beta \in \text{int}(\alpha)}$ to the RRT gotten by replacing each β and its incoming neighbors and edges by T^β . Then γ_T restricts to a poset isomorphism from its domain to $\text{cl}(T)$.

Proof. We will define an inverse $\sigma_T: \text{cl}(T) \rightarrow \prod_{\alpha \in T_{\text{int}}} K_{\#\text{in}(\alpha)}^{\text{tree}}$ to the restriction of γ_T . Fix $\widehat{T} \in \text{cl}(T)$; then there is a (unique) surjective homomorphism $f: \widehat{T} \rightarrow T$ of ribbon trees. For any $\alpha \in T$, define $\widehat{\alpha} \in \widehat{T}$ to be the element of $f^{-1}\{\alpha\}$ that is closest to the root. For any $\alpha \in T_{\text{int}}$, define

$$(14) \quad \widehat{T}^\alpha := f^{-1}\{\alpha\} \cup \{\widehat{\beta} \mid \beta \in \text{in}(\alpha)\}, \quad \alpha_{\text{root}}^{\widehat{T}^\alpha} := \widehat{\alpha}.$$

Then \widehat{T}^α is a subtree of \widehat{T} : since f is a tree homomorphism, $f^{-1}\{\alpha\}$ is a subtree of \widehat{T} . For any $\beta \in \text{in}(\alpha)$, we must either have $\text{out}(\widehat{\beta}) = f(\widehat{\beta}) = \beta$ or $\text{out}(\widehat{\beta}) = \text{out}(f(\widehat{\beta})) = \alpha$; by the definition of $\widehat{\beta}$, the latter equality must hold, so \widehat{T}^α is a subtree of \widehat{T} . Furthermore, the ribbon tree structure of \widehat{T} induces a ribbon tree structure on \widehat{T} , so \widehat{T} is an RRT. I claim that \widehat{T}^α is stable and has leaves in bijection with $\text{in}(\alpha)$. For any $\beta \in \text{in}(\alpha)$, it follows immediately from the definition of $\widehat{\beta}$ that $\widehat{\beta} \in \widehat{T}^\alpha$ is a leaf. Next, fix $\beta \in f^{-1}\{\alpha\}$; we must show $\beta \in \widehat{T}^\alpha$ has at least 2 incoming neighbors. In fact, its incoming neighbors are in correspondence with the incoming neighbors of β in \widehat{T} . We may conclude that \widehat{T}^α is a stable RRT with leaves in correspondence with $\text{in}(\alpha)$. We may now define σ_T :

$$(15) \quad \sigma_T: \text{cl}(T) \rightarrow \prod_{\alpha \in T_{\text{int}}} K_{\#\text{in}(\alpha)}^{\text{tree}}, \quad \sigma_T(\widehat{T}) := (\widehat{T}^\alpha)_{\alpha \in T_{\text{int}}}.$$

It is clear from the definition of σ_T that it is an inverse to the restriction of γ_T to a morphism $\gamma_T: \prod_{\alpha \in T_{\text{int}}} K_{\#\text{in}(\alpha)}^{\text{tree}} \rightarrow \text{cl}(T)$. It is also clear that γ_T and σ_T respect the partial orders on $\prod_{\alpha \in T_{\text{int}}} K_{\#\text{in}(\alpha)}^{\text{tree}}$ and K_r^{tree} . \square

We now turn to the proof of the (ABSTRACT POLYTOPE) property from Prop. 2.13. Define $\widehat{K}_r := K_r \cup \{F_{-1}\}$, where F_{-1} is a formal minimal element with $d(F_{-1}) := -1$. We first recall the notion of abstract polytope:

Definition 2.15. An **abstract polytope of rank** $n \in \mathbb{Z}_{\geq -1}$ is a partially ordered set P (whose elements are called **faces**) satisfying the properties (EXTREMAL), (FLAG-LENGTH), (STRONGLY CONNECTED), and (DIAMOND), defined below.

(EXTREMAL) P has a least and a greatest face, denoted F_{-1} resp. F_n .

(FLAG-LENGTH) Every flag (i.e. maximal chain) of P has length $n + 1$, i.e. contains $n + 2$ faces.

For $F, G \in P$ with $F \leq G$, recall that the closed interval $[F, G]$ is defined by

$$(16) \quad [F, G] := \{H \in P \mid F \leq H \leq G\}.$$

It follows from (EXTREMAL) and (FLAG-LENGTH) that we can endow P with a rank function, where $\text{rk } F$ is defined to be the rank of the poset $[F_{-1}, F]$.

(STRONGLY CONNECTED) For every $F < G$ with $\text{rk } G - \text{rk } F \geq 3$ and for every $H, H' \in (F, G)$, there is a sequence $(H = H_1, H_2, \dots, H_k = H')$ in (F, G) such that H_i and H_{i+1} are adjacent for every i (i.e., either $H_i \prec H_{i+1}$ or $H_{i+1} \prec H_i$, where we write $F_1 \prec F_2$ if $F_1 < F_2$ and there exists no F_3 with $F_1 < F_3 < F_2$).

(DIAMOND) For every $F < G$ with $\text{rk } G - \text{rk } F = 2$, the open interval (F, G) contains exactly 2 elements.

Proposition 2.16. For any $r \geq 2$, \widehat{K}_r is an abstract polytope of dimension $r - 2$.

Proof. (EXTREMAL) The least face is the face F_{-1} we have added to K_r to form \widehat{K}_r . The greatest face (in $\widehat{K}_r^{\text{br}}$) is the 1-bracketing $\{\{1, \dots, r\}, \{1\}, \dots, \{r\}\}$.

(FLAG-LENGTH) It suffices to show that if $T^0 < \dots < T^\ell$ is a maximal chain in K_r^{tree} , then $\ell = r - 2$. By Lemmata 2.6 and 2.7, we have $0 \leq d(T^0) < \dots < d(T^\ell) \leq r - 2$. To prove the claim, we must show that every dimension between 0 and $r - 2$ is represented. For any T^i, T^{i+1} , we must have $d(T^i) = d(T^{i+1}) - 1$: otherwise, there exists $T' \in K_r^{\text{tree}}$ which can be obtained by performing a single move to T^{i+1} , and which satisfies $d(T^i) < d(T') < d(T^{i+1})$; this contradicts the maximality of the chain. Again by maximality, we must have $T^\ell = F_{r-2}$. It remains to show $d(T^0) = 0$. Suppose for a contradiction that $d(T^0)$ is positive; then by Lemma 2.6, there exists $\alpha \in T_{\text{int}}^0$ with $\#\text{in}(\alpha) \geq 3$. It follows that we may perform a move to T^0 , so there exists $T' \in K_r^{\text{tree}}$ with $T' < T^0$, contradicting the maximality of this chain.

(STRONGLY CONNECTED) First, we show that \widehat{K}_r is connected. It suffices to show that for any $a, b \geq 2$ with $a + b - 1 = r$ and i with $1 \leq i \leq a$, there exists a path in $\widehat{K}_r \setminus F_{r-2}$ between these two codimension-1 faces:

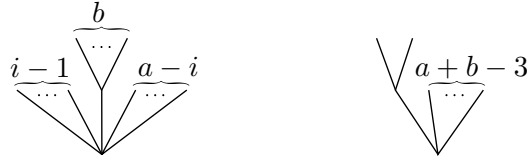

We produce such a path in the following four, exhaustive, cases:

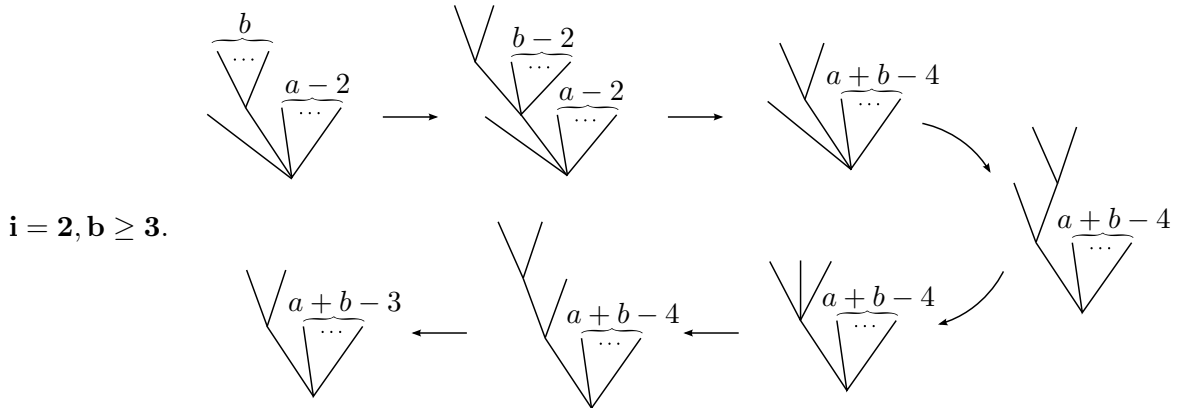
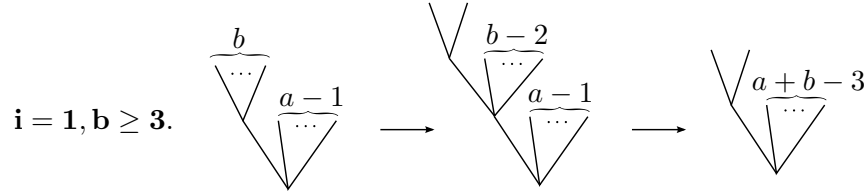
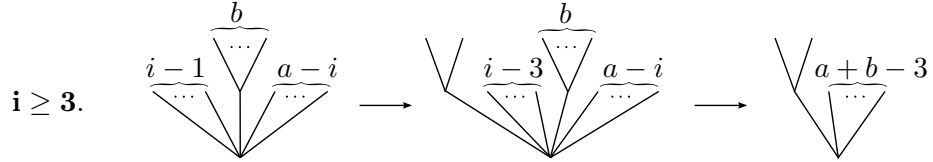

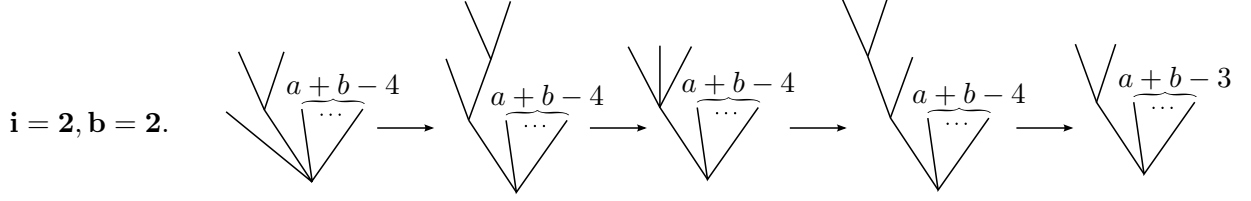

Next, we show that for any $T \in K_r^{\text{tree}}$ with $d(T) \geq 2$, the interval $[F_{-1}, T]$ is connected. By Def.-Lem. 2.14, $[F_{-1}, T]$ is isomorphic to $\{F_{-1}\} \cup \prod_{\alpha \in T_{\text{int}}} K_{\#\text{in}(\alpha)}^{\text{tree}}$. The connectedness of $\widehat{K}_s^{\text{tree}}$ implies that $\{F_{-1}\} \cup \prod_{\alpha \in T_{\text{int}}} K_{\#\text{in}(\alpha)}^{\text{tree}}$ is connected: indeed, for any two nonmaximal elements $(T_1^\alpha)_\alpha, (T_2^\alpha)_\alpha$, there is a path that goes from (T_1^α) to $(\min(T_1^\alpha, T_2^\alpha))$ and then to (T_2^α) .

Finally, we show that for any $\mathcal{B}, \mathcal{B}'$ with $\mathcal{B}' < \mathcal{B}$ and $d(\mathcal{B}') \leq d(\mathcal{B}) - 3$, the interval $[\mathcal{B}', \mathcal{B}]$ is connected. Extend the dimension function d to K_r^{br} via the identification $K_r^{\text{br}} \simeq K_r^{\text{tree}}$. Then $d(\mathcal{B}) = 4r - \#\mathcal{B}$. To prove that $[\mathcal{B}', \mathcal{B}]$ is connected, it suffices to show that for any distinct $\tilde{\mathcal{B}}^1, \tilde{\mathcal{B}}^2 \in (\mathcal{B}', \mathcal{B})$ with $d(\tilde{\mathcal{B}}^1) = d(\tilde{\mathcal{B}}^2) = d(\mathcal{B}) - 1$, there is a path from $\tilde{\mathcal{B}}^1$ to $\tilde{\mathcal{B}}^2$ in $(\mathcal{B}', \mathcal{B})$. The inequality $\tilde{\mathcal{B}}^j \geq \mathcal{B}'$ for $j \in \{1, 2\}$ implies that $\hat{\mathcal{B}} := \tilde{\mathcal{B}}^1 \cup \tilde{\mathcal{B}}^2$ is a 1-bracketing. Moreover, it satisfies $\hat{\mathcal{B}} \in [\mathcal{B}', \mathcal{B})$, and by the formula for the dimension of a 1-bracketing given above, it satisfies $d(\hat{\mathcal{B}}) = d(\mathcal{B}) - 2$. By the hypothesis $d(\mathcal{B}') \leq d(\mathcal{B}) - 3$, $\hat{\mathcal{B}}$ must therefore lie in $(\mathcal{B}', \mathcal{B})$, so $(\tilde{\mathcal{B}}^1, \hat{\mathcal{B}}, \tilde{\mathcal{B}}^2)$ is a path in $(\mathcal{B}', \mathcal{B})$.

(DIAMOND) First, fix $T \in K_r^{\text{tree}}$ with $d(T) = 1$; we must show that the open interval (F_{-1}, T) contains exactly two elements. Lemma 2.6 implies that every vertex in T_{int} has two incoming neighbors except for a single α with $\#\text{in}(\alpha) = 3$. Denote the incoming neighbors of α by $(\beta_1, \beta_2, \beta_3)$. There are two possible moves that can be made at α , by either splitting off (α_1, α_2) or (α_2, α_3) . In fact, these are the only two moves that can be performed on T . Since $d(T) = 1$, (F_{-1}, T) contains two elements.

Next, fix $\mathcal{B}, \mathcal{B}' \in K_r^{\text{br}}$ with $d(\mathcal{B}') = d(\mathcal{B}) - 2$. It follows from the definition of $d: K_r^{\text{tree}}$ and Lemma 2.12 that \mathcal{B}' is obtained from \mathcal{B} by adding two 1-brackets. From this it is clear that the open interval $(\mathcal{B}', \mathcal{B})$ contains two elements. □

3. CONSTRUCTION OF THE 2-ASSOCIAHEDRA $W_{\mathbf{n}}$

As described in §1.1, $W_{\mathbf{n}}$ is intended to index the possible degenerations that a sequence of points in the moduli space $\overline{2\mathcal{M}}_{\mathbf{n}}$ can undergo. In this section we will define two models for $W_{\mathbf{n}}$: $W_{\mathbf{n}}^{\text{tree}}$ and $W_{\mathbf{n}}^{\text{br}}$. To approach and motivate these models, consider the following representative degenerations in $\overline{2\mathcal{M}}_{200}$:

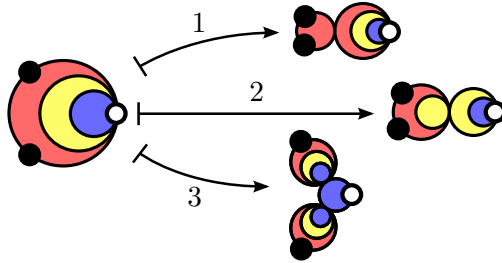

(Here we view points in $\overline{2\mathcal{M}}$ as equivalence classes of configurations of marked circles on a disk.) Degeneration 1 occurs when the two black points collide; degeneration 2 occurs when the larger

interior circle expands and collides with the boundary circle, while the black points simultaneously collide; and degeneration 3 occurs when the two interior circles simultaneously expand and collide with the boundary circle, with the black points not simultaneously colliding. To define the 2-associahedra, we must produce combinatorial data that track these degenerations. We can do so in two ways:

- Represent each component as a vertex in a tree, with solid edges corresponding to the seams (i.e., boundary circle or interior circles) appearing on that component. We represent an attachment between two components as a dashed edge, and a marked point is also represented as a dashed edge. This leads to the model W_n^{tree} , and in this model the degenerations pictured above take the following form:

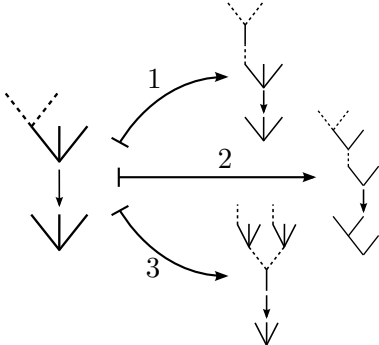

The reader will observe that a single datum is not only a tree with solid and dashed edges, but also a smaller, solid, tree which receives a map from the larger tree. The reason for this is that when components bubble off, the same seam may appear in multiple components. These seams must remain linked, so that the enlargement $2\overline{\mathcal{M}}_n$ is a reasonable compactification of $2\mathcal{M}_n$, and this linking is enforced by the smaller tree and the map it receives.

- Represent the seams as a horizontal line of numbers; above each number, represent the points that appear on that seam as a vertical line of letters. For any given component C in the bubble tree, form a subtree consisting of the components that can only be reached from the main component by passing through C ; the datum corresponding to C is a grouping including those marked points appearing in this subtree. Such a grouping is called a *2-bracket*, and every 2-bracket comes with a “width”, which indicates the seams that appear on the corresponding component. This leads to the model W_n^{br} , and in this model the above degenerations take the following form:

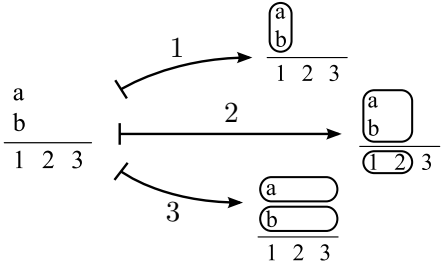

We begin by defining W_n^{tree} , whose definition is more intuitive; later we will define W_n^{br} .

3.1. The poset $W_{\mathbf{n}}^{\text{tree}}$ of stable tree-pairs.

Definition 3.1. A *stable tree-pair of type \mathbf{n}* is a datum $2T = T_b \xrightarrow{f} T_s$, with T_b, T_s, f described below:

- The *bubble tree* T_b is an RRT whose edges are either solid or dashed, which must satisfy these properties:
 - The vertices of T_b are partitioned as $V(T_b) = V_{\text{comp}} \sqcup V_{\text{seam}} \sqcup V_{\text{mark}}$, where:
 - * every $\alpha \in V_{\text{comp}}$ has ≥ 1 solid incoming edge, no dashed incoming edges, and either a dashed or no outgoing edge;
 - * every $\alpha \in V_{\text{seam}}$ has ≥ 0 dashed incoming edges, no solid incoming edges, and a solid outgoing edge; and
 - * every $\alpha \in V_{\text{mark}}$ has no incoming edges and either a dashed or no outgoing edge.
 - We partition $V_{\text{comp}} =: V_{\text{comp}}^1 \sqcup V_{\text{comp}}^{\geq 2}$ according to the number of incoming edges of a given vertex.
 - (STABILITY) If α is a vertex in V_{comp}^1 and β is its incoming neighbor, then $\#\text{in}(\beta) \geq 2$; if α is a vertex in $V_{\text{comp}}^{\geq 2}$ and $\beta_1, \dots, \beta_\ell$ are its incoming neighbors, then there exists j with $\#\text{in}(\beta_j) \geq 1$.
- The *seam tree* T_s is an element of K_r^{tree} .
- The *coherence map* is a map $f: T_b \rightarrow T_s$ of sets having these properties:
 - f sends root to root, and if $\beta \in \text{in}(\alpha)$ in T_b , then either $f(\beta) \in \text{in}(f(\alpha))$ or $f(\alpha) = f(\beta)$.
 - f contracts all dashed edges, and every solid edge whose terminal vertex is in $V_{\text{comp},1}$.
 - For any $\alpha \in V_{\text{comp}}^{\geq 2}$, f maps the incoming edges of α bijectively onto the incoming edges of $f(\alpha)$, compatibly with $<_\alpha$ and $<_{f(\alpha)}$.
 - f sends every element of V_{mark} to a leaf of T_s , and if $\lambda_i^{T_s}$ is the i -th leaf of T_s , then $f^{-1}\{\lambda_i^{T_s}\}$ contains n_i elements of V_{mark} , which we denote by $\mu_{i1}^{T_b}, \dots, \mu_{in_i}^{T_b}$.

We denote by $W_{\mathbf{n}}^{\text{tree}}$ the set of isomorphism classes of stable tree-pairs of type \mathbf{n} .

Definition 3.2. For $2T$ a stable tree-pair, we define the *dimension* $d(2T) \in \mathbb{Z}$ like so:

$$(17) \quad d(2T) := |\mathbf{n}| + r - \#V_{\text{comp}}^1(T_b) - \#(T_s)_{\text{int}} - 2.$$

Remark 3.3. Note that W_1^{tree} has a single element, the stable tree-pair $\bullet \rightarrow \bullet$; its dimension is zero.

Lemma 3.4. Fix a stable tree-pair $2T \in W_{\mathbf{n}}$.

(a) The dimension can be re-expressed using this formula:

$$(18) \quad d(2T) = \sum_{\substack{\alpha \in V_{\text{comp}}^1(T_b) \\ \text{in}(\alpha) = (\beta)}} (\#\text{in}(\beta) - 2) + \sum_{\alpha \in V_{\text{comp}}^{\geq 2}(T_b)} \left(\left(\sum_{\beta \in \text{in}(\alpha)} \#\text{in}(\beta) \right) - 1 \right) + \sum_{\rho \in (T_s)_{\text{int}}} (\#\text{in}(\rho) - 2).$$

(b) If $\mathbf{n} \neq (1)$, the dimension satisfies the inequality $0 \leq d(2T) \leq |\mathbf{n}| + r - 3$.

Proof. (a) (18) is the result of substituting into (17) (8) and the following identity:

$$(19) \quad \sum_{\alpha \in V_{\text{seam}}(T_b)} \#\text{in}(\alpha) = \#V_{\text{comp}}(T_s) + |\mathbf{n}| - 1.$$

This follows by noting that $\sum_{\alpha \in V_{\text{seam}}(T_b)} \#\text{in}(\alpha)$ counts the elements of $V_{\text{comp}}(T_b)$ that are the incoming neighbor of some element of $V_{\text{seam}}(T_b)$. This set is the complement of the root of T_b , hence has cardinality $\#V_{\text{comp}}(T_b) + |\mathbf{n}| - 1$.

(b) The inequality $d(2T) \geq 0$ follows from (18) and the (STABILITY) axiom in the definition of stable tree-pairs; the inequality $d(2T) \leq |\mathbf{n}| + r - 3$ follows immediately from (17). \square

Next we define three types of “moves” that can be performed on stable tree-pairs. Examples of these moves are shown in the first bullet in the introduction to the current section. As we will show, each move decreases the dimension d by one.

Fix a stable tree-pair $T_b \xrightarrow{f} T_s$. Here are the moves that may be applied:

- Type-1 moves:* Fix $\alpha \in V_{\text{comp}}(T_b)$ and $\beta \in \text{in}(\alpha)$. Choose a consecutive subset $(\gamma_{p+1}, \dots, \gamma_{p+l}) \subset (\gamma_1, \dots, \gamma_k) = \text{in}(\beta)$ where l satisfies the following condition (necessary to preserve stability):
- If $\#\text{in}(\alpha) = 1$, then we require $2 \leq l < k$.
 - If $\#\text{in}(\alpha) \geq 2$, then we require $2 \leq l \leq k$.

The corresponding *type-1 move* consists of modifying the incoming edges of β as shown here,

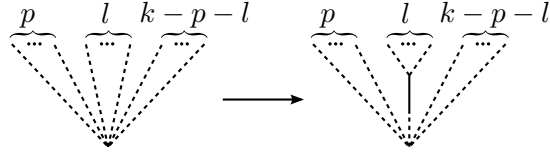

leaving T_s unchanged, and modifying f in the obvious way.

Type-2 moves: Fix $\alpha \in V(T_s)$. Choose a consecutive subset $(\gamma_{p+1}, \dots, \gamma_{p+l}) \subset (\gamma_1, \dots, \gamma_k) = \text{in}(\alpha)$ where l satisfies $2 \leq l < k$. For every $\tilde{\alpha} \in V_{\text{comp}}^{\geq 2}(T_b) \cap f^{-1}\{\alpha\}$ with $\text{in}(\tilde{\alpha}) =: (\beta_1, \dots, \beta_k)$ and for every i with $1 \leq i \leq l$, choose $q \geq 0$ and partition $\mathbf{a} := (\#\text{in}(\beta_{p+i}))_{i=1}^l$ as $\mathbf{a} = \sum_{j=1}^q \mathbf{b}^j$, for $\mathbf{b}^1, \dots, \mathbf{b}^q \in \mathbb{Z}^l \setminus \{\mathbf{0}\}$. The corresponding *type-2 move* consists of (a)

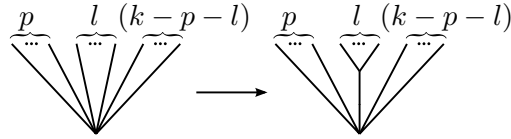

and (b) modifying the incoming edges of each $\tilde{\alpha}$ as shown here,

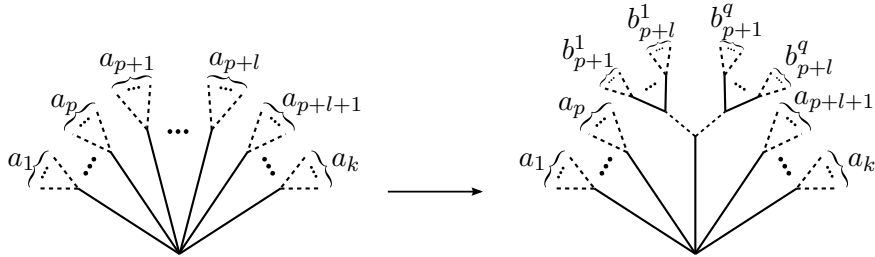

and modifying f in the obvious way.

Type-3 moves: Choose $\alpha \in V_{\text{comp}}^{\geq 2}(T_b)$, and write $\text{in}(\alpha) =: \{\beta_1, \dots, \beta_k\}$. Choose $q \geq 2$, and partition $\mathbf{a} := (\#\text{in}(\beta_i))_{i=1}^k$ as $\mathbf{a} = \sum_{j=1}^q \mathbf{b}^j$ for $\mathbf{b}^1, \dots, \mathbf{b}^q \in \mathbb{Z}^k \setminus \{\mathbf{0}\}$. The corresponding *type-3 move* consists of modifying the incoming edges of α as shown here,

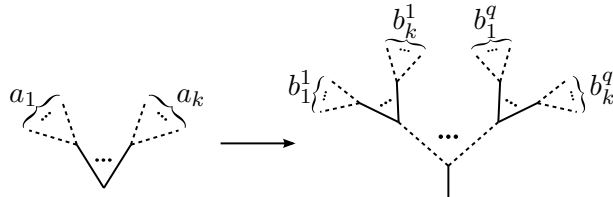

leaving T_s unchanged, and modifying f in the obvious way.

Lemma 3.5. *If $2T'$ is the result of making a move of type 1, 2, or 3 to $2T$, then $d(2T') = d(2T) - 1$.*

Proof. Recall the definition of d :

$$(20) \quad |\mathbf{n}| + r - \#V_{\text{comp}}^1(T_b) - \#(T_s)_{\text{int}} - 2.$$

- In a type-1 move, one 1-seam component forms (where the points collide) and T_s does not change.
- In a type-2 move, no new 1-seam components form; one new interior vertex in T_s forms.
- In a type-3 move, one 1-seam component forms (the former k -seam component) and the seam tree does not change.

□

Definition 3.6. Define $W_{\mathbf{n}}^{\text{tree}}$ as a poset by declaring $2T' < 2T$ if there is a finite sequence of moves that transforms $2T$ into $2T'$. The poset structure is well-defined by the same argument as in Def.-Lem. 2.8.

Lemma 3.7. *For any $n \geq 1$, there is a poset isomorphism $W_{\mathbf{n}}^{\text{tree}} \simeq K_n^{\text{tree}}$. There are also isomorphisms $W_{n,0}^{\text{tree}} \simeq J_n \simeq W_{0,n}^{\text{tree}}$, where J_n is the $(n-1)$ -dimensional multiplihedron.*

Proof. Define a map $W_n^{\text{tree}} \rightarrow K_n^{\text{tree}}$ like so: given a stable tree-pair $T_b \xrightarrow{f} T_s$, send it to the result of collapsing all the solid edges in T_b , then converting all the dashed edges to solid ones. A straightforward check shows that this map is well-defined and respects the partial order. An inverse $K_n^{\text{tree}} \rightarrow W_n^{\text{tree}}$ is given like so: given a stable RRT T , convert its edges to dashed ones, then insert a solid edge at every interior vertex. Here is an illustration of this correspondence, where the stable tree-pair on the left lies in W_6^{tree} and the RRT on the right lies in K_6^{tree} :

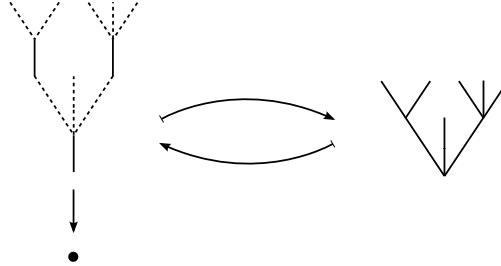

The identifications $W_{n,0}^{\text{tree}} \simeq J_n \simeq W_{0,n}^{\text{tree}}$ are explained in Rmk. 4.4 of version 2 of [BW]. □

Remark 3.8. There are also poset isomorphisms $W_{\underbrace{0, \dots, 0, 1, 0, \dots, 0}_n}$; we leave the details of these isomorphisms to the reader.

3.2. The poset $W_{\mathbf{n}}^{\text{br}}$ of 2-bracketings. We now define the notion of a 2-bracketing, which will allow us to define the model $W_{\mathbf{n}}^{\text{br}}$. These definitions are somewhat opaque, so we give some motivation after the definitions.

Definition 3.9. A *2-bracket* of \mathbf{n} is a pair $\mathbf{2B} = (B, (2B_i))$ consisting of a 1-bracket $B \subset \{1, \dots, r\}$ and a consecutive subset $2B_i \subset \{1, \dots, n_i\}$ for every $i \in B$ such that at least one $2B_i$ is nonempty. We write $\mathbf{2B}' \subset \mathbf{2B}$ if $B' \subset B$ and $2B'_i \subset 2B_i$ for every $i \in B'$, and we define $\pi(B, (2B_i)) := B$.

Definition 3.10. A *2-bracketing* of \mathbf{n} is a pair $(\mathcal{B}, 2\mathcal{B})$, where \mathcal{B} is a 1-bracketing of r and $2\mathcal{B}$ is a collection of 2-brackets of \mathbf{n} that satisfies these properties:

(1-BRACKETING) For every $\mathbf{2B} \in 2\mathcal{B}$, $\pi(\mathbf{2B})$ is contained in \mathcal{B} .

(2-BRACKETING) If $\mathbf{2B}, \mathbf{2B}' \in 2\mathcal{B}$ have the property that for some $i_0 \in \pi(\mathbf{2B}) \cap \pi(\mathbf{2B}')$ the intersection $2B_{i_0} \cap 2B'_{i_0}$ is nonempty, then either $\mathbf{2B} \subset \mathbf{2B}'$ or $\mathbf{2B}' \subset \mathbf{2B}$.

(ROOT AND MARKED POINTS) $2\mathcal{B}$ contains $(\{1, \dots, r\}, (\{1, \dots, n_1\}, \dots, \{1, \dots, n_r\}))$ and every 2-bracket of \mathbf{n} of the form $(\{i\}, (\{j\}))$.

For any $B_0 \in \mathcal{B}$, write $2\mathcal{B}_{B_0} := \{(B, (2B_i)) \in 2\mathcal{B} \mid B = B_0\}$.

(MARKED SEAMS ARE UNFUSED)

- For any $B_0 \in \mathcal{B}$ and for any $i \in B_0$, we have $\bigcup_{\mathbf{2B} \in 2\mathcal{B}_{B_0}} 2B_i = \{1, \dots, n_i\}$.
- For every $\mathbf{2B} \in 2\mathcal{B}_{B_0}$ for which there exists $\mathbf{2B}' \in 2\mathcal{B}_{B_0}$ with $\mathbf{2B}' \subsetneq \mathbf{2B}$, and for every $i \in B_0$ and $j \in 2B_i$, there exists $\mathbf{2B}'' \in 2\mathcal{B}_{B_0}$ with $\mathbf{2B}'' \subsetneq \mathbf{2B}$ and $2B''_i \ni j$.

(PARTIAL ORDER) For every $B_0 \in \mathcal{B}$, $2\mathcal{B}_{B_0}$ is endowed with a partial order with the following properties:

- $\mathbf{2B}, \mathbf{2B}' \in 2\mathcal{B}_{B_0}$ are comparable if and only if $2B_i \cap 2B'_i = \emptyset$ for every $i \in B_0$.
- For any i and $j < j'$, we have $(\{i\}, (\{j\})) < (\{i\}, (\{j'\}))$.
- For any 2-brackets $\mathbf{2B}^j \in 2\mathcal{B}_{B_0}$, $\widetilde{\mathbf{2B}}^j \in 2\mathcal{B}_{\widetilde{B}_0}$, $j \in \{1, 2\}$ with $\widetilde{\mathbf{2B}}^j \subset \mathbf{2B}^j$, we have the implication

$$(21) \quad \mathbf{2B}^1 < \mathbf{2B}^2 \implies \widetilde{\mathbf{2B}}^1 < \widetilde{\mathbf{2B}}^2.$$

We define $W_{\mathbf{n}}^{\text{br}}$ to be the set of 2-bracketings of \mathbf{n} , with the poset structure defined by declaring $(\mathcal{B}', 2\mathcal{B}') < (\mathcal{B}, 2\mathcal{B})$ if containments $\mathcal{B}' \subset 2\mathcal{B}$, $2\mathcal{B}' \subset 2\mathcal{B}$ hold and at least one of these containments is proper.

Remark 3.11 (Motivation for the definition of 2-bracketings). Recall from §1.1 that a 2-bracketing is intended to indicate the bubbling structure of a nodal witch curve. That is, the 1-bracketing \mathcal{B} indicates how the seams have collided; each 2-bracket $\mathbf{2B} \in 2\mathcal{B}$ corresponds to a bubble in the nodal witch curve, with $\pi(\mathbf{2B})$ indicating the seams present on the bubble and the fashion in which these seams have collided, and $2B_i$ indicating the marked points which appear on the i -th seam and which are either on the present bubble or appear above this bubble (i.e., further from the main component). The properties (1-BRACKETING), (2-BRACKETING), and (ROOT AND MARKED POINTS) are straightforward enough: (1-BRACKETING) says that the collisions of seams on the various bubbles in the tree are controlled by a single 1-bracketing; (2-BRACKETING) says that if a single marked point appears above two different bubbles, then one of these bubbles must be above the other; and (ROOT AND MARKED POINTS) is a consequence of the fact that the root corresponds to the 2-bracket $(\{1, \dots, r\}, (\{1, \dots, n_1\}, \dots, \{1, \dots, n_r\}))$ and that the j -th marked point on the i -th seam corresponds to the 2-bracket $(\{i\}, (\{j\}))$. (MARKED SEAMS ARE UNFUSED) guarantees that marked points may only appear on unfused seams, which is a result of the fact that in our putative compactification $\overline{2\mathcal{M}}_{\mathbf{n}}$, when a collection of seams collide, wherever there is a marked point at the instant of this collision, a bubble must form. Finally, (PARTIAL ORDER) reflects the fact that in a bubble tree, on each seam of each bubble there is an ordering of the marked and nodal points.

3.3. We prove that $W_{\mathbf{n}}^{\text{tree}}, W_{\mathbf{n}}^{\text{br}}$ coincide.

Definition 3.12. Fix a stable tree-pair $2T = T_b \xrightarrow{f} T_s \in W_{\mathbf{n}}^{\text{tree}}$. A $2T$ -bracket is a 2-bracket $\mathbf{2B} = (B, (2B_i))$ of \mathbf{n} with the property that for some $\alpha \in V_{\text{comp}}(T_b) \sqcup V_{\text{mark}}(T_b)$, we have

$$(22) \quad B = B(f(\alpha)), \quad 2B_i = \{j \mid \mu_{ij}^{T_b} \in (T_s)_\alpha\}.$$

We denote this bracket by $\mathbf{2B}(\alpha) = (B(f(\alpha)), (2B_i(\alpha)))$.

Note that (STABILITY) implies that $\alpha \in V_{\text{comp}}(T_b) \sqcup V_{\text{mark}}(T_b)$ is uniquely determined by $\mathbf{2B}(\alpha)$. We denote the vertex corresponding to $\mathbf{2B}$ by $\alpha(\mathbf{2B})$.

Definition-Lemma 3.13. Define a map $2\nu: W_{\mathbf{n}}^{\text{tree}} \rightarrow W_{\mathbf{n}}^{\text{br}}$ to send a stable tree-pair $2T = T_b \xrightarrow{f} T_s$ to $(\mathcal{B}(2T), 2\mathcal{B}(2T))$, where $\mathcal{B}(2T) := \nu(T_s)$ and where $2\mathcal{B}(2T)$ is the set of $2T$ -brackets, with the partial order on $2\mathcal{B}(2T)_{B(\beta)}$, $\beta \in T_s$ is defined like so: fix $\tilde{\beta}_1, \tilde{\beta}_2 \in (V_{\text{comp}}(T_b) \sqcup V_{\text{mark}}(T_b)) \cap f^{-1}\{\beta\}$. If $\mathbf{2B}(\tilde{\beta}_1), \mathbf{2B}(\tilde{\beta}_2)$ have $2B_i(\tilde{\beta}_1) \cap 2B_i(\tilde{\beta}_2) \neq \emptyset$ for some $i \in B(\beta)$, then define $\mathbf{2B}(\tilde{\beta}_1), \mathbf{2B}(\tilde{\beta}_2)$ to be incomparable. Otherwise, define

$$(23) \quad \gamma := \alpha(\alpha_{\text{root}, T_b}, \tilde{\beta}_1, \tilde{\beta}_2) := [\alpha_{\text{root}, T_b}, \tilde{\beta}_1] \cap [\tilde{\beta}_1, \tilde{\beta}_2] \cap [\tilde{\beta}_2, \alpha_{\text{root}, T_b}] \in V_{\text{seam}}(T_b)$$

as in §D.2, [MS], and for $j \in \{1, 2\}$, define δ_j to be the element of $\text{in}(\gamma)$ with $\tilde{\beta}_j \in (T_b)_{\gamma\delta_j}$. Now define the order on $\mathbf{2B}(\tilde{\beta}_1), \mathbf{2B}(\tilde{\beta}_2) \in 2\mathcal{B}(2T)_{S(\beta)}$ like so:

- if $\delta_1 <_{\gamma} \delta_2$, then $\mathbf{2B}(\tilde{\beta}_1) < \mathbf{2B}(\tilde{\beta}_2)$;
- if $\delta_2 <_{\gamma} \delta_1$, then $\mathbf{2B}(\tilde{\beta}_2) < \mathbf{2B}(\tilde{\beta}_1)$.

Then 2ν is bijective.

Proof. Throughout this proof we assume $\mathbf{n} \neq (1)$, since in this case the bijectivity of 2ν holds trivially.

Step 1: If T is an RRT and β_1, β_2 are any distinct non-root vertices, then

$$(24) \quad \gamma := \alpha(\alpha_{\text{root}}, \beta_1, \beta_2) := [\alpha_{\text{root}}, \beta_1] \cap [\beta_1, \beta_2] \cap [\beta_2, \alpha_{\text{root}}]$$

is the node furthest from the root satisfying $\beta_1, \beta_2 \in T_{\gamma}$.

Define Σ to consist of those vertices δ of T satisfying $\beta_1, \beta_2 \in T_{\delta}$. The inclusion $\gamma \in [\alpha_{\text{root}}, \beta_j]$ for $j \in \{1, 2\}$ implies $\beta_j \in T_{\gamma}$, so γ is an element of Σ . Any two elements $\delta_1, \delta_2 \in \Sigma$ have the property that either $\delta_1 \in [\delta_2, \alpha_{\text{root}}]$ or $\delta_2 \in [\delta_1, \alpha_{\text{root}}]$, since both δ_1 and δ_2 lie in $[\alpha_{\text{root}}, \beta_1]$. Suppose that δ_1, δ_2 are distinct elements of Σ and that δ_1 lies in $[\delta_2, \alpha_{\text{root}}]$. Since β_1, β_2 lie in T_{δ_1} and δ_1 lies in $[\delta_2, \alpha_{\text{root}}]$, any path from β_1 to β_2 that passes through δ_1 must pass through δ_2 more than once; therefore δ_1 does not lie in $[\beta_1, \beta_2]$, which implies $\gamma \neq \delta_1$. It follows that γ is the (unique) element of Σ that is furthest from the root.

Step 2: If $2T$ is a stable tree-pair of type \mathbf{n} , then $2\nu(2T)$ is a 2-bracketing of \mathbf{n} .

As discussed in the proof of Prop. 2.12, $\mathcal{B}(2T) = \nu(T_s)$ is a 1-bracketing of r . For any $(B, (2B_i)) \in 2\mathcal{B}(2T)$, it is clear that for every i , $2B_i \subset \{1, \dots, n_i\}$ is consecutive. The (STABILITY) axiom implies that there exists i for which $2B_i$ is nonempty, so every element of $2\mathcal{B}(2T)$ is a 2-bracket.

Next, we justify two implicit assertions in the definition of $(\mathcal{B}(2T), 2\mathcal{B}(2T))$. Specifically, we implicitly asserted (1) that for $\beta \in V_{\text{int}}(T_s)$ and $\tilde{\beta}_1, \tilde{\beta}_2 \in (V_{\text{comp}}(T_b) \sqcup V_{\text{mark}}(T_b)) \cap f^{-1}\{\beta\}$ with the property that $2B_i(\tilde{\beta}_1) \cap 2B_i(\tilde{\beta}_2) = \emptyset$ for every $i \in B(\beta)$, $\gamma := \alpha(\alpha_{\text{root}, T_b}, \tilde{\beta}_1, \tilde{\beta}_2)$ lies in $V_{\text{seam}}(T_b)$; and (2) that we have defined a partial order on every $2\mathcal{B}(2T)_{B(\beta)}$.

- (1) Suppose for a contradiction that $\gamma \in V_{\text{comp}}(T_b) \sqcup V_{\text{mark}}(T_b)$, and recall from Step 1 that γ can be interpreted as the node furthest from the root with $\tilde{\beta}_1, \tilde{\beta}_2 \in (T_b)_{\gamma}$. The assumption on $\tilde{\beta}_1, \tilde{\beta}_2$ implies that they are not the same vertex, hence γ cannot lie in $V_{\text{mark}}(T_b)$; therefore $\gamma \in V_{\text{comp}}(T_b)$. For $j \in \{1, 2\}$, define ϵ_j to be the element of $\text{in}(\gamma)$ with $\tilde{\beta}_j \in (T_b)_{\gamma\epsilon_j}$. By the definition of γ , ϵ_1 and ϵ_2 cannot coincide. In particular, $\#\text{in}(\gamma) \geq 2$, so f must map the incoming edges of γ bijectively onto the incoming edges of $f(\gamma)$. Therefore $f(\epsilon_1)$ and $f(\epsilon_2)$ are distinct elements of $\text{in}(f(\gamma))$. A given edge in T_b is either contracted by f or mapped to an edge in an orientation-preserving fashion, so we must have $f(\tilde{\beta}_1) \neq f(\tilde{\beta}_2)$,

in contradiction to the assumption $f(\tilde{\beta}_1) = \beta = f(\tilde{\beta}_2)$. Therefore our implicit assertion $\gamma \in V_{\text{seam}}(T_b)$ was justified.

- (2) If $2B_i(\tilde{\beta}_1) \cap 2B_i(\tilde{\beta}_2) = \emptyset$ for every $i \in B(\beta)$, then $\tilde{\beta}_1$ and $\tilde{\beta}_2$ must be distinct; therefore our relation is antireflexive. Next, fix $\tilde{\beta}_1, \tilde{\beta}_2, \tilde{\beta}_3$ with $\mathbf{2B}(\tilde{\beta}_1) < \mathbf{2B}(\tilde{\beta}_2)$ and $\mathbf{2B}(\tilde{\beta}_2) < \mathbf{2B}(\tilde{\beta}_3)$. Define

$$(25) \quad \gamma_{ij} := \alpha(\alpha_{\text{root}, T_b}, \tilde{\beta}_i, \tilde{\beta}_j), \quad i, j \in \{1, 2, 3\}.$$

Then we have either (a) $\gamma_{13} = \gamma_{12}$ and $\gamma_{23} \in (T_b)_{\gamma_{13}}$ or (b) $\gamma_{13} = \gamma_{23}$ and $\gamma_{12} \in (T_b)_{\gamma_{13}}$. (Indeed, γ_{12} and γ_{23} are both in $[\tilde{\beta}_2, \alpha_{\text{root}, T_b}]$, so either $\gamma_{12} \in (T_b)_{\gamma_{23}}$ or $\gamma_{23} \in (T_b)_{\gamma_{12}}$. If, for instance, $\gamma_{12} \in (T_b)_{\gamma_{23}}$, then $\tilde{\beta}_1, \tilde{\beta}_3 \in (T_b)_{\gamma_{23}}$; moreover, γ_{23} is the furthest vertex from the root with this property: if there exists $\zeta \in \text{in}(\gamma_{23})$ such that $(T_b)_\zeta$ contains $\tilde{\beta}_1$ and $\tilde{\beta}_3$, then $(T_b)_\zeta$ also contains γ_{12} and therefore $\tilde{\beta}_2$, contradicting the fact that ϵ is the furthest vertex from the root with $\tilde{\beta}_1, \tilde{\beta}_3 \in (T_b)_\epsilon$.) Suppose (a) holds. If $\gamma_{12} = \gamma_{13} = \gamma_{23}$, then there are $\delta_1, \delta_2, \delta_3 \in \text{in}(\gamma_{13})$ with $\tilde{\beta}_j \in (T_b)_{\delta_j}$ for all j . By hypothesis, $\delta_1 <_{\gamma_{13}} \delta_2$ and $\delta_2 <_{\gamma_{13}} \delta_3$, hence $\delta_1 <_{\gamma_{13}} \delta_3$, hence $\mathbf{2B}(\tilde{\beta}_1) < \mathbf{2B}(\tilde{\beta}_3)$ as desired. On the other hand, suppose (a) holds and $\gamma_{23} \in (T_b)_{\gamma_{13}} \setminus \gamma_{13}$. Define $\delta_1, \delta_{23} \in \text{in}(\gamma_{13})$ by $\tilde{\beta}_1 \in (T_b)_{\delta_1}$, $\gamma_{23} \in (T_b)_{\delta_{23}}$. The hypothesis $\mathbf{2B}(\tilde{\beta}_1) < \mathbf{2B}(\tilde{\beta}_2)$ implies $\delta_1 <_{\gamma_{13}} \delta_{23}$, hence $\mathbf{2B}(\tilde{\beta}_1) < \mathbf{2B}(\tilde{\beta}_3)$ as desired. A similar argument applies if (b) holds, so our putative partial order is transitive.

Finally, we verify the axioms of a 2-bracketing.

(1-BRACKETING) Fix $\mathbf{2B} = (B, (2B_i)) \in 2\mathcal{B}(2T)$. Then $\alpha(\mathbf{2B}) \in V_{\text{comp}}(T_b)$ has the property that B is the set of indices of incoming leaves of $f(\alpha)$, which in turn is a 1-bracket in $\mathcal{B}(2T)$; therefore $B \in \mathcal{B}(2T)$.

(2-BRACKETING) Suppose that $\mathbf{2B}, \mathbf{2B}' \in 2\mathcal{B}(2T)$ have the property that for some $i_0 \in B \cap B'$, $2B_{i_0} \cap 2B'_{i_0} \neq \emptyset$, and denote $\alpha := \alpha(\mathbf{2B}), \alpha' := \alpha(\mathbf{2B}')$. Choose $j \in 2B_{i_0} \cap 2B'_{i_0}$. By assumption, the path from $\mu_{ij}^{T_b}$ to $\alpha_{\text{root}, T_b}$ passes through both α and α' , so we must either have $\alpha \in (T_b)_{\alpha'}$ or $\alpha' \in (T_b)_\alpha$. In the first case we must have $\mathbf{2B} \subset \mathbf{2B}'$, and similarly in the second case.

(ROOT AND MARKED POINTS) Since $f(\alpha_{\text{root}, T_b}) = \alpha_{\text{root}, T_s}$, the 2-bracket corresponding to $\alpha_{\text{root}, T_b}$ is $(\{1, \dots, r\}, (\{1, \dots, n_1\}, \dots, \{1, \dots, n_r\}))$. On the other hand, the 2-bracket corresponding to $\mu_{ij}^{T_b}$ is $(\{i\}, (\{j\}))$.

(MARKED SEAMS ARE UNFUSED)

- Fix $\rho \in T_s$, $i \in B(\rho)$, and $j \in \{1, \dots, n_i\}$; we must produce $\alpha_0 \in V_{\text{comp}}(T_b) \cap f^{-1}\{\rho\}$ with $2B_i(\alpha_0) \ni j$. Choose a path from $\mu_{ij}^{T_b}$ to $\alpha_{\text{root}, T_b}$. By examining the image of this path in T_s , we see that some element in the path must lie in $V_{\text{comp}}(T_b) \cap f^{-1}\{\rho\}$, and we can define α_0 to be this element.
- Fix $B(\rho) \in \mathcal{B}(2T)$; $\mathbf{2B}(\alpha), \mathbf{2B}(\alpha') \in 2\mathcal{B}(2T)_{B(\rho)}$ with $\mathbf{2B}(\alpha') \subsetneq \mathbf{2B}(\alpha)$; $i \in B(\rho)$; and $j \in 2B_i(\alpha) \setminus 2B_i(\alpha')$. We must produce $\mathbf{2B}(\alpha'') \in 2\mathcal{B}_{B(\rho)}$ with $\mathbf{2B}(\alpha'') \subsetneq \mathbf{2B}(\alpha)$ and $2B_i(\alpha'') \ni j$. The existence of j implies $2B_i(\alpha') \subsetneq 2B_i(\alpha)$; this, together with the inclusions $\mathbf{2B}(\alpha), \mathbf{2B}(\alpha') \in 2\mathcal{B}(2T)_{B(\rho)}$, imply $\alpha \in V_{\text{comp}}^1(T_b)$. Denote the incoming neighbor of α by β ; we may now choose $\alpha'' \in \text{in}(\beta)$ to have the property that $(T_b)_{\alpha''}$ includes $\mu_{ij}^{T_b}$.

(PARTIAL ORDER) Earlier we endowed every $2\mathcal{B}_{B(\beta)}, \alpha \in T_s$ with a partial order.

- It is an immediate consequence of our definition of the partial order on $2\mathcal{B}_{B(\beta)}$ that $\mathbf{2B}(\tilde{\beta}_1), \mathbf{2B}(\tilde{\beta}_2)$ are comparable if and only if $2B_i \cap 2B'_i = \emptyset$ for every $i \in B(\beta)$.

- For any $i \in \{1, \dots, r\}$ and j, j' with $1 \leq j < j' \leq n_i$, it is clear that $(i, (\{j\})) < (i, (\{j'\}))$ in the partial order on $2\mathcal{B}(2T)_{\{i\}}$.
- Fix $\mathbf{2B}(\alpha^j) \in 2\mathcal{B}(2T)_{B(\rho)}$, $\mathbf{2B}(\tilde{\alpha}^j) \in 2\mathcal{B}(2T)_{B(\tilde{\rho})}$ for $j \in \{1, 2\}$ with $\mathbf{2B}(\tilde{\alpha}^j) \subset \mathbf{2B}(\alpha^j)$ and $\mathbf{2B}(\alpha^1) < \mathbf{2B}(\alpha^2)$. We must show $\mathbf{2B}(\tilde{\alpha}^1) < \mathbf{2B}(\tilde{\alpha}^2)$. The inclusions $\mathbf{2B}(\tilde{\alpha}^j) \subset \mathbf{2B}(\alpha^j)$ for $j \in \{1, 2\}$ are equivalent to the inclusions $\tilde{\alpha}^j \in (T_b)_{\alpha^j}$. From this it is easy to see that $\mathbf{2B}(\tilde{\alpha}^1) < \mathbf{2B}(\tilde{\alpha}^2)$.

Step 3: We define a putative inverse $2\tau: W_{\mathbf{n}}^{\text{br}} \rightarrow W_{\mathbf{n}}^{\text{tree}}$.

Fix $(\mathcal{B}, 2\mathcal{B}) \in W_{\mathbf{n}}^{\text{br}}$. Define $T_s := \tau(\mathcal{B})$. Towards the definition of T_b , define the following sets:

$$(26) \quad V_{\text{mark}} := \left\{ (\{i\}, (\{j\})) \mid \begin{array}{l} 1 \leq i \leq r \\ 1 \leq j \leq n_i \end{array} \right\} \ni \mu_{ij}^{T_b}, \quad V_{\text{comp}} := 2\mathcal{B} \setminus V_{\text{mark}} \ni \alpha_{\mathbf{2B}, \text{comp}},$$

$$V_{\text{seam}} := V_{\text{seam},1} \sqcup V_{\text{seam}}^{\geq 2}, \quad V_{\text{seam},1} := \{ \mathbf{2B} \in 2\mathcal{B} \mid \exists \mathbf{2B}' \in 2\mathcal{B}_{\pi(\mathbf{2B})}: \mathbf{2B}' \subsetneq \mathbf{2B} \} \ni \alpha_{\mathbf{2B}, \pi(\mathbf{2B}), \text{seam}},$$

$$V_{\text{seam}}^{\geq 2} := \left\{ (\mathbf{2B}, B') \in 2\mathcal{B} \times \mathcal{B} \mid \begin{array}{l} \nexists \mathbf{2B}'' \in 2\mathcal{B}_{\pi(\mathbf{2B})}: \mathbf{2B}'' \subsetneq \mathbf{2B} \\ B' \subsetneq \pi(\mathbf{2B}), \nexists B'' \in \mathcal{B}: B' \subsetneq B'' \subsetneq \pi(\mathbf{2B}) \end{array} \right\} \ni \alpha_{\mathbf{2B}, B', \text{seam}}.$$

Now define the vertices and incoming neighbors in T_b by

$$(27) \quad V := V_{\text{comp}} \sqcup V_{\text{seam}} \sqcup V_{\text{mark}}, \quad \alpha_{\text{root}} := \alpha(\{1, \dots, r\}, \{1, \dots, n_1\}, \dots, \{1, \dots, n_r\}), \text{comp},$$

$$\text{in}(\mu_{ij}^{T_b}) := \emptyset, \quad \text{in}(\alpha_{\mathbf{2B}, \text{comp}}) := \left\{ \begin{array}{l} \{ \alpha_{\mathbf{2B}, \pi(\mathbf{2B}), \text{seam}} \}, \quad \exists \mathbf{2B}' \in 2\mathcal{B}_{\pi(\mathbf{2B})}: \mathbf{2B}' \subsetneq \mathbf{2B}, \\ \{ \alpha_{\mathbf{2B}, B', \text{seam}} \mid \begin{array}{l} B' \subsetneq \pi(\mathbf{2B}) \\ \nexists B'' \in \mathcal{B}: B' \subsetneq B'' \subsetneq \pi(\mathbf{2B}) \end{array} \}, \quad \text{otherwise,} \end{array} \right.$$

$$\text{in}(\alpha_{\mathbf{2B}, B', \text{seam}}) := \left\{ \alpha_{\mathbf{2B}'', \text{comp}} \mid \begin{array}{l} \pi(\mathbf{2B}'') = B', \mathbf{2B}'' \subsetneq \mathbf{2B}, \\ \nexists \mathbf{2B}''' \in 2\mathcal{B}: \mathbf{2B}'' \subsetneq \mathbf{2B}''' \subsetneq \mathbf{2B} \end{array} \right\} \cup$$

$$\cup \left\{ \mu_{ij}^{T_b} \mid \begin{array}{l} B' = \{i\}, (\{i\}, (\{j\})) \subsetneq \mathbf{2B}, \\ \nexists \mathbf{2B}'' \in 2\mathcal{B}: (\{i\}, (\{j\})) \subsetneq \mathbf{2B}'' \subsetneq \mathbf{2B} \end{array} \right\},$$

where the incoming edges of $\alpha_{\mathbf{2B}, \text{comp}}$ are solid and the incoming edges of $\alpha_{\mathbf{2B}, B', \text{seam}}$ are dashed. For $\alpha_{\mathbf{2B}, \text{comp}}$ for which there does not exist $\mathbf{2B}' \in 2\mathcal{B}_{\pi(\mathbf{2B})}$ with $\mathbf{2B}' \subsetneq \mathbf{2B}$, order the incoming neighbors $\left\{ \alpha_{\mathbf{2B}, B', \text{seam}} \mid \begin{array}{l} B' \subsetneq \pi(\mathbf{2B}) \\ \nexists B'' \in \mathcal{B}: B' \subsetneq B'' \subsetneq \pi(\mathbf{2B}) \end{array} \right\}$ according to the order on the incoming neighbors of $\pi(\mathbf{2B})$ in $T_s = \tau(\mathcal{B})$. For $\alpha_{\mathbf{2B}, B', \text{seam}}$, order the incoming neighbors according to the partial order on $2\mathcal{B}_{\pi(\mathbf{2B})}$. Finally, define $f: T_b \rightarrow T_s$ like so:

$$(28) \quad f(\mu_{ij}^{T_b}) := \lambda_i^{T_s}, \quad f(\alpha_{\mathbf{2B}, \text{comp}}) := \alpha(\pi(\mathbf{2B})), \quad f(\alpha_{\mathbf{2B}, B', \text{seam}}) := \alpha(B').$$

There are a number of things we have to check in order to verify that $T_b \xrightarrow{f} T_s$ is a stable tree-pair. For (27) to define a RRT via Lemma 2.3, we must check conditions (1–3) in the statement of that lemma.

- (1) It is clear that no $\text{in}(\alpha)$ can contain α_{root} .
- (2) Fix a non-root vertex α in T_b . Depending on which type of vertex α is, we check that there exists a unique β with $\text{in}(\beta) \ni \alpha$:
 - $\alpha = \mu_{ij}^{\mathbf{T}^b}$. The vertices β with $\text{in}(\beta) \ni \mu_{ij}^{\mathbf{T}^b}$ are exactly those $\alpha_{\mathbf{2B}, \{i\}, \text{seam}}$ with $\mathbf{2B}$ satisfying these properties:
 - (a) $(i, (\{j\})) \subsetneq \mathbf{2B}$;
 - (b) either $\pi(\mathbf{2B}) = \{i\}$, or $\pi(\mathbf{2B}) \supset \{i\}$ and no $B'' \in \mathcal{B}$ has $\{i\} \subsetneq B'' \subsetneq \pi(\mathbf{2B})$;
 - (c) no $\mathbf{2B}'' \ni 2\mathcal{B}$ has $(i, (\{j\})) \subsetneq \mathbf{2B}'' \subsetneq \mathbf{2B}$.

Define Σ to consist of those $\mathbf{2B} \in 2\mathcal{B}$ that properly contain $(i, (\{j\}))$, and order Σ by inclusion. Since α is not the root, Σ contains α_{root} and is therefore not empty; by

the (2-BRACKETING) property of 2-bracketings, any two elements of Σ are comparable under inclusion. Therefore Σ has a unique minimal element $\mathbf{2B}^0$.

I claim that $\mathbf{2B}^0$ is the unique element of $2\mathcal{B}$ satisfying (a–c). Indeed, it is clear from its definition that $\mathbf{2B}^0$ satisfies (a) and (c). If $\mathbf{2B}$ does not satisfy (b), then there exists $B'' \in \mathcal{B}$ with $\{i\} \subsetneq B'' \subsetneq \pi(\mathbf{2B}^0)$. By the (MARKED SEAMS ARE UNFUSED) property of 2-bracketings, there exists $\mathbf{2B}'' \in 2\mathcal{B}$ with $\pi(\mathbf{2B}'') = B''$ and $\mathbf{2B}''_i \ni j$. This 2-bracket satisfies $(i, (\{j\})) \subsetneq \mathbf{2B}'' \subsetneq \mathbf{2B}^0$, which contradicts the definition of $\mathbf{2B}$; therefore $\mathbf{2B}$ satisfies (b). On the other hand, suppose that $\mathbf{2B}$ satisfies (a–c). (a) implies that $\mathbf{2B}$ lies in Σ , and (c) implies that $\mathbf{2B}$ is in fact the minimal element of Σ ; therefore $\mathbf{2B} = \mathbf{2B}_0$. We may conclude that $\beta := \alpha_{\mathbf{2B}, \{i\}, \text{seam}}$ is the unique vertex in T_b with $\text{in}(\beta) \ni \alpha$.

- $\alpha = \alpha_{\mathbf{2B}, \text{comp}}$. An argument similar to the one used in the case $\alpha = \mu_{ij}^{T_b}$ shows that there is a unique β with $\text{in}(\beta) \ni \alpha$.

- $\alpha = \alpha_{\mathbf{2B}, B', \text{seam}}$. If there exists $\mathbf{2B}' \in 2\mathcal{B}_{\pi(\mathbf{2B})}$ with $\mathbf{2B}' \subsetneq \mathbf{2B}$, then $\alpha \in V_{\text{seam}, 1}$ and $B' = \pi(\mathbf{2B})$. Therefore $\beta := \alpha_{\mathbf{2B}, \text{comp}}$ is the unique vertex with $\text{in}(\beta) \ni \alpha$.

On the other hand, suppose that there does not exist such a $\mathbf{2B}'$. Then $\alpha \in V_{\text{seam}}^{\geq 2}$, and $\beta := \alpha_{\mathbf{2B}, \text{comp}}$ is the unique vertex with $\text{in}(\beta) \ni \alpha$.

- (3) Suppose that $\alpha_1, \dots, \alpha_\ell \in V$ has $\ell \geq 2$ and $\alpha_j \in \text{in}(\alpha_{j+1})$ for every j . It is clear from our verification of (2) that α_1 is not the same as α_ℓ .

Now that we have shown that T_b is well-defined as an RRT, we check the rest of the requirements on $T_b \xrightarrow{f} T_s$.

- – We have defined V as the union $V = V_{\text{comp}} \sqcup V_{\text{seam}} \sqcup V_{\text{mark}}$, and the incoming and outgoing edges of the vertices are clearly the necessary type. It is not hard to see that $\alpha_{\mathbf{2B}, \text{comp}} \in V_{\text{comp}}$ has at least one incoming edge: if there exists $\mathbf{2B}' \in 2\mathcal{B}_{\pi(\mathbf{2B})}$ with $\mathbf{2B}' \subsetneq \mathbf{2B}$, then $\#\text{in}(\alpha_{\mathbf{2B}, \text{comp}}) = 1$. Next, suppose that there is no such $\mathbf{2B}'$. The incoming vertices of $\alpha_{\mathbf{2B}, \text{comp}}$ are in correspondence with maximal elements of Σ , where Σ consists of those elements B' of \mathcal{B} with $B' \subsetneq \pi(\mathbf{2B})$. It follows from the (ROOT AND LEAVES) property of 1-bracketings that $\#\text{in}(\alpha_{\mathbf{2B}, \text{comp}}) \geq 2$.
- (STABILITY) Fix $\alpha = \alpha_{\mathbf{2B}, \text{comp}} \in V_{\text{comp}}^1$. Its unique incoming neighbor is $\beta := \alpha_{\mathbf{2B}, \pi(\mathbf{2B}), \text{seam}}$. We must show that β has at least 2 incoming neighbors. The incoming neighbors of β are in correspondence with the maximal elements of the set Σ of $\mathbf{2B}'' \in 2\mathcal{B}_{\pi(\mathbf{2B})}$ with $\mathbf{2B}'' \subsetneq \mathbf{2B}$. The fact that $\alpha_{\mathbf{2B}, \text{comp}}$ lies in $V_{\text{comp}, 1}$ implies that Σ is nonempty. Choose $\mathbf{2B}^1$ to be any maximal element of Σ . Now choose any i, j with the property that $\mathbf{2B}_i \setminus \widetilde{\mathbf{2B}}_i$ contains j . Define Σ' to consist of those $\mathbf{2B}'' \in \Sigma$ with $\mathbf{2B}''_i \ni j$. By (MARKED SEAMS ARE UNFUSED), Σ' is nonempty; choose $\mathbf{2B}^2$ to be any maximal element of Σ' . Then $\mathbf{2B}^1, \mathbf{2B}^2$ are distinct maximal elements of Σ . This shows that β has at least 2 incoming neighbors.

On the other hand, suppose that $\alpha = \alpha_{\mathbf{2B}, \text{comp}}$ lies in $V_{\text{comp}}^{\geq 2}$. The incoming neighbors of α are in correspondence with maximal elements of the set Σ of $B' \in \mathcal{B}$ with $B' \subsetneq \pi(\mathbf{2B})$. Write $\mathbf{2B} = (B, (2B_i))$. Not every $2B_i$ can be empty, so we may choose i, j with the property that $2B_i$ contains j . Define Σ' to be the set of 1-brackets $B' \in \mathcal{B}$ with $\{i\} \subset B' \subsetneq \pi(\mathbf{2B})$. Σ' contains $\{i\}$, hence is nonempty; define B^1 to be a maximal element of Σ' (in fact, this determines B_0 uniquely). Now define Σ'' to be the set of 2-brackets $\mathbf{2B}'' \in 2\mathcal{B}_{B^1}$ with $(i, (\{j\})) \subset \mathbf{2B}'' \subsetneq \mathbf{2B}$. Σ'' contains $(i, (\{j\}))$, hence is nonempty; define $\mathbf{2B}^2$ to be a maximal element of Σ'' . Then $\alpha = \alpha_{\mathbf{2B}, \text{comp}}$ has $\beta := \alpha_{\mathbf{2B}, B^0, \text{seam}}$ as an incoming neighbor, and β has $\alpha_{\mathbf{2B}^2, \text{comp}}$ as an incoming neighbor.

- By Prop. 2.12, T_s is an element of K_r^{tree} .
- It is clear that f satisfies the necessary properties.

Step 4: We verify that 2ν and 2τ are inverse to one another.

This can be shown by an argument similar to the one made in the proof of Prop. 2.12 to show that ν and τ are inverse to one another. \square

Lemma 3.14. *The partial order on $W_{\mathbf{n}}^{\text{br}}$ coincides with the one induced by the partial order on $W_{\mathbf{n}}^{\text{tree}}$ and the isomorphism $2\nu: W_{\mathbf{n}}^{\text{tree}} \rightarrow W_{\mathbf{n}}^{\text{br}}$.*

Proof. The nontrivial direction is to show that for $(\mathcal{B}^1, 2\mathcal{B}^1) \subsetneq (\mathcal{B}^2, 2\mathcal{B}^2)$, we can obtain $(\mathcal{B}^2, 2\mathcal{B}^2)$ from $(\mathcal{B}^1, 2\mathcal{B}^1)$ via a finite sequence of moves. It is enough to show that there is a 2-bracketing $(\mathcal{B}, 2\mathcal{B}) \in W_{\mathbf{n}}^{\text{br}}$ satisfying the containments

$$(29) \quad (\mathcal{B}^1, 2\mathcal{B}^1) \subset (\mathcal{B}, 2\mathcal{B}) \subset (\mathcal{B}^2, 2\mathcal{B}^2),$$

and such that either $(\mathcal{B}, 2\mathcal{B})$ is the result of performing a single move on $(\mathcal{B}^1, 2\mathcal{B}^1)$, or $(\mathcal{B}^2, 2\mathcal{B}^2)$ is the result of performing a single move on $(\mathcal{B}, 2\mathcal{B})$. We produce such a 2-bracketing in the following, exhaustive, cases.

Case 1: There exist $B^0 \in \mathcal{B}^1$ and $2\mathbf{B} \in 2\mathcal{B}_{B^0}^2 \setminus 2\mathcal{B}_{B^0}^1$, $2\mathbf{B}' \in 2\mathcal{B}_{B^0}^2$ with $2\mathbf{B}' \subsetneq 2\mathbf{B}$. We claim that $(\mathcal{B}^2, 2\mathcal{B}^2 \setminus \{2\mathbf{B}\})$ is a valid 2-bracketing. The only property that does not obviously hold is (MARKED SEAMS ARE UNFUSED). This is a consequence of the fact that $(\mathcal{B}^2, 2\mathcal{B}^2)$ has the (MARKED SEAMS ARE UNFUSED) property. $(\mathcal{B}^2, 2\mathcal{B}^2)$ is the result of performing a type-1 move on $(\mathcal{B}^2, 2\mathcal{B}^2 \setminus \{2\mathbf{B}\})$, and the necessary containments hold:

$$(30) \quad (\mathcal{B}^1, 2\mathcal{B}^1) \subset (\mathcal{B}^2, 2\mathcal{B}^2 \setminus \{2\mathbf{B}\}) \subsetneq (\mathcal{B}^2, 2\mathcal{B}^2).$$

Case 2: Case 1 does not hold, and there exist $B^0 \in \mathcal{B}^1$ and $2\mathbf{B} \in 2\mathcal{B}_{B^0}^2$, $2\mathbf{B}' \in 2\mathcal{B}_{B^0}^2 \setminus 2\mathcal{B}_{B^0}^1$ with $2\mathbf{B}' \subsetneq 2\mathbf{B}$. Fix such 2-brackets $2\mathbf{B}'$, $2\mathbf{B}$. Without loss of generality, we may assume that $2\mathbf{B}$ is minimal among 2-brackets in $2\mathcal{B}_{B^0}^2$ that properly contain $2\mathbf{B}'$. The assumption that we are not in Case 1 implies that $2\mathbf{B}$ lies in $2\mathcal{B}_{B^0}^1$; this assumption also implies that $2\mathbf{B}'$ cannot properly contain any 2-bracket in $2\mathcal{B}_{B^0}^2$. This and the minimality of $2\mathbf{B}$ implies that for any $i \in B^0$ and $j \in 2B'_i$, there is no $2\mathbf{B}'' \in 2\mathcal{B}_{B^0}^1$ with $2\mathbf{B}'' \subsetneq 2\mathbf{B}$ and $2B''_i \ni j$; it therefore follows from the (MARKED SEAMS ARE UNFUSED) property of $(\mathcal{B}^1, 2\mathcal{B}^1)$ that there are no 2-brackets in $2\mathcal{B}_{B^0}^1$ that are properly contained in $2\mathbf{B}$. The (MARKED SEAMS ARE UNFUSED) property of $(\mathcal{B}^2, 2\mathcal{B}^2)$ implies that for every $i \in B^0$ and $j \in 2B_i^2$, there exists $\widetilde{2\mathbf{B}} \in 2\mathcal{B}_{B^0}^2$ with $\widetilde{2\mathbf{B}} \subsetneq 2\mathbf{B}$ and $\widetilde{2B}_i \ni j$. This, together with (2-BRACKETING), imply that if $\widetilde{B}^1, \dots, \widetilde{B}^k \in 2\mathcal{B}_{B^0}^2$ denote the maximal elements (with respect to inclusion) of $2\mathcal{B}_{B^0}^2$ that are properly contained in $2\mathbf{B}$, then these 2-bracketings satisfy $2\mathbf{B} = \bigsqcup_{i=1}^k \widetilde{2\mathbf{B}}^i$. Therefore $(\mathcal{B}^1, 2\mathcal{B}^1 \cup \{\widetilde{2\mathbf{B}}^1, \dots, \widetilde{2\mathbf{B}}^k\})$ is the result of performing a single type-3 move on $(\mathcal{B}^1, 2\mathcal{B}^1)$, and the necessary containments hold:

$$(31) \quad (\mathcal{B}^1, 2\mathcal{B}^1) \subsetneq (\mathcal{B}^1, 2\mathcal{B}^1 \cup \{\widetilde{2\mathbf{B}}^1, \dots, \widetilde{2\mathbf{B}}^k\}) \subset (\mathcal{B}^2, 2\mathcal{B}^2).$$

Case 3: Neither Case 1 nor Case 2 hold. Choose $2\mathbf{B} = (B, (2B_i)) \in 2\mathcal{B}^2 \setminus 2\mathcal{B}^1$. By assumption, there is no $2\mathbf{B}' \in 2\mathcal{B}_B^2$ with either $2\mathbf{B}' \subsetneq 2\mathbf{B}$ or $2\mathbf{B} \subsetneq 2\mathbf{B}'$; it follows from this and the (2-BRACKETING) and (NO GAPS) properties of $(\mathcal{B}^1, 2\mathcal{B}^1)$ that B lies in $\mathcal{B}^2 \setminus \mathcal{B}^1$. Furthermore, the assumption that neither Case 1 nor Case 2 hold implies that any two elements of $2\mathcal{B}_B^2$ are disjoint. We may now set $\mathcal{B} := \mathcal{B}^2 \setminus \{B\}$ and $2\mathcal{B} := 2\mathcal{B}^2 \setminus 2\mathcal{B}_B^2$; the necessary containments hold, and $(\mathcal{B}^2, 2\mathcal{B}^2)$ is the result of performing a single type-2 move on $(\mathcal{B}, 2\mathcal{B})$.

□

Proof of Thm. 1.1. Combine Def.-Lem. 3.13 and Lemma 3.14. □

By Thm. 1.1 we may define $W_{\mathbf{n}} := W_{\mathbf{n}}^{\text{tree}} = W_{\mathbf{n}}^{\text{br}}$. The forgetful map $W_{\mathbf{n}} \rightarrow K_r$ is defined in the two models like so: $W_{\mathbf{n}}^{\text{tree}} \rightarrow K_r^{\text{tree}}$ sends $T_b \xrightarrow{f} T_s$ to T_s ; and $W_{\mathbf{n}}^{\text{br}} \rightarrow K_r^{\text{br}}$ sends $(\mathcal{B}, 2\mathcal{B})$ to \mathcal{B} .

4. $\widehat{W}_{\mathbf{n}}$ IS AN ABSTRACT POLYTOPE

In this section we show that $\widehat{W}_{\mathbf{n}} := W_{\mathbf{n}} \cup \{F_{-1}\}$ is an abstract polytope. This relies on a characterization (Def.-Lem. 4.3) of the closed faces of $W_{\mathbf{n}}$, as products and fiber products of lower-dimensional 2-associahedra. Toward this characterization, we show in the following lemma that for $2T' \in \text{cl}(2T)$, certain vertices in $2T$ have avatars in $2T'$.

Lemma 4.1. *Fix $2T, 2T' \in W_{\mathbf{n}}^{\text{tree}}$ with $2T' \leq 2T$.*

- For any $\rho \in T_s$, there exists a unique $\rho' \in T'_s$ satisfying $B(\rho') = B(\rho)$.
- For any $\alpha \in V_{\text{comp}}(T_b) \cup V_{\text{mark}}(T_b)$ there exists a unique $\alpha' \in V_{\text{comp}}(T'_b) \cup V_{\text{mark}}(T'_b)$ satisfying $2\mathbf{B}(\alpha') = 2\mathbf{B}(\alpha)$.

Proof. First, we prove the first statement. The uniqueness of ρ' is guaranteed by the stability condition, so it suffices to prove existence. We do so by induction on $d(2T')$, starting with $d(2T') = d(2T)$ and counting down. If $d(2T') = d(2T)$, then $T_s = T'_s$ and the statement holds trivially. Next, suppose that for $\rho \in T_s$, we have proved the existence of $\rho' \in T'_s$ with $B(\rho') = B(\rho)$ for every $2T' \leq 2T$ with $d(2T') \geq d(2T) - k \geq 1$; we must show that there is $\rho' \in T'_s$ with $B(\rho') = B(\rho)$ for $T'_s < T_s$ with $d(T'_s) = d(T_s) - k - 1$. Choose $2T''$ with $2T' < 2T'' \leq 2T$ and $d(2T'') = d(2T) - k$, and denote by ρ'' the vertex in T''_s with $B(\rho'') = B(\rho)$. $2T'$ can be obtained from $2T''$ via a single move, so either $T'_s = T''_s$ or T'_s can be obtained from T''_s by performing the following modification to some solid corolla in T''_s , for $2 \leq \ell < k$:

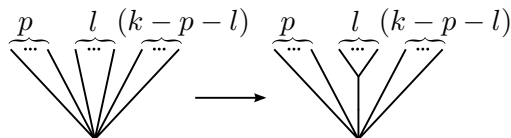

In the former case, we can set $\rho' := \rho''$. In the latter case, we can identify $V(T'_s) \simeq V(T''_s) \cup \{v_{\text{new}}\}$; if we set ρ' to be the vertex in T'_s corresponding via this identification to ρ'' , then $B(\rho') = B(\rho'')$.

The second statement of the lemma can be proven very similarly. □

Next, we show how this correspondence allows us to extract certain sub-stable-tree-pairs from $2T'$.

Definition-Lemma 4.2. *Fix $2T, 2T' \in W_{\mathbf{n}}^{\text{tree}}$ with $2T' < 2T$.*

- Fix $\alpha \in V_{\text{comp}}^1(T_b)$ with $\text{in}(\alpha) =: (\beta)$ and $\text{in}(\beta) =: (\gamma_1, \dots, \gamma_k)$, and denote by $\alpha', \gamma'_1, \dots, \gamma'_k$ the vertices in T'_b that correspond to $\alpha, \gamma_1, \dots, \gamma_k$ via Lemma 4.1. Define $(T'_b)^\alpha$ to be the portion of T'_b bounded by α' and $\gamma'_1, \dots, \gamma'_k$, and define $(T'_s)^\alpha$ to be a single vertex. Then $(2T')^\alpha := (T'_b)^\alpha \rightarrow (T'_s)^\alpha$ is a stable tree-pair in W_k^{tree} .
- For any $\rho \in V_{\text{int}}(T_s)$ with $\text{in}(\rho) =: (\sigma_1, \dots, \sigma_k)$, define $(T'_s)^\rho$ to be the portion of T'_s bounded by ρ' and $\sigma'_1, \dots, \sigma'_k$, where we continue to use the notation of Lemma 4.1. For any $\alpha \in V_{\text{comp}}^{\geq 2}(T_b)$ with $f(\alpha) = \rho$, denote $\text{in}(\alpha) =: (\beta_1, \dots, \beta_k)$ and $\text{in}(\beta_i) =: (\gamma_{i1}, \dots, \gamma_{i\ell_i})$ for $i \in$

$\{1, \dots, k\}$, and define $(T'_b)^\alpha$ to be the portion of T'_b bounded by α' and $\gamma'_{11}, \dots, \gamma'_{1\ell_1}, \dots, \gamma'_{k1}, \dots, \gamma'_{k\ell_k}$. Then $\left((T'_s)^\rho, ((2T')^\alpha := (T'_b)^\alpha \rightarrow (T'_s)^\rho)_\alpha\right)$ is an element of the following fiber product:

$$(32) \quad \prod_{\substack{\alpha \in V_{\text{comp}}^{\geq 2}(T_b) \cap f^{-1}\{\rho\} \\ \text{in}(\alpha) = (\beta_1, \dots, \beta_k)}}^{K_{\#\text{in}(\rho)}} W_{\ell_1, \dots, \ell_k}^{\text{tree}}.$$

Proof. (a) The statement that $(2T')^\alpha$ is an element of W_k^{tree} is almost immediate. Indeed, $(T_s)^\alpha = \text{pt}$, and $(T_b)^\alpha$ is the following:



Define $2T = \widetilde{2T}^1, \dots, \widetilde{2T}^{a_0} = 2T'$, where $\widetilde{2T}^{a+1}$ can be obtained from $\widetilde{2T}^a$ by making a single move. Then $(\widetilde{T}_s^a)^\alpha = \text{pt}$ for every a , and $(\widetilde{T}_b^{a+1})^\alpha$ is either equal to $(\widetilde{T}_b^a)^\alpha$ or can be obtained from $(\widetilde{T}_b^a)^\alpha$ by performing the following modification to one of the dashed corollas in $(T_b^a)^\alpha$, for $2 \leq \ell < k$:

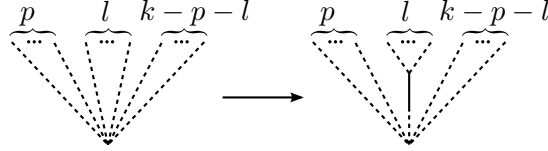

W_k^{tree} is closed under modifications of this form, so $(2T')^\alpha$ is a stable tree-pair in W_k^{tree} .

(b) This statement can be proven via an argument very similar to the one made for (a). □

Definition-Lemma 4.3. Fix $2T \in W_{\mathbf{n}}^{\text{tree}}$. Define a map

$$(33) \quad \Gamma_{2T}: \prod_{\substack{\alpha \in V_{\text{comp}}^1(T_b) \\ \text{in}(\alpha) = (\beta)}} W_{\#\text{in}(\beta)}^{\text{tree}} \times \prod_{\rho \in V_{\text{int}}(T_s)} \prod_{\substack{\alpha \in V_{\text{comp}}^{\geq 2}(T_b) \cap f^{-1}\{\rho\} \\ \text{in}(\alpha) = (\beta_1, \dots, \beta_{\#\text{in}(\rho)}}}^{K_{\#\text{in}(\rho)}} W_{\#\text{in}(\beta_1), \dots, \#\text{in}(\beta_{\#\text{in}(\rho)})}^{\text{tree}} \hookrightarrow W_{\mathbf{n}}^{\text{tree}},$$

by sending $\left((2T)_\alpha, (T_\rho, (\widetilde{2T}_\alpha)_\rho)\right)$ to the element of $W_{\mathbf{n}}^{\text{tree}}$ defined like so: for $\alpha \in V_{\text{comp}}^1(T_b)$ with $\text{in}(\alpha) = (\beta)$, replace the portion of T_b bounded by α and $\text{in}(\beta)$ by $2T_\alpha$; for $\rho \in V_{\text{int}}(T_s)$, replace the portion of T_s bounded by ρ and $\text{in}(\rho)$ by T_ρ ; and for $\rho \in V_{\text{int}}(T_s)$ and $\alpha \in V_{\text{comp}}^{\geq 2}(T_b) \cap f^{-1}\{\rho\}$ with $\text{in}(\alpha) = (\beta_1, \dots, \beta_{\#\text{in}(\rho)})$, replace the portion of T_b bounded by α and $\text{in}(\beta_1), \dots, \text{in}(\beta_{\#\text{in}(\rho)})$ by $\widetilde{2T}_\alpha$. Then Γ_{2T} restricts to a poset isomorphism from its domain to $\text{cl}(2T) \subset W_{\mathbf{n}}^{\text{tree}}$.

Proof. Step 1: Γ_{2T} is a map of posets.

It suffices to show that for any $\left((2T_\alpha^{(2)})_\alpha, (T_\rho^{(2)}, (\widetilde{2T}_\alpha^{(2)})_\rho)\right) < \left((2T_\alpha^{(1)})_\alpha, (T_\rho^{(1)}, (\widetilde{2T}_\alpha^{(1)})_\rho)\right)$, there exists $\left((2T_\alpha^{(3)})_\alpha, (T_\rho^{(3)}, (\widetilde{2T}_\alpha^{(3)})_\rho)\right)$ with

$$(34) \quad \left((2T_\alpha^{(2)})_\alpha, (T_\rho^{(2)}, (\widetilde{2T}_\alpha^{(2)})_\rho)\right) \leq \left((2T_\alpha^{(3)})_\alpha, (T_\rho^{(3)}, (\widetilde{2T}_\alpha^{(3)})_\rho)\right) < \left((2T_\alpha^{(1)})_\alpha, (T_\rho^{(1)}, (\widetilde{2T}_\alpha^{(1)})_\rho)\right)$$

and

$$(35) \quad \Gamma_{2T}\left(\left((2T_\alpha^{(3)})_\alpha, (T_\rho^{(3)}, (\widetilde{2T}_\alpha^{(3)})_\rho)\right)\right) < \Gamma_{2T}\left(\left((2T_\alpha^{(1)})_\alpha, (T_\rho^{(1)}, (\widetilde{2T}_\alpha^{(1)})_\rho)\right)\right).$$

To do so, first suppose that there exists $\alpha_0 \in V_{\text{comp}}^1(T_b)$ with $2T_{\alpha_0}^{(2)} < 2T_{\alpha_0}^{(1)}$. Define $\left((2T_{\alpha}^{(3)})_{\alpha}, (T_{\rho}^{(3)}, (\widetilde{2T}_{\alpha}^{(3)})_{\alpha})_{\rho} \right)$ to be the result of starting with $\left((2T_{\alpha}^{(1)})_{\alpha}, (T_{\rho}^{(1)}, (\widetilde{2T}_{\alpha}^{(1)})_{\alpha})_{\rho} \right)$, and replacing $2T_{\alpha_0}^{(1)}$ by $2T_{\alpha_0}^{(2)}$. The assumption on α_0 implies that $2T_{\alpha_0}^{(2)}$ can be obtained from $2T_{\alpha_0}^{(1)}$ by performing a sequence of type-1 moves. Therefore $\Gamma_{2T} \left((2T_{\alpha}^{(3)})_{\alpha}, (T_{\rho}^{(3)}, (\widetilde{2T}_{\alpha}^{(3)})_{\alpha})_{\rho} \right)$ can be obtained from $\Gamma_{2T} \left((2T_{\alpha}^{(1)})_{\alpha}, (T_{\rho}^{(1)}, (\widetilde{2T}_{\alpha}^{(1)})_{\alpha})_{\rho} \right)$ by performing a sequence of type-1 moves.

If there exists no such α_0 , then we can choose $\rho_0 \in V_{\text{int}}(T_s)$ with $(T_{\rho_0}^{(2)}, (\widetilde{2T}_{\alpha}^{(2)})_{\alpha}) < (T_{\rho_0}^{(1)}, (\widetilde{2T}_{\alpha}^{(1)})_{\alpha})$ and make an argument similar to the previous paragraph.

Step 2: Γ_{2T} restricts to a poset isomorphism onto $\text{cl}(2T)$.

The injectivity of Γ_{2T} is clear. It remains to show that the image of Γ_{2T} is equal to $\text{cl}(2T)$, and that the inverse is a poset map. By Step 1, the image of Γ_{2T} is contained in $\text{cl}(2T)$. Now define a putative inverse

$$(36) \quad \Gamma_{2T}^{-1}: \text{cl}(2T) \rightarrow \prod_{\substack{\alpha \in V_{\text{comp}}^1(T_b) \\ \text{in}(\alpha) = (\beta)}} W_{\#\text{in}(\beta)}^{\text{tree}} \times \prod_{\rho \in V_{\text{int}}(T_s)} \prod_{\substack{\alpha \in V_{\text{comp}}^{\geq 2}(T_b) \cap f^{-1}\{\rho\} \\ \text{in}(\alpha) = (\beta_1, \dots, \beta_{\#\text{in}(\rho)})}}^{K_{\#\text{in}(\rho)}} W_{\#\text{in}(\beta_1), \dots, \#\text{in}(\beta_{\#\text{in}(\rho)})}^{\text{tree}},$$

$$(37) \quad 2T' \mapsto \left((2T'_{\alpha})_{\alpha}, (T'_{\rho}, (\widetilde{2T'}_{\alpha})_{\alpha})_{\rho} \right)$$

like so:

- (a) For $\alpha \in V_{\text{comp}}^1(T_b)$ with $\text{in}(\alpha) = (\beta)$, set $2T'_{\alpha} := (2T')^{\alpha} \in W_{\#\text{in}(\beta)}^{\text{tree}}$, where the latter stable tree-pair was defined in Def.-Lem. 4.2(a).
- (b) For $\rho \in V_{\text{int}}(T_s)$ and $\alpha \in V_{\text{comp}}^{\geq 2}(T_b)$ with $f(\alpha) = \rho$ and $\text{in}(\alpha) = (\beta_1, \dots, \beta_{\#\text{in}(\rho)})$, define

$$(38) \quad (T'_{\rho}, (\widetilde{2T'}_{\alpha})_{\alpha})_{\rho} := ((T'_s)^{\rho}, ((2T')^{\alpha})_{\alpha})_{\rho},$$

where the latter expression was defined in Def.-Lem. 4.2(b).

It is simple to verify that Γ_{2T}^{-1} is an inverse for the restriction of Γ_{2T} to a map to $\text{cl}(2T)$, and to verify that Γ_{2T}^{-1} is a poset map. \square

Now that we have recursively characterized the closed faces of $W_{\mathbf{n}}$, we turn to our proof that $\widehat{W}_{\mathbf{n}}$ is an abstract polytope. We prove the (DIAMOND) and (STRONGLY CONNECTED) properties in Props. 4.5 and 4.4.

Proposition 4.4. *For any $r \geq 1$ and $\mathbf{n} \in \mathbb{Z}_{\geq 0}^r \setminus \{\mathbf{0}, (1)\}$, $\widehat{W}_{\mathbf{n}}$ satisfies (DIAMOND).*

Proof. We must show that for every $F < G$ in $\widehat{W}_{\mathbf{n}}$ with $d(G) - d(F) = 2$, the open interval (F, G) contains exactly 2 elements. In the following steps, we prove this in the cases $F \neq F_{-1}$ and $F = F_{-1}$.

Step 1: We show that for $F < G$ in $W_{\mathbf{n}}$ with $d(G) - d(F) = 2$, the open interval (F, G) contains exactly 2 elements.

In this step, we work with $W_{\mathbf{n}}^{\text{tree}}$. Fix $2T, 2T' \in W_{\mathbf{n}}^{\text{tree}}$ with $d(2T) - d(2T') = 2$. Then $2T'$ can be obtained from $2T$ by applying two moves; we must prove that there are exactly two elements of the open interval $(2T', 2T)$. There are nine cases to consider, depending on whether each of the two moves are of type 1, 2, or 3. This proof quickly becomes repetitive, so we only give details in the case of two type-3 moves.

Suppose that $2T'$ is indeed the result of applying two type-3 moves to $2T$. Suppose, furthermore, that the modifications to T_b are as in the upper-left and upper-right arrows of the following figure (where an arrow indicates a single move, and the adjacent number indicates the type of move):

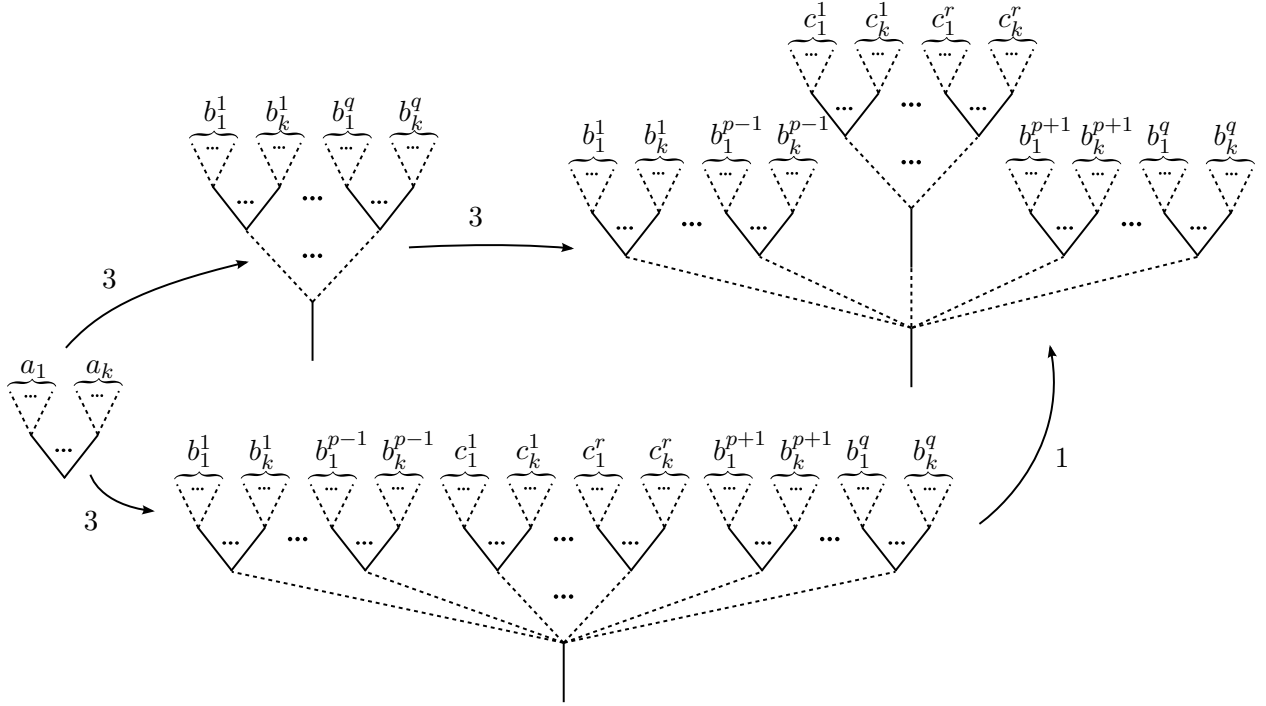

(Here we have chosen a partition of \mathbf{a} as $\mathbf{a} = \sum_{i=1}^q \mathbf{b}^i$, then chosen a partition of \mathbf{b}^p as $\mathbf{b}^p = \sum_{j=1}^r \mathbf{c}^j$.) Then there is exactly one other element of the open interval $(2T', 2T)$: the one obtained from $2T$ by replacing the portion of T_b on the left of the figure by the bottom configuration in the figure. Note that this alternate path from $2T$ to $2T'$ consists not of two type-3 moves, but by a type-3 move followed by a type-1 move.

The other subcases to consider are simpler than this one. Moreover, the other eight cases are similar to this one; rather than include the details, we show in Table 1 representative examples of the diamond property.

Step 2: We show that for $G \in W_{\mathbf{n}}$ with $d(G) = 1$, (F_{-1}, G) contains exactly 2 elements.

In this step, we again work with $W_{\mathbf{n}}^{\text{tree}}$. Fix $2T \in W_{\mathbf{n}}^{\text{tree}}$ with $d(2T) = 1$. It follows from Lemma 3.4 that the vertices in $2T$ satisfy exactly one of three valency conditions, which we treat in cases below.

Every $\alpha \in (T_s)_{\text{int}}$ has $\#\text{in}(\alpha) = 2$. There is a single $\hat{\alpha} \in V_{\text{comp}}^1(T_b)$ with $\#\text{in}(\hat{\alpha}) = 3$, where $\hat{\beta}$ is the incoming neighbor of $\hat{\alpha}$; every $\alpha \in V_{\text{comp}}^1(T_b) \setminus \{\hat{\alpha}\}$ with $\text{in}(\alpha) =: (\beta)$ has $\#\text{in}(\beta) = 2$; and every $\alpha \in V_{\text{comp}}^{\geq 2}(T_b)$ with $\text{in}(\alpha) =: (\beta_1, \beta_2)$ has $\#\text{in}(\beta_1) + \#\text{in}(\beta_2) = 1$. In this case, the only moves that can be performed on $2T$ are type-1 moves based at $\hat{\alpha}$. If we denote $\text{in}(\hat{\beta}) =: (\gamma_1, \gamma_2, \gamma_3)$, then the type-1 moves at $\hat{\alpha}$ correspond to proper consecutive subsets of $(\gamma_1, \gamma_2, \gamma_3)$ of length at least 2; (γ_1, γ_2) and (γ_2, γ_3) are the only such subsets.

Every $\alpha \in (T_s)_{\text{int}}$ has $\#\text{in}(\alpha) = 2$. There is a single $\hat{\alpha} \in V_{\text{comp}}^{\geq 2}(T_b)$ with $\#\text{in}(\hat{\beta}_1) + \#\text{in}(\hat{\beta}_2) = 2$, where $(\hat{\beta}_1, \hat{\beta}_2)$ are the incoming neighbors of $\hat{\alpha}$; every $\alpha \in V_{\text{comp}}^1(T_b)$ with $\text{in}(\alpha) =: (\beta)$ has $\#\text{in}(\beta) = 2$; and every $\alpha \in V_{\text{comp}}^{\geq 2}(T_b) \setminus \{\hat{\alpha}\}$ with $\text{in}(\alpha) =: (\beta_1, \beta_2)$ has $\#\text{in}(\beta_1) + \#\text{in}(\beta_2) = 1$. There are two subcases: either (a) $(\#\text{in}(\beta_1), \#\text{in}(\beta_2)) = (1, 1)$ or (b) $(\#\text{in}(\beta_1), \#\text{in}(\beta_2)) \in \{(2, 0), (0, 2)\}$. If (a) holds, the only moves that can be performed on $2T$ are type-3 moves based at $\hat{\alpha}$. In the notation of the definition of type-3 moves, $\mathbf{a} = (1, 1)$, and the type-3 moves at $\hat{\alpha}$ correspond to choices of $\mathbf{b}^1, \dots, \mathbf{b}^q \in \mathbb{Z}_{\geq 0}^2 \setminus \{\mathbf{0}\}$ with $\sum_j \mathbf{b}^j = \mathbf{a}$. There are clearly two such choices: $\mathbf{b}^1 = (1, 0)$ and $\mathbf{b}^2 = (0, 1)$, or $\mathbf{b}^1 = (0, 1)$ and $\mathbf{b}^2 = (1, 0)$. On the

	type-1	type-2	type-3
type-1			
type-2			
type-3			

TABLE 1. In this step we show that for any $2T, 2T' \in W_{\mathbf{n}}^{\text{tree}}$ with $d(2T) - d(2T') = 2$, the open interval $(2T', 2T)$ contains two elements. Here we illustrate this fact in nine cases: $2T'$ can be obtained from $2T$ by applying two moves, and these moves can be of type 1, 2, or 3. In each case, the four configurations are the bubble trees T_b of a stable tree-pair; the seam trees T_s are either a point or a corolla of two, three, or four solid edges, and can be inferred from the bubble tree. On the left is $2T$, on the right is $2T'$, and the remaining two stable tree-pairs are the two elements of $(2T', 2T)$. The arrows indicate moves, and their labels are the types.

other hand, if (b) holds, we can either perform a type-1 move or a type-3 move at $\hat{\alpha}$, and there is only possible move of each type.

There is a single $\hat{\rho} \in (T_s)_{\text{int}}$ with $\#\text{in}(\hat{\rho}) = 3$. Every $\alpha \in V_{\text{comp}}^1(T_b)$ with $\text{in}(\alpha) =: (\beta)$ has $\#\text{in}(\beta) = 2$; every $\alpha \in V_{\text{comp}}^{\geq 2}(T_b)$ with $\text{in}(\alpha) =: (\beta_1, \beta_2)$ has $\#\text{in}(\beta_1) + \#\text{in}(\beta_2) = 1$; and every $\rho \in (T_s)_{\text{int}} \setminus \{\hat{\rho}\}$ has $\#\text{in}(\rho) = 2$. In this case, the only moves that can be performed on $2T$ are type-2 moves based at $\hat{\rho}$. Denote $\text{in}(\hat{\rho}) =: (\sigma_1, \sigma_2, \sigma_3)$. The type-2 moves based at $\hat{\rho}$ correspond to (1) a choice of a proper consecutive subset $(\sigma_{p+1}, \dots, \sigma_{p+\ell}) \subset \text{in}(\hat{\rho})$ of length at least 2 (of which there are two), and (2) for every $\alpha \in V_{\text{comp}}^{\geq 2}(T_b)$ with $f(\alpha) = \hat{\rho}$, a choice of $q \geq 0$ and $\mathbf{b}^1, \dots, \mathbf{b}^q \in \mathbb{Z}_{\geq 0}^{\ell} \setminus \{\mathbf{0}\}$ with $\sum_j \mathbf{b}^j = \mathbf{a}$, where $\mathbf{a} \in \mathbb{Z}_{\geq 0}^{\ell} \setminus \{\mathbf{0}\}$ is defined by setting $\text{in}(\alpha) =: (\beta_1, \beta_2, \beta_3)$ and $a_i := \#\text{in}(\beta_{p+i})$. By assumption, for every such α , we have $|\mathbf{a}| = 1$. Therefore there is exactly one choice of the decomposition $\mathbf{a} = \sum_j \mathbf{b}^j$, so there are two type-2 moves based at $\hat{\rho}$. □

Proposition 4.5. For any $r \geq 1$ and $\mathbf{n} \in \mathbb{Z}_{\geq 0}^r \setminus \{\mathbf{0}, (1)\}$, $\widehat{W}_{\mathbf{n}}$ is strongly connected.

Proof. We must show that for every $F < G$ in $\widehat{W}_{\mathbf{n}}$ with $d(G) - d(F) \geq 3$, $[F, G]$ is connected, i.e. any two elements in the open interval (F, G) can be connected by a path contained in (F, G) . In the following steps, we prove this in the cases $F \neq F_{-1}$ and $F = F_{-1}$.

Step 1: For $s \geq 1$ and $\mathbf{m}^1, \dots, \mathbf{m}^\ell \in \mathbb{Z}_{\geq 0}^s \setminus \{\mathbf{0}\}$, define a dimension function on the completed fiber product $P := \{F_{-1}\} \cup \prod_{1 \leq i \leq \ell}^{K_s^{\text{tree}}} W_{\mathbf{m}^i}^{\text{tree}}$ like so:

$$(39) \quad d(T, (2T^{(i)})_i) := d(T) + \sum_{1 \leq i \leq \ell} (d(2T^{(i)}) - d(T)), \quad d(F_{-1}) := -1.$$

Denote the maximal element of P by F^{top} . For any $G \in P$ with $d(F^{\text{top}}) - d(G) \geq 3$, the interval $[G, F^{\text{top}}]$ is connected.

We divide this step into two cases, depending on whether or not G is the minimal element F_{-1} .

First, suppose $G = F_{-1}$. The condition $d(F^{\text{top}}) - d(G) \geq 3$ translates into the condition $s - 2 + \sum_{1 \leq i \leq \ell} (|\mathbf{m}^i| - 1) \geq 2$, which implies that at least one of these conditions holds:

- (a) $s \geq 4$.
- (b) $s \geq 3$ and there exists i with $|\mathbf{m}^i| \geq 2$.
- (c) There exist $i \neq j$ with $|\mathbf{m}^i| \geq 2$ and $|\mathbf{m}^j| \geq 2$.
- (d) There exists i with $|\mathbf{m}^i| \geq 3$.

In case (a), it suffices to assume $d(G) = d(F^{\text{top}}) - 1$ and to show that there is a path in (F_{-1}, F^{top}) from G to the following element of P :

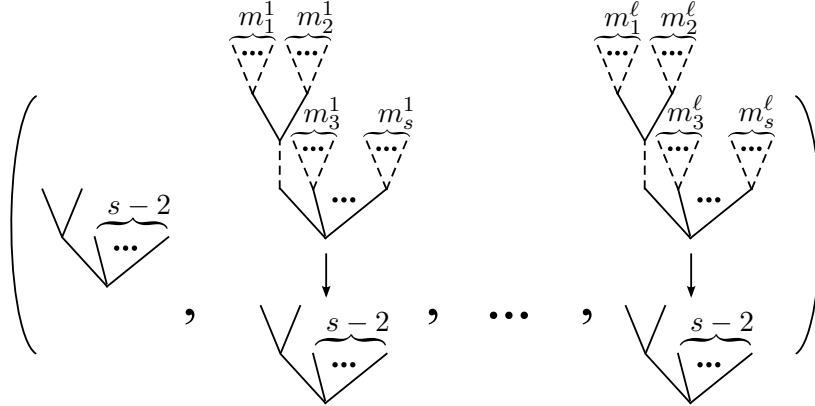

This can be shown by an argument similar to the one made in Prop. 2.16 to prove the (STRONGLY CONNECTED) property for the associahedra. The same is true for cases (b–d).

Second, we must show that $[G, F^{\text{top}}]$ is connected for $G \neq F_{-1}$. We do so by using the 2-bracketing model for 2-associahedra. Write $G = (\widehat{\mathcal{B}}, (\widehat{2\mathcal{B}}_i)_{i=1}^\ell)$, where throughout this proof we abbreviate 2-bracketings by their collection of 2-bracketings and omit the underlying 1-bracketing, as this 1-bracketing will be evident. Fix distinct $F^{(j)} := (\mathcal{B}^{(j)}, (2\mathcal{B}_i^{(j)})_{i=1}^\ell) \in (G, F^{\text{top}}) \subset P$ for $j \in \{1, 2\}$; we must show that there is a path between these elements within (G, F^{top}) . Without loss of generality, we may assume $d(F^{(j)}) = d(F^{\text{top}}) - 1$ for $j \in \{1, 2\}$. It follows that each $F^{(j)}$ can be obtained in exactly one of the following ways, where we write $F^{\text{top}} =: (\mathcal{B}, (2\mathcal{B}_i)_i)$:

- (1) Perform a type-1 move on a single $2\mathcal{B}_i$.
- (2) Perform a single move $\mathcal{B} \rightarrow \mathcal{B}'$, then perform a type-2 move $2\mathcal{B}_i \rightarrow 2\mathcal{B}'_i$ for every $1 \leq i \leq \ell$, such that $\pi(2\mathcal{B}'_i) = \mathcal{B}'$.
- (3) Perform a type-3 move on a single $2\mathcal{B}_i$.

Define $\tilde{F} := (\mathcal{B}^{(1)} \cup \mathcal{B}^{(2)}, (2\mathcal{B}_i^{(1)} \cup 2\mathcal{B}_i^{(2)})_i$). Then \tilde{F} is again an element of the fiber product P , where for $B_0 \in \mathcal{B}^{(1)} \cup \mathcal{B}^{(2)}$ and $1 \leq i \leq \ell$ the partial order on $(2\mathcal{B}_i^{(1)} \cup 2\mathcal{B}_i^{(2)})_{B_0}$ is induced by the partial order on the larger collection $(\widehat{2\mathcal{B}_i})_{B_0}$. If (1) holds for $F^{(j)}$ for both $j = 1$ and $j = 2$, then $d(\tilde{F}) = d(F^{\text{top}}) - 2$; we can then connect $F^{(1)}$ and $F^{(2)}$ by the path $F^{(1)} \rightarrow \tilde{F} \rightarrow F^{(2)}$. The same is true in all of the other cases, except in the cases that (2) holds for $j \in \{1, 2\}$, or that (3) holds for $j \in \{1, 2\}$: here, $d(\tilde{F})$ could be less than $d(F^{\text{top}})$. The constructions in these two situations are similar, so we assume that (3) holds for $j \in \{1, 2\}$. Denote by i_1 resp. i_2 the indices with the property that $F^{(j)}$ is obtained from F^{top} by performing a type-3 move on $2\mathcal{B}_{i_j}$. If $i_1 \neq i_2$, then $d(\tilde{F}) = d(F^{\text{top}}) - 2$ and we can again use the path $F^{(1)} \rightarrow \tilde{F} \rightarrow F^{(2)}$. Suppose, on the other hand, that $i_1 = i_2 =: i_0$. If $d(2\mathcal{B}_{i_0}) = d(\widehat{2\mathcal{B}_{i_0}}) - 2$, we can again use the construction described above. Otherwise, it suffices to show that there is a path from $2\mathcal{B}_{i_0}^{(1)}$ to $2\mathcal{B}_{i_0}^{(2)}$ within $W_{\mathbf{m}^{i_0}}$ that avoids both $\widehat{2\mathcal{B}_{i_0}}$ and the maximal face. Towards this, we express $2\mathcal{B}_{i_0}^{(1)}$ and $2\mathcal{B}_{i_0}^{(2)}$ like so:

$$(40) \quad 2\mathcal{B}_{i_0}^{(j)} = \left\{ (\{1, \dots, s\}, (\{1, \dots, m_1^{i_0}\}, \dots, \{1, \dots, m_s^{i_0}\})) \right\} \cup \left\{ (\{k\}, (\{\ell\})) \mid \begin{array}{l} 1 \leq k \leq s \\ 1 \leq \ell \leq m_k^{i_0} \end{array} \right\} \\ \cup \left\{ (\{1, \dots, s\}, (A_{t,1}^{(j)}, \dots, A_{t,s}^{(j)})) \mid 1 \leq t \leq q^{(j)} \right\} \\ =: 2\mathcal{B}^{\text{top}} \cup \left\{ (\{1, \dots, s\}, (A_{t,1}^{(j)}, \dots, A_{t,s}^{(j)})) \mid 1 \leq t \leq q^{(j)} \right\}.$$

To define our path from $2\mathcal{B}_{i_0}^{(1)}$ to $2\mathcal{B}_{i_0}^{(2)}$, we begin by examining $(A_{1,1}^{(1)}, \dots, A_{1,s}^{(1)})$ and $(A_{1,1}^{(2)}, \dots, A_{1,s}^{(2)})$. If these sequences of sets are equal, we do nothing. If they are not equal, then because $2\mathcal{B}_{i_0}^{(1)}, 2\mathcal{B}_{i_0}^{(2)}$ are bounded from below by $\widehat{2\mathcal{B}_{i_0}}$, there must exist $q' \geq 2$ such that one of the following equalities holds:

$$(41) \quad \begin{aligned} (A_{1,1}^{(1)}, \dots, A_{1,s}^{(1)}) &= (A_{1,1}^{(2)} \cup \dots \cup A_{q',1}^{(2)}, \dots, A_{1,s}^{(2)} \cup \dots \cup A_{q',s}^{(2)}), \\ (A_{1,1}^{(2)}, \dots, A_{1,s}^{(2)}) &= (A_{1,1}^{(1)} \cup \dots \cup A_{q',1}^{(1)}, \dots, A_{1,s}^{(1)} \cup \dots \cup A_{q',s}^{(1)}). \end{aligned}$$

Suppose that the first equality holds. Then we define the first two steps in our path like so:

$$(42) \quad \begin{aligned} (2\mathcal{B}_{i_0}^{(1)} &= 2\mathcal{B}^{\text{top}} \cup \left\{ (\{1, \dots, s\}, (A_{t,1}^{(1)}, \dots, A_{t,s}^{(1)})) \mid 1 \leq t \leq q^{(1)} \right\}, \\ 2\mathcal{B}^{\text{top}} \cup \left\{ (\{1, \dots, s\}, (A_{t,1}^{(1)}, \dots, A_{t,s}^{(1)})) \mid 1 \leq t \leq q^{(1)} \right\} &\cup \left\{ (\{1, \dots, s\}, (A_{t,1}^{(2)}, \dots, A_{t,s}^{(2)})) \mid 1 \leq t \leq q' \right\}, \\ 2\mathcal{B}^{\text{top}} \cup \left\{ (\{1, \dots, s\}, (A_{t,1}^{(1)}, \dots, A_{t,s}^{(1)})) \mid 2 \leq t \leq q^{(1)} \right\} &\cup \left\{ (\{1, \dots, s\}, (A_{t,1}^{(2)}, \dots, A_{t,s}^{(2)})) \mid 1 \leq t \leq q' \right\}). \end{aligned}$$

If, on the other hand, the second equation in (41) holds, we define the first two steps in our path like so:

$$(43) \quad \begin{aligned} (2\mathcal{B}_{i_0}^{(1)} &= 2\mathcal{B}^{\text{top}} \cup \left\{ (\{1, \dots, s\}, (A_{t,1}^{(1)}, \dots, A_{t,s}^{(1)})) \mid 1 \leq t \leq q^{(1)} \right\}, \\ 2\mathcal{B}^{\text{top}} \cup \left\{ (\{1, \dots, s\}, (A_{t,1}^{(1)}, \dots, A_{t,s}^{(1)})) \mid 1 \leq t \leq q^{(1)} \right\} &\cup \left\{ (\{1, \dots, s\}, (A_{1,1}^{(2)}, \dots, A_{1,s}^{(2)})) \right\}, \\ 2\mathcal{B}^{\text{top}} \cup \left\{ (\{1, \dots, s\}, (A_{t,1}^{(1)}, \dots, A_{t,s}^{(1)})) \mid q' + 1 \leq t \leq q^{(1)} \right\} &\cup \left\{ (\{1, \dots, s\}, (A_{1,1}^{(2)}, \dots, A_{1,s}^{(2)})) \right\}). \end{aligned}$$

By proceeding in this fashion, we can construct a path from $2\mathcal{B}^{(1)}$ to $2\mathcal{B}^{(2)}$ whose elements are either of codimension 1 or 2 in $W_{\mathbf{m}^{i_0}}$.

Step 2: For $G \in W_{\mathbf{n}}$ with $d(G) \geq 2$, $[F_{-1}, G]$ is connected.

Fix $2T \in W_{\mathbf{n}}^{\text{tree}}$ with $d(2T) \geq 2$. By Def.-Lem. 4.3, we have the following formula for $[F_{-1}, 2T]$:

$$(44) \quad [F_{-1}, 2T] \simeq \{F_{-1}\} \cup \prod_{\substack{\alpha \in V_{\text{comp}}^1(T_b) \\ \text{in}(\alpha) = (\beta)}} W_{\# \text{in}(\beta)}^{\text{tree}} \times \prod_{\rho \in V_{\text{int}}(T_s)} \prod_{\substack{\alpha \in V_{\text{comp}}^{\geq 2}(T_b) \cap f^{-1}\{\rho\} \\ \text{in}(\alpha) = (\beta_1, \dots, \beta_{\# \text{in}(\rho)})}} K_{\# \text{in}(\rho)}^{\text{tree}} W_{\# \text{in}(\beta_1), \dots, \# \text{in}(\beta_{\# \text{in}(\rho)})}^{\text{tree}}.$$

Fix stable tree-pairs $2T^{(1)}, 2T^{(2)}$ with $2T^{(i)} < 2T$ and $d(2T^{(i)}) = d(2T) - 1$, and express them via (44) as $2T^{(i)} = \left((2T_{\alpha}^{(i)})_{\alpha}, (T_{\rho}^{(i)}, (\widetilde{2T}_{\alpha}^{(i)})_{\alpha})_{\rho} \right)$ for $i \in \{1, 2\}$. Similarly, write $2T = \left((2T_{\alpha})_{\alpha}, (T_{\rho}, (\widetilde{2T}_{\alpha})_{\alpha})_{\rho} \right)$ (so $2T_{\alpha}$ resp. T_{ρ} resp. $\widetilde{2T}_{\alpha}$ are the top-dimensional faces of their respective posets). For $i \in \{1, 2\}$, the equality $d(2T^{(i)}) = d(2T) - 1$ implies that one of these possibilities holds:

- (a) There exists a single $\alpha_0 \in V_{\text{comp}}^1(T_b)$ with $2T_{\alpha_0}^{(i)} \neq 2T_{\alpha_0}$. For every $\rho \in V_{\text{int}}(T_s)$, $(T_{\rho}^{(i)}, (\widetilde{2T}_{\alpha}^{(i)})_{\alpha}) = (T_{\rho}, (\widetilde{2T}_{\alpha})_{\alpha})$.
- (b) For every $\alpha \in V_{\text{comp}}^1(T_b)$, $2T_{\alpha}^{(i)} = 2T_{\alpha}$. There exists a single $\rho_0 \in V_{\text{int}}(T_s)$ with $(T_{\rho_0}^{(i)}, (\widetilde{2T}_{\alpha}^{(i)})_{\alpha}) \neq (T_{\rho_0}, (\widetilde{2T}_{\alpha})_{\alpha})$.

Suppose that (a) resp. (b) hold for $i = 1$ resp. $i = 2$. Then we can construct a path from $2T^{(1)}$ to $2T^{(2)}$ in $(F_{-1}, 2T)$ as $2T^{(1)} \rightarrow 2T' \rightarrow 2T^{(2)}$, where $2T'$ is defined like so:

$$(45) \quad 2T' := \left((2T'_{\alpha})_{\alpha}, (T'_{\rho}, (\widetilde{2T}'_{\alpha})_{\alpha})_{\rho} \right),$$

$$2T'_{\alpha} := \begin{cases} 2T_{\alpha_0}^{(1)}, & \alpha = \alpha_0, \\ 2T_{\alpha}, & \alpha \neq \alpha_0, \end{cases}, \quad (T'_{\rho}, (\widetilde{2T}'_{\alpha})_{\alpha}) := \begin{cases} (T_{\rho}^{(2)}, (\widetilde{2T}_{\alpha}^{(2)})_{\alpha}), & \rho = \rho_0, \\ (T_{\rho}, (\widetilde{2T}_{\alpha})_{\alpha}), & \rho \neq \rho_0. \end{cases}$$

Similar arguments show that there exists a path from $2T^{(1)}$ to $2T^{(2)}$ if (b) resp. (a) hold for $i = 1$ resp. $i = 2$; or if (a) holds for $i \in \{1, 2\}$ and the α_0 's are different; or if (b) holds for $i \in \{1, 2\}$ and the ρ_0 's are different. If (a) holds for $i \in \{1, 2\}$ and there exists a single α_0 with $2T_{\alpha_0}^{(i)} \neq 2T_{\alpha_0}$ for $i \in \{1, 2\}$, then either $2T_{\alpha_0}^{(1)} = 2T_{\alpha_0}^{(2)}$, or these stable tree-pairs are not equal, in which case the existence of a path from $2T^{(1)}$ to $2T^{(2)}$ in $(F_{-1}, 2T)$ follows from the identification $W_{\mathbf{n}}^{\text{tree}} \simeq K_{\mathbf{n}}^{\text{tree}}$ of Lemma 3.7 and the (STRONGLY CONNECTED) property of associahedra proven in Prop. 2.13. Similarly, if (b) holds for $i \in \{1, 2\}$ and there exists a single ρ_0 with $(T_{\rho_0}^{(1)}, (\widetilde{2T}_{\alpha}^{(1)})_{\alpha}) = (T_{\rho_0}^{(2)}, (\widetilde{2T}_{\alpha}^{(2)})_{\alpha})$, then the existence of a path from $2T^{(1)}$ to $2T^{(2)}$ in $(F_{-1}, 2T)$ follows from Step 1.

Step 3: For $F < G$ in $W_{\mathbf{n}}$ with $d(G) - d(F) \geq 3$, $[F, G]$ is connected.

The argument in Step 2 applies equally well to this case. \square

Theorem 4.6. *For any $r \geq 1$ and $\mathbf{n} \in \mathbb{Z}_{\geq 0}^r \setminus \{\mathbf{0}, (1)\}$, $\widehat{W}_{\mathbf{n}}$ is an abstract polytope of dimension $|\mathbf{n}| + r - 3$.*

Proof. We established (DIAMOND) resp. (STRONGLY CONNECTED) in Props. 4.4 resp. 4.5, so it only remains to establish (EXTREMAL), (FLAG-LENGTH), and the dimension formula.

The least face of $\widehat{W}_{\mathbf{n}}$ is the face F_{-1} we have added to $W_{\mathbf{n}}$ to form $\widehat{W}_{\mathbf{n}}$, while the greatest face (in $\widehat{W}_{\mathbf{n}}^{\text{br}}$) is the 2-bracketing $(\mathcal{B}, 2\mathcal{B})$ with

$$(46) \quad \mathcal{B} := \{\{1, \dots, r\}, \{1\}, \dots, \{r\}\},$$

$$2\mathcal{B} := \left\{ \left(\{1, \dots, r\}, (\{1, \dots, n_1\}, \dots, \{1, \dots, n_r\}) \right) \right\} \cup \left\{ (\{i\}, (\{j\})) \mid \begin{array}{l} 1 \leq i \leq r \\ 1 \leq j \leq n_i \end{array} \right\}.$$

This establishes (EXTREMAL).

To prove (FLAG-LENGTH) and to show that the dimension of $W_{\mathbf{n}}$ is $|\mathbf{n}| + r - 3$, it suffices to show that if $2T^0 < \dots < 2T^\ell$ is a maximal chain in $W_{\mathbf{n}}^{\text{tree}}$, then $\ell = |\mathbf{n}| + r - 3$. By Lemmata 3.4 and 3.5, we have $0 \leq d(2T^0) < \dots < d(2T^\ell) \leq |\mathbf{n}| + r - 3$. To prove the claim, we must show that every dimension between 0 and $|\mathbf{n}| + r - 3$ is represented. For any T^i, T^{i+1} , we must have $d(T^i) = d(T^{i+1}) - 1$: otherwise, there exists $T' \in W_{\mathbf{n}}^{\text{tree}}$ which can be obtained by performing a single move to T^{i+1} , and which satisfies $d(T^i) < d(T') < d(T^{i+1})$; this would contradict the maximality of the chain. Again by maximality, we must have $2T^\ell = F_{|\mathbf{n}|+r-3}$. It remains to show $d(T^0) = 0$. Suppose for a contradiction that $d(T^0)$ is positive; then by Lemma 3.4, either (a) there exists $\alpha \in V_{\text{comp}}^1(T_b)$ with $\#\text{in}(\alpha) \geq 3$; (b) there exists $\alpha \in V_{\text{comp}}^{\geq 2}(T_b)$ with $\sum_{\beta \in \text{in}(\alpha)} \#\text{in}(\beta) \geq 2$; or (c) there exists $\alpha \in (T_s)_{\text{int}}$ with $\#\text{in}(\alpha) \geq 3$. In these three cases we may perform a move of type 1 resp. type 3 resp. type 2 to $2T^0$, which contradicts the maximality of our chain. \square

Proof of Thm. 1.2. Combine Def.-Lem. 4.3 and Thm. 4.6. \square

APPENDIX A. 2- AND 3-DIMENSIONAL 2-ASSOCIAHEDRA

In this appendix, we work out all¹ the 2- and 3-dimensional 2-associahedra $W_{\mathbf{n}}$. First, we record the face vectors of these examples and note whether or not $\widehat{W}_{\mathbf{n}}$ is simple. (An abstract d -polytope is *simple* if every 0-face is adjacent to exactly d 1-faces. The author believes that for every $r \geq 2$ and $\mathbf{n} \in \mathbb{Z}_{\geq 0}^r$ with $|\mathbf{n}| \geq 4$, $\widehat{W}_{\mathbf{n}}$ is not simple.) Second, we give “net” representations of these examples, where each vertex corresponds to a 0-face of $W_{\mathbf{n}}$, each edge to a 1-face, and each polygonal face to a 2-face. In the case of the 3-dimensional examples, we do not represent the 3-dimensional face. Each numbered edge should be identified with the correspondingly numbered edge. Some faces are labelled by the 2-bracketings to which they correspond.

2-dimensional 2-associahedra			3-dimensional 2-associahedra		
\mathbf{n}	face vector	simple?	\mathbf{n}	face vector	simple?
30	(6,6,1)	yes	40	(21,32,13,1)	no
21	(8,8,1)	yes	31	(36,56,22,1)	no
200	(5,5,1)	yes	22	(44,69,27,1)	no
110	(6,6,1)	yes	300	(18,27,11,1)	yes
101	(4,4,1)	yes	210	(30,45,17,1)	yes
020	(6,6,1)	yes	201	(18,27,11,1)	yes
			120	(32,48,18,1)	yes
			030	(24,36,14,1)	yes
			2000	(14,21,9,1)	yes
			1100	(18,27,11,1)	yes
			1010	(14,21,9,1)	yes
			1001	(10,15,7,1)	yes
			0200	(18,27,11,1)	yes
			0110	(22,33,13,1)	yes

¹We make use of the identity $W_{n_1, n_2, \dots, n_r} \simeq W_{n_r, n_{r-1}, \dots, n_1}$. Also, we do not include 2-associahedra of the form W_{n_1} or $W_{0, \dots, 0, 1, 0, \dots, 0, 1}$, since these can be identified with associahedra via Lemma 3.7 and the following remark.

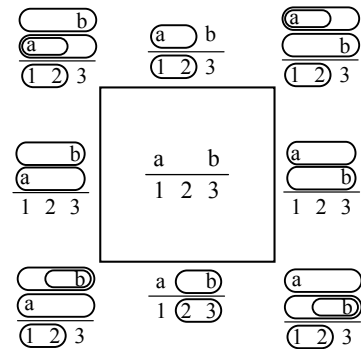
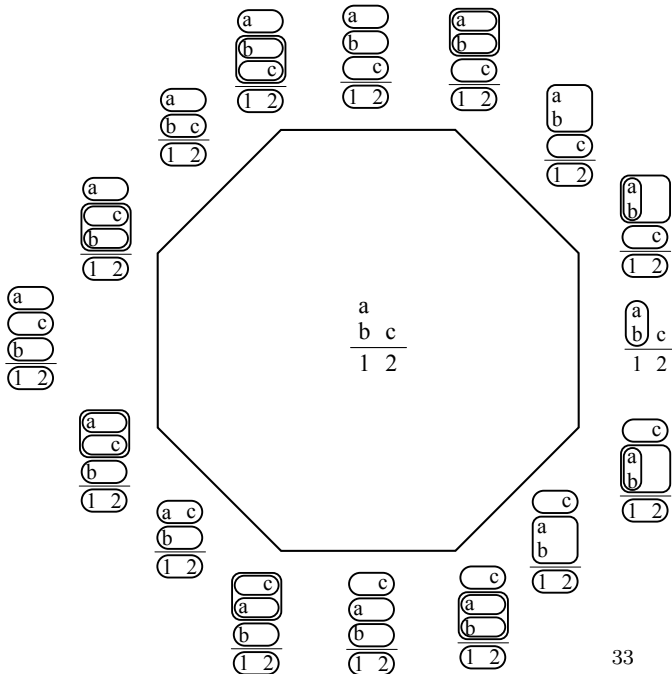
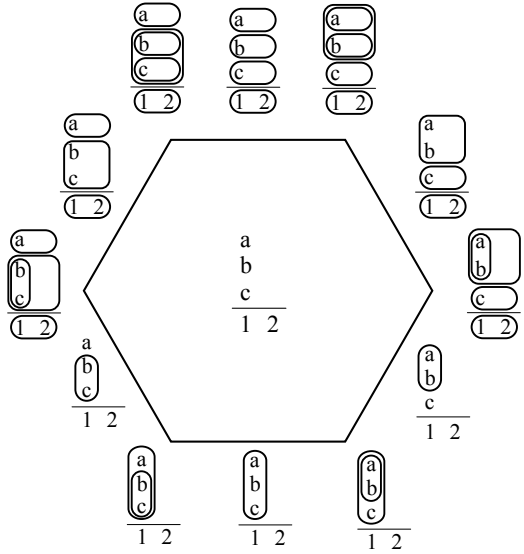
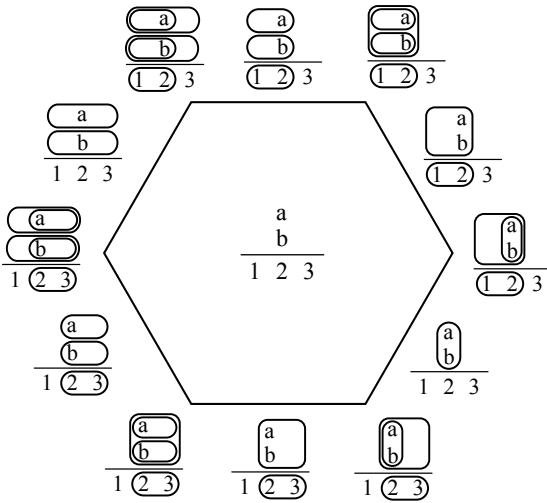
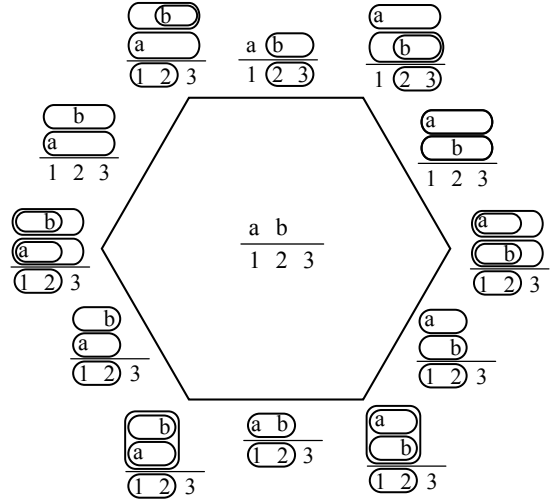
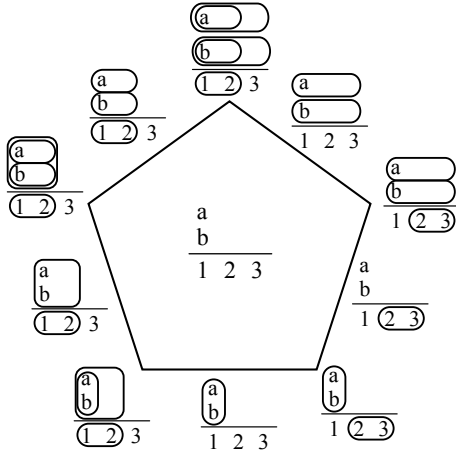

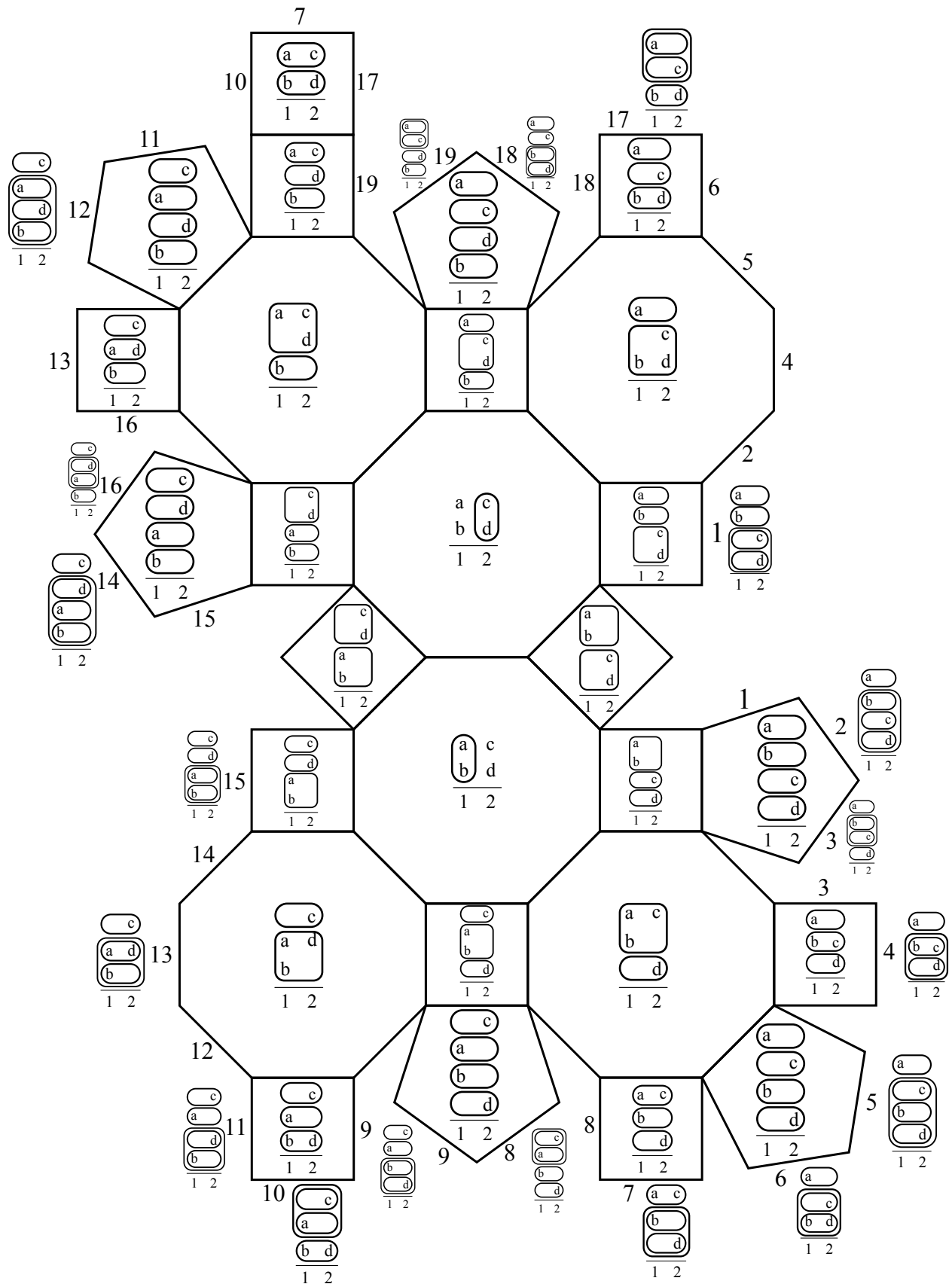

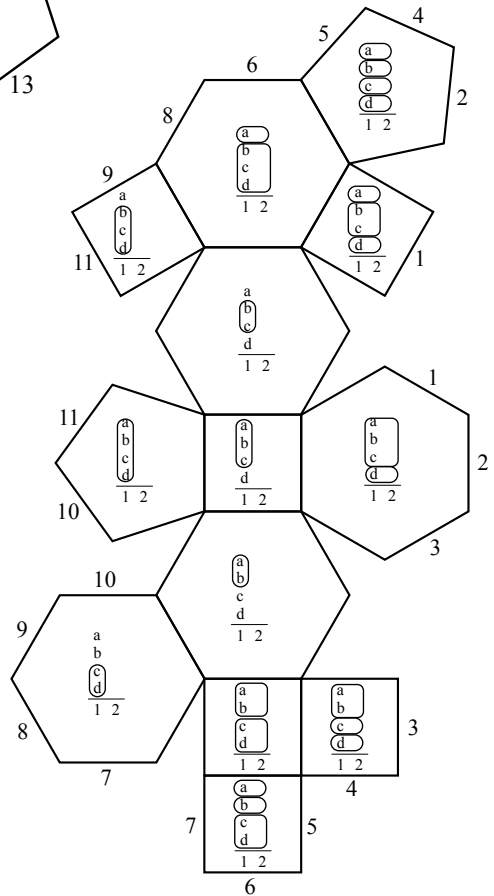
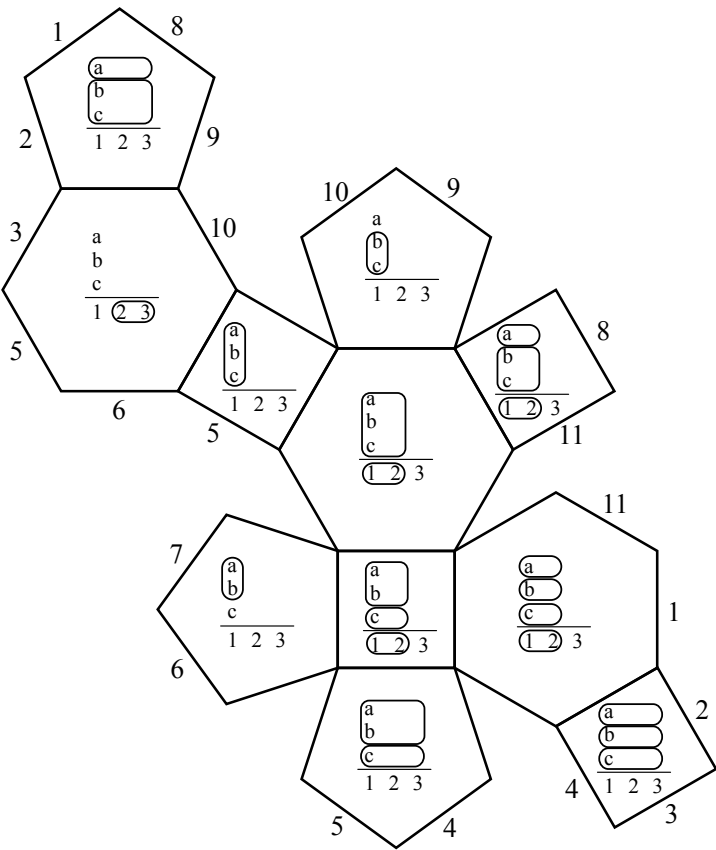
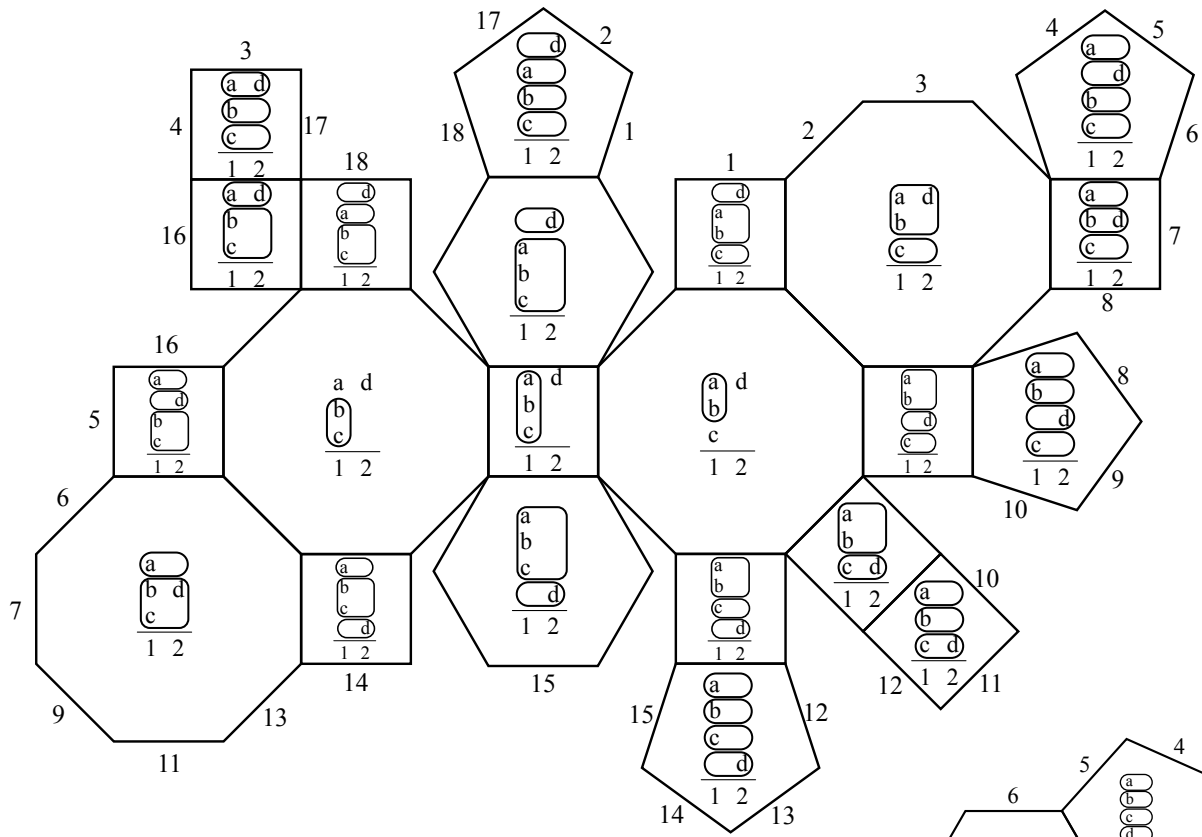

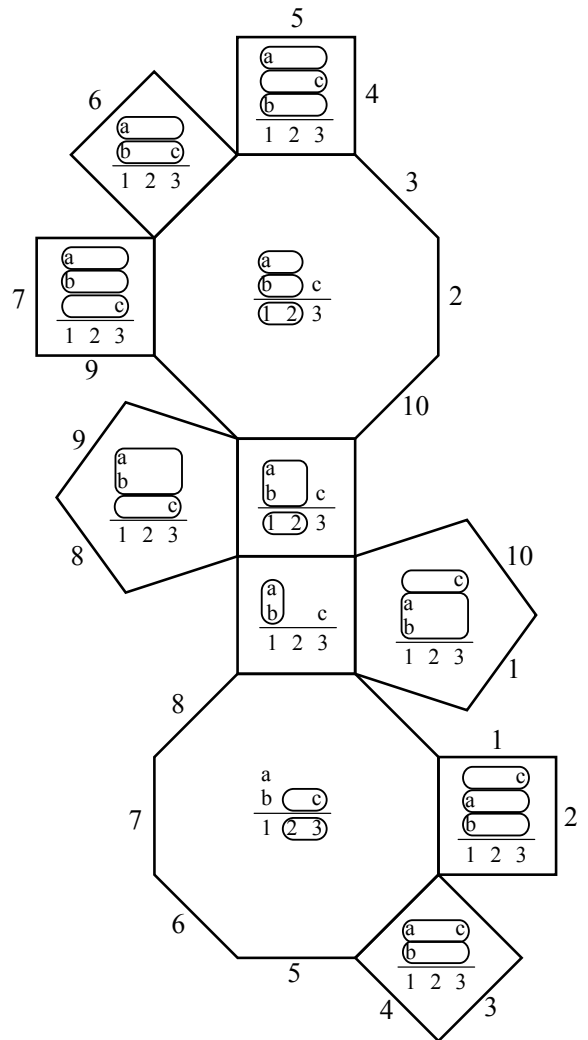
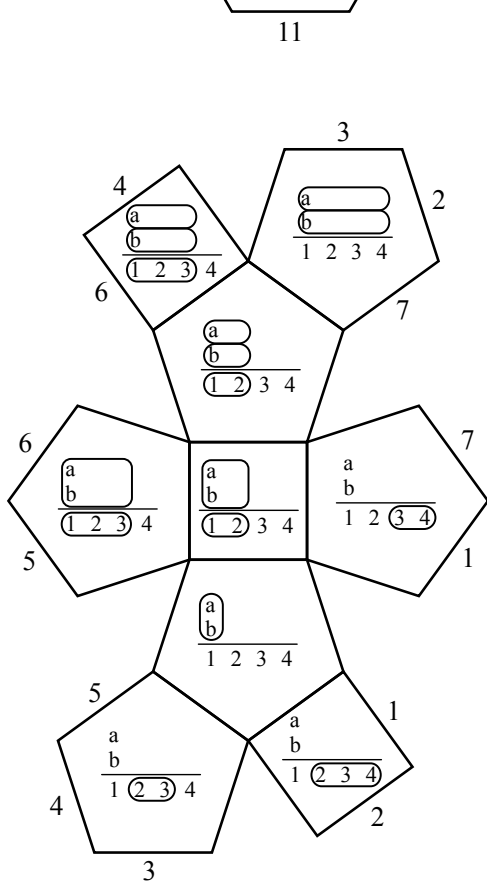
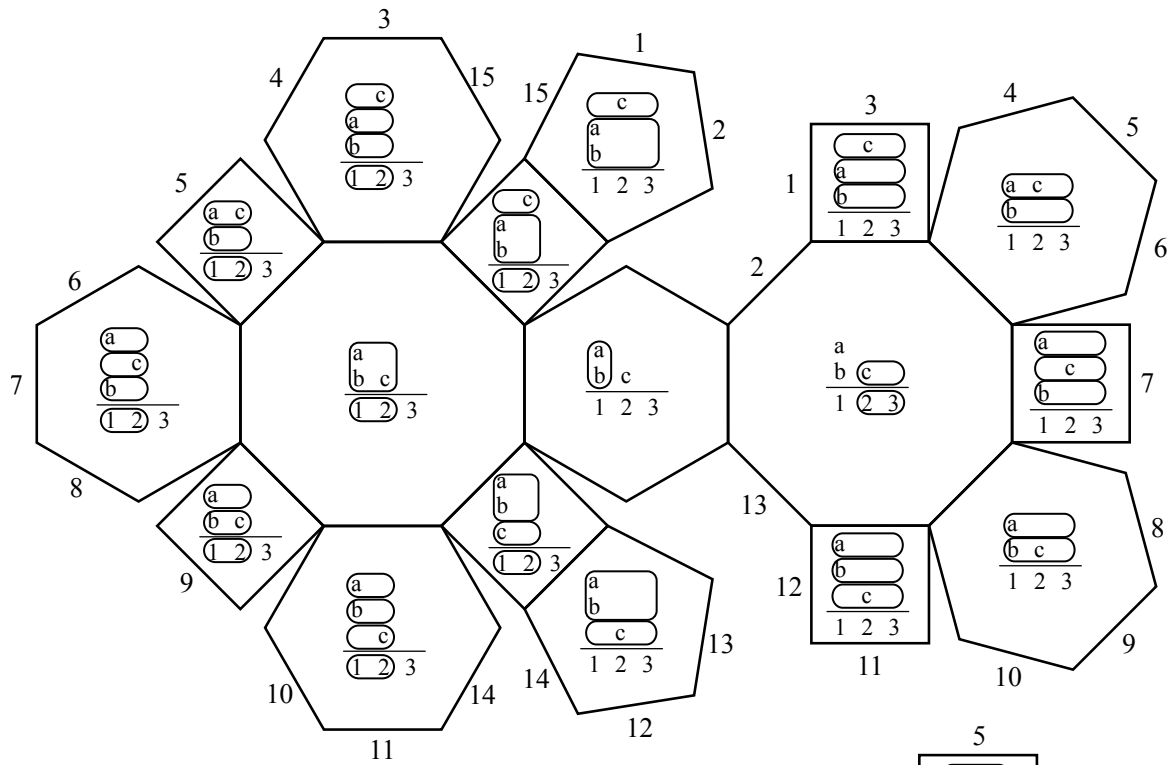

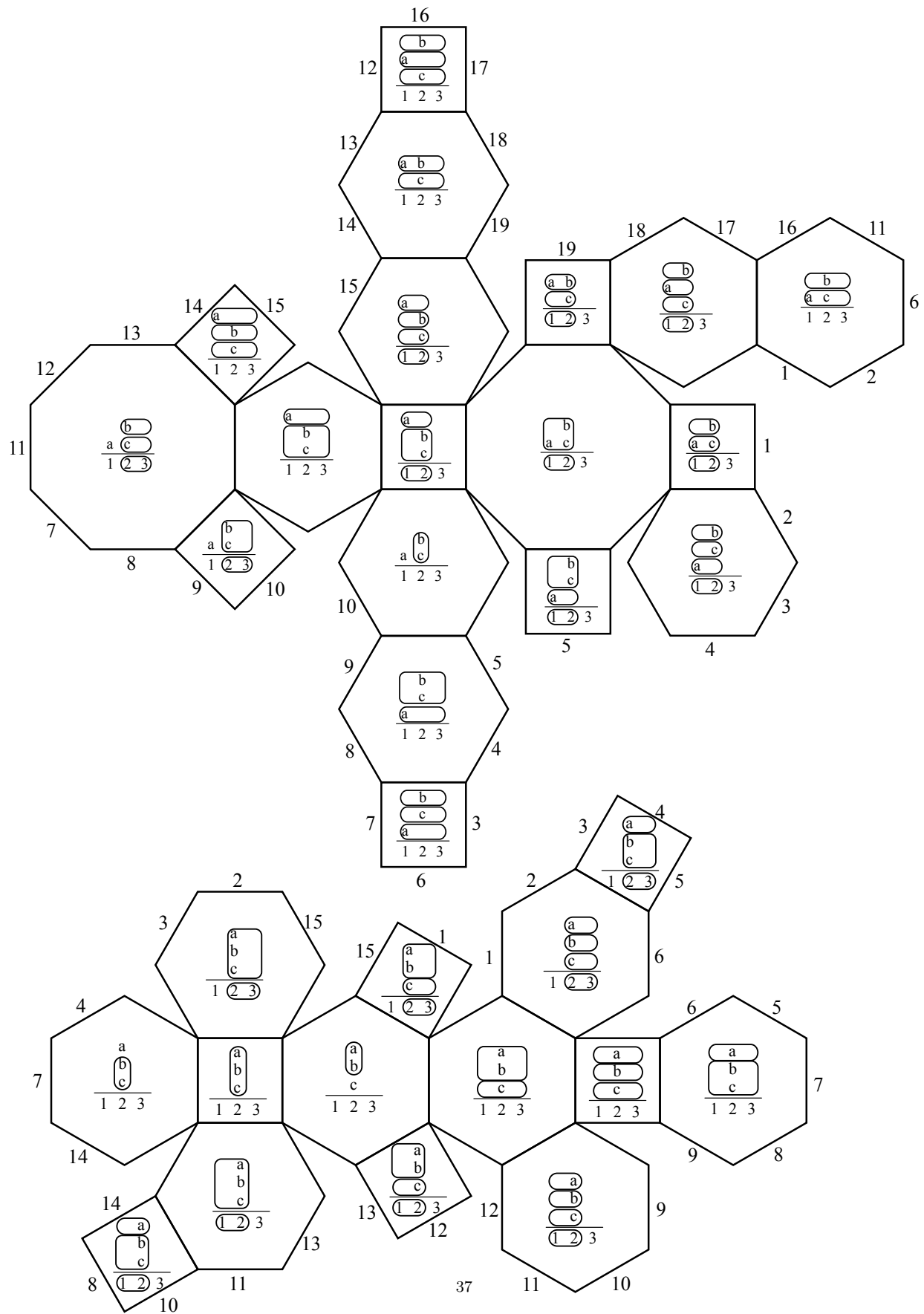

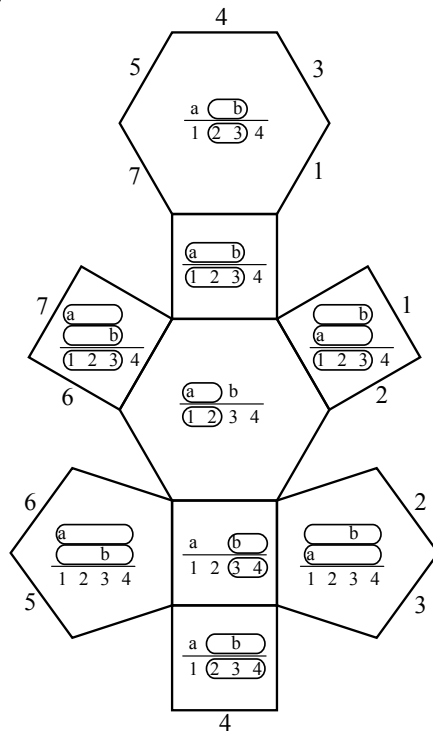
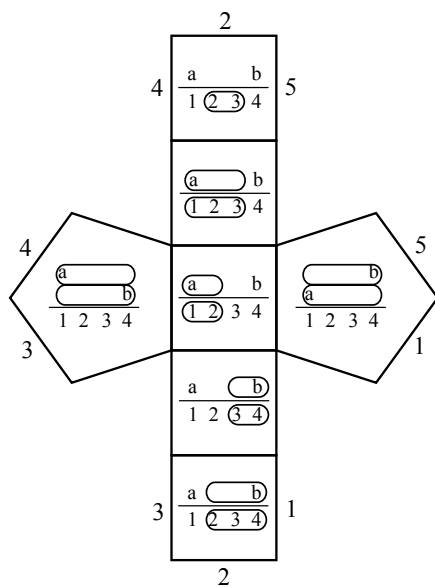
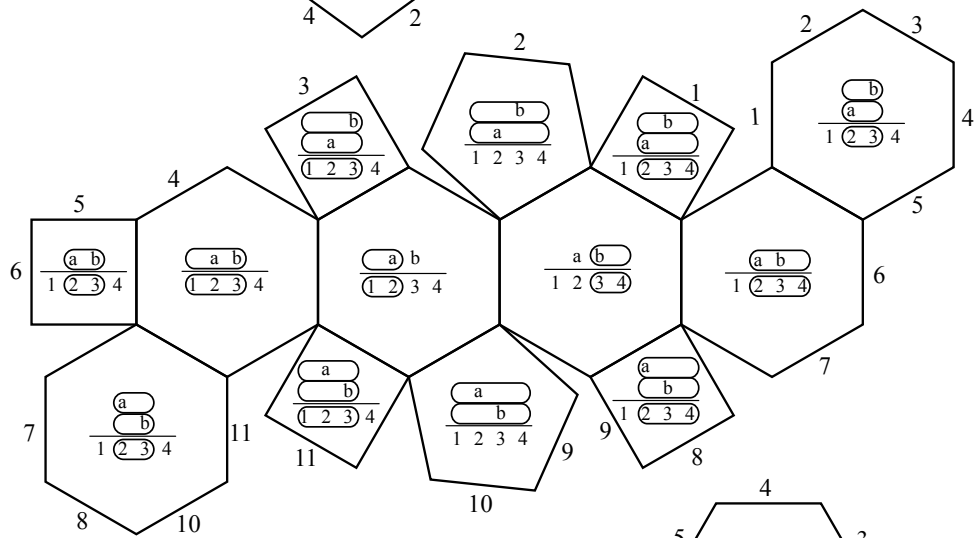
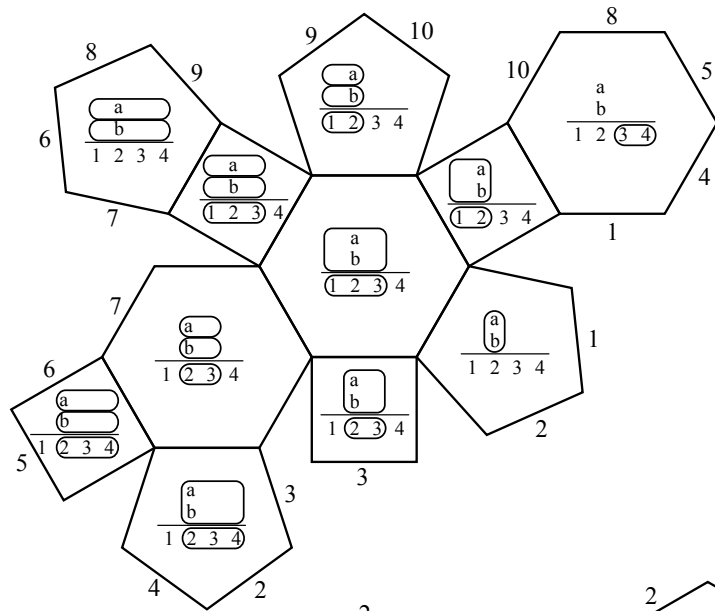

REFERENCES

- [Ba1] M.A. Batanin. Configuration spaces from Combinatorial, Topological and Categorical perspectives. Lecture given on September 27, 2006. Slides available at <http://maths.mq.edu.au/~street/BatanAustMSMq.pdf>.
- [Ba2] M.A. Batanin. Monoidal globular categories as a natural environment for the theory of weak n -categories. *Adv. Math.* 136 (1998), no. 1, 39-103.
- [Ba3] M.A. Batanin. Symmetrisation of n -operads and compactification of real configuration spaces. *Adv. Math.* 211 (2007), no. 2, 684–725.
- [B1] N. Bottman. Moduli spaces of witch curves. In preparation.
- [B2] N. Bottman. Pseudoholomorphic quilts with figure eight singularity. Thesis, MIT, 2015.
- [B3] N. Bottman. Pseudoholomorphic quilts with figure eight singularity. arXiv:arXiv:1410.3834.
- [BW] N. Bottman, K. Wehrheim. Gromov compactness for squiggly strip shrinking in pseudoholomorphic quilts. arXiv:1503.03486.
- [MWW] S. Ma'u, K. Wehrheim, C. Woodward. A_∞ functors for Lagrangian correspondences. arXiv:1601.04919.
- [MSS] M. Markl, S. Shnider, J.D. Stasheff. *Operads in algebra, topology and physics*, volume 96 of *Mathematical Surveys and Monographs*. American Mathematical Society, Providence, RI, 2007.
- [MS] D. McDuff, D.A. Salamon. *J-holomorphic curves and symplectic topology*, volume 52 of *American Mathematical Society Colloquium Publications*. American Mathematical Society, Providence, RI, 2004. Second edition.
- [V] Alexander A. Voronov. Homotopy Gerstenhaber algebras. *Conférence Moshé Flato 1999, Vol. II (Dijon)*, pp. 307-331, *Math. Phys. Stud.*, 22, Kluwer Acad. Publ., Dordrecht, 2000.