

Michele Colledanchise and Petter Ögren

Behavior Trees in Robotics and AI

An Introduction

Contents

1	What are Behavior Trees?	3
1.1	A Short History of BTs	4
1.2	What is wrong with FSMs? The Need for Reactiveness and Modularity	4
1.3	Classical Formulation of BTs	6
1.3.1	Execution Example of a BT	9
1.3.2	Control Flow Nodes with Memory	10
1.4	Creating a BT for Pac-Man from Scratch	12
1.5	Creating a BT for a Mobile Manipulator Robot	14
1.6	Use of BTs in Robotics and AI	16
1.6.1	BTs in autonomous vehicles	16
1.6.2	BTs in industrial robotics	18
1.6.3	BTs in the Amazon Picking Challenge	20
1.6.4	BTs inside the social robot JIBO	21
2	How Behavior Trees Generalize and Relate to Earlier Ideas	23
2.1	Finite State Machines	23
2.1.1	Advantages and disadvantages	24
2.1.2	Hierarchical Finite State Machines	24
2.1.3	Creating a FSM that works like a BTs	29
2.1.4	Creating a BT that works like a FSM	31
2.2	Subsumption Architecture	31
2.2.1	Advantages and disadvantages	32
2.2.2	How BTs Generalize the Subsumption Architecture	33
2.3	Teleo-Reactive programs	34
2.3.1	Advantages and disadvantages	35
2.3.2	How BTs Generalize Teleo-Reactive Programs	35
2.4	Decision Trees	35
2.4.1	Advantages and disadvantages	36
2.4.2	How BTs Generalize Decision Trees	37
2.5	Advantages and Disadvantages of Behavior Trees	38

2.5.1	Advantages	38
2.5.2	Disadvantages	42
3	Design principles	45
3.1	Improving Readability using Explicit Success Conditions	45
3.2	Improving Reactivity using Implicit Sequences	46
3.3	Handling Different Cases using a Decision Tree Structure	47
3.4	Improving Safety using Sequences	47
3.5	Creating Deliberative BTs using Backchaining	49
3.6	Creating Un-Reactive BTs using Memory Nodes	51
3.7	Choosing the Proper Granularity of a BT	52
4	Analysis of Efficiency, Safety, and Robustness	55
4.1	Statespace Formulation of BTs	55
4.2	Efficiency and Robustness	58
4.3	Safety	62
4.4	Examples	66
4.4.1	Robustness and Efficiency	66
4.4.2	Safety	69
4.4.3	Complex BT	73
5	Formal Analysis of How Behavior Trees Generalize Earlier Ideas	77
5.1	How BTs Generalize Decision Trees	77
5.2	How BTs Generalize the Subsumption Architecture	79
5.3	How BTs Generalize Sequential Behavior Compositions	81
5.4	How BTs Generalize TRs	82
5.4.1	Universal TRs and FT-Successful BTs	84
6	Stochastic BTs	87
6.1	Stochastic BTs	88
6.1.1	Markov Chains and Markov Processes	89
6.1.2	Formulation	91
6.2	Transforming a SBT into a DTMC	96
6.2.1	Computing Transition Properties of the DTMC	99
6.3	Reliability of a SBT	101
6.3.1	Average sojourn time	101
6.3.2	Mean Time To Fail and Mean Time To Succeed	103
6.3.3	Probabilities Over Time	104
6.3.4	Stochastic Execution Times	105
6.3.5	Deterministic Execution Times	105
6.4	Examples	107
	References	117

Quotes on Behavior Trees

“There are a lot of different ways to create AI’s, and I feel like I’ve tried pretty much all of them at one point or another, but ever since I started using behavior trees, I wouldn’t want to do it any other way. I wish I could go back in time with this information and do some things differently.”¹

Mike Weldon
Disney, Pixar

“[...]. Sure you could build the very same behaviors with a finite state machine (FSM). But anyone who has worked with this kind of technology in industry knows how fragile such logic gets as it grows. A finely tuned hierarchical FSM before a game ships is often a temperamental work of art not to be messed with!”²

Alex J. Champandard
Editor in Chief & Founder AiGameDev.com,
Senior AI Programmer Rockstar Games

“Behavior trees offer a good balance of supporting goal-oriented behaviors and reactivity.”³

Daniel Broder
Unreal Engine developer

“The main advantage [of Behavior Trees] is that individual behaviors can easily be reused in the context of another higher-level behavior, without needing to specify how they relate to subsequent behaviors, [1]”.

Andrew Bagnell et al.
Carnegie Mellon University.

¹ http://www.gamasutra.com/blogs/ChrisSimpson/20140717/221339/Behavior_trees_for_AI_How_they_work.php

² <http://aigamedev.com/open/article/fsm-age-is-over/>

³ <https://forums.unrealengine.com/showthread.php?6016-Behavior-Trees-What-and-Why>

Chapter 1

What are Behavior Trees?

A Behavior Tree (BT) is a way to structure the switching between different tasks¹ in an autonomous agent, such as a robot or a virtual entity in a computer game. An example of a BT can be seen in Fig. 1.1a. As will be explained, BTs are a very efficient way of creating complex systems that are both *modular* and *reactive*. These properties are crucial in many applications, which has led to the spread of BT from computer game programming to many branches of AI and Robotics.

In this book, we will first give an introduction to BTs, in the present chapter. Then, in Chapter 2 we describe how BTs relate to, and in many cases generalize, earlier switching structures. These ideas are then used as a foundation for a set of efficient and easy to use design principles described in Chapter 3. Properties such as safety, robustness, and efficiency are important for an autonomous system, and in Chapter 4 we describe a set of tools for formally analyzing these using a state space description of BTs. With the new analysis tools, we can formalize the descriptions of how BTs generalize earlier approaches in Chapter 5. Finally, we describe an extended set of tools to capture the behavior of Stochastic BTs, where the outcomes of actions are described by probabilities, in Chapter 6. These tools enable the computation of both success probabilities and time to completion.

In this chapter, we will first tell a brief history of BTs in Section 1.1, and explain what are the core benefits of BTs, in Section 1.2, then in Section 1.3 we will describe how a BT works. Then, we will create a simple BT for the video game Pac-Man in Section 1.4 and a more sophisticated BT for a mobile manipulator in Section 1.5. We finally describe the usage of BT in a number of applications in Section 1.6.

¹ assuming that an activity can somehow be broken down into reusable sub-activities called *tasks* sometimes also denoted *actions* or *control modes*

1.1 A Short History of BTs

BTs were developed in the video game industry, as a tool to increase modularity in the control structures of Non-Player Characters (NPCs) [18, 7, 19, 25, 36]. In this billion-dollar industry, modularity is a key property that enables reuse of code, incremental design of functionality, and efficient testing.

In games, the control structures of NPCs were often formulated in terms of Finite State Machines (FSMs). However, just as Petri Nets [29] provide an alternative to FSMs that supports *concurrency*, BTs provide an alternative view of FSMs that supports *modularity*.

Following the development in the industry, BTs have now also started to receive attention in academia [22, 30, 38, 3, 33, 23, 1, 21, 8, 12, 17, 15].

At Carnegie Mellon University, BTs have been used extensively to do robotic manipulation [1, 12]. The fact that modularity is the key reason for using BTs is clear from the following quote from [1]: “The main advantage is that individual behaviors can easily be reused in the context of another higher-level behavior, without needing to specify how they relate to subsequent behaviors”.

BTs have also been used to enable non-experts to do robot programming of pick and place operations, due to their “modular, adaptable representation of a robotic task” [15] and allowed “end-users to visually create programs with the same amount of complexity and power as traditionally-written programs” [34]. Furthermore, BTs have been proposed as a key component in brain surgery robotics due to their “flexibility, reusability, and simple syntax” [17].

The advantages of BTs as compared to FSMs was the reason for extending the so-called *JADE agent Behavior Model* with BTs in [3], and the benefits of using BTs to control complex multi mission UAVs was described in [33].

The modularity of BTs was used to address the formal verification of mission plans in [21] while the execution time of stochastic BTs was analyzed in [8]. BTs have also been studied in machine learning applications [22, 30] and details regarding efficient parameter passing were investigated in [38]. Finally, a Modelica implementation of BTs was presented in [20].

1.2 What is wrong with FSMs? The Need for Reactiveness and Modularity

Many autonomous agents need to be both reactive and modular. By reactive we mean the ability to quickly and efficiently react to changes. We want a robot to slow down and avoid a collision if a human enters into its planned trajectory and we want a virtual game character to hide, flee, or fight, if made aware of an approaching enemy. By modular, we mean the degree to which a system’s components may be separated into building blocks, and recombined [13]. We want the agent to be modular, to enable components to be developed, tested, and reused independently of one

another. Since complexity grows with size, it is beneficial to be able to work with components one at a time, rather than the combined system.

FSMs have long been the standard choice when designing a task switching structure, see e.g. [35, 26]. FSMs will be discussed in detail in Chapter 2.1, but here we make a short description of the tradeoff between reactivity and modularity that is inherent in FSMs. This tradeoff can be understood in terms of the classical Goto-statement that was used in early programming languages. The Goto statement is an example of a so-called *one-way control transfer*, where the execution of a program jumps to another part of the code and continue executing from there. Instead of *one-way control transfers*, modern programming languages tend to rely on *two-way control transfers* embodied in e.g. function calls. Here, execution jumps to a particular part of the code, executes it, and then returns to where the function call was made. The drawbacks of *one-way control transfers* were made explicit by Edsger Dijkstra in his paper *Goto statement considered harmful* [10], where he states that “The Goto statement as it stands is just too primitive; it is too much an invitation to make a mess of one’s program”. Looking back at the state transitions in FSMs, we note that they are indeed *one-way control transfers*. This is where the tradeoff between reactivity and modularity is created. For the system to be reactive, there needs to be many transitions between components, and many transitions means many *one-way control transfers* which, just as Dijkstra noted, harms modularity by being an “invitation to make a mess of one’s program”. If, for example, one component is removed, every transition to that component needs to be revised. As will be seen, BTs use *two-way control transfers*, governed by the internal nodes of the trees.

Using BTs instead of FSMs to implement the task switching, allows us to describe the desired behavior in modules as depicted in Figure 1.1a. Note that in the next section we will describe how BTs work in detail, so these figures are just meant to give a first glimpse of BTs, rather than the whole picture.

A behavior is often composed of a sequence of sub-behaviors that are task independent, meaning that while creating a sub-behavior the designer does not need to know which sub-behavior will be performed next. Sub-behaviors can be designed recursively, adding more details as in Figure 1.1b. BTs are executed in a particular way, which will be described in the following section, that allows the behavior to be carried out reactively. For example, the BTs in Figure 1.1 execute the sub-behavior *Place Ball*, but also verifies that the ball is still at a known location and securely grasped. If, due to an external event, the ball slips out of the grasp, then the robot will abort the sub-behavior *Place Ball* and will re-execute the sub-behavior *Pick Ball* or *Find Ball* according to the current situation.

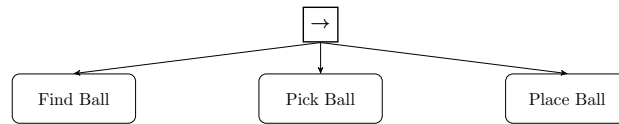

(a) A high level BT carrying out a task consisting of first finding, then picking and finally placing a ball.

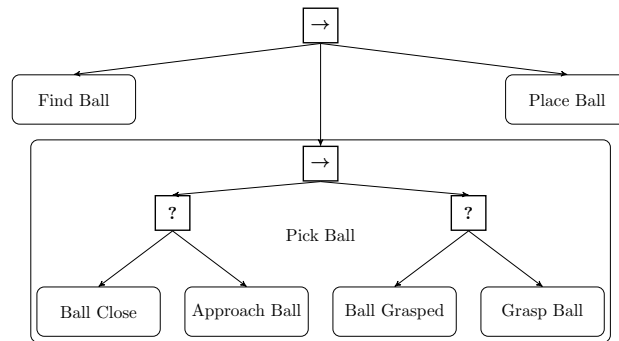

(b) The action Pick Ball from the BT in Fig. 1.1a is expanded into a sub-BT. The Ball is approached until it is considered close, and then the action grasp is executed until the ball is securely grasped.

Fig. 1.1: Illustrations of a BT carrying out a pick and place task with different degrees of detail. The execution of a BT will be described in Section 1.3.

1.3 Classical Formulation of BTs

At the core, BTs are built from a small set of simple components, just as many other powerful concepts, but throughout this book, we will see how this simple formalism can be used to create very rich structures, in terms of both applications and theory.

Formally speaking, a BT is a directed rooted tree where the internal nodes are called *control flow nodes* and leaf nodes are called *execution nodes*. For each connected node we use the common terminology of *parent* and *child*. The root is the node without parents; all other nodes have one parent. The control flow nodes have at least one child. Graphically, the children of a node are placed below it, as shown in Figures 1.2-1.4.

A BT starts its execution from the root node that generates signals that allow the execution of a node called *ticks* with a given frequency, which are sent to its children. A node is executed if and only if it receives ticks. The child immediately returns *running* to the parent, if its execution is under way, *success* if it has achieved its goal, or *failure* otherwise.

In the classical formulation, there exist four categories of control flow nodes (sequence, fallback, parallel, and decorator) and two categories of execution nodes (action and condition). They are all explained below and summarized in Table 1.1.

The sequence node executes Algorithm 1, which corresponds to routing the ticks to its children from the left until it finds a child that returns either *failure* or *running*, then it returns *failure* or *running* accordingly to its own parent. It returns *success* if and only if all its children return *success*. Note that when a child returns *running* or *failure*, the sequence node does not route the ticks to the next child (if any). The symbol of the sequence node is a box containing the label “→”, shown in Figure 1.2.

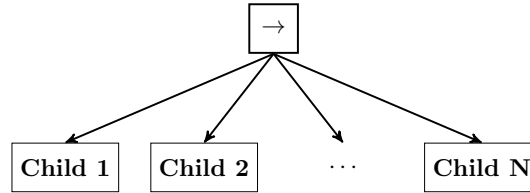

Fig. 1.2: Graphical representation of a sequence node with N children.

Algorithm 1: Pseudocode of a Sequence node with N children

```

1 for  $i \leftarrow 1$  to  $N$  do
2    $childStatus \leftarrow Tick(child(i))$ 
3   if  $childStatus = running$  then
4     return  $running$ 
5   else if  $childStatus = failure$  then
6     return  $failure$ 
7 return  $success$ 

```

The fallback node² executes Algorithm 2, which corresponds to routing the ticks to its children from the left until it finds a child that returns either *success* or *running*, then it returns *success* or *running* accordingly to its own parent. It returns *failure* if and only if all its children return *failure*. Note that when a child returns *running* or *success*, the fallback node does not route the ticks to the next child (if any). The symbol of the the fallback node is a box containing the label “?”, shown in Figure 1.3.

The parallel node executes Algorithm 3, which corresponds to routing the ticks to all its children and it returns *success* if M children return *success*, it returns *failure* if $N - M + 1$ children return *failure*, and it returns *running* otherwise, where N is the number of children and $M \leq N$ is a user defined threshold. The symbol of the the parallel node is a box containing the label “ \rightrightarrows ”, shown in Figure 1.4.

² Fallback nodes are sometimes also called *selector* nodes.

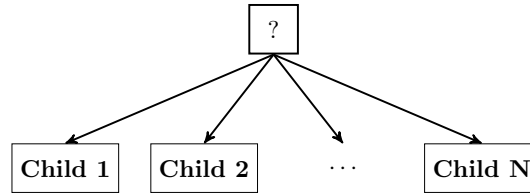

Fig. 1.3: Graphical representation of a fallback node with N children.

Algorithm 2: Pseudocode of a Fallback node with N children

```

1 for  $i \leftarrow 1$  to  $N$  do
2    $childStatus \leftarrow Tick(child(i))$ 
3   if  $childStatus = running$  then
4     return  $running$ 
5   else if  $childStatus = success$  then
6     return  $success$ 
7 return  $failure$ 
  
```

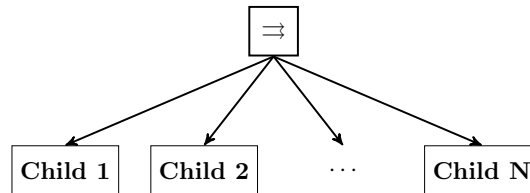

Fig. 1.4: Graphical representation of a parallel node with N children.

Algorithm 3: Pseudocode of a Parallel node with N children and success threshold M

```

1 for  $i \leftarrow 1$  to  $N$  do
2    $childStatus(i) \leftarrow Tick(child(i))$ 
3 if  $\sum_{i:childStatus(i)=success} 1 \geq M$  then
4   return  $Success$ 
5 else if  $\sum_{i:childStatus(i)=failure} 1 > N - M$  then
6   return  $failure$ 
7 return  $running$ 
  
```

When it receives ticks, an action node executes a command. It returns *success* if the action is correctly completed or *failure* if the action has failed. While the action is ongoing it returns *running*. An action node is shown in Figure 1.5a.

When it receives ticks, a condition node checks a proposition. It returns *success* or *failure* depending on if the proposition holds or not. Note that a condition node never returns a status of *running*. A condition node is shown in Figure 1.5b.

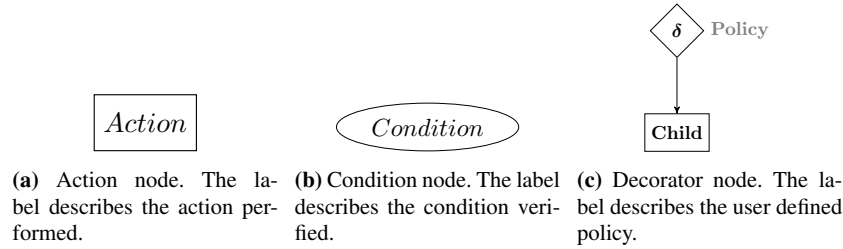

Fig. 1.5: Graphical representation of action (a), condition (b), and decorator (c) node.

The decorator node is a control flow node with a single child that manipulates the return status of its child according to a user-defined rule and also selectively ticks the child according to some predefined rule. For example, an *invert* decorator inverts the *success/failure* status of the child; a *max-N-tries* decorator only lets its child fail N times, then always returns *failure* without ticking the child; a *max-T-sec* decorator lets the child run for T seconds then, if the child is still running, the decorator returns *failure* without ticking the child. The symbol of the the decorator is a rhombus, as in Figure 1.5c.

Node type	Symbol	Succeeds	Fails	Running
Fallback	?	If one child succeeds	If all children fail	If one child returns running
Sequence	→	If all children succeed	If one child fails	If one child returns running
Parallel	⇒	If $\geq M$ children succeed	If $> N - M$ children fail	else
Action	text	Upon completion	If impossible to complete	During completion
Condition	text	If true	If false	Never
Decorator	◇	Custom	Custom	Custom

Table 1.1: The node types of a BT.

1.3.1 Execution Example of a BT

Consider the BT in Figure 1.6 designed to make an agent look for a ball, approach it, grasp it, proceed to a bin, and place the ball in the bin. This example will illustrate the execution of the BT, including the reactivity when another (external) agent takes the ball from the first agent, making it switch to looking for the ball and approaching it again. When the execution starts, the ticks traverse the BT reaching the condition node *Ball Found*. The agent does not know the ball position hence the condition node returns *failure* and the ticks reach the action *Find Ball*, which returns *running* (see Figure 1.7a). While executing this action, the agent sees the ball with the camera. In

this new situation the agent knows the ball position. Hence the condition node *Ball Found* now returns *success* resulting in the ticks no longer reaching the action node *Find Ball* and the action is preempted. The ticks continue exploring the tree, and reach the condition node *Ball Close*, which returns *failure* (the ball is far away) and then reach the action node *Approach Ball*, which returns *running* (see Figure 1.7b). Then the agent eventually reaches the ball, picks it up and goes towards the bin (see Figure 1.7c). When an external agent moves the ball from the hand of the first agent to the floor (where the ball is visible), the condition node *Ball Found* returns *success* while the condition node *Ball Close* returns *failure*. In this situation the ticks no longer reach the action *Approach Bin* (which is preempted) and they instead reach the action *Approach Ball* (see Figure 1.7d).

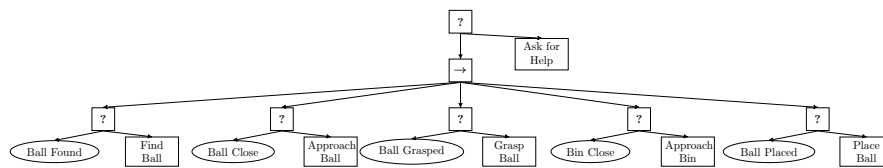

Fig. 1.6: BT encoding the behavior of Example 2.1.

1.3.2 Control Flow Nodes with Memory

As seen in the example above, to provide reactivity the control flow nodes sequence and fallback keep sending ticks to the children to the left of a running child, in order to verify whether a child has to be re-executed and the current one has to be preempted. However, sometimes the user knows that a child, once executed, does not need to be re-executed.

Nodes with memory [25] have been introduced to enable the designer to avoid the unwanted re-execution of some nodes. Control flow nodes with memory always remember whether a child has returned *success* or *failure*, avoiding the re-execution of the child until the whole sequence or fallback finishes in either *success* or *failure*. In this book, nodes with memory are graphically represented with the addition of the symbol “*” (e.g. a sequence node with memory is graphically represented by a box with a “→*”). The memory is cleared when the parent node returns either *success* or *failure*, so that at the next activation all children are considered. Note however that every execution of a control flow node with memory can be obtained with a non-memory BT using some auxiliary conditions as shown in Figure 1.8. Hence nodes with memory can be considered to be syntactic sugar.

Remark 1.1. Some BT implementations, such as the one described in [25], do not include the *running* return status. Instead, they let each action run until it returns

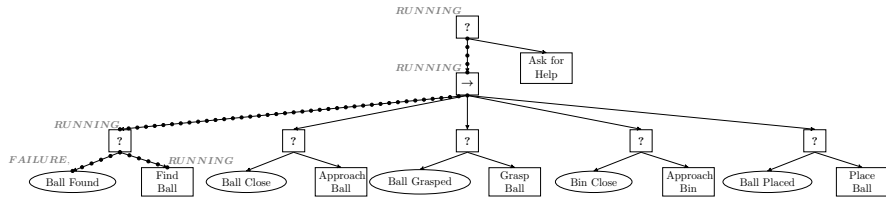

(a) Ticks' traversal when the robot is searching the ball.

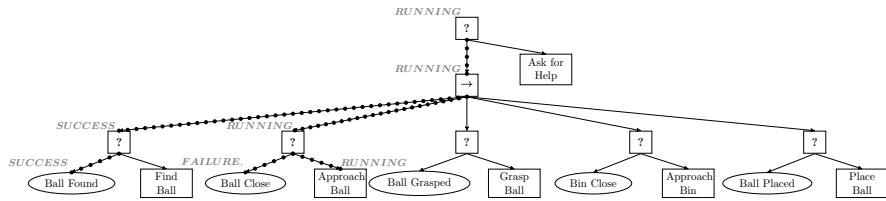

(b) Ticks' traversal while the robot is approaching the ball.

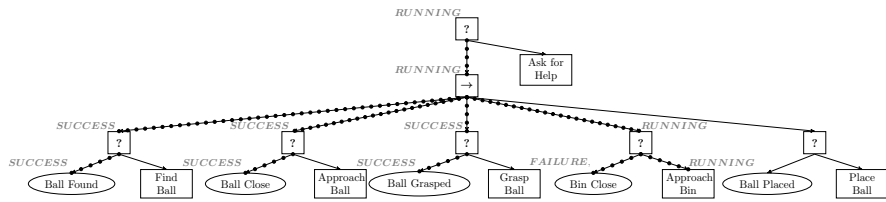

(c) Ticks' traversal while the robot is approaching the bin.

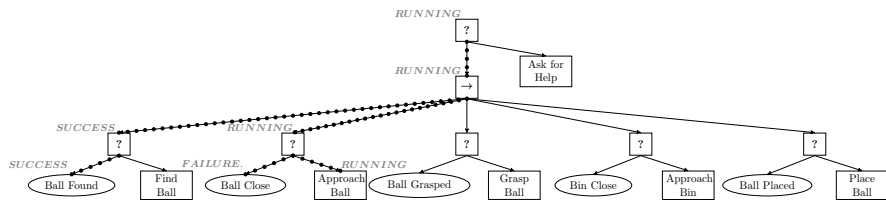

(d) Ticks' traversal while the robot is approaching the ball again (because it was removed from the hand).

Fig. 1.7: Visualization of the ticks' traversal in the different situations, as explained in Section 1.3.1.

failure or *success*. We denote these BTs as *non-reactive*, since they do not allow actions other than the currently active one to react to changes. This is a significant limitation on non-reactive BTs, which was also noted in [25]. A non-reactive BT can be seen as a BT with only memory nodes.

As reactivity is one of the key strengths of BTs, the non-reactive BTs are of limited use.

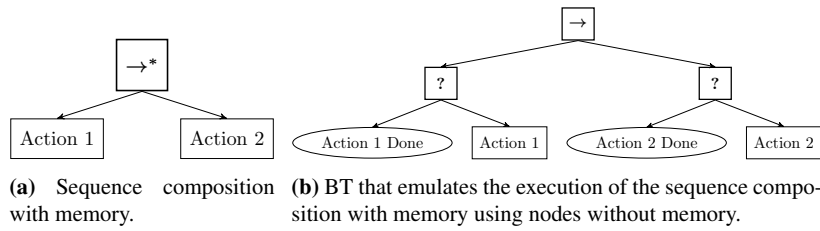

Fig. 1.8: Relation between memory and memory-less BT nodes.

1.4 Creating a BT for Pac-Man from Scratch

In this section we create a set of BTs of increasing complexity for playing the game Pac-Man. The source code of all the examples is publicly available and editable, see Appendix A. We use a clone of the Namco's Pac-Man computer game depicted in Figure 1.9³.

In the testbed, a BT controls the agent, Pac-Man, through a maze containing two ghosts, a large number of pills, including two so-called power pills. The goal of the game is to consume all the pills, without being eaten by the ghosts. The power pills are such that, if eaten, Pac-Man receives temporary super powers, and is able to eat the ghosts. After a given time the effect of the power pill wears off, and the ghosts can again eat Pac-Man. When a ghost is eaten, it returns to the center box where it is regenerated and becomes dangerous again. Edible ghosts change color, and then flash to signal when they are about to become dangerous again.

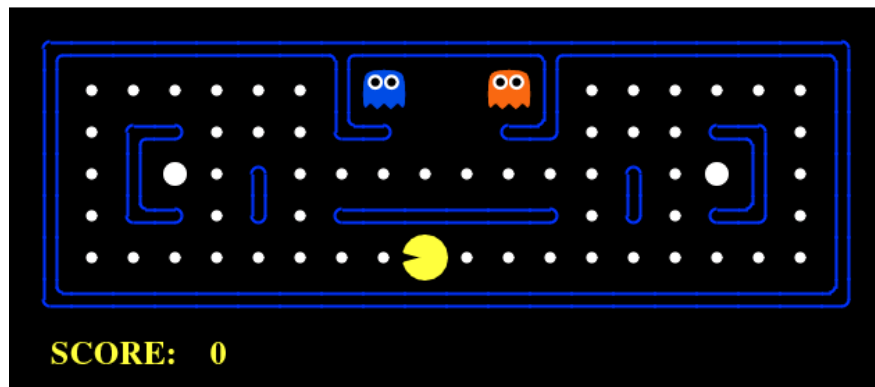

Fig. 1.9: The game Pac-Man for which we will design a BT. There exists maps of different complexity.

³ The software was developed at UC Berkeley for educational purposes. More information available at: http://ai.berkeley.edu/project_overview.html

The simplest behavior is to let Pac-Man ignore the ghosts and just focus on eating pills. This is done using a greedy action *Eat pills* as in Figure 1.10.



Fig. 1.10: BT for the simplest non-random behavior, *Eat pills*, which maximizes the number of pills eaten in the next time step.

The simple behavior described above ignores the ghosts. To take them into account, we can extend the previous behavior by adding an *Avoid Ghosts* action to be executed whenever the condition *Ghost Close* is true. This action will greedily maximize the distance to all ghosts. The new action and condition can be added to the BT as depicted in Fig. 1.11. The resulting BT will switch between *Eat Pills* and *Avoid Ghost* depending on whether *Ghost Close* returns success or failure.

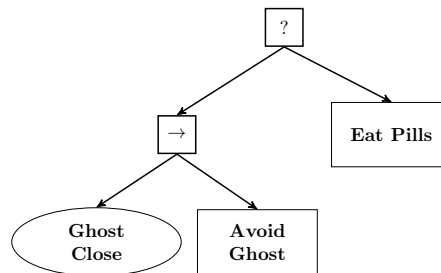

Fig. 1.11: If a Ghost is Close, the BT will execute the action *Avoid Ghost*, else it will run *Eat Pills*.

The next extension we make is to take the power pills into account. When Pac-Man eats a Power pill, the ghosts are edible, and we would like to chase them, instead of avoiding them. To do this we add the condition *Ghost Scared* and the action *Chase Ghost* to the BT, as shown in Fig. 1.12. *Chase Ghost* greedily minimizes the distance to the closest edible ghost. Note that we only start chasing the ghost if it is close, otherwise we continue eating pills. Note also that all extensions are modular, without the need to rewire the previous BT.

With this incremental design, we have created a basic AI for playing Pac-Man, but what if we want to make a world class Pac-Man AI? You could add additional nodes to the BT, such as moving towards the Power pills when being chased, and stop chasing ghosts when they are blinking and soon will transform into normal ghosts. However, much of the fine details of Pac-Man lies in considerations of the Maze geometry, choosing paths that avoid dead ends and possible capture by multiple ghosts. Such spatial analysis is probably best done inside the actions, e.g., making *Avoid Ghosts* take dead ends and ghost positions into account. The question

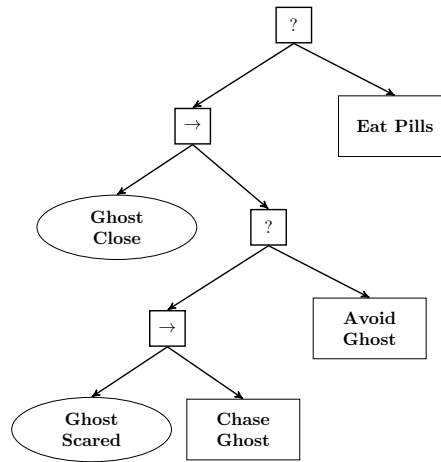

Fig. 1.12: BT for the Combative Behavior

of what functionality to address in the BT structure, and what to take care of inside the actions is open, and must be decided on a case to case basis, as discussed in Section 3.7.

1.5 Creating a BT for a Mobile Manipulator Robot



Fig. 1.13: The Mobile Manipulator for which we will design a BT.

In this section, we create a set of BTs of increasing complexity for controlling a mobile manipulator. The source code of all the examples is publicly available and editable. See Appendix B. We use a custom-made testbed created in the V-REP robot simulator depicted in Figure 1.13.

In the testbed, a BT controls a mobile manipulator robot, a youBot, on a flat surface. In the scenario, there are several colored cubes lying on a flat surface. The goal is to move the green cube to the goal area while avoiding the other cubes. The youBot's grippers are such that the robot is able to pick and place the cubes if the robot is close enough.

The simplest possible BT is to check the goal condition *Green Cube on Goal*. If this condition is satisfied (i.e. the cube is on the goal) the task is done, if it is not satisfied the robot needs to *place the cube* onto the goal area. To correctly execute the action *Place Cube*, two conditions need to hold: the robot *is holding the green cube* and the robot *is close to the goal area*. The behavior described so far can be encoded in the BT in Figure 1.14. This BT is able to place the green cube on the goal area if and only if the robot is close to the goal area with the green cube grasped.

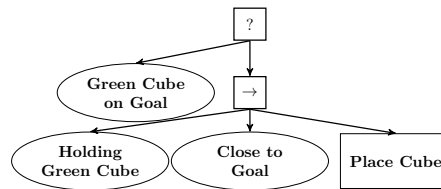
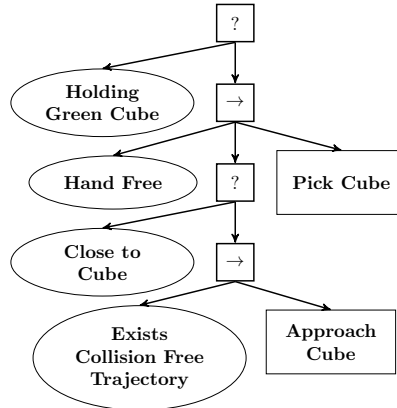

Fig. 1.14: BT for the simple Scenario.

Now, thanks to the modularity of BTs, we can separately design the BTs needed to satisfy the two lower conditions in Fig. 1.14, i.e., the BT needed to grasp the green cube and the BT needed to reach the goal area. To grasp the green cube, the robot needs to have the *hand free* and be *close to the cube*. If it is not close, it approaches as long as a collision free trajectory exists. This behavior can be encoded in the BT in Figure 1.15a. To reach the goal area we let the robot simply *Move To the Goal* as long as a *collision free trajectory exists*. This behavior can be encoded in the BT in Figure 1.15b.

Now we can extend the simple BT above by replacing the two lower conditions in Fig. 1.14 with the two BTs in Fig. 1.15. The result can be seen in Fig. 1.16. Using this design, the robot is able to place the green cube in the goal area as long as there exists a collision free trajectory to the green cube and to the goal area.

We can continue to incrementally build the BT in this way to handle more situations, for instance removing obstructing objects to ensure that a *collision free trajectory exists*, and dropping things in the hand to be able to pick the green cube up.



(a) A BT that picks the green cube.

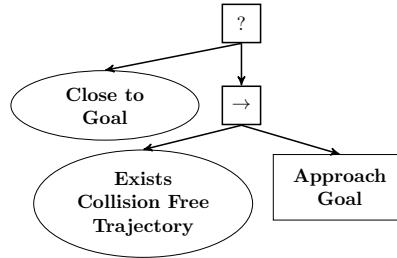

(b) A BT that reaches the goal region.

Fig. 1.15: Illustrations of a BT carrying out the subtasks of picking the green cube and reaching the goal area

1.6 Use of BTs in Robotics and AI

In this section we describe the use of BTs in a set of real robot applications and projects, spanning from autonomous navigation to industrial robotics.

1.6.1 BTs in autonomous vehicles

There is no standard CA for autonomous vehicles, however reviewing the CAs used to address the DARPA Grand Challenge, a competition for autonomous vehicles, we note that most teams employed FSMs designed and developed exactly for that challenge [40, 41]. Some of them used a HFSM[26] decomposing the mission task in multiple sub-tasks in a hierarchy.

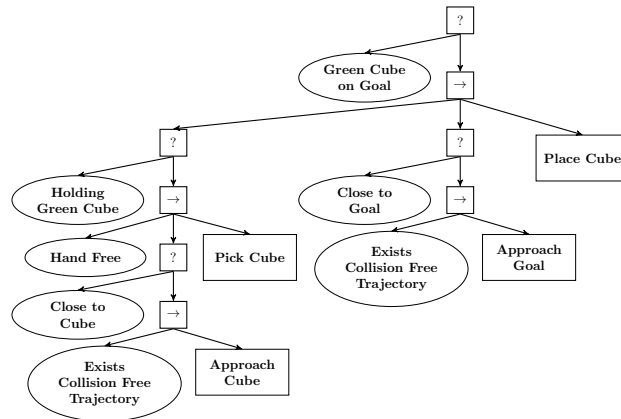

Fig. 1.16: Final BT resulting from the aggregation of different BTs.



Fig. 1.17: Trucks running the Scania iQmatic's software.⁴

iQmatic is a Scania led project that aims at developing a fully autonomous heavy vehicle, i.e. a truck, for goods transport; mining; and other industrial applications. The vehicle's software has to be reusable, maintainable and easy to develop. For these reasons, the iQmatic's developers chose BTs as the CA for the project. BTs are appreciated in iQmatic for their human readability, that support the design and

⁴ Picture courtesy of Scania.com

development of early prototypes; and their maintainability, that makes the editing task easier. Figure 1.17 shows two trucks used in the iQmatic project.

1.6.2 BTs in industrial robotics

Industrial robots usually operate in structured environments and their CA is designed for a single specific task. Hence classical CAs such as FSMs or Petri Nets [29] have found successful applications in the last decades. However, future generations of industrial robots, so-called cobots, will operate in less structured environments and collaborate closely with humans. Several research projects explore this research direction.



Fig. 1.18: Experimental platform of the CoSTAR project.⁵

CoSTAR [34] is a project that aims at developing a software framework that contains tools for industrial applications that involve human cooperation. The use cases include non trained operators composing task plans, and training robots to perform complex behaviors. BTs have found successful applications in this project as they simplify the composition of sub-tasks. The order in which the sub-tasks are executed is independent from the sub-task implementation; this enables easy composition of trees and the iterative composition of larger and larger trees. Figure 1.18 shows one of the robotic platforms of the project.

⁵ Picture courtesy of <http://cpaxton.github.io/>



Fig. 1.19: Experimental platform of the SARAFun project.⁶

SARAFun⁷ is a project that aims at developing a robot-programming framework that enables a non-expert user to program an assembly task from scratch on a robot in less than a day. It takes advantages of state of the art techniques in sensory and cognitive abilities, robot control, and planning.

BTs are used to execute the generic actions learned or planned. For the purpose of this project, the CA must be human readable, enable code reuse, and modular. BTs have created advantages also during the development stage, when the code written by different partners had to be integrated. Figure 1.19 shows an ABB Yumi robot used in the SARAFun testbed.

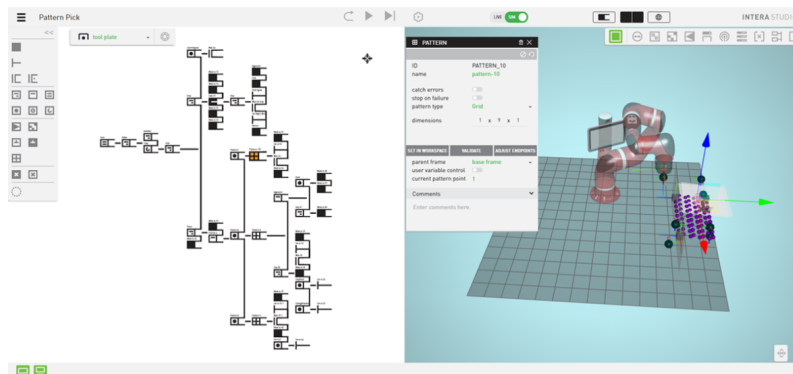

Fig. 1.20: Intera's BT (left) and simulation environment (right).⁸

⁷ <http://h2020sarafun.eu>

Rethink Robotics released its software platform Intera in 2017, with BTs at the “heart of the design”. Intera claims to be a “first-of-its-kind software platform that connects everything from a single robot controller, extending the smart, flexible power of Rethink Robotics’ Sawyer to the entire work cell and simplifying automation with unparalleled ease of deployment.”⁹ It is designed with the goal of creating the world’s fastest-to-deploy robot and fundamentally changing the concepts of integration, making it drastically easier and affordable.

Intera’s BT defines the sequence of tasks the robot will perform. The tree can be created manually or trained by demonstration. Users can inspect any portion of the BT and make adjustments. The Intera interface (see Figure 1.20) also includes a simulated robot, so a user can run simulations while the program executes the BT. BTs are appreciated in this context because the train-by-demonstration framework builds a BT that is easily inspectable and modifiable.¹⁰

1.6.3 BTs in the Amazon Picking Challenge

The Amazon Picking Challenge (APC) is an international robot competition. Robots need to autonomously retrieve a wide range of products from a shelf and put them into a container. The challenge was conceived with the purpose of strengthening the ties between industrial and academic robotic research, promoting shared solutions to some open problems in unstructured automation. Over thirty companies and research laboratories from different continents competed in the APC’s preliminary phases. The best performing teams earned the right to compete at the finals and the source codes of the finalists were made publicly available¹¹.

The KTH entry in the final challenge used BTs in both editions (2015 and 2016). BTs were appreciated for their modularity and code reusability, which allowed the integration of different functionalities developed by programmers with different background and coding styles. In 2015, the KTH entry got the best result out of the four teams competing with PR2 robots.

⁹ <http://www.rethinkrobotics.com/news-item/rethink-robotics-releases-intera-5-new-approach-automation/>

⁹ Setup located at CERTH, Thessaloniki, Greece. Picture courtesy of Angeliki Topalidou-Kyniazopoulou.

⁹ Picture courtesy of <http://www.rethinkrobotics.com/intera/>

¹⁰ <http://twimage.net/rodney-brooks-743452002>

¹¹ <https://github.com/amazon-picking-challenge>

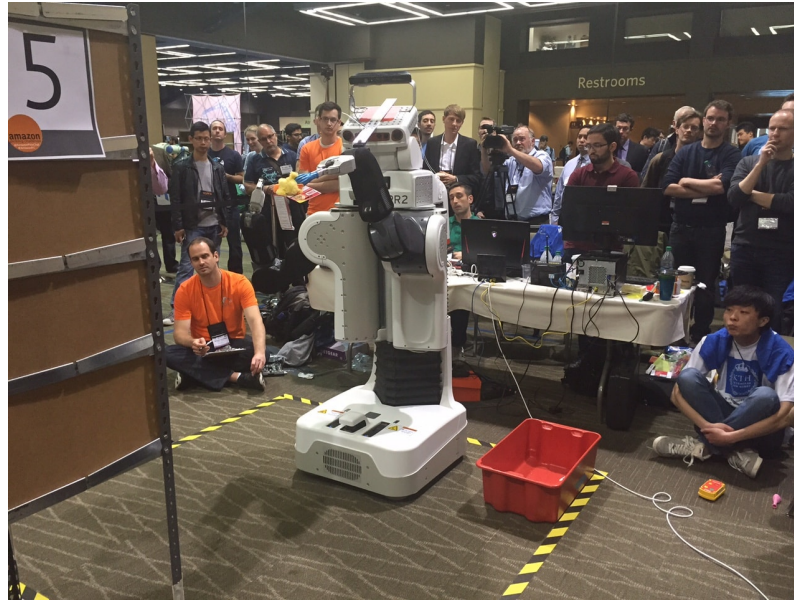

Fig. 1.21: The KTH entry in the Amazon Picking Challenge at ICRA 2015.

1.6.4 BTs inside the social robot JIBO

JIBO is a social robot that can recognize faces and voices, tell jokes, play games and share information. It is intended to be used in homes, providing the functionality of a tablet, but with an interface relying on speech and video instead of a touch screen. BTs are a fundamental part of the software architecture of JIBO¹², including an open SDK inviting external contributors to develop new skills for the robot.

¹² <https://developers.jibo.com/docs/behavior-trees.html>



Fig. 1.22: The JIBO social robot has an SDK based on BTs.

Chapter 2

How Behavior Trees Generalize and Relate to Earlier Ideas

In this chapter we describe how BT relate to, and often generalize, a number of well known control architectures including Finite State Machines (2.1), the Subsumption Architecture (2.2), the Teleo-Reactive Approach (2.3) and Decision Trees (2.4). We also present advantages and disadvantages of each approach. Finally, we list a set of advantages and disadvantages of BTs (2.5). Some of the results of this chapter were previously published in the journal paper [9].

2.1 Finite State Machines

A FSM is one of the most basic mathematical models of computation. The FSM consists of a set of states, transitions and events, as illustrated in Fig. 2.1 showing an example of a FSM designed to carry out a grab-and-throw task. Note that the discussion here is valid for all CAs based on FSMs, including Mealy [27] and Moore [24] machines.

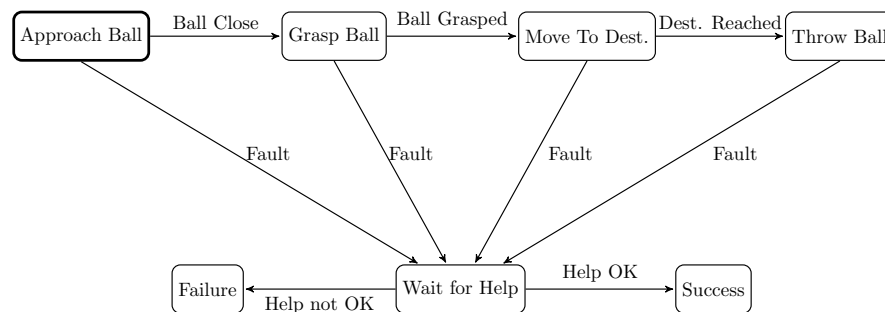

Fig. 2.1: Graphical representation of a FSM designed to carry out a simple grab-and-throw task. The initial state has a thicker border, and event names are given next to the corresponding transition arrows.

2.1.1 *Advantages and disadvantages*

FSMs are widely used due to their three main advantages:

- Very common structure, used in many different parts of computer science.
- Intuitive and easy to understand.
- Easy to implement.

However, the drawbacks of FSMs gives rise to problems when the system modelled grows in complexity and number of states, as described briefly in Section 1.2. In particular we have the following drawbacks

- Reactivity/Modularity tradeoff. A reactive system needs many transitions, and every transition corresponds to a goto-statement, see Section refsec:modularity. In particular, the transitions give rise to the problems below:
 - Maintainability: Adding or removing states requires to re-evaluate possibly all the transitions and internal states of the whole FSM. This makes FSMs highly susceptible to human design errors and makes them inefficient to be used and generated by computer programs.
 - Scalability: FSMs with many states and many transitions between them are hard to modify, for both humans and computers.
 - Reusability: The transitions between states may depend on internal variables (like in a Hybrid Automaton), making it unpractical to encode the same task for use in multiple projects.

2.1.2 *Hierarchical Finite State Machines*

Hierarchical Finite State Machines (HFSMs), also known as State Charts[16], were developed to alleviate some of the disadvantages of FSMs. In a HFSM, a state can in turn contain one or more sub states. A state containing two or more states is called a *super state*. In a HFSM, a *generalized transition* is a transition between super states. Generalized transitions can reduce the number of transitions by connecting two super states rather than connecting a larger number of sub states individually. Each super state has one sub state identified as the starting state, executing whenever a transition to the super state occurs. Figure 2.2 shows an example of a HFSM for a video game character.

2.1.2.1 *Advantages and disadvantages*

The main advantages of HFSMs are:

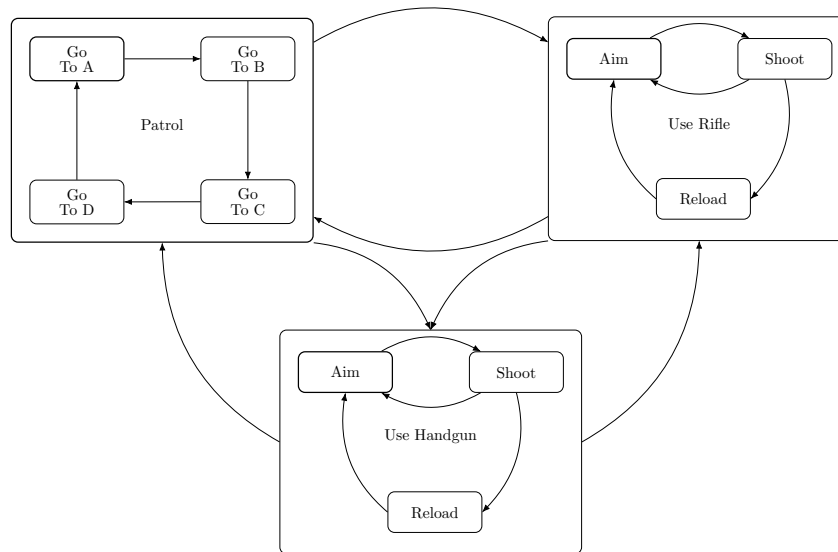

Fig. 2.2: Example of a HFSM controlling a NPC of a combat game. *Patrol*, *Use Rifle*, and *Use Handgun* are superstates.

- **Increased Modularity:** it is possible to separate the tasks in sub-tasks. However these sub-tasks often still depend on each other through state-dependent transitions.
- **Behavior inheritance:** The state nesting in HFSMs allows so-called *behavior inheritance*. Behavior inheritance allows sub-states to inherit behaviors from the superstate; for example, in the HFSM depicted in Figure 2.2, while in the sub-states inside *Use Handgun*, the character holds the weapon using one hand whereas while in the sub-states inside *Use Rifle*, the character holds the weapon using two hands. Thus, there is no need for the sub states to specify this property, instead, it is inherited from the superstate.

The main disadvantages of HFSMs are:

- **Maintainability:** Adding or removing states is still hard. A long sequence of actions, with the possibility of going back in the sequence and re-execute a task that was undone by external agents (e.g. the environment), still requires a fully connected sub-graph.
- **Manually created hierarchy:** Although HFSMs were conceived as a hierarchical version of FSMs, the hierarchy has to be user defined and editing such a hierarchy can be difficult. The hierarchy resolves some problems, but a reactive HFSM still results in some sub graphs being fully connected with many possible transitions, see Fig. 2.3.

From a theoretical standpoint, every execution described by a BT can be described by a FSM and vice-versa [33, 23]. However, due to the number of transitions, using a FSM as a CA is unpractical for some applications as shown in Chapter 1. Moreover, a potential problem is that a FSM does not assume that the propositions triggering the outgoing transitions from the same state are mutually exclusive. When implemented, the propositions are checked regularly in discrete time, hence there exists a non-zero probability that two or more propositions hold simultaneously after one cycle. To solve this problem we need to redefine some transitions, as done in the FSM in Figure 2.22, making the propositions of the outgoing transitions mutually exclusive. A FSM of this format is impractical to design for both humans and computers. Adding and removing behaviors by a human is prone to errors. After adding a new state, each existing transition must be re-evaluated (possibly removed or replaced) and new transitions from/to the new state must be evaluated as well. A high number of transitions make any automated process to analyze or synthesize FSMs computationally expensive.

HFSMs is the most similar CA to BTs in terms of purpose and use. To compare BTs with HFSMs we use the following complex example. Consider the HFSM shown in Figure 2.3 describing the behavior of a humanoid robot. We can describe the same functionality using the BT shown in Figure 2.4. Note that we have used the standard notation [16] of HFSMs to denote two activities running in parallel with a dashed line as separation. One important difference is that, in HFSMs, each layer in the hierarchy needs to be added explicitly, whereas in BTs every sub-tree can be seen as a module of its own, with the same interface as an atomic action.

In the HFSM shown in Figure 2.3, a proposition needs to be given for each transition, and to improve readability we have numbered these propositions from C1 to C10. In the top layer of the HFSM we have the sub-HFSMs of *Self Protection* and *Perform Activities*. Inside the latter we have two parallel sub-HFSMs. One is handling the user interaction, while the larger one contains a complete directed graph handling the switching between the different activities. Finally, *Play Ball Game* is yet another sub-HFSM with the ball tracking running in parallel with another complete directed graph, handling the reactive switching between *Approach Ball*, *Grasp Ball*, and *Throw Ball*.

It is clear from the two figures how modularity is handled by the HFSM. The explicitly defined sub-HFSM encapsulates *Self Protection*, *Perform Activities* and *Play Ball Game*. However, inside these sub-HFSMs, the transition structure is a complete directed graph, with $n(n - 1)$ transitions that need to be maintained (n being the number of nodes).

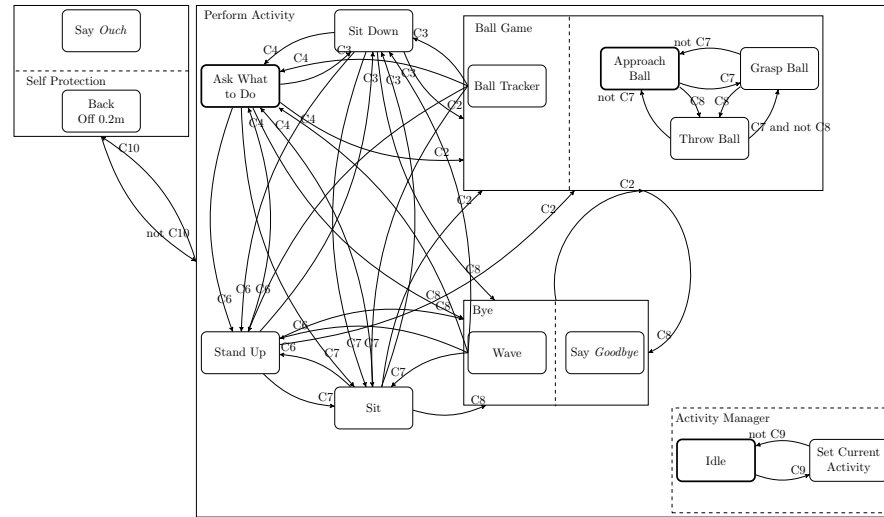

Fig. 2.3: A HFSM description of the BT in Figure 2.4. The transition conditions are shown at the end of each arrow to indicate the direction of the transition. Note how the complexity of the transitions *within* each layer of the HFSM grows with the number of nodes. The conditions labels are: C1 = Activity Sit, C2 = Not Know What to Do, C3 = Activity Stand Up, C4 = Activity Sleep, C5 = Activity Ball Game, C6 = Ball Close, C7 = Ball Grasped, C8 = New User Suggestion, C9 = Activity Sit, C10 = Bumper Pressed.

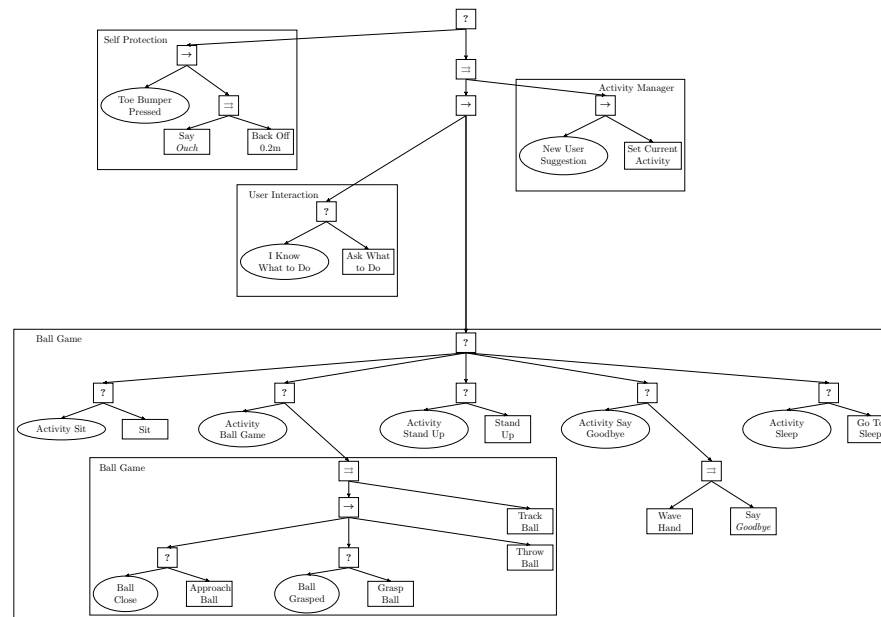

Fig. 2.4: A BT that combines some capabilities of the NAO robot in an interactive and modular way. Note how atomic actions can easily be replaced by more complex sub-BTs.

2.1.3 Creating a FSM that works like a BTs

As described in Chapter 1, each BT returns *Success*, *Running* or *Failure*. Imagine we have a state in an FSM that has 3 transitions, corresponding to these 3 return statements. Adding a Tick source that collect the return transitions and transfer the execution back into the state, as depicted in Figure 2.5, we have a structure that resembles a BT.

We can now compose such FSM states using both Fallback and Sequence constructs. The FSM corresponding to the Fallback example in Figure 2.6 would then look like the one shown in Figure 2.7.

Similarly, the FSM corresponding to the Sequence example in Figure 2.8 would then look like the one shown in Figure 2.9, and a two level BT, such as the one in Figure 2.10 would look like Figure 2.11.

A few observations can be made from the above examples. First, it is perfectly possible to design FSMs with a structure taken from BTs. Second, considering that a BT with 2 levels corresponds to the FSM in Figure 2.11, a BT with 5 levels, such as the one in Figure 2.12 would correspond to a somewhat complex FSM.

Third, and more importantly, the *modularity* of the BT construct is illustrated in Figures 2.5-2.11. Figure 2.11 might be complex, but that complexity is encapsulated in a box with a single in-transition and three out-transitions, just as the box in Figure 2.5.

Fourth, as was mentioned in Section 1.2, the decision of what to do after a given sub-BT returns is always decided on the parent level of that BT. The sub-BT is ticked, and returns *Success*, *Running* or *Failure* and the parent level decides whether to tick the next child, or return something to its own parent. Thus, the BT ticking and returning of a sub-BT is similar to a *function call* in a piece of source code, just as described in Section 1.2. A function call in Java, C++ or Python moves execution to another piece of the source code, but then returns the execution to the line right below the function call. What to do next is decided by the piece of code that made the function call, not the function itself. As we will see below, this is quite different

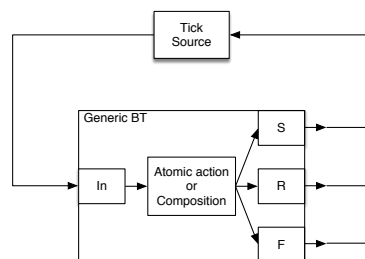

Fig. 2.5: An FSM behaving like a BT, made up of a single normal state, three out transitions Success (S), Running (R) and Failure (F), and a Tick source.

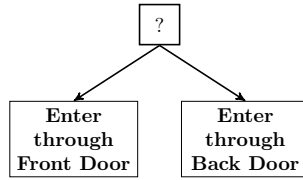

Fig. 2.6: A Fallback is used to create an *Enter Building* BT. The back door option is only tried if the front door option fails. Fallbacks are denoted by a white box with a question mark and Actions are denoted by a green box.

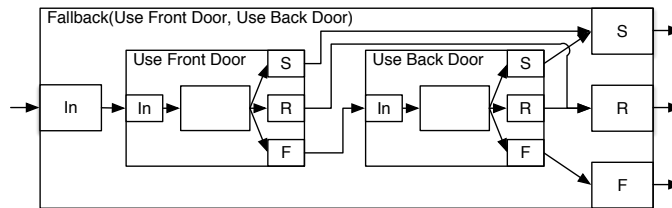

Fig. 2.7: A FSM corresponding to the Fallback BT in Figure 2.6. Note how the second state is only executed if the first fails.

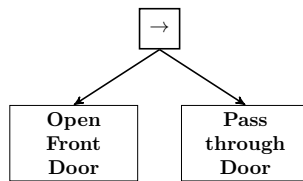

Fig. 2.8: A Sequence is used to create an *Enter Through Front Door* BT. Passing the door is only tried if the opening action succeeds. Sequences are denoted by a white box with an arrow.

from standard FSMs where the decision of what to do next is decided by the state being transitioned to, in a way that resembles the Goto statement.

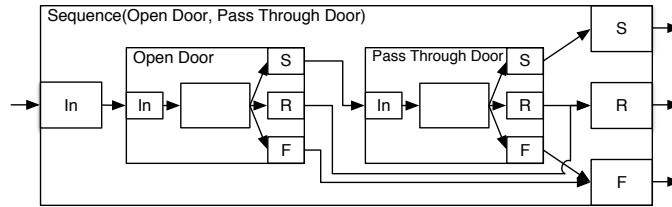

Fig. 2.9: An FSM corresponding to the Sequence BT in Figure 2.8. Note how the second state is only executed if the first succeeds.

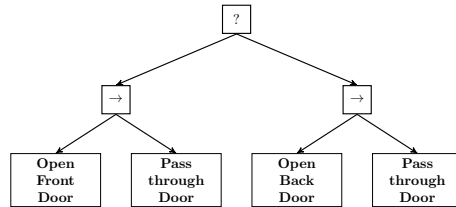

Fig. 2.10: The two BTs in Figures 2.6 and 2.8 are combined to larger BT. If e.g. the robot opens the front door, but does not manage to pass through it, it will try the back door.

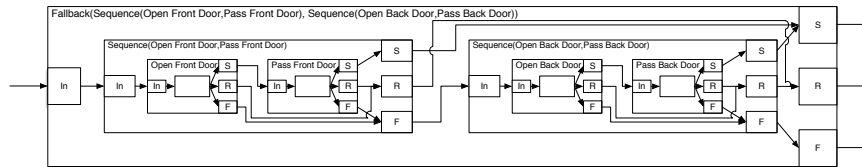

Fig. 2.11: An FSM corresponding to the BT in Figure 2.10.

2.1.4 Creating a BT that works like a FSM

If you have a FSM design and want to convert it to a BT, the most straight forward way is to create a *State Variable* available to all parts of the BT and then list all the states of the FSM and their corresponding transitions and actions as shown in Figure 2.13.

2.2 Subsumption Architecture

The Subsumption Architecture [4] is heavily associated with the behavior-based robotic architecture, which was very popular in the late 1980s and 90s. This archi-

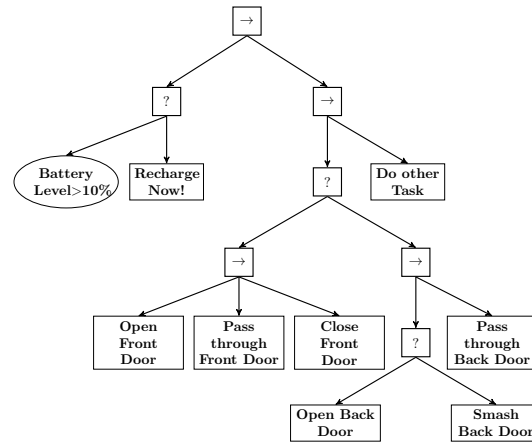

Fig. 2.12: Combining the BTs above and some additional Actions, we get a flexible BT for entering a building and performing some task.

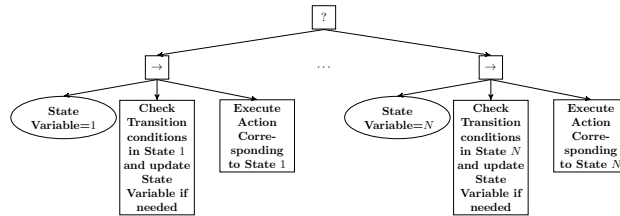

Fig. 2.13: Example of a straightforward translation of a FSM to a BT using a global *State Variable*.

ecture has been widely influential in autonomous robotics and elsewhere in real-time AI and has found a number of successful applications [5]. The basic idea of the Subsumption Architecture is to have several controllers, each one implementing a task, running in parallel. Each controller is allowed to output both its actuation commands and a binary value that signifies if it wants to control the robot or not. The controllers are ordered according to some priority (usually user defined), and the highest priority controller, out of the ones that want to control the robot, has the access to the actuators. Thus, a controller with a higher priority is able to subsume a lower level one. Figure 2.14 shows an example of a Subsumption Architecture.

2.2.1 Advantages and disadvantages

The Subsumption Architecture has many practical advantages, in particular:

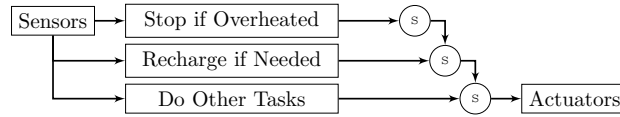

Fig. 2.14: Example of Subsumption Architecture composed by three controllers. The controller *Stop if Overheated* subsumes the controller *Recharge if Needed*, which subsumes the controller *Do Other Tasks*.

- **Easy development:** The Subsumption Architecture is naturally well suited for iterative development and testing.
- **Modularity:** The Subsumption Architecture connects limited, task-specific actions.
- **Hierarchy:** The controllers are hierarchically ordered, which makes it possible to define high priority behaviors (e.g. safety guarantees) that override others.

The main disadvantages of the Subsumption Architecture are:

- **Scalability:** Designing complex action selection through a distributed system of inhibition and suppression can be hard.
- **Maintainability:** Due to the lack of structure, the consequences of adding or removing controllers can be hard to estimate.

2.2.2 How BTs Generalize the Subsumption Architecture

There is a straightforward mapping from a Subsumption Architecture design to a BT using a fallback node. If each controller in the SA is turned into a BT action, returning running if the binary output indicates that it wants to run and failure the rest of the time, a standard fallback composition will create an equivalent BT. As an example we see that the structure in Fig. 2.14 is represented by the BT in Fig. 2.15. A more formal argument using a state space representation of BTs will be given in Section 5.2.

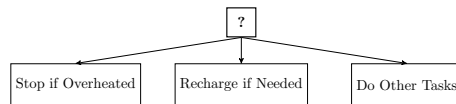

Fig. 2.15: A BT version of the subsumption example in Figure 2.14.

2.3 Teleo-Reactive programs

Teleo-Reactive (TR) programs were introduced by Nils Nilsson [31] at Stanford University in 1994 to allow engineers to define the behavior of a robotics system that had to achieve specific goals while being responsive to changes in the environment. A TR program is composed of a set of prioritized condition-action rules that directs the agent towards a goal state (hence the term *teleo*) while monitoring the environmental changes (hence the term *reactive*). In its simplest form, a TR program is described by a list of condition-action rules as the following:

$$\begin{aligned} c_1 &\rightarrow a_1 \\ c_2 &\rightarrow a_2 \\ &\dots \\ c_m &\rightarrow a_m \end{aligned}$$

where the c_i are conditions and a_i are actions. The condition-action rules list is scanned from the top until it finds a condition that holds, then the corresponding action is executed. In a TR program, actions are usually *durative* rather than discrete. A durative action is one that continues indefinitely in time (e.g. the action *move forwards* is a durative action, whereas the action *take one step* is discrete). In a TR program, a durative action is executed as long as its corresponding condition remains the one with the highest priority among the ones that hold. When the highest priority condition that holds changes, the action executed changes accordingly. Thus, the conditions must be evaluated continuously so that the action associated with the current highest priority condition that holds, is always the one being executed. A running action terminates when its corresponding condition ceases to hold or when another condition with higher priority takes precedence. Figure 2.16 shows an example of a TR program for navigating in an obstacle free environment.

$$\begin{aligned} \text{Equal}(\text{pos}, \text{goal}) &\rightarrow \text{Idle} \\ \text{Heading Towards}(\text{goal}) &\rightarrow \text{Go Forwards} \\ (\text{else}) &\rightarrow \text{Rotate} \end{aligned}$$

Fig. 2.16: Example of teleoreactive program carrying out a navigation task. If the robot is in the goal position, the action performed is *Idle* (no actions executed). Otherwise if it is heading towards the goal, the action performed is *Go Forwards*. Otherwise, the robot performs the action *Rotate*.

TR programs have been extended in several directions, including integrating TR programs with automatic planning and machine learning [2, 42], removing redundant parts of a TR program [28], and using TR programs to play robot soccer [14].

2.3.1 Advantages and disadvantages

The main advantages of a TR program are:

- Reactive execution: TR programs enable reactive executions by continually monitoring the conditions and aborting actions when needed.
- Intuitive structure: The list of condition-action rules is intuitive to design for small problems.

The main disadvantages of a TR program are:

- Maintainability: Due to its structure (a long list of rules), adding or removing condition-action rules is prone to cause errors when a TR program has to encode a complex system. In those cases, a TR program takes the shape of a long list.
- Failure handling: To enable failure handling, a TR program needs to have a condition that checks if an action fails.

2.3.2 How BTs Generalize Teleo-Reactive Programs

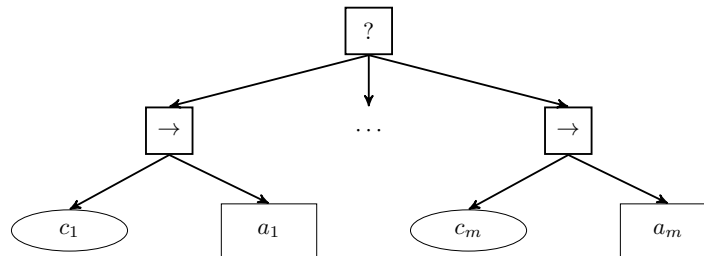

Fig. 2.17: The BT that is analogous to a given TR.

The core idea of continuously checking conditions and applying the corresponding rules can be captured using a Fallback node and pairs of conditions and actions. Thus, a general TR program can be represented in the BT of Fig. 2.17. A more formal argument using a state space representation of BTs will be given in Section 5.4.

2.4 Decision Trees

A Decision Tree (DT) is a directed tree that represents a list of nested if-then clauses used to derive decisions [37]. Leaf nodes describe decisions, conclusions, or actions

to be carried out, whereas non-leaf nodes describe predicates to be evaluated. Figure 2.18 shows a DT where according to some conditions, a robot will decide what to do.

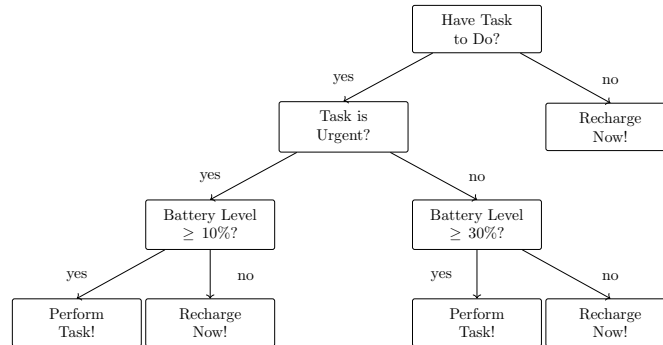

Fig. 2.18: Example of DT executing a generic robotic task. The predicate are evaluated traversing the tree in a top-down fashion.

2.4.1 Advantages and disadvantages

The main advantages of a DT are:

- Modularity: The DT structure is modular, in the sense that a sub-DT can be developed independently from the rest of the DT, and added where suitable.
- Hierarchy: DT's structure is hierarchical, in the sense that predicates are evaluated in a top-down fashion.
- Intuitive structure: It is straightforward to design and understand DTs.

The main disadvantages of a DT are:

- No information flow out from the nodes, giving an absence of failure handling
- Repetitions: To describe a reactive behavior, a given predicate must be reevaluated at different depths of the tree resulting in a DT with many repetitions.
- Maintainability: Due to repetitions, if the number of outgoing arcs from a predicate should change, this will affect the entire tree where such predicates appears.

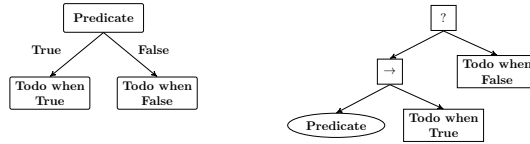

Fig. 2.19: The basic building blocs of Decision Trees are ‘If ... then ... else ...’ statements (left), and those can be created in BTs as illustrated above (right).

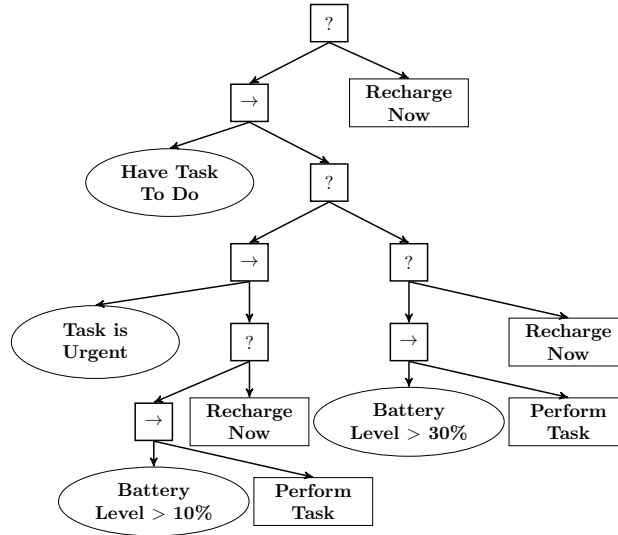

Fig. 2.20: A BT that is equivalent to the Decision Tree in Figure 2.18.

2.4.2 How BTs Generalize Decision Trees

A general DT can be converted into a BT using the mapping shown in Fig. 2.19. By converting the Predicate to a Condition, letting the leaves be actions always returning running, we can map each decision node of the DT to a small BT. Applying the mapping to the DT of Fig. 2.18 we get the BT of Fig. 2.20. A more formal argument using a state space representation of BTs will be given in Section 5.1. Note that this structure requires actions always returning running, reflecting the drawback of DTs that no information flows out of the actions

2.5 Advantages and Disadvantages of Behavior Trees

Having looked at how BTs relate to a set of existing control architectures we will now take a step back and list a number of advantages and disadvantages of BTs.

2.5.1 Advantages

As described in Section 1.2 many advantages stem from BTs being both modular and reactive. Below we list a set of advantages of BTs.

Modular: By modular, we mean the degree to which a system's components may be separated into building blocks, and recombined [13]. A modular system can be designed, implemented, tested and reused one module at a time. The benefits of modularity thus increases, the more complex a system is, by enabling a divide and conquer approach when designing, implementing and testing.

BTs are modular, since each subtree of a BT can be seen as a module in the above sense, with a standard interface given by the return statuses. Thus, BTs are modular on all scales ranging from the topmost subtrees to all the leaves of the tree.

Hierarchical organization: If a control architecture contains several levels of decision making it is denoted hierarchical. The possibility of designing and analyzing structures on different hierarchical levels is important for both humans and machines, as it enables e.g., iterative refinement and extensions of plan, see Section 3.5.

BTs are hierarchical, since each level of a BT automatically defines a level in the hierarchy.

Reusable code: Having reusable code is very important in any large, complex, long-term project. The ability to reuse designs relies in an essential way on the ability to build larger things from smaller parts, and on the independence of the input and output of those parts from their use in the project. To enable reuse of code, each module must interface the CA in a rigorous and well-defined fashion. BTs enable reusable code, since given the proper implementation, any subtree can be reused in multiple places of a BT. Furthermore, when writing the code of a leaf node, the developer needs to just take care of returning the correct return status which is universally predefined as either *running*, *success*, or *failure*. Unlike FSMs and HFMSMs, where the outgoing transitions require knowledge about the next state, in BTs leaf nodes are developed disregarding which node is going to be executed next. Hence, the BT logic is independent from the leaf node executions and vice versa.

Reactivity: By reactive we mean the ability to quickly and efficiently react to changes. For unstructured environments where outcomes of actions are not certain, and the state of the world is constantly changed by external actors, plans that

were created offline and then executed in an open loop fashion are often likely to fail.

BTs are reactive, since the continual generation of ticks and their tree traversal result in a closed loop execution. Actions are executed and aborted according to the ticks' traversal, which depends on the leaf nodes' return statuses. Leaf nodes are tightly connected with the environment (e.g. condition nodes evaluate the overall system properties and action nodes return *failure/success* if the action failed/succeeded). Thus, BTs are highly responsive to changes in the environment.

Human readable: A readable structure is desirable for reducing the cost of development and debugging, especially when the task is human designed. The structure should remain readable even for large systems. Human readability requires a coherent and compact structure.

BTs are human readable due to the tree structure and modularity.

Expressive: A control architecture must be sufficiently expressive to encode a large variety of behaviors.

BTs are at least as expressive as FSMs, see Section 2.1, the Subsumption Architecture, see Section 2.2, Teleo-reactive programs, see Section 2.3, and Decision Trees, see Section 2.4.

Suitable for analysis: Safety critical robot applications often require an analysis of qualitative and quantitative system properties. These properties include: safety, in the sense of avoiding irreversible undesired behaviors; robustness, in the sense of a large domain of operation; efficiency, in the sense of time to completion; reliability, in the sense of success probability; and composability, in the sense of analyzing whether properties are preserved over compositions of sub-tasks.

BTs have tools available to evaluate such system properties, see Chapters 4 and 5 below.

Suitable for automatic synthesis: In some problem instances, it is preferable that the action ordering of a task, or a policy, is automatically synthesized using task-planning or machine learning techniques. The CA can influence the efficiency of such synthesis techniques (e.g. a FSM with a large number of transitions can drastically deteriorate the speed of an algorithm that has to consider all the possible paths in the FSMs).

BTs are suitable for automatic synthesis in terms of both planning, see Section 3.5 and learning, see [cite Learning papers].

To illustrate the advantages listed above, we consider the following simple example.

Example 2.1. A robot is tasked to find a ball, pick it up and place it into a bin. If the robot fails to complete the task, it should go to a safe position and wait for a human operator. After picking up the ball (Figure 2.21a), the robot moves towards the bin (Figure 2.21b). While moving towards the bin, an external entity takes the ball from the robot's gripper (Figure 2.21c) and immediately throws it in front of the robot, where it can be seen (Figure 2.21d). The robot aborts the execution of moving and it starts to approach the ball again.

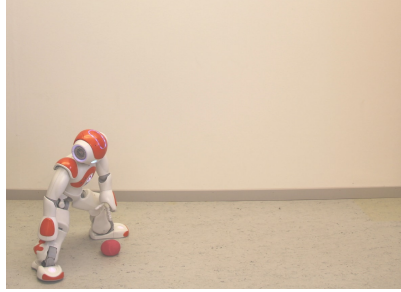

(a) The robot is picking up the ball.

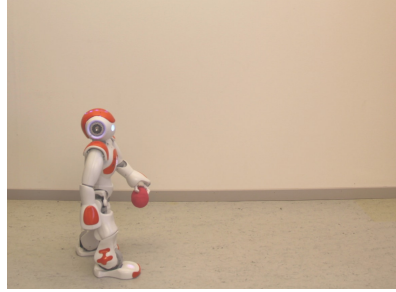

(b) The robot moves toward the bin (far away from the robot) with the ball in the hand.



(c) An external entity (a human) takes the ball from the robot gripper.



(d) The robot approaches the ball in the new location.

Fig. 2.21: Execution stages of Example 2.1.

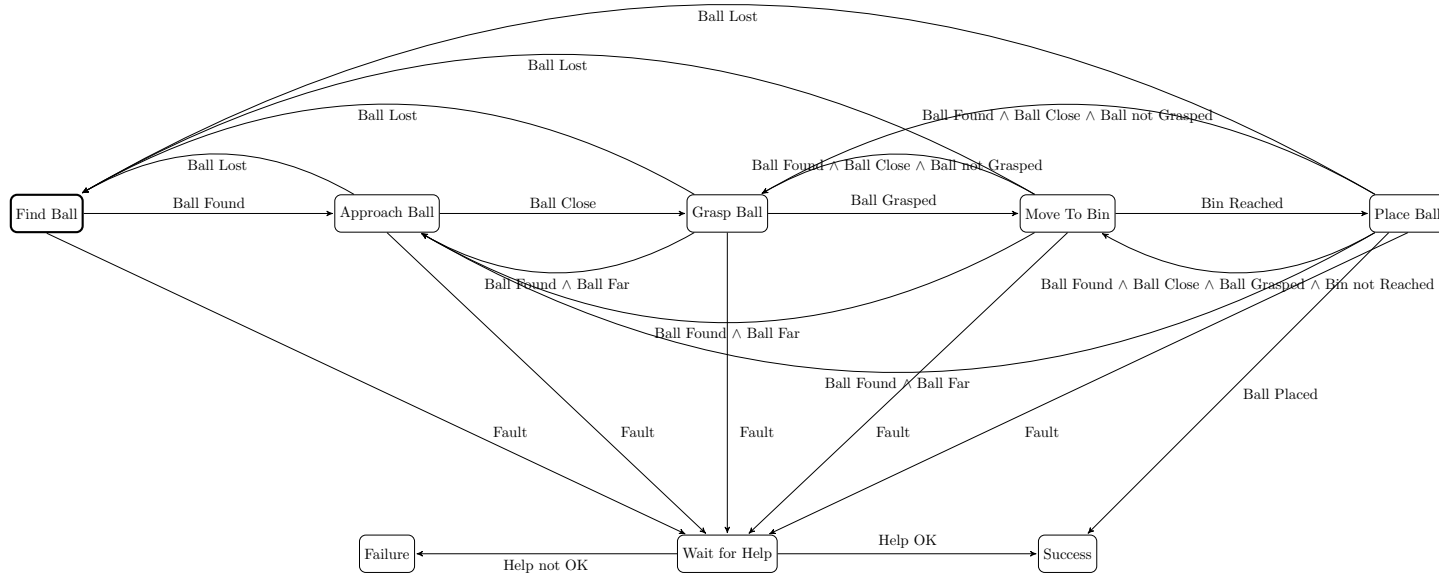

Fig. 2.22: FSM modeling the robot's behavior in Example 2.1. The initial state has a thicker border.

In this example, the robot does not simply execute a pick-and-place task. It *continually* monitors the progress of the actions, stops whenever needed, skips planned actions, decides the actions to execute, and responds to exogenous events. In order to execute some actions, the robot might need to inject new actions into the plan (e.g. the robot might need to empty the bin before placing the ball). Hence the task requires a CA suitable for extensions. These extensions might be man made (e.g. the robot asks the operator to update the current action policy) requiring a CA to be *human readable*, or automated (e.g. using model-based reasoning) requiring a CA to be *suitable for automatic synthesis*. In either case, to be able to easily extend and modify the action policy, its representation must be *modular*. In addition, new actions may subsume existing ones whenever needed (e.g. *empty the bin if it is full* must be executed before *place the ball*). This requires a *hierarchical* representation of the policy. Moreover there might be multiple different ways of carrying out a task (e.g. picking the ball using the left hand or the right hand). The robot must be able to decide which option is the best, requiring the CA to be *suitable for analysis*. Finally, once the policy is designed, it is desirable that it can be *reused* in other contexts.

Most used CAs do not show characteristics suitable for the properties described above. Take as an example a FSM modeling the behavior of the robot in Example 2.1, depicted in Figure 2.22. As it can be seen, even for this simple example the FSM gets fairly complex with many transitions.

2.5.2 Disadvantages

In this section we describe some disadvantages of BTs experienced by different BT developers.

The BT engine can be complex to implement. The implementation of the BT engine can get complicated using single threaded sequential programming. To guarantee the full functionality of BTs, the tick's generation and traversal should be executed in parallel with the action execution. However the BT engine only needs to be implemented once, it can be reused, and several BT engines are available as off the shelf software libraries.¹

Checking all the conditions can be expensive. A BT needs to check several conditions to implement the closed-loop task execution. In some applications this checking is expensive or not feasible. In those cases a closed-loop execution (using any CA) presents more costs than advantages. However it is still possible to design an open-loop task execution using BTs with memory nodes, see Section 1.3.2.

¹ C++ library: <https://github.com/miccol/Behavior-Tree>

ROS library: http://wiki.ros.org/behavior_tree

python library: <https://github.com/futureneer/beetree>

Sometimes a feed-forward execution is just fine. In applications where the robot operates in a very structured environment, predictable in space and time, BTs do not have any advantages over simpler CAs.

BTs are different from FSM. BTs, despite being easy to understand, require a new mindset when designing a task execution. The execution is not focused on states but on conditions and the execution is not event driven but tick driven. At least some of the design principles described in Chapter 3 needs to be learned and applied.

BTs are less mature. Although there is software for developing BTs, it is still far behind the amount and maturity of the software available for e.g. FSMs.

Chapter 3

Design principles

BTs are fairly easy to understand and use, but to make full use of their potential it can be good to be aware of a set of design principles that can be used in different situations. In this chapter we will describe these principles using a number of examples. First, in Section 3.1, we will describe the benefit of using explicit success conditions in sequences, then, in Section 3.2, we describe how the reactivity of a BT can be increased by creating implicit sequences, using fallback nodes. In Section 3.3, we show how BTs can also be designed in a way that is similar to Decision Trees. Then, in Section 3.4, we show how safety can be improved using sequences. Finally, in Section 3.7, we discuss the choice of granularity when designing a BT.

Note that these design principles are applicable at any level of a BT and can be combined freely.

Thus the safety principle can be combined with an implicit sequence etc.

3.1 Improving Readability using Explicit Success Conditions

One advantage of BTs is that the switching structure is clearly shown in the graphical representation of the tree. However, one detail that is not shown is the when the individual actions return success and failure.

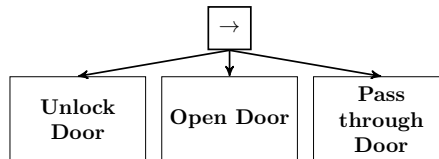

Fig. 3.1: Simple Sequence

Consider the sequence in Figure 3.1. One can assume that Unlock Door returns success when it has unlocked the door, but what if it is called when the door is already unlocked? Depending on the implementation it might either return success immediately, or actually try to unlock the door again, with the possibility of returning failure if the key cannot be turned further. A similar uncertainty holds regarding the implementation of Open Door (what if the door is already open?) and Pass through Door. To address this problem, and remove uncertainties regarding the implementation, explicit success conditions can be included in the BT.

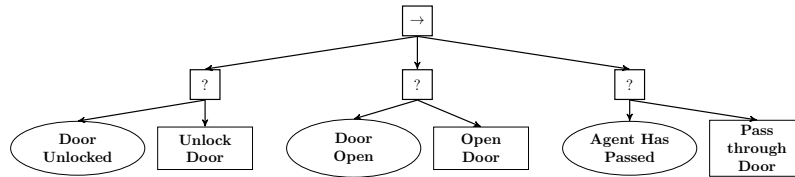

Fig. 3.2: Sequence with explicit success conditions. Note how each action is paired with a condition through a fallback node, making the success condition of the pair explicit.

In Figure 3.2, the BT from Figure 3.1 has been extended to include explicit success conditions. These conditions are added in a pair with the corresponding action using a Fallback node. Now, if the door is already unlocked and open, the two first conditions of Figure 3.2 will return Success, the third will return Failure, and the agent will proceed to execute the action Pass through Door.

3.2 Improving Reactivity using Implicit Sequences

It turns out that we can improve the reactivity of the BT in Figure 3.2 even further, using the fact that BTs generalize the Teleo-reactive approach, see Section 2.3.2. Consider the case when the agent has already passed the door, but the door is closed behind it. The BT in Figure 3.2 would then proceed to unlock the door, open it, and then notice that it had already passed it and return success.

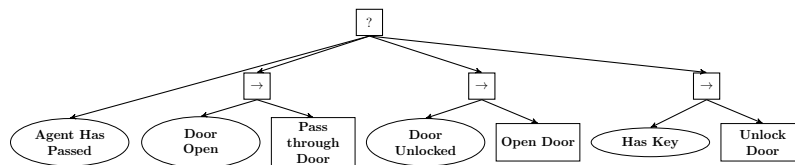

Fig. 3.3: An Implicit Sequence is constructed using a fallback node, reversing the order of the actions and pairing them with appropriate preconditions.

The key observation needed to improve reactivity is to realize that the goal is to get through the door, and that the other actions are just means to get to that goal. In the BT in Figure 3.3 we have reversed the order of the actions in order to check the goal state first. We then changed fallbacks to sequences and vice versa, and finally changed the conditions. Now, instead of checking outcomes, or success conditions as we did in Figure 3.2, we check preconditions, conditions needed to execute the corresponding actions, in Figure 3.3. First the BT checks if the agent has passed the door, if so it returns success. If not, it proceeds to check if the door is open, and if so passes through it. If neither of the previous conditions are satisfied, it checks if the door is unlocked, and if so starts to open it. As a final check, if nothing else returns success, it checks if it has the key to the door. If it does, it tries to open it, if not it returns failure.

The use of implicit sequences is particularly important in cases where the agent needs to undo some of its own actions, such as closing a door after passing it. A systematic way of creating implicit sequences is to use back chaining, as described in Section 3.5.

3.3 Handling Different Cases using a Decision Tree Structure

Sometimes, a reactive switching policy can be easily described in terms of a set of cases, much like a Decision Tree. Then, the fact that BTs generalize Decision Trees can be exploited, see Section 2.4.2.

A simple Pac-Man example can be found in Figure 3.4. The cases are separated by the two conditions Ghost Close and Ghost Scared. If no ghost is close, Pac-Man continues to eat pills. If a ghost is close, the BT checks the second condition, Ghost Scared, which turns true if Pac-Man eats a Power Pill. If the ghost is scared, Pac-Man chases it, if not, Pac-Man avoids the Ghost.

3.4 Improving Safety using Sequences

In some agents, in particular robots capable of performing irreversible actions such as damaging equipment, it is very important to be able to guarantee that some situations will never occur. These unwanted situations might be as simple as failing to reach the recharging station before running out of battery, or as serious as falling down a staircase and hurting someone.

A sequence node can be used to guarantee safety, as shown in Fig. 3.5. Looking closer at the BT in Fig. 3.5 we see that it will probably lead to an unwanted chattering behavior. It will recharge until it reaches just over 20% and then start doing Main Task, but the stop as soon as the battery is back at 20%, and possibly end up

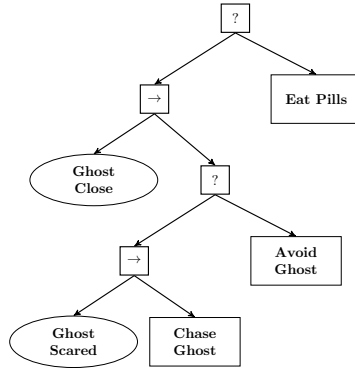

Fig. 3.4: Simple Pac-Man example using a DT structure.

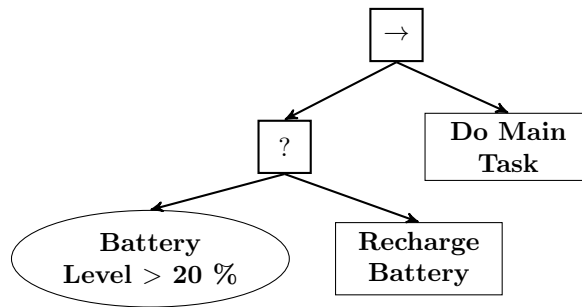

Fig. 3.5: A BT that is guaranteed not to run out of batteries, as long as Main Task keeps the robot close enough to the recharging station so that 20% of battery will be enough to travel back.

chattering i.e. quickly switching between the two tasks. The solution is to make sure that once recharging, the robot waits until the battery is back at 100%. This can be achieved by the BT in Fig 3.6.

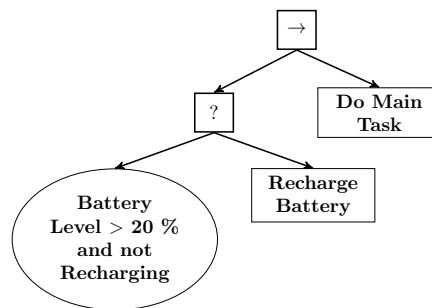

Fig. 3.6: By changing the condition in Fig. 3.5 the robot now keeps recharging until the Battery level reaches 100%.

3.5 Creating Deliberative BTs using Backchaining

BT can also be used to create deliberative agents, where the actions are carried out in order to reach a specific goal. We will use an example to see how this is done. Imagine we want the agent to end up inside a house. To make that goal explicit, we create the trivial BT in Figure 3.7, with just a single condition checking if the goal is achieved or not.

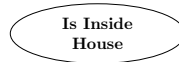

Fig. 3.7: A BT composed of a single conditions checking if the goal is achieved.

Now imagine we have a set of small BTs such as the ones in Figs. 3.8 and 3.9, each on the format of the general Postcondition-Precondition-Action (PPA) BT in Figure 3.11.

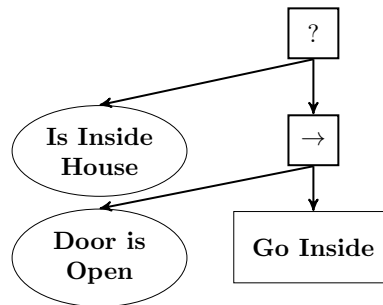

Fig. 3.8: PPA for achieving the postcondition Is Inside House. If the postcondition is not satisfied already, the BT checks the precondition Door is Open, if so it executes the action Go Inside.

If we have such a set, we can work our way backwards from the goal (backchaining) by replacing preconditions with PPAs having the corresponding postcondition. Thus replacing the single condition in Figure 3.7 with the PPA of Figure 3.8 we get Figure 3.8. More interestingly, if we replace the precondition Door is Open in Figure 3.8 with the PPA of Figure 3.9 we get the BT of Figure 3.10

Thus we can iteratively build a deliberative BT by applying Algorithm 4. Looking at the BT in Figure 3.10 we note that it first checks if the agent Is Inside House, if so it returns Success. If not it checks if Door is Open, and if it is, it proceeds to Go Inside. If not it checks if Door Unlocked and correspondingly executes Open Door. Else it checks if Door is Weak, and it Has Crowbar and proceeds to Brake Door Open if that is the case. Else it returns Failure. If an action is executed it might either succeed, which will result in a new condition being satisfied and another action being executed until the task is finished, or it might fail. If Go Inside fails, the

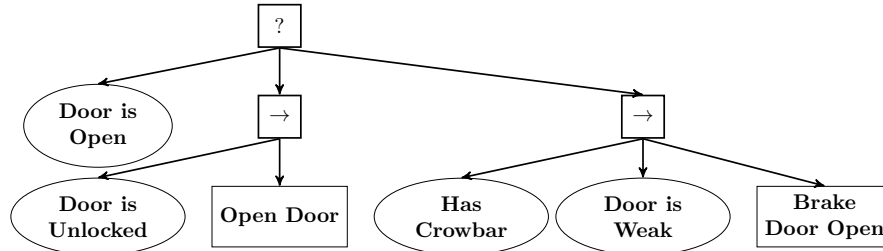

Fig. 3.9: PPA for achieving the postcondition Is Door is Open. If the postcondition is not satisfied, the BT checks the first precondition Door is Unlocked, if so it executes the action Open Door, if not it checks the second set of preconditions, starting with Door is Weak, if so it checks Has Crowbar, if both are satisfied it executes Brake Door Open.

Algorithm 4: Pseudocode of Backchaining Algorithm

Data: Set of Goal Conditions C_i , and a set of PPAs

Result: A reactive BT working to achieve the C_i s

- 1 Replace all C_i with PPAs having C_i as postcondition;
 - 2 **do**
 - 3 successively replace the preconditions of a PPA with other complete PPA having the corresponding condition as postcondition, and therefore including at least one action to achieve this condition ;
 - 4 **while** until BT returns *Running or Success*;
-

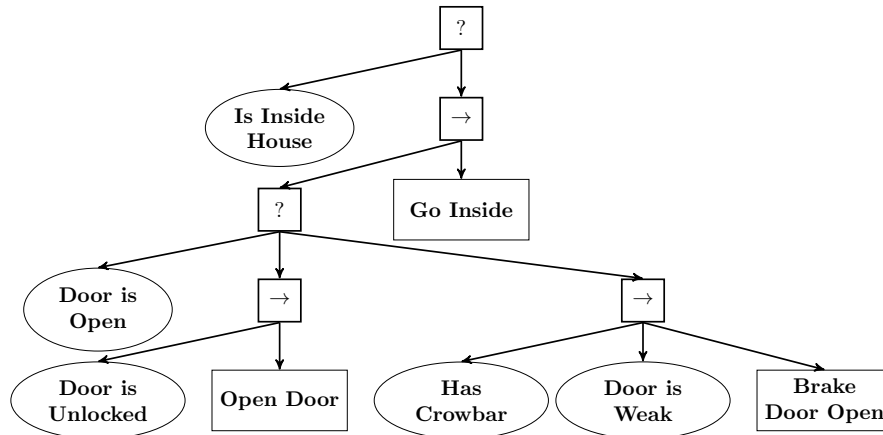

Fig. 3.10: The result of replacing Door is Open in Figure 3.8 with the PPA of Figure 3.9.

whole BT returns failure, but if Open Door fails, the conditions Door is Weak and Has Crowbar are checked.

In general, we let the PPA have the form of Figure 3.11, with one postcondition C that can be achieved by either one of set of actions A_i , each of these action are combined in a sequence with its corresponding list of preconditions C_{ij} , and these

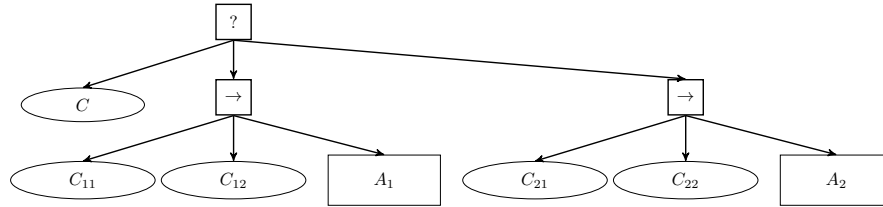

Fig. 3.11: General format of a Postcondition-Precondition-Action (PPA) BT. The Postcondition C can be achieved by either one of actions A_1 or A_2 , which have Preconditions C_{1i} and C_{2i} respectively.)

action precondition sequences are fallbacks for achieving the same objective. We see that from an efficiency point of view it makes sense to put actions that are most likely to succeed first (to avoid unnecessary failures) and check preconditions that are most likely to fail first (to quickly move on to the next fallback option).

3.6 Creating Un-Reactive BTs using Memory Nodes

As mentioned in Section 1.3.2, sometimes a child, once executed, does not need to be re-executed for the whole execution of a task. Control flow nodes with memory are used to simplify the design of a BT avoiding the unwanted re-execution of some nodes. The use of nodes with memory is advised exclusively for those cases where there is no unexpected event that will undo the execution of the sub-tree in a composition with memory, as in Example 3.1 below.

Example 3.1 (Nodes with Memory). Consider the behavior of an industrial manipulator in a production line. That has to *pick*, *move*, and *place* objects. The robot's actions are carried out in a fixed workspace, with high precision. Human operators make sure that nothing on the line changes. If they need a change in the line, the software is manually updated accordingly. In this example the robot operates in a structured environment that is fully predictable in space and time. In this case we can disregard any unexpected change letting us describing the desired behavior by a sequence with memory of pick and place as in Figure 3.12. In this scenario, after picking we can be sure that the object does not slip out of the robot's grippers. Hence while the robot is moving the object, the BT does not need to check if the object is still picked.

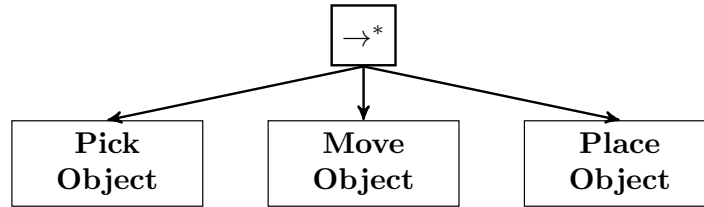

Fig. 3.12: Example of a Un-Reactive sequence composition of the behaviors pick,move, and place.

3.7 Choosing the Proper Granularity of a BT

In any modular design, the choice of the granularity of the modules needs to be decided on. In a BTs framework, this is translated into the choice of what to represent as a leaf node (single action or condition) and what to represent as a BT. In BTs, in general, there are two reasons behind encoding a behavior inside a leaf node:

- **Module to be re-used:** It is advisable to aggregate a behavior in a leaf node whenever that behavior has to be reused in different parts of the tree or in different projects. As in Example 3.2 below.
- **Modules may have to be re-executed due to unexpected changes in the environment:** It is advisable to separate a behavior in different sub-behaviors whenever the execution of a sub-behavior might be undone by unexpected uncontrollable changes (e.g. environmental changes) as in Example 3.3 below. In that case, we do not separate the different steps of *assemble object* as we do not need to account for any affecting unexpected changes during the execution of the different steps.

Example 3.2 (Re-use). Consider the BT in Figure 3.13 describing the behavior of a humanoid robot. The actions *sit* and *stand* are re-used in different parts of the tree.

Example 3.3 (Re-execution needed).

Consider an assembly task for an industrial robot that coexists in a semi-structured environment with human workers. The tasks to perform are *pick object*, *assemble object*, and *place object*. A closed-loop execution of this task can be represented with the BT in Figure 3.14. Note that the BT can reactively handle the unexpected changes due to the human worker in the line such as: the worker picks up the object that the robot is trying to reach, the object slips out from the robots grippers while the robot is placing it, etc. If we had instead chosen to aggregate the actions *pick object*, *assemble object*, and *place object* into a single action we would lose reactivity when, for example, the robot has to re-pick and assemble object slipped out from the robot's grippers. With a single action the robot will try to re-assemble an assembled object.

The advice above should give the designer an idea on how to reach a balanced BT that is neither too *sparse* nor too *compact*. A sparse BT might be unreasonably

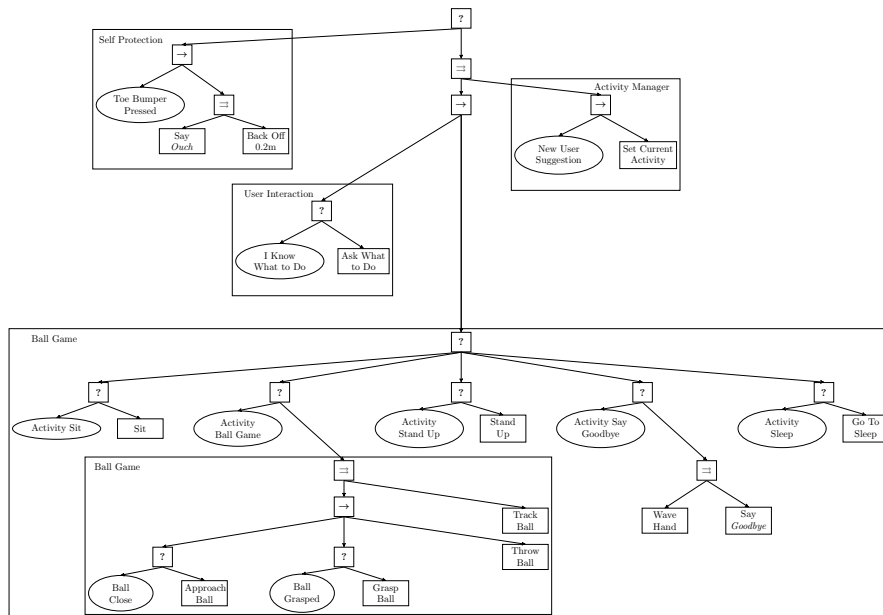

Fig. 3.13: Robot activity manager

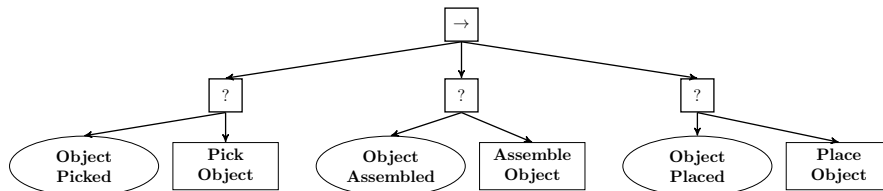

Fig. 3.14: Closed loop example

complex. While a compact BT may risk being not sufficiently reactive, by executing too many operations in a feed-forward fashion, losing one main advantage of BTs.

Chapter 4

Analysis of Efficiency, Safety, and Robustness

Autonomous agents will need to be efficient, robust, and reliable in order to be used on a large scale. In this chapter, we present a mathematical framework for analyzing these properties for a BT (4.1). The analysis includes efficiency (4.2), in terms of execution time's bound; robustness (4.2), in terms of capability to operate in large domains; and safety (4.3), in terms of avoiding some particular parts of the state space. Some of the results of this chapter were previously published in the journal paper [9].

4.1 Statespace Formulation of BTs

In this section we present a new formulation of BTs. The new formulation is more formal, and will allow us to analyze how properties are preserved over modular compositions of BTs. In the functional version, the *tick* is replaced by a recursive function call that includes both the return status, the system dynamics and the system state.

Definition 4.1 (Behavior Tree). A BT is a three-tuple

$$\mathcal{T}_i = \{f_i, r_i, \Delta t\}, \quad (4.1)$$

where $i \in \mathbb{N}$ is the index of the tree, $f_i : \mathbb{R}^n \rightarrow \mathbb{R}^n$ is the right hand side of an ordinary difference equation, Δt is a time step and $r_i : \mathbb{R}^n \rightarrow \{\mathcal{R}, \mathcal{S}, \mathcal{F}\}$ is the return status that can be equal to either *Running* (\mathcal{R}), *Success* (\mathcal{S}), or *Failure* (\mathcal{F}). Let the Running/Activation region (R_i), Success region (S_i) and Failure region (F_i) correspond to a partitioning of the state space, defined as follows:

$$R_i = \{x : r_i(x) = \mathcal{R}\} \quad (4.2)$$

$$S_i = \{x : r_i(x) = \mathcal{S}\} \quad (4.3)$$

$$F_i = \{x : r_i(x) = \mathcal{F}\}. \quad (4.4)$$

Finally, let $x_k = x(t_k)$ be the system state at time t_k , then the execution of a BT \mathcal{T}_i is a standard ordinary difference equation

$$x_{k+1} = f_i(x_k), \quad (4.5)$$

$$t_{k+1} = t_k + \Delta t. \quad (4.6)$$

The return status r_i will be used when combining BTs recursively, as explained below.

Assumption 1 *From now on we will assume that all BTs evolve in the same continuous space \mathbb{R}^n using the same time step Δt .*

Remark 4.1. It is often the case, that different BTs, controlling different vehicle subsystems evolving in different state spaces, need to be combined into a single BT. Such cases can be accommodated in the assumption above by letting all systems evolve in a larger state space, that is the Cartesian product of the smaller state spaces.

Definition 4.2 (Sequence compositions of BTs). Two or more BTs can be composed into a more complex BT using a Sequence operator,

$$\mathcal{T}_0 = \text{Sequence}(\mathcal{T}_1, \mathcal{T}_2).$$

Then r_0, f_0 are defined as follows

$$\text{If } x_k \in S_1 \quad (4.7)$$

$$r_0(x_k) = r_2(x_k) \quad (4.8)$$

$$f_0(x_k) = f_2(x_k) \quad (4.9)$$

else

$$r_0(x_k) = r_1(x_k) \quad (4.10)$$

$$f_0(x_k) = f_1(x_k). \quad (4.11)$$

\mathcal{T}_1 and \mathcal{T}_2 are called children of \mathcal{T}_0 . Note that when executing the new BT, \mathcal{T}_0 first keeps executing its first child \mathcal{T}_1 as long as it returns Running or Failure. The second child is executed only when the first returns Success, and \mathcal{T}_0 returns Success only when all children have succeeded, hence the name Sequence, just as the classical definition of Sequences in Algorithm 1 of Section 1.3. For notational convenience, we write

$$\text{Sequence}(\mathcal{T}_1, \text{Sequence}(\mathcal{T}_2, \mathcal{T}_3)) = \text{Sequence}(\mathcal{T}_1, \mathcal{T}_2, \mathcal{T}_3), \quad (4.12)$$

and similarly for arbitrarily long compositions.

Definition 4.3 (Fallback compositions of BTs). Two or more BTs can be composed into a more complex BT using a Fallback operator,

$$\mathcal{T}_0 = \text{Fallback}(\mathcal{T}_1, \mathcal{T}_2).$$

Then r_0, f_0 are defined as follows

$$\text{If } x_k \in F_1 \quad (4.13)$$

$$r_0(x_k) = r_2(x_k) \quad (4.14)$$

$$f_0(x_k) = f_2(x_k) \quad (4.15)$$

else

$$r_0(x_k) = r_1(x_k) \quad (4.16)$$

$$f_0(x_k) = f_1(x_k). \quad (4.17)$$

Note that when executing the new BT, \mathcal{T}_0 first keeps executing its first child \mathcal{T}_1 as long as it returns Running or Success. The second child is executed only when the first returns Failure, and \mathcal{T}_0 returns Failure only when all children have tried, but failed, hence the name Fallback, just as the classical definition of Fallbacks in Algorithm 2 of Section 1.3.

For notational convenience, we write

$$\text{Fallback}(\mathcal{T}_1, \text{Fallback}(\mathcal{T}_2, \mathcal{T}_3)) = \text{Fallback}(\mathcal{T}_1, \mathcal{T}_2, \mathcal{T}_3), \quad (4.18)$$

and similarly for arbitrarily long compositions.

Parallel compositions only make sense if the BTs to be composed control separate parts of the state space, thus we make the following assumption.

Assumption 2 *Whenever two BTs $\mathcal{T}_1, \mathcal{T}_2$ are composed in parallel, we assume that there is a partition of the state space $x = (x_1, x_2)$ such that $f_1(x) = (f_{11}(x), f_{12}(x))$ implies $f_{12}(x) = x$ and $f_2(x) = (f_{21}(x), f_{22}(x))$ implies $f_{21}(x) = x$ (i.e. the two BTs control different parts of the system).*

Definition 4.4 (Parallel compositions of BTs). Two or more BTs can be composed into a more complex BT using a Parallel operator,

$$\mathcal{T}_0 = \text{Parallel}(\mathcal{T}_1, \mathcal{T}_2).$$

Let $x = (x_1, x_2)$ be the partitioning of the state space described in Assumption 2, then $f_0(x) = (f_{11}(x), f_{22}(x))$ and r_0 is defined as follows

If $M = 1$

$$r_0(x) = \mathcal{S} \text{ If } r_1(x) = \mathcal{S} \vee r_2(x) = \mathcal{S} \quad (4.19)$$

$$r_0(x) = \mathcal{F} \text{ If } r_1(x) = \mathcal{F} \wedge r_2(x) = \mathcal{F} \quad (4.20)$$

$$r_0(x) = \mathcal{R} \text{ else} \quad (4.21)$$

If $M = 2$

$$r_0(x) = \mathcal{S} \text{ If } r_1(x) = \mathcal{S} \wedge r_2(x) = \mathcal{S} \quad (4.22)$$

$$r_0(x) = \mathcal{F} \text{ If } r_1(x) = \mathcal{F} \vee r_2(x) = \mathcal{F} \quad (4.23)$$

$$r_0(x) = \mathcal{R} \text{ else} \quad (4.24)$$

4.2 Efficiency and Robustness

In this section we will show how some aspects of time efficiency and robustness carry across modular compositions of BTs. This result will then enable us to conclude, that if two BTs are efficient, then their composition will also be *efficient*, if the right conditions are satisfied. We also show how the Fallback composition can be used to increase the region of attraction of a BT, thereby making it more robust to uncertainties in the initial configuration.

Note that, as in [6], by robustness we mean large regions of attraction. We do not investigate e.g. disturbance rejection, or other forms of robustness.

Many control problems, in particular in robotics, can be formulated in terms of achieving a given goal configuration in a way that is time efficient and robust with respect to the initial configuration. Since all BTs return either Success, Failure or Running, the definitions below will include a finite time, at which Success must be achieved.

In order to formalize the discussion above, we say that *efficiency* can be measured by the size of a time bound τ in Definition 4.5 and *robustness* can be measured by the size of the region of attraction R' in the same definition.

Definition 4.5 (Finite Time Successful). A BT is Finite Time Successful (FTS) with region of attraction R' , if for all starting points $x(0) \in R' \subset R$, there is a time τ , and a time $\tau'(x(0))$ such that $\tau'(x) \leq \tau$ for all starting points, and $x(t) \in R'$ for all $t \in [0, \tau')$ and $x(t) \in S$ for $t = \tau'$

As noted in the following Lemma, exponential stability implies FTS, given the right choices of the sets S, F, R .

Lemma 4.1 (Exponential stability and FTS). A BT for which x_s is a globally exponentially stable equilibrium of the execution (4.5), and $S \supset \{x : \|x - x_s\| \leq \varepsilon\}$, $\varepsilon > 0$, $F = \emptyset$, $R = \mathbb{R}^n \setminus S$, is FTS.

Proof. Global exponential stability implies that there exists $a > 0$ such that $\|x(k) - x_s\| \leq e^{-ak}$ for all k . Then, for each ε there is a time τ such that $\|x(k) - x_s\| \leq e^{-a\tau} < \varepsilon$, which implies that there is a $\tau' < \tau$ such that $x(\tau') \in S$ and the BT is FTS.

We are now ready to look at how these properties extend across compositions of BTs.

Lemma 4.2. (Robustness and Efficiency of Sequence Compositions) *If $\mathcal{T}_1, \mathcal{T}_2$ are FTS, with $S_1 = R'_2 \cup S_2$, then $\mathcal{T}_0 = \text{Sequence}(\mathcal{T}_1, \mathcal{T}_2)$ is FTS with $\tau_0 = \tau_1 + \tau_2$, $R'_0 = R'_1 \cup R'_2$ and $S_0 = S_1 \cap S_2 = S_2$.*

Proof. First we consider the case when $x(0) \in R'_1$. Then, as \mathcal{T}_1 is FTS, the state will reach S_1 in a time $k_1 < \tau_1$, without leaving R'_1 . Then \mathcal{T}_2 starts executing, and will keep the state inside S_1 , since $S_1 = R'_2 \cup S_2$. \mathcal{T}_2 will then bring the state into S_2 , in a time $k_2 < \tau_2$, and \mathcal{T}_0 will return Success. Thus we have the combined time $k_1 + k_2 < \tau_1 + \tau_2$.

If $x(0) \in R'_2$, \mathcal{T}_1 immediately returns Success, and \mathcal{T}_2 starts executing as above.

The Lemma above is illustrated in Figure 4.2, and Example 4.1 below.

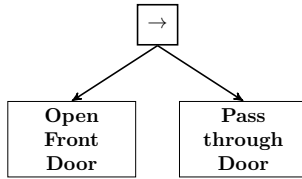

Fig. 4.1: A Sequence is used to create an *Enter Through Front Door* BT. Passing the door is only tried if the opening action succeeds. Sequences are denoted by a white box with an arrow.

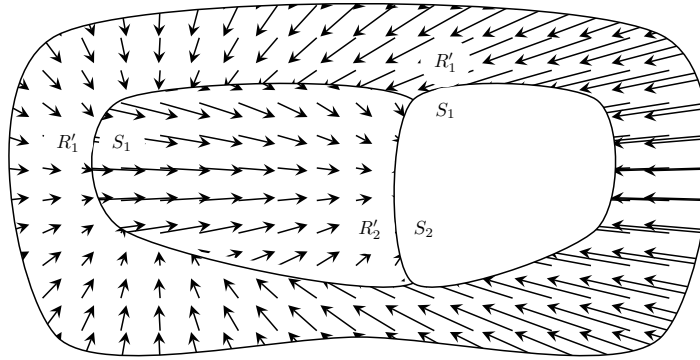

Fig. 4.2: The sets R'_1, S_1, R'_2, S_2 of Example 4.1 and Lemma 4.2.

Example 4.1. Consider the BT in Figure 4.1. If we know that *Open Front Door* is FTS and will finish in less than τ_1 seconds, and that *Pass through Door* is FTS and will finish in less than τ_2 seconds. Then, as long as $S_1 = R'_2 \cup S_2$, Lemma 4.2 states that the combined BT in Figure 4.1 is also FTS, with an upper bound on the execution time of $\tau_1 + \tau_2$. Note that the condition $S_1 = R'_2 \cup S_2$ implies that the action *Pass through Door* will not make the system leave S_1 , by e.g. accidentally colliding with the door and thereby closing it without having passed through it.

The result for Fallback compositions is related, but with a slightly different condition on S_i and R'_j . Note that this is the theoretical underpinning of the design principle *Implicit Sequences* described in Section 3.2.

Lemma 4.3. (Robustness and Efficiency of Fallback Compositions) *If $\mathcal{T}_1, \mathcal{T}_2$ are FTS, with $S_2 \subset R'_1$ and $R_1 = R_1$, then $\mathcal{T}_0 = \text{Fallback}(\mathcal{T}_1, \mathcal{T}_2)$ is FTS with $\tau_0 = \tau_1 + \tau_2$, $R'_0 = R'_1 \cup R'_2$ and $S_0 = S_1$.*

Proof. First we consider the case when $x(0) \in R'_1$. Then, as \mathcal{T}_1 is FTS, the state will reach S_1 before $k = \tau_1 < \tau_0$, without leaving R'_1 . If $x(0) \in R'_2 \setminus R'_1$, \mathcal{T}_2 will execute, and the state will progress towards S_2 . But as $S_2 \subset R'_1$, $x(k_1) \in R'_1$ at some time $k_1 < \tau_2$. Then, we have the case above, reaching $x(k_2) \in S_1$ in a total time of $k_2 < \tau_1 + k_1 < \tau_1 + \tau_2$.

The Lemma above is illustrated in Figure 4.3, and Example 4.2 below.

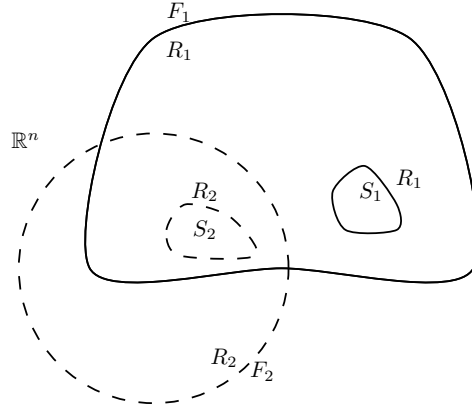

Fig. 4.3: The sets S_1, F_1, R_1 (solid boundaries) and S_2, F_2, R_2 (dashed boundaries) of Example 4.2 and Lemma 4.3.

Remark 4.2. As can be noted, the necessary conditions in Lemma 4.2, including $S_1 = R'_2 \cup S_2$ might be harder to satisfy than the conditions of Lemma 4.3, including $S_2 \subset R'_1$. Therefore, Lemma 4.3 is often preferable from a practical point of view, e.g. using implicit sequences as shown below.

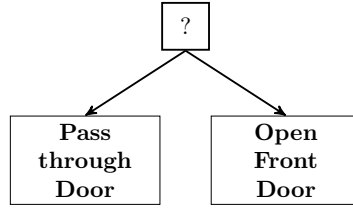

Fig. 4.4: An Implicit Sequence created using a Fallback, as described in Example 4.2 and Lemma 4.3.

Example 4.2. This example will illustrate the design principle *Implicit sequences*, see Section 3.2. Consider the BT in Figure 4.4. During execution, if the door is closed, then *Pass through Door* will fail and *Open Front Door* will start to execute. Now, right before *Open Front Door* returns Success, the first action *Pass through Door* (with higher priority) will realize that the state of the world has now changed enough to enable a possible success and starts to execute, i.e. return Running instead of Failure. The combined action of this BT will thus make the robot open the door (if necessary) and then pass through it.

Thus, even though a Fallback composition is used, the result is sometimes a sequential execution of the children in reverse order (from right to left). Hence the name Implicit sequence.

The example above illustrates how we can increase the robustness of a BT. If we want to be able to handle more diverse situations, such as a closed door, we do not have to make the door passing action more complex, instead we combine it with another BT that can handle the situation and move the system into a part of the statespace that the first BT can handle. The sets S_0, F_0, R_0 and f_0 of the combined BT are shown in Figure 4.5, together with the vector field $f_0(x) - x$. As can be seen, the combined BT can now move a larger set of initial conditions to the desired region $S_0 = S_1$.

Lemma 4.4. (Robustness and Efficiency of Parallel Compositions) *If $\mathcal{T}_1, \mathcal{T}_2$ are FTS, then $\mathcal{T}_0 = \text{Parallel}(\mathcal{T}_1, \mathcal{T}_2)$ is FTS with*

If $M = 1$

$$R'_0 = \{R'_1 \cup R'_2\} \setminus \{S_1 \cup S_2\} \quad (4.25)$$

$$S_0 = S_1 \cup S_2 \quad (4.26)$$

$$\tau_0 = \min(\tau_1, \tau_2) \quad (4.27)$$

If $M = 2$

$$R'_0 = \{R'_1 \cap R'_2\} \setminus \{S_1 \cap S_2\} \quad (4.28)$$

$$S_0 = S_1 \cap S_2 \quad (4.29)$$

$$\tau_0 = \max(\tau_1, \tau_2) \quad (4.30)$$

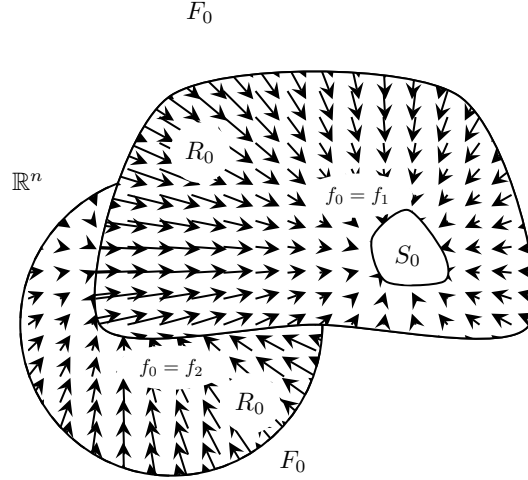

Fig. 4.5: The sets S_0, F_0, R_0 and the vector field $(f_0(x) - x)$ of Example 4.2 and Lemma 4.3.

Proof. The parallel composition executes \mathcal{T}_1 and \mathcal{T}_2 independently. If $M = 1$ the parallel composition returns success if either \mathcal{T}_1 or \mathcal{T}_2 returns success, thus $\tau_0 = \min(\tau_1, \tau_2)$. It returns running if either \mathcal{T}_1 or \mathcal{T}_2 returns running and the other does not return success. If $M = 2$ the parallel composition returns success if and only if both \mathcal{T}_1 and \mathcal{T}_2 return success, thus $\tau_0 = \max(\tau_1, \tau_2)$. It returns running if either \mathcal{T}_1 or \mathcal{T}_2 returns running and the other does not return failure.

4.3 Safety

In this section we will show how some aspects of safety carry across modular compositions of BTs. The results will enable us to design a BTs to handle safety guarantees and a BT to handle the task execution separately.

In order to formalize the discussion above, we say that *safety* can be measured by the ability to avoid a particular part of the statespace, that we for simplicity denote the *Obstacle Region*.

Definition 4.6 (Safe). A BT is Safe, with respect to the obstacle region $O \subset \mathbb{R}^n$, and the initialization region $I \subset R$, if for all starting points $x(0) \in I$, we have that $x(t) \notin O$, for all $t \geq 0$.

In order to make statements about the safety of composite BTs we also need the following definition.

Definition 4.7 (Safeguarding). A BT is Safeguarding, with respect to the step length d , the obstacle region $O \subset \mathbb{R}^n$, and the initialization region $I \subset R$, if it is

safe, and FTS with region of attraction $R' \supset I$ and a success region S , such that I surrounds S in the following sense:

$$\{x \in X \subset \mathbb{R}^n : \inf_{s \in S} \|x - s\| \leq d\} \subset I, \quad (4.31)$$

where X is the reachable part of the state space \mathbb{R}^n .

This implies that the system, under the control of another BT with maximal state-space steplength d , cannot leave S without entering I , and thus avoiding O , see Lemma 4.5 below.

Example 4.3. To illustrate how safety can be improved using a Sequence composition, we consider the UAV control BT in Figure 4.6. The sets S_i, F_i, R_i are shown in Figure 4.7. As \mathcal{T}_1 is *Guarantee altitude above 1000 ft*, its failure region F_1 is a small part of the state space (corresponding to a crash) surrounded by the running region R_1 that is supposed to move the UAV away from the ground, guaranteeing a minimum altitude of 1000 ft. The success region S_1 is large, every state sufficiently distant from F_1 . The BT that performs the mission, \mathcal{T}_2 , has a smaller success region S_2 , surrounded by a very large running region R_2 , containing a small failure region F_2 . The function f_0 is governed by Equations (4.9) and (4.9) and is depicted in form of the vector field ($f_0(x) - x$) in Figure 4.8.

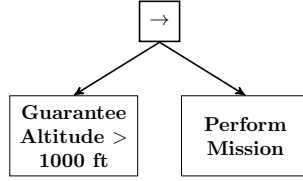

Fig. 4.6: The Safety of the UAV control BT is Guaranteed by the first Action.

The discussion above is formalized in Lemma 4.5 below.

Lemma 4.5 (Safety of Sequence Compositions). *If \mathcal{T}_1 is safeguarding, with respect to the obstacle O_1 initial region I_1 , and margin d , and \mathcal{T}_2 is an arbitrary BT with $\max_x \|x - f_2(x)\| < d$, then the composition $\mathcal{T}_0 = \text{Sequence}(\mathcal{T}_1, \mathcal{T}_2)$ is Safe with respect to O_1 and I_1 .*

Proof. \mathcal{T}_1 is safeguarding, which implies that \mathcal{T}_1 is safe and thus any trajectory starting in I_1 will stay out of O_1 as long as \mathcal{T}_1 is executing. But if the trajectory reaches S_1 , \mathcal{T}_2 will execute until the trajectory leaves S_1 . We must now show that the trajectory cannot reach O_1 without first entering I_1 . But any trajectory leaving S_1 must immediately enter I_1 , as the first state outside S_1 must lie in the set $\{x \in \mathbb{R}^n : \inf_{s \in S_1} \|x - s\| \leq d\} \subset I_1$ due to the fact that for \mathcal{T}_2 , $\|x(k) - x(k+1)\| = \|x(k) - f_2(x(k))\| < d$.

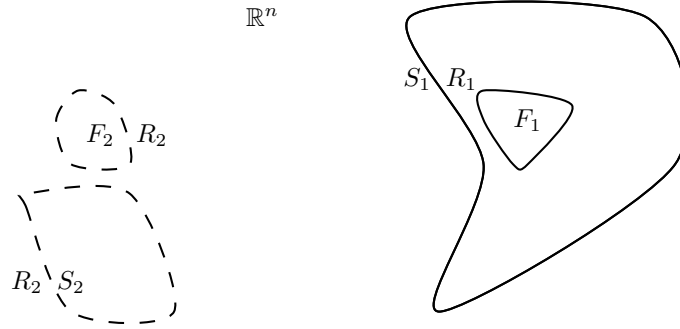

Fig. 4.7: The sets S_1, F_1, R_1 (solid boundaries) and S_2, F_2, R_2 (dashed boundaries) of Example 4.3 and Lemma 4.5.

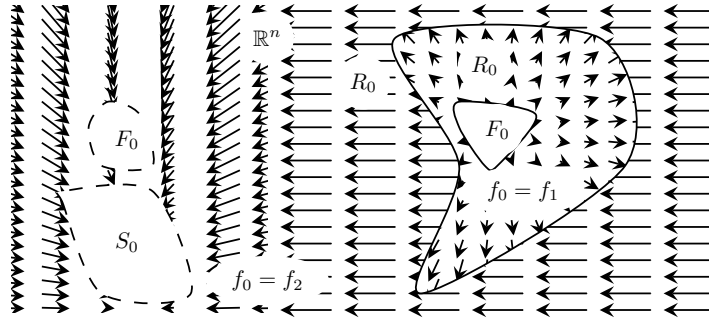

Fig. 4.8: The sets S_0, F_0, R_0 and the vector field $(f_0(x) - x)$ of Example 4.3 and Lemma 4.5.

We conclude this section with a discussion about undesired chattering in switching systems.

The issue of undesired chattering, i.e., switching back and fourth between different sub-controllers, is always an important concern when designing switched control systems, and BTs are no exception. As is suggested by the right part of Figure 4.8, chattering can be a problem when vector fields meet at a switching surface.

Although the efficiency of some compositions can be computed using Lemma 4.2 and 4.3 above, chattering can significantly reduce the efficiency of others. Inspired by [11] the following result can give an indication of when chattering is to be expected.

Let R_i and R_j be the running region of \mathcal{T}_i and \mathcal{T}_j respectively. We want to study the behavior of the system when a composition of \mathcal{T}_i and \mathcal{T}_j is applied. In some cases the execution of a BT will lead to the running region of the other BT and vice-versa. Then, both BTs are alternatively executed and the state trajectory chatters

on the boundary between R_i and R_j . We formalize this discussion in the following lemma.

Lemma 4.6. *Given a composition $\mathcal{T}_0 = \text{Sequence}(\mathcal{T}_1, \mathcal{T}_2)$, where f_i depend on Δt such that $\|f_i(x) - x\| \rightarrow 0$ when $\Delta t \rightarrow 0$. Let $s : \mathbb{R}^n \rightarrow \mathbb{R}$ be such that $s(x) = 0$ if $x \in \delta S_1 \cap R_2$, $s(x) < 0$ if $x \in \text{interior}(S_1) \cap R_2$, $s(x) > 0$ if $x \in \text{interior}(\mathbb{R}^n \setminus S_1) \cap R_2$, and let*

$$\lambda_i(x) = \left(\frac{\partial s}{\partial x}\right)^T (f_i(x) - x).$$

Then, $x \in \delta S_1$ is chatter free, i.e., avoids switching between \mathcal{T}_1 and \mathcal{T}_2 at every timestep, for small enough Δt , if $\lambda_1(x) < 0$ or $\lambda_2(x) > 0$.

Proof. When the condition holds, the vector field is pointing outwards on at least one side of the switching boundary.

Note that this condition is not satisfied on the right hand side of Figure 4.8. This concludes our analysis of BT compositions.

4.4 Examples

In this section we show some BTs of example and we analyze their properties.

Section 4.4.1 illustrates how to analyze robustness and efficiency of a robot executing a generic task. Section 4.3 illustrates to compute safety using the functional representation of Section 4.1. Section 6.4 illustrates how to compute the performance estimate of a given BT. Finally, Section 4.4.3 illustrates the properties above of a complex BT.

All BTs were implemented using the ROS BT package.¹ A video showing the executions of the BTs used in Sections 4.4.2-4.4.1 is publicly available.²

4.4.1 Robustness and Efficiency

To illustrate Lemma 4.3 we look at the BT of Figure 4.9 controlling a NAO robot. The BT has three sub-trees *Walk Home*, which is first tried, if that fails (the robot cannot walk if it is not standing up) it tries the sub-tree *Sit to Stand*, and if that fails, it tries *Lie down to Sit Up*. Thus, each fallback action brings the system into the running region of the action to its left, e.g., the result of *Sit to Stand* is to enable the execution of *Walk Home*.

Example 4.4. Let $x_k = (x_{1k}, x_{2k}) \in \mathbb{R}^2$, where $x_{1k} \in [0, 0.5]$ is the horizontal position of the robot head and $x_{2k} \in [0, 0.55]$ is vertical position (height above the floor) of the robot head. The objective of the robot is to get to the destination at $(0, 0.48)$.

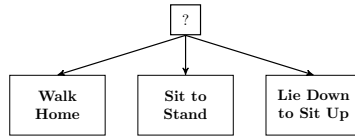

Fig. 4.9: The combination $\mathcal{T}_3 = \text{Fallback}(\mathcal{T}_4, \mathcal{T}_5, \mathcal{T}_6)$ increases robustness by increasing the region of attraction.

First we describe the sets S_i, F_i, R_i and the corresponding vector fields of the functional representation. Then we apply Lemma 4.3 to see that the combination does indeed improve robustness. For this example $\Delta t = 1s$.

For *Walk Home*, \mathcal{T}_4 , we have that

¹ library available at http://wiki.ros.org/behavior_tree.

² <https://youtu.be/fH7jx4ZsTG8>

$$S_4 = \{x : x_1 \leq 0\} \quad (4.32)$$

$$R_4 = \{x : x_1 \neq 0, x_2 \geq 0.48\} \quad (4.33)$$

$$F_4 = \{x : x_1 \neq 0, x_2 < 0.48\} \quad (4.34)$$

$$f_4(x) = \begin{pmatrix} x_1 - 0.1 \\ x_2 \end{pmatrix} \quad (4.35)$$

that is, it runs as long as the vertical position of the robot head, x_2 , is at least $0.48m$ above the floor, and moves towards the origin with a speed of $0.1m/s$. If the robot is not standing up $x_2 < 0.48m$ it returns Failure. A phase portrait of $f_4(x) - x$ is shown in Figure 4.10. Note that \mathcal{T}_4 is FTS with the completion time bound $\tau_4 = 0.5/0.1 = 10$ and region of attraction $R'_4 = R_4$.

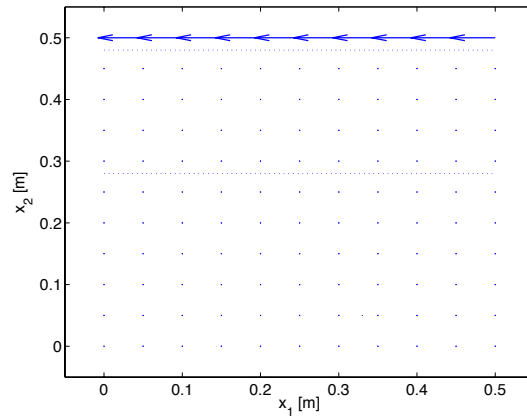

Fig. 4.10: The Action *Walk Home*, keeps the head around $x_2 = 0.5$ and moves it towards the destination $x_1 = 0$.

For *Sit to Stand*, \mathcal{T}_5 , we have that

$$S_5 = \{x : 0.48 \leq x_2\} \quad (4.36)$$

$$R_5 = \{x : 0.3 \leq x_2 < 0.48\} \quad (4.37)$$

$$F_5 = \{x : x_2 < 0.3\} \quad (4.38)$$

$$f_5(x) = \begin{pmatrix} x_1 \\ x_2 + 0.05 \end{pmatrix} \quad (4.39)$$

that is, it runs as long as the vertical position of the robot head, x_2 , is in between $0.3m$ and $0.48m$ above the floor. If $0.48 \leq x_2$ the robot is standing up, and it returns Success. If $x_2 \leq 0.3$ the robot is lying down, and it returns Failure. A phase portrait of $f_5(x) - x$ is shown in Figure 4.11. Note that \mathcal{T}_5 is FTS with the completion time bound $\tau_5 = \text{ceil}(0.18/0.05) = \text{ceil}(3.6) = 4$ and region of attraction $R'_5 = R_5$

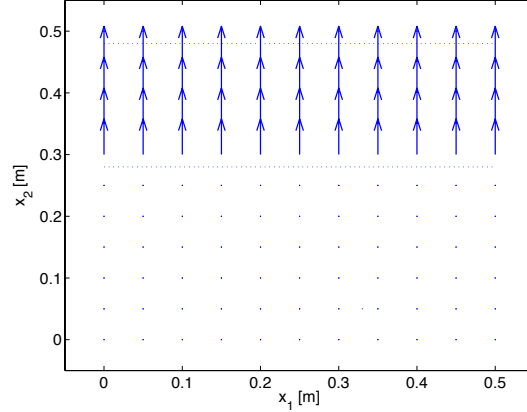

Fig. 4.11: The Action *Sit to Stand* moves the head upwards in the vertical direction towards standing.

For *Lie down to Sit Up*, \mathcal{T}_6 , we have that

$$S_6 = \{x : 0.3 \leq x_2\} \quad (4.40)$$

$$R_6 = \{x : 0 \leq x_2 < 0.3\} \quad (4.41)$$

$$F_6 = \emptyset \quad (4.42)$$

$$f_6(x) = \begin{pmatrix} x_1 \\ x_2 + 0.03 \end{pmatrix} \quad (4.43)$$

that is, it runs as long as the vertical position of the robot head, x_2 , is below $0.3m$ above the floor. If $0.3 \leq x_2$ the robot is sitting up (or standing up), and it returns Success. If $x_2 < 0.3$ the robot is lying down, and it returns Running. A phase portrait of $f_6(x) - x$ is shown in Figure 4.12. Note that \mathcal{T}_6 is FTS with the completion time bound $\tau_6 = 0.3/0.03 = 10$ and region of attraction $R'_6 = R_6$

Informally, we can look at the phase portrait in Figure 4.13 to get a feeling for what is going on. As can be seen the fallbacks make sure that the robot gets to its feet and walks back, independently of where it started in $\{x : 0 < x_1 \leq 0.5, 0 \leq x_2 \leq 0.55\}$.

Formally, we can use Lemma 4.3 to compute robustness in terms of the region of attraction R'_3 , and efficiency in terms of bounds on completion time τ_3 . The results are described in the following Lemma.

Lemma 4.7. *Given $\mathcal{T}_4, \mathcal{T}_5, \mathcal{T}_6$ defined in Equations (4.32)-(4.43).*

The combined BT $\mathcal{T}_3 = \text{Fallback}(\mathcal{T}_4, \mathcal{T}_5, \mathcal{T}_6)$ is FTS, with region of attraction $R'_3 = \{x : 0 < x_1 \leq 0.5, 0 \leq x_2 \leq 0.55\}$, completion time bound $\tau_3 = 24$.

Proof. We note that $\mathcal{T}_4, \mathcal{T}_5, \mathcal{T}_6$ are FTS with $\tau_4 = 10, \tau_5 = 4, \tau_6 = 10$ and regions of attractions equal to the running regions $R'_i = R_i$. Thus we have that $S_6 \subset R_5 = R'_5$ and

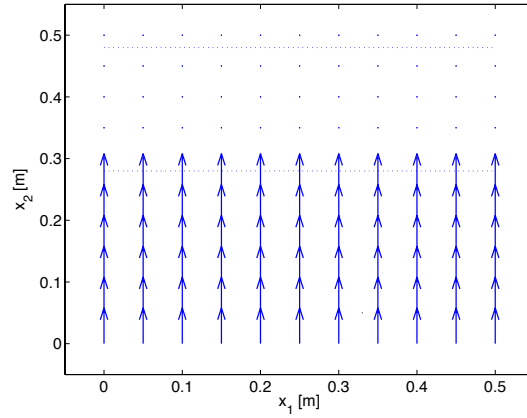

Fig. 4.12: The Action *Lie down to Sit Up* moves the head upwards in the vertical direction towards sitting.

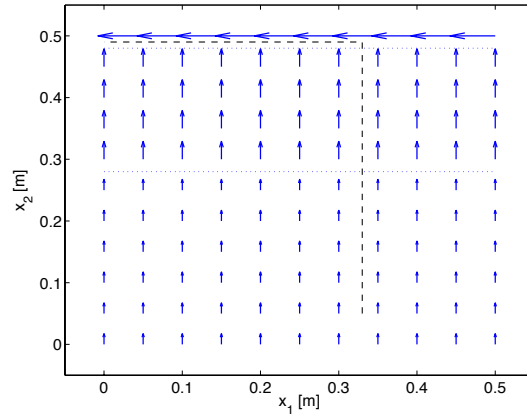

Fig. 4.13: The combination $\text{Fallback}(\mathcal{T}_4, \mathcal{T}_5, \mathcal{T}_6)$ first gets up, and then walks home.

$S_5 \subset R_4 = R'_4$. Applying Lemma 4.3 twice now gives the desired results, $R'_3 = R'_4 \cup R'_5 \cup R'_6 = \{x : 0 \leq x_1 \leq 0.5, 0 \leq x_2 \leq 0.55\}$ and $\tau_3 = \tau_4 + \tau_5 + \tau_6 = 10 + 4 + 10 = 24$.

4.4.2 Safety

To illustrate Lemma 4.5 we choose the BT of Figure 4.14. The idea is that the first sub-tree in the sequence (named *Guarantee Power Supply*) is to guarantee that the

combination does not run out of power, under very general assumptions about what is going on in the second BT.

First we describe the sets S_i, F_i, R_i and the corresponding vector fields of the functional representation. Then we apply Lemma 4.5 to see that the combination does indeed guarantee against running out of batteries.

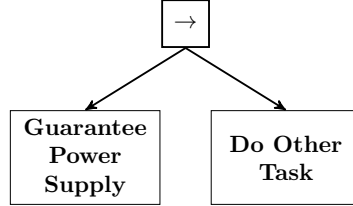

Fig. 4.14: A BT where the first action guarantees that the combination does not run out of battery.

Example 4.5. Let \mathcal{T}_1 be *Guarantee Power Supply* and \mathcal{T}_2 be *Do other tasks*. Let furthermore $x_k = (x_{1k}, x_{2k}) \in \mathbb{R}^2$, where $x_{1k} \in [0, 100]$ is the distance from the current position to the recharging station and $x_{2k} \in [0, 100]$ is the battery level. For this example $\Delta t = 10s$.

For *Guarantee Power Supply*, \mathcal{T}_1 , we have that

$$S_1 = \{x : 100 \leq x_2 \text{ or } (0.1 \leq x_1, 20 < x_2)\} \quad (4.44)$$

$$R_1 = \{x : x_2 \leq 20 \text{ or } (x_2 < 100 \text{ and } x_1 < 0.1)\} \quad (4.45)$$

$$F_1 = \emptyset \quad (4.46)$$

$$f_1(x) = \begin{pmatrix} x_1 \\ x_2 + 1 \end{pmatrix} \text{ if } x_1 < 0.1, x_2 < 100 \quad (4.47)$$

$$= \begin{pmatrix} x_1 - 1 \\ x_2 - 0.1 \end{pmatrix} \text{ else} \quad (4.48)$$

that is, when running, the robot moves to $x_1 < 0.1$ and recharges. While moving, the battery level decreases and while charging the battery level increases. If at the recharge position, it returns Success only after reaching $x_2 \geq 100$. Outside of the recharge area, it returns Success as long as the battery level is above 20. A phase portrait of $f_1(x) - x$ is shown in Figure 4.15.

For *Do Other Task*, \mathcal{T}_2 , we have that

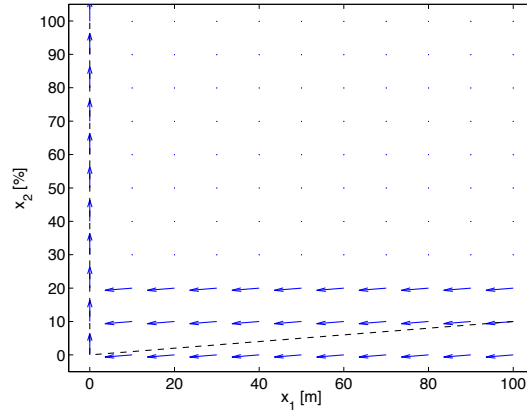

Fig. 4.15: The *Guarantee Power Supply* Action

$$S_2 = \emptyset \quad (4.49)$$

$$R_2 = \mathbb{R}^2 \quad (4.50)$$

$$F_2 = \emptyset \quad (4.51)$$

$$f_2(x) = \begin{pmatrix} x_1 + (50 - x_1)/50 \\ x_2 - 0.1 \end{pmatrix} \quad (4.52)$$

that is, when running, the robot moves towards $x_1 = 50$ and does some important task, while the battery level keeps on decreasing. A phase portrait of $f_2(x) - x$ is shown in Figure 4.15.

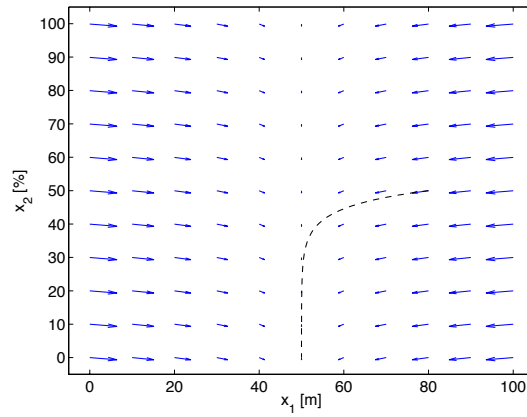

Fig. 4.16: The *Do Other Task* Action

Given \mathcal{T}_1 and \mathcal{T}_2 , the composition $\mathcal{T}_0 = \text{Sequence}(\mathcal{T}_1, \mathcal{T}_2)$ is created to improve the safety of \mathcal{T}_2 , as described below.

Informally, we can look at the phase portrait in Figure 4.17 to get a feeling for what is going on. The obstacle to be avoided is the Empty Battery state $O = \{x : x_2 = 0\}$, and \mathcal{T}_0 makes sure that this state is never reached, since the *Guarantee Power Supply* action starts executing as soon as *Do Other Task* brings the battery level below 20%. The remaining battery level is also enough for the robot to move back to the recharging station, given that the robot position is limited by the reachable space, i.e., $x_{1k} \in [0, 100]$.

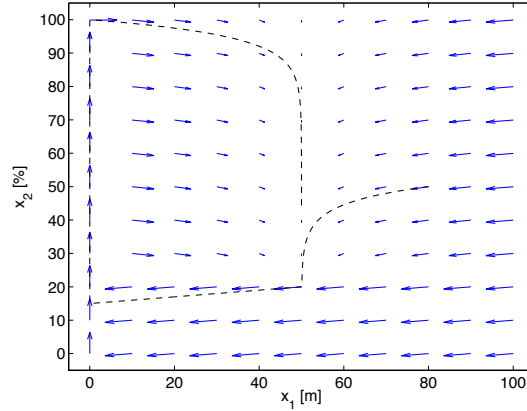

Fig. 4.17: Phase portrait of $\mathcal{T}_0 = \text{Sequence}(\mathcal{T}_1, \mathcal{T}_2)$. Note that \mathcal{T}_1 guarantees that the combination does not run out of battery. The dashed line is a simulated execution, starting at $(80, 50)$.

Formally, we state the following Lemma

Lemma 4.8. *Let the obstacle region be $O = \{x : x_2 = 0\}$ and the initialization region be $I = \{x : x_1 \in [0, 100], x_2 \geq 15\}$.*

Furthermore, let \mathcal{T}_1 be given by (4.44)-(4.48) and \mathcal{T}_2 be an arbitrary BT satisfying $\max_x \|x - f_2(x)\| < d = 5$, then $\mathcal{T}_0 = \text{Sequence}(\mathcal{T}_1, \mathcal{T}_2)$ is Safe with respect to I and O , i.e. if $x(0) \in I$, then $x(t) \notin O$, for all $t > 0$.

Proof. First we see that \mathcal{T}_1 is Safe with respect to O and I . Then we notice that \mathcal{T}_1 is Safeguarding with margin $d = 10$ for the reachable set $X = \{x : x_1 \in [0, 100], x_2 \in [0, 100]\}$. Finally we conclude that \mathcal{T}_0 is Safe, according to Lemma 4.5.

Note that if we did not constraint the robot to move in some reachable set $X = \{x : x_1 \in [0, 100], x_2 \in [0, 100]\}$, it would be able to move so far away from the recharging station that the battery would not be sufficient to bring it back again before reaching $x_2 = 0$.

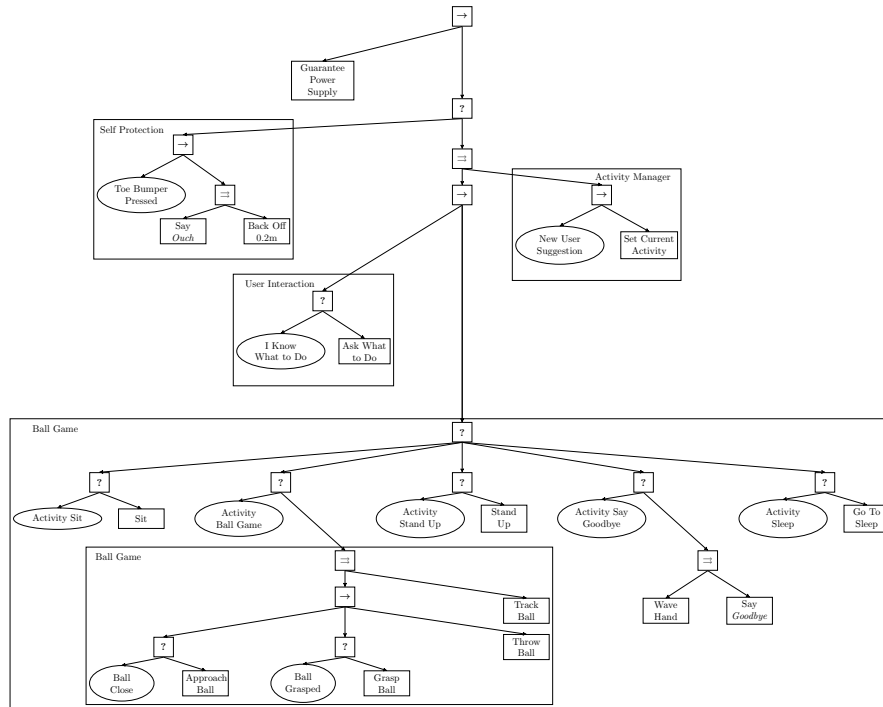

Fig. 4.18: A BT that combines some capabilities of the NAO robot in an interactive and modular way. Note how atomic actions can easily be replaced by more complex sub-BTs.

4.4.3 Complex BT

Below we will use a larger BT to illustrate modularity, as well as the applicability of the proposed analysis tools to more complex problems.

Example 4.6. The BT in Figure 4.18 is designed for controlling a NAO humanoid robot in an interactive capability demo, and includes the BTs of Figures 4.14 and 4.9 as subtrees, as discussed below.

The top left part of the tree includes some exception handling, in terms of battery management, and backing up and complaining in case the toe bumpers are pressed. The top right part of the tree is a parallel node, listening for new user commands, along with a request for such commands if none are given and an execution of the corresponding activities if a command has been received.

The subtree *Perform Activities* is composed of checking of what activity to do, and execution of the corresponding command. Since the activities are mutually exclusive, we let the Current Activity hold only the latest command and no ambiguities of control commands will occur.

The subtree *Play Ball Game* runs the ball tracker, in parallel with moving closer to the ball, grasping it, and throwing it.

As can be seen, the design is quite modular. A HDS implementation of the same functionality would need an extensive amount of transition arrows going in between the different actions.

We will now apply the analysis tools of the paper to the example, initially assuming that all atomic actions are FTS, as described in Definition 4.5.

Comparing Figures 4.14 and 4.18 we see that they are identical, if we let *Do Other Task* correspond to the whole right part of the larger BT. Thus, according to Lemma 4.8, the complete BT is safe, i.e. it will not run out of batteries, as long as the reachable state space is bounded by 100 distance units from the recharging station and the time steps are small enough so that $\max_x \|x - f_2(x)\| < d = 5$, i.e. the battery does not decrease more than 5% in a single time step.

The design of the right subtree in *Play Ball Game* is made to satisfy Lemma 4.2, with the condition $S_1 = R'_2 \cup S_2$. Let $\mathcal{T}_1 = \text{Fallback}(\text{Ball Close?}, \text{Approach Ball})$, $\mathcal{T}_2 = \text{Fallback}(\text{Ball Grasped?}, \text{Grasp Ball})$, $\mathcal{T}_3 = \text{Throw Ball}$. Note that the use of condition action pairs makes the success regions explicit. Thus $S_1 = R'_2 \cup S_2$, i.e. Ball Close is designed to describe the Region of Attraction of Grasp Ball, and $S_2 = R'_3 \cup S_3$, i.e. Ball Grasped is designed to describe the Region of Attraction of Throw Ball. Finally, applying Lemma 4.2 twice we conclude that the right part of *Play Ball Game* is FTS with completion time bound $\tau_1 + \tau_2 + \tau_3$, region of attraction $R'_1 \cup R'_2 \cup R'_3$ and success region $S_1 \cap S_2 \cap S_3$.

The parallel composition at the top of *Play Ball Game* combines *Ball Tracker* which always returns Running, with the subtree discussed above. The parallel node has $M = 1$, i.e. it only needs the Success of one child to return Success. Thus, it is clear from Definition 4.4 that the whole BT *Play Ball Game* has the same properties regarding FTS as the right subtree.

Finally, we note that *Play Ball Game* fails if the robot is not standing up. Therefore, we improve the robustness of that subtree in a way similar to Example 4.4 in Figure 4.9. Thus we create the composition $\text{Fallback}(\text{Play Ball Game}, \mathcal{T}_5, \mathcal{T}_6)$, with $\mathcal{T}_5 = \text{Sit to Stand}$, $\mathcal{T}_6 = \text{Lie Down to Sit Up}$.

Assuming that that high dimensional dynamics of *Play Ball Game* is somehow captured in the x_1 dimension we can apply an argument similar to Lemma 4.7 to conclude that the combined BT is indeed also FTS with completion time bound $\tau_1 + \tau_2 + \tau_3 + \tau_5 + \tau_6$, region of attraction $R'_1 \cup R'_2 \cup R'_3 \cup R'_5 \cup R'_6$ and success region $S_1 \cap S_2 \cap S_3$.

The rest of the BT concerns user interaction and is thus not suitable for doing performance analysis.

Note that the assumption on all atomic actions being FTS is fairly strong. For example, the NAO grasping capabilities are somewhat unreliable. A deterministic analysis such as this one is still useful for making good design choices, but in order to capture the stochastic properties of a BT, we need the tools of Chapter 6.

But first we will use the tools developed in this chapter to formally investigate how BTs relate to other control architectures.

Chapter 5

Formal Analysis of How Behavior Trees Generalize Earlier Ideas

In this chapter, we will formalize the arguments of Chapter 2, using the tools developed in Chapter 4. In particular, we prove that BTs generalize Decision Trees (5.1), the Subsumptions Architecture (5.2), Sequential Behavior Compositions (5.3) and the Teleo-Reactive Approach (5.4). Some of the results of this chapter were previously published in the journal paper [9].

5.1 How BTs Generalize Decision Trees

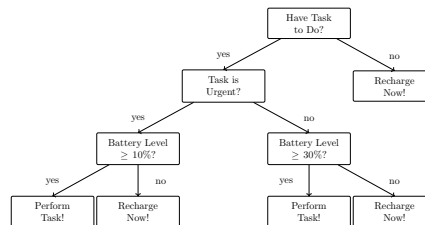

Fig. 5.1: The Decision Tree of a robot control system. The decisions are interior nodes, and the actions are leaves.

Consider the Decision Tree of Figure 5.1, the robot has to decide whether to perform a given task or recharge its batteries. This decision is taken based upon the urgency of the task, and the current battery level. The following Lemma shows how to create an equivalent BT from a given Decision Tree.

Lemma 5.1. *Given a Decision Tree as follows*

$$DT_i = \begin{cases} DT_{i1} & \text{if predicate } P_i \text{ is true} \\ DT_{i2} & \text{if predicate } P_i \text{ is false} \end{cases} \quad (5.1)$$

where DT_{i1} , DT_{i2} are either atomic actions, or sub DTs with identical structure, we can create an equivalent BT by setting

$$\mathcal{T}_i = \text{Fallback}(\text{Sequence}(P_i, \mathcal{T}_{i1}), \mathcal{T}_{i2}) \quad (5.2)$$

for non-atomic actions, $\mathcal{T}_i = DT_i$ for atomic actions and requiring all actions to return Running all the time.

The original Decision Tree and the new BT are equivalent in the sense that the same values for P_i will always lead to the same atomic action being executed. The lemma is illustrated in Figure 5.2.

Proof. The BT equivalent of the Decision Tree is given by

$$\mathcal{T}_i = \text{Fallback}(\text{Sequence}(P_i, \mathcal{T}_{i1}), \mathcal{T}_{i2})$$

For the atomic actions always returning running we have $r_i = R$, for the actions being predicates we have that $r_i = P_i$. This, together with Definitions 4.2-4.3 gives that

$$f_i(x) = \begin{cases} f_{i1} & \text{if predicate } P_i \text{ is true} \\ f_{i2} & \text{if predicate } P_i \text{ is false} \end{cases} \quad (5.3)$$

which is equivalent to (5.1).

Informally, first we note that by requiring all actions to return Running, we basically disable the feedback functionality that is built into the BT. Instead whatever action that is ticked will be the one that executes, just as the Decision Tree. Second the result is a direct consequence of the fact that the predicates of the Decision Trees are essentially ‘If ... then ... else ...’ statements, that can be captured by BTs as shown in Figure 5.2.

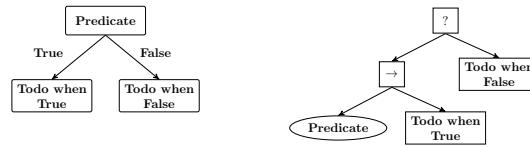

Fig. 5.2: The basic building blocs of Decision Trees are ‘If ... then ... else ...’ statements (left), and those can be created in BTs as illustrated above (right).

Note that this observation opens possibilities of using the extensive literature on learning Decision Trees from human operators, see e.g. [37], to create BTs. These learned BTs can then be extended with safety or robustness features, as described in Section 4.2.

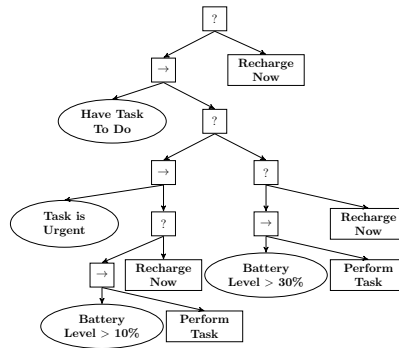

Fig. 5.3: A BT that is equivalent to the Decision Tree in Figure 5.1. A more compact version of the same tree can be found in Figure 5.4.

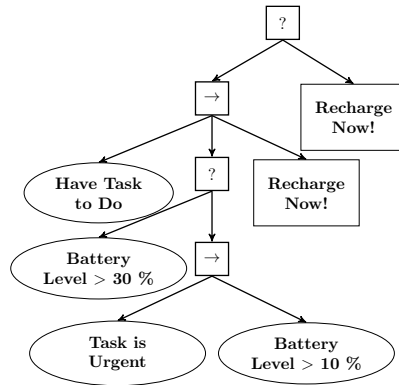

Fig. 5.4: A more compact formulation of the BT in Figure 5.3.

We finish this section with an example of how BTs generalize Decision Trees. Consider the Decision Tree in Figure 5.1. Applying Lemma 5.1 we get the equivalent BT of Figure 5.3. However the direct mapping does not always take full advantage of the features of BTs. Thus a more compact, and still equivalent, BT can be found in Figure 5.4, where again, we assume that all actions always return *Running*.

5.2 How BTs Generalize the Subsumption Architecture

In this section we will see how the subsumption architecture, proposed by Brooks [4], can be realized using a Fallback composition. The basic idea in [4] was to have a

number of controllers set up in parallel and each controller was allowed to output both actuator commands, and a binary value, signaling if it wanted to control the robot or not. The controllers were then ordered according to some priority, and the highest priority controller, out of the ones signaling for action, was allowed to control the robot. Thus, a higher level controller was able to *subsume* the actions of a lower level one.

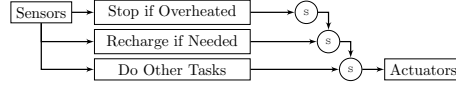

Fig. 5.5: The Subsumption architecture. A higher level behavior can subsume (or suppress) a lower level one.

An example of a Subsumption architecture can be found in Figure 5.5. Here, the basic level controller *Do Other Tasks* is assumed to be controlling the robot for most of the time. However, when the battery level is low enough, the *Recharge if Needed* controller will signal that it needs to command the robot, subsume the lower level controller, and guide the robot towards the recharging station. Similarly, if there is risk for overheating, the top level controller *Stop if Overheated* will subsume both of the lower level ones, and stop the robot until it has cooled down.

Lemma 5.2. *Given a Subsumption architecture, we can create an equivalent BT by arranging the controllers as actions under a Fallback composition, in order from higher to lower priority. Furthermore, we let the return status of the actions be Failure if they do not need to execute, and Running if they do. They never return Success. Formally, a subsumption architecture composition $S_i(x) = \text{Sub}(S_{i1}(x), S_{i2}(x))$ can be defined by*

$$S_i(x) = \begin{cases} S_{i1}(x) & \text{if } S_{i1} \text{ needs to execute} \\ S_{i2}(x) & \text{else} \end{cases} \quad (5.4)$$

Then we write an equivalent BT as follows

$$\mathcal{T}_i = \text{Fallback}(\mathcal{T}_{i1}, \mathcal{T}_{i2}) \quad (5.5)$$

where \mathcal{T}_{ij} is defined by $f_{ij}(x) = S_{ij}(x)$ and

$$r_{ij}(x) = \begin{cases} \mathcal{R} & \text{if } S_{ij} \text{ needs to execute} \\ \mathcal{F} & \text{else.} \end{cases} \quad (5.6)$$

Proof. By the above arrangement, and Definition 4.3 we have that

$$f_i(x) = \begin{cases} f_{i1}(x) & \text{if } S_{i1} \text{ needs to execute} \\ f_{i2}(x) & \text{else,} \end{cases} \quad (5.7)$$

which is equivalent to (5.4) above. In other words, actions will be checked in order of priority, until one that returns running is found.

A BT version of the example in Figure 5.5 can be found in Figure 5.6. Table 5.1 illustrates how the two control structures are equivalent, listing all the 2^3 possible return status combinations. Note that no action is executed if all actions return Failure.

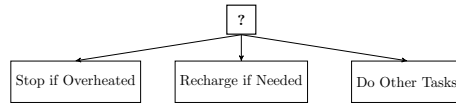

Fig. 5.6: A BT version of the subsumption example in Figure 5.5.

Table 5.1: Possible outcomes of Subsumption-BT example.

Stop if over heated	Recharge if Needed	Do Other Tasks	Executed Action
Running	Running	Running	Stop ...
Running	Running	Failure	Stop ...
Running	Failure	Running	Stop ...
Running	Failure	Failure	Stop ...
Failure	Running	Running	Recharge ...
Failure	Running	Failure	Recharge ...
Failure	Failure	Running	Do other ...
Failure	Failure	Failure	-

5.3 How BTs Generalize Sequential Behavior Compositions

In this section, we will see how the Fallback composition, and Lemma 4.3, can also be used to implement the Sequential Behavior Compositions proposed in [6].

The basic idea proposed by [6] is to extend the region of attraction by using a family of controllers, where the asymptotically stable equilibrium of each controller was either the goal state, or inside the region of attraction of another controller, positioned earlier in the sequence.

We will now describe the construction of [6] in some detail, and then see how this concept is captured in the BT framework. Given a family of controllers $U = \{\Phi_i\}$,

we say that Φ_i prepares Φ_j if the goal $G(\Phi_i)$ is inside the domain $D(\Phi_j)$. Assume the overall goal is located at $G(\Phi_1)$. A set of execution regions $C(\Phi_i)$ for each controller was then calculated according to the following scheme:

1. Let a Queue contain Φ_1 . Let $C(\Phi_1) = D(\Phi_1)$, $N = 1$, $D_1 = D(\Phi_1)$.
2. Remove the first element of the queue and append all controllers that *prepare* it to the back of the queue.
3. Remove all elements in the queue that already has a defined $C(\Phi_i)$.
4. Let Φ_j be the first element in the queue. Let $C(\Phi_j) = D(\Phi_j) \setminus D_N$, $D_{N+1} = D_N \cup D(\Phi_j)$ and $N \leftarrow N + 1$.
5. Repeat steps 2, 3 and 4 until the queue is empty.

The combined controller is then executed by finding j such that $x \in C(\Phi_j)$ and then invoking controller Φ_j .

Looking at the design of the Fallback operator in BTs, it turns out that it does exactly the job of the Burrige algorithm above, as long as the subtrees of the Fallback are ordered in the same fashion as the queue above. We formalize this in Lemma 5.3 below.

Lemma 5.3. *Given a set of controllers $U = \{\Phi_i\}$ we define the corresponding regions $S_i = G(\Phi_i)$, $R'_i = D(\Phi_i)$, $F_i = \text{Complement}(D(\Phi_i))$, and consider the controllers as atomic BTs, $\mathcal{T}_i = \Phi_i$. Assume S_1 is the overall goal region. Iteratively create a larger BT \mathcal{T}_L as follows*

1. Let $\mathcal{T}_L = \mathcal{T}_1$.
2. Find a BT $\mathcal{T}_* \in U$ such that $S_* \subset R'_L$
3. Let $\mathcal{T}_L \leftarrow \text{Fallback}(\mathcal{T}_L, \mathcal{T}_*)$
4. Let $U \leftarrow U \setminus \mathcal{T}_*$
5. Repeat steps 2, 3 and 4 until U is empty.

If all \mathcal{T}_i are FTS, then so is \mathcal{T}_L .

Proof. The statement is a direct consequence of iteratively applying Lemma 4.3.

Thus, we see that BTs generalize the Sequential Behavior Compositions of [6], with the execution region computations and controller switching replaced by the Fallback composition, as long as the ordering is given by Lemma 5.3 above.

5.4 How BTs Generalize TRs

In this section, we use the following Lemma to show how to create a BT with the same execution as a given TR. The lemma is illustrated by Example 5.1 and Figure 5.7.

Lemma 5.4 (TR-BT analogy). *Given a TR in terms of conditions k_i and actions a_i , an equivalent BT can be constructed as follows*

$$\mathcal{T}_{TR} = \text{Fallback}(\text{Sequence}(c_1, a_1), \dots, \text{Sequence}(c_m, a_m)), \quad (5.8)$$

where we convert the True/False of the conditions to Success/Failure, and let the actions only return Running.

Proof. It is straightforward to see that the BT above executes the exact same a_i as the original TR would have, depending on the values of the conditions c_i , i.e. it finds the first condition c_i that returns Success, and executes the corresponding a_i .

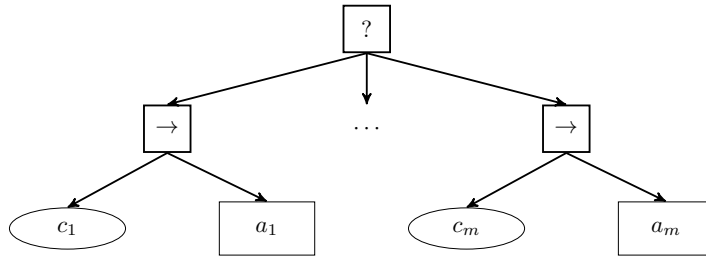

Fig. 5.7: The BT that is analogous to a given TR.

We will now illustrate the lemma with an example from Nilsson's original paper [31].

Example 5.1. The TR $Goto(loc)$ is described as follows, with conditions on the left and corresponding actions to the right:

$$\text{Equal}(pos, loc) \rightarrow \text{Idle} \quad (5.9)$$

$$\text{Heading Towards}(loc) \rightarrow \text{Go Forwards} \quad (5.10)$$

$$(\text{else}) \rightarrow \text{Rotate} \quad (5.11)$$

where pos is the current robot position and loc is the current destination.

Executing this TR, we get the following behavior. If the robot is at the destination it does nothing. If it is heading the right way it moves forward, and else it rotates on the spot. In a perfect world without obstacles, this will get the robot to the goal, just as predicted in Lemma 5.5. Applying Lemma 5.4, the GoTo TR is translated to a BT in Figure 5.8.

The example continues in [31] with a higher level recursive TR, called $Amble(loc)$, designed to add a basic obstacle avoidance behavior

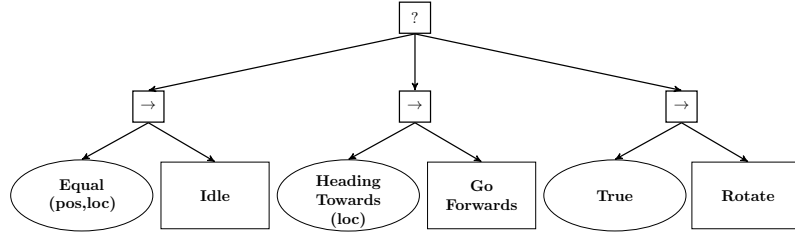

Fig. 5.8: The BT version of the TR GoTo.

$$\text{Equal}(\text{pos}, \text{loc}) \rightarrow \text{Idle} \quad (5.12)$$

$$\text{Clear Path}(\text{pos}, \text{loc}) \rightarrow \text{GoTo}(\text{loc}) \quad (5.13)$$

$$(\text{else}) \rightarrow \text{Amble}(\text{new point}(\text{pos}, \text{loc})) \quad (5.14)$$

where *new point* picks a new random point in the vicinity of *pos* and *loc*.

Again, if the robot is at the destination it does nothing. If the path to goal is clear it executes the GoTo TR. Else it picks a new point relative to its current position and destination (*loc*) and recursively executes a new copy of Amble with that destination. Applying Lemma 5.4, the Amble TR is translated to a BT in Figure 5.9.

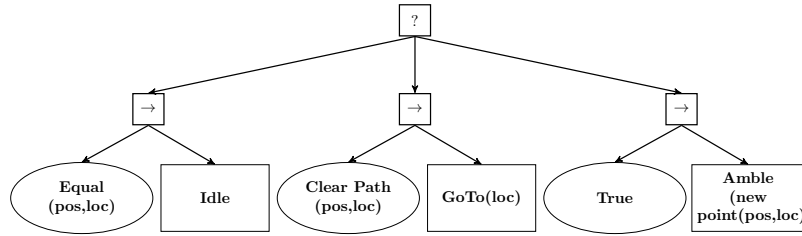

Fig. 5.9: The BT version of the TR Amble.

5.4.1 Universal TRs and FT-Successful BTs

Using the functional form of BTs introduced in 4.1 we can show that Lemma 4.3 is a richer version of Lemma 5.5 below, and also fix one of its assumptions. Lemma 4.3 includes execution time, but more importantly builds on a finite difference equation system model over a continuous state space. Thus control theory concepts can be used to include phenomena such as imperfect sensing and actuation into the analy-

sis, that was removed in the strong assumptions of Lemma 5.5. Thus, the BT analogy provides a powerful tool for analyzing TR designs.

Lemma 5.5 (Nilsson 1994). *If a TR-program is Universal, and there are no sensing and execution errors, then the execution of the program will lead to the satisfaction of k_1 .*

Proof. In [31] it is stated that it is easy to see that this is the case.

The idea of the proof is indeed straight forward, but as we will see when we compare it to the BT results in Section 5.4.1 below, the proof is incomplete.

In Lemma 4.3, S_i, R_i, F_i correspond to Success, Running and Failure regions and R' denotes the region of attraction.

Lemma 4.3 shows under what conditions we can guarantee that the Success region S_0 is reached in finite time. If we for illustrative purposes assume that the regions of attraction are identical to the running regions $R_i = R'_i$, the Lemma states that as long as the system starts in $R'_0 = R'_1 \cup R'_2$ it will reach $S_0 = S_1$ in less than $\tau_0 = \tau_1 + \tau_2$ time units. The condition analogous to the Regression property is that $S_2 \subset R'_1$, i.e. that the Success region of the second BT is a subset of the region of attraction R'_1 of the first BT. The regions of attraction, R'_1 and R'_2 are very important, but there is no corresponding concept in Lemma 5.5. In fact, we can construct a counter example showing that Lemma 5.5 does not hold.

Example 5.2 (Counter Example). Assume that a TR program is Universal in the sense described above. Thus, the execution of action a_i eventually leads to the satisfaction of k_j where $j < i$ for all $i \neq 1$. However, assume it is also the case that the execution of a_i , on its way towards satisfying k_j actually leads to a violation of k_i . This would lead to the first true condition being some k_m , with $m > i$ and the execution of the corresponding action a_m . Thus, the chain of decreasing condition numbers is broken, and the goal condition a_1 might never be reached.

The fix is however quite straightforward, and amounts to using the following definition with a stronger assumption.

Definition 5.1 (Stronger Regression property). For each $k_i, i > 1$ there is $k_j, j < i$ such that the execution of action a_i leads to the satisfaction of k_j , *without ever violating k_i .*

Chapter 6

Stochastic BTs

Some of the results of this chapter were previously published in the paper [8].

We are interested in modeling the reliability of reactive robot plan executions, in terms of execution times and success probabilities. To clarify what we mean by these concepts, we consider the following minimalistic example: a robot is searching for an object, and can choose between the two subtasks *searching on the table*, and *opening/searching the drawer*. One possible plan is depicted in Figure 6.1. Here, the robot first searches the table and then, if the object was not found on the table, opens the drawer and searches the drawer. In the figure, each task is assigned an execution time, and a success probability. For example, searching the table has a success probability of 0.1 and an execution time of 5s. Given a plan like this, it is fairly straightforward to compute the reliability of the entire plan, in terms of execution time distribution and success probability. In this chapter, we show how to compute such performance metrics for arbitrary complex plans encoded using BTs. In particular, we will define Stochastic BTs in Section 6.1, transform them into DTMCs in Section 6.2, compute reliabilities in Section 6.3 and describe examples Section 6.4.

Before motivating our study of BTs we will make a few more observations regarding the example above. First we note that the plan would still make sense if we changed the order of *searching on the table* and *opening/searching the drawer*, both subtasks achieve the objective of finding the object. Such subtasks, where ordering is not critical, and succeeding in just one is enough, will be called *Fallbacks*. Note however that it does not make sense to swap the order of *opening the drawer* and *searching the drawer*. Here, the order cannot be changed, and both subtasks must succeed. It does not make sense to search the drawer if we were not able to open it. We call such a set of subtasks a *Sequence*. Note that adding subtasks to a *Sequence* generally decreases overall success probabilities, whereas adding *Fallbacks* generally increases overall success probabilities.

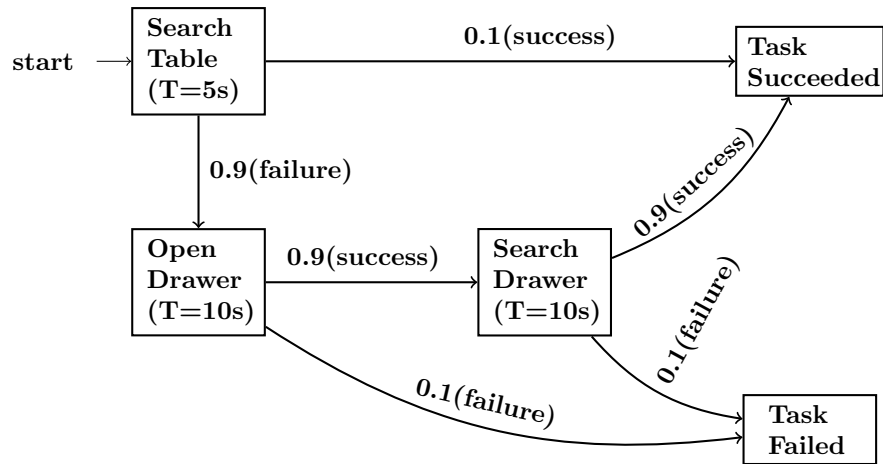

Fig. 6.1: A simple plan for a search task, modelled by a Markov Chain.

6.1 Stochastic BTs

In this section we will show how some probabilistic measures as term of Mean Time to Succeed (MTTS), Mean Time to Fail (MTTF), and probability over time carry across modular compositions of BTs. The advantage of using BTs lie in their modularity and hierarchical structure, which provides good scalability, as explained below. These features would be lost if the whole process from problem formulation to solution was carried out within the classical framework. To do show the properties above, we need to introduce some concepts from Markov theory.

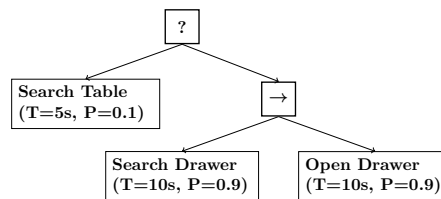

Fig. 6.2: The BT equivalent of the Markov chain in Figure 6.1. The atomic actions are the leaves of the tree, while the interior nodes correspond to *Sequence* compositions (arrow) and *Fallbacks* compositions (question mark).

6.1.1 Markov Chains and Markov Processes

Markov theory [32] deals with memory-less processes. If a process is given by a sequence of actions that changes the system's state disregarding its history, a DTMC is suitable to model the plan execution. Whereas if a process is given by a transition rates between states, a Continuous Time Markov Chain (CTMC) it then suitable to model such plan execution. A DTMC is given by a collection of states $\mathcal{S} = \{s_1, s_2, \dots, s_d\}$ and the transitions probabilities p_{ij} between states s_i and s_j . A CTMC is given by a collection of states \mathcal{S} and the transition rates q_{ij}^{-1} between states s_i and s_j .

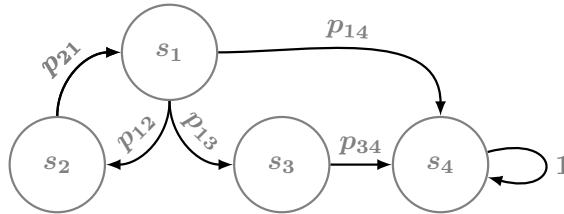

Fig. 6.3: Example of a DTMC with 4 states and 6 transitions.

Definition 6.1. The stochastic sequence $\{X_n, n = 0, 1, 2, \dots\}$ is a DTMC provided that:

$$\begin{aligned} P\{X_{n+1} = s_{n+1} | X_n = s_n, X_{n-1} = s_{n-1}, \dots, X_0 = s_0\} = \\ = P\{X_{n+1} = s_{n+1} | X_n = s_n\} \end{aligned} \quad (6.1)$$

$\forall n \in \mathbb{N}$, and $\forall s \in \mathcal{S}$

The expression on the right hand side of (6.1) is the so-called *one step transition probability* of the chain and denotes the probability that the process goes from state s_n to state s_{n+1} . We use the following notation:

$$p_{ij} = P\{X_{n+1} = s_j | X_n = s_i\} \quad (6.2)$$

to denote the probability to jump from a state s_i to a state s_j . Since we only consider homogeneous DTMC, the above probabilities do not change in time.

Definition 6.2. The *one-step transition matrix* P is a $|\mathcal{S}| \times |\mathcal{S}|$ matrix in which the entries are the transition probabilities p_{ij} .

Let $\pi(k) = [\pi_1(k), \dots, \pi_{|\mathcal{S}|}(k)]^\top$, where π_i is the probability of being in state i , then the Markov process can be described as a discrete time system with the following time evolution:

$$\begin{cases} \pi(k+1) = P^\top \pi(k) \\ \pi(0) = \pi_0. \end{cases} \quad (6.3)$$

where π_0 is assumed to be known a priori.

Definition 6.3. The stochastic sequence $\{X(t), t \geq 0\}$ is a CTMC provided that:

$$\begin{aligned} P\{X(t_{n+1}) = s_{n+1} | X(t_n) = s_n, X(t_{n-1}) = s_{n-1}, \dots, \\ X(t_0) = s_0\} = P\{X(t_{n+1}) = s_{n+1} | X(t_n) = s_n\} \end{aligned} \quad (6.4)$$

$\forall n \in \mathbb{N}, \forall s \in \mathcal{S}$, and all sequences $\{t_0, t_1, \dots, t_{n+1}\}$ such that $t_0 < t_1 < \dots < t_n < t_{n+1}$. We use the following notation:

$$p_{ij}(\tau) = P\{X(t + \tau) = s_j | X(t) = s_i\} \quad (6.5)$$

to denote the probability to be in a state s_j after a time interval of length τ given that at present time is into a state s_i . Since we only consider homogeneous CTMC, the above probabilities only depend on the time length τ .

To study the continuous time behavior of a Markov process we define the so-called *infinitesimal generator matrix* Q .

Definition 6.4. The infinitesimal generator of the transition probability matrix $P(t)$ is given by:

$$Q = [q_{ij}] \quad (6.6)$$

where

$$q_{ij} = \begin{cases} \lim_{\Delta t \rightarrow 0} \frac{p_{ij}(\Delta t) - \delta_{ij}}{\Delta t} & \text{if } i \neq j \\ -\sum_{k \neq i} q_{kj} & \text{otherwise.} \end{cases} \quad (6.7)$$

Then, the continuous time behavior of the Markov process is described by the following ordinary differential equation, known as the Cauchy problem:

$$\begin{cases} \dot{\pi}(t) = Q^\top \pi(t) \\ \pi(0) = \pi_0 \end{cases} \quad (6.8)$$

where the initial probability vector π_0 is assumed to be known a priori.

Definition 6.5. The average sojourn time SJ_i of a state s_i in a CTMC is the average time spent in that state. It is given by [39]:

$$SJ_i = -\frac{1}{q_{ii}} \quad (6.9)$$

Definition 6.6. Considering the CTMC $\{X(t), t \geq 0\}$, the stochastic sequence $\{Y_n, n = 0, 1, 2, \dots\}$ is a DTMC and it is called Embedded MC (EMC) of the process $X(t)$ [39].

The transition probabilities of the EMC r_{ij} are defined as:

$$r_{ij} = P\{Y_{n+1} = s_j | Y_n = s_i\} \quad (6.10)$$

and they can be easily obtained as a function of the transition rates q_{ij} :

$$r_{ij} = \begin{cases} -\frac{q_{ij}}{q_{ii}} & \text{if } i \neq j \\ 1 - \sum_{k \neq i} r_{kj} & \text{otherwise.} \end{cases} \quad (6.11)$$

On the other hand the infinitesimal generator matrix Q can be reconstructed from the EMC as follows

$$q_{ij} = \begin{cases} \frac{1}{\Delta t} r_{ij} & \text{if } i \neq j \\ -\sum_{k \neq i} r_{kj} & \text{otherwise.} \end{cases} \quad (6.12)$$

6.1.2 Formulation

We are now ready to make some definitions and assumptions, needed to compute the performance estimates. We begin with a formal definition of the BTs, first introduced in Chapter 1.

Definition 6.7. An action \mathcal{A} in a BT, is called *stochastic* if the following holds:

- It first returns running, for an amount of time that might be zero or non-zero, then consistently returns either success or failure for the rest of the execution of its parent node¹.
- The probability to succeed p_s and the probability to fail p_f are known a priori.
- The probability to succeed $p_s(t)$ and the probability to fail $p_f(t)$ are exponentially distributed with the following Probability Density Functions (PDFs):

$$\hat{p}_s(t) = p_s \mu e^{-\mu t} \quad (6.13)$$

$$\hat{p}_f(t) = p_f \nu e^{-\nu t} \quad (6.14)$$

from which we can calculate the Cumulative Distribution Functions (CDFs)

$$\bar{p}_s(t) = p_s(1 - e^{-\mu t}) \quad (6.15)$$

$$\bar{p}_f(t) = p_f(1 - e^{-\nu t}) \quad (6.16)$$

Definition 6.8. An action \mathcal{A} in a BT, is called *deterministic* (in terms of execution time, not outcome) if the following holds:

¹ The execution of the parent node starts when it receives a tick and finishes when it returns either success/failure to its parent.

- It first returns running, for an amount of time that might be zero or non-zero, then consistently returns either success or failure for the rest of the execution of its parent node.
- The probability to succeed p_s and the probability to fail p_f are known a priori.
- The time to *succeed* and the time to *fail* are deterministic variables τ_s and τ_f known a priori.
- The probability to succeed $p_s(t)$ and the probability to fail $p_f(t)$ have the following PDFs:

$$\hat{p}_s(t) = p_s \delta(t - \tau_s) \quad (6.17)$$

$$\hat{p}_f(t) = p_f \delta(t - \tau_f) \quad (6.18)$$

where $\delta(\cdot)$ is the Dirac's delta function. From the PDFs we can calculate the CDFs:

$$\bar{p}_s(t) = p_s H(t - \tau_s) \quad (6.19)$$

$$\bar{p}_f(t) = p_f H(t - \tau_f) \quad (6.20)$$

where $H(\cdot)$ is the step function.

Remark 6.1. Note that it makes sense to sometimes have $\tau_s \neq \tau_f$. Imagine a door opening task which takes 10s to complete successfully but fails 30% of the time after 5s when the critical grasp phase fails.

Example 6.1. For comparison, given a deterministic action with τ_s , we let the rates of a stochastic action have $\mu = \tau_s^{-1}$. Then the PDFs and CDFs are as seen in Fig. 6.4.

As we want to analyze the BT composition of actions, we must also define actions that include both stochastic and deterministic parts.

Definition 6.9. An action \mathcal{A} in a BT, is called *hybrid* if one of $p_s(t)$ and $p_f(t)$ is a random variable with exponential distribution, and the other one is deterministic.

Thus hybrid actions come in two different variations:

Deterministic success time

For this type of hybrid action, the following holds:

- It first returns running, for an amount of time that might be zero or non-zero, then consistently returns either success or failure for the rest of the execution of its parent node.
- The probability to succeed p_s is known a priori.
- The time to *succeed* is a deterministic variable τ_s known a priori.

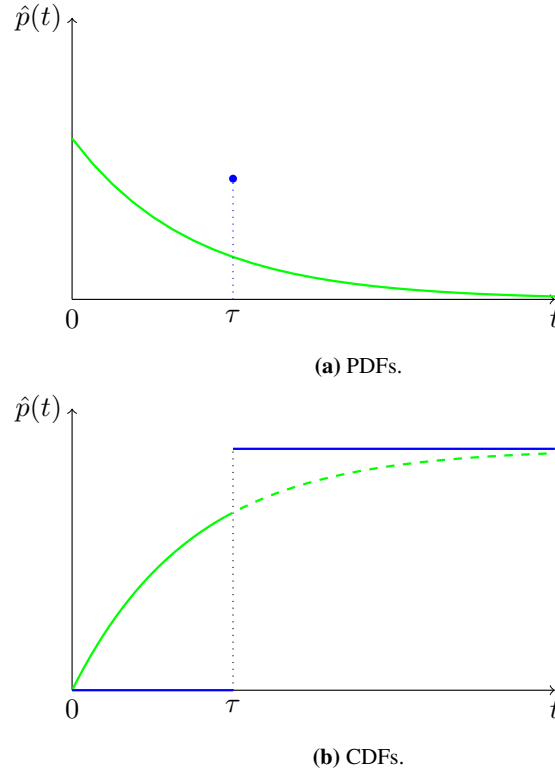

Fig. 6.4: Cumulative and probability density distribution function for a deterministic (blue lines) and stochastic action (green curve).

- The probability to fail has the following PDF:

$$\hat{p}_f(t) = \begin{cases} p_f(1 - e^{-vt}) & \text{if } t < \tau_s \\ 1 - p_s & \text{if } t = \tau_s \\ 0 & \text{otherwise} \end{cases} \quad (6.21)$$

In this case the CDF and the PDF of the probability to succeed are discontinuous. In fact this hybrid action will return failure if, after the success time τ_s , it does not return success. Then, to have an analogy with stochastic actions we derive the PDF of the probability to succeed:

$$\hat{p}_s(t) = p_s \delta(t - \tau_s) \quad (6.22)$$

and the CDFs as follows:

$$\bar{p}_s(t) = p_s H(t - \tau_s) \quad (6.23)$$

$$\bar{p}_f(t) = \begin{cases} p_f(1 - e^{-vt}) & \text{if } t < \tau_s \\ 1 - \bar{p}_s(t) & \text{otherwise} \end{cases} . \quad (6.24)$$

Thus, the probability of running is zero after τ_s i.e. after τ_s it either fails or succeeds. Moreover, the success rate is set to $\mu = \tau_s^{-1}$.

Deterministic failure time

For this type of hybrid action, the following holds:

- It first returns running, for an amount of time that might be zero or non-zero, then consistently returns either success or failure for the rest of the execution of its parent node.
- The probability to fail p_f is known a priori.
- The time to *succeed* is a random variables with exponential distribution with rate μ known a priori.
- The probability to succeed has the following PDF:

$$\hat{p}_s(t) = \begin{cases} p_s(1 - e^{-\mu t}) & \text{if } t < \tau_f \\ 1 - p_f & \text{if } t = \tau_f \\ 0 & \text{otherwise} \end{cases} . \quad (6.25)$$

To have an analogy with stochastic actions we derive the PDF of the probability to fail:

$$\hat{p}_f(t) = p_f \delta(t - \tau_f) \quad (6.26)$$

and the CDFs as follows:

$$\bar{p}_f(t) = p_f H(t - \tau_f) \quad (6.27)$$

$$\bar{p}_s(t) = \begin{cases} p_s(1 - e^{-\mu t}) & \text{if } t < \tau_f \\ 1 - \bar{p}_f(t) & \text{otherwise} \end{cases} . \quad (6.28)$$

Moreover, the failure rate is set to $\nu = \tau_f^{-1}$

Remark 6.2. Note that the addition of deterministic execution times makes (6.8) discontinuous on the right hand side, but it still has a unique solution in the Carathéodory sense [11].

We will now give an example of how these concepts transfer over BT compositions.

Example 6.2. Consider the BT in Fig. 6.5. The parallel node is set to returns success as soon as one child returns success, and the two children are of different kinds, one deterministic and the other stochastic. Note that the MTTs and MTF of this

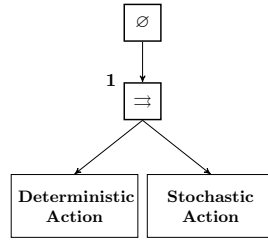
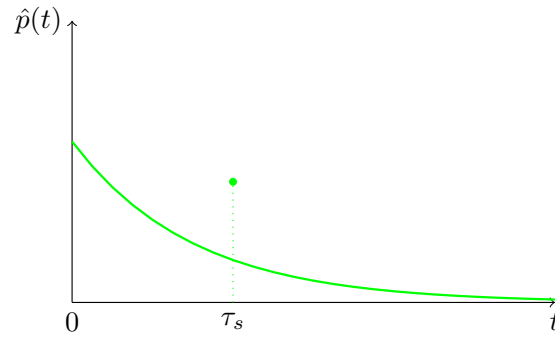
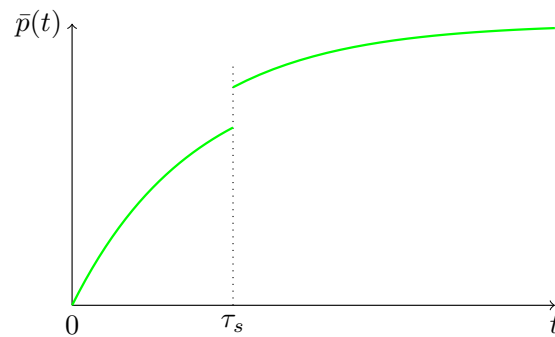

Fig. 6.5: Parallel node of Example 6.2.

BT has to account for the heterogeneity of its children. The deterministic child can succeed only at time τ_s . The CDF of the parallel node is given by the sum of the CDFs of its children. The PDF has a jump at time τ_s accounting for the fact that the parallel node is more likely to return success after that time. Thus, the PDF and the CDF of a Success return status are shown in Fig. 6.6.



(a) PDF.



(b) CDF.

Fig. 6.6: Cumulative and probability density distribution function of Success of the parallel node in Figure 6.5.

Definition 6.10. A BT \mathcal{T}_1 and a BT \mathcal{T}_2 are said to be *equivalent* if and only if \mathcal{T}_1 can be created from \mathcal{T}_2 by permutations of the children of Fallbacks and Parallel compositions.

An example of two equivalent BTs is shown in Fig. 6.7.

Assumption 3 For each action \mathcal{A} in the BT, one of the following holds

- The action \mathcal{A} is a stochastic action.
- The action \mathcal{A} is a deterministic action.
- The action \mathcal{A} is a hybrid action.

Assumption 4 For each condition \mathcal{C} in the BT, the following holds

- It consistently returns the same value (success or failure) throughout the execution of its parent node.
- The probability to succeed at any given time $p_s(t)$ and the probability to fail at any given time $p_f(t)$ are known a priori.

We are now ready to define a SBT.

Definition 6.11. A SBT is a BT satisfying Assumptions 3 and 4.

Given a SBT, we want to use the probabilistic descriptions of its actions and conditions, $p_s(t)$, $p_f(t)$, μ and ν , to recursively compute analogous descriptions for every sub-trees and finally the whole tree.

To illustrate the investigated problems and SBTs we take a look at the following example.

Example 6.3. Imagine a robot that is to search for a set of keys on a table and in a drawer. The robot knows that the keys are often located in the drawer, so that location is more likely than the table. However, searching the table takes less time, since the drawer must be opened first. Two possible plans are conceivable: searching the table first, and then the drawer, as in Fig. 6.7a, or the other way around as in Fig. 6.7b. These two plans can be formulated as SBTs and analyzed through the scope of Problem 1 and 2, using the results of Section 6.1 below. Depending on the user requirements in terms of available time or desired reliability at a given time, the proper SBT can be chosen.

Remark 6.3. Note that Assumption 1 corresponds to the return status of the search actions in Example 6.3 behaving in a reasonable way, e.g., not switching between success and failure.

6.2 Transforming a SBT into a DTMC

The first step of our approach is to define, for each control flow node in \mathcal{V} , a vector representation of the children's outcomes and a description of its execution policy,

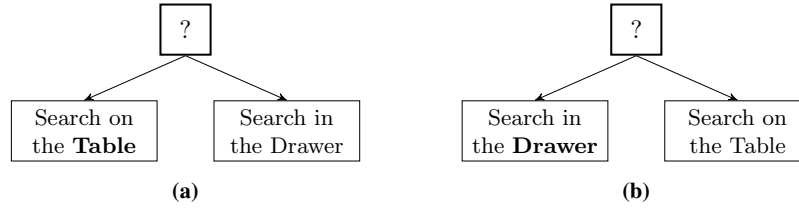

Fig. 6.7: BT modeling of two plan options. In (a), the robot searches on the table first, and in the drawer only if the table search fails. In (b), the table is searched only if nothing is found in the drawer.

then we map the execution into a DTMC with a direct representation of the one-step transition matrix, and finally we compute the probability of success and failure over time for each node.

Note that the modularity of BTs comes from the recursive tree structure, any BT can be inserted as sub-tree in another BT. This modularity allows us to do the analysis in a recursive fashion, beginning with the leaves of the BT, i.e. the actions and conditions which have known probabilistic parameters according to Assumptions 3 and 4, and then progressing upwards in a scalable fashion.

To keep track of the execution of a given flow control node, the children outcomes are collected in a vector state called the *marking* of the node, and the transitions between markings are defined according to the execution policy of the node. In detail, let $\mathbf{m}(k) = [m_1(k), m_2(k), \dots, m_N(k)]$ be a marking of a given BT node with N children at time step k with

$$m_i(k) = \begin{cases} -1 & \text{if child } i \text{ returns failure at } k \\ 1 & \text{if child } i \text{ returns success at } k \\ 0 & \text{otherwise} \end{cases} \quad (6.29)$$

Example 6.4. Consider the BT in Figure 6.7(a). If the first child (Search Table) has failed, and the second (Search Drawer) is currently running, the marking would be $\mathbf{m}(k) = [-1, 0]$.

We define an *event* related to a BT node when one of its children returns either success or failure. Defining $\mathbf{e}_i(k)$ to be the vector associated to the event of the i -th running child, all zeros except the i -th entry which is equal to $e_i(k) \in \{-1, 1\}$:

$$e_i(k) = \begin{cases} -1 & \text{if child } i \text{ has failed at } k \\ 1 & \text{if child } i \text{ has succeeded at } k. \end{cases} \quad (6.30)$$

We would like to describe the time evolution of the node marking due to an event associated with the child i as follows:

$$\mathbf{m}(k+1) = \mathbf{m}(k) + \mathbf{e}_i(k) \quad (6.31)$$

with the event $\mathbf{e}_i(k)$ restricted to the feasible set of events at $\mathbf{m}(k)$, i.e.

$$\mathbf{e}_i(k) \in \mathcal{F}(\mathbf{m}(k)).$$

In general, $\mathcal{F}(\mathbf{m}(k)) \subset \mathcal{F}_0$, with

$$\mathcal{F}_0 = \{\mathbf{e}_i : \mathbf{e}_i \in \{-1, 0, 1\}^N, \|\mathbf{e}_i\|_2 = 1\}, \quad (6.32)$$

i.e. events having only one nonzero element, with value -1 or 1 . We will now describe the set $\mathcal{F}(\mathbf{m}(k))$ for the three different node types.

Feasibility condition in the Fallback node

$$\begin{aligned} \mathcal{F}_{FB}(\mathbf{m}(k)) = \{\mathbf{e}_i \in \mathcal{F}_0 : \exists i : m_i(k) = 0, e_i \neq 0, \\ m_j(k) = -1, \forall j, 0 < j < i\}, \end{aligned} \quad (6.33)$$

i.e. the event of a child returning success or failure is only allowed if it was ticked, which only happens if it is the first child, or if all children before it have returned failure.

Feasibility condition in the Sequence node

$$\begin{aligned} \mathcal{F}_S(\mathbf{m}(k)) = \{\mathbf{e}_i \in \mathcal{F}_0 : \exists i : m_i(k) = 0, e_i \neq 0, \\ m_j(k) = 1, \forall j, 0 < j < i\}, \end{aligned} \quad (6.34)$$

i.e. the event of a child returning success or failure is only allowed if it was ticked, which only happens if it is the first child, or if all children before it have returned success.

Feasibility condition in the Parallell node

$$\begin{aligned} \mathcal{F}_P(\mathbf{m}(k)) = \{\mathbf{e}_i \in \mathcal{F}_0 : \exists i : m_i(k) = 0, e_i \neq 0, \\ \sum_{j:m_j(k)>0} m_j(k) < M \\ \sum_{j:m_j(k)<0} m_j(k) < N - M + 1\}, \end{aligned} \quad (6.35)$$

i.e. the event of a child returning success or failure is only allowed if it has not returned yet, and the conditions for success ($< M$ successful children) and failure ($< N - M - 1$ failed children) of the parallell node are not yet fulfilled.

Example 6.5. Continuing Example 6.4 above, $\mathcal{F}(\mathbf{m}(k)) = \mathcal{F}_{FB}([-1, 0]) = \{(0, 1), (0, -1)\}$, i.e. the second child returning success or failure. Note that if the first child would have returned success, the feasible set would be empty $\mathcal{F}_{FB}([1, 0]) = \emptyset$.

The Reachability Graph (RG), see Figure 6.8, of a BT node can now be computed starting from the initial marking $\mathbf{m}(0) = \mathbf{m}_0 = \mathbf{0}^\top$, taking into account all the possible event combinations that satisfy the feasibility condition.

Definition 6.12. A marking \mathbf{m}_i is reachable from a marking \mathbf{m}_j if there exists a sequence of feasible events $\sigma = [\sigma_1, \sigma_2, \dots, \sigma_g]$ such that $\mathbf{m}_i = \mathbf{m}_j + \sum_{h=1}^g \sigma_h$.

Remark 6.4. Note that $\mathbf{m}(k) = \mathbf{m}_i$ when \mathbf{m}_i is the marking at time k .

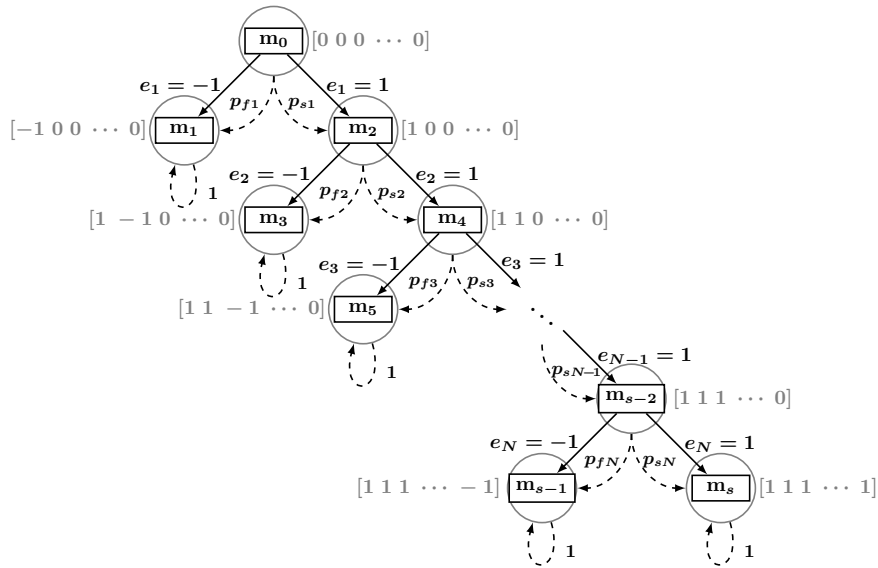

Fig. 6.8: Reachability graph of the sequence node (blue rectangles) with N children and its DTMC representation (cyan circles). When the node returns success/failure the related DTMC is in an absorbing state.

6.2.1 Computing Transition Properties of the DTMC

The RG of a BT node comprises all the reachable markings, the transitions between them describe events which have a certain success/failure probability. We can then map the node execution to a DTMC where the states are the markings in the RG

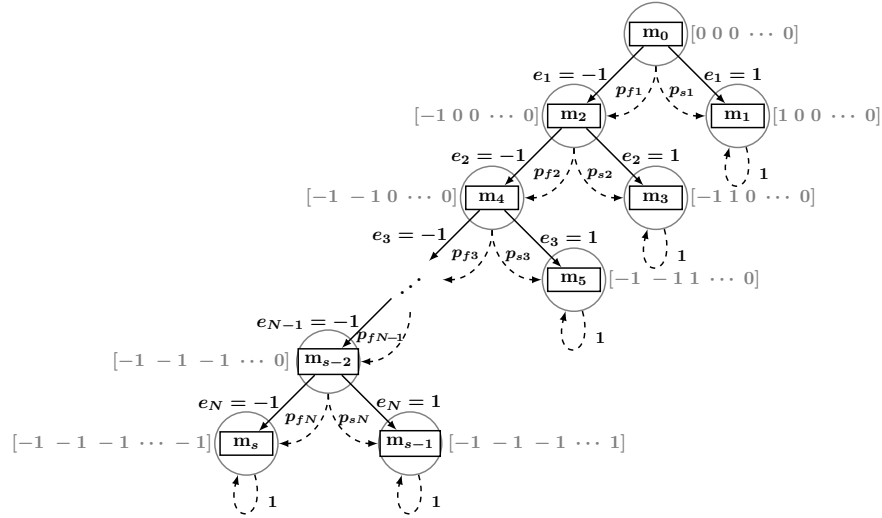

Fig. 6.9: Reachability graph of the fallback node (blue rectangles) with N children and its DTMC representation (cyan circles). When the node returns success/failure the related DTMC is in an absorbing state.

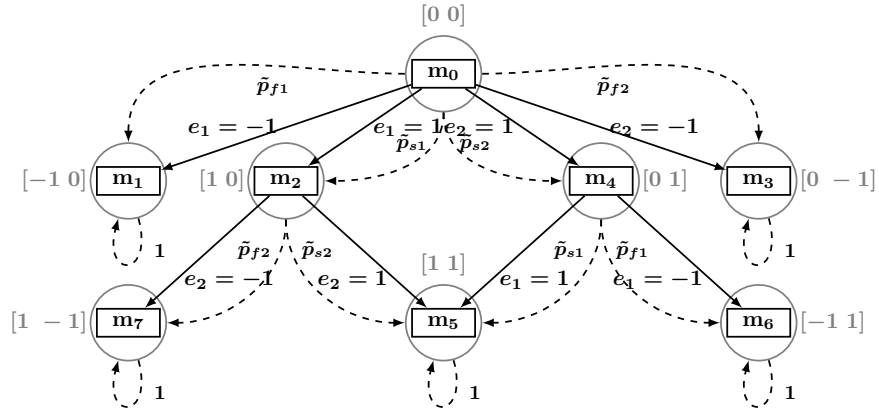

Fig. 6.10: Reachability graph of the parallel node (blue rectangles) with 2 children and its DTMC representation (cyan circles). When the node returns success/failure the related DTMC is in an absorbing state.

and the one-step transition matrix P is given by the probability of jump between markings, with off diagonal entries defined as follows:

$$p_{ij} = \begin{cases} \tilde{p}_{sh} & \text{if } \mathbf{m}_j - \mathbf{m}_i \in \mathcal{F}(\mathbf{m}_i) \wedge e_h \mathbf{e}_h^T (\mathbf{m}_j - \mathbf{m}_i) > 0 \\ \tilde{p}_{fh} & \text{if } \mathbf{m}_j - \mathbf{m}_i \in \mathcal{F}(\mathbf{m}_i) \wedge e_h \mathbf{e}_h^T (\mathbf{m}_j - \mathbf{m}_i) < 0 \\ 0 & \text{otherwise} \end{cases} \quad (6.36)$$

and diagonal entries defined as:

$$p_{ii} = 1 - \sum_j p_{ij}. \quad (6.37)$$

with:

$$\tilde{p}_{sh} = \frac{p_{sh} \mu_h \nu_h}{p_{fh} \mu_h + p_{sh} \nu_h} \cdot \left(\sum_{j: \mathbf{e}_j \in \mathcal{F}(\mathbf{m}_i)} \frac{\mu_j \nu_j}{p_{fj} \mu_j + p_{sj} \nu_j} \right)^{-1} \quad (6.38)$$

and

$$\tilde{p}_{fh} = \frac{p_{fh} \mu_h \nu_h}{p_{fh} \mu_h + p_{sh} \nu_h} \cdot \left(\sum_{j: \mathbf{e}_j \in \mathcal{F}(\mathbf{m}_i)} \frac{\mu_j \nu_j}{p_{fj} \mu_j + p_{sj} \nu_j} \right)^{-1} \quad (6.39)$$

where p_{sj} and p_{fj} is the p_s and p_f of child j .

Remark 6.5. For sequence and selector node the following holds: $\tilde{p}_{sh} = p_{sh}$ and $\tilde{p}_{fh} = p_{fh}$.

In Figs. 6.8 and 6.9 the mapping from RG to a DTCM related to a sequence node and a fallback node are shown. In Fig. 6.10 the mapping for a parallel node with two children and $M = 2$ is shown. We choose not to depict the mapping of a general parallel node, due to its large amount of states and possible transition between them.

To obtain the continuous time probability vector $\pi(t)$ we need to compute the infinitesimal generator matrix Q associated with the BT node. For doing so we construct a CTMC for which the EMC is the DTMC of the BT node above computed. According to (6.7) the map from the EMC and the related CTMC is direct, given the average sojourn times SJ_i .

6.3 Reliability of a SBT

6.3.1 Average sojourn time

We now compute the average sojourn time of each marking \mathbf{m}_i of a BT node.

Lemma 6.1. *For a BT node with $p_{si}, p_{fi}, \mu_i, \nu_i$ given for each child, the average sojourn time of in a marking \mathbf{m}_i is:*

$$SJ_i = \left(\sum_{h: \mathbf{e}_h \in \mathcal{F}(\mathbf{m}_i)} \left(\frac{p_{sh}}{\mu_h} + \frac{p_{fh}}{\nu_h} \right)^{-1} \right)^{-1} \quad (6.40)$$

with $h : \mathbf{e}_h \in \mathcal{F}(\mathbf{m}_i)$.

Proof. In each marking one of the following occur: the running child h fails or succeeds. To take into account both probabilities and time rates, that influence the average sojourn time, we describe the child execution using an additional CTMC, depicted in Fig. 6.11

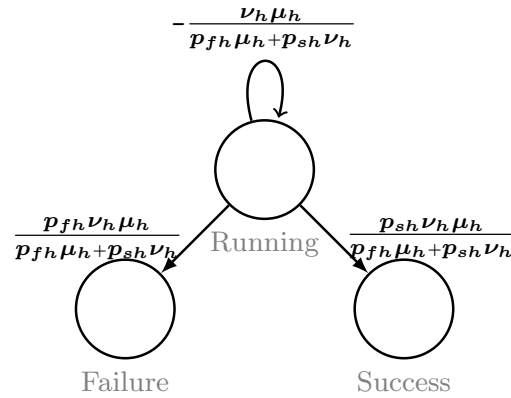

Fig. 6.11: CTMC of a child's execution.

According to (6.9) the average sojourn time is:

$$\tau_i = \frac{p_{fh} \mu_h + p_{sh} \nu_h}{\nu_h \mu_h} = \frac{p_{sh}}{\mu_h} + \frac{p_{fh}}{\nu_h} \quad (6.41)$$

and the rate of leaving that state is τ_i^{-1} . Now to account all the possible running children outcome, e.g. in a parallel node, we consider all the rates associate to the running children. The rate of such node is the sum of all the rates associate to the running children τ_i^{-1} . Finally, the average sojourn time of a marking \mathbf{m}_i is given by the inverse of the combined rate:

$$\frac{1}{SJ_i} = \sum_{h: \mathbf{e}_h \in \mathcal{F}(\mathbf{m}_i)} \frac{1}{\frac{p_{sh}}{\mu_h} + \frac{p_{fh}}{\nu_h}} \quad (6.42)$$

from which we obtain (6.40).

Remark 6.6. The EMC associated with the CTMC in Fig. 6.11 is depicted in Fig. 6.12. It describes the child's execution as a DTMC.

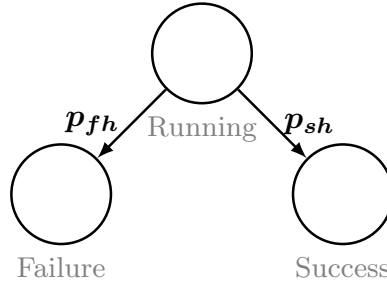

Fig. 6.12: DTMC of a child's execution.

6.3.2 Mean Time To Fail and Mean Time To Succeed

To derive a closed form of the mean time to fail (MTTF) and mean time to succeed (MTTS) of a BT node, we take the probability to reach a success (failure) state from the DTMC and the average time spent in each state visited before reaching this state obtained from (6.40). We rearrange the state space of the DTMC so that the initial state is first, the other transient states are second, the failure states are second last and the success states are last:

$$P_c^\top = \begin{bmatrix} T & 0 & 0 \\ R_F & \mathbb{I} & 0 \\ R_S & 0 & \mathbb{I} \end{bmatrix} \quad (6.43)$$

where T is the matrix describing the one-step transition from a transit state to another one, R_F is the matrix describing the one-step transition from a transit state to a failure state, and R_S is the matrix describing the one-step transition from a transit state to a success state. We call this rearrangement the *canonization* of the state space.

Lemma 6.2. Let A be a matrix with the ij -th entry defined as $\exp(t_{ij})$ where t_{ij} is the time needed to transit from a state j to a state i if j, i are neighbors in the RG, 0 otherwise. The MTTF and MTTS of the BT node can be computed as follows

$$MTTF = \frac{\sum_{i=1}^{|\mathcal{S}_F|} u_{i1}^F \log(h_{i1}^F)}{\sum_{i=1}^{|\mathcal{S}_F|} u_{i1}^F} \quad (6.44)$$

where:

$$H^F \triangleq A_F \sum_{i=0}^{\infty} A_T^i. \quad (6.45)$$

and

$$MTTS = \frac{\sum_{i=1}^{|\mathcal{S}_S|} u_{i1}^S \log(h_{i1}^S)}{\sum_{i=1}^{|\mathcal{S}_S|} u_{i1}^S} \quad (6.46)$$

where:

$$H^S \triangleq A_S \sum_{i=0}^{\infty} A_T^i \quad (6.47)$$

where A_T , A_F , and A_S are the sub-matrices of A corresponding to the canonization described in (6.43), for which the following holds:

$$A = \begin{bmatrix} A_T & 0 & 0 \\ A_F & 0 & 0 \\ A_S & 0 & 0 \end{bmatrix}. \quad (6.48)$$

Proof. Failure and success states are absorbing, hence we focus our attention on the probability of leaving a transient state, described by the matrix U , defined below:

$$U = \sum_{k=0}^{\infty} T^k, \quad (6.49)$$

Thus, considering i as the initial transient state, the entries u_{ij} is the mean number of visits of j starting from i before being absorbed, we have to distinguish the case in which the absorbing state is a failure state from the case in which it is a success state:

$$U^F \triangleq R_F U \quad (6.50)$$

$$U^S \triangleq R_S U. \quad (6.51)$$

Equations (6.50) and (6.51) represent the mean number of visits before being absorbed in a failure or success state respectively.

To derive MTTF (MTTS) we take into account the mean time needed to reach every single failure (success) state with its probability, normalized over the probability of reaching any failure (success) state, starting from the initial state. Hence we sum the probabilities of reaching a state starting from the initial one, taking into account only the first column of the matrices obtaining Eq. (6.44) and Eq. (6.46).

Remark 6.7. Since there are no self loops in the transient state of the DTMC above, the matrix T is nilpotent. Hence u_{ij} is finite $\forall i, j$.

6.3.3 Probabilities Over Time

Since all the marking of a BT node have a non null corresponding average sojourn time, the corresponding DTMC is a EMC of a CTMC with infinitesimal generator matrix $Q(t)$ as defined in (6.7). Hence, we can compute the probability distribution over time of the node according to (6.8) with the initial condition $\pi_0 = [1 \ \mathbf{0}]^T$ that represents the state in which none of the children have returned success/failure yet.

6.3.4 Stochastic Execution Times

Proposition 6.1. *Given a SBT, with known probabilistic parameters for actions and conditions, we can compute probabilistic measures for the rest of the tree as follows: For each node whose children have known probabilistic measures we compute the related DTMC. Now the probability of a node to return success $p_s(t)$ (failure $p_f(t)$) is given by the sum of the probabilities of the DTMC of being in a success (failure) state. Let $\mathcal{S}_S \subset \mathcal{S}_A$, and $\mathcal{S}_F \subset \mathcal{S}_A$ be the set of the success and failure states respectively of a DTMC related to a node, i.e. those states representing a marking in which the node returns success or failure, with $\mathcal{S}_F \cup \mathcal{S}_S = \mathcal{S}_A$ and $\mathcal{S}_F \cap \mathcal{S}_S = \emptyset$.*

Then we have

$$\bar{p}_s(t) = \sum_{i:s_i \in \mathcal{S}_S} \pi_i(t) \quad (6.52)$$

$$\bar{p}_f(t) = \sum_{i:s_i \in \mathcal{S}_F} \pi_i(t) \quad (6.53)$$

where $\pi(t)$ is the probability vector of the DTMC related to the node (i.e. the solution of (6.8)). The time to succeed (fail) for a node is given by a random variable with exponential distribution and rate given by the inverse of the MTTs (MTTF) since for such random variables the mean time is given by the inverse of the rate.

$$\mu = MTTs^{-1} \quad (6.54)$$

$$\nu = MTTF^{-1} \quad (6.55)$$

Remark 6.8. Proposition 6.55 holds also for deterministic and hybrid BTs, as (6.8) has a unique solution in the Carathéodory sense [11].

6.3.5 Deterministic Execution Times

As the formulation of the deterministic case involves Dirac delta functions, see Equation (6.17)-(6.18), the approach described above might lead to computational difficulties. As an alternative, we can take advantage of the fact that we know the exact time of possible transitions. Thus, the success and failure probabilities of a deterministic node are unchanged in the intervals between the MTTF and MTTs of its children.

Example 6.6. Consider the tree

$$\mathcal{T} = \text{fallback}(\mathcal{A}_1, \mathcal{A}_2) \quad (6.56)$$

depicted in Fig. 6.13 and let τ_{Fi} (τ_{Si}) be the *MTTF* (*MTTS*) of action i and p_{fi} (p_{si}) its probability to fail (succeed). The success/failure probability over time of the tree \mathcal{T} is a discontinuous function depicted in Fig. 6.14.

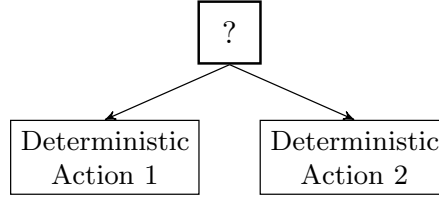

Fig. 6.13: Example of a fallback node with two deterministic actions/subtrees.

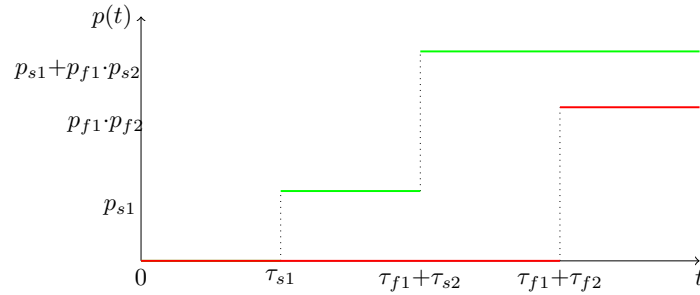

Fig. 6.14: Failure (red) and success (green) probability of the deterministic node of example. The running probability is the complement of the other two (not shown).

Hence the success and failure probability have discrete jumps over time. These piece-wise continuous functions can be described by the discrete time system (6.3) introducing the information of the time when the transitions take place, which is more tractable than directly solving (6.8). Then, the calculation of $\pi(t)$ is given by a zero order hold of the discrete solution.

Proposition 6.2. Let P be the one-step transition matrix given in Definition 6.2 and let τ_{Fi} (τ_{Si}) be the time to fail (succeed) of action i and p_{fi} (p_{si}) its probability to fail (succeed). Let $\tilde{\pi}(\tau) = [\tilde{\pi}_1(\tau), \dots, \tilde{\pi}_{|\mathcal{S}|}(\tau)]^\top$, where $\tilde{\pi}_i(\tau)$ is the probability of being in a marking \mathbf{m}_i at time τ of a RG representing a deterministic node with N children, let $\tilde{P}(\tau)$ be a matrix which entries $\tilde{p}_{ij}(\tau)$ are defined as:

$$\tilde{p}_{ij}(\tau) = \begin{cases} p_{ij} \cdot \delta(\tau - (\log(\tilde{a}_{j1}))) & \text{if } i \neq j \\ 1 - \sum_{k \neq i} \tilde{p}_{ik} & \text{otherwise} \end{cases} \quad (6.57)$$

with \tilde{a}_{ij} the ij -th entry of the matrix \tilde{A} defined as:

$$\tilde{A} \triangleq \sum_{i=0}^{\infty} A^i \quad (6.58)$$

with A as defined in (6.48).

Then the evolution of $\tilde{\pi}(k)$ process can be described as a discrete time system with the following time evolution:

$$\tilde{\pi}(\tau + \Delta\tau) = \tilde{P}(\tau)^\top \tilde{\pi}(\tau) \quad (6.59)$$

where $\Delta\tau$ is the common factor of $\{\tau_{F1}, \tau_{S1}, \tau_{F2}, \tau_{S2}, \dots, \tau_{FN}, \tau_{SN}\}$. Then for, deterministic nodes, given $\tilde{\pi}(\tau)$ the probability over time is given by:

$$\pi(t) = \text{ZOH}(\tilde{\pi}(\tau)) \quad (6.60)$$

where *ZOH* is the zero order hold function.

Proof. The proof is trivial considering that Eq. (6.59) is a piece-wise constant function and $\Delta\tau$ is the common fraction of all the step instants.

6.4 Examples

In this section, we present three examples. The first example is the BT in Figure 6.15a, which is fairly small and allows us to show the details of each step. The second example is the deterministic time version of the same BT, illustrating the differences between the two cases. The third example involves a more complex BT, shown in Figure 6.16. This example will be used to verify the approach numerically, by performing Monte Carlo simulations and comparing the numeric results to the analytical ones, see Table 6.2 and Figure 6.19. It is also used to illustrate the difference in performance metrics, between two equivalent BTs, see Figure 6.21.

We will now carry out the computation of probabilistic parameters for an example SBT.

Example 6.7. Given the tree shown in Fig. 6.15a, its probabilistic parameters are given by evaluating the fallback node, since it is the child of the root node. The given PDF of the i -th action are:

$$\hat{p}_s(t) = p_{s_i} \mu e^{-\mu t} \quad (6.61)$$

$$\hat{p}_f(t) = p_{f_i} \nu e^{-\nu t} \quad (6.62)$$

where:

- p_{f_i} probability of failure

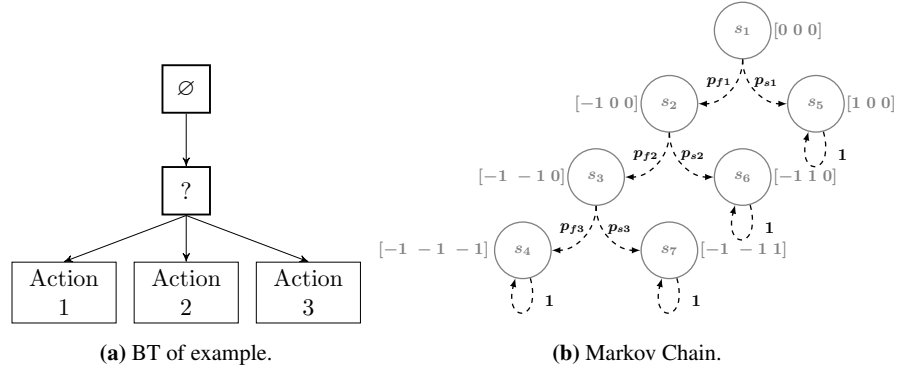

Fig. 6.15: BT and related DTMC modeling the plan of Example 6.4.

- p_{s_i} probability of success
- v_i failure rate
- μ_i success rate

The DTMC related as shown in Fig. 6.15b has $\mathcal{S} = \{s_1, s_2, s_3, s_4, s_5, s_6, s_7\}$, $\mathcal{S}_F = \{s_4\}$ and $\mathcal{S}_S = \{s_5, s_6, s_7\}$.

According to the canonization in (6.43), the one-step transition matrix is:

$$P_c^\top = \begin{bmatrix} 0 & 0 & 0 & 0 & 0 & 0 & 0 \\ p_{f1} & 0 & 0 & 0 & 0 & 0 & 0 \\ 0 & p_{f2} & 0 & 0 & 0 & 0 & 0 \\ 0 & 0 & p_{f3} & 1 & 0 & 0 & 0 \\ p_{s1} & 0 & 0 & 0 & 1 & 0 & 0 \\ 0 & p_{s2} & 0 & 0 & 0 & 1 & 0 \\ 0 & 0 & p_{s3} & 0 & 0 & 0 & 1 \end{bmatrix} \quad (6.63)$$

According to Equation (6.40) the average sojourn times are collected in the following vector

$$SJ = \left[\frac{p_{s1}}{\mu_1} + \frac{p_{f1}}{v_1}, \frac{p_{s2}}{\mu_2} + \frac{p_{f2}}{v_2}, \frac{p_{s3}}{\mu_3} + \frac{p_{f3}}{v_3} \right] \quad (6.64)$$

The infinitesimal generator matrix is defined, according to (6.7), as follows:

$$Q = \begin{bmatrix} \frac{-\mu_1 v_1}{p_{s_1} v_1 + p_{f_1} \mu_1} & 0 & 0 & 0 & 0 & 0 & 0 \\ \frac{\mu_1 v_1 p_{f_1}}{p_{s_1} v_1 + p_{f_1} \mu_1} & \frac{-\mu_2 v_2}{p_{s_2} v_2 + p_{f_2} \mu_2} & 0 & 0 & 0 & 0 & 0 \\ 0 & \frac{\mu_2 v_2 p_{f_2}}{p_{s_2} v_2 + p_{f_2} \mu_2} & \frac{-\mu_3 v_3}{p_{s_3} v_3 + p_{f_3} \mu_3} & 0 & 0 & 0 & 0 \\ 0 & 0 & \frac{\mu_3 v_3 p_{f_3}}{p_{s_3} v_3 + p_{f_3} \mu_3} & 0 & 0 & 0 & 0 \\ \frac{\mu_1 v_1 p_{s_1}}{p_{s_1} v_1 + p_{f_1} \mu_1} & 0 & 0 & 0 & 0 & 0 & 0 \\ 0 & \frac{\mu_2 v_2 p_{s_2}}{p_{s_2} v_2 + p_{f_2} \mu_2} & 0 & 0 & 0 & 0 & 0 \\ 0 & 0 & \frac{\mu_3 v_3 p_{s_3}}{p_{s_3} v_3 + p_{f_3} \mu_3} & 0 & 0 & 0 & 0 \end{bmatrix}. \quad (6.65)$$

The probability vector, according to (6.8), is given by:

$$\pi(t) = [\pi_1(t)\pi_2(t)\pi_3(t)\pi_4(t)\pi_5(t)\pi_6(t)\pi_7(t)]^\top \quad (6.66)$$

We can now derive closed form expression for MTTs and MTTF. Using the decomposition in (6.43), the matrices computed according Equations 6.51 and 6.50 are:

$$U^S = \begin{bmatrix} p_{s_1} & 0 & 0 \\ p_{f_1} p_{s_2} & p_{s_2} & 0 \\ p_{f_1} p_{f_2} p_{s_3} & p_{f_2} p_{s_3} & p_{s_3} \end{bmatrix} \quad (6.67)$$

$$U^F = [p_{f_1} p_{f_2} p_{f_3} \quad p_{f_2} p_{f_3} \quad p_{f_3}] \quad (6.68)$$

Note that U^S is a 3×3 matrix and U^F is a 1×3 matrix since there are 3 transient states, 3 success state and 1 failure state. For action i we define $t_{f_i} = v_i^{-1}$ the time to fail and $t_{s_i} = \mu_i^{-1}$ the time to succeed. The non-zero entries of the matrix given by (6.48) are:

$$\begin{aligned} a_{2,1} &= e^{t_{f_1}} & a_{3,2} &= e^{t_{f_2}} & a_{4,3} &= e^{t_{f_3}} \\ a_{5,1} &= e^{t_{s_1}} & a_{6,2} &= e^{t_{s_2}} & a_{7,3} &= e^{t_{s_3}} \end{aligned} \quad (6.69)$$

from which we derive (6.45) and (6.47) as:

$$H^S = \begin{bmatrix} e^{t_{s_1}} & 0 & 0 \\ e^{t_{f_1}} e^{t_{s_2}} & e^{t_{s_2}} & 0 \\ e^{t_{f_1}} e^{t_{f_2}} e^{t_{s_3}} & e^{t_{f_2}} e^{t_{s_3}} & e^{t_{s_3}} \end{bmatrix} \quad (6.70)$$

$$H^F = [e^{t_{f_1}} e^{t_{f_2}} e^{t_{f_3}} \quad e^{t_{f_2}} e^{t_{f_3}} \quad e^{t_{f_3}}] \quad (6.71)$$

Using Equations (6.44) and (6.46) we obtain the MTTs and MTTF. Finally, the probabilistic parameters of the tree are expressed in a closed form according to Equations (6.52)-(6.55):

$$\bar{p}_s(t) = \pi_5(t) + \pi_6(t) + \pi_7(t) \quad (6.72)$$

$$\bar{p}_f(t) = \pi_4(t) \quad (6.73)$$

$$\mu = \frac{p_{s_1} + p_{f_1} p_{s_2} + p_{f_1} p_{f_2} p_{s_3}}{p_{s_1} t_{s_1} + p_{f_1} p_{s_2} (t_{f_1} + t_{s_2}) + p_{f_1} p_{f_2} p_{s_3} (t_{f_1} + t_{f_2} + t_{s_3})} \quad (6.74)$$

$$\mathbf{v} = \frac{1}{t_{f_1} + t_{f_2} + t_{f_3}} \quad (6.75)$$

Example 6.8. Consider the tree given in Example 6.4, we now compute the performances in case when the actions are all deterministic.

The computation of MTTF and MTTs follows from Example 6.4, whereas the computation of $\pi(t)$ can be made according to Proposition 6.2.

According to (6.58) the matrix \tilde{A} takes the form below

$$\tilde{A} = \begin{bmatrix} 0 & 0 & 0 & 0 & 0 & 0 \\ e^{t_{f_1}} & 0 & 0 & 0 & 0 & 0 \\ e^{t_{f_1}} e^{t_{f_2}} & e^{t_{f_2}} & 0 & 0 & 0 & 0 \\ e^{t_{f_1}} e^{t_{f_2}} e^{t_{f_3}} & e^{t_{f_2}} e^{t_{f_3}} & e^{t_{f_3}} & 0 & 0 & 0 \\ e^{t_{s_1}} & 0 & 0 & 0 & 0 & 0 \\ e^{t_{f_1}} e^{t_{s_2}} & e^{t_{s_2}} & 0 & 0 & 0 & 0 \\ e^{t_{f_1}} e^{t_{f_2}} e^{t_{s_3}} & e^{t_{f_2}} e^{t_{s_3}} & e^{t_{s_3}} & 0 & 0 & 0 \end{bmatrix} \quad (6.76)$$

thereby, according to (6.57), the modified one step transition matrix takes the form of (6.77), and the probability vector $\pi(t)$ is given by (6.60).

$$\bar{p}^T = \begin{bmatrix} 1 - (p_{f_1} \delta(t-t_{f_1}) + p_{s_1} \delta(t-t_{s_1})) & 0 & 0 & 0 & 0 & 0 & 0 & 0 & 0 & 0 \\ p_{f_1} \delta(t-t_{f_1}) & 1 - (p_{f_2} \delta(t-(t_{f_1}+t_{f_2})) + p_{s_2} \delta(t-(t_{f_1}+t_{s_2}))) & 0 & 0 & 0 & 0 & 0 & 0 & 0 & 0 \\ 0 & p_{f_2} \delta(t-(t_{f_1}+t_{f_2})) & 0 & 0 & 0 & 0 & 0 & 0 & 0 & 0 \\ p_{s_1} \delta(t-t_{s_1}) & 0 & 0 & 0 & 0 & 0 & 0 & 0 & 0 & 0 \\ 0 & p_{s_2} \delta(t-(t_{f_1}+t_{s_2})) & 0 & 0 & 0 & 0 & 0 & 0 & 0 & 0 \\ 0 & 0 & p_{f_3} \delta(t-(t_{f_1}+t_{f_2}+t_{f_3})) & 0 & 0 & 0 & 0 & 0 & 0 & 0 \\ 0 & 0 & p_{s_3} \delta(t-(t_{f_1}+t_{f_2}+t_{s_3})) & 0 & 0 & 0 & 0 & 0 & 0 & 0 \end{bmatrix} \quad (6.77)$$

Below we present a more complex example, extending Example 6.4 above. We use this example for two purposes, first, to verify the correctness of the proposed approach using Monte Carlo simulations, and second, to illustrate how changes in the SBT lead to different performance metrics.

Example 6.9. The task given to a two armed robot is to find and collect objects which can be found either on the floor, in the drawers or in the closet. The time needed to search for a desired object on the floor is less than the time needed to search for it in the drawers, since the latter has to be reached and opened first. On the other hand, the object is more likely to be in the drawers than on the floor, or in the closet. Moreover, the available policies for picking up objects are the one-hand and the two-hands grasps. The one-hand grasp most likely fails, but it takes less time to check if it has failed or not. Given these options, the task can be achieved

in different ways, each of them corresponding to a different performance measure. The plan chosen for this example is modeled by the SBT shown in Fig. 6.16.

The performance estimates given by the proposed approach for the whole BT, as well as for two sub trees can be seen in Figs. 6.17-6.18 .

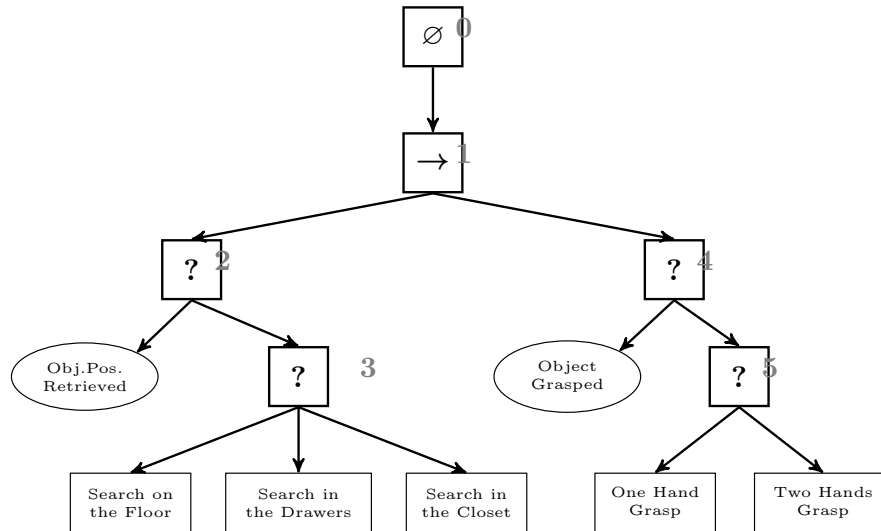

Fig. 6.16: BT modeling the search and grasp plan. The leaf nodes are labeled with a text, and the control flow nodes are labeled with a number, for easy reference.

We also use the example above to verify the correctness of the analytical estimates, and the results can be seen in Table 6.2. We compared the analytical solution derived using our approach with numerical results given by a massive Monte Carlo simulation carried out using a BT implementation in the Robot Operative System (ROS) [23] where actions and conditions are performed using ROS nodes with outcomes computed using the C++ random number generator with exponential distribution. The BT implementation in ROS was run approximately 80000 times to have enough samples to get numerical averages close to the true values. For each run we stored if the tree (and some sub-trees) succeeded or failed and how long it took, allowing us to estimate μ , ν , $p_s(t)$, $p_f(t)$ experimentally. The match is reported in Figs. 6.17-6.18 and in Table 6.1. As can be seen, all estimates are within 0.18 % of the analytical results.

To further illustrate the difference between modeling the actions as deterministic and stochastic, we again use the BT in Fig. 6.16 and compute the accumulated Success/Failure/Running probabilities for the two cases. Defining the time to succeed and fail as the inverse of the given rates and computing the probabilities as described in Section 6.3.5 we get the results depicted in Figs. 6.19 and 6.20. As can be seen, the largest deviation is found in the Failure probabilities. In the stochastic

Measure	Analytical	Numerical	Relative Error
μ_{Root}	5.9039×10^{-3}	5.8958×10^{-3}	0.0012
v_{Root}	4.4832×10^{-3}	4.4908×10^{-3}	0.0017
μ_3	6.2905×10^{-3}	6.2998×10^{-3}	0.0014
v_3	2.6415×10^{-3}	2.6460×10^{-3}	0.0017
μ_5	9.6060×10^{-2}	9.5891×10^{-2}	0.0018
v_5	4.8780×10^{-2}	4.8701×10^{-2}	0.0016

Table 6.1: Table comparing numerical and experimental results of MTTF and MTTS.

Label	μ	v	$p_s(t)$	$p_f(t)$
Obj. Pos. Retrieved	—	—	$p_{s5}(t)$	$p_{f5}(t)$
Object Grasped	—	—	$p_{s4}(t)$	$p_{f4}(t)$
Search on the Floor	0.01	0.0167	0.3	0.7
Search in the Drawer	0.01	0.01	0.8	0.2
Search in the Closet	0.005	0.0056	0.2	0.8
One Hand Grasp	0.1	20	0.1	0.9
Two Hands Grasp	0.1	0.05	0.5	0.5

Table 6.2: Table collecting given parameters, the labels of the control flow nodes are given in Fig. 6.16.

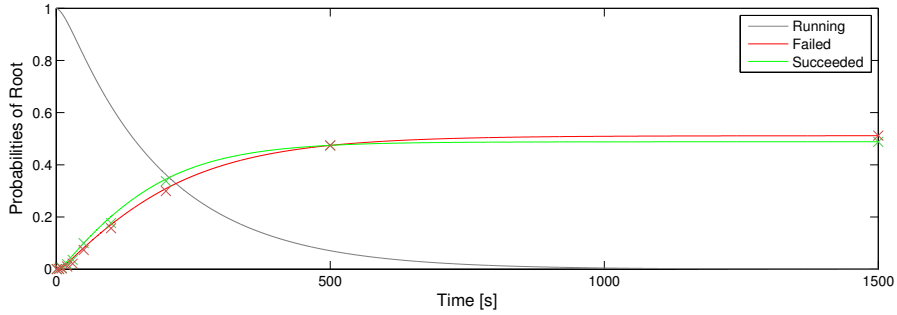
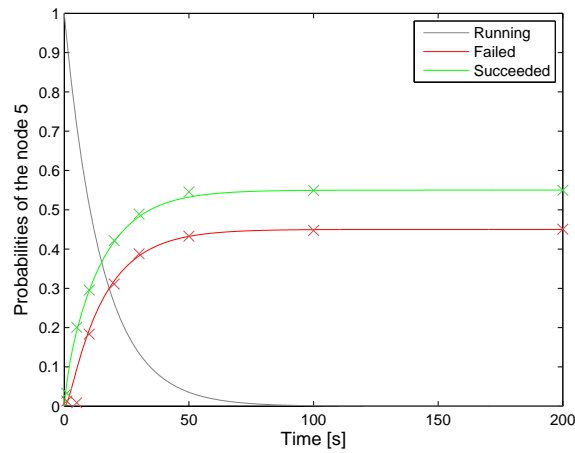

Fig. 6.17: Probability distribution over time for the Root node of the larger BT in Fig. 6.16. Numerical results are marked with an 'x' and analytical results are drawn using solid lines.

case the CDF rises instantly, whereas in the deterministic case it becomes non-zero only after all the fallbacks in at least one of the two sub-trees have failed.

In Fig. 6.21 the results of swapping the order of “Search on the Floor” and “Search in the Drawers” are shown in. As can be seen, the success probability after 100s is about 30% when starting with the drawers, and about 20% when starting with the floor. Thus the optimal solution is a new BT, with the drawer search as the first option. Note that the asymptotic probabilities are always the same for equivalent BT, see Definition 6.10, as the changes considered are only permutations of fallbacks.



(a) Node 5

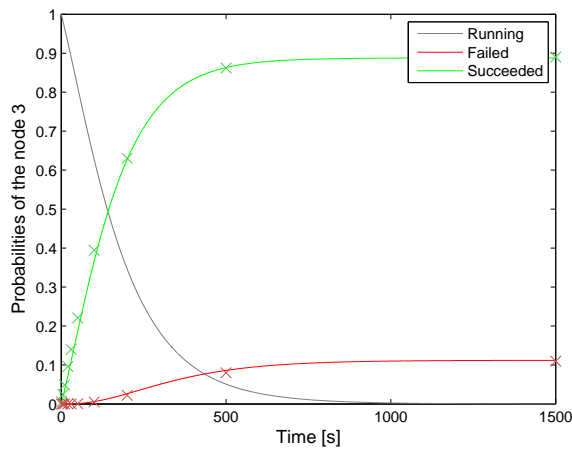

(b) Node 3

Fig. 6.18: Comparison of probability distribution over time related to Node 5 (a) and Node 3 (b). Numerical results are marked with 'x' and analytical results are drawn using solid lines.

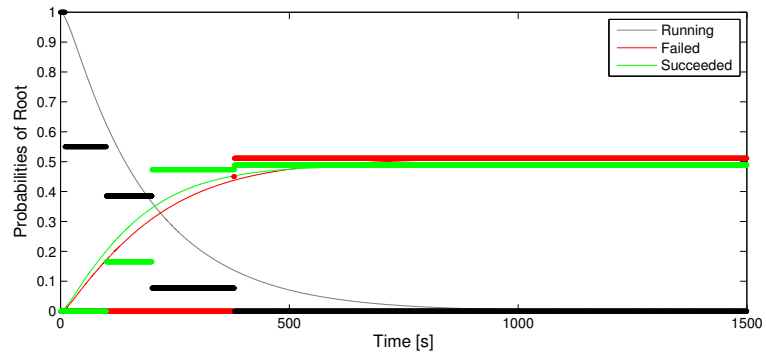
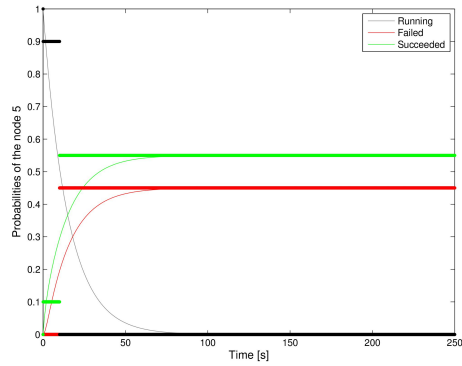
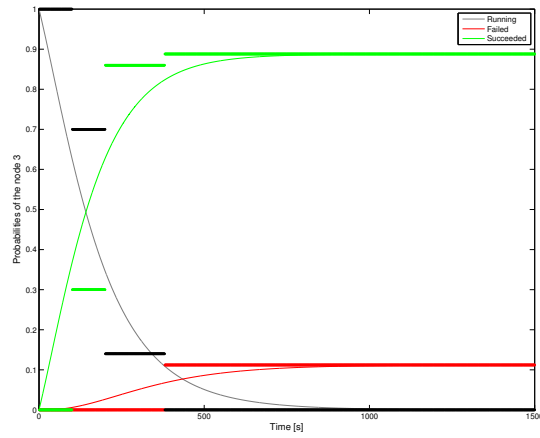

Fig. 6.19: Comparison of Success/Failure/Running probabilities of the root node in the case of deterministic times (thick) and stochastic times (thin).



(a) Node 5



(b) Node 3

Fig. 6.20: Comparison of Success/Failure/Running probabilities of the node 5 (a) and node 3 (b) in the case of deterministic times (thick) and stochastic times (thin).

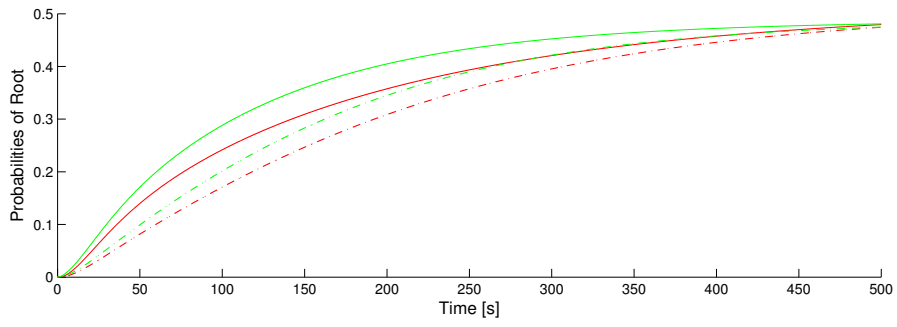

Fig. 6.21: Success/Failure probabilities in the case of searching on the floor first (dashed) and searching in the drawer first (solid).

References

1. J. Andrew (Drew) Bagnell, Felipe Cavalcanti, Lei Cui, Thomas Galluzzo, Martial Hebert, Moslem Kazemi, Matthew Klingensmith, Jacqueline Libby, Tian Yu Liu, Nancy Pollard, Mikhail Pivtoraiko, Jean-Sebastien Valois, and Ranqi Zhu. An Integrated System for Autonomous Robotics Manipulation. In *IEEE/RSJ International Conference on Intelligent Robots and Systems*, pages 2955–2962, October 2012.
2. Scott Benson and Nils J Nilsson. Reacting, planning, and learning in an autonomous agent. In *Machine intelligence 14*, pages 29–64. Citeseer, 1995.
3. Iva Bojic, Tomislav Lipic, Mario Kusek, and Gordan Jezic. Extending the JADE Agent Behaviour Model with JBehaviourtrees Framework. In *Agent and Multi-Agent Systems: Technologies and Applications*, pages 159–168. Springer, 2011.
4. R. Brooks. A Robust Layered Control System for a Mobile Robot. *Robotics and Automation, IEEE Journal of*, 2(1):14–23, 1986.
5. R.A. Brooks. Elephants don't play chess. *Robotics and autonomous systems*, 6(1-2):3–15, 1990.
6. Robert R Burridge, Alfred A Rizzi, and Daniel E Koditschek. Sequential Composition of Dynamically Dexterous Robot Behaviors. *The International Journal of Robotics Research*, 18(6):534–555, 1999.
7. A.J. Champandard. Understanding Behavior Trees. *AiGameDev.com*, 6, 2007.
8. Michele Colledanchise, Alejandro Marzinotto, and Petter Ögren. Performance Analysis of Stochastic Behavior Trees. In *Robotics and Automation (ICRA), 2014 IEEE International Conference on*, June 2014.
9. Michele Colledanchise and Petter Ögren. How behavior trees modularize hybrid control systems and generalize sequential behavior compositions, the subsumption architecture, and decision trees. *IEEE Transactions on Robotics*, 33(2):372–389, 2017.
10. Edsger W. Dijkstra. Letters to the editor: go to statement considered harmful. *Commun. ACM*, 11:147–148, March 1968.
11. A.F. Filippov and F.M. Arscott. *Differential Equations with Discontinuous Righthand Sides: Control Systems*. Mathematics and its Applications. Kluwer Academic Publishers, 1988.
12. Thomas Galluzzo, Moslem Kazemi, and Jean-Sebastien Valois. Bart - behavior architecture for robotic tasks, <https://code.google.com/p/bart/>. Technical report, 2013.
13. JK Gershenson, GJ Prasad, and Y Zhang. Product modularity: definitions and benefits. *Journal of Engineering design*, 14(3):295–313, 2003.
14. Gerhard Gubisch, Gerald Steinbauer, Martin Weiglhofer, and Franz Wotawa. A teleo-reactive architecture for fast, reactive and robust control of mobile robots. In *New Frontiers in Applied Artificial Intelligence*, pages 541–550. Springer, 2008.
15. Kelleher R. Guerin, Colin Lea, Chris Paxton, and Gregory D. Hager. A framework for end-user instruction of a robot assistant for manufacturing. In *IEEE International Conference on Robotics and Automation (ICRA)*, 2015.
16. David Harel. Statecharts: A visual formalism for complex systems, 1987.
17. Danying Hu, Yuanzheng Gong, Blake Hannaford, and Eric J. Seibel. Semi-autonomous simulated brain tumor ablation with raven ii surgical robot using behavior tree. In *IEEE International Conference on Robotics and Automation (ICRA)*, 2015.
18. D. Isla. Handling Complexity in the Halo 2 AI. In *Game Developers Conference*, 2005.
19. Damian Isla. Halo 3-building a Better Battle. In *Game Developers Conference*, 2008.
20. Andreas Klöckner, Franciscus van der Linden, and Dirk Zimmer. The Modelica BehaviorTrees Library: Mission planning in continuous-time for unmanned aircraft. In *Proceedings of the 10th International Modelica Conference*, 2014.
21. Andreas Klöckner. Interfacing Behavior Trees with the World Using Description Logic. In *AIAA conference on Guidance, Navigation and Control*, Boston, 2013.
22. C.U. Lim, R. Baumgarten, and S. Colton. Evolving Behaviour Trees for the Commercial Game DEFCON. *Applications of Evolutionary Computation*, pages 100–110, 2010.

23. Alejandro Marzinotto, Michele Colledanchise, Christian Smith, and Petter Ögren. Towards a Unified Behavior Trees Framework for Robot Control. In *Robotics and Automation (ICRA), 2014 IEEE International Conference on*, June 2014.
24. G. H. Mealy. A method for synthesizing sequential circuits. *The Bell System Technical Journal*, 34(5):1045–1079, Sept 1955.
25. Ian Millington and John Funge. *Artificial intelligence for games*. CRC Press, 2009.
26. Michael Montemerlo, Jan Becker, Suhrud Bhat, Hendrik Dahlkamp, Dmitri Dolgov, Scott Etinger, Dirk Haehnel, Tim Hilden, Gabe Hoffmann, Burkhard Huhnke, et al. Junior: The stanford entry in the urban challenge. *Journal of field Robotics*, 25(9):569–597, 2008.
27. Edward F Moore. Gedanken-experiments on sequential machines. *Automata studies*, 34:129–153, 1956.
28. Seyed R Mousavi and Krysia Broda. *Simplification Of Teleo-Reactive sequences*. Imperial College of Science, Technology and Medicine, Department of Computing, 2003.
29. Tadao Murata. Petri nets: Properties, analysis and applications. *Proceedings of the IEEE*, 77(4):541–580, 1989.
30. M. Nicolau, D. Perez-Liebana, M. O’Neill, and A. Brabazon. Evolutionary behavior tree approaches for navigating platform games. *IEEE Transactions on Computational Intelligence and AI in Games*, PP(99):1–1, 2016.
31. Nils J. Nilsson. Teleo-reactive programs for agent control. *JAIR*, 1:139–158, 1994.
32. J.R. Norris. *Markov Chains*. Number no. 2008 in Cambridge Series in Statistical and Probabilistic Mathematics. Cambridge University Press, 1998.
33. Petter Ögren. Increasing Modularity of UAV Control Systems using Computer Game Behavior Trees. In *AIAA Guidance, Navigation and Control Conference, Minneapolis, MN*, 2012.
34. Chris Paxton, Andrew Hundt, Felix Jonathan, Kelleher Guerin, and Gregory D Hager. Costar: Instructing collaborative robots with behavior trees and vision. *arXiv preprint arXiv:1611.06145*, 2016.
35. Matthew Powers, Dave Wooden, Magnus Egerstedt, Henrik Christensen, and Tucker Balch. The Sting Racing Team’s Entry to the Urban Challenge. In *Experience from the DARPA Urban Challenge*, pages 43–65. Springer, 2012.
36. Steve Rabin. *Game AI Pro*, chapter 6. The Behavior Tree Starter Kit. CRC Press, 2014.
37. Claude Sammut, Scott Hurst, Dana Kedzier, and Donald Michie. *Imitation in Animals and Artifacts*, chapter Learning to Fly, page 171. MIT Press, 2002.
38. Alexander Shoulson, Francisco M Garcia, Matthew Jones, Robert Mead, and Norman I Badler. Parameterizing Behavior Trees. In *Motion in Games*. Springer, 2011.
39. William J Stewart. *Probability, Markov chains, queues, and simulation: the mathematical basis of performance modeling*. Princeton University Press, 2009.
40. Chris Urmson, Joshua Anhalt, Drew Bagnell, Christopher Baker, Robert Bittner, MN Clark, John Dolan, Dave Duggins, Tugrul Galatali, Chris Geyer, et al. Autonomous driving in urban environments: Boss and the urban challenge. *Journal of Field Robotics*, 25(8):425–466, 2008.
41. Chris Urmson, J Andrew Bagnell, Christopher R Baker, Martial Hebert, Alonzo Kelly, Raj Rajkumar, Paul E Rybski, Sebastian Scherer, Reid Simmons, Sanjiv Singh, et al. Tartan racing: A multi-modal approach to the darpa urban challenge. 2007.
42. Blanca Vargas and E Morales. Solving navigation tasks with learned teleo-reactive programs. *Proceedings of IEEE International Conference on Robots and Systems (IROS)*, 2008.