

A tunable low energy P_s beam for the anti-hydrogen free fall and for testing gravity with a Mach-Zehnder interferometer

Andre Rosowsky
IRFU,CEA, Université Paris-Saclay*
(Dated: December 14, 2024)

The test of gravitational force on antimatter in the field of the matter gravitational field, produced by earth, can be done by a free fall experiment which involves only General Relativity, and with a Mach-Zehnder interferometer which involves Quantum Mechanics. This article presents a new method to produce a tunable low energy (P_s) beam suitable for trapping the (\bar{H}^+) ion in a free fall experiment, and suitable for a gravity Mach-Zehnder interferometer with (P_s). The low energy (P_s) beam is tunable in the [10 eV, 100 eV] range.

PACS numbers: 36.10.Gv,34.35.+a,68.49.Bc,41.75.Fr,41.75.Ht,73.20.Mf,34.80.Pa,03.75.Hh,03.75.Kk

keywords: Antimatter gravity,Antihydrogen,Positronium,Positron

I. Introduction

When the Standart Model of particles interactions and General Relativity are involved in the same phenomena a number of questions are unanswered. Assuming the CPT invariance[1][2][3], the theory states that anti-matter attracts anti-matter in the same way as matter attracts matter, but it tells nothing about the attraction, or the repulsion, of an anti-matter atom in the field of matter mass like the one generated by the earth. The Standart Model of particles interactions is mute on the subject since it does not include gravitation. Anti-matter is a quantum field theory concept which is not required by General Relativity. In fact a consistent Quantum Field Theory capable of merging General Relativity with the Standart Model has still to be found.

When Quantum Field Theory and General Relativity are both considered to interpret gravitational atomic interferometry, they lead two diverging points of views and creative controversies that will be presented in the frame of positronium gravitational interferometry.

Even in the frame of pure General Relativity, the galaxy rotation curve cannot be explained, which lead to introduce dark matter and dark energy, that is new quantum fields. These dark quantities are there to compensate for the inconsistency of the curve with General Relativity, but are not required by the Standart Model which is experimentally confirmed at unprecedented precision.

General relativity considers only one type of mass, and does not make any distinction for the parameter called mass when it is used for particles or for anti-particles. Mass in the frame of General Relativity is both the dynamical variable related to inertia via the energy-momentum, and to gravitation via the free fall along a geodesic. In Quantum field theory mass is only related to inertia via the energy-momentum, but not to gravitation.

These situations have triggered a lot of efforts to perform

a *free fall* experiment with an atom of anti-hydrogen. Since there is no prediction by theory, here *free fall* of an atom of anti-hydrogen released at rest, means that it can go up or down. The main difficulty to perform the experiment is to produce an atom of anti-hydrogen with an horizontal speed of the order of 60 m.s^{-1} or less, and with a spread of vertical speed corresponding to a temperature below $10 \text{ } \mu\text{eV}$. In a trap which contains a cloud of particles, the temperature refers to the kinetic energy spread in the particles kinetic energy distribution. But in the free-fall experiment there is only 1 particle involved, not a cloud. The temperature here, refers to the cooling cloud and hence to the atom residual uncontrolled kinetic energy after cooling, that shall be below $10 \text{ } \mu\text{eV}$.

The test of anti-hydrogen free fall is a General relativity experiment which does not involves Quantum Mechanics. Conversely, the Colella Overhauser Werner experiment (COW)[4][5] performed in 1959, was a test of gravitational effect on the de Broglie wave length of neutrons : it involved both General Relativity, via gravitation, and Quantum Mechanics. The same test can be done with an atom made in equal parts of matter and anti-matter : positronium (P_s). If the free fall experiment finds that the matter anti-matter interaction is repulsive, then the interferometer experiment will measure this difference provided that General relativity and Quantum Mechanics are both valid. Furthermore, if the repulsive force intensity is equal to the attractive force between matter particles, then the interference oscillation pattern of the COW experiment shall vanish in the case of the (P_s) atom. Hence both experiments are tightly related.

In 1995, at CERN, the PS210 experiment produced 9 atoms of antihydrogen at the Low Energy Antiproton Ring (LEAR) with an antiproton (p^-) beam crossing a Xenon jet target. So the first experiment to produce (\bar{H}) atoms was a *beam-on-target experiment*. The following experiments performed at the Antiproton Decelerator (AD) were all based on electromagnetic traps, hence *bottle type experiment* : ATRAP[6][7], ATHENA[8][9], ASACUSA[10]. The success of these experiments in producing (\bar{H}) in large quantities, or in the case of ASACUSA storing large amount of (p^-) in a trap, opened the door to the first measurements on (\bar{H}). Since the trapped particles carry little kinetic energy, the key parameter in these experiments is the particle cloud temperature : a bottle exper-

* Address: CEN Saclay, F-91191 GIF-sur-YVETTES Cedex, FRANCE; andre.rosowsky@cern.ch

iment scientific potential is as great as the cloud temperature is low. In the first experiments, the temperature achieved was not low enough to allow for a free fall experiment. Also at the time, it was not commonly realized that neither the Standart Model, nor the CPT invariance, would make any prediction on the attractive or repulsive feature of the gravitational force between matter and anti-matter, or conversely would trigger controversies. The next generation of bottle type experiments, ALPHA[11][12], BASE[13], CUSP[14](CUSP is the follow-up of ASACUSA) aim at lower temperatures, which, in principle, will allow the ALPHA experiment to detect the attractive or repulsive feature of matter-antimatter gravitation, will allow CUSP to measure with accuracy the hyperfine transition in the ground state $n=1$, and will allow BASE to measure with accuracy the proton-antiproton charge to mass ratio and magnetic moment. None of these bottle type experiment is designed to directly observe and measure the free-fall of an atom of antihydrogen in the matter field of gravitation of earth.

Conversely, two beam-on-target experiments, AEGIS[15][16] and GBAR[17][18] are designed specifically with the goal to observe and measure the free-fall, that can go up or down, of an antihydrogen atom.

Both experiments are performed at CERN, and both rely on the production of the ion of anti-matter (\bar{H}^+) in two steps.

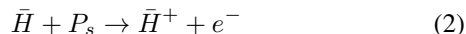
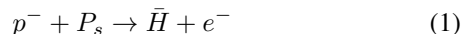

So the first goal of these experiments is not to produce the atom (\bar{H}), but the ion (\bar{H}^+). Unlike the atom, the ion can be cooled at the temperature of $10 \mu\text{eV}$ [19]. Both experiments have choosen a positronium target, that is a cloud of (P_s) atom at rest, with kinetic energy of 1 eV or less. The beam is made of a precooled cloud of antiprotons (p^-) stored in trap before being accelerated and packaged into a beam of few keV.

The opposite configuration, that is a beam of (P_s) atoms on a (p^-) target at rest, requires a low energy beam of (P_s) atoms. With a low energy (P_s) beam, one can then improve the production scheme designed for GBAR[20]. This method can be used by both GBAR and AEGIS but will require some modifications in their steps and layout. It can also be used to convert CUSP into an antihydrogen free fall experiment, and to improve its hyperfine measurement.

Once a (P_s) beam is available, the complementary gravity experiment, a gravity quantum mechanical experiment, becomes feasible. Such an experiment will be described: it is a positronium version of the Colella Overhauser Werner experiment (COW) that was performed with neutrons.

The first section will present the production of the (P_s) beam. The second section will discuss the kinematic constraints of the beam on target reactions (1) and (2) seen from two reference frames: (p^-) beam on a (P_s) target, and (P_s) beam on a (p^-) target. The number of ions (\bar{H}^+) that could be

produced by CUSP and GBAR with this layout will be computed. The third section will present the gravity interferometry with a (P_s) beam. The fourth section will present the controversy.

II. The (P_s) beam.

The physics of (P_s) formation when a positron beam hits a metal target has been subject of several experiments and theoretical studies between 1970 and 1990. The main findings are :

- (P_s) is not produced in the bulk but near the surface of the metal,
- positrons with kinetic energy of few keV thermalise while migrating from the bulk to the surface where they are either trapped, or form (P_s) which is itself trapped, by vacancies or oxygen contamination,
- metals which have a negative work function eject the (P_s) atoms and the positrons at very low kinetic energy corresponding to the negative work function value,
- when the temperature of the metal target is raised, the (P_s) atoms trapped on the surface can free themselves more easily and the fraction of (P_s) ejected from the metal increases.

Most of the theoretical and experimental effort was focused on thermalized positrons from an incident beam with kinetic energy of ~ 1 keV or more. The role assigned to (P_s) atoms was to measure the void cavities under the skin of the material. We will concentrate here on a different channel : the scattering of positrons at low energy, between 10 eV and 100 eV, but above the surface trapping of (e^+ , P_s) at lower positron incident energy.

Below 1 keV, two channels are no more neglectable and compete with the thermal desorption of (P_s) created from thermalized positrons:

- like electrons, at about 1 keV incident kinetic energy, the number of positrons backscattered after few interactions becomes large,
- below 100 eV the tail of the backscattered positrons overlaps with the ($e^+ + e^- \rightarrow P_s$) cross section, producing backscattered (P_s) atoms.

Since for many years the goal was to produce very low energy positrons and (P_s) sources, the effort was focused on thermalized positrons, that is positrons implemented in the metal skin with kinetic energies of 1 keV or more. In that perspective, backscattered (P_s) was a source of loss and noise, and was often disregarded. Conversely (e^+) diffraction and reflection were studied, and provide experimental data on (P_s) as a side effect. The article [21] which presents the results of

experimental Bragg reflection of (e^+) on Al and Cu notes that the reflection of (P_s) is constant for (e^+) incident energy between 0 eV and 40 eV. But there were very few measurements of backscattered (P_s) from a metal, and the one focused on this topic, by R. H. Howell , I. J. Rosenberg , M. J. Fluss, was at energies at or above 50 eV [22]. Nevertheless this precious data will be used to estimate the the backscattered fraction of (P_s) suitable to produce a low diverging beam.

Unlike thermalized positrons which produce (P_s) at low energy and in a wide angular cone around the metal normal direction [23], the backscattered (P_s) are emitted within a small angle, producing a (P_s) beam.

Few alternative paths to produce a (P_s) beam were proposed . Photodetachment of the positronium negative ion was used to produce a tunable beam with energy in the [300 eV, 1.9 keV] window [24]. The beam is too high in energy and not coherent, hence not suitable for interferometry. Charge exchange reaction of energetic positrons with gas molecules is another approach [25][26], but as for the photodetachment, the beam energy is too high, the beam is not coherent and the efficiency is low.

Conversely, scattering of positrons at glancing angle[27] can be used to produce a coherent (e^+) beam. This approach with higher energies, ~ 20 keV, is used to study crystal surface[28] : the reflection high-energy positron diffraction (RHEPD). But the high kinetic energy prevents the conversion of the (e^+) beam into a (P_s) beam and leads to low efficiency in converting (e^+) into (P_s) beam ($\sim 5\%$).

Compared to the above methods, the backscattered diffracted (e^+) approach proposed here, leads to higher conversion efficiency as observed by R. H. Howell , I. J. Rosenberg , M. J. Fluss, and with the useful feature of being coherent, and hence suitable for interferometry.

A. Low energy positron diffraction from a metal crystal

The measurements of the fraction of backscattered (P_s) from an incident (e^+) beam performed by R. H. Howell , I. J. Rosenberg, M. J. Fluss, are synthesized in table (I). These values are visually extracted from the article, hence their precision is $\sim 1\%$. The graph built with these values corresponds to the figure 6 of their article. This experiment has a mask which limits the acceptance for the backscattered (P_s) within 30 degrees with respect to the normal incident beam.

The authors have interpreted these data by comparing them with elastic backscattering of electrons, and concluded that the increase of the fraction of backscattered (P_s), resulted from the overlapping of the tail of the elastic backscattering cross section with the (P_s) formation cross section. This picture is not objected here but a complement is added. The elastic scattering is re-interpreted as diffraction, and the crossing of the curves is explained by the availability of Surface Plasmons Polaritons (SPP) at, or slightly above, 6.8 eV.

Measurements performed with ionic crystal surfaces, LiF

TABLE I: Fraction of backscattered Ps within a cone of 1/2 opening angle 30 degrees

$K(e^+) \text{ eV}$	Al	Cu	Au	Ni
50	0.42	0.26	0.20	0.22
100	0.26	0.21	0.20	0.17
200	0.15	0.16	0.17	0.13
500	0.09	0.12	0.16	-
1000	0.04	-	0.10	0.09
2000	-	0.04	0.08	-
3000	-	-	0.05	0.03

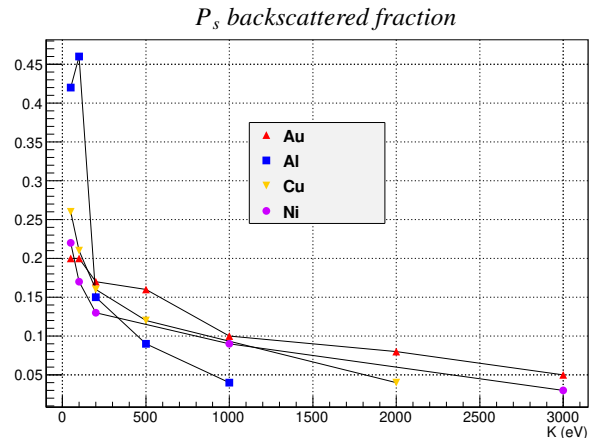
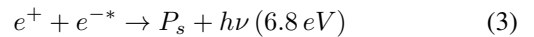

FIG. 1

and NaF, have shown a large backscattering of 25 eV (e^+) in the first order Bragg reflexion [29]. Similar measurements have shown (e^+) Bragg reflexion below 10 eV on Crystals of Al and Cu [21]. Based on these measurements, the (P_s) backscattering from incoming (e^+) is modeled as a 2 steps process :

1. the (e^+) diffraction by the first plane of nuclei in the metal,
2. the interaction (e^+) with Surface Plasmons Polaritons to produce (P_s).

In the 2nd step, the (P_s) atom is created by the following reaction, where (e^{-*}) stands for electron in the metal.



At energies above ~ 10 eV and below ~ 1000 eV, the (e^+) are diffracted by the first plane of nuclei in the metal. The normal incident diffraction notations are illustrated in figure (2).

The constructive interference condition at normal incidence is then :

$$d = a \cdot \sin(\theta) = n \cdot \lambda \quad (4)$$

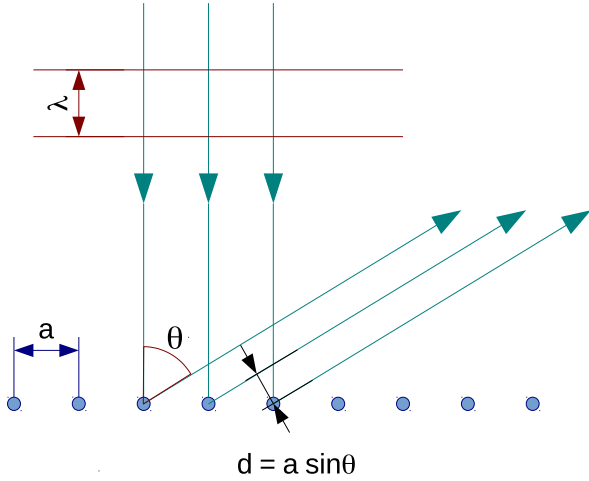

FIG. 2: Diffraction of the (e^+) by the first plan of nuclei.

and :

$$\lambda = \frac{h}{\sqrt{2 \cdot m \cdot e \cdot V}} \approx \sqrt{\frac{150}{V}} \text{ \AA} \quad (5)$$

We can now compute the angles at which the (e^+) are backscattered before capturing the (e^{-*}) to form (P_s) for ($n = 1$) and ($n = 2$). The results, and the corresponding lattice parameter (a) are shown in table (II) and table (III).

At 100 eV and above, the diffracted angle is smaller than the mask and therefore the order ($n = 1$) backscattered (P_s) atoms are within the detector acceptance, but at these energies, the reaction (3) cross section decreases very fast, leading to the decrease of the backscattered (P_s) atoms. The same is true for the order ($n = 2$) at 200 eV and above.

At 50 eV both the order ($n = 0$) and ($n = 1$) are within the 30 degrees mask acceptance for Al and Au. While for Cu and Ni the order ($n = 1$) is at the edge and only a fraction of the corresponding (P_s) atoms can reach the detector. The θ difference between Cu and Ni for ($n = 1$) is only 1.1 degree, but the decrease of backsattered (P_s) is (4%) on a total of ($\sim 22\%$), that is a relative loss of (18%) showing the effect of the mask edge.

TABLE II: Angle of ($n = 1$) diffracted e^+ with and incident energy from (50 eV) to (200 eV)

metal	a (\AA)	θ deg (50 eV)	θ deg (100 eV)	θ deg (200 eV)
Al	4.046	25.3464	17.6202	12.3595
Cu	3.597	28.7851	19.9068	13.9316
Au	4.065	25.2196	17.5351	12.3008
Ni	3.499	29.6706	20.4890	14.3300

The lower fraction of backsattered (P_s) for Au relative to

TABLE III: Angle of ($n = 2$) diffracted e^+ with and incident energy from (50 eV) to (200 eV)

metal	a (\AA)	θ deg (50 eV)	θ deg (100 eV)	θ deg (200 eV)
Al	4.046	58.8903	37.2584	25.3464
Cu	3.597	74.3767	42.9204	28.7851
Au	4.065	58.4493	37.0549	25.2196
Ni	3.499	81.9010	44.4313	29.6706

Al cannot be explained by the diffraction angle, but by Surface Plasmons Polaritons, as discussed in the next section.

Since the intensity of diffracted electrons on a metal crystal is almost the same for the orders 0 and 1, we can estimate that the fraction of backscattered (P_s) emitted at each order is 1/2 of the total measured, when only 2 modes are within the mask acceptance. That fraction is ($\sim 20\%$) for Aluminium. At (50 eV) there are 3 Bragg diffracted modes, but only 2 are within the mask.

From this analysis we can infer that the fraction shall increase when the incoming (e^+) energy decreases between 50 eV and 10 eV, because the number of allowed diffraction Bragg modes decreases from 3 to 2. Below 10 eV, the adsorption of both (e^+) and (P_s) by surface states shall be taken into account [30]. So the operational (P_s) beam energy range is between ~ 10 eV and 100 eV.

The divergence opening angle of the (P_s) beam can be inferred from the backscattering of electrons. The Low Energy Electron Diffraction (LEED) method is a common method to investigate the surface of crystals, and the divergence of a diffracted mode is less than 10 mrd. In the case of electrons, a main contributor to the divergence comes from the diffraction of multiple ions planes, as the electrons penetrate deeper. In the case of low energy positrons, the repulsion of the first positive nuclei plane reduces this effect.

B. P_s creation and surface states

The reaction (6) below is a radiative recombination in vacuum. The resonant energy of the emitted photon is 6.8 eV, and its small width, explain the small cross section. Conversely in a 3 body recombination like the reaction (7), the extra (e^-) provides the resonant condition by adjusting its kinetic energy. That is made possible because a free electron in vacuum can take any kinetic energy.

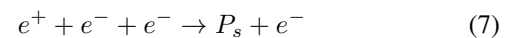
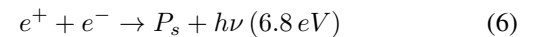

For the reaction (3), the radiated 6.8 eV photon is absorbed by the metal surface states, and it shall correspond to a permitted transition. So without a resonance in the spectrum of the electrons collective surface states, a fraction of the (e^+, e^-)

radiative recombinations does not take place. Hence the availability of Surface Plasmon Polariton (SPP) resonance at 6.8 eV, or nearby with a large width, enhances the (P_s) production cross section.

The SPP of most metals are below the required 6.8 eV, and they cannot absorb this energy : the situation is similar to radiative capture in vacuum with a 2 body reaction. But the SPP resonant energy for Al is exceptionally high at 10.5 eV and is few eV wide, allowing the SPP resonance to overlap with the P_s potential well at 6.8 eV. Conversely the SPP resonant energy of Au is at 1.58 eV. One can infer then, that the reason for the larger fraction of P_s atoms emitted with a 50 eV beam on Al, versus Au, is the availability of a Surface Plasmon Polariton resonance.

The difference between the thermalized regime for incident (e^+) on Al(100) above 1 keV, and backscattered regime below 100 eV, may explain the observed inconsistency of the experimental data for incident energy at 200 eV and 1.5 keV, with both the model of positrons in the image correlation potential well, and with the model of weakly bound (P_s) atoms[31]. At 1.5 keV the positrons are thermalized, while at 200 eV there is a mixing of thermalized and backscattered positrons. In this measurement[31], the divergency of the diffracted spot was found to be 7.1 mrd which is consistent with ~ 10 mrd upper limit given above.

An experiment was performed with a non-metal : graphite[32]. It was observed that the thermalized positrons form (P_s) atoms, and these atoms are emitted within 4 mrd, while the emission intensity grows with temperature. This last feature is a signature of the creation of (P_s) atoms from positrons which are first thermalized, then trapped at the surface. The incident (e^+) kinetic energy was 750 eV which is consistent with thermalized positrons. But the shape of the angular emission could not be explained by a direct electron capture. The model, proposed by the authors, states that the emission resulted from interactions with phonons. The comparison of the model with the data [32] shows a good agreement.

So in a similar way as the low energy (e^+), backscattered from the first layer of a metal atoms, form (P_s) atoms assisted by SPP, the high energy (e^+), thermalized inside graphite, form (P_s) atoms assisted by phonons. Increasing the phonons density with temperature, increases the emission intensity.

This analysis suggests two ways to improve the (P_s) beam intensity. The first one is to choose a metal with a SPP resonance at 6.8 eV. Magnesium has a SPP resonance at ~ 7 eV and should be a suitable crystal target. The second one is to use stimulated emission. Radiative ion electron recombination in vacuum can be enhanced by stimulated emission of the radiated photon, using a laser. In a similar fashion, reaction (3) could, in principle, be enhanced in Al and Mg by generating SPP while the (e^+) beam hit the target. Such SPP could be created by an electron beam of 7 eV for Mg, or 10.5 eV for Al. SPP could also be created by photons[33].

Furthermore, the launch of polarized Surface Plasmons Po-

laritons was demonstrated[34]. Hence with stimulated emission of polarized Surface Plasmons Polaritons, if the incident (e^+) beam is also made polarized[35], it is possible to produce a polarized ortho-positronium beam.

C. The (P_s) beam configuration.

The diffraction configuration discussed in the previous sections, with an incident beam at 90 degrees, is the one used both by the data's article and by the LEED technique for which a large number of experimental data are available. But one could also use the Bragg angle configuration with the same metals, Al and Mg. The analysis is the same and the conclusions hold.

The apparatus proposed to create a (P_s) beam, is made of a crystal with a SPP resonance overlapping 6.8 eV and with an energy tunable (e^+) beam. A possible configuration is illustrated in figure 3. This beam is made incident at a selected Bragg angle. With an incident energy below 100 eV, the (e^+) do not penetrate deep in the crystal, and only the first two planes have to be taken into account for the Bragg diffraction. These effect is reflected in the very high backscattering efficiency observed in the measurement at 90 degrees incident beam discussed in the previous section. With Aluminium, the total number of allowed modes is 3 at 90 degrees incident beam, with 50 eV (e^+), but only 2 modes are within the mask acceptance of the experiment. So the maximum fraction of (P_s) atoms that could be emitted in each mode, if there were no losses, is 33%. When limited to 2 modes, the experiment measured 42%. So the expected efficiency of emitting a (P_s) atom in a single selected mode at Bragg reflexion, is $42/66 = 63.6\%$. The (e^+) which are reflected without capturing an electron are few. Above 10 eV, the measurements on Al give a $\sim 2\%$ reflection of (e^+) exiting the crystal : most of the incident (e^+) are reflected as (P_s) atoms[22][21].

This experimental efficiency is a lower limit, since no stimulated emission of SPP and no polarization of both the SPP and the (e^-) were implemented. Hence with a single mode emission at a selected Bragg angle, it is expected that 63.6% , at least, of the (e^-) beam is transformed into an unpolarized (P_s) beam. And a higher efficiency is expected with Magnesium and/or with stimulated SPP emission.

Unlike for (e^-), there is no Fermi sea of positrons in the metal, and the absolute value of the work function is very small, hence the (e^+) are diffracted with their incident kinetic energy. The energy variation is the 6.8 eV emission for the creation of (P_s) corrected by the small work function.

III. (\bar{H}^+) production with a tunable P_s beam

The GBAR experiment will be taken as reference for the discussion, but the same arguments are valid for similar experiments based on (\bar{H}^+).

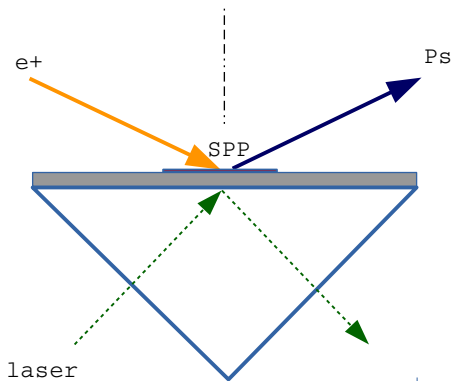

FIG. 3: Layout for an SPP stimulated emission of a (P_s) atom beam.

A. Kinematics

The kinematic energy of the reaction (1) is better understood in the reference frame of the (p^-) at rest. An incoming (P_s) atom requires at least 6.8 eV to break the link between the positron and the electron. This energy is the depth of the potential of the (P_s) atom in the ground state. This energy is provided by the kinetic energy of the incoming (P_s) atom. So the cross section for producing (\bar{H}) starts at 6.8 eV. At larger kinetic energy, above ~ 40 eV, the positron (e^+), once released by the breaking of (P_s), carries to much kinetic energy to fall into the 13.6 eV potential of (\bar{H}). Hence the cross section is high between 10 eV and 40 eV, and neglectable at others (P_s) beam kinetic energies.

Once transposed in the reference frame of the (P_s) atom at rest, with a (p^-) beam, the kinetic energy of the antiproton for the maximum cross section is around 10~15 keV due to the fact that its mass is ($\sim 1000\times$) larger than the one of the (P_s) atom.

When a light object in a beam, (P_s), collides with an heavy object at rest, in this case (p^-), the heavy object does not recoil, and all the kinetic energy of the incoming light object is converted to break the (P_s) atom. Conversely when an heavy object collides with a light one at rest, the light object's recoil absorbs most of the incoming kinetic energy which is no more available for the reaction. That is why, a 10 eV (p^-) beam colliding with a (P_s) target at rest will not produce the reaction (1).

The table (IV) gives for each bin of (P_s) kinetic energy in the frame of (p^-) at rest, the corresponding kinetic energy of the (p^-) in the frame of the (P_s) atom at rest.

For the next step, reaction (2), to get the ion, the electromagnetic potential of the second positron (e^+) is at the depth of 0.7 eV, and the depth of the ($n=3$) excited state of the (P_s) atom is 0.75 eV : the very near depth of the two potentials allows for a very high cross section, provided that the relative speed of (P_s) and (\bar{H}) is small. The contradiction is then the

TABLE IV: (P_s) kinetic energy with (p^-) at rest and equivalent (p^-) kinetic energy for (P_s) at rest (eV)

K_{P_s}	K_{p^-}	K_{P_s}	K_{p^-}	K_{P_s}	K_{p^-}
1	918.083	11	10098.9	21	19279.7
2	1836.17	12	11017	22	20197.8
3	2754.25	13	11935.1	23	21115.9
4	3672.33	14	12853.2	24	22034
5	4590.41	15	13771.2	25	22952.1
6	5508.5	16	14689.3	26	23870.1
7	6426.58	17	15607.4	27	24788.2
8	7344.66	18	16525.5	28	25706.3
9	8262.74	19	17443.6	29	26624.4
10	9180.83	20	18361.7	30	27542.5

requirement to have a 15 keV (p^-) beam which, once transformed into (\bar{H}), shall become a nearly 0 eV beam.

The solution proposed here is different : use a tunable 10 eV (P_s) beam on (p^-) at rest, to optimize both the ($P_s(n=1)$) interaction of reaction (1), and the ($P_s(n=3)$) interaction for the reaction (2). This solution hence relies on the availability of a (P_s) beam with a tunable kinetic energy at 10 eV.

Without a tunable (P_s) beam, GBAR has to find a compromise between the collision kinetic energies suitable for both the reactions (1) and (2). Since GBAR is a (p^-) beam on a (P_s) target experiment, the compromise is on the (p^-) beam energy which is set at 6 keV.

Conversely here the first reaction is a (P_s) beam colliding on a slow moving (p^-) target, and the second one is a (P_s) beam in the (3^3P) state slowly crossed by an (\bar{H}) beam.

The initial (p^-) target will be in the [20 eV , 100 eV] window. The kinetic energy has two functions:

1. to extract the (p^-) cloud from the trap where it is cooled,
2. to package the cloud into a beam 1 cm long, with a diameter below 1mm, beam which defines the line of flight.

From the point of view of the reactions (1) and (2), this energy range is so low that the target is "at rest". While at GBAR the (P_s) cloud is enclosed inside a square tube 1 x 1 mm² and 2 cm long, here the (P_s) will be a beam that is first used in a collision mode to produce (\bar{H}), and then slow down, while being set in the 3^3P state, so that the produced (\bar{H}) is slightly faster and crosses the excited (P_s) cloud like in bottle experiment. The same (P_s) beam is used for both reactions, but the preparation of the (P_s) in the excited (3^3P) state is used to slow down the beam at a speed slightly lower than the (p^- , \bar{H}) beam.

B. The (p^-) target and the steps sequence

The (p^-) target is easier to handle if it is not at rest. And in order to get the largest cross sections for the reactions (1) and (2), we shall have the (P_s) beam hitting the target at ~ 10 eV, and then be slow down to the speed of (\bar{H}).

The following configuration is proposed:

1. start with a (p^-) target at low energy, between 20 and 100 eV,
2. hit the target by a faster (P_s) beam in the same direction at 10 eV for reaction (1),
3. after the (P_s) is ahead of the (p^- , \bar{H}) beam, slow down the (P_s) with a ($1^3S - 3^3P$) transition (205 nm, 6.05 eV),
4. then slow down the 15% of (P_s) beam which is in the (3^3P) excited state, with a ($3^3P - 2^3S - 3^3P$) stimulated emission + excitation (1320 nm, 2×0.94 eV),
5. repeat the slow down ($3^3P - 2^3S - 3^3P$) transition once,
6. the (\bar{H}) being slightly faster than the excited (P_s) beam, the collision is at low relative speed to produce the ion (\bar{H}^+).

The 2 transitions ($3^3P - 2^3S - 3^3P$) will be referred to as a ‘‘Slow Down Station’’ (SDS). The advantage of starting at $n=3$ and then performing a stimulated emission + excitation, is that the final rest state is 3^3P . Other similar sequences can be done via $n=2$ and/or $n=4$ states to reach an excited $n = 3$ state with (P_s) final kinetic energy below 1 eV. For instance, GBAR has chosen the sequence ($1^3S - 2^3P - 3^3D$)[36]. The ($1^3S - 3^3P$) is selected here because it has been proven experimentally[37], and because the full SDS sequence with these 3 states is relatively simple compared to others paths.

Once the first transition and the 2 Doppler emissions-excitations have taken place, the (P_s) beam kinetic energy falls down to $10 - 6.05 - 4 \times 0.94 = 0.17$ eV. By slightly lowering the (P_s) beam energy below 10 eV, one can tune the speed of (P_s) just below the (\bar{H}) one, at will : this energy is fully set by setting the (e^+) initial beam energy. By fine tuning both the (P_s) kinetic energy around 10 eV, and the initial (p^-) beam energy, the cross section of reaction (2) can be optimized while keeping the reaction (1) near its maximum. The low kinetic energy of the (p^-) is sufficient to extract it from its cooling trap, and low enough to have a target practically at rest.

To move from (\bar{H}) to (\bar{H}^+), the atom shall capture a second positron (e^+) in a potential at the depth of 0.7 eV while the depth of the ($n=3$) excited state of the (P_s) atom is 0.75 eV : the difference is 0.05 eV. The energy spread of the (p^- , \bar{H}) beam will distribute this energy, but fine tuning of the (p^-) initial beam allows for adjusting the (P_s) energy distribution to optimize the (\bar{H}^+) production. One of the advantage of using very low energy p^- beam is that relative to the p^- mass,

this energy is so small that even if poorly defined, it does not affect the cross section. Conversely GBAR has a spread of kinetic energy of the p^- beam of ~ 1 keV which degrades either reaction (1) or reaction (2). As for the (P_s) beam, since it is produced by diffraction and resonant SPP emission, its kinetic energy is not affected by diffusion and multiple scattering. The (e^+) do not thermalise, hence the (P_s) beam spread can be kept within ~ 0.5 eV : none of the cross sections of reactions (1) and (2) is affected.

Note that to produce (P_s) at 10 eV, the incident (e^+) beam shall be at $10 + 6.8 = 16.8$ eV because 6.8 eV will be absorbed by the emission of a Surface Plasmon Polariton.

C. The experimental layout

The experimental layout to implement this configuration is drawn in figure 4. With a pair of electrostatic deflectors, the (p^-) beam can be aligned with the (P_s) beam within 1 cm of flight length.

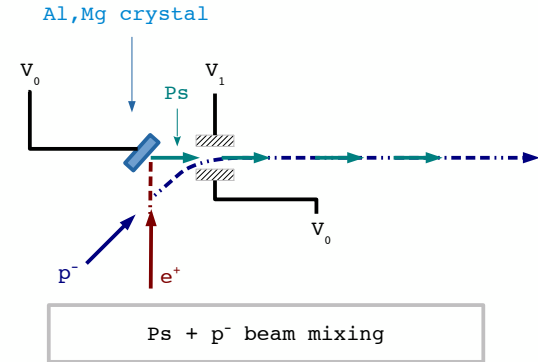

FIG. 4

Starting with an (e^+) beam source with a diameter of $100\mu\text{m}$, and with a divergence of 10 mrd (10 mrd is conservative, smaller divergences are obtained with LEED), the (P_s) beam diameter grows $200\mu\text{m}$ every 1cm. Distances will be counted from the metal crystal (P_s) source. With a separation of 1cm between the metal crystal, and a 1cm long electrostatic deflector, the reactions (1) and (2) start at 2cm with a (P_s) beam diameter of $500\mu\text{m}$. The beam diameters at several distances from the crystal metal P_s source are given in table (V)

TABLE V: P_s beam diameter as a function of the distance from the crystal.

x (cm)	1	2	3	4	5	6
ϕ (μm)	300	500	700	900	1000	1200

Once the (P_s) has hit the (p^-) beam and produced a (p^- , \bar{H}) beam, it is slow down to ~ 0.06 eV by the 2 Slow Down Stations and by fine tuning the initial (e^+) beam. Since

the speed of (P_s) at 0.06 eV is $\sim 1.02 \cdot 10^4 \text{ m.s}^{-1}$ and the speed of a (p^- , \bar{H}) with 20 eV kinetic energy is $6.2 \cdot 10^4 \text{ m.s}^{-1}$, (\bar{H}) moves $\sim 6 \times$ faster than (P_s). So if the (\bar{H}) beam is 2 cm long, and the (P_s) beam is 1 cm long, it will take (\bar{H}) the time to fly $(2+1)/6 = 0.5$ cm in order to overtake the excited (P_s) target. The full crossing, then, takes ~ 80 ns. The lifetime of (P_s) $n=3$ is ~ 11 ns, and is not sufficient. Hence the region of laser excitation ($3^3P - 2^3S - 3^3P$) shall extend over the 3 cm in order to keep the fraction of excited atoms constant.

After (P_s) has been slow down to ~ 0.06 eV, any SDS transition makes (P_s) faster than (\bar{H}), hence two counter propagating SDS-lasers have to be used to create a bouncing which keeps the (P_s) in the same region as (\bar{H}). The use of 2 counter propagating SDS-lasers allows the recycling the (P_s) atoms, but to keep the estimation conservative, the number of ions produced will be computed without the recycling.

Some (\bar{H}) will not capture an (e^+), and will continue the flight as well as the (P_s) atoms which are not slowdown to 0.06 eV. The non excited (P_s) atoms will decay spontaneously in 142 ns. With a speed of $\sim 2 \cdot 10^6 \text{ m.s}^{-1}$ they decay in ~ 30 cm. Hence several SDS can be set within these 30 cm. After 30 cm, the only particles left in the beam are (p^- , \bar{H} , \bar{H}^+). In what follows, these extra interaction regions are not taken into account, so the estimation of the number of (\bar{H}^+) produced is conservative.

A feature beyond the scope of this article, but which shall be considered to improve the (P_s) beam density, is that the (P_s) $n=3$ has an electrical moment dipole which is $\sim 10^3$, 10^4 smaller than the one of guided atoms in a Rydberg state. But (P_s) mass is $\sim 10^3$ times smaller, and the focussing-defocussing power here is meant to correct small divergencies of few mrd. Guiding has been considered for positronium in Rydberg states[38], which is not yet packaged as a beam. With a diffracted positronium beam, the focussing power is much less demanding.

D. (\bar{H}^+) in numbers with CUSP and GBAR using a (P_s) beam.

CUSP was designed to measure the $n=1$ hyperfine transition of (\bar{H}), and it uses a radioactive (e^+) source much less intense than the linac source used by GBAR. Nevertheless, the CUSP source would be just sufficient to perform a free fall experiment, and CUSP parameters give the threshold limit at which this method can be used. This section will compare the number of (\bar{H}^+) that can be produced by both experiments. The layout modification for CUSP would be to replace the (\bar{H}) apparatus by the one proposed here and to keep the hyperfine transition measurement apparatus.

CUSP can store $2 \cdot 10^7$ (e^+) in its trap, and 10^7 (p^-) about 3 times per hours.

We will assume that the (p^-) beam is 2 cm long and has a diameter of ~ 0.85 mm.

With these numbers and using a conservative Al crystal

without stimulated SPP emission at order $n=1$ or $n=2$, 66% of the (e^+) delivered in a 2 cm long beam at 16.8 eV will produce the (P_s) beam at 10 eV. Hence the 10 eV (P_s) beam will carry $1.32 \cdot 10^7$ atoms. The volume is given by the average diameter of the (P_s) beam between $L = 3$ cm and $L = 5$ cm. Its inverse, $1/\text{volume}$, is 176 which gives the beam density for reaction (1).

$$\rho = 176 \times 1.32 \cdot 10^7 = 2.32 \cdot 10^9 \text{ cm}^{-3} \quad (8)$$

The (P_s), produced in the ground state, being much faster than the (p^-) beam, the later will be considered at rest for reaction (1). Around 10 eV, a (P_s) beam on (p^-) at rest has a cross section of $\sim 15 \cdot 10^{-16} \text{ cm}^2$, and the number of (\bar{H}) produced at each shot is then :

$$2.32 \cdot 10^9 \times 10^7 \times 15 \cdot 10^{-16} \times 2 = 69.6 \quad (\bar{H}) \quad (9)$$

Following the AEGIS method[37], with a single photon excitation at $n=3$, the fraction of (P_s) $n=3$ will be $\sim 15\%$. This fraction could be increased with more laser power[39]. The states $n=2$ and $n=1$ also produce (\bar{H}^+), but they will not be taken into account in order to keep the estimation conservative. The number of (P_s) in the beam in the state $n=3$ is then $2 \cdot 10^6$.

The SDS will start at the end of the electrostatic deflector, so that the (P_s) beam is ready at $L = 3$ cm. The volume is then given by the average diameter of the (P_s) beam between $L = 3$ cm and $L = 5$ cm, and then, its inverse, $1/\text{volume}$, is 176 which gives the beam density for excited (P_s) at $n=3$:

$$\rho = 3.52 \cdot 10^8 \text{ cm}^{-3} \quad (10)$$

The reaction (2) cross section with (P_s) in the 3^3P state is $\sim 1000 \cdot 10^{-16} \text{ cm}^2$. Then, assuming that only $1/2$ of (\bar{H}) are produced in the first of the 2 cm, and that only 1 cm is available for reaction 2, the number of (\bar{H}^+) per shot produced via the 3^3P state is :

$$3.52 \cdot 10^8 \times 69.6/2 \times 1000 \cdot 10^{-16} \times 1 = 0.0012 \quad (11)$$

Once CUSP is connected to ELENA in 2019 and gets 10 times more (p^-), it could produce 0.012 (\bar{H}^+) per shot.

As an hyperfine measurement experiment, even without ELENA, CUSP could produce 69.6 (\bar{H}) in a timely way, within a ~ 100 ns window. This would be too much in 1 shot, but then CUSP could run at a faster rate with less (e^+) per shot. At the moment, the experiment has no timing since the (\bar{H}) escape randomly from the apparatus where they are produced. Operating in a small time window would reduce the background noise.

GBAR will be connected to ELENA from its start in 2017, and has a linac source which delivers $\sim 10^{10}$ cooled down (e^+) in its trap, that is 500 times more than CUSP. With these numbers, and assuming 10^8 (p^-) per shot, GBAR would produce 5000 more (\bar{H}) and (\bar{H}^+) per shot :

- 348000 (\bar{H}) per shot,
- 6 (\bar{H}^+) per shot.

IV. Gravitational interferometry

An interferometry with (P_s) was suggested in 2002 [40], using the light wave Bragg diffraction for Raman splitters and mirrors, which made the exit beam intensity very weak. In 2002, the experiment was hardly feasible. Today, with more powerful lasers and (e^+) sources, it might be within reach.

The solution proposed here is simpler : since the (P_s) are produced by the diffraction of an incident (e^+) beam, the source is coherent and the emitted modes can be used as such to create a Mach-Zehnder atom interferometer. The two beams recombination is performed by a specular reflection on a LiF crystal for each beam. Measurements have shown that between 7 eV and 60 eV specular reflexion of (P_s) atoms has an efficiency that decrease from 30% to 3% [41]. These values are sufficient to operate an interferometer at a kinetic energy of 10 eV.

At that energy the (P_s) de Broglie wavelength is 2.74 Å. Historically, classical crystal diffraction is the path used for neutrons and electrons interferometry : no light wave Bragg diffraction was used. Unlike matter atoms which masses are too large and which wave lengths are too small, the (P_s) wave length is also suitable for a solid state interferometer.

This interferometer is similar to the one used in the Colella Overhauser Werner experiment (COW). The differences are :

- the neutrons are replaced by (P_s) atoms in the ground state,
- the beam splitters are replaced by passive diffraction gratings or partially reflecting Au or LiF mirror.

Progress in nano technology opens new possibilities for splitting and recombining a (P_s) beam : gold nano mesh, nano grating and LiF mirrors dispersed on a graphene sheet.

The developpement of nano grid for Transmission Electron Microscopy (TEM), makes available gold grid, packaged within 3-mm diameter disc of gold mesh where a layer of gold foil with a regular array of micrometer-sized holes is suspended across the square openings in the mesh [42]. These micro mesh, 500 nm thick, can be used as semi-transparent mirror for the (P_s) beam.

Nano technology allows for the fabrication of graphene gratings with slit widths and separation in the ~ 50 nm range suitable for diffracting (P_s) atoms with a wave length of ~ 2 Å. An alternative is nanoporous alumina, which is commercially available with pores diameter of 20 nm and a thickness from 200 nm to 200 μ m. Assuming that grating in the 5 nm range can be produced, and absorbing all the diffracted modes but 2, one could reach an angular separation of ~ 0.1 rd and use the grating for beam splitting and recombination.

Conversely, larger angular separation could be obtained with LiF semi-transparent mirrors. The developpement of Li-ion batteries has triggered a rich field of research in the methods for producing larges, stables, carbon electrodes, modified with surface deposition of LiF nano particles. Recently[43], it has been demonstrated that LiF nanos particles with a diameter of 5-15 nm can be dispersed and attached to a graphene sheet. The nano particle have a good crystallinity with (002) plane on graphene. Being oriented they can act as dispersed mirrors for a (P_s) beam. Using a graphene monolayer on a TEM grid, like for instance the Quantifoil Gold produced by Sigma-Aldrich, a semi-transparent (P_s) mirror could be obtained. Assuming 0.25 reflection for 10 eV (P_s) atoms, and a LiF/graphene surface ration of 0.2, the 2 reflections in the interferometer path before the recombination would give 0.0025 efficiency. Assuming 0.05 transparency with losses due to the interactions with the graphene and with the grid, crossing twice the mirror would give 0.0025 efficiency. One should add the losses in the last semi-transparent mirror used for the recombination, and then, the overall the proportion of (P_s) atoms exiting the Mach-Zehnder interferometer would be $\sim 10^{-3}, 10^{-4}$.

The layout of such interferometer is drawn in figure 5. In this layout, the mirrors on each separated arm use specular reflection on a LiF crystal with 0.25 reflection coefficient.

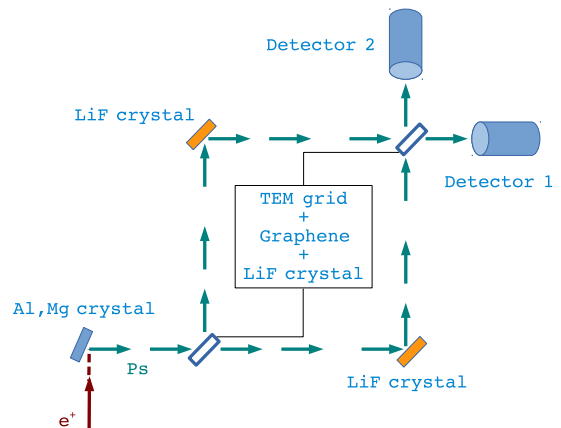

FIG. 5: Mach-Zehnder atom interferometer with a P_s coherent beam.

To define the parameters, we rewrite the COW interference formula. The COW experiment phase shift between the two arm of the interferometer is computed with classical mechanics since the atoms'speed is $\sim 10^6 m.s^{-1}$. The interferometer will be rotated around the horizontal axe. The atoms are launched horizontally and their wave is splitted in two. The atoms on the horizontal axe have a kinetic energy E_0 , a wave vector k_0 , and the gravitation potential origin is set at this level. Once at the upper level z of the interferometer, the wave vector is k . The phase shift when the atoms go from the level 0 to z is the same for the two paths. Hence the phase difference at the recombination point is given by $\Delta\Phi = L.\Delta k$ with

L being the horizontal path length.

$$\begin{aligned} \frac{\hbar^2.k^2}{2.m} &= E_0 - m.g.z \Rightarrow k^2 = \frac{2.m.E_0}{\hbar^2} \cdot (2\pi)^2 \cdot \left(1 - \frac{m.g.z}{E_0}\right) \\ k_0^2 &= \frac{2.m.E_0}{\hbar^2} (2\pi)^2 \Rightarrow k^2 = k_0^2 \cdot \left(1 - \frac{m.g.z}{E_0}\right) \\ m.g.z &\gg E_0 \Rightarrow k \sim k_0 \cdot \left(1 - \frac{m.g.z}{2.E_0}\right) \\ \Rightarrow k - k_0 &= -\frac{m.g.z.k_0}{2.E_0} \end{aligned} \quad (12)$$

The rotation angle around the horizontal axis being α , as the interferometer is rotated, the COW phase shift becomes :

$$\begin{aligned} \Delta\Phi &= -\frac{m.g.z.L.\sin\alpha.k_0}{2.E_0} = -\frac{m.g.z.L.\sin\alpha.k_0}{2.(\hbar^2.k_0^2/2.m)} \Rightarrow \\ \Delta\Phi &= \frac{-2\pi.g.\lambda.m^2.z.L.\sin\alpha}{\hbar^2} \end{aligned} \quad (13)$$

The (P_s) lifetime is 142 ns, so its half lifetime is 98 ns. The corresponding distance, before 1/2 of the (P_s) are lost, is $L_{1/2}$. The product $z.L$ is the surface of the interferometer. It is set to $S = (L_{1/2}/2)^2$. With these settings, the phase shift can be written $\Delta\Phi = a.\sin\alpha$, and for kinetic energies from 10 eV to 100 eV, the values of (a) are given in table (VI) :

TABLE VI

K_{P_s} (eV)	λ (Å)	v ($10^6 m.s^{-1}$)	$a(rd)$	$L_{1/2}$ (cm)
10	2.742	1.362	$5.737 \cdot 10^{-4}$	13.4
30	1.583	2.297	$9.420 \cdot 10^{-4}$	22.6
50	1.226	2.965	$1.218 \cdot 10^{-3}$	29.2
100	0.867	4.193	$1.721 \cdot 10^{-3}$	41.3

With these very small numbers, the measurement of the gravitational phase shift requires a very large number of (P_s) atoms : one needs a high statistics to sample the small phase shift.

Unlike atoms interferometers with light standing wave diffraction, the (P_s) is and remain in the same internal state during its path through the interferometer. The only constraint is that its life time is large enough to let it reach the 2 beams re-combination region. In the following we will consider orthopositronium in the ground state with a life time of 142 ns. There will be no electro-magnetic field involved and hence no splitting of the hyperfine states.

Aside for surface defects or contamination, the main effect to consider, as limiting the coherence of the diffracted (P_s) beam and the gravitational phase shift measurement, are the lattice elastic vibrations. At room temperature, the amplitude of lattice elastic vibrations is $\sim 0.1 \text{ \AA}$, hence $\sim 5\%$ of the lattice size. This effect will therefore not prevent the interference of de Broglie waves at wave lengths of $\sim 2 \text{ \AA}$. Conversely, if we assume that the supporting structure is a single crystal like

in the COW experiment, then the elastic vibrations along this support, while the (P_s) atoms follow their path, produces a phase shift blur larger than the phase shift due to gravity.

The acoustic phonon speed in Al and Mg is $\sim 5000 m.s^{-1}$ to be compared to the $1.36210^6 m.s^{-1}$ of the (P_s) beam at 10 eV. Hence the amplitude of the lattice displacement at the exit of the interferometer during the (P_s) flight will be :

$$(5000/1.362 \cdot 10^6) \times 0.1 \text{ \AA} \sim 3.6 \cdot 10^{-4} \text{ \AA} \quad (14)$$

The contribution of these vibrations to the measured phase shift at the interferometer exit is :

$$\begin{aligned} \lambda &= 2.742 \text{ \AA} \\ (3.6 \cdot 10^{-4}/2.742) \times 2\pi &= 8.2 \cdot 10^{-4} rd > \Delta\Phi \end{aligned} \quad (15)$$

Hence the thermal vibrations can blur the gravitational phase shift. By reducing the temperature of the crystal to few kelvins this background can be reduced by a factor ~ 10 .

If it were not for the decrease in specular reflexion when the kinetic energy grows, it would seem more advantageous to use atoms with a kinetic energy of 100 eV to increase $L_{1/2}$. The authors who measured the specular reflexion noted that their value is probably lowered by the surface contamination of their sample, and that a reflexion coefficient nearer to 1 is to be expected. If that turn out to be experimentally proven, then the kinetic energy could be increases. But that would not help because the wave length would decrease to 0.867 \AA making the phase shift even more difficult to measure within the lattice vibrations background.

Even at room temperature and with a (P_s) beam kinetic energy of 10 eV, it possible to measure the phase shift by increasing the path length. If the path length is increased, for instance $L = 20 \times L_{1/2}$, the maximal phase shift becomes $a = 114.74 \cdot 10^{-4} rd$ at a cost of dividing the number of (P_s) atoms in the detectors by a factor 2048. With this loss factor, the maximal phase shift is 14 times larger than the lattice elastic vibrations effect, and hence becomes visible.

Let's assume that the goal is to measure a difference between the two outputs of the interferometer of ~ 1000 atoms. Then to measure a maximal phase shift $\Delta\Phi = a \sim 0.01 rd$ one needs $\sim 2 \cdot 10^5$ atoms if no atom is lost and if the detector has no jitter in the atom counting. But the (P_s) decay in flight gives a loss factor 2000 for $a = 114.74 \cdot 10^{-4} rd$. Then to measure steps of 1/10 of the maximal phase shift, one needs $10 \times 2000 \times 2 \cdot 10^5 = 4 \cdot 10^9$ atoms. In real life there are several sources of noise in the counting. So we shall assume an overall efficiency of 10%. The specular reflexion of the beam splitters adds a loss factor $\sim 10^{-3}, 10^{-4}$. So the source shall provide $10^{13} \sim 10^{14}$ atoms per measurement. And 100 \sim 1000 measurements are performed at each step between $\alpha = 0$ to $\alpha = \pi$.

A classical linac source, with a tungsten target of ~ 1 mm, water cooled, orthogonal to the electron beam, and followed

by a tungsten moderator has a maximal output of $\sim 10^8$ (e^+) per second. So with a classical linac source, one can perform 1 measurement per day. A thin tungsten target at grazing incidence with a magnetic bulb, and no need for target cooling, shall produce $\sim 10^{11}$ (e^+) per second [44]. For detecting the phase shift with a crude measurement, the classical linac source is enough, but to reach a precision similar to the one of neutrons interferometry, like the COW experiment, the thin tungsten target source is required. The classical source experiment can be improved if it is performed at a lower temperature. All the parameters have been taken with a conservative approach.

An alternative approach is to increase the phase shift by adding locally, near one arm of the interferometer, a large mass. The experiment was performed with 84 kg of lead and with a matter interferometer[45]. The use non decaying matter atoms allows for 8 m altitude flight which is not practical with (P_s) atoms, but one could use a much larger mass to increase the phase shift in the (P_s) interferometer.

The loss of coherence due to the lattice vibrations could be used as a modulator and frequency filter for the (P_s) beams : Surface Acoustic Wave (SAW) devices are common in electronics and provides all the required toolbox. A specific use of the SAW could be the bunching of diffracted (P_s) beam to be packaged in short bunches.

Aside from practical effects like the thermal vibrations, one may object that the decay in flight, within each arm of the COW interferometer, provides information about the path of the atoms, and hence erases the interference pattern. A similar objection was raised and answered, by by Rasel et all [46], in the case of the standing light wave interferometer. But the coherence is not lost : recording the decays in flight will not provide information about the non decayed atoms path.

The signal collected is the number of (P_s) atoms after the beam recombination. As with any Mach-Zehnder interferometer, there are two detection directions of interest : one looking at each incoming beam line of flight. When the interference is constructive in one, it shall be destructive in the other. But the use of a TEM grid to support the semi-transparent (P_s) mirrors creates a shadow, and the transmission and reflection coefficients are no the same when the device is entered from one side or the other. Hence the anticorrelation between the 2 detectors shall be observed, but the absolute number of atoms, expected on each detector, shall take into account this effect.

A. The (P_s) counters

A detector will be flooded by photons due to the continuous decay in flight of (P_s) atoms in the beams. Furthermore to measure an excess of 1000 decays out of $\sim 2 \cdot 10^5$ requires an accuracy better than 0.5%. With each decay producing 1 MeV, it means to distinguish 1 GeV out of 200 GeV. A classical method based on calorimetry is unpractical. But one can use an unconventional path by counting the decays instead of measuring the energy deposited. Lets force the decay channel

into back to back 511 keV photons, by flipping the (P_s) to its singlet state with a 2 Tesla field. Then instead of recording the photons with a calorimeter, one can use the albedo of the electromagnetic shower, figure (6). The albedo is the least fluctuating energy deposited in an electromagnetic shower : it is constant at $\sim 5\%$ for any photon energy. So each photon will emit ~ 25 keV in the albedo. Assuming the internal 2 Tesla magnet is 10 cm diameter and 20 cm long, one can place a 12 faces albedo detector. Each detector is made of a 1 cm thick tungsten plate and a silicon pixel detector facing the tungsten, as illustrated in figure (7). The photon crosses first the silicon detector and then the tungsten. Either it starts its shower in the silicon, or else the shower albedo will hit the silicon. The albedo is emitted backward from the photon line of flight, hence the position can be very precise, $\sim 50\mu m$. By counting the hits and dividing by 2, one gets the number of (P_s) atoms. Since the number of atoms is $\sim 2 \cdot 10^5$, and each gives 2 photons, with a 20 megapixel silicon detector the occupancy will be $2 \times 2 \cdot 10^5 / 20 \cdot 10^6 = 5\%$.

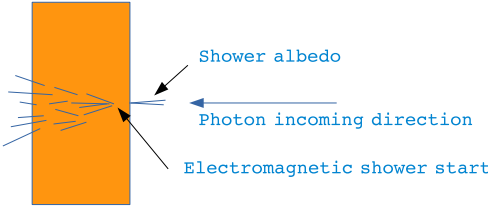

FIG. 6: Electromagnetic shower albedo counter

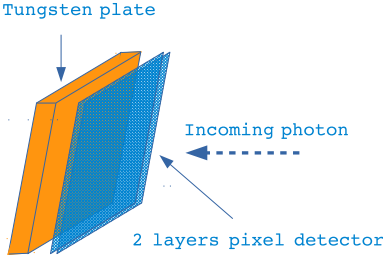

FIG. 7: Electromagnetic shower albedo counter

With a pixel detector efficiency of 99%, and a detector made of 2 pixel layers, the detection loss is 10^{-4} , so the counting precision is much better than the 0.5% required. The use of 2 pixel layers allows the correction of geometrical effects when a photon hit the layer at the junction between 2 pixels. The 2 layers are positioned with an offset of 1/2 a pixel to correct that effect. The magnetic beam orientation does not play any role, but to avoid detection losses by the decay at the exit of the magnetic field, the pixel detectors shall extend far-

ther than the leaking field. Finally, with a cylindrical detector aligned with the (P_s) line of flight, the decays along this line will not be detected. Hence an endcap double layer pixel detector shall be installed to close the acceptance. Since the 2 photons are emitted back to back, in the endcap, each photon detected contribute to 1 unit in the counting, while in the barrel it contributes to 1/2.

V. Gravity and atoms interferometry : a controversy

This experiment will hopefully be done, but the interpretation of the results are still subject to two opposing views.

In the Quantum Mechanical frame, the phase shift accumulated within these 2 paths, starting at the same altitude, but travelling at different altitudes, is due to the loss of kinetic energy for the path going upward, loss which translates into a difference in momentum, hence in wave length. The loss is equal to the difference in gravitational potential energy. By measuring the phase shift and comparing it with the computed one due to gravity, one put to test the weak equivalence principle : the Universal Free Fall.

In the frame of General Relativity, the path farther from earth feels a weaker gravitational acceleration which produces a gravitational redshift of its wave length and a phase shift with the other path. In that perspective, one put to test the gravitational redshift.

These opposing views were discussed at the “Rencontres de Moriond 2011” session Weak Equivalent Principle, thursday 24 mars 2011, morning session [47][48][49][50][51][52][53] for atomic COW experiments using Raman splitters and mirrors on standing light waves. After the presentation of the opposite views, a debate took place on the meaning of *time* within each point of view. The audience agreed that the bottom line was to define “what is a clock ?” [54]. At Moriond no solution was found, and after a long debate .. it was decided to close the session and go skying.

One of the controversial clock argument was the role played by the laser-atom interaction and the effect of the internal states changes during the beam splitting, and at the reflection on standing light waves. This point was addressed in 2014, and it was shown that while the laser-atom interaction was not affected by the gravitational redshift, the propagation of the photons absorbed-emitted by these interactions was indeed affected by a gravitational redshift[55].

The controversy about the laser-atom interaction can be restated as follows. The atom gravitational interferometers, with Raman splitters and mirrors, mixes the continuous energy spectrum of gravitation with the discontinuous internal atomic spectrum. In other words, it mixes the electromagnetic interaction wave length of the discrete states, with the matter wave length related to the atom mass and kinetic energy. By using (P_s) atoms in the ground state in a region void of electromagnetic fields (or at least where the fields are neglectable, unlike with lasers), the experiment is a pure matter wave interferometer.

Then leaving aside the laser-atom interaction, the question still remain : does the (P_s) interferometer is a gravitometer and a test of Universal Free Fall (UFF) only, or does it includes the gravitational redshift ?

A first problem has to do with the proper definition of the oscillator which is being measured. In the COW experiment, the interference measures the different kinetic energy at different altitudes via the wave length defined from the momentum : the de Broglie wave length. So in equation (13) $\lambda = \lambda_{dB}$. But the ratio (h/m) is also in the same equation, that is the Compton wave length : $h/m = \lambda_C$. The redshift is not related to the path between two altitudes, but to the measurement of an oscillator created at one altitude, and measured at an other one where the gravitational field is different : it is the clock measuring the oscillator which ticks at a different rate than the one located where the oscillator was created. The proper wave length is seen red shifted or blue shifted because the clock rate is different. But which wave length is it ? As long as the redshift was measured with photons there was no ambiguity : there is only one wave length that characterizes the photon. General Relativity deals with oscillators and measuring clocks, not with the wave associated with massive particles. Conversely the wave associated with massive particles is purely quantum mechanical, and since a Quantum Field Theory of Gravity (QFTG) has not been written yet, the redshift of a quantum oscillator with mass is not well defined.

A second problem is related to the role of the horizontal path. If one takes the point of view of the redshift interpretation then it is the ruler, that is the clock rate, which changes during the vertical path. But the change is the same for both arms in the interferometer. Then only during the horizontal path, the different clock rates accumulate a phase shift.

Let's restate the problem. An oscillator generating a signal at a given altitude has a proper frequency. When moving to an other altitude through a gravitational field gradient, the clocks that are used to measure this frequency are ticking at a slower rate if the field increases, or at a faster one if the field decreases. Hence the oscillator frequency is seen as being blue shifted or red shifted. The difficulty with the atom interferometer experiment is that the oscillating field which is propagated horizontally at two altitudes is generated at the same altitude, hence the redshift and the free fall phenomena are entangled.

In the Pound and Rebka Harvard Tower Experiment, PRHTE [56], performed in 1959, the (γ) source was at one altitude, and the absorbing atom was at an other altitude. There was no ambiguity : the oscillator setting the proper frequency was the emitting atom at one altitude, while the measuring clock was the absorbing atom at an other altitude. Conversely in the COW atom interferometer each beam is the clock for the other one, and both beams are the oscillator which is being redshifted : there is a confusion on which one plays which role.

Putting aside the redshift controversy, and coming back to the original COW experiment, as a quantum system, (P_s) in the ground state is a pure leptonic system electrically neutral,

with no laser-atom interaction, and void of any complication in the analysis related to the strong interaction : only the electroweak sector may play a role. As a 2 body system, (P_s) internal dynamic is fully computable. Hence, with a (P_s) interferometer, a number of questions raised by the use of atoms interacting with lasers, or with any other source of non gravitational fields, are removed. The experiment involves only gravity, the de Broglie and Compton wave lengths.

If the interaction between matter and anti-matter is repulsive, and equal in intensity with the one on matter-matter attraction, then the 2 beams will feel no gravitational force : the forces on (e^+) and (e^-) will cancel.

The GBAR experiment, where wave interference does not play any role, shall agree with the gravitational interferometer. If there is a difference between the gravitational interaction of a matter-matter system versus a matter-anti-matter system, then the experiment shall see a departure from the computed phase shift, and hence from the number of atoms detected in each detector.

But even that is a source of controversy. The fact that one could contemplate the possibility of anti-gravitation triggered objections [57] : the controversy about possible anti-gravitation extends to the theoretical community, and while the above author presents arguments against it, others sup-

port it. Answers to the objections to antigravity based on the $K^0\bar{K}^0$ oscillations, as well as cosmological arguments, and the introduction of the Dirac-Milne universe have been proposed as a theoretical frame for anti-gravitation [58][59][60][61][62][63][64].

Antigravity may not exist, and the experiments involved in this search may be futile. But before rejecting them, may be one would contemplate the possibility to find an explanation for the galaxy rotation curve with attractive gravity alone, in the frame of General Relativity. As long as the galaxy rotation curve contradicts General Relativity, it is legitimate to question its validity at the edge of existing knowledge, like anti-matter free fall and redshift.

VI. Acknowledgments

I wish to thanks Professor Yasunori Yamazaki, from the CUSP collaboration at CERN, and from RIKEN in Japan, with whom I had the pleasure to discuss the paths toward gravity experiments and the CUSP parameters. It is also with the help of Professor Yasunori Yamazaki that I was able to make the first steps in this field 10 years ago, when he supported the proposal to follow the beam on target path to produce (\bar{H}^+), that Patrice Pérez and I proposed, and which has become today the GBAR experiment.

-
- [1] G. Lüders, Ann. Phys. **2**, 1 (1957).
 - [2] J. Bernabéu, "Discrete symmetries CP, T, CPT," Arxiv.org/pdf/1602.06206.pdf.
 - [3] Yasunori Yamazaki , Stefan Ulmer, Annalen der Physik **525**, 493 (2013), doi:10.1002/andp.201300060.
 - [4] R. Colella, A.W. Overhauser, S.A. Werner, Physical Review Letters **33**, 1237 (1974).
 - [5] R. Colella, A.W. Overhauser, S.A. Werner, Physical Review Letters **34**, 1472 (1975).
 - [6] G. Gabrielse et al. , ATRAP Collaboration, Physics Letters B **548**, 140 (2002).
 - [7] D. Comeau et al. , ATRAP Collaboration, New Journal of Physics **14** (2012), doi:10.1088/1367-2630/14/4/045006.
 - [8] M. Amoretti et al. , ATHENA Collaboration, NIM A **518**, 679 (2004).
 - [9] M. Amoretti et al. , ATHENA Collaboration, NIM A **518**, 244 (2004).
 - [10] H. Yamaguchi et al. , The ASACUSA Collaboration, PHYSICAL REVIEW A **70** (2004).
 - [11] The ALPHA Collaboration, Physics Letters B **695**, 95 (2011).
 - [12] The ALPHA Collaboration, nature communications (2013), doi: 10.1038/ncomms2787.
 - [13] S. Ulmer et al. , The BASE Collaboration, Nature **524**, 196 (2015).
 - [14] N. Kuroda et al. , The ASACUSA Collaboration, nature communications (2013), doi: 10.1038/ncomms4089.
 - [15] The AEGIS Collaboration, Journal of Physics : Conference series **199** (2010), iopscience.iop.org/article/10.1088/1742-6596/199/1/012009.
 - [16] The AEGIS Collaboration, Journal of Physics : Conference series **791** (2017), iopscience.iop.org/article/10.1088/1742-6596/791/1/012014/pdf.
 - [17] P. Perez et al., Hyperfine Interact **233**, 21 (2015), doi:10.1007/s10751-015-1154-8.
 - [18] P. Perez, Y. Sacquin, Classical and Quantum Gravity **29** (2012), doi:10.1088/0264-9381/29/18/184008.
 - [19] Jochen Walz and Theodor W. Hänsch, General Relativity and Gravitation **36** (2004).
 - [20] P. Perez, A. Rosowsky, NIM A **545**, 20 (2005).
 - [21] A. P. Mills , P. M. Platzman, Solid State Communications **35**, 321 (1980).
 - [22] R. H. Howell , I. J. Rosenberg , M. J. Fluss , Physical Review B **34**, 3069 (1986).
 - [23] D. Neilson , R. M. Nieminen , J. Szymany, Physical Review B **38**, 11 131 (1988).
 - [24] Y. N. K. Michishio, , T. Tachibana, R.H.Suzuki, K. Wada, A. Yagishita, T. Hyodo., APPLIED PHYSICS LETTERS **100**, 254102 (2012).
 - [25] N. Zafar, G. Laricchia, M. Charlton, A. Garner, Physical Review Letters **76**, 1595 (1996).
 - [26] G. Laricchia, S. Armitage, A. Kover, D. J. Murtagh, Advances In Atomic, Molecular, and Optical Physics **56** (2008).
 - [27] D. Gidley, R. Mayer, W. E. Frieze, K.G.Lyn, Physical Review Letters **58**, 595 (1987).
 - [28] Y. Fukaya, M Maekawa, I Mochizuki, K Wada, T Hyodo, A Kawasuso, Journal of Physics: Conference Series **443**, 012068 (2013), 16th International Conference on Positron Annihilation (ICPA-16), doi:10.1088/1742-6596/443/1/012068.
 - [29] A. P. Mills, W. S. Crane, Phys. Rev. B **31**, 3988 (1985).

- [30] R. H. Howell , I. J. Rosenberg , M. J. Fluss, P. Mayer, Phys. Rev. B **35** (1987).
- [31] K.G.Lyn, A. P. Mills, R. N. West, S.Berko, K.F.Kanter, L.O.Roellig, Physical Review Letters **54**, 1702 (1985).
- [32] P.Sferlazzo, S.Berko, K.G.Lyn, A. P. Mills, L.O.Roellig, A.J.Viescas, Physical Review Letters **60**, 538 (1988).
- [33] M. S. Tame, C. Lee, J. Lee, D. Ballester, M. Paternostro, A. V. Zayats, and M. S. Kim, Physical Review Letters **101**, 190504 (2008).
- [34] Jing Yang, Shuxiang Zhou, Chuang Hu, Weiwei Zhang, Xiao Xiao, Jiasen Zshang, Laser Photonics Review **8**, 590 (2014), doi : 10.1002/lpor.201300201 , onlinelibrary.wiley.com/doi/10.1002/lpor.201300201/epdf.
- [35] D. Abbott et al. , PEPPO collaboration, Physical Review Letters **116**, 214801 (2016).
- [36] Pauline Comini, *Study of the antihydrogen atom and ion formation in the collisions antiproton positronium*, Ph.D. thesis, Université Pierre et Marie Curie (2014).
- [37] The AEGIS Collaboration, Physical Review A **94** (2016), doi.org/10.1103/PhysRevA.94.012507.
- [38] D. B. Cassidy, S. D. Hogan, International Journal of Modern Physics: Conference Series **30**, 1460259 (2014), doi: 10.1142/S2010194514602592.
- [39] F. Villa, Nuclear Instruments and Methods in Physics Research B **269**, 1527 (2011).
- [40] M. K. Oberthaler, Nuclear Instruments and Methods in Physics Research B **192**, 129 (2002).
- [41] M. H. Weber, S. Tang, S.Berko, B.L Brown, K.F.Kanter, K.G.Lyn, A. P. Mills, L.O.Roellig, A.J.Viescas, Physical Review Letters **61**, 2542 (1988).
- [42] Christopher J. Russo, Lori A. Passmore, Science **346**, 1377 (2014), doi: 10.1126/science.1259530.
- [43] Zhong-Shuai Wu, Lili Xue, Wencai Ren, Feng Li, Lei Wen, Hui-Ming Cheng, Advanced Functional Material **22**, 3290 (2012), www.afm-journal.de, doi: 10.1002/adfm.201200534.
- [44] P. Perez, A. Rosowsky, NIM A **532**, 523 (2004).
- [45] Peter Asenbaum, Chris Overstreet , Tim Kovachy, Daniel D. Brown , Jason M. Hogan , Mark A. Kasevich, Physical Review Letters **118**, 183602 (2017).
- [46] E. M. Rasel, M. K. Oberthaler, H. Batelaan, Jörg Schmiedmayer, A. Zeilinger, Physical Review Letters **75**, 2633 (1995).
- [47] Peter Wolf, “Does an atom interferometer test the gravitational redshift at the Compton frequency?” Rencontres de Moriond and GPhyS colloquium 2011, Gravitational Waves and Experimental Gravity (2011).
- [48] Michael Hohensee, “Matter-Wave Tests of the Einstein Equivalence Principle.” Rencontres de Moriond and GPhyS colloquium 2011, Gravitational Waves and Experimental Gravity (2011).
- [49] Peter Wolf , Luc Blanchet , Christian J. Bordé , Serge Reynaud , Christophe Salomon , Claude Cohen Tannoudji, NATURE **467** (2010).
- [50] H. Müller, A Peters , S Chu, NATURE **467** (2010).
- [51] M. Hohensee , H Müller, A Peters , S Chu, “Gravitational Redshift , Equivalence Principle , and Matter Waves,” (2010), arXiv:1009.2485.
- [52] M. Hohensee , H Müller , A Peters , S Chu, “Equivalence Principle and Gravitational Redshift,” (2011), arXiv:1102.4362.
- [53] Peter Wolf , Luc Blanchet , Christian J. Bordé , Serge Reynaud , Christophe Salomon , Claude Cohen Tannoudji, “Does an atom interferometer test the gravitational redshift at the Compton frequency?” (2010), arXiv:1012.1194.
- [54] J. Muga , R. Sala Mayato , I.L. Egusquiza, *Time in Quantum Mechanics*, Vol. m72 (2002) ISBN 978-3-540-73472-7.
- [55] K. Wilhelm, B. N. Dwivedi, <http://www.arxiv.org/abs/1307.0274v2>.
- [56] R. V. Pound and G. A. Rebka, PHYSICAL REVIEW LETTERS **3**, 439 (1959).
- [57] Savely G Karshenboim, Journal of Physics B: Atomic, Molecular and Optical Physics **49**, 144001 (2016), <http://iopscience.iop.org/article/10.1088/0953-4075/49/14/144001/pdf>.
- [58] M. Villata, EPL , 20001 (2011), doi: 10.1209/0295-5075/94/20001.
- [59] Jose M. Ripalda, arxiv.org/abs/gr-qc/9906012 (2010).
- [60] Michael Martin Nieto., T. Goldman, Physics Reports **205**, 221 (1991).
- [61] G. Cardin, Physics Letters B **282**, 256 (1992).
- [62] A. Benoit-Lévy, G. Cardin, Astronomy&Astrophysics **537** (2012), <https://doi.org/10.1051/0004-6361/201016103>.
- [63] S. A. Trigger , I. A. Gribov, Journal of Physics: Conference Series **653** (2015), <http://iopscience.iop.org/article/10.1088/1742-6596/653/1/012121/pdf>.
- [64] J. Scherk, PHYSICS LETTERS **88B** (1979).