

A combinatorial method for connecting BHV spaces representing different numbers of taxa

October 30, 2021

YINGYING REN⁵, SIHAN ZHA⁶, JINGWEN BI², JOSÉ A. SANCHEZ¹, CARA MONICAL¹, MICHELLE DELCOURT³, ROSEMARY GUZMAN¹, AND RUTH DAVIDSON⁴

¹*Department of Mathematics, University of Illinois Urbana-Champaign, Urbana, Illinois, 61801, U.S.A;*

²*Department of Engineering, Cornell University, New York, New York, 10044, U.S.A.;*

³*School of Mathematics, University of Birmingham, Edgbaston, Birmingham, B15 2TS, U.K.*

⁴*Departments of Mathematics and Plant Biology, University of Illinois Urbana-Champaign, Urbana, Illinois, 61801 U.S.A.*

⁵*Departments of Mathematics and Computer Science, University of Illinois Urbana-Champaign, Urbana, Illinois, 61801 U.S.A.*

⁶*Departments of Mathematics and Economics, University of Illinois Urbana-Champaign, Urbana, Illinois, 61801 U.S.A.*

Corresponding author: Ruth Davidson, Departments of Mathematics and Plant Biology, University of Illinois Urbana-Champaign, Urbana, Illinois, 61801, U.S.A.; E-mail: redavid2@illinois.edu

Abstract

The phylogenetic tree space introduced by Billera, Holmes, and Vogtmann (BHV tree space) is a CAT(0) continuous space that represents trees with edge weights with an intrinsic geodesic distance measure. The geodesic distance measure unique to BHV tree space is well known to be computable in polynomial time, which makes it a potentially powerful tool for optimization problems in phylogenetics and phylogenomics. Specifically, there is significant interest in comparing and combining phylogenetic trees. For example, BHV tree space has been shown to be potentially useful in tree summary and consensus methods, which require combining trees with different number of leaves. Yet an open problem is to transition between BHV tree spaces of different maximal dimension, where each maximal dimension corresponds to the complete set of edge-weighted trees with a fixed number of leaves. We show a combinatorial method to transition between copies of BHV tree spaces in which trees with different numbers of taxa can be studied, derived from its topological structure and geometric properties. This method removes obstacles for embedding problems such as supertree and consensus methods in the BHV treespace framework.

Keywords: Phylogenetic trees, Billera-Holmes-Vogtmann treespace, supertree methods, consensus methods, graph theory, CAT(0) spaces

Originally introduced in 200, the Billera, Holmes, and Vogtmann (BHV) treespace (Billera et al., 2001) has long intrigued the mathematics and statistics communities, but performing computations relevant to the construction of the tree of life in this space that are of contemporary interest to the computational and systematic biology communities remains difficult for many reasons. Yet significant progress has been made towards removing key obstacles to such computations, beginning with the software and polynomial-time algorithm introduced in (Owen and Provan, 2011). This was a significant advance because BHV space is a CAT(0) space with an intrinsic geodesic distance measure, and the biological significance of how far apart two trees are is an essential issue for assessing the accuracy of phylogenies computed from both biological and simulated data.

Traditional statistical analyses-which are key to assessing confidence levels in phylogeny estimation-are difficult to perform in BHV treespace as it is a non-Euclidean space (Benner et al., 2014). Yet there has been progress in the development of methods for performing statistical analyses in BHV treespace (Nye, 2011; Barden et al., 2013; Miller et al., 2015; Weyenberg et al., 2016). Further, continued exploration of the geometric structure (Lin et al., 2015) and the use of such deeper understanding to improve optimization-based tree inference methods (Skwerer et al., 2014) are promising. Much work remains to be done before the mathematical foundations of this space are fully explored to the extent where phylogeny reconstruction, evaluation, and related data analysis can be applied in this space.

The contribution in this manuscript is to provide a combinatorial paradigm for relating copies of BHV treespace that correspond to trees with differing numbers of leaves as well as differing internal structures. In particular, there is a unique copy of BHV treespace in which components of maximal dimension are determined by the number of internal edges of binary trees. This is an equivalent notion to identifying copies of BHV space that correspond to trees with n leaves that are fully resolved; i.e. those not containing polytomies. We present a combinatorial method with a mathematical foundation for moving between copies of BHV space that can be identified with fully resolved phylogenies with n leaves.

In the first Section, “Mathematical Foundations and Definitions”, we give a broad overview of the mathematical foundation and common notation from previous publications, as well as novel definitions required for our results and new notation used in this paper. Our results underlying the combinatorial paradigm developed to transition between copies of BHV space designed to study sets of trees with different numbers of leaves are presented in Section entitled “Results.” In the “Discussion” Section, we address the potential for applications of our combinatorial paradigm in computational biology that were not possible without a method to move between BHV spaces corresponding to trees with different numbers of taxa.

1 Mathematical Foundations and Definitions

1.1 Phylogenetic Trees

A *phylogeny* is a mathematical model of the common evolutionary of a group of taxa. For example, the taxa may be genes, species, or individuals within a conspecific population. We adopt the convention for this manuscript that a phylogeny is a tree graph, and refer to phylogenies as *phylogenetic trees*. In a fully resolved phylogenetic tree the evolutionary history is represented by a tree T with a label set assigned to the *leaves* of degree one (which also represent the taxa under study) and each internal vertex of T has degree of at least 3. The internal vertex set represents the branching points in evolutionary history that result in taxon divergence due to evolutionary events such as point mutation, recombination (Kim et al., 2016), or gene inversion (Francis, 2014). Yet we adopt the perspective that despite these types of events, evolution is fundamentally treelike on a large scale, even when forces such as lateral gene transfer are the likeliest explanation for specia-

tion history, which is supported by publications such as (Abby et al., 2012). Further discussion of such important evolutionary events leading to non-treelike structures is not relevant to our results.

This paper views all phylogenetic trees as non-rooted, and thus the tree structures show relative similarities and differences between species instead of an implied chronological order. From this perspective, the topology (shape) of a phylogenetic tree with three leaves or fewer does not provide any biological information for the species described. Therefore, all definitions and theorems below focus on trees with four leaves or more.

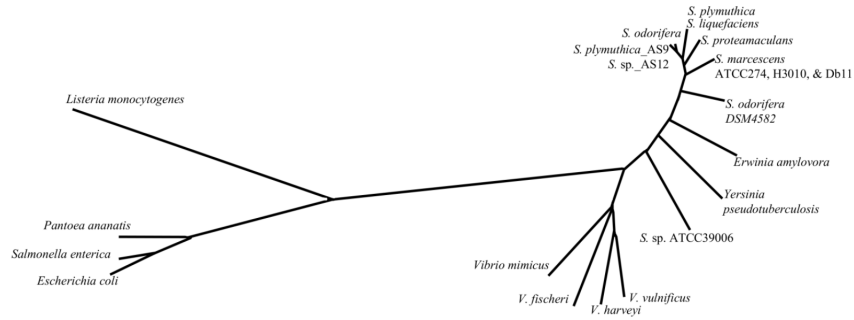

Figure 1: Unrooted phylogenetic tree for the LuxS gene, from the Supplementary Material published in (Joyner et al., 2014)

For clarity, in this manuscript we use the same notation for trees as in (Owen and Provan, 2011). A phylogenetic tree is a tree $T = (X, E, \Sigma)$, where X is the label set assigned to the leaves of the tree, E is the set of interior edges, and Σ is the set of splits of the set X induced by the interior edges. In other words, the split $X_e | \bar{X}_e$ associated with edge $e \in E$ represents the partition of X introduced by removing the edge e from T .

Following (Semple and Steel, 2003), we say two splits associated with edges $\{e, f\} \in E$, $X_e | \bar{X}_e$ and $X_f | \bar{X}_f$, are **compatible** if one of the sets

$$X_e \cap X_f, X_e \cap \bar{X}_f, \bar{X}_e \cap X_f, \bar{X}_e \cap \bar{X}_f$$

is empty. This is equivalent to asserting that one of the following set relationships is valid:

$$X_e \subset X_f, X_f \subset X_e, X_e \subset \bar{X}_f, \bar{X}_f \subset X_e, \bar{X}_e \subset X_f, X_f \subset \bar{X}_e, \bar{X}_e \subset \bar{X}_f, \bar{X}_f \subset \bar{X}_e.$$

Splits induced by a leaf edge are referred to as *trivial*, as they provide no information from the perspective we adopt in this manuscript about the evolutionary relationships in the phylogeny. Figure 1 shows an unrooted phylogenetic tree inferred from biological data that was published in the supplementary materials for (Joyner et al., 2014). One can observe the bipartitions of the taxa that are non-trivial induced by the internal edges of the tree. These correspond to set bipartitions of X where each subset in $X_e | \bar{X}_e$ has cardinality at least two.

1.2 Billera-Holmes-Vogtmann (BHV) Tree Space

BHV tree space is a continuous tree space that embeds trees using their split weights—where weights are the length of the internal edges corresponding to a non-trivial split. This tree space is formed by a set of Euclidean subspaces, called *orthants* (a generalization of the notion of, for example, a quadrant in \mathbb{R}^2). Each orthant of BHV space uniquely represents phylogenetic trees of different split weights but the same underlying topology. Orthants are joined together by lower

dimensional orthants whenever the topologies they represent share common splits. Yet lower-dimensional orthants in a copy of BHV tree space correspond to tree topologies that have an internal vertex of degree higher than 3. Therefore, paths between orthants of maximal dimension in BHV space that cross lower dimensional orthants can be thought of simply as collapsing internal edges for one labeled topology, thereby introducing a polytomy, and expanding the polytomy in a way that corresponds to a different labeled topology.

BHV space uses the *geodesic* introduced in (Billera et al., 2001) as its *intrinsic* metric, which is defined as the shortest path between two points that lies completely inside the space. In (Billera et al., 2001) it was also shown that BHV tree space is CAT(0), or has globally non-positive curvature, and the geodesic is unique. The paper (Owen and Provan, 2011) introduced an algorithm with polynomial time complexity for computing the geodesic distance; this was a major advance towards making BHV space an object for the study of phylogenetic trees.

Definition 1. Denote a BHV tree space in which the maximum-dimensional orthants corresponding to fully resolved binary trees with n taxa as BHV_n . In other words, all internal vertices have degree three, such as in Figure 1.

In BHV_n the maximum-dimensional orthants have dimension k , where $k = n - 3$ is the number of internal edges in a fully resolved binary tree with n taxa. We briefly mention that BHV_n can be embedded in \mathbb{R}^N , where $N = 2^{n-1} - n - 1$ is the number of possible splits on n taxa. This embedding is not useful without requiring the use of an *extrinsic* metric, such as in (Lin and Yoshida, 2016). Extrinsic metrics are useful in contexts beyond the scope of this paper. Here we only mention this to clarify the difference between an embedding of BHV_n in another space for visualization purposes and mathematical foundations for different lines of research regarding BHV_n . Our results only rely on the intrinsic metric of the geodesic distance in BHV_n . In other words, we follow the convention that outside of the CAT(0) surfaces that comprise BHV_n , there is no mathematical information relevant to our results.

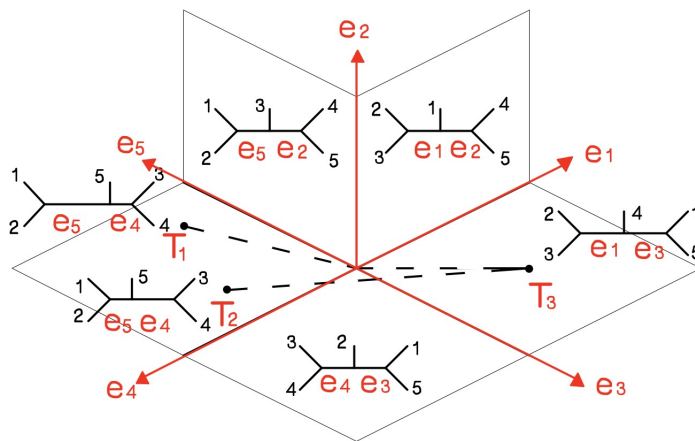

Figure 2: Part of BHV_5 embedded in \mathbb{R}^3 for visualization purposes: There are fifteen two-dimensional orthants in BHV_5 corresponding to the fifteen labeled topologies on a five-leave unrooted phylogeny. Note that the one-dimensional quadrants labeled with edges correspond to the edges that collapse along the path traversed in the space. All edges collapse at the origin into a star phylogeny.

1.3 Fundamental Definitions for our Results

Definition 2. A BHV **Connection Cluster** is defined upon the following collection of objects: (1) *start tree* T_s , an unweighted binary phylogenetic tree, (2) *start dimension* n , the number of leaves in the start tree, and (3) *connection step* ℓ , the number of new leaves added to the start tree.

The BHV Connection Cluster denoted $C_{T_s, n, \ell}$ is the set of unweighted fully resolved trees with $n + \ell$ leaves obtained from adding ℓ leaves to arbitrary edges (including leaf edges) of the start tree T_s starting with n leaves. Thus the new leaf set corresponding to this BHV Connection Cluster is the set containing the n leaves of the start tree T_s and the ℓ new leaves. We note that the connection step ℓ creates a new tree containing both the splits present in the start tree T_s in $BHV_{n+\ell}$ and new splits induced by the new edges added by the connection step. Hence, the maximum-dimensional orthants in $BHV_{n+\ell}$ now have dimension $n + \ell - 3$.

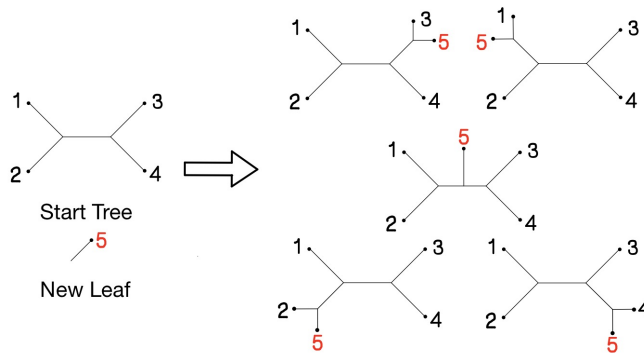

Figure 3: The BHV Connection Cluster $C_{T_s, 4, 1}$ with start tree $T_s \in BHV_4$

Trees in a BHV Connection Cluster, $C_{T_s, n, \ell}$, are unweighted fully resolved $(n + \ell)$ -leaf trees. If we assign arbitrary edge weights to every tree in the cluster, and define a split weights vector for each tree, we will obtain a set of $(n + \ell - 3)$ -dimension orthants in $BHV_{n+\ell}$ which shares the same leaf set as the cluster.

Definition 3. Define this set of $(n + \ell - 3)$ -dimension orthants and the lower dimensional orthants associated with them as a BHV **Connection Space**, or $S_{T_s, n, \ell}$. Each point in this space represents a tree, and the coordinates of the point are the split weights of the tree. We define the **leaf set** of the BHV Connection Space to be the same leaf set as the corresponding Connection Cluster.

Note that the one-dimensional orthants in this space will correspond to splits on the leaf set. We also refer to a one-dimensional orthant as the axis of the space. The distance between two points in the space is the same as the geodesic path for the two points in $BHV_{n+\ell}$. Intuitively, the BHV Connection Space is a group of Euclidean orthants glued together, and each individual orthant contains trees with different edge weights but same topology, as in BHV tree space.

Definition 4. A BHV **connection graph**, or $G_{T_s, n, \ell}$ has vertex set V_C : the set of one-dimensional orthants in $S_{T_s, n, \ell}$. As mentioned earlier, V_C is equivalently the set of splits in all the trees in $C_{T_s, n, \ell}$. The edge set of $G_{T_s, n, \ell}$ is E : $\{v_i v_j\}$: $v_i, v_j \in V_C$ and there exists a tree $T \in C_{T_s, n, \ell}$ such that T contains the two sets of splits represented by $\{v_i$ and $v_j\}$. The leaf set of $G_{T_s, n, \ell}$ is the same as the leaf set of $S_{T_s, n, \ell}$.

2 Results

Theorem 2.1. *The number of trees in a BHV Connection Cluster $C_{T_s, n, \ell}$ is $\frac{(2(n+\ell)-5)!!}{(2n-5)!!}$.*

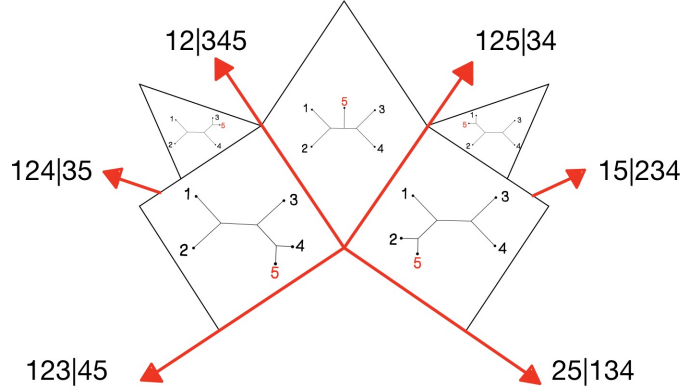

Figure 4: The BHV Connection Space $S_{T_4,4,1}$

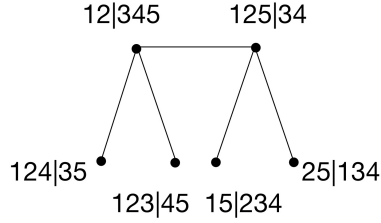

Figure 5: The BHV Connection Graph $G_{T_s,4,1}$, where $T_s \in \text{BHV}_4$

Proof. A fully-resolved m -leaf tree T has $2m - 3$ edges, consisting of m leaf edges and $m - 3$ internal edges; thus there are $2m - 3$ different fully-resolved $(m + 1)$ -leaf trees that can be obtained from adding a single new leaf to the m -leaf start tree. Adding new leaves to distinct original edges are probabilistically independent events. Thus the number of $(n + \ell)$ -leaf trees obtained by adding ℓ new leaves to an n -leaf start tree T_s is

$$\begin{aligned}
 & (2n - 3) \times (2n - 1) \times \dots \times (2(n + \ell - 1) - 3) \\
 = & \frac{1 \times 3 \times \dots \times (2n - 5) \times (2n - 3) \times (2n - 1) \times \dots \times (2(n + \ell - 1) - 3)}{1 \times 3 \times \dots \times (2n - 5)} \\
 = & \frac{(2(n + \ell - 1) - 3)!!}{(2n - 5)!!} = \frac{(2(n + \ell) - 5)!!}{(2n - 5)!!}.
 \end{aligned}$$

□

Theorem 2.2. BHV Connection Space $S_{T_s,n,\ell}$ has dimension $2^\ell(2n - 2) - \ell - n - 1$.

Proof. BHV Connection Space $S_{T_s,n,\ell}$ has dimension equal to the number of unique nontrivial splits from all the trees in the corresponding BHV Connection Cluster, $C_{T_s,n,\ell}$. Because each split has the form $X_e|\bar{X}_e$, a leaf will either belong to X_e or \bar{X}_e . If we assign label 1 or 2 to every leaf, then the set of leaves with label 1, X_1 , and the set of leaves with label 2, X_2 , will form a split $X_1|X_2$ on the leaf set. The new tree in $\text{BHV}_{n+\ell}$ is denoted T_t .

We have $2^{n+\ell}$ different ways of assigning the labels 1 or 2 the new leaf set of size $n + \ell$, but there are certain constraints for a label assignment split to be a tree split. Consider the following three cases:

1. We first consider splits where all leaves from the start tree are in one side of the split. Namely, if V is the leaf set of T_s and L is the new leaf set, then in this first case, we are counting all splits with the form

$$Y_e | \bar{Y}_e, V \subset Y_e, Y_e \cup \bar{Y}_e = L.$$

Without loss of generality, assign label 1 to all leaves from the original start tree. There are 2^ℓ choices to assign a label to the ℓ new leaves in T_t . However, the choice to assign label 1 to all ℓ new leaves in T_t results in all leaves in the tree having the same label, which will not define a split. Moreover, if $\ell - 1$ new leaves get label 1 in T_t , and the remaining one leaf gets label 2, then we have a split defined by the leaf edge, which is a trivial split. Since we have ℓ new leaves, there are ℓ assignments resulting in this situation. So we are left with $2^\ell - 1 - \ell$ different label assignments for T_t .

2. We consider the splits that are derived from the trivial leaf splits of the start tree T_s by adding the new ℓ leaves to T_s to obtain T_t . Again, let V be the leaf set of T_s and L be the new leaf set ($|L| = \ell$) in T_t . We are counting splits of the form

$$(\{x \in X\} \cup Y_e) | (Y_e \cup V \setminus \{v\}), v \in V, Y_e \cup \bar{Y}_e = L.$$

Assign label 1 to one leaf from the start tree and label 2 to all remaining leaves in the start tree. Denote the leaf with label 1 as v_1 . We again have 2^ℓ choices for assigning labels to the ℓ new leaves in T_t . However, if all ℓ new leaves get label 2, we have a trivial leaf edge split between v_1 and the rest of the leaves. So we have $2^\ell - 1$ choices. Since we choose v_1 randomly, we have n different choices for v_1 . Therefore, we have $(2^\ell - 1)n$ different label assignments.

3. In the last case, we consider splits that are derived from a nontrivial leaf split of T_s by adding the new ℓ leaves to obtain T_t . Using the same notation as in the previous case, we are counting splits in the form of

$$(Y_e \cup Z_e) | (\bar{Y}_e \cup \bar{Z}_e), Y_e \cup \bar{Y}_e = L, Z_e \cup \bar{Z}_e = V, |Z_e| \geq 2, |\bar{Z}_e| \geq 2.$$

Recall that T_s is a fully resolved binary tree with n leaves, thus the start tree defines $n - 3$ unique nontrivial splits. For each split, label the leaves from different sides of the split with label 1 and 2 respectively. Then we have 2^ℓ different ways of assigning labels for the ℓ new leaves. So there are $(n - 3)2^\ell$ different label assignments for T_t .

To see these three cases are mutually exclusive to each other, note that we have different label assignments for the leaves in T_s in each case. Specifically, we let the leaves in T_s share in the same label in case (1), assign a different label to a single leaf from the rest of the leaves in case (2), and assign different labels based on a split of T_s in case (3). These three cases also cover all possible assignments for T_s . Therefore, the total number of splits in T_t is

$$2^\ell - 1 - \ell + (2^\ell - 1)n + (n - 3)2^\ell = 2^\ell(2n - 2) - \ell - n - 1.$$

□

Because a three-leaf unweighted tree in BHV_3 does not provide any biological information, the BHV Connection Space with start tree $T_s \in \text{BHV}_3$ and connection step ℓ is the same space as BHV_{l+3} with the same leaf set as the Connection Space. To observe this more carefully, we

can compute the number of orthants and dimension of $S_{T_s,3,\ell}, T_s \in \text{BHV}_3$ using the formulas from Theorems 2.1 and 2.2: the number of maximum-dimensional orthants is

$$\frac{(2(3+\ell)-5)!!}{(2 \cdot 3 - 5)!!} = \frac{(2(3+\ell)-5)!!}{1!!} = (2(\ell+3)-5)!!,$$

and the dimension of these orthants is

$$2^\ell(2 \cdot 3 - 2) - \ell - 3 - 1 = 2^{(\ell+3)-1} - (\ell+3) - 1.$$

We remark that our formulas do not conflict with the dimension calculations of $\text{BHV}_{\ell+3}$ given in (Billera et al., 2001) and (Owen and Provan, 2011).

Lemma 2.3. *For any two vertices in BHV Connection Graph $G_{T_s,n,\ell}$, if they represent two compatible splits, then they are connected in the BHV Connection Graph.*

Proof. For any two vertices, say v_1, v_2 , in the BHV Connection Graph $G_{T_s,n,\ell}$ (we will refer to this graph as G_C for the remainder of this proof) that represent two compatible splits, to prove that they are connected in G_C is equivalent to proving that there exists a tree in the corresponding BHV Connection Cluster that contains both of the splits that v_1 and v_2 represent. Denote the new leaf set in G_C as $V_{new}, |V_{new}| = \ell$. Removing a common leaf from two compatible splits will result in two new compatible splits.

We initialize a list for pairs of splits. v_1 and v_2 are splits on $n + \ell$ leaves. Denote $P_{n+\ell} = (v_1, v_2)$. Let $P_{n+\ell}$ be the beginning of the list. The vertices v_1 and v_2 both contain all leaves in V_{new} . We generate the two compatible splits in $P_{n+\ell-1}$ by removing a leaf in V_{new} from v_1 and v_2 . In fact, we can generate the two compatible splits in P_{n+i} from P_{n+i+1} for all $i \geq 0$ by removing one leaf that is in V_{new} and also in the two splits in P_{n+i+1} from the two splits in P_{n+i+1} . So we will have a list $\{P_{n+\ell}, P_{n+\ell-1}, \dots, P_{n+1}, P_n\}$, where $P_{n+\ell}$ is the beginning of the list and P_n is the end of the list. Notice that the two compatible splits in P_n are splits on the leaf set of T_s , and the splits in P_{n+i+1} will contain one more leaf than the splits in P_{n+i} . That leaf is in V_{new} . To prove that there exists a tree that is formed by adding the ℓ new leaves to the start tree T_s and contains both of the splits in $P_{n+\ell}$, we proceed by induction on P_{n+i} . When $i = 0$, T_s contains both of the splits in P_n .

As in our inductive hypothesis, assume there is a tree T_i that contains both of the splits in P_{n+i} and the extra leaf in the splits in P_{n+i+1} is denoted as r . If the two splits in P_{n+i} are $X_{e_1}|\bar{X}_{e_1}$ and $X_{e_2}|\bar{X}_{e_2}$, then without loss of generality, the two splits in P_{n+i+1} will be $X_{e_1} \cup \{r\}|\bar{X}_{e_1}$ and $X_{e_2} \cup \{r\}|\bar{X}_{e_2}$. By the construction of all elements in the list, we know the two splits in P_{n+i+1} are compatible. So one and only one of

$$(X_{e_1} \cup \{r\}) \cap (X_{e_2} \cup \{r\}), (X_{e_1} \cup \{r\}) \cap (\bar{X}_{e_2}), (\bar{X}_{e_1}) \cap (X_{e_2} \cup \{r\}), (\bar{X}_{e_1}) \cap (\bar{X}_{e_2})$$

has to be an empty set. Since $r \in (X_{e_1} \cup \{r\}) \cap (X_{e_2} \cup \{r\})$, one of

$$(X_{e_1} \cup \{r\}) \cap (\bar{X}_{e_2}) = (X_{e_1}) \cap (\bar{X}_{e_2}), (\bar{X}_{e_1}) \cap (X_{e_2} \cup \{r\}) = (\bar{X}_{e_1}) \cap (X_{e_2}), (\bar{X}_{e_1}) \cap (\bar{X}_{e_2})$$

has to be an empty set. On the other hand, the two splits in P_{n+i} are also compatible.

So one and only one of

$$(X_{e_1}) \cap (X_{e_2}), (X_{e_1}) \cap (\bar{X}_{e_2}), (\bar{X}_{e_1}) \cap (X_{e_2}), (\bar{X}_{e_1}) \cap (\bar{X}_{e_2})$$

is non-empty. Thus $(X_{e_1}) \cap (X_{e_2})$ is not an empty set. Denote one of the common leaves in (X_{e_1}) and (X_{e_2}) as u , where $u \in T_i$. If we choose any internal edge e in T_i connected to the parent of u , we can add a leaf edge to e with the leaf vertex as r , and the new tree (denoted T_{i+1}) that we obtain will contain both splits in P_{n+i+1} . Therefore, there exists a tree in the BHV Connection Cluster that contains both of the splits represented by v_1 and v_2 . \square

Corollary 2.4. *Let G be a BHV Connection Graph. For any $V \subseteq V(G)$, if V represents a set of compatible splits, then V induces a complete subgraph of G , and thus the set of compatible splits form an orthant of dimension $|V|$ in the corresponding BHV Connection Space $S_{T_s, n, \ell}$.*

Proof. We proceed by induction. If $|V| = 1$, then the only vertex in the set is a complete graph in G , and it corresponds to an axis in $S_{T_s, n, \ell}$ by Definition 3. As in our inductive hypothesis, we assume that if $V \subseteq V(G)$ of size n represents a set of compatible splits, then V induces a complete subgraph of G , and the set of compatible splits form an orthant of dimension n in $S_{T_s, n, \ell}$. For any $U \subseteq V(G)$ of size $n + 1$ that represents a set of compatible splits, choose any n vertices from U ; they will induce a complete subgraph of G . The one remaining vertex, v , represents a split that is compatible with splits represented by $U \setminus \{v\}$. By Lemma 2.3, v and any vertex from $U \setminus \{v\}$ is connected to all vertices in the subgraph with vertices in the set $U \setminus \{v\}$. Thus, U induces a complete subgraph in G . By Definition 4, the orthants formed by the splits represented by U exist in $S_{T_s, n, \ell}$. □

Lemma 2.5. *For all $n \geq 3$, the trees along the geodesic between any two trees T_1, T_2 in BHV_n will only contain some split if that split is contained in either of the two trees.*

Proof. By (Billera et al., 2001) Proposition 4.1, the geodesic between T_1 and T_2 traverses a sequence of orthants whose split set is a subset of the union of the split set of T_1 and that of T_2 . □

Theorem 2.6. *The BHV Connection Space $S_{T_s, n, \ell}$ is a convex space. In particular, the geodesic between any two trees T and T' in $S_{T_s, n, \ell}$ lies within $S_{T_s, n, \ell}$.*

Proof. Denote the split sets of T and T' as Σ and Σ' . By Lemma 2.5, for any tree T_g on the geodesic, T_g only contain splits in $\Sigma \cup \Sigma'$. Thus the split set of T_g , Σ_g is a subset of the vertex of BHV Connection Graph $G_{T_s, n, \ell}$. On the other hand, since splits in Σ_g exist in a tree, they are compatible with each other. By Lemma 2.3, the orthants formed by Σ_g exist in $S_{T_s, n, \ell}$ and thus T_g exists in $S_{T_s, n, \ell}$. Since T_g is chosen arbitrarily along the geodesic, the geodesic is contained in $S_{T_s, n, \ell}$ (as shown in (Owen and Provan, 2011) regarding the properties of the geodesic distance in any BHV space). □

2.1 BHV Connection Graphs with Connection Step 1

For the rest of this section, we focus on BHV Connection Graphs with connection step 1. We show that we can build BHV Connection Graphs for trees with complicated shapes from simpler trees.

Definition 5. A *caterpillar* is an unrooted tree that can be represented in the plane by a graph where all the leaves have exactly one edge to a single line.

Equivalently, caterpillars are trees where every vertex of degree at least three has at most two non-leaf neighbors. Figure 7 shows a caterpillar with 8 leaves. Binary caterpillars are caterpillars in which all non-leaf vertices have degree three. Due to the simplicity of this tree shape, we are able to easily construct BHV Connection Graphs with connection step 1 for binary caterpillars.

We also observe that such BHV Connection Graphs for all binary trees can be constructed using binary caterpillar trees. The concatenation method proposed in Theorem 2.8 provides a general idea of the structure of the BHV Connection Graph for trees with more complex topologies and arbitrary numbers of leaves.

Theorem 2.7. *The size of a largest independent set in the BHV Connection Graph with step 1, $G_{T_s, n, 1}$, is n . Furthermore, the set of vertices representing splits introduced by adding the new leaf to a leaf edge is the only independent set of $G_{T_s, n, 1}$ of size n .*

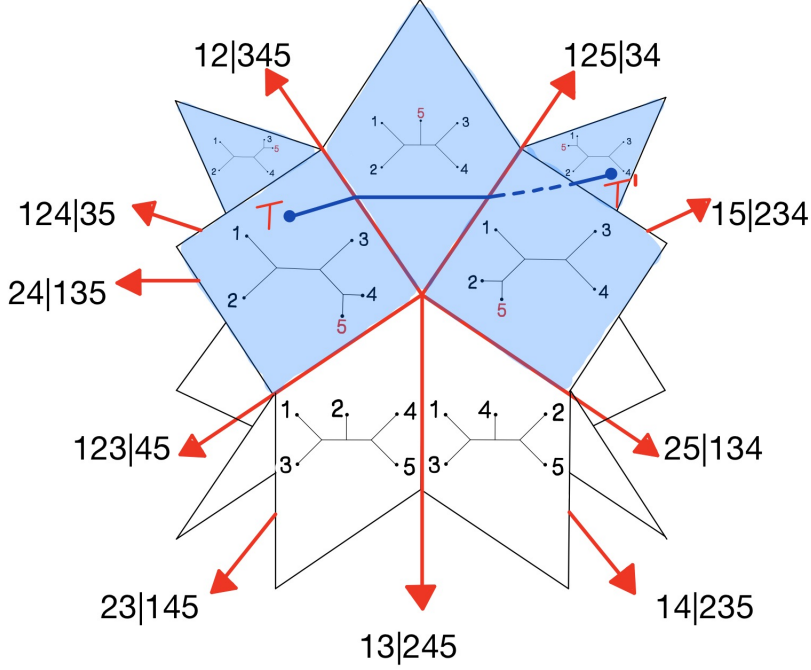

Figure 6: An example of the geodesic path in BHV Connection Space (colored blue). The BHV Connection Space $S_{T_s, 4, 1}$ is shown as part of BHV_5



Figure 7: A caterpillar with 8 leaves.

Proof. When adding a single leaf to a tree, we may either add it to a leaf edge or an internal edge. Suppose the leaf set of T_s is W , and $|W| = n$. Adding a new leaf v to an existing leaf edge in T_s will introduce splits such as $\{u, v\} | \{W \setminus \{u, v\}\}$ where $u \in W$. Adding a new leaf v to an internal edge will introduce splits such as $\{v, A\} | \{W \setminus A\}$ where $A \subset W, |A| > 1, |W \setminus A| > 1$.

By definition, each vertex in a BHV Connection Graph corresponds to a split introduced by adding new leaves. For the remainder of the proof we will refer to the vertex set of $G_{T_s, n, 1}$ as V . We partition V into parts: the vertices which represent splits introduced by adding the new leaf to a leaf edge, denoted V_ℓ , and vertices which represent splits introduced by adding the new leaf to an internal edge, denoted V_i . Here $V_i \cup V_\ell = V, V_i \cap V_\ell = \emptyset$. Moreover, adding a new leaf to an internal edge will introduce two splits so $|V_i| = 2(n - 3) = 2n - 6$ and $|V_\ell| = n$.

Let v be the new leaf added to the start tree. For all $\{u, m\} \subset W$, we know $\{u, v\} | \{W \setminus \{u, v\}\}$ and $\{m, v\} | \{W \setminus \{m, v\}\}$ are not compatible. Therefore, V_ℓ is an independent set of size n in $G_{T_s, n, 1}$. The following proves that this is also the unique largest independent set in $G_{T_s, n, 1}$.

Assume for contradiction that the largest independent set in $G_{T_s, n, 1}$ contains vertices from V_i and has size larger than n . Define the largest independent set in $G_{T_s, n, 1}$ as V_α . $|V_\alpha| \geq n$. Any two vertices in V_α are not connected. By Lemma 2.3, they correspond to a pair of incompatible splits. Since the pair of splits introduced by adding a new leaf to an internal edge are compatible, only one of the splits will have a corresponding vertex inside V_α . Thus, V_α will have at most $n - 3$ vertices from V_i . Denote some independent set in the V_i induced subgraph of $G_{T_s, n, 1}$ as V_β . Note $|V_\beta| \leq n - 3$.

Each vertex in V_β represents a split in the form $v \cup A_i | W \setminus A_i$, where $A_i \in V$, $|A_i| > 1$, and $|W \setminus A_i| > 1$. The splits introduced by adding the new leaf to an existing leaf edge which are compatible with $(\{v\} \cup A_i) | (W \setminus A_i)$ have the form $\{v, u\} | (W \setminus \{v, u\})$, where $u \in A_i$. Thus, the number of splits introduced by adding the new leaf to a leaf edge that are also compatible with $(v \cup A_i) | (W \setminus A_i)$ is $|A_i|$.

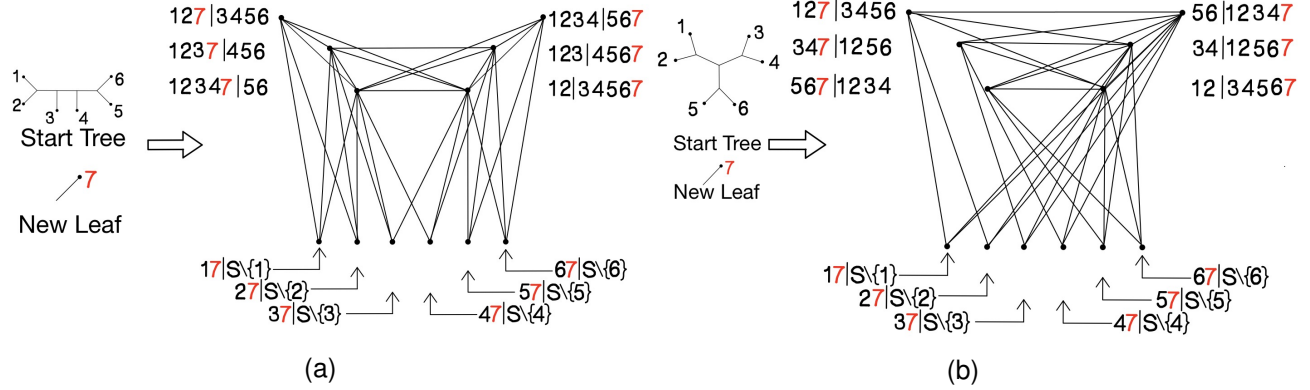

Figure 8: The BHV Connection Graphs $G_{T(a),6,1}$ and $G_{T(b),6,1}$. In Figures (a) and (b), the vertex set of the start tree T_s is $\{1, 2, 3, 4, 5, 6\}$. The bottom six vertices are V_ℓ in this graph, which also form an independent set. The start trees $T(a)$ and $T(b)$ have the same leaf set but different tree topologies. $G_{T(a),6,1}$ and $G_{T(b),6,1}$ are not isomorphic to each other as $G_{T(a),6,1}$ has vertex degree sequence $\{3, 3, 3, 3, 3, 3, 5, 5, 7, 7, 9, 9\}$. $G_{T(b),6,1}$ has vertex degree sequence $\{3, 3, 3, 3, 3, 3, 5, 5, 5, 9, 9, 9\}$.

To calculate the total number of vertices in V_ℓ to which vertices in V_β are adjacent, we only need to calculate the total number of splits introduced by adding the new leaf to a leaf edge that are also compatible with splits represented by vertices in V_β : $|\bigcup_{i=1}^{|V_\beta|} A_i|$. By the Inclusion - Exclusion principle,

$$|\bigcup_{i=1}^{|V_\beta|} A_i| \geq \sum_{i=1}^{|S_\beta|} |A_i| - \sum_{1 \leq i < j \leq |S_\beta|} |A_i \cap A_j|.$$

If $v \cup A_i | W \setminus A_i$ are leaves with trivial splits incompatible with those corresponding to $v \cup A_j | W \setminus A_j$ (which is the case for any two splits in V_β) then as in (Owen and Provan, 2011):

$$(v \cup A_i) \cap (W \setminus A_j) \neq \emptyset,$$

$$(W \setminus A_i) \cap (v \cup A_j) \neq \emptyset,$$

$$(W \setminus A_i) \cap (W \setminus A_j) \neq \emptyset.$$

Since $v \notin W$,

$$(A_i) \cap (W \setminus A_j) \neq \emptyset,$$

$$(W \setminus A_i) \cap (A_j) \neq \emptyset,$$

$$(W \setminus A_i) \cap (W \setminus A_j) \neq \emptyset.$$

But $A_i | (W \setminus A_i)$ and $A_j | (W \setminus A_j)$ correspond to trivial splits in the start tree T_s and are thus compatible with each other. Therefore, $A_i \cap A_j = \emptyset$, $|A_i \cap A_j| = 0$. So we have

$$\left| \bigcup_{i=1}^{|V_\beta|} A_i \right| \geq \sum_{i=1}^{|V_\beta|} |A_i| - \sum_{1 \leq i < j \leq |V_\beta|} 0 > \sum_{i=1}^{|V_\beta|} 1 = |V_\beta|.$$

This demonstrates that if V_α contains d independent vertices from V_i , we need to remove at least $d + 1$ vertices from V_ℓ : $|V_\alpha| < d + n - d - 1 = n - 1$, which contradicts our previous conclusion that $|V_\alpha| \geq n$. Thus, V_α does not contain any vertex from V_i , $V_\alpha = V_\ell$, and $|V_\alpha| = n$. (See Figure 8 for examples.) □

Theorem 2.8. *Let T_s be a start tree with n leaves and at least one internal edge. Splitting one of the internal edges of T_s results in two subtrees: T_a with a leaves and T_b with b leaves where $a + b = n + 2$. Then $G_{T_a, a, 1}$ and $G_{T_b, b, 1}$ are subgraphs of $G_{T_s, n, 1}$. Furthermore,*

$$|E(G_{T_s, n, 1})| = |E(G_{T_a, a, 1})| + |E(G_{T_b, b, 1})| + 5(a - 2)(b - 2),$$

where $E(G)$ represents the edge set of a graph G .

Proof. As shown in Figure 9, we can obtain two subtrees by splitting one of the internal edges of tree T_s . If that edge defines the split $P|Q$, we will have two different representations for T_s . In Figure 9 (b), we use A to represent the subtree with leaf vertices from Q ; in Figure 9 (c), we use B to represent the subtree with leaf vertices from P . If we treat both A and B as leaf vertices, we can view these two representations as two trees, T_a and T_b , and construct $G_{T_a, |P|+1, 1}$ and $G_{T_b, |Q|+1, 1}$ by adding a new leaf v to each tree.

When we identify A and B with the leaf vertex sets that they represent, the topologies of $G_{T_a, |P|+1, 1}$ and $G_{T_b, |Q|+1, 1}$ remains unchanged but the leaf vertices now have the same labels as the leaf vertices in $G_{T_s, |P|+|Q|, 1}$ obtained by adding v to T_s . Note that the vertex set $(A \cup \{v\})|B$ and the vertex set $(B \cup \{v\})|A$ correspond to the two splits obtained by adding the new leaf v to the edge $P|Q$. So by adding proper edges between $G_{T_a, |P|+1, 1}$ and $G_{T_b, |Q|+1, 1}$, we obtain $G_{T_s, |P|+|Q|, 1}$.

Using the definitions from Theorem 2.7, we can define the vertex set: V , the internal edge split set: V_i , and the leaf edge split set: V_ℓ for $G_{T_a, |P|+1, 1}$, $G_{T_b, |Q|+1, 1}$, and $G_{T_s, |P|+|Q|, 1}$. We denote these as

$$V_a, V_{a_i}, V_{a_\ell}; V_b, V_{b_i}, V_{b_\ell};$$

and

$$V, V_i, V_\ell$$

respectively. Observe that for all $u \in V_b$, if u induces a split in the form $M|N$, then at least one of M, N is a subset of $A \cup \{v\}$.

Next, we consider the new edges that will be added from leaf vertices in both graphs. Since leaf vertex sets will form independent sets as shown in Theorem 2.7, leaf vertices can only connect to internal vertices in the other tree—meaning leaf vertices added to T_b , for example, can only connect to internal edges adjacent to leaf vertices in T_a .

Leaf vertices in V_a correspond to splits in the form of $\{u, v\}|B \setminus \{u\}$, $u \in B$. On the other hand, $B \cup \{v\}$ will be a subset of one side of the split for exactly half of the splits represented by internal vertices in V_b . There are $(a - 1)(b - 3)$ additional edges from the leaf vertices in V_a when added to the internal vertices in V_b ; similarly, there are $(b - 1)(a - 3)$ additional edges from the leaf vertices in V_b added to the internal vertices in V_a . So another $(a - 1)(b - 3) + (b - 1)(a - 3)$ edges will be added in total.

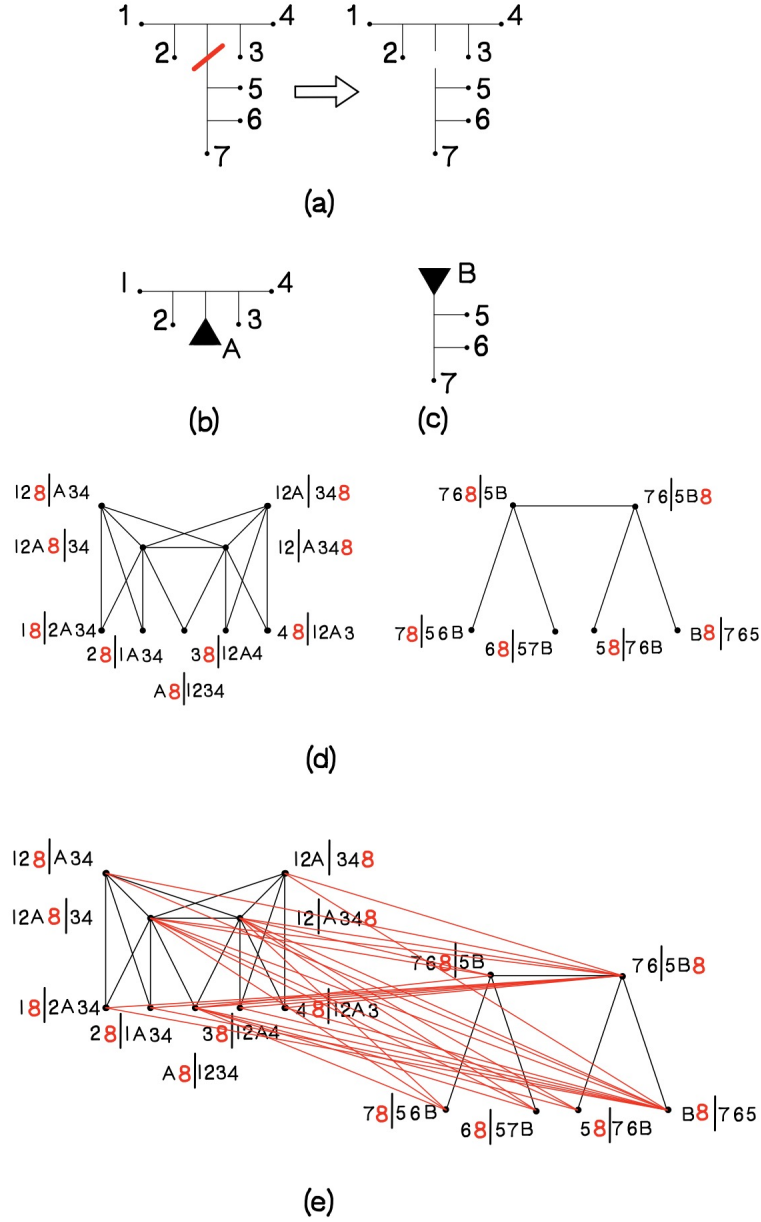

Figure 9: Sub-Figure (a) shows an example for splitting an internal edge of a tree T_s to obtain two smaller trees. In Subfigures (b) and (c), the set A corresponds to the subtree in T_s with leaf vertex set $\{5, 6, 7\}$ and the set B corresponds to the subtree in T_s with leaf vertex set $\{1, 2, 3, 4\}$. Note figures (b) and (c) are two different representations of T_s .

The last case is the edges between V_{a_i} and V_{b_i} . Half of the vertices in V_{a_i} will represent splits with one side containing $A \cap \{v\}$ while for a split corresponding to a vertex in V_{b_i} , the side of the split that does not contain B will be a subset of $A \cap \{v\}$. So half of the vertices in V_{a_i} can be connected to all vertices in V_{b_i} . For the other half of vertices in V_{a_i} that represent splits with A and v on different sides, the side with v will be a subset of the side of a split represented by a vertex in V_{b_i} that contains $B \cap \{v\}$, which is half of the vertices in V_{b_i} . Thus, $(a - 3)(2(b - 3)) + (a - 3)(b - 3) = 3(a - 3)(b - 3)$ edges will be added.

In total, the number of edges that need to be added to the BHV Connection Graph is

$$\begin{aligned}
 & 3(a+b) - 13 + (a-1)(b-3) + (a-3)(b-1) + 3(a-3)(b-3) \\
 &= 5ab - 10a - 10b + 20 \\
 &= 5(a-2)(b-2).
 \end{aligned}$$

□

To illustrate the proof of Theorem 2.8, consider the situation illustrated in Figure 9: A and B contain only leaf vertices, Subfigures (b) and (c) are also two subgraphs of T_s , which we denote T_a and T_b . From this perspective, we can construct the BHV Connection Graphs $G_{T_a,5,1}$ and $G_{T_b,4,1}$ with a new leaf with label 8, as shown in Subfigure (d). If we expand A and B to $\{5,6,7\}$ and $\{1,2,3,4\}$ in the vertex names in $G_{T_a,5,1}$ and $G_{T_b,4,1}$, the union of the vertex sets in $G_{T_a,5,1}$ and $G_{T_b,4,1}$ will be equal to the vertex set of the BHV Connection Graph $G_{T_s,7,1}$ with the new leaf with label 8. Adding edges specified by 2.8, we will obtain the final $G_{T_s,7,1}$ shown in Subfigure (a).

The following is one application of Theorem 2.8.

Corollary 2.9. *The BHV Connection Graph $G_{T_s,n,1}$ has $\frac{5}{2}(n-2)(n-3)$ edges.*

Proof. Any tree with more than three leaves can be formed by concatenating a three-leaf tree in the way described in Theorem 2.8 via iteration. See Figure 10 for an example. Using the last equation from Theorem 2.8, the number of edges in BHV Connection Graph $G_{T_s,n,1}$ is

$$E(n) = E(n-1) + E(3) + 5(n-1-2)(3-2) = E(n-1) + 5(n-3),$$

because $E(3) = 0$.

By solving the recurrence relation, we get the following explicit formula:

$$E(n) = \frac{5}{2}(n-2)(n-3).$$

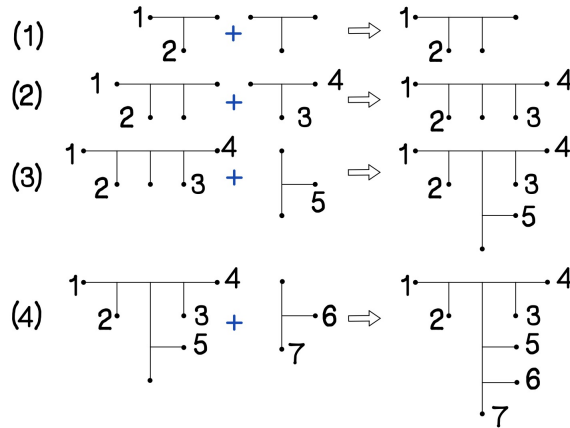

Figure 10: The four iterative steps of adding a three-leaf tree to obtain a target tree T_i

□

3 Discussion

The purpose of this manuscript is to provide a combinatorial method to transition between copies of BHV_n , where n is allowed to vary. Our combinatorial method only uses the intrinsic geodesic metric of (Owen and Provan, 2011) and the construction of the BHV Connection Space, rather than introducing a complex system of mathematical objects that make our results applicable only in limited situations—meaning situations where there are limits on the number of taxa, types of data (meaning conspecific data, gene data, or species trees that should be combined), or the shape of the input and output trees. In particular, the types of tree topologies in the start tree T_s in the beginning of the transition and the end of the transition T_t are not limited beyond the constraint that they are binary. We make these comments to emphasize that our combinatorial method opens the door to the study of several problems in computational biology that up to this point were impossible to study in BHV spaces. We list a few examples below.

1. There is potential for new supertree construction methods (that widely vary and are still under development) for combining phylogenies on varying numbers of taxa with myriad biological properties (Wilkinson et al., 2005; Bininda-Emonds, 2004; Akanni et al., 2015). Supertree methods *must* take inputs with varying numbers of taxa to be useful in a biological context. But in (St. John, 2017) it was made clear that BHV spaces are well-suited for these methods due to the properties of the intrinsic geodesic metric.
2. There is potential for new summary (coalescent-based) methods such as those developed in (Mirarab et al., 2014; Liu et al., 2015) that combine gene phylogenies such as in (Joyner et al., 2014) inferred from short samples from long genomes into a species phylogeny. In practice, it is rare that genomic information for all species taxa is available, and complex methods for dealing with this issue are of current interest to the computational biology community (Streicher et al., 2015; Darriba et al., 2016; Baca et al., 2017) when working with biological data. Summary methods are controversial (Chou et al., 2015; Springer and Gatesy, 2016), but remain of deep interest to the computational biology community and always require exceptions and non-trivial software advances for cases with missing taxa that appeal to complex solutions (Xi et al., 2015). While new methods for dealing with missing taxa are in constant production using computational techniques (Kobert et al., 2016; Thomas et al., 2013; Molloy and Warnow, 2017), it would be surprising if these results did not open the door to the use of BHV spaces in novel quantitative paradigms for the development of fast and accurate novel methods for summary-based species tree estimation.
3. Consensus methods such as the majority consensus method can achieve better results when there is not a restriction on the input trees having the same number of taxa. As pointed out in (St. John, 2017) the geodesic metric allows the construction of paths between trees in a set of trees \mathcal{T} in BHV spaces that do not inherit splits from trees not in the set \mathcal{T} . Therefore our results may enable a novel quantitative embedding of the consensus problem for phylogenies that is competitive with our outperforms pre-existing methods. We believe this is a natural extension of this project because consensus methods rely on splits, but BHV spaces have geometric components that allow for polytomic trees, which are not informative in the use of consensus methods that rely on resolved internal splits in a phylogeny.
4. There is also potential for optimization of the results in this paper by further study of the BHV Connection Space and the BHV Connection Cluster. These are novel objects that may provide a more accessible quantitative framework for addressing problems such as quartet-agglomeration (Sumner et al., 2017; Sayyari and Mirarab, 2016; Reaz et al., 2014;

Avni et al., 2015; Rusinko and Hipp, 2012) that require combining four-taxon trees into trees with any possible number of taxa. We mention the example of quartet-agglomeration in particular because, as explained thoroughly in (Sumner et al., 2017), the Neighbor-Joining method of tree inference (Saitou and Nei, 1987) is fundamentally a quartet-based method that continues to perform well on many datasets that contain more than four taxa (Yoshida and Nei, 2016). The scientific connection between quartet-agglomeration and Neighbor-Joining should not be ignored if progress in these areas is to be made, and our results provide a way to study these problems in a new setting.

5. Finally, there is potential for using our new quantitative framework in the study of inferred unrooted trees that contain polytomies (vertices of degree of four or higher). The orthants of non-maximal dimension in any BHV_n -space correspond to polytomic trees. Polytomies are often recovered in studies of biological data due to the fact that the biological signal in any dataset may not be strong enough to indicate that branch length in an inferred tree should have length greater than zero. This is known to be an issue in maximum-likelihood tree estimation on biological datasets (Pamminger and Hughes, 2017; Simmons and Norton, 2014; Slowinski, 2001). Further, it is known that if the true evolutionary history cannot provide sufficient information to resolve a polytomy, distance-based methods, which remain in use not only on their own, but also as components of maximum-likelihood phylogenomic software inference packages such as FastTree-2 (Price et al., 2010) are biased against returning the correct tree (Davidson and Sullivant, 2014).

4 Supporting materials

To generate connection graphs connecting BHV spaces of specific dimensions using our software, use the script `connection_graph.py` which includes dependencies on Dendropy (see (Sukumaran and Holder, 2010) for the original paper about this software package). Go to

<https://github.com/cpmoni/igl-polyhedra>

to find installation and usage instructions. Figure 11 is the connection graph generated to connect BHV spaces between 9 and 10 dimensions. Please note that the other graphs in this paper is drawn by hand rather than the software, in order to fully clarify the mathematical concepts.

5 Acknowledgments

The undergraduate students Y.R, S.Z, J.B., and J. S., as well as the initialization of this project, were supported by a Mathways Grant NSF DMS-1449269 to the Illinois Geometry Lab at the University of Illinois Urbana-Champaign. R.D. was supported by the NSF grant DMS-1401591. M.D. was supported by the NSF Graduate Research Fellowship DGE-1144245. C.M. was supported by a GAANN fellowship from the Department of Education awarded by the University of Illinois Urbana-Champaign.

References

- L. J. Billera, S. P. Holmes, and K. Vogtmann, “Geometry of the space of phylogenetic trees”, *Advances in Applied Mathematics* **27** (2001), no. 4, 733–767.
- M. Owen and J. S. Provan, “A fast algorithm for computing geodesic distances in tree space”, *IEEE/ACM Transactions on Computational Biology and Bioinformatics (TCBB)* **8** (2011), no. 1, 2–13.

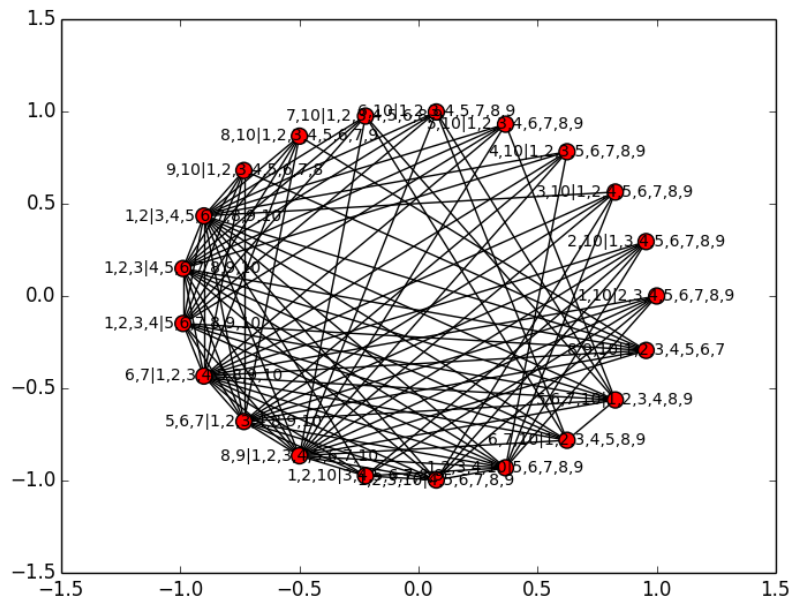

Figure 11: Visualization of the BHV connection graph connecting 9 and 10 dimensions generated by the code released on the github with this paper

- P. Benner, M. Bačák, and P.-Y. Bourguignon, “Point estimates in phylogenetic reconstructions”, *Bioinformatics* **30** (2014), no. 17, i534–i540.
- T. M. Nye, “Principal components analysis in the space of phylogenetic trees”, *The Annals of Statistics*, 2011 2716–2739.
- D. Barden, H. Le, M. Owen, *et al.*, “Central limit theorems for Fréchet means in the space of phylogenetic trees”, *Electronic Journal of Probability* **18** (2013).
- E. Miller, M. Owen, and J. S. Provan, “Polyhedral computational geometry for averaging metric phylogenetic trees”, *Advances in Applied Mathematics* **68** (2015) 51–91.
- G. Weyenberg, R. Yoshida, and D. Howe, “Normalizing kernels in the Billera-Holmes-Vogtmann treespace”, *IEEE/ACM Transactions on Computational Biology and Bioinformatics (TCBB)*, 2016.
- B. Lin, B. Sturmfels, X. Tang, and R. Yoshida, “Convexity in tree spaces”, *arXiv preprint arXiv:1510.08797*, 2015.
- S. Skwerer, J. Marron, and S. Provan, “Optimization methods for Fréchet means in BHV treespace”, *arXiv preprint arXiv:1411.2923*, 2014.
- S. Kim, C.-S. Cho, K. Han, and J. Lee, “Structural variation of Alu element and human disease”, *Genomics and Informatics* **14** (2016), no. 3, 70–77.
- A. R. Francis, “An algebraic view of bacterial genome evolution”, *Journal of Mathematical Biology* **69** (2014), no. 6-7, 1693–1718.

- S. S. Abby, E. Tannier, M. Gouy, and V. Daubin, “Lateral gene transfer as a support for the tree of life”, *Proceedings of the National Academy of Sciences* **109** (2012), no. 13, 4962–4967.
- J. Joyner, D. Wanless, C. D. Sinigalliano, and E. K. Lipp, “Use of quantitative real-time PCR for direct detection of *Serratia marcescens* in marine and other aquatic environments”, *Applied and Environmental Microbiology* **80** (2014), no. 5, 1679–1683.
- C. Semple and M. A. Steel, “Phylogenetics”, Oxford University Press on Demand, 2003.
- B. Lin and R. Yoshida, “Tropical Fermat-Weber points”, *arXiv preprint arXiv:1604.04674*, 2016.
- M. Wilkinson, J. A. Cotton, C. Creevey, O. Eulenstein, S. R. Harris, F.-J. Lapointe, C. Lavesseur, J. O. Mcinerney, D. Pisani, and J. L. Thorley, “The shape of supertrees to come: tree shape related properties of fourteen supertree methods”, *Systematic Biology* **54** (2005), no. 3, 419–431.
- O. R. Bininda-Emonds, “Phylogenetic supertrees: combining information to reveal the tree of life”, Springer Science & Business Media, 2004.
- W. A. Akanni, M. Wilkinson, C. J. Creevey, P. G. Foster, and D. Pisani, “Implementing and testing bayesian and maximum-likelihood supertree methods in phylogenetics”, *Royal Society Open Science* **2** (2015), no. 8, 140436.
- K. St. John, “The shape of phylogenetic treespace”, *Systematic Biology* **66** (2017), no. 1, e83–e94.
- S. Mirarab, R. Reaz, M. S. Bayzid, T. Zimmermann, M. S. Swenson, and T. Warnow, “ASTRAL: genome-scale coalescent-based species tree estimation”, *Bioinformatics* **30** (2014), no. 17, i541–i548.
- L. Liu, S. Wu, and L. Yu, “Coalescent methods for estimating species trees from phylogenomic data”, *Journal of systematics and evolution* **53** (2015), no. 5, 380–390.
- J. W. Streicher, J. A. Schulte, and J. J. Wiens, “How should genes and taxa be sampled for phylogenomic analyses with missing data? an empirical study in iguanian lizards”, *Systematic Biology* **65** (2015), no. 1, 128–145.
- D. Darriba, M. Weiß, and A. Stamatakis, “Prediction of missing sequences and branch lengths in phylogenomic data”, *Bioinformatics* **32** (2016), no. 9, 1331–1337.
- S. M. Baca, A. Alexander, G. T. Gustafson, and A. E. Z. Short, “Ultraconserved elements show utility in phylogenetic inference of Aedeoidea (Coleoptera) and suggest paraphyly of ‘Hydradeopha’”, *Systematic Entomology*, 2017.
- J. Chou, A. Gupta, S. Yaduvanshi, R. Davidson, M. Nute, S. Mirarab, and T. Warnow, “A comparative study of SVDquartets and other coalescent-based species tree estimation methods”, *BMC Genomics* **16** (2015), no. 10, S2.
- M. S. Springer and J. Gatesy, “The gene tree delusion”, *Molecular phylogenetics and evolution* **94** (2016) 1–33.
- Z. Xi, L. Liu, and C. C. Davis, “The impact of missing data on species tree estimation”, *Molecular Biology and Evolution* **33** (2015), no. 3, 838–860.

- K. Kobert, L. Salichos, A. Rokas, and A. Stamatakis, “Computing the internode certainty and related measures from partial gene trees”, *Molecular Biology and Evolution* **33** (2016), no. 6, 1606–1617.
- G. H. Thomas, K. Hartmann, W. Jetz, J. B. Joy, A. Mimoto, and A. O. Mooers, “PASTIS: an R package to facilitate phylogenetic assembly with soft taxonomic inferences”, *Methods in Ecology and Evolution* **4** (2013), no. 11, 1011–1017.
- E. Molloy and T. Warnow, “To include or not to include: The impact of gene filtering on species tree estimation methods”, *Systematic Biology*, 2017 <https://doi.org/10.1093/sysbio/syx077>.
- J. G. Sumner, A. Taylor, B. R. Holland, and P. D. Jarvis, “Developing a statistically powerful measure for quartet tree inference using phylogenetic identities and Markov invariants”, *Journal of Mathematical Biology*, 2017 1–36.
- E. Sayyari and S. Mirarab, “Anchoring quartet-based phylogenetic distances and applications to species tree reconstruction”, *BMC Genomics* **17** (2016), no. 10, 783.
- R. Reaz, M. S. Bayzid, and M. S. Rahman, “Accurate phylogenetic tree reconstruction from quartets: A heuristic approach”, *PLoS One* **9** (2014), no. 8, e104008.
- E. Avni, R. Cohen, and S. Snir, “Weighted quartets phylogenetics”, *Systematic Biology* **64** (2015), no. 2, 233–242.
- J. P. Rusinko and B. Hipp, “Invariant based quartet puzzling”, *Algorithms for Molecular Biology* **7** (2012), no. 1, 35.
- N. Saitou and M. Nei, “The neighbor-joining method: a new method for reconstructing phylogenetic trees.”, *Molecular Biology and Evolution* **4** (1987), no. 4, 406–425.
- R. Yoshida and M. Nei, “Efficiencies of the NJp, maximum likelihood, and Bayesian methods of phylogenetic construction for compositional and noncompositional genes”, *Molecular Biology and Evolution* **33** (2016), no. 6, 1618–1624.
- T. Pamminger and W. O. H. Hughes, “Testing the reproductive groundplan hypothesis in ants (Hymenoptera: Formicidae)”, *Evolution* **71** (2017), no. 1, 153–159.
- M. P. Simmons and A. P. Norton, “Divergent maximum-likelihood-branch-support values for polytomies”, *Molecular Phylogenetics and Evolution* **73** (2014) 87–96.
- J. B. Slowinski, “Molecular polytomies”, *Molecular Phylogenetics and Evolution* **19** (2001), no. 1, 114–120.
- M. N. Price, P. S. Dehal, and A. P. Arkin, “FastTree 2—approximately maximum-likelihood trees for large alignments”, *PLoS one* **5** (2010), no. 3, e9490.
- R. Davidson and S. Sullivant, “Distance-based phylogenetic methods around a polytomy”, *IEEE/ACM Transactions on Computational Biology and Bioinformatics (TCBB)* **11** (2014), no. 2, 325–335.
- J. Sukumaran and M. T. Holder, “Dendropy: a python library for phylogenetic computing”, *Bioinformatics* **26** (2010), no. 12, 1569–1571.