

# Impact of RAN Virtualization on Fronthaul Latency Budget: An Experimental Evaluation

F. Giannone<sup>\*</sup>, H. Gupta<sup>\*</sup>, K. Kondepu<sup>\*</sup>, D. Manicone<sup>\*</sup>, A. Franklin<sup>\*</sup>, P. Castoldi<sup>\*</sup>, L. Valcarenghi<sup>\*</sup>

<sup>\*</sup>Scuola Superiore Sant'Anna, Pisa, Italy

<sup>\*</sup>Indian Institute of Technology Hyderabad, India

Email:francesco.giannone@santannapisa.it

**Abstract**—In 3GPP the architecture of a New Radio Access Network (New RAN) has been defined where the evolved NodeB (eNB) functions can be split between a Distributed Unit (DU) and Central Unit (CU). Furthermore, in the virtual RAN (VRAN) approach, such functions can be virtualized (e.g., in simple terms, deployed in virtual machines). Based on the split type, different performance in terms of capacity and latency are requested to the network (i.e., fronthaul) connecting DU and CU.

This study experimentally evaluates, in the 5G segment of the Advanced Research on NetWorking (ARNO) testbed (ARNO-5G), the fronthaul latency requirements specified by Standard Developing Organizations (SDO) (3GPP in this specific case). Moreover it evaluates how much virtualization impacts the fronthaul latency budget for the the Option 7-1 functional split.

The obtained results show that, in the considered Option 7-1 functional split, the fronthaul latency requirements are about 250  $\mu$ s but they depend on the radio channel bandwidth and the number of the connected UEs. Finally virtualization further decreases the latency budget.

**Index Terms**—5G, functional split, NGFI, DU, CU, testbed

## I. INTRODUCTION

To address the demanding requirements in terms of expected throughput, latency and scalability, 5G networks are expected to be massively deployed and offer an unprecedented capacity [1], [2]. A new concept of Radio Access Network, called New RAN, has been proposed to increase performance with limited deployment cost. In general, in the New RAN, the evolved NodeB (eNB) functions are split into two new network entities [3]. The base-band processing is centralized in the so-called Central Unit (CU) and the RF processing has been left at the edge of New RAN in the Distributed Unit (DU).

The Common Public Radio Interface (CPRI), so far used to connect BaseBand unit (BBU)(i.e., CU) and Remote Radio Head (RRH)(i.e., DU), has shown some limitations [4]. CPRI is based on carrying time domain baseband IQ samples between RRH and BBU. Thus, CPRI needs a high capacity fronthaul, low latency, low delay variation and fine synchronization. Guaranteeing such requirements, if Ethernet is chosen [5] as fronthaul transport technology, is particularly challenging [6]–[8].

Thus new upper layer functional splits, proposed by 3GPP in TR 38.801 [3], a Next Generation Fronthaul Interface (NGFI) [9], and the new CPRI specification for 5G called eCPRI [10] are under definition. Different splits, however, demand different requirements in terms of latency and capacity as reported in 3GPP TR 38.801 [3].

Moreover, recent approaches push the CU functions into the “cloud” (where the CU is “virtualized”), thereby paving the way to the so-called virtual RAN (V-RAN) [11]. However, to the best of the authors’ knowledge, no evaluation has been conducted so far of the impact of virtualization on the fronthaul latency budget.

This paper evaluates experimentally the latency and jitter requirements for different radio channel bandwidths and different number of User Equipments (UEs), in both physical and virtual environment. The experimental evaluation is performed in the 5G segment of the Advanced Research on NetWorking testbed (ARNO-5G) [12]. ARNO-5G allows to emulate the behavior of a 5G network and run performance tests to evaluate several functional split requirements. Another foreseen feature of the ARNO-5G testbed is the possibility of virtualizing different Radio Access Network (RAN) and Evolved Packet Core (EPC) functions to test the virtualized RAN and EPC limits and compare them with the deployment in physical machines.

## II. THE ARNO-5G TESTBED

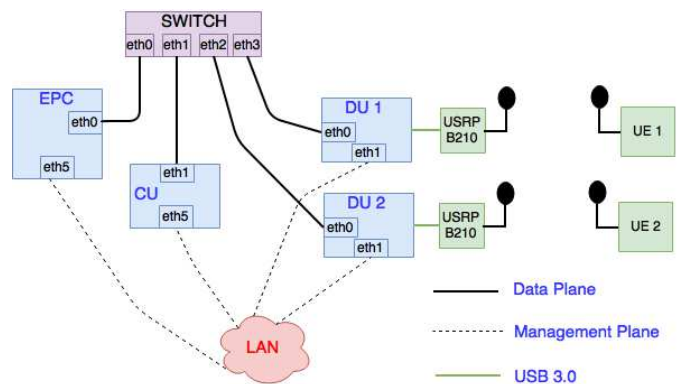

Fig. 1. The ARNO 5G testbed

Fig. 1 shows the ARNO-5G testbed. In this section the function deployment utilized to conduct the performance evaluation reported in this paper is described but alternative deployments are possible exploiting the same hardware.

The EPC and the functional elements belonging to it (i.e., the Serving Gateway (S-GW), the Public Data Network Gateway (PDN-GW), the Mobile Management Entity (MME) and

the Home Subscriber Server (HSS)) are deployed in a mini-pc (Up-board) featuring an Intel Atom x5-Z8350 Quad Core Processor and hosting Ubuntu 14.04 LTS with a 4.7 kernel (directly precompiled by OpenAirInterface (OAI) team).

The Radio Aggregation Unit (RAU) consists of a Cisco Catalyst 2960G switch, referred to as SWITCH in Fig. 1. The RAU becomes a necessary network element because of the point-to-multipoint architecture between the CU and the DU. The RAU forwards the communication from the CU to several DUs.

The CU is deployed in a desktop server with Intel Xeon E5620 and hosting Ubuntu 14.04 with 3.19 low-latency kernel. It is connected by a 1 Gigabit Ethernet link to the EPC and by a 1 Gigabit Ethernet link to the DU as well.

The first DU (*DU1*) is deployed in a Mini-ITX featuring an Intel I7 7700 Quad Core @ 4.0 GHz and hosting Ubuntu 14.04, 3.19 low-latency kernel. This machine is connected to the CU by a 1 Gigabit Ethernet link. It is also connected through USB 3.0 link to an Ettus B210 for implementing the Radio Frequency (RF) front-end.

The second DU (*DU2*) is deployed on a desktop computer with an Intel i7 4790 @ 3.60 GHz and hosting Ubuntu 14.04 with 3.19 low-latency kernel. Also the *DU2* is connected through USB 3.0 link to an Ettus B210 for implementing the RF front-end. The Ettus B210 USRP device is a fully integrated, single-board, Universal Software Radio Peripheral (USRP) platform and acts as radio front-end performing Digital to Analog and Analog to Digital Conversion (DAC/ADC).

The UEs (ie., *UE1* and *UE2*) consists of Huawei E3372 LTE dongles. The dongles support LTE category 4 and Frequency-division duplexing (FDD) communication systems in the following bands: 900 MHz, 1800 MHz, 2100 MHz and 2600 MHz.

The utilized mobile network software is the OpenAirInterface (OAI) by Eurecom. The current OAI platform includes an implementation of 3GPP LTE Release 10 for UE, eNB, MME, HSS, S-GW and PDN-GW on standard Linux-based operating system. In particular, the OAI software stack of the LTE protocol provides different layers such as PHY, RLC, MAC, PDCP and RRC. The latest OAI development branch was used to evaluate the considered scenarios.

Moreover, OAI platform provides C-RAN based functional split evaluation. The functional splits implemented by the OAI platform are the IF5 and IF4.5 also known as Option 8 and Option 7-1 in the 3GPP terminology [3]. In our study we consider a signal bandwidth equal to 5 MHz and 10 MHz, corresponding to 25 and 50 Physical Resource Blocks (PRBs) with the Option 7-1 scenario. In this split in the uplink direction, Fast Fourier Transform (FFT), Cyclic Prefix (CP) removal and possibly Physical Random Access Channel (PRACH) filtering functions reside in the DU and the rest of PHY functions reside in the CU. In the downlink direction, Inverse Fast Fourier Transform (IFFT) and CP addition functions reside in the DU, the rest of PHY functions reside in the CU. In other word, the Option 7-1 functional split is made before/after the resource mapping/demapping respectively.

### III. PERFORMANCE EVALUATION PARAMETERS AND EVALUATION SCENARIOS

This paper evaluates experimentally the maximum latency (i.e., the one way delay between DU and CU) and jitter (i.e., packet delay variation) that Option 7-1 functional split can tolerate in the fronthaul, referred to as allowable latency budget and allowable jitter budget respectively. For Option 7-1 split the one-way latency constraint specified by 3GPP is  $250 \mu s$  [3], mainly due to the  $4 ms$  limit of the Hybrid ARQ (HARQ) [13]. However, no jitter constraint is specified.

The latency and jitter experienced along the fronthaul link is emulated by means of the linux utility traffic control *tc* [14]. The *tc* utility is capable of increasing the delay and jitter that a packet experiences on a link by storing it in the output interface for a specified amount of time before its transmission on the link. A delay  $d0$  is applied to the ethernet interface of the machine in which the DU is deployed and a delay  $d1$  is applied to the ethernet interface of the machine in which the CU is deployed. In this way a one-way latency is inserted in the fronthaul link. For reaching the allowable latency budget,  $d0$  and  $d1$  are increase with steps of  $10 \mu s$ . To evaluate the allowable jitter budget instead,  $d0$  and  $d1$  consists of two components: a fixed mean latency and an additional random latency following a normal distribution whose standard deviation is increased with steps of  $5 \mu s$ . In the latter evaluation two different scenarios are considered. In the first one we set the mean latency close to the allowable latency budget and we varied the jitter in order to understand if the jitter could cause a reduction of the threshold. In the second jitter evaluation scenario we fixed the mean latency quite far from the allowable latency budget and the variation of the jitter values was made to understand if jitter could be an additional constraint for the fronthaul. More details about how to emulate the packet delay by using the *tc* command can be found in [14].

In the performed experimental evaluation different scenarios are considered as described as follows.

Fig. 2 shows the considered Scenario 1, where a single DU is connected to a single CU through the RAU. In this scenario, we bind a single interface with a single UDP port number and all the RAN and EPC functional elements are run on physical machines. It is worth mentioning that NGFI can support point-to-multipoint topology between CU and DU, thus a new element is required. It is called RAU which can interface with CU and carries transport for several DUs [15].

Fig. 3 shows Scenario 2 in which two DUs are connected with a single CU. In order to deploy such scenario we bind a single interface at the CU by using different UDP port numbers to serve two different DUs at the same time. All the RAN

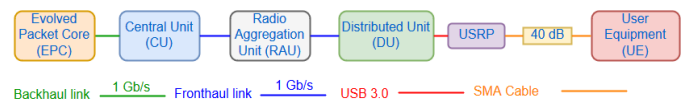

Fig. 2. Scenario 1: Single DU and Single UE

and EPC functional elements run in physical machines. The two DUs are running in two different physical machines, as depicted in the block diagram in Fig. 3, while two OAI CU instances, running in the same physical machine, are connected to the corresponding DUs.

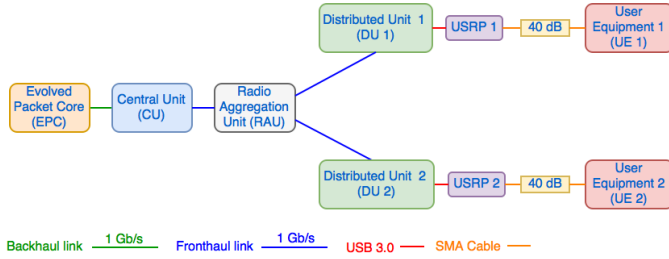

Fig. 3. Scenario 2: Multiple DUs and Multiple UEs

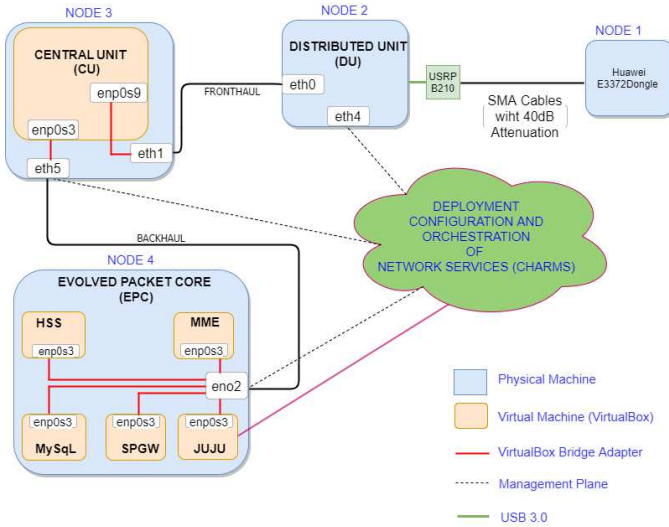

Fig. 4. Scenario 3: virtualization of CU and EPC

Fig. 4 shows the virtualized CU and EPC setup by exploiting JuJu orchestration framework and OAI platform [16], [17]. In particular, the set of Charms (network services) managed by JuJu performs the functional split option 7-1 as specified in 3GPP [3]. This experimental setup contains different Charms such as: MYSQL database, OAI-HSS, OAI-MME, OAI-Serving/Package Gateway for the EPC, OAI-eNB configured to act as a CU and OAI-DU with attached USRP radio frequency frontend. Each of these services is executed inside virtual machines (running Ubuntu 16.04), exploiting VirtualBox tool, except for the OAI-DU which runs in a physical machine, a MiniITX with Intel I7 7700 Quad Core @ 4.0 GHz running Ubuntu 14.04.

In all the aforementioned scenarios the UEs are static and connected to the DU through coaxial cables with 40 dB attenuation. The other experimental parameters are shown in Table I.

TABLE I  
EXPERIMENTAL PARAMETERS

Parameter	Value
Experiment Duration	100000 TTIs
Frame Duration	10 ms
Duplexing Mode	FDD
PHY Layer Abstraction	NO
Number of DUs	2
Number of UEs	2
Carrier Bandwidth	5MHz, 10 MHz

#### IV. EXPERIMENTAL RESULTS

In this section the allowable latency and jitter budgets are evaluated. To calculate the allowable latency and jitter budgets, we use the *tc* command to add delay to network interfaces and TCP traffic is generated by using *iperf* tool to check the UE connectivity stability.

Fig. 5 shows the allowable latency budgets for the considered Scenario 1, Scenario 2 and Scenario 3 with different signal bandwidth values (i.e., 5 MHz and 10 MHz). Results show that in all the scenarios the allowable latency budget is always below the 250  $\mu$ s one-way latency constraint specified by 3GPP [3]. Moreover, it can be noticed that the allowable latency budget decreases if the signal bandwidth and if the number of DUs connected to the same CU increases. The dependence on the signal bandwidth is due to the heavier processing required by the higher number of utilized PRBs. The dependence on the number of CU is similarly due to the higher number of processes running in the same machine. Finally, by comparing the results obtained in Scenario 3 with the ones obtained in Scenario 1 and Scenario 2, it can be noticed that the maximum fronthaul latency that can be tolerated is much lower if mobile network functions are virtualized (i.e., Scenario 3) than if mobile network functions run in physical machines (i.e., Scenario 1 and 2). This phenomenon depends on VM core capacity and other VM parameters. Note that, in Scenario 3 with 10 MHz signal, the UE is not capable of communicating with the EPC because the large number of samples cannot reach the CU on time due to encapsulation delay and transit time across the RAU.

Latency requirements for different functional splits to serve high capacity New RAN architecture have been specified in the 3GPP [3]. However, it is not clear how different functional splits can be affected by jitter. Thus, the second set of experiments aims at investigating whether the jitter impacts the allowable latency budget found in the first set of experiments. In the considered experiments, we vary the jitter while keeping the fronthaul latency fixed and within the above allowable latency budget.

Fig. 6 shows the obtained jitter results in Scenario 1, Scenario 2 and Scenario 3. In particular, in Scenario 1 the latency is set to 220  $\mu$ s for the 5 MHz and is set to 160  $\mu$ s when a 10 MHz signal bandwidth is considered. The obtained

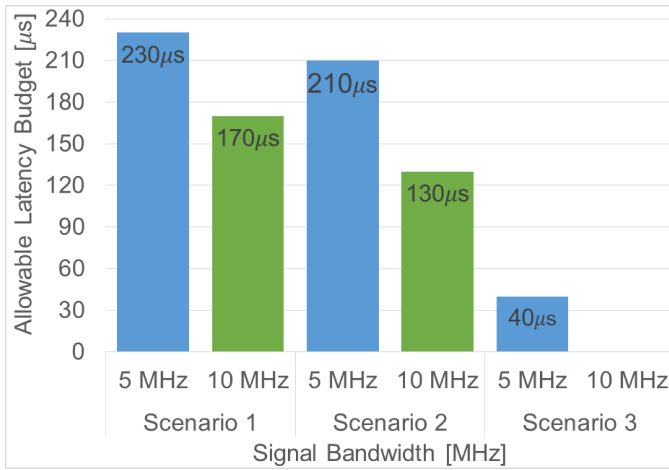

Fig. 5. Fronthaul Allowable Latency Budget in the Scenario 1, Scenario 2 and Scenario 3

allowable jitter budget in this case is equal to  $35 \mu\text{s}$  and  $30 \mu\text{s}$  for the 5 MHz and 10 MHz signal bandwidth, respectively.

For Scenario 2, the experiments are carried out by setting a fixed latency on the fronthaul link equal to  $200 \mu\text{s}$  and  $120 \mu\text{s}$  for 5 MHz and 10 MHz, respectively. The allowable jitter budget is equal to  $30 \mu\text{s}$  for the 5 MHz and  $25 \mu\text{s}$  for the 10 MHz as depicted in Fig. 6.

In Scenario 3, the experiments are carried out by setting a fixed latency on the fronthaul link equal to  $30 \mu\text{s}$  for 5 MHz signal bandwidth. The obtained allowable jitter budget is  $20 \mu\text{s}$ . Note that, even in this case, for 10 MHz the UE cannot connect because the considered testbed system with virtualized CU has only 4 cores. However, it has been verified that the UE is capable of connecting if a virtual CU with 8 cores is utilized with no additional delay on the fronthaul link.

By comparing the results reported in Fig. 5 and in Fig. 6 it can be deduced that jitter negligibly impacts the allowable latency budget.

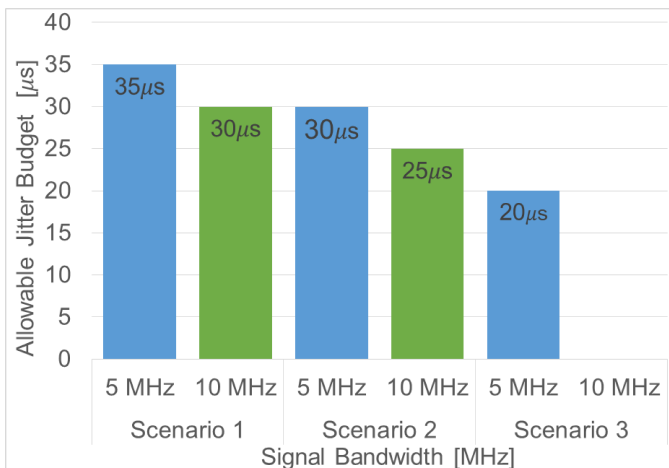

Fig. 6. Fronthaul Allowable Jitter Budget with a latency close to the Limit in Scenario 1, Scenario 2 and Scenario 3

To observe the impact of the sole jitter on the fronthaul link, that is to find the allowable jitter budget, the latency value is set far from the allowable latency budget depicted in Fig. 5. The obtained results are shown in Fig. 7 for Scenario 1, Scenario 2, and Scenario 3. In both Scenario 1 and Scenario 2, the latency is set to  $100 \mu\text{s}$  and  $50 \mu\text{s}$  for signal bandwidths 5 MHz and 10 MHz, respectively. In Scenario 1, the obtained allowable jitter budgets are  $30 \mu\text{s}$  and  $25 \mu\text{s}$  for 5 MHz and 10 MHz signal bandwidth, respectively. Whereas, in Scenario 2, the obtained allowable jitter budgets are  $35 \mu\text{s}$  and  $40 \mu\text{s}$  for 5 MHz and 10 MHz signal bandwidth, respectively. In Scenario 3, the experiments are carried out by setting a fixed latency on the fronthaul equal to  $20 \mu\text{s}$  for 5 MHz signal bandwidth. The obtained jitter budget is  $25 \mu\text{s}$ , and no communication was observed in case of 10 MHz signal bandwidth.

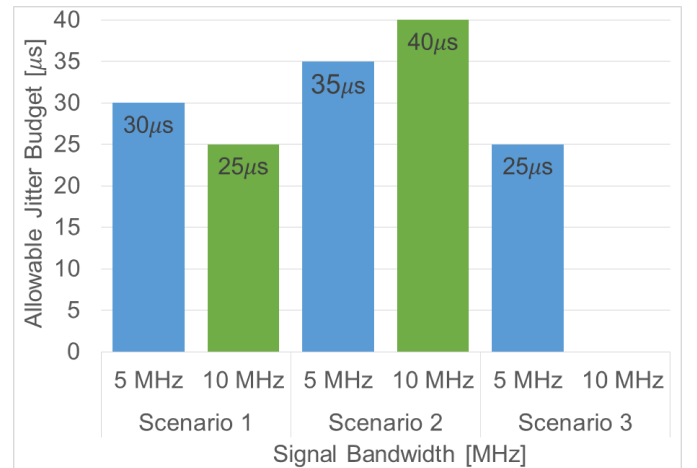

Fig. 7. Fronthaul Allowable Jitter Budget with a latency from the Limit in Scenario 1, Scenario 2 and Scenario 3

From the presented results, we can observe that when the jitter overcomes a certain threshold DU and CU are not capable of communicating. Indeed, the jitter cannot be higher than  $40 \mu\text{s}$  because, if the jitter is large, the are periods in which not enough samples (i.e., modulation symbols) can be delivered to the PHY layer.

## V. CONCLUSIONS

This paper presented the experimental evaluation of the impact of virtualizing eNB functions on the fronthaul latency budget. It also showed the maximum sustainable fronthaul jitter. The experimental evaluation was performed in a testbed utilizing OpenAirInterface as mobile network software, desktop computers, and USRPs.

Results showed that by increasing the instances of CU running in the same machine the allowable fronthaul latency budget decreases of some tens of microseconds due to the higher number of computations required in the same machine. Similarly, but in the order of more than fifty microseconds, it happens if the signal bandwidth increases. Moreover, if eNB functions are run in virtual machines the allowable latency

budget further decreases, in the order of hundreds of microseconds, due to the higher number of computations required by the virtualization engine. Finally, the fronthaul jitter evaluation showed that jitter negligibly impact the allowable latency budget. However, the allowable jitter budget is in the order of tens of microseconds in all the considered scenarios.

#### ACKNOWLEDGMENT

This work has been partially funded by the EU H2020 5G-Transformer Project (grant no. 761536).

#### REFERENCES

- [1] Ericsson, "Ericsson mobility report," June 2015 (accessed on Jan. 22, 2016). <https://www.ericsson.com/assets/local/mobility-report/documents/2015/ericsson-mobility-report-june-2015.pdf>
- [2] Ericsson, "5G radio access capabilities and technologies," June 2015 (accessed on Jan. 22, 2016). <http://www.ericsson.com/res/docs/whitepapers/wp-5g.pdf>
- [3] 3rd Generation Partnership Project; Technical Specification Group Radio Access Network, Study on new radio access technology; radio access architecture and interfaces, 3GPP TR 38.801 V2.0.0 (2017-03).
- [4] Common Public Radio Interface (CPRI) Specification V7.0, Tech. Rep., 2015 (accessed on Jun. 11, 2017). <http://www.cpri.info/downloads/>
- [5] 5G PPP, "View on 5G Architecture," White Paper, July 2016. [Online] Available: <https://5g-ppp.eu/white-papers/> (accessed on Jul. 20, 2017)
- [6] D. Chitimala, K. Kondepu, L. Valcarenghi, M. Tornatore, and B. Mukherjee, "5G Fronthaul-Latency and Jitter Studies of CPRI Over Ethernet," *J. Opt. Commun. Netw.* 9, 172-182, 2017
- [7] L. Valcarenghi, F. Giannone, D. Manicone, and P. Castoldi, "Virtualized eNB latency limits," in *Proceedings of ICTON 2017*, July 2-6, Girona, Spain
- [8] Small Cell Forum Document 159.07.02, Small cell virtualization functional splits and use cases, Small Cell Forum, January 2016 (accessed on Jul. 20, 2017)
- [9] Next Generation Fronthaul Interface (1914) Working Group [Online] Available: <http://sites.ieee.org/sagroups-1914/> (accessed on Jul. 20, 2017).
- [10] New Common Public Radio Interface (eCPRI) for 5G Specification V1.0, Tech. Rep., 2017 (accessed on Sep. 15, 2017) <http://www.cpri.info/press.html>
- [11] A. Checko, H. Christiansen, H. Yan, Y. Scolari, G. Kardaras, M. Berger, and L. Dittmann, "Cloud RAN for mobile networks—A technology overview," *IEEE Commun. Surv. Tutorials*, vol. 17, pp. 405-426, 2015.
- [12] ARNO-5G Testbed [arnotestbed.santannapisa.it](http://arnotestbed.santannapisa.it)
- [13] CMCC, "Transport requirement for CU&DU functional splits options", R3-161813 (document for discussion), 3GPP TSG RAN WG3 Meeting #93, Goteborg, Sweden, 22nd-26th August 2016
- [14] S. Hemminger, "Network Emulation with NetEm," in *Linux Conf Au*, April 2005.
- [15] R. Knopp, N. Nikaiein, C. Bonnet, F. Kaltenberger, A. Ksentini, R. Gupta "Prototyping of Next Generation Fronthaul Interfaces (NGFI) using OpenAirInterface," [Online] Available: [http://www.openairinterface.org/?page\\_id=1695](http://www.openairinterface.org/?page_id=1695)(accessed on Sept. 28, 2017).
- [16] N. Makris, T. Korakis, V. Maglogiannis, D. Naudts, N. Nikaiein, G. Lyberopoulos, E. Theodoropoulou, I. Seskar, C. A. Garcia Perez, P. Merino Gomez, M. Tosic, N. Milosevic and S. Spirou "FLEX Testbed: a platform for 4G/5G wireless networking research," [Online] Available: <https://biblio.ugent.be/publication/8506526/file/8506529.pdf>(accessed on Sept. 28, 2017).
- [17] "How to run OAI using JuJu Service modelling tool (cloudification of OAI)," [Online] Available: <https://gitlab.eurecom.fr/oai/openairinterface5g/wikis/OAIonJuJu>(accessed on Sept. 28, 2017).