

Confidentiality enforcement by hybrid control of information flows

Joachim Biskup, Cornelia Tadros and Jaouad Zarouali

Fakultät für Informatik, Technische Universität Dortmund, Germany

E-mail: {joachim.biskup|cornelia.tadros|jaouad.zarouali}@cs.tu-dortmund.de

Abstract An information owner, possessing diverse data sources, might want to offer information services based on these sources to cooperation partners and to this end interact with these partners by receiving and sending messages, which the owner on his part generates by program execution. Independently from data representation or its physical storage, information release to a partner might be restricted by the owner's confidentiality policy on an integrated, unified view of the sources. Such a policy should even be enforced if the partner as an intelligent and only semi-honest attacker attempts to infer hidden information from message data, also employing background knowledge. For this problem of inference control, we present a framework for a unified, holistic control of information flow induced by program-based processing of the data sources to messages sent to a cooperation partner. Our framework expands on and combines established concepts for confidentiality enforcement and its verification and is instantiated in a Java environment. More specifically, as a hybrid control we combine gradual release of information via declassification, enforced by static program analysis using a security type system, with a dynamic monitoring approach. The dynamic monitoring employs flow tracking for generalizing values to be declassified under confidentiality policy compliance.

Keywords: confidentiality policy, inference-usability confinement, declassification, inference control, language-based information flow control

1. Introduction

Today's IT-security technologies provide a broad variety of effective and efficient mechanisms to prohibit unauthorized reading of any kind of raw *data*, e.g., authenticated access control and private-key or certified public-key encryption. And these technologies also offer somehow limited approaches to confine the *information* content of data made accessible to cooperation partners, e.g., language-based information flow control, information systems with inference-usability confinement, confidentiality-preserving data publishing and cryptographic multiparty computations. However, independently of its carrier and its representation, information is the fundamental *asset* of an individual pursuing self-determination or an enterprise doing business. Moreover, information arises not only from accessible data but essentially also from a priori *knowledge* and *intelligence* of a reasoning observer and, additionally, is *accumulated* over the time. So, being widely unsolved so far, the challenge is to enable an individual or an enterprise as an information *owner* to exercise a *holistic control* over the information conveyed to communication partners by means of transferred data.

We address this challenge in the following narrower, yet comprehensive scenario. The owner's information basis is modeled as an *abstract information state* which might be a single relational database, a collection of diverse data sources or a dedicated virtual view derived from a federation of heterogeneous data sources. This basis is processed program-based by a single control component, called *mediator*, to determine reactions to requests received from a cooperation partner of the information owner under selective prohibitions of information release stated in the owner's *confidentiality policy*. The mediator's approach is twofold, first, to explore the options of the partner, seen as a semi-honest attacker, to exploit the communicated data to infer information to be kept hidden, and, second, to block all such options by filtering and modifying the data appropriately.

Thereby, the exploration of the attacker's inference options should be based on his (assumed) general background and a priori knowledge as well as on the tracing of the overall history and the tracking of the current control flow of the mediator's program execution. In particular, we focus on the partner being an initiator of requests, an observer of reactions and a rational attacker against the policy, but do not consider his client system by means of which he interacts with the mediator.

The policy only specifies *what* should be kept confidential and leaves open *how* confidentiality will be enforced. For an enforcement we propose a two-layered approach of employing existing concepts, namely

- language-based *information flow control* with declassification for the program-based interaction processing, e.g. [25], and
- *inference-usability confinement* with dynamic tracking of information flows from the abstract information state to generated message data sent to the partner and with a filter and modification method that employs generalization of declassified values, e.g. [5,6,7].

Our main contributions are

1. a fundamental framework for unified, holistic control of information flow through program execution from an abstract information state to the partner,
2. a formal verification that the control enforces the confidentiality policy under restrictions on the expressiveness of the programming constructs involved, and
3. a Java-based, exemplary instantiation of that framework.

The proposed control bases on the *gradual release* property [2] established by security type systems for language-based information flow control. According to this property, program execution may release information from the abstract information state, but exclusively and gradually via dedicated declassification assignments, and thus via no other program constructs. The guarantee of this gradual release property by a suitable security type system is the basis of our verification of confidentiality enforcement. Additionally, what information is declassified is controlled by a dynamic monitor for confidentiality-policy compliance in the spirit of inference-usability confinement.

Inference-usability confinement does not confine information disclosure, but such that would enable the partner to infer a confidential piece of information. The key method to do so is to simulate the partner's options for inference by two means, knowledge updates and entailment tests. First, a control mechanism for inference-usability confinement may update a usually logic-based model of the partner's knowledge according to what knowledge the partner may gain through a specific message sent to him as a reaction. Second, the control mechanism may test whether such an updated knowledge model entails a confidential piece of information (in the pertinent logic). Employing these means, including possibly

several entailment tests each based on a specific, tentative knowledge update, the control mechanism may decide for or against confining the information content of the message to be sent to the partner.

In our two-layered approach, the dynamic monitor simulates the partner's inference similarly, because it also employs a kind of knowledge update and a kind of entailment test. First, the monitor tracks information flow for determining what knowledge the partner may gain through a declassified value and for updating a model of the partner's knowledge accordingly. Second, the monitor tests whether the disclosure of pieces of tracked information gives the partner the option of harmful inference. By these means, the dynamic monitor decides whether to filter information (as a confinement) by modifying a declassified value to a suitably generalized value. This way, the monitor extends the control by the type system for gradual release, by determining what information is to be declassified, and confining this information to that conveyed by a suitably generalized value if necessary for confidentiality policy compliance.

This combined control by both the type system and the monitor is shown to be effective by adopting a proof method from [4], a modular static approach for conditioned gradual release. The conditioned gradual release property extends gradual release with a declaration of what information may be declassified (in relational logic). A program may be verified to have this property by a static analysis of its code.

As part of the framework, we also provide a general scheme by means of which declassified values are generalized to confine the information disclosed. And furthermore, inspired by symbolic execution [3], we present an algorithmic approach for the monitor's dynamic tracking of abstract information. Our contributed framework leaves room for many optimizations, for example an apt balance between static program analysis and dynamic monitoring. Such optimizations can be explored reasonably given a concrete class of abstract information states and could be built on results of the established methods we employ for our framework. In the conclusion of this article, setting our contribution into the context of related work, we outline ideas how to do so.

Outline of article.

In Section 2, we overview the essential design concepts of the mediator framework according to our two-layered approach and illustrate them with a running example (part of the first main contribution).

In Section 3.1, we instantiate the framework in a Java environment, exemplifying the challenges inherent in any instantiation and suggesting respective preliminary solutions (part of the third main contribution). Moreover, this instantiation demonstrates the joint functioning of the framework's components introduced in Section 2.

In Section 3.2, we define the functionality of the desired mediator as part of a run-based system under the objective of a unified, verifiable declaration of the whole framework. The other part of this system models an observer, which as a worst case assumes the capabilities of the cooperation partner as an attacker against the confidentiality policy. This model of the observer is presented in Section 3.3 and completes the declaration of the semantic property for confidentiality, outlined in Section 2. Afterwards, in Section 4 we detail the control by the dynamic monitor based on declarative properties that we motivate and introduce in the same section for the tracking of information flow from the abstract information state to program data. Then, we verify that the declaratively specified mediator enforces the confidentiality property (first and second main contribution). The proofs for this verification are shifted to the appendix.

As a further elaboration of the mediator framework (first main contribution), in Section 5, we present an algorithm for determining a generalized value based on a summary of the observer's options of inference as prepared by the dynamic monitor. This algorithm implements a declarative concept from Section 2 as we prove, and additionally relies on a generalization hierarchy of values similarly as anonymization algorithms for k -anonymity. Furthermore, in Section 6, adapting ideas from symbolic program execution,

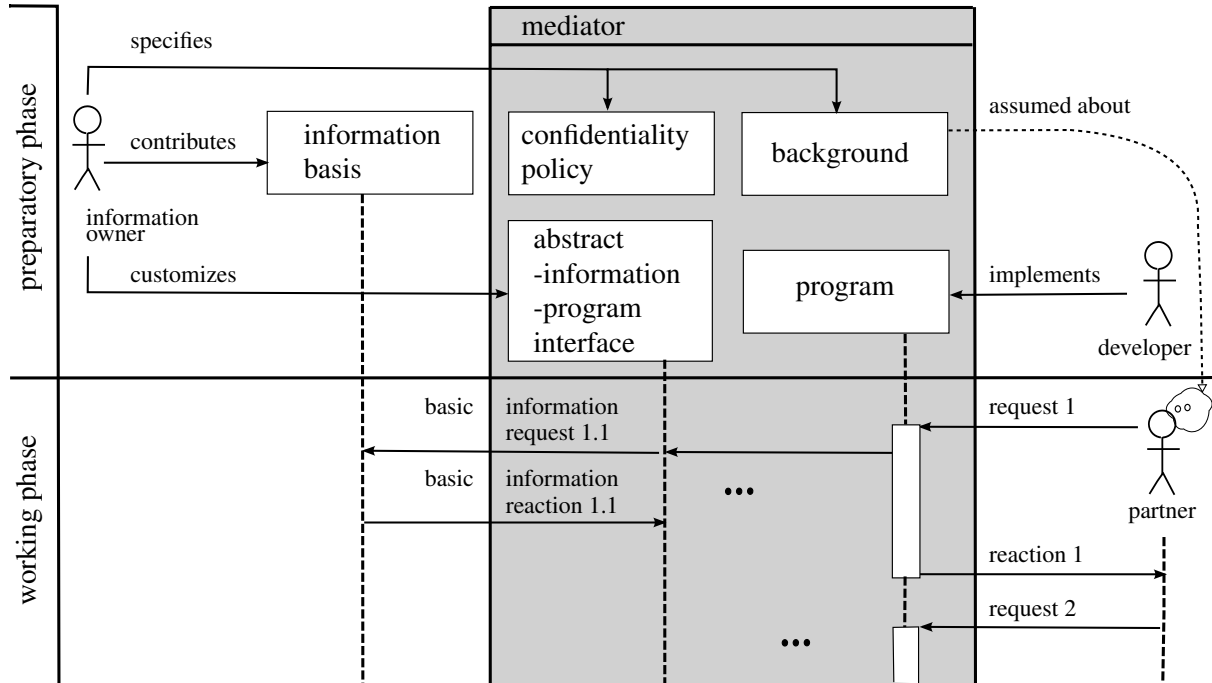

Figure 1. Scenario of an information owner cooperating via a mediator with one partner with the owner's concern for the confidentiality of information contained in his information basis

we present algorithms that implement the declarative requirements for the tracking of information flow from Section 4 and verify that these requirements are indeed achieved.

In Section 7, we present selected challenges for instantiating components of the framework introduced from Section 3.2 on and sketch respective solutions of our Java-based instantiation introduced in Section 3.1. Finally, in Section 8, by additionally considering related work, we will discuss our contributions.

2. Overview on the framework

The main goal of the framework is confidentiality preservation for the mediated abstract information state processed program-based as an information service to the partner by *uniformly* and *securely relating* two established methods of control. On the one hand, the first method, inference control in the spirit of inference-usability confinement, controls the information release from the abstract information state by dynamic tracking and value generalization. On the other hand, the second method, information flow control, considers information with different degrees of sensitivity and contained in data objects which are stored in variables and are manipulated by means of commands like evaluation of expressions, assignment or conditionals (guarded commands). In this section, first we will make more precise the information mediation scenario for which we aim to achieve this goal as shown in Figure 1. Then, we will introduce our proposed framework step-wise along the line of reasoning that justifies our approach. In the next section, we will summarize the introduced components of the framework by their comprehensive formalization as a run-based system and give an example of instantiating the framework.

Scenario. Preparing the mediator's information services, a developer, on behalf of the information owner, implements a *program* which generates reactions to requests by a specific cooperation partner, for example, to make sales offers according to requests by the partner as a buyer. For these services, the informa-

tion owner has defined a dedicated *abstract-information-program interface* via which the program may query the abstract information state, the *information basis* contributed by the information owner. Such queries, here called *basic information requests*, are the only way how the program may get data from the abstract information state. Moreover, the information owner declares a partner-specific *confidentiality policy* pol as sets of abstract information states, as described in [7].

Example 1 *As a simple running example we consider an abstract information state in form of a relation DS over the attribute ID as a primary key and further functionally dependent attributes A, B and C . Each attribute X has a finite domain $\text{dom}(X)$ assumed to be disjoint with the domains of the other attributes. Via the interface the mediator's program can query the state by unnested select or project queries, where selection predicates are restricted to conjunctions of attribute-equals-value terms. To keep it simple, the program only accesses the state for a single row as identified by its ID value id . We denote this row by DS^{id} . The value id can be thought of as an identifier of an individual and the row as data related to him. With regard to this individual's privacy, the data owner specifies as confidential that C has the value c_1 by $S_1 = \{(id, A, B, c_1) \mid A \in \text{dom}(A), B \in \text{dom}(B)\}$, that C has the value c_2 by $S_2 = \{(id, A, B, c_2) \mid A \in \text{dom}(A), B \in \text{dom}(B)\}$ and that the value b_2 of B occurs with the value c_3 of C by $S_3 = \{(id, A, b_2, c_3) \mid A \in \text{dom}(A)\}$.*

As a threat to this policy, the partner is seen as a semi-honest attacker who always uses requests with a valid format and type, but who may employ a sequence of such requests to find out confidential information. The information owner specifies the *background* which the partner might exploit for this purpose, assuming the partner's actual a priori knowledge.

During the mediator's service, the program is executed by the mediator to handle the partner's requests on the one hand, and to keep selected pieces of such information confidential from the partner as declared in the policy on the other hand. More specifically, being rational, the cooperation partner might reason about the reaction data transmitted to him by a single message generated by one execution of the program based on the actual abstract information state and the partner's request. By reasoning thus the partner might infer that this state contains a certain piece of confidential information. Moreover, for such a reasoning the partner might also inspect the whole *history* of message data generated by possibly several subsequent program executions. In this way, the partner might figure out that the set of states appearing possible to him (which contains the actual state) is a subset of at least one of the states S specified as an element of the confidentiality policy (and thus the actual state is contained in such a sensitive S).

The partner's capabilities as an attacker will be assumed as those of a potentially more powerful *observer* which may not only perceive message data as the partner may do, but in a limited way may perceive the mediator's progress of computation as the partner might not do. The capabilities of this observer will be formalized as part of a system consisting of the mediator and the observer. This formalization abstracts the mediator's activities and the observer's perceptions thereof to a function, called *run*, from time, represented as \mathbb{N}_0 , to the mediator's and the observer's states. The (formal model of the) system Sys then is a set of runs and has several parameters among which are the mediator's program p , an abstract information state as an element of a set \mathcal{AIS} of abstract information states, a confidentiality policy $\text{pol} \subseteq \mathcal{P}(\mathcal{AIS})$, and program input from a single request by the partner.

Based on this formalization, the observer's inference will be modeled by a knowledge operator \mathcal{K} about possible abstract information states. Finally, the confidentiality policy requires that the observer, and thus the less powerful partner, should not be able to infer a confidential piece S of information. Thus, we aim at the following property.

Property 1 (Confidentiality preservation) For all runs $r \in Sys$ and times t and for all $S \in pol$ it holds $\mathcal{K}(r, t) \not\subseteq S$.

The sole purpose of the mediator framework is to enforce this property in an automated manner, filtering and modifying as few pieces of information as possible for a most informative reaction to the partner. For this purpose, the mediator employs a *flow tracker* for dynamic tracking of information flow from the abstract information state to data processed by the program and a *censor* for policy-compliant value generalization. The jointly coordinated functioning of the flow tracker and the censor as a dynamic monitor of declassification assignments is illustrated by Figure 2 and explained in the remainder of the section. The remainder of the section is further divided into items along the line of reasoning supporting our approach.

Example 2 For the upcoming exposition of the mediator framework, consider the following purposeless program p the arguments arg_1, arg_2 of which are set via the partner's request and the return value x_{rea} of which is forwarded to the partner. A basic information request br to the interface takes the query kind and the respective parameters as arguments. The marked lines are being explained in the sequel.

```

p(arg1, arg2) : xrea
1: if arg1 IN dom(C) then x1 := NOT ISEMPTY(br(select, C = arg1))
2: else x1 := FALSE endif
3: if arg2 IN dom(C) then x2 := NOT ISEMPTY(br(select, C = arg2))
4: else x2 := FALSE endif
5: x3 := br(project, {A, B})
6: x4 := br(project, {A, C})
7: if x1 or x2 then x5 := x3 else x5 := x4 endif
8: decl(x5, x6)
9: xrea := TOSTRING(x6)

```

1. Isolation by typing. The working space of the mediator's program has to be strictly divided into a *protected realm* where potentially confidential information stemming from reactions to basic information requests, basic information reactions for short, is processed and an *open realm* where the final external reaction to the partner's request is prepared. The division into realms is virtually achieved by separating the set Vars of program variables into two subsets, that of low variables Lvars to which only data processed in the open realm may be written as a preliminary rule, and that of high variables Hvars, without any write restrictions.

Technically, the mediator's program will be typed by means of a security level inference \vdash_{Γ} when the developer compiles the program. This level inference starts with the basic set Γ , which assigns levels from {high, low} to selected expressions, and inductively derives levels of further expressions, including program variables, and levels of assignments as elementary programs and of their composition to complex subprograms by control flow constructs. Our approach is not to select a specific security level

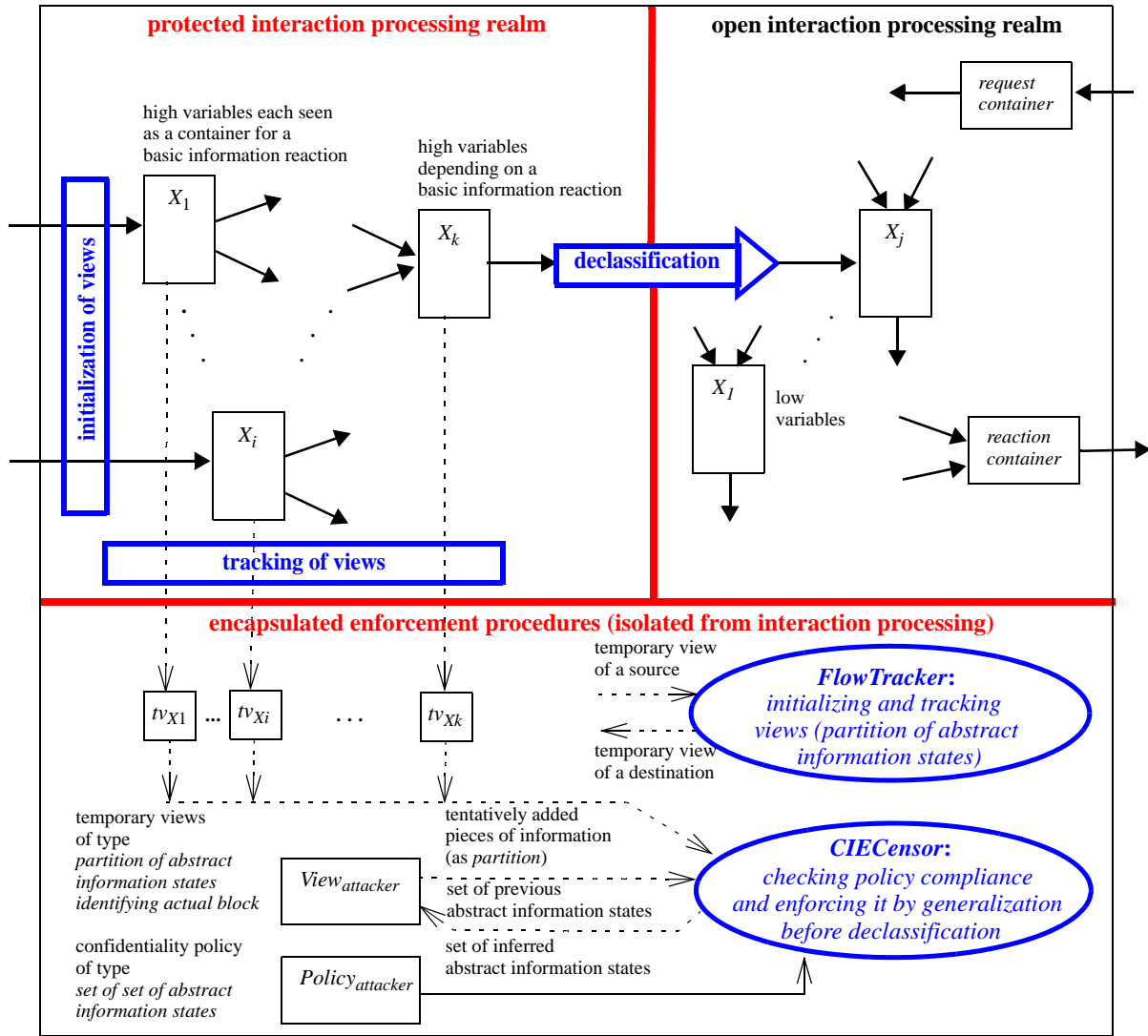

Figure 2. Components of the proposed framework with a two layered approach according to the draft in [10]: Release of information from the abstract information state to the partner solely through declassification, and control of the information flow through declassification for confidentiality policy compliance by a dynamic monitor which consists of FlowTracker and CIECensor

inference system¹, but to point to properties needed for the verification of our framework and offered by numerous such systems to-date. Each time we eventually instantiate the framework, we select the security level inference system as we demonstrate in Section 3.1.

¹ Or more generally, we do not rely on a specific security type (inference) system, which may assign and derive more expressive types than security levels in the mentioned inductive way. But we do not need the enriched expressiveness for our exposition.

The meaning of variable levels, as we desire for the division of processing realms, are phrased more concisely by two rules, adhered to by level inference. The first rule *no-read-up* roughly says that a subprogram typed low, denoted by $p : \text{low}$, may not read high-level variables. Complementarily, the second rule *no-write-down* roughly says that a subprogram typed high, denoted by $p : \text{high}$, may not write to low variables. As stated in the strict form here, these rules applied together ensure that the value of a high variable does not affect the values of low variables at all.

This lack of effect of high processing on low processing can be stated as a security property like non-interference [25]. If a security level inference guarantees such a property, then it actually achieves the desired isolation of realms under three further restrictions. First, basic information reactions must be treated as high variables by level inference. Second, a designated variable as a container for the reaction sent to the partner must be low. Third, to largely simplify the design of the dynamic monitor we further require that parameters to basic information requests must be low. In formal terms, these requirements could be specified in the set Γ on which level inference \vdash_{Γ} bases.

Example 3 *In the program code displayed in Example 2 parts processed in the protected realm are underlined: these are those parts that may not write to low variables. The variables x_1 to x_4 get assigned the return values of basic information requests and therefore may not be low. The guard of the if-statement in line 7 thus evaluates high variables. Since this evaluation may not affect the change in low variables, they may not be written in the scope of the guard.*

2. Sharing by declassification. To nevertheless enable *discretionary sharing* of information about the abstract information state, i.e., a controlled information flow from a variable in the protected realm to a variable in the open realm, we will use *declassification* by means of an explicit assignment $\text{decl}(x_{src}, x_{dest})$ for declassification of the content of variable x_{src} to variable x_{dest} , to be offered by the level inference system used. This is the sole means to let information contained in the abstract information state flow from the protected to the open realm.

Absence of (exploitable) information flow about this state via other program constructs than a declassification assignment means that after the execution of such a program construct, but declassification, the partner cannot extend his knowledge. This restriction on the way how the partner may extend his knowledge about the abstract information state can be enforced by the security level inference system as the property of gradual release. Hence, we aim at the following property that considers the knowledge before and after the one-step execution of the next program construct, called *active command*.

Property 2 (Gradual release, cf. [2]) *For all runs $r \in \text{Sys}$ and times t where the active command in (r, t) is not a declassification assignment, it holds $\mathcal{K}(r, t + 1) = \mathcal{K}(r, t)$.*

Example 4 *In the program code of Example 2 a value contained in a high variable can only be assigned to the variable x_{rea} for the reaction to the partner if this value has been declassified before. A rule of thumb is that the earlier in the code a value is declassified the less informative a possible modification of that value is as a negative effect, and the less computational effort the dynamic monitor requires as a positive effect. This rule will be illustrated in Section 7.*

3. History-aware policy compliance by FlowTracker and CIECensor. *Before transferring data through the declassification assignment the mediator has to ensure that the transfer would be harmless, i.e., complying with the confidentiality policy under the simulated history-dependent *previous view* $\text{prev} \subseteq \mathcal{AIS}$ of the attacker on the mediator's abstract information state. For this complex task, we will provide a dedicated encapsulated component called *FlowTracker* which can delegate subtasks, namely*

(1) evaluations of harmlessness and (2) actions of filtering and modifying, to a further component called *CIECensor*.

The previous view prev describes knowledge of the partner about the abstract information state in the following sense: The partner can rule out any state in $\mathcal{AIS} \setminus \text{prev}$ as the actual abstract information state ais without being mistaken since $\text{ais} \in \text{prev}$ will be an invariant throughout interaction processing guaranteed by the proposed framework. Initially, this view can be taken from the previous execution of the interaction processing program for the cooperation partner or, if there is no such execution, initialized to a definition of a priori knowledge for that partner. To simplify notation, we define \mathcal{AIS} accordingly and let the mediator initialize $\text{prev} := \mathcal{AIS}$. Intuitively, initial policy compliance should amount to ensuring $\text{prev} \not\subseteq S$ for all $S \in \text{pol}$. With the previous simplification, this requirement can be reformulated to $S \neq \mathcal{AIS}$.

Example 5 *Since the partner knows, in our simplified illustrative scenario, that the mediator accesses the row of an individual identifiable by its ID value id , the set \mathcal{AIS} is the set of all such rows $\{(id, A, B, C) \mid A \in \text{dom}(A), B \in \text{dom}(B), C \in \text{dom}(C)\}$. Obviously the policy given in Example 1 is not compromised by this initial knowledge.*

4. Need of local flow tracking. For an *evaluation of harmlessness* of a requested data transfer through a declassification assignment, the *CIECensor* needs to know both the explicit and the implicit information about the abstract information state contained in the source variable x_{src} as the result of the preceding processing in the protected realm.² I.e., the *CIECensor* needs an additional input, namely a temporary view on the abstract information state for x_{src} , solely resulting from preceding processing and to be tentatively combined with the attacker's previous view. This *tentative addition* will be dynamically generated by the *FlowTracker*.

5. Identifying implicit flows by symbolic executions. Implicit information – as caused by guarded commands – not only depends on the execution path actually performed but also on the (alternative) paths possibly followed which could be selected for different values of the pertinent guards. Accordingly, the *FlowTracker* will base the dynamic generation of the tentative addition, the temporary view on the abstract information of a variable x_{src} to be declassified, on a *symbolic expression*. This symbolic expression stems from *symbolic program execution* of a piece of code, which computes the value of x_{src} and has a high security level, as inspired by [3].

Symbolic program execution will translate the considered piece of code to an execution tree, the leaves of which each represents a set of possible execution paths. Throughout *all* paths of this tree, symbolic program execution will follow the changes of high variables and denote their respective information contents, regarding the abstract information state, by symbolic expressions. These expressions may refer to each program expression, the initial value of which is used in a path, by a respective (still uninterpreted) symbol.

Example 6 *The if-statement in line 7 of the code of Example 2, when considered in isolation, is translated to the symbolic expression $(x_1 \vee x_2) * x_3 + \neg(x_1 \vee x_2) * x_4$ for the information content of variable x_5 regarding the abstract information state. The symbol $+$ separates the alternative paths, while the*

² As it is common [4,12], we assume that x_{src} is not declassified in the scope of a high level guard so that only the preceding evaluation of the guard of a guarded command, the execution of which has been completed, may be conveyed implicitly through the declassification. The only way how this implicit information may be conveyed is by the value of x_{src} .

symbol $*$ connects boolean conditions/computations along each path. The symbols \neg, \vee denote boolean operators. The interpretation of all these symbols is illustrated in the next step.

6. Determining local flows by FlowTracker. To prepare for declassification, the *FlowTracker* will evaluate the symbolic expressions for high variables manipulated by a considered piece of code using the actual information contents of other variables involved. These information contents are dynamically determined as *temporary views* associated with these variables. More specifically, these temporary views are *initialized* when storing a basic information reaction in a variable seen as a container and for an evaluation further *tracked* according to the operators in the symbolic expressions.

In abstract terms, such an information content is represented as an R -indexed partition of \mathcal{AIS} , similarly as in [7], which is a partial function of type $R \hookrightarrow \mathcal{P}(\mathcal{AIS})$ such that the elements of its image form a partition of \mathcal{AIS} and R is a finite subset of values $Vals$. We write $(\mathcal{B}_w)_{w \in R'}$ where $\mathcal{B}_w \subseteq \mathcal{AIS}$ is the image of w and $R' \subseteq R$ is the domain of the function. A temporary view containing $(\mathcal{B}_w)_{w \in R'}$ for variable x means the following: knowing the value of x is w enables the attacker to infer to which block the actual abstract information state belongs, namely \mathcal{B}_w . Moreover, the partition is complemented with an identification of the *actual value* of the variable and *block* of the partition, respectively.

Example 7 Reconsider the program of Example 2 called with values c_1 and c_3 obtained from the partner's request. In line 7, variable x_5 contains the result of projecting the abstract information state to attributes A and B in the if-branch, or A and C in the else-branch. The step-wise construction of the temporary view for x_5 for this program line is illustrated by Figure 3 and explained in the following.

If we take $dom(C) = \{c_1, c_2, c_3, c_4\}$, a projection to attributes (A, C) partitions \mathcal{AIS} of Example 5 into the blocks above the dotted crossline. These blocks are represented by four boxes each labeled with a set of indexes. Each index, which is of the form (A, C) , $A \in dom(A)$, $C \in \{c_1, c_2, c_3, c_4\}$, refers to a respective block, in total yielding $4 \cdot dom(A)$ many blocks above the crossline. Likewise, a projection to (A, B) yields a partition as below the dotted crossline where the single box represents $dom(A) \cdot dom(B)$ many blocks.

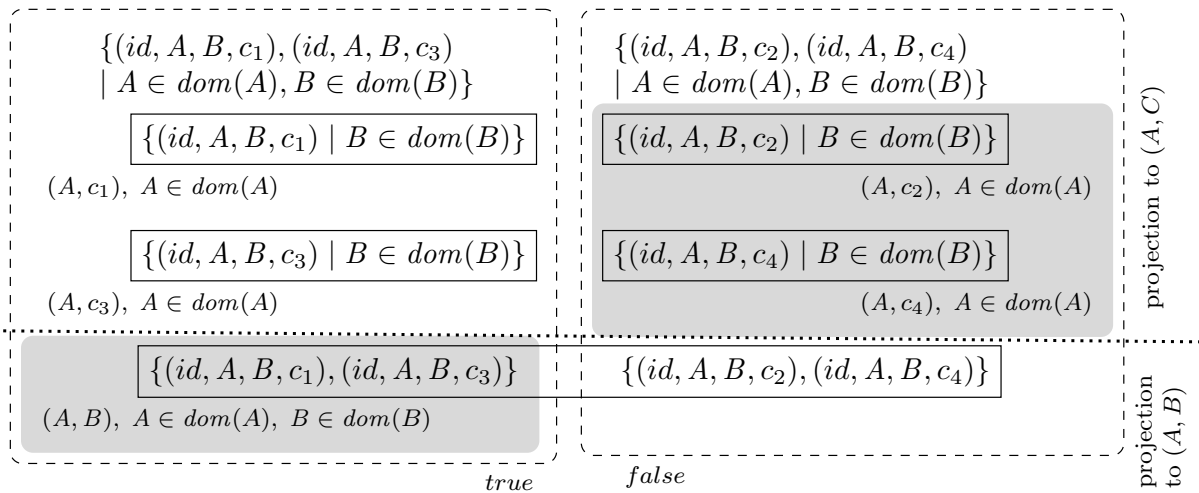

Figure 3. Partitions for the flow tracking through the if-statement in line 7 to variable x_5 : the initial partition for the guard x_1 or x_2 consists of the true/false-indexed blocks in dashed lines dividing \mathcal{AIS} into the two sets in the first line of the diagram

If the cooperation partner observed the so computed value of x_5 , he could single out the actual abstract information state as a member of a specific block in the grayly shaded area where blocks below the dotted crossline are reduced to their intersection with this area. For example, if that value was the pair (a_1, b_2) , the partner may conclude that the state is one of $\{(id, a_1, b_2, c_1), (id, a_1, b_2, c_3)\}$.

Now, let us see how the *FlowTracker* determines these blocks in the grayly shaded area by interpreting the symbolic expression $(x_1 \vee x_2) * x_3 + \neg(x_1 \vee x_2) * x_4$ introduced in Example 6. As for the subterm $(x_1 \vee x_2) * x_3$, the *FlowTracker* evaluates symbol x_3 to the temporary view of x_3 which contains the partition below the dotted crossline. Then, the symbol $*$, which connects this evaluation with the path condition $x_1 \vee x_2$, is interpreted as intersecting the obtained partition with the true-indexed block drawn with dashed lines. The previous evaluation of the symbol \vee in the path condition is according to a comprehensive definition applicable to any n -ary operator, boolean and non boolean, and discussed in Section 6.

Likewise, the *FlowTracker* evaluates the other subterm. Finally, evaluating the symbol $+$, the *FlowTracker* combines the two partitions, one for each of the considered subterms, by a union of the two respective sets of blocks, which are those in the grayly shaded area. The set union corresponds to the partner's considering each of the two alternative paths in line 7 as a potential candidate for the actual execution path. If the partner observes the actual value of x_5 and then uses the partition in the grayly shaded area, he may figure out the actual path due to the domains of B and C being disjoint, but this is not necessarily so.

7. Evaluation of harmlessness by CIECensor. Provided by the *FlowTracker* with the tentative addition, for declassification the *CIECensor* checks whether the *combined information content* of the tentative addition resulting from preceding processing and the previous view resulting from the history could possibly violate the *confidentiality policy*. In abstract terms, this combination is obtained by taking all nonempty intersections of a block in (the partition of) the tentative addition with the previous view, and a *possible violation* occurs if there is a block in the combination that is *completely contained* in an element of the confidentiality policy. If the check confirms harmlessness, the previous view is updated to its intersection with the actual block and the declassification processed without filtering and modifying.

Otherwise, such a harmful situation can be described by a non-empty *security configuration* which the *CIECensor* will use for generalization of the value to be declassified.

Definition 1 (Security configuration, cf. [11]) Let $(\mathcal{B}_w)_{w \in R'}$ be an R -indexed partition of \mathcal{AIS} , let $\text{prev} \subseteq \mathcal{AIS}$ be the previous view and let $\text{pol} \subseteq \mathcal{P}(\mathcal{AIS})$ be a confidentiality policy. Then, the security configuration \mathcal{SC} consists of the domain R' and a set V (violating sets) of sets $I \subseteq R'$ of block indices defined by the condition

$$\text{exists } \mathcal{S} \in \text{pol} \text{ such that } \bigcup_{w \in I} \mathcal{B}_w \cap \text{prev} \subseteq \mathcal{S} \text{ and there is no such } I' \text{ with } I' \supset I.$$

Example 8 In line 8 in the program of Example 2 the value of x_5 is declassified to x_6 , being prepared by the *FlowTracker*'s computation of the temporary view for x_5 , the partition in the grayly shaded area of Figure 3. For this declassification, the *CIECensor* determines the security configuration secret-wise for the policy in Example 1.

$$- \mathcal{S}_1 = \{(id, A, B, c_1) \mid A \in \text{dom}(A), B \in \text{dom}(B)\}:$$

There is no block in the partition for x_5 completely contained in \mathcal{S}_1 .

- $\mathcal{S}_2 = \{(id, A, B, c_2) \mid A \in dom(A), B \in dom(B)\}$:
The blocks indexed by (A, c_2) with $A \in dom(A)$, in the right upper corner of the diagram, each are contained in \mathcal{S}_2 and even so is their union.
- $\mathcal{S}_3 = \{(id, A, b_2, c_3) \mid A \in dom(A)\}$:
There is no block contained in \mathcal{S}_3 , but each of the blocks $\{(id, A, b_2, c_1), (id, A, b_2, c_3)\}$ with $A \in dom(A)$ consists only of states containing confidential information as defined by \mathcal{S}_1 and \mathcal{S}_3 together.

Gathering these results, we obtain the security configuration $SC = (R', \{\{(A, c_2) \mid A \in dom(A)\}\})$ where its domain R' is the set of all possible block indices, i.e., $\{(A, B) \mid A \in dom(A), B \in dom(B)\} \cup \{(A, c_2), (A, c_4) \mid A \in dom(A)\}$.

Somehow counter-intuitively, the block indices (A, b_2) with $A \in dom(A)$ are not to be found among the violating sets of SC because the knowledge represented by each of the indexed blocks includes that one of \mathcal{S}_1 and \mathcal{S}_3 holds, but not which of them. If the CIECensor included these indices, it might mistakenly detect a policy violation. Due to the security configuration being non empty we conclude that there is a potential policy violation so that the censor must possibly generalize the value of x_5 before its declassification.

The meaning of a set I in a security configuration, considering the context of a declassification $decl(x_{src}, x_{dest})$, is that knowing the value of x_{src} is in I enables the partner to infer that a confidential piece of information \mathcal{S} is contained in the actual abstract information state. In this sense, a set $I'' \subset I$ stands for more specific knowledge which is harmful if I is, so that it is omitted from the respective security configuration.

Example 9 Continuing the previous example, we see that from knowing that the value of x_5 is in $I = \{(A, c_2) \mid A \in dom(A)\}$ the partner might conclude that the actual abstract information state is in the union of the respective blocks, viz. $\bigcup_{(A, c_2) \in I} \{(id, A, B, c_2) \mid B \in dom(B)\}$, and hence that the secret \mathcal{S}_2 holds. Each of the blocks in this union represents more specific knowledge which as such leads the partner to the same conclusion.

With simple set-theoretic arguments we obtain a more concise declaration of the security configuration.

Proposition 1 The security configuration of Definition 1 can be rewritten to $(R', \{I_{\mathcal{S}} \mid \mathcal{S} \in pol \text{ with } I_{\mathcal{S}} = \{w \in R' \mid \mathcal{B}_w \cap prev \subseteq \mathcal{S}\} \text{ and } I_{\mathcal{S}} \neq \emptyset\})$.

To determine the configuration algorithmically, for each secret in pol we need to iterate through R' instead of searching $\mathcal{P}(R')$ for the maximal sets I described by Definition 1.

8. Filtering and modifying by generalization. If the CIECensor on checking the security configuration finds it not empty, which indicates a possible policy violation, the CIECensor considers whether there would be an *actual violation*. Clearly, this is the case if the block that corresponds to the actual value, combined with the previous view, is contained in a policy element, and thus this value may not be revealed. However, to avoid meta-inferences such a hiding has to be made *indistinguishable* from the treatment of at least one different value. Accordingly, the CIECensor has to apply a precomputed *distortion table*, as exemplified in [11], that (i) clusters possible values such that the union of their blocks is not contained in any policy element and (ii) determines for each cluster a suitably *generalized value*, similarly as for k -anonymity.

Definition 2 (Distortion table) Let R be a finite subset of $Vals$. Then a distortion table over R is a function $dt : (\{R' \in \mathcal{P}(R)\} \times \mathcal{P}(\mathcal{P}(R') \setminus R')) \times R \rightarrow R$ such that

1. for all $R' \in \mathcal{P}(R), v \in R$ it holds $dt((R', \emptyset), v) = v$;
2. for all row indices ri of the form $(R', V) \in \mathcal{P}(R) \times \mathcal{P}(\mathcal{P}(R') \setminus \{R'\})$ and $v \in R$ such that $\{w \in R \mid dt(ri, w) = v\} \cap R' \neq \emptyset$ there does not exist $I \in V$ such that $\{w \in R \mid dt(ri, w) = v\} \cap R' \subseteq I$.

Applying the distortion table then means that the *CIECensor*, after it has determined a security configuration SC of Definition 1, looks up the generalized value of $v \in R$ as $g = dt(SC, v)$. All values w with $dt(SC, w) = g$ form a cluster as stated by (i) above Definition 2 and ensured by the definition of the distortion table and the security configuration. After generalization, the *CIECensor* updates the previous view with the partition derived from the clustering and returns the generalized value to the destination variable of the declassification assignment.

Example 10 Reconsider the security configuration $(R', \{(A, c_2) \mid A \in dom(A)\})$ from Example 8 denoted by SC_1 . The *CIECensor* determines this configuration for the declassification of x_5 . For this configuration a distortion table may contain the following row

security configuration	value to be declassified							
	...	(a_n, b_m)	(a_1, c_2)	...	(a_n, c_2)	(a_1, c_4)	...	(a_n, c_4)
SC_1	...	(a_n, b_m)	(a_1, g_C)	...	(a_n, g_C)	(a_1, g_C)	...	(a_n, g_C)

If the value of x_5 was (a_1, c_4) , which is actually harmless, the *CIECensor* would generalize it to (a_1, g_C) to hide the harmful value of (a_1, c_2) behind the same output. Afterward, it would set the previous view to $\{(id, a_1, B, c_2), (id, a_1, B, c_4) \mid B \in dom(B)\}$. The *CIECensor* returns other harmless values ungeneralized such as (a_n, b_m) .

Section 5 will present an example for a method to compute the generalization of a value given the security configuration without explicitly storing such a table, but a generalization hierarchy over R as inspired by generalization schemes for k -anonymity [17].

As part of the *programming discipline*, the set of possible return values of a basic information reaction and the set of (crucial) values of external reactions (depending on the abstract information state) has to be kept suitably small to manage the computation of the distortion table. Here, we greatly simplify this challenge by requiring that such a finite set R of crucial values indeed exists. To enable further processing of generalized values within the *open realm*, all operators used in the program have to be suitably *redefined* by overloading. However, we will abstract from this aspect in this work.

3. Implementing and specifying the mediator framework

In this section, by a Java-based exemplary instantiation of the framework we will first illustrate how all parts of the framework are to be combined and work together to realize the desired mediator. In particular, we illustrate how the mediator synchronizes program execution with dynamic tracking by the FlowTracker and declassification by the *CIECensor*. Moreover, to prepare for a formal verification

of the framework, we will describe the mediator's behavior by runs of the considered system Sys as introduced in the scenario description of Section 2. Based on the mediator-side run specification, we will then consider the cooperation partner's capabilities as a worst case as those of a more powerful observer whose behavior we will define as part of these runs. In particular, we consider the partner's reasoning as the observer's knowledge operator \mathcal{K} which we will define in Section 3.3.

3.1. Implementation in Java using Paragon

A leading idea behind the design of the framework is to base on established technologies such as language-based information flow control and symbolic execution in order to facilitate a holistic control as anticipated in Section 2. In this subsection, we overview a Java-based implementation of the framework, conducted in a master thesis [27]. This overview first demonstrates along Figure 4 how to instantiate the framework with a basic utilization of existing program libraries including such for the mentioned technologies. This instantiation reveals challenges incurred in any implementation of the framework and suggests respective, preliminary solutions. Second, this overview demonstrates along Figure 5 how the mediator's components generally work together. The aim of their joint functioning is to ensure confidentiality as stated in Property 1. As a basis for its verification, we finally formalize the framework as a system of runs in the next two subsections.

Instantiation. As a first major task, a *developer* implements a program for the intended service of the mediator in a programming environment which consists of the *mediator template* with the abstract-information-program interface and libraries of `.pi` files for the Java-based language *Paragon* with its own compiler. Supporting the developer's task, this compiler ensures Item 1 (Isolation) and Item 2 (Sharing) by rejecting programs that release information from the abstract information state otherwise than through a designated declassification method. To this end, methods offered by the mediator template are annotated with *flow policies* of Paragon to specify the permitted information flow accordingly while the PI library (**Paragon Interface**) does likewise for a basic selection of the Java API.

A challenge regarding the setup of the programming environment is that the Paragon compiler does not support all Java features, see [12,1], and the PI library is limited so that the full framework could only be written in Paragon with much effort if at all. Instead the framework is preliminarily reduced to its main functionality, the interface-wise access to the abstract-information state and the interplay of the control components, as method stubs in the mediator template. A further challenge is to utilize the `.pi` file from the compilation of the program to identify fragments processed in the protected realm in an automated manner and to put the execution of such fragments under control of the dynamic monitor, consisting of FlowTracker and CIECensor.

As a second major task, *the information owner*, or a security engineer on his behalf, stipulates partner-specific definitions, the confidentiality policy `pol` and the partner's background `prev`. These are persisted in a *data-store* to enable Item 3 (History-based policy compliance).

The further major tasks are performed by compilers designed for the framework in an automated manner, also using Java CC which generates compiler code from a grammar in BNF. First, for Item 4 (Flow tracking) fragments of protected realm processing are identified, following the flow policies which are derived by the Paragon compiler from flow policies initially annotated by the developer and which are then added by the compiler into the `.pi` file for the program. To synchronize the FlowTracker with the program, FlowTracker calls are inserted into the code just before each fragment. To allow the FlowTracker to read variables of the program, the code of the program is filled into a program template and transformed by substituting program variables with object fields. This way we basically deal with the Java-inherent

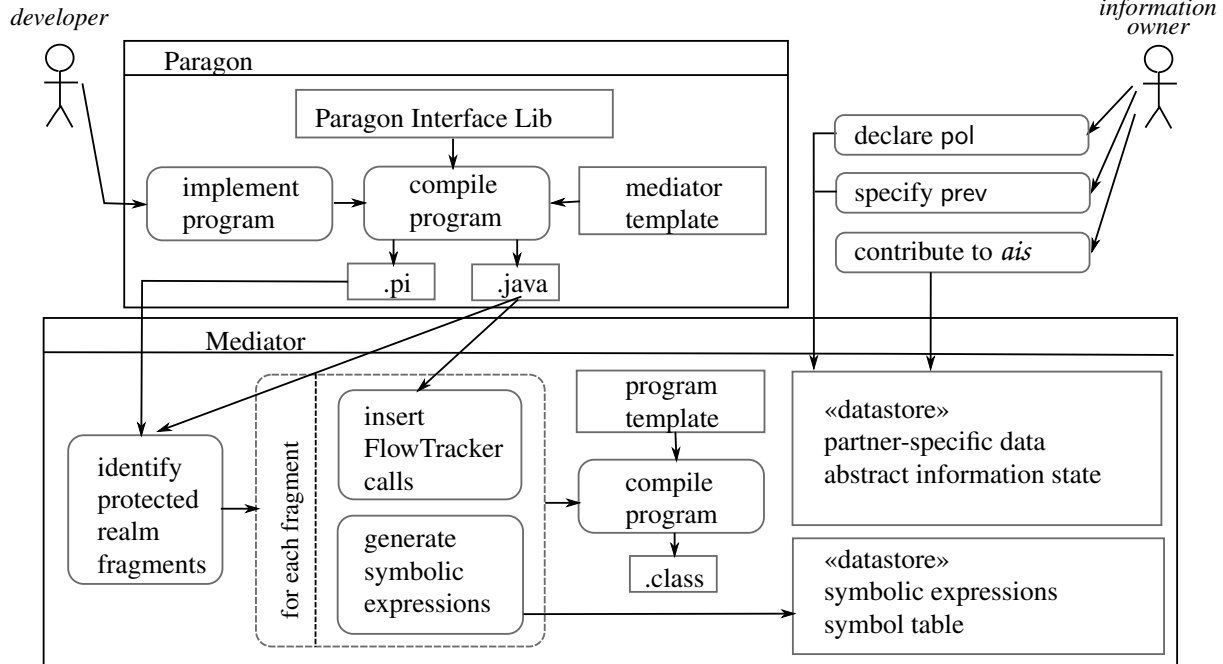

Figure 4. Instantiation of the mediator framework in a Java programming environment

challenge that only the program is allowed access to its method stack where program variable values reside, whereas object fields reside in the object heap which may be principally shared by all threads.

Second, for flow tracking according to Item 5 (Implicit flows) the manipulation of each high variable by a protected realm fragment is encoded into a respective symbolic expression. Symbolic expressions are kept in the data-store with an index on an identifier of the respective fragment together with a symbol table to look up the initialization of each symbol during the mediator's working phase. An advantage of shifting the determination of symbolic expressions from the mediator's working phase to compile time is that it may save computational effort during the mediator's working phase. Especially, this should be the case if the compiler tested whether a symbolic path condition is not satisfiable to eliminate the term connected to this path condition. Such satisfiable tests involve high computational costs at compile time, but reduce the computational costs for interpreting symbolic expressions during the working phase. In this article, however, such optimizations by satisfiability testing are not further treated.

This task completes the instantiation of the framework which is run with a library for its full functionality in place of the mediator template. To realize this functionality, a noteworthy challenge is that for declassifying the value of a variable, not only the value, but also the variable identifier is needed by the CIECensor to obtain the temporary view of that variable according to Item 6 (Tentative addition) and Item 7 (Harmlessness). A significant challenge is that generalized primitive data types in Java must be defined and the associated operators overloaded according to Item 9 (Generalization). For our basic instantiation of the framework, we avoided the last challenge by converting such types into Strings whenever data are transferred from the program to framework components.

Communication among components. In our Java-based implementation, the cooperation partner poses his requests, to be handled by the mediator, to an instance of the class Mediator in step 1 of Figure 5 and the Mediator instance in response initiates the run of a program specified in the request by an identifier *Pid*, e.g. a URL. Such an identifier may select one among several programs each designed for the

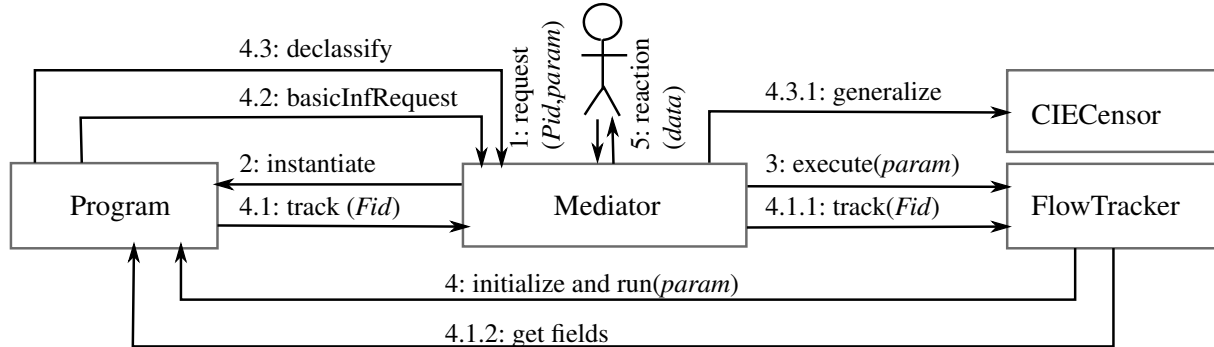

Figure 5. Communication among components of the instantiated framework

processing of a specific request type. As shown previously in Figure 2, the components of the dynamic monitor are to be isolated from the program to prevent their manipulation by its developer. Therefore, the Mediator works as a proxy of these components according to the following standard steps.

In step 2, the Mediator loads the class Program, as selected by *Pid*, and instantiates it binding to the new instance the symbolic expressions and related symbol tables in the data-store. Then, in step 3, the Mediator hands over execution to the FlowTracker to let it synchronize with program execution. Accordingly, in step 4 the FlowTracker sets fields of the Program instance to parameter values from the request and runs the Program. During this run, the Program synchronizes with the FlowTracker via its proxy, the Mediator, in step 4.1, right before a protected realm fragment with identifier *Fid* as determined during compilation. For synchronization, the track message activates the FlowTracker in step 4.1.1 which may access program variables through getters of object fields in step 4.1.2. Moreover, during its run, the Program first accesses the abstract information state in step 4.2 and then declassifies values via the Mediator in step 4.3 which hence calls the CIECensor for value generalization in step 4.3.1.

3.2. Specification of the mediator

Now, we leave the specific instantiation illustrated in Figure 5 and provide a general pattern for the mediator, including its dynamic monitor, with the aim of achieving and verifying Property 1 (Confidentiality Preservation). We give this pattern in form of a run specification, which on the one hand defines the general functioning of the desired mediator. In view of the exemplary instantiation, this functioning is the joint functioning of the four classes Mediator, Program, CIECensor and FlowTracker (and thus, in particular, is more comprehensive than the Mediator class which mainly serves as a proxy for isolating the other classes from one another).

On the other hand, this run specification defines an observer of the mediator's activities with more powerful means than the cooperation partner presumably has as an attacker against the confidentiality policy, as illustrated in Figure 6 and explained in this section. In Section 4, we will formally prove that the mediator, if instantiated according to pattern of this run specification, achieves Property 1 (Confidentiality Preservation) which has been introduced in Section 2 and is now formalized by this specification.

The mediator's behavior is defined by runs as functions from time \mathbb{N}_0 to its state which consists of three sub-states, namely IP for interaction processing, C for the CIECensor and FT for the Flow Tracker. In the interaction processing state $IP = \langle p \mid mem \mid ais \rangle$ the mediator prepares the reaction according to a request from the partner, executing program *p* on the current memory *mem* and the fixed abstract

information state $ais \in \mathcal{AIS}$. The memory is a function $mem : \text{Vars} \rightarrow \text{Vals}$ and its low projection mem_{low} is the restriction of this function to low variables.

Aiming at a unified approach to control, we do not select a specific programming language, but consider a language LIP as some (inductively defined) set of well-formed programs, including the empty program ϵ . We do not further specify this language, but only assume that it is interpreted by a one-step semantics defined as a function $eval : LIP \times (\text{Vars} \rightarrow \text{Vals}) \times \mathcal{AIS} \rightarrow LIP \times (\text{Vars} \rightarrow \text{Vals}) \times \mathcal{AIS}$, see [21] for examples. Moreover, we assume that every sequence of successive applications of this function converges to a result (ϵ, mem_n, ais) in a finite number n of steps (termination assumption), and further that (p, mem, ais) uniquely determines this result (determinism assumption). Lastly, we assume that basic information requests are included in LIP as a command of the simplified form $br_{para}(x)$, where $para$ is a meaningful parameter, such as the query kinds “select” and “project” in Example 2, and each of them is interpreted by an evaluation function $eval(br_{para}) : \text{Vals} \times \mathcal{AIS} \rightarrow R$ to the finite subset R of Vals .

The CIECensor operates on its state $C = \langle prev \mid pol \mid dt \rangle^3$ and the FlowTracker on its state $FT = \langle tempvs \mid st \mid sli \rangle^3$ as outlined in Section 2 and summarized in the following in the context of interaction processing. Table 1 defines the initialization and then inductively the subsequent state of the mediator in a run r at time $t + 1$ according to the first case listed in the table which applies to the precondition given for $r(t)$. Each such precondition requires a specific form of the components of sub-states of the mediator in $r(t)$. In the postcondition for $r(t + 1)$, only components of the mediator which change are displayed, others are omitted.

At initialization, the program variables and all fragments of program p are assumed to have security levels according to Item 1 (Isolation) and Item 2 (Sharing) of Section 2 induced by security level inference $sli(r, t) = \vdash_{\Gamma}$. The not formally stated set Γ defines the fundamental security levels of the output for the cooperation partner being low, the parameters to basic information requests being low and the basic information reaction from the abstract information state being high, as we have alluded in Item 1 (Isolation) in Section 2. After initialization, in case (1) (Start flow tracking), if interaction processing reaches a protected realm fragment, here a high-level prefix hp of the rest program $p(r, t)$, the mediator starts the FlowTracker which changes its status st from *idle* to *tracking*. While tracking, the FlowTracker cannot be called again according to the precondition in $r(t)$ for such a call. This way, the specified runs synchronize program execution and flow tracking at the start of protected realm fragments like the Java implementation in Section 3.1 does.

By means of a still unspecified function $trans$, the FlowTracker extracts symbolic expressions from the program prefix hp , one for each high-level variable manipulated by the prefix. This extraction could also take place at compile time as in Section 3.1 so that the FlowTracker would only look up the precompiled expressions. For each such high variable, while in status *tracking* the FlowTracker interprets these expressions to modify the temporary view $tempvs$ of the variable using a still unspecified function $eval$. For this interpretation, the FlowTracker might need the value of low-level program expressions and thus needs access to the program’s low memory mem_{low} . The two still unspecified functions $trans$ and $eval$ are introduced in Section 6. After the high-level fragment hp , the mediator inserts the command $stopFT$ which stops the FlowTracker.

³ with the components: previous view $prev$, confidentiality policy pol , distortion table dt , temporary views $tempvs$, status st , security level inference sli .

⁴ For the sake of simplicity, the notation just indicates the use of an appropriate level inference \vdash_{Γ} , but is not accurate about the representation of the security levels for subprograms and expressions of the mediator program p . These levels are usually derived by means of \vdash_{Γ} during compilation of the complete mediator program.

Table 1

Inductive specification of the mediator in a run r in terms of the precondition and postcondition of the state transition

Initialization	
	System parameters: $p \in LIP$ mediator program, \mathcal{AIS} set of abstract information states, $pol \subseteq \mathcal{P}(\mathcal{AIS})$ confidentiality policy, $dt : (\{R' \in \mathcal{P}(R)\} \times \mathcal{P}(\mathcal{P}(R') \setminus R')) \times R \rightarrow R$ distortion table over a fixed, finite range R of values from $Vals$, \vdash_{Γ} security level inference over LIP , ⁴ and mem^0 a mapping from $Vars$ to fixed default values and program arguments
$r(0)$	$IP(r, 0): p(r, 0) = p, mem(r, 0) = mem^0, ais(r, 0) = ais$ for some $ais \in \mathcal{AIS}$ $C(r, 0): prev(r, 0) = \mathcal{AIS}, pol(r, 0) = pol, dt(r, 0) = dt$ $FT(r, 0): tempvs(r, 0) = tempvs^0$ where $tempvs^0(x) = (\mathcal{AIS}_v)_{v \in \{mem^0(x)\}}$ for all $x \in Hvars$ $st(r, 0) = idle, sli(r, 0) = \vdash_{\Gamma}$ ⁴
Tracking of protected realm processing	
(1) Start flow tracking	
$r(t)$	$p(r, t) \equiv hp; lp$ where $hp : high, lp : low$ and for any other such sequence $hp'; lp'$ the subprogram hp' is a prefix of hp $st(r, t) \equiv idle$ $tempvs = eval(trans(hp, \vdash_{\Gamma}))(tempvs(r, t), mem_{low}(r, t))$ ⁴
$r(t+1)$	$IP = eval(\langle hp; stopFT; lp \mid mem(r, t) \mid ais(r, t) \rangle)$ $FT = \langle tempvs \mid tracking \mid \vdash_{\Gamma} \rangle$ ⁴
(2) Stop Flow Tracking	
$r(t)$	$p(r, t) \equiv stopFT; restp$
$r(t+1)$	$IP = \langle restp \mid mem(r, t) \mid ais(r, t) \rangle$ $FT = \langle tempvs(r, t) \mid idle \mid \vdash_{\Gamma} \rangle$ ⁴
Declassification	
(3) Generalize value by CIECensor	
$r(t)$	$p(r, t) \equiv decl(x_{src}, x_{dest}); restp$ where $x_{src} \in Hvars, x_{dest} \in Lvars$ $(prev, g) = censor(C(r, t), tempvs(r, t)(x_{src}), mem(r, t)(x_{src}))$
$r(t+1)$	$IP = \langle restp \mid mem(r, t)[x_{dest} \mapsto g] \mid ais(r, t) \rangle$ $C = \langle prev \mid pol \mid dt \rangle$
(4) Forward value uncensored	
$r(t)$	$p(r, t) \equiv decl(x_{src}, x_{dest}); restp$
$r(t+1)$	$IP = \langle restp \mid mem(r, t)[x_{dest} \mapsto mem(r, t)(x_{src})] \mid ais(r, t) \rangle$
(5) Interaction processing	
$r(t+1)$	$IP = eval(IP(r, t))$

In case (2) (Stop flow tracking), the FlowTracker's status is reset to *idle* by the special command *stopFT* so that it may be called again for tracking in case (1). In case (3) (Generalize value by CIECensor), the CIECensor is called as a function *censor* for the declassification of a high-level variable and computes a possibly generalized value $g \in R$ and an element in $\mathcal{P}(\mathcal{AIS})$ for the previous view. The func-

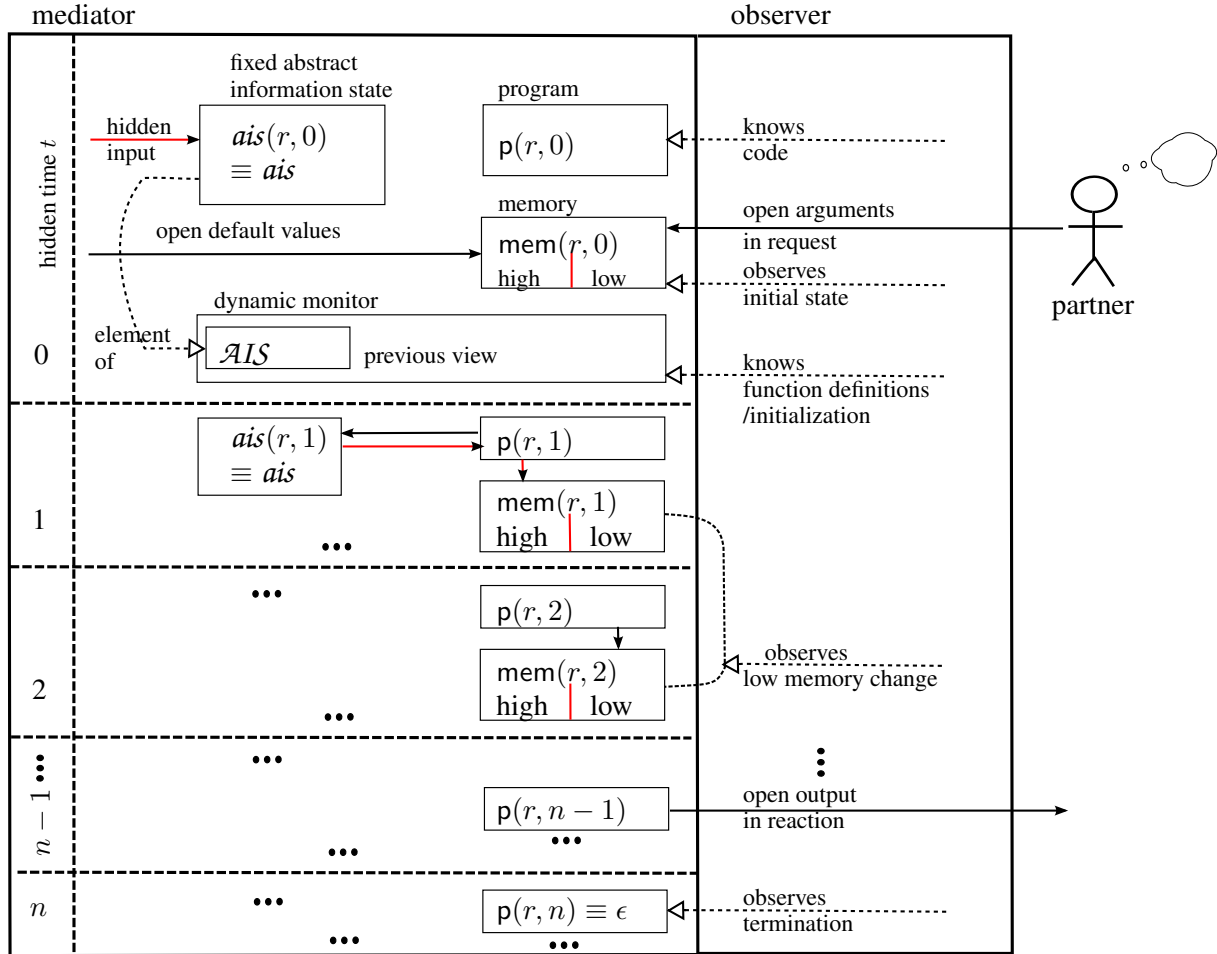

Figure 6. The mediator’s functioning as perceived by the observer in system \mathcal{S}_{ys} , as a worst case scenario for the cooperation partner’s options of inference as an attacker against the confidentiality policy

tion censor is introduced in Section 4. The fourth and fifth case include a special case of declassification and general interaction processing by program execution, respectively.

3.3. The observer representing the partner as an attacker

As part of the system \mathcal{S}_{ys} we specify the state transitions of an observer which has presumably more powerful means than the partner as illustrated in Figure 6. The observer has fundamental, initial knowledge to reason about the mediated abstract information state, namely the system parameters as listed in Table 1 and the system’s specification \mathcal{S}_{ys} . Note that contrary to other work the observer knows the initial memory. The initial memory is set to default values and program arguments, but is not dependent on the mediated abstract information state which is the only target of the confidentiality policy in this article. Moreover, the observer might perceive the mediator’s behavior according to the transition function of its state O in a run r as defined in Table 2.

Based on the mediator-side specification of a run r , this table defines a sequence of observable events $O(r, t + 1)$ inductively for the mediator’s internal time t as sketched in Figure 6. Starting with the obser-

Table 2

Inductive specification of the observer in a run r in terms of the precondition on the mediator's state and the postcondition for the next observed event

Initialization		
$r(0)$	$O(r, 0)$	$= \text{mem}(r, 0)$
(1) Low memory change		
$r(t)$	the active command in $p(r, t)$ assigns v to $x \in \text{Lvars}$ with $v \neq \text{mem}(r, t)(x)$	
$r(t + 1)$	$O(r, t + 1)$	$= O(r, t).(x, v)$
(2) Termination		
$r(t)$	$p(r, t)$	$\equiv \epsilon$
$r(t + 1)$	$O(r, t + 1)$	$= O(r, t).\text{End}$
(3) No observation		
$r(t + 1)$	$O(r, t + 1)$	$= O(r, t)$

variation of initial memory, inductively the next possible observation at time $t + 1$ is appended to $O(r, t)$ according to the first case listed of which the precondition on the mediator's state holds in $r(t)$. More specifically, the observer is informed about progress of computation by the mediator through changes of low memory in case (1) or termination in case (2), including completion of the reaction stored in a low variable and sent to the partner. But neither is the observer informed about changes in high memory nor about the mediator's internal clock, the time t .

However, being rational the observer could infer information about high memory changes, or the mediator's internal time, and about the abstract information state. We suspect that the observer, being curious and a semi-honest attacker against the policy, intends to infer pieces of confidential information being contained in this state. These inferences are derived by the knowledge operator \mathcal{K} on \mathcal{AIS} defined by O in \mathcal{Sys} , analogously as for example in [4],

$$\mathcal{K}(r, t) = \{ \text{ais} \in \mathcal{AIS} \mid \text{exists run } r' \in \mathcal{Sys} \text{ and time } t' \in \mathbb{N}_0 \text{ such that} \\ \text{ais}(r', 0) = \text{ais} \text{ and } O(r', t') = O(r, t) \}. \quad (1)$$

Applying its initial knowledge about the system, the observer can consider all runs which agree with the observed sequence of events, and rule out the others as possible runs. By such considerations, the observer may also gain information about high memory and the mediator's internal time, but they are not the target of its reasoning as an attacker against the confidentiality policy.

By ruling out possibilities, the observer can narrow down the set of candidates for the actual abstract information state after each observation and does not forget previous observations so that it possibly extends its knowledge over the time, i.e., for $t_{\text{after}} > t_{\text{before}}$ it holds $\mathcal{K}(r, t_{\text{after}}) \subseteq \mathcal{K}(r, t_{\text{before}})$ (monotonicity of knowledge). We may understand the confidentiality requirement $\mathcal{K}(r, t) \not\subseteq \mathcal{S}$ for each $\mathcal{S} \in \text{pol}$ in Property 1 now as follows: the partner as the observer should be sure about the possibility of the confidential piece \mathcal{S} of information not being contained in the actual abstract information state.

Algorithm 1 CIECensor**Input:** CIECensor state $\langle \text{prev} \mid \text{pol} \mid \text{dt} \rangle$, partition $(\mathcal{B}_w)_{w \in R'}$, value $v \in R$ **Output:** View $\text{view} \subseteq \mathcal{AIS}$, value $g \in R$ **Actions:**Determine security configuration SC by Definition 1 using $(\mathcal{B}_w)_{w \in R'}$, prev and pol Set $g := \text{dt}(SC, v)$ Set $\text{view} := \text{prev} \cap \text{IAI}((\mathcal{B}_w)_{w \in R'}, \text{dt}, SC, g)$ to be defined in (2) below**4. Confidentiality enforcement by the CIECensor**

First of all, by way of example we detail the actions taken by the CIECensor according Algorithm 1 to follow the observer's inferences and to block them. After that we discuss and prove that these inferences are effectively blocked by design of the CIECensor and the distortion table if declassification is the only means to transfer information from a variable x_{src} in the protected realm to a variable x_{dest} in the open realm (gradual release as Property 2) and the temporary view of x_{src} provided by the FlowTracker has the intended semantics.

Example 11 *First, the CIECensor, summarized in Algorithm 1, determines the pertinent security configuration of Definition 1. To do so, it principally considers all $I \subset R'$ and tests whether the observer knowing that x_{src} has a value in I could infer a confidential piece S of information. Among all sets I with a positive test the CIECensor determines maximal supersets and collects them in the security configuration SC of Definition 1.*

Then, the CIECensor possibly generalizes the declassified value v , using the previously computed security configuration, here $SC_1 = (R', \{\{(A, c_2) \mid A \in \text{dom}(A)\}\})$ from Example 8. The means of generalization is a distortion table of Definition 2 which given the observer's inference options as represented by SC_1 blocks them by appropriate generalization. To illustrate this blocking, we reconsider the distortion table from Example 10, repeated below for convenience, on the row index SC_1 . With this table, by a lookup in the row indexed by the security configuration the CIECensor generalizes the value (a_1, c_2) to the value (a_1, g_C) as it would do with (a_1, c_4) .

security configura- tion	value to be declassified							
	...	(a_n, b_m)	(a_1, c_2)	...	(a_n, c_2)	(a_1, c_4)	...	(a_n, c_4)
SC_1	...	(a_n, b_m)	(a_1, g_C)	...	(a_n, g_C)	(a_1, g_C)	...	(a_n, g_C)

If the observer knows the security configuration and observes the value (a_1, g_C) for x_6 in line 8 in the code of Example 2, then it can infer that the original value of x_5 was one of $\{(a_1, c_2), (a_1, c_4)\}$, reconstructing the preimage of (a_1, g_C) in the table in row SC_1 . This inference is harmless since that inferred set of possible values is not contained in the only violating set of SC_1 . By construction, this violating set and all of its subsets are the sole sets of possible values for x_5 whose disclosure reveals a confidential piece of information.

Finally, the CIECensor adds to the previous view prev the observer's knowledge gained by disclosure of the generalized value. This knowledge gain is being investigated in the following.

Which knowledge the observer could gain about the abstract information state from a single value observed as a low memory change of a variable x is represented by an R -indexed partition $(\mathcal{B}_w)_{w \in R'}$ for

that variable. Knowing the value $w \in R'$ of x , the observer could know that this state is in the set \mathcal{B}_w . Evidently, the observer could gain knowledge from an inference of possible values for the source variable in a declassification, but usually less precise knowledge than from a single, definite value. As illustrated in Example 11, the inferred set of possible values should be the preimage of the generalized value g and entails the knowledge that takes into account all possibilities and is represented by the following set of *inferred abstract information* states.

$$IAI((\mathcal{B}_w)_{w \in R'}, dt, SC, g) = \bigcup_{w \in R': dt(SC, w) = g} \mathcal{B}_w \quad (2)$$

But that this set indeed represents the observer's knowledge gain from value g needs three further steps of justification.

In the first step, the FlowTracker must be designed and verified to compute temporary views correctly according to the intended meaning of a block \mathcal{B}_w , at least at the time of declassification.

Property 3 (Correctness of flow tracking) *Let r be a run with abstract information state ais and $t \in \mathbb{N}_0$ a time such that $p(r, t) \equiv \text{decl}(x_{src}, x_{dest})$; restp where restp might be empty. If $x_{src} \in \text{Hvars}$, then it holds*

1. x_{src} is in the domain of $\text{tempvs}(r, t)$,
2. the blocks $(\mathcal{B}_w)_{w \in R'} = \text{tempvs}(r, t)(x_{src})$ form a partition covering $\mathcal{K}(r, t)$,
3. $\text{mem}(r, t)(x_{src}) = v$ iff $ais \in \mathcal{B}_v$ in $\text{tempvs}(r, t)(x_{src})$.

Example 12 *Let us overview the situation of the FlowTracker in Example 7 which illustrates temporary view computation for the high variable x_5 of the program in Example 2. Take as the time t the program line's number which is being executed.*

The observer's initial knowledge $\mathcal{K}(r, 0)$ is AIS in Example 5, independently of the actual run r , and does not change during r until declassification in line 8 because until that line low memory is not affected. Each of these runs corresponds to one execution of the program until line 7 on arguments c_1 and c_3 based on a different state in AIS. In particular, there are $|\text{AIS}| = \text{dom}(A) \cdot \text{dom}(B) \cdot \text{dom}(C)$ many such runs.

In Example 7, the temporary view for x_5 in line 8 is the partition shown in the grayly shaded area in Figure 3. First, if we go through that example again, we notice that the FlowTracker's evaluation yielding this partition does not depend on the actual abstract information state, but on the values c_1 and c_3 . Moreover, we notice that the partition covers $\mathcal{K}(r, 7) = \text{AIS} = \{(id, A, B, C) \mid A \in \text{dom}(A), B \in \text{dom}(B), C \in \text{dom}(C) = \{c_1, c_2, c_3, c_4\}\}$ as required by Property 3 in its second point.

For the third point of Property 3, let us consider the state $ais = (id, a_1, b_2, c_1)$. On this state the if-branch is taken and finally in line 7 the value of x_5 becomes (a_1, b_2) . In the partition, shown in Example 7, this value points to the block $\{(id, a_1, b_2, c_1), (id, a_1, b_2, c_3)\}$ which indeed contains ais (left lower corner of the diagram). Thus, the block indexed by the actual value contains the actual information state. On the same way backwards, the block containing ais can be found out. Then, its index equals the actual value of x_5 . These two ways of correctly determining the block from the value looked up in memory, and the value from the index of the block looked up for ais in the partition, respectively, correspond to the two implications of the equivalence in the third point of Property 3.

In the second step, we should design an algorithm for temporary view computations by the FlowTracker in a way that does not enable the observer to extend its knowledge through these computations,

and should verify this property. Such an extension of knowledge would be difficult to determine for checking policy compliance. These computations can only be observed through their effects on value generalization during declassification, as they are otherwise isolated from interaction processing as specified in Table 1 and illustrated in Figure 2. Therefore, we require that in every run r the usage of the temporary view of x_{src} during declassification of x_{src} at time t will still let the observer consider a run r' as an alternative run of r , if the observer does so before the declassification at time t due to $O(r, t) = O(r', t')$. The simplest way to do so is to require that the FlowTracker computes the same temporary views in r' as it does in r .

Property 4 (Non-interference of flow tracking) *Let r, r' be runs, $t, t' \in \mathbb{N}_0$ times such that $p(r, t) \equiv p(r', t') \equiv \text{decl}(x_{src}, x_{dest}); \text{restp}$, where restp might be empty, and $O(r, t) = O(r', t')$. Then, it holds*

- the domains of $\text{tempvs}(r, t)$ and $\text{tempvs}(r', t')$ are both Hvars
- and $\text{tempvs}(r, t)(x) = \text{tempvs}(r', t')(x)$ for all $x \in \text{Hvars}$.

Example 13 *We are considering the observer's knowledge gain from the usage of the temporary view of x_5 in line 8 of the program of Example 2 during declassification. The observer at the start of a run may observe memory initialization in particular with the program arguments c_1 and c_3 . The system Sys , specified by Table 1 and Table 2, is set up with these parameters among others such as \mathcal{AIS} so that it holds $O(r, 0) = O(r', 0)$ for all $r, r' \in \text{Sys}$. As until program line 8 with the declassification neither a low memory change nor a termination could be observed, it even holds $O(r, t) = O(r', t')$ for all $r, r' \in \text{Sys}$ and for all $0 \leq t, t' \leq 8$. In every run r for the considered program, according to Table 1, the FlowTracker works in three subsequent phases of tracking, which each contributes to the computation of $\text{tempvs}(r, 8)(x_5)$, the temporary view of x_5 used for declassification of x_5 in line 8: the first phase during the assignment in line 1 (as marked by the underlining), the second phase during the assignment in line 3 and the third and final phase during the sequence from line 5 until line 7. In each run, the final result of the temporary view for x_5 is the same as in every other run at time 7, and importantly at time 8 of declassification as Example 7 has illustrated. Therefore, Property 4 is satisfied in the discussed scenario.*

In Section 6, according to these two steps and the respective two declarative properties the temporary view computations of the FlowTracker will be detailed, based on an algorithmic approach similar to symbolic execution.

Finally, in the third step, taking Property 3 and Property 4 together, we are ready to prove that from a generalized value $g \in R$ the observer gains the knowledge described by (2) and nothing else if the temporary view of the source variable is $(\mathcal{B}_w)_{w \in R'}$ and harmful inferences of possible values are represented by SC . This claim is formally stated by the next theorem. Additionally, for its proof, we need correspondence relations between runs, defined in [4] and outlined in the appendix, by means of which declassification assignments in a pair of runs can be matched. Such correspondence relations may be constructed if the security level inference system adheres to the two rules, no-write-down and no-read-up (without declassification), sketched in Item 1 (Isolation) of Section 2.

Theorem 1 (Declassification under generalization) *Let Sys be as specified in Table 1 and Table 2, based on a security level inference system guaranteeing Property 2 (Gradual release) and Property 5 (No-read-up) and Property 6 (No-write-down), given in the appendix. Moreover, let the CIECensor of Sys use Algorithm 1 and the FlowTracker of Sys satisfy Property 3 (Correctness) and Property 4 (Non-interference). Let $r \in \text{Sys}$ be a run and t a time such that $p(r, t) \equiv \text{decl}(x_{src}, x_{dest}); \text{restp}$, where restp might be empty, and $x_{src} \in \text{Hvars}$ and $x_{dest} \in \text{Lvars}$. Moreover, let $g = \text{dt}(\text{SC}, u)$ with $u = \text{mem}(r, t)(x_{src}) \in R$. Then, it holds $\mathcal{K}(r, t + 1) = \mathcal{K}(r, t) \cap \text{IAI}(\text{tempvs}(r, t)(x_{src}), \text{dt}, \text{SC}, g)$.*

As a conclusion and summary, we argue and prove formally in Theorem 2 that by the three actions according to Algorithm 1 the CIECensor explores all the observer's options of inference and blocks them successfully. In the first action, the CIECensor by determining the security configuration captures all such options that are given through the disclosure of the generalized value g by declassification. The CIECensor identifies these options by inference tests of the form $\mathcal{B}_w \subseteq \mathcal{S}$ where \mathcal{B}_w is the knowledge gained by a value w , which may be generalized to g , and $\mathcal{S} \in \text{pol}$ is a confidential piece of information. The form of these tests is suggested by Proposition 1. In the second action, the CIECensor employs a distortion table which by design effectively blocks all options of the former kind by appropriate value generalization. In the third action, the CIECensor updates the observer's knowledge in the previous view correctly, as ensured by Theorem 1, and thus captures all options of inference based on the history of observed computation steps performed by the mediator. Therefore, we can prove confidentiality preservation based on the assumption that the confidentiality policy does not aim to protect what the observer, and hence the presumably less powerful cooperation partner, already initially knows, namely that the abstract information state is in \mathcal{AIS} .

Assumption 1 For all $\mathcal{S} \in \text{pol}$ it holds $\mathcal{S} \neq \mathcal{AIS}$.

Theorem 2 (Confidentiality preservation) Let Sys be as specified in Table 1 and Table 2 satisfying Property 2 (Gradual release), and Property 5 (No-read-up) and Property 6 (No-write-down), given in the appendix. Let the CIECensor of Sys use Algorithm 1 and the FlowTracker of Sys satisfy Property 3 (Correctness) and Property 4 (Non-interference). Suppose further that Sys adheres to Assumption 1. Then, Sys satisfies Property 1 (Confidentiality preservation).

5. Distortion tables by subtree generalization

As it is done for k -anonymity, to algorithmically obtain a distortion table we will use an order relation on values in which a value v_1 that is above another value v_2 in the order is more general than v_2 , whereas v_2 is more specific than v_1 . This way, the order should define a generalization hierarchy with a most general top value, such as the hierarchy shown in Figure 7. Formally, a generalization hierarchy is a partial order T on $R \times R$ such that its Hasse diagram is a tree with a designated root value ANY . Here, R is again a finite set of values on which the distortion table for the CIECensor must be defined. As already mentioned in Item 8 (Filtering and modifying) of Section 2, we assume that operators of the programming language LIP are overloaded for all non-primitive values in R , such as integer intervals as a generalization of integers which is often used for k -anonymization.

For an algorithmic definition of a distortion table dt , the idea is to design a scheme for determining a parent (or self) g of a value v in the generalization hierarchy given a security configuration and to define $\text{dt}(\mathcal{SC}, v) = g$. This scheme should ensure that the algorithmically defined table meets all requirements of a distortion table in Definition 2, and should select a most specific value g for a most informative reaction to the cooperation partner.

Example 14 We set aside our running example for a moment to present the main ideas of the proposed scheme. Consider a security configuration $\mathcal{SC} = (R', \{I\})$ as one of the two shown in subfigures (a) and (b) of Figure 7. A distortion table

- (i) should cluster values in R' such that none of the clusters is contained in I ,

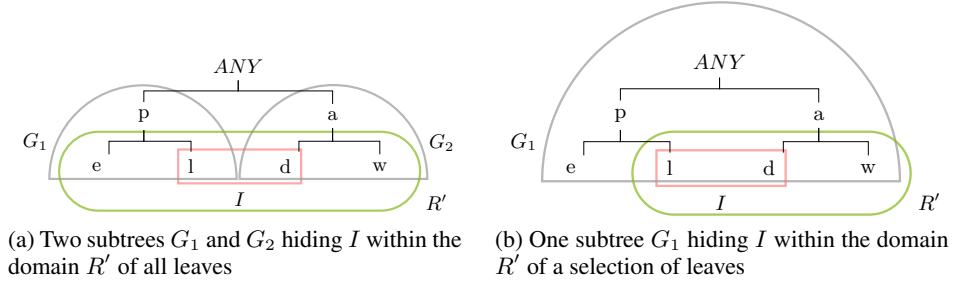

Figure 7. *SC*-subtree generalization schemes for a generalization hierarchy over $R = \{p(\text{rofessional}), e(\text{ngineer}), l(\text{awyer}), a(\text{rtist}), d(\text{ancer}), w(\text{riter})\}$

(ii) should cover the whole range R of values with possibly several such clusters, pairwise disjoint, and

(iii) should define a generalized value for each cluster.

As discussed in Section 4, each such cluster corresponds to the preimage of the respective generalized value, given the row index *SC* of the table.

An intuitive idea is to cluster all values of a subtree in the generalization hierarchy, and generalize all values in this cluster to the root value of the subtree. In the example hierarchy on the left, the values e, l, p of the subtree G_1 may be clustered and each of them generalized to p . In literature on k -anonymity, the subtree generalization scheme similarly generalizes all leaves of a subtree to its root, instead of generalizing only a selection of its leaves, see e.g. the survey [17].

The task now is to select subtrees as clusters such that all requirements in (i) and (ii) above are met, and to prefer selecting a subtree G contained in another subtree G' over selecting G' because G has a more specific root value than G' has. In the example hierarchy on the left, selecting G_1 is preferred over selecting the complete tree.

Recapitulating the requirements in (i) and (ii), we note that an algorithm, which defines a distortion table, should only explicitly form clusters which contain values of the violating set I because only for such clusters the requirement in (i) must be considered. Other clusters of values in R should each contain only one respective value which is mapped to itself by the distortion table, producing no information loss at all. Such clusters must not be explicitly constructed by an algorithm for the distortion table.

According to the previous considerations, the proposed scheme comprises the following steps.

- (I) Select disjoint subtrees as clusters, which each contains at least one value of I , such that the intersection of a selected subtree with the domain R' of *SC* is not contained in I .
- (II) Select as many such subtrees such that I is covered by the union of their values and not any selected subtree G may be replaced by one of its subtrees $G' \subset G$ without violating the previous requirements.
- (III) For each selected subtree, generalize all its values to its root, and map each value not contained in any subtree to itself.

In each of the two situations depicted in Figure 7, we may proceed by tentatively selecting each leaf with a value in I as a cluster. If a tentatively selected subtree G violates the requirement in (I), we replace it with the subtree rooted in the parent of the root of G . We proceed in this manner until all selected subtrees fulfill the requirement in (I). Finally, we remove all subtrees from the selection which are contained in

Algorithm 2 Subtree generalization

Input: Generalization hierarchy T over R , row index $SC \in \{R' \in \mathcal{P}(R)\} \times \mathcal{P}(\mathcal{P}(R') \setminus R')$, value $w \in R$

Output: Generalized value $g \in R$

Actions:

- 1: Determine an SC -generalization scheme \mathcal{G} of Definition 3
- 2: **if** exists $G \in \mathcal{G}$ such that $w \in G$ **then**
- 3: Set g to the root value of G
- 4: **else**
- 5: Set $g := w$
- 6: **end if**

another selected subtree. For the situation on the right, we see that neither the leaf l , nor the subtree rooted in p fulfill the requirement in (I), so that the complete tree is selected in the process. Note that the domain R' of the security configuration must not be limited to the leaf values of the hierarchy as it is in the figure.

Summarizing the above, by a SC -subtree generalization scheme we define a selection of subtrees according to the outlined steps (I) and (II) and use this selection, as in step (III), in Algorithm 2 to define a distortion table.

Definition 3 (SC-subtree generalization scheme) Let R be a finite subset of $Vals$, T a generalization hierarchy over R and $SC = (R', V) \in \{R' \in \mathcal{P}(R)\} \times \mathcal{P}(\mathcal{P}(R') \setminus R')$. An SC -subtree generalization scheme is a set $\mathcal{G} \subset \mathcal{P}(R)$ of sets G of values such that

1. every set G in \mathcal{G} forms a subtree of T
2. all sets in \mathcal{G} are pairwise disjoint
3. for all $I \in V$ there exists a selection $S \subseteq \mathcal{G}$ such that
 - (a) $I \subseteq \bigcup_{G \in S} G$
 - (b) and for all $G \in S$ it holds $G \cap R' \not\subseteq I$
4. \mathcal{G} is minimal among all such sets with respect to the order \leq on $\mathcal{P}(\mathcal{P}(R))$ defined by $\mathcal{G} \leq \mathcal{G}'$ iff for all $G \in \mathcal{G}$ there is $G' \in \mathcal{G}'$ such that $G \subseteq G'$.

We conclude this section by stating and proving that this way we indeed define a distortion table. The proof is in the appendix. A main step in the proof is that minimality of the selection implies that the selection is unique given the security configuration SC and the generalization hierarchy T . Hence, Algorithm 2 does not need to make a choice in line 1, but is deterministic, so that indeed it computes a function.

Proposition 2 Algorithm 2 computes a distortion table on $(\{R' \in \mathcal{P}(R)\} \times \mathcal{P}(\mathcal{P}(R') \setminus R')) \times R$ in the sense of Definition 2.

6. Operationalizing the FlowTracker

The main task of the FlowTracker is to determine the knowledge the observer gains about the abstract information state from a value w of high variable x as this value is finally set after the execution of a high-

level piece of program code. For this task, the FlowTracker inspects all execution paths of the considered program code, each path starting with the same, fixed low memory state, but a different, varied abstract information state. Through this inspection, the FlowTracker may identify all abstract information states on which the execution of the considered program code results in the specific value w for variable x . These states are collected in a block \mathcal{B}_w of the temporary view for x , so that from the value w of x the observer might only gain the knowledge that the actual abstract information state is in \mathcal{B}_w .

To inspect execution paths of a piece of program code, the FlowTracker translates this code to its execution tree, whose paths correspond to a set of execution paths, using a function $\text{transToET} : LIP \rightarrow LET$. While the programming language LIP has been introduced in Section 3.2, by LET we denote the set of all well-formed execution trees including the empty tree ϵ and defined below. However, it is not necessary that the FlowTracker inspects all execution paths one-by-one. Instead, the FlowTracker may abstract from execution paths to sets of execution paths, so that the members of each set are execution paths which result in the same gain of knowledge. This way, the FlowTracker aims to inspect the change of temporary views.

In our context, an execution tree should use assignments and branch conditions derived from the translated programming language LIP , so that assignments and branch conditions are expressed using m -ary operators from Θ_m , basic information requests from Π and query functions in Ω from the language LIP . Thereby, each query function tests a designated property of data objects and thus transforms any value taken from $Vals$ to a boolean value $\{true, false\}$ as the test result.

Definition 4 (Execution tree [3]) *An execution tree (ET) is a directed labeled tree $T = (N, E, C, L, Start)$ such that*

- N is a set of nodes labeled by assignments (from LIP),
- $E \subseteq N \times N$ is a set of control flow edges,
- C is a set of branch conditions which are boolean expressions from LIP as defined by

$$\begin{aligned} Bool &:= true \mid false \mid Q(Op) \mid Vars \mid Bool \text{ and } Bool \mid Bool \text{ or } Bool \mid \\ &\quad \text{not } Bool \mid (Bool) \end{aligned}$$

$$Op := O_m(Op, \dots, Op) \mid Vars$$

$$Q := \Omega \quad O_m := \Theta_m \text{ for } m > 1, \quad O_1 := \Theta_1 \cup \Pi,$$

- $L : E \rightarrow C$ is a mapping from edges to branch conditions,
- $Start \in N$ is the root node.

For a meaningful translation of programs, we assume that the one-step semantics of the program is preserved in the sense that for all $p, p_1 \in LIP$, $mem, mem_1 \in (Vars \rightarrow Vals)$, $ais \in \mathcal{AIS}$ such that $\text{eval}(p, mem, ais) = (p_1, mem_1, ais)$ it holds $\text{eval}(\text{transToET}(p), mem, ais) = (\text{transToET}(p_1), mem_1, ais)$ where execution trees, too, are provided with an appropriate one-step semantics as a function eval . For execution trees T generated this way the termination and determinism properties are inherited from the translated program.

The FlowTracker, however, does not execute the tree on memory and abstract information state, but encodes the manipulation of each high variable by the tree, following each of its paths, into a respective symbolic expression, in a way similar to symbolic execution, and interprets such an expression as a change of the temporary view for the respective variable. Symbolic execution is an active, exten-

Algorithm 3 Symbolic execution `transToSym`, adapted from [3]

Input: execution tree T , security level inference \vdash_{Γ} over LIP

Output: symbolic state `symb` : $Hvars \rightarrow SymExpr$,
symbolic initialization function `init` : $\Lambda \rightarrow Bool \cup Op$

Actions:

1: Depth-first traversal of T , assigning to each node n

(1) a path condition $pc(n) \in SymBool$ and

(2) a symbolic state $symb(n) : Hvars \rightarrow SymExpr$

2: Initialize $symb(Start)(x) = x$ for all $x \in Hvars$

Symbolic execution

3: Set $symb(n) := symb(p)$ for parent p of n in T

4: Set $bool$ as the branch condition of the edge from parent node p to node n in T

5: Set $symbbool := transToSym(bool, symb(p), init, \vdash_{\Gamma})$, determining `transToSym`
by Algorithm 4, possibly extending the domain of `init`

6: Set $pc(n) := pc(p) * symbbool$

7: Define $expr$ as in the assignment $x := expr$ of node n

8: Set $symb(n)(x) := transToSym(expr, symb(p), init, \vdash_{\Gamma})$, determining `transToSym`
by Algorithm 4, possibly extending the domain of `init`

After the traversal

9: Define $\{l_1, \dots, l_k\}$ as the set of all leaf nodes of T

10: For all $x \in Hvars$ set $symb(x) := pc(l_1) * symb(l_1)(x) + \dots + pc(l_k) * symb(l_k)(x)$

sive research field and provides many methods for optimization including parallelization and pruning of branches by satisfiability testing of symbolic expressions, e.g. [13,23] and to be investigated for this framework in the future.

During symbolic execution as defined by Algorithm 3, the FlowTracker introduces still uninterpreted symbols for basic information reactions and low level expressions involved in the manipulation of a high variable using Algorithm 4. Symbolic expressions represent alternative paths in dependence of the introduced symbols and in dependence of high variables, indicating branches of paths by $*$ and their joins by $+$, and have the following form:

$$SymExpr := SymExpr + SymExpr \mid SymBool * SymOp \mid SymOp$$

$$SymOp := O_m(SymOp, \dots, SymOp) \mid \Lambda \mid Hvars$$

$$SymBool := Q(SymOp) \mid SymBool \wedge SymBool \mid SymBool \vee SymBool \mid$$

$$\neg SymBool \mid (SymBool) \mid SymBool * SymBool \mid \Lambda \mid Hvars$$

$$Q := \Omega \quad O_m := \Theta_m \text{ for } m \geq 1$$

Example 15 We are considering the three phases of flow tracking for the protected realm fragments of the program in Example 2, the first being the underlined assignment in line 1, the second the like in line 3 and the third the underlined sequence from line 5 to line 7. If activated by the mediator in case (1) of Table 1, the FlowTracker extracts the respective fragment, translates the extracted code to its execution tree and executes Algorithm 3 and Algorithm 4 on that tree. Alternatively, the instantiation

Algorithm 4 Translation transToSym of expressions to symbolic expressions

Input: $expr \in Bool \cup Op$, symbolic state $\text{symb} : \text{Hvars} \rightarrow \text{SymExpr}$,
 global symbolic initialization function $\text{init} : \Lambda \rightarrow Bool \cup Op$,
 security level inference $\vdash_{\Gamma} : \text{Vars} \rightarrow \{\text{low}, \text{high}\}$

Output: symbolic expression $\text{symexpr} \in \text{SymExpr}$

Actions:

if $expr$ contains only variables $x \in \text{Lvars}$, but not a basic information request, or $expr = \text{br}_{para}(x)$
then
 Choose symbol α not used in init ; Set $\text{init}(\alpha) := expr$; Return α
else if $expr = x \in \text{Hvars}$ **then**
 Return $\text{symb}(x)$
else if $expr = \oplus(expr_1, \dots, expr_m)$ **then**
 Return $\oplus(\text{transToSym}(expr_1, \text{symb}, \text{init}, \vdash_{\Gamma}), \dots,$
 $\text{transToSym}(expr_m, \text{symb}, \text{init}, \vdash_{\Gamma}))$
else and so on according to the inductive definition of $expr$
end if

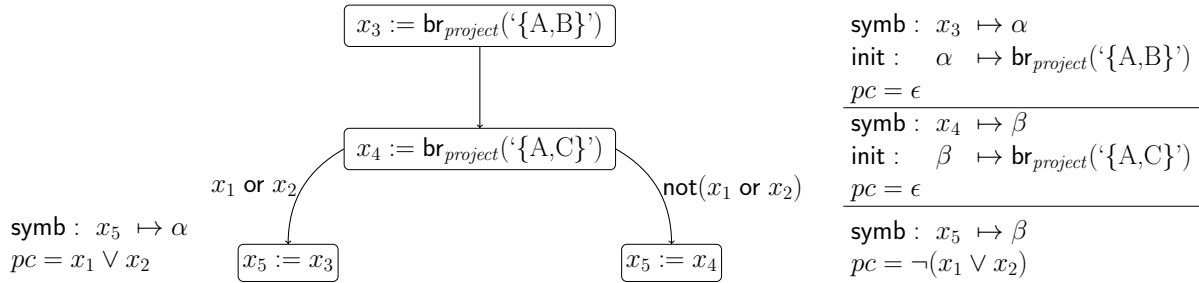

Figure 8. Assignments to nodes made by symbolic execution of the high code fragment from line 5 to line 7 in Example 2 using Algorithm 3 with $\text{Hvars} = \{x_1, \dots, x_5\}$ and $\text{Lvars} = \{x_6, x_{rea}\}$

of the mediator framework overviewed in Section 3.1 precomputes symbolic expressions by a compiler, using Algorithm 3 and Algorithm 4.

For the first fragment, its execution tree consists only of one node labeled with the assignment in line 1. Algorithm 3 processes this node in line 8 by invoking Algorithm 4 which outputs $\text{symb} : x_1 \mapsto \alpha$ and $\text{init} : \alpha \mapsto \text{br}_{select}(\text{'C='} + arg_1)$. In this expression arg_1 is a low variable the value of which is concatenated to the string 'C='. The second fragment is processed analogously.

The execution tree of the third fragment is processed depth-first with Algorithm 3 until line 8 as illustrated by Figure 8. In line 9 and line 10, finally the path conditions and symbolic expressions of x_5 are compiled to the result $(x_1 \vee x_2) * \alpha + \neg(x_1 \vee x_2) * \beta$.

To interpret a symbolic expression, the FlowTracker first determines an initial partition for each symbol, called context $\text{ctxt} : \Lambda \rightarrow (R \leftrightarrow \mathcal{P}(\mathcal{AIS}))$, according to the symbolic initialization function $\text{init} : \Lambda \rightarrow Bool \cup Op$ as an output of Algorithm 3. To do so, it has to synchronize with the low memory state that interaction processing has produced at the start of flow tracking. In the run-based system in Table 1 we assume that this state is available for the FlowTracker all the time while it is tracking. The FlowTracker then uses low memory to determine the argument values for view initialization functions

$\text{initv} : \Pi \times \text{Vals} \rightarrow (R \leftrightarrow \mathcal{P}(\mathcal{AIS}))$ of basic information requests taken from Π ; and furthermore the FlowTracker uses low memory to interpret the value v determined for a low expression as a single-block partition $(\mathcal{AIS}_w)_{w \in \{v\}}$.

Example 16 *The symbolic expression $(x_1 \vee x_2) * \alpha + \neg(x_1 \vee x_2) * \beta$ is produced by Algorithm 3 together with the symbolic initialization function $\text{init} : \alpha \mapsto \text{br}_{\text{project}}(\{A, B\})$, $\beta \mapsto \text{br}_{\text{project}}(\{A, C\})$ as shown in Example 15. The parameters to the basic information requests are string constants, so that the FlowTracker does not need low memory to initialize the partitions for the two symbols α and β : the partition for α is shown in Figure 3 below the dotted crossline and for β above the dotted crossline, respectively.*

Then, in the context ctxt , the FlowTracker interprets composite symbolic expressions SymExpr following their inductive structure as defined by the production rules above. In the base case, symbols in Λ are interpreted by ctxt and variables $x \in \text{Hvars}$ by temporary views tempvs . At the start of flow tracking, temporary views may be available from previous phases of flow tracking. Operators in Θ , query functions in Ω and symbolic boolean operators are all interpreted in an analogous way, exemplified here for $\oplus \in \Theta_m$ with $R_i \subseteq R$ and $\mathcal{B}_w^i \subseteq \mathcal{AIS}$:

$$\oplus((\mathcal{B}_w^1)_{w \in R_1}, \dots, (\mathcal{B}_w^m)_{w \in R_m}) := \{\mathcal{B}_v \mid \mathcal{B}_v \neq \emptyset \text{ and } \mathcal{B}_v = \bigcup_{\substack{w_1 \in R_1, \dots, w_m \in R_m \\ \oplus(w_1, \dots, w_m) = v}} \bigcap_{i=1, \dots, m} \mathcal{B}_{w_i}^i\}. \quad (3)$$

Intuitively, we can understand that the interpretation is correct by viewing the involved partitions with the intended semantics as the observer's inferences about the abstract information states from values. First, if the observer considered that the value v resulted from evaluating \oplus with values w_1, \dots, w_m for its operands, then it would infer from each value w_i that the abstract information state is in \mathcal{B}_{w_i} and thus in the intersection of these sets. Second, the observer normally cannot identify the actual operand values, but only a set of candidates for them. For each such candidate (w_1, \dots, w_m) the observer considers the possibility that the abstract information state is in the respective intersection for (w_1, \dots, w_m) and so concludes that the abstract information state is in the union of all these intersections. Lastly, the branch $*$ and join $+$ of paths are interpreted as follows:

$$\begin{aligned} (\mathcal{B}_w^1)_{w \in R_1} * (\mathcal{B}_w^2)_{w \in R_2} &:= \{\mathcal{B}_v \mid \text{true} \in R_1, v \in R_2, \mathcal{B}_v \neq \emptyset, \mathcal{B}_v = \mathcal{B}_{\text{true}}^1 \cap \mathcal{B}_v^2\}, \\ (\mathcal{B}_w^1)_{w \in R_1} + (\mathcal{B}_w^2)_{w \in R_2} &:= \{\mathcal{B}_v \mid \mathcal{B}_v \neq \emptyset, \mathcal{B}_v = \bigcup_{v \in R_1} \mathcal{B}_v^1 \cup \bigcup_{v \in R_2} \mathcal{B}_v^2\}. \end{aligned} \quad (4)$$

The reader may find an example of the FlowTracker's interpretation of composite symbolic expressions in Example 7 of Section 2.

Formally, we can show correct and non-interfering tracking if we assume that the temporary views for basic information reactions are initialized correctly and define a symbolic interpretation function

$$\begin{aligned} \text{eval} : \text{SymExpr} \times (\Lambda \rightarrow \text{Bool} \cup \text{Op}) \\ \times (\text{Hvars} \rightarrow (R \leftrightarrow \mathcal{P}(\mathcal{AIS}))) \times (\text{Lvars} \rightarrow \text{Vals}) \rightarrow \\ (\text{Hvars} \rightarrow (R \leftrightarrow \mathcal{P}(\mathcal{AIS}))) \end{aligned}$$

inductively in the way sketched above.

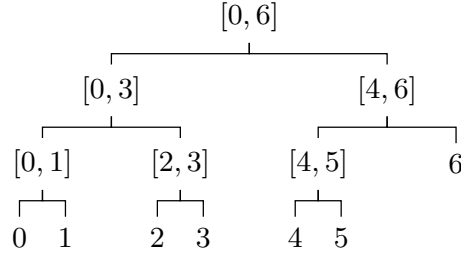
Figure 9. Generalization hierarchy for the finite integer domain $\{0, 1, \dots, 6\}$

Assumption 2 For all $ais \in \mathcal{AIS}$, $br_{para} \in \Pi$, $v, w \in Vals$ it holds $eval(br_{para})(v, ais) = w$ iff $ais \in \mathcal{B}_w$ in $initv(br_{para}, v)$.

Theorem 3 (Flow tracking) Let Sys be as specified in Table 1 and Table 2 satisfying Property 2 (gradual release), and Property 5 (No-read-up) and Property 6 (No-write-down), given in the appendix. Let the FlowTracker of Table 1 translate the code hp by $transToSym(transToET(hp), \vdash_{\Gamma})$ to $(symb, init)$ and interpret each symbolic expression $symb(x)$ for $x \in Hvars$ by the function $eval$ as a change of the temporary view $tempvs(x)$. Then, the system Sys satisfies Property 3 (Correctness) and Property 4 (Non-interference) of flow tracking.

7. Further challenges and solutions for the Java-based instantiation

In Section 3.1 we have outlined our Java-based instantiation of the mediator framework with two focuses: first, on the initialization of the mediator in the preparatory phase of Figure 1 and, second, in the working phase of Figure 1, on the synchronization of the components Program, FlowTracker and CIECensor through a Mediator class. The full functionality of the Java-based instantiation of the complete mediator framework may be summarized as follows:

1. template-based compilation of the mediator program to initialize the mediator framework according to the pattern in Section 3.2 such that the dynamic monitor, which consists of the FlowTracker and the CIECensor, is isolated from the program by the Mediator class as a proxy by means of Java-facilitated encapsulation;
2. initialization of temporary views according to Assumption 2 for rows of relational data which each represents an abstract information state like in Example 5;
3. flow tracking of protected realm fragments synchronized with program execution;
4. policy-enforcement at declassification by means of subtree generalization schemes.

This functionality is yet limited to mediator programs without loops and with finite enumeration types only. Moreover, we eased the fully automated compilation of the mediator program by restricting the form of the program even more, for example to the use of object fields instead of program variables. However, the instantiation under these limitations still poses intricate challenges. In the following, we point out several of such challenges related to the second and fourth functionality and present preliminary solutions by way of example. Regarding challenges related to other functionality in the list we refer the reader to Section 3.1.

Example 17 Within the scenario described in Example 1, we focus on a different data source containing a row of an individual identified by the primary key ID which has two functionally dependent further attributes D and E each with a finite domain of integers $\text{dom}(D) = \text{dom}(E) = \{0, 1, 2, 3\}$. This source may be accessed by select and project queries similarly as the source considered in Example 1. A generalization hierarchy may be defined such that it at least contains the domains of attributes D and E as shown in Figure 9.

A first challenge is to overload the addition of integers with an operator \oplus for the addition of intervals as generalized integers. The result of this operator must lay within the predefined, finite generalization hierarchy. Hence, we set $[x_1, x_2] \oplus [y_1, y_2] = [x_1 + y_1, x_2 + y_2]$ if the resulting interval is in the hierarchy. Here, an integer x is interpreted as the interval $[x, x]$. Otherwise, we take the minimal interval $[z_1, z_2]$ in the hierarchy (from bottom to top) such that $[x_1 + y_1, x_2 + y_2] \cap [0, 6] \subset [z_1, z_2]$. For example, we may compute $[0, 1] \oplus [0, 1] = [0, 3]$ and $[2, 3] \oplus 1 = [0, 6]$. Finally, if such a minimum does not exist as for $[2, 3] \oplus [4, 6]$ we define $[0, 6]$ as the result.

Now, we consider that the mediator should compute the sum of the columns D and E in the individual's row. For this simple computation, we may write the following two programs in pseudo-code (not in Java to shorten notation) which use declassification assignments at different points throughout computation.

<p>$p_1 : x_{rea}$</p> <p>1: $x_1 := \text{br}(\text{project}, \{D\})$</p> <p>2: $\text{decl}(x_1, l_{x_1})$</p> <p>3: $x_2 := \text{br}(\text{project}, \{E\})$</p> <p>4: $\text{decl}(x_2, l_{x_2})$</p> <p>5: $x_{rea} := l_{x_1} \oplus l_{x_2}$</p>	<p>$p_2 : x_{rea}$</p> <p>1: $x_1 := \text{br}(\text{project}, \{D\})$</p> <p>2: $x_2 := \text{br}(\text{project}, \{E\})$</p> <p>3: $x_3 := x_1 \oplus x_2$</p> <p>4: $\text{decl}(x_3, x_{reas})$</p>
--	--

A second challenge now is to initialize the temporary views for the FlowTracker in lines 1 and 3 of program p_1 and in lines 1 and 2 of program p_2 . To this end, the complete set of possible rows may be determined as $\mathcal{AIS} = \{(id, D, E) \mid D, E \in \{0, 1, 2, 3\}\}$. A block for the partition that results from the projection to D , for example, may be determined from its index v by the select query with selection predicate $D = v$ evaluated on \mathcal{AIS} when \mathcal{AIS} is stored as a relational database instance. This way the preimage of the result v of the projection to D is determined. If the mediator accessed several rows, each related to another individual, the result of the projection might be a set S of values the preimage of which is the union of all preimages each determined for a respective value $v \in S$. In general, the challenge of temporary view initialization is related to the problem of query inversion [8].

With the program p_1 , the FlowTracker computes the temporary view of x_1 and that of x_2 just by initializing them in the illustrated way, whereas with the program p_2 the FlowTracker additionally computes the temporary view of x_3 . The latter temporary view has seven blocks, one for each result value of adding integers between 0 and 3.

The additional computational effort of the FlowTracker during the execution of p_2 is compensated by a possibly more informative result value for x_{rea} in comparison to program p_1 . To illustrate the decreased loss of information, we consider a confidentiality policy with two elements $S_{D=3}$ and $S_{E=3}$, declaring that the value 3 of D and of E , respectively, is confidential. Based on this policy, the CIECensor determines the following security configurations: $SC_1 = (R'_1, \{\{3\}\})$ with $R'_1 = \{0, 1, 2, 3\}$ for the

declassification in line 1 and also in line 3 of program p_1 , and $SC_2 = (R'_2, \{6\})$ with $R'_2 = \{0, 1, \dots, 6\}$ for the declassification in line 4 of program p_2 .

For each declassification, the CIECensor computes a generalized value with Algorithm 2 for subtree generalization. To follow each of the CIECensor's steps we take $ais = (id, 2, 1)$ for the row accessed by the program in the source data. First, in line 2 of program p_1 the CIECensor selects the subtree with root $[2, 3]$ for SC_1 so that the value 2 of x_1 is generalized to the interval $[2, 3]$. Second, in line 3 the CIECensor again selects the same subtree, but here returns the unmodified value 1 of x_2 since that value is not an element of the selected subtree. Finally, the result x_{rea} has the value $[2, 3] \oplus 1 = [0, 6]$ which is the smallest interval in the hierarchy that contains $[3, 4]$. This loss of information in the result sent to the partner does not occur when computing the sum with program p_2 . In line 4 of program p_2 , the CIECensor select the subtree with root $[4, 6]$ for SC_2 , so that it returns the value 3 of x_3 , the sum of attributes D and E , unmodified.

The challenge with which mainly the program developer is burdened in our proposed framework is to balance the trade-off between computational effort and most informative reactions to the partner by inserting declassification assignments into the program code appropriately. An appropriate way for the developer to do so is to structure the mediator program in a modular way, for example, to compute and declassify intermediate results for the reaction to the partner in dedicated methods.

8. Conclusion

In this article, we have set a highly ambitious goal, namely how to provably enforce confidentiality of information by confining the information content of message data generated by program execution based on possibly diverse data sources. Towards this goal, we presented a mediator framework for a unified, holistic, history-aware control and applied a modular verification method to verify enforcement of a confidentiality policy on the unified view of the data sources, called abstract information state. The control bases on or adapts existing technologies for (1) the isolation of processing realms, overcome solely by declassification; (2) tracking of explicit and implicit information flow from the abstract information state to program variables; (3) informative value generalization based on a generalization hierarchy, and (4) a Java-based instantiation of the framework.

In this section, we contrast our achievements for these four tasks with those in related work, and give hopefully constructive ideas how the achievements of the related fields could contribute to further improvements of our proposed framework. We are convinced that for feasible and applicable instantiations of the framework, in the long-term, the expertise from different fields of research is needed. This conviction led us to spending much effort to find and exploit established methods for solutions of the four tasks. Research fields supporting our efforts include information system integration and mediation [15], data-program interfacing [16], logic-based inference control [5] and language-based information flow control with declassification [25] as further discussed in [9].

Research on inference-usability confinement, e.g. [5,6,7], studies how to design a control mechanism for a logic-based information system to confine the information content of a reaction to a basic information request of diverse kinds, such that the observer of communicated reaction data is always sure about the possibility that a confidential piece of information does not hold in the underlying information system. As a more general and comprehensive approach, in this article we consider program-based processing of requests so that our proposed control mechanism should comprise methods of both language-based information flow control and inference-usability confinement. With our focus on such a unified

control, we used an abstract representation of information like in [7] for the purpose of flow tracking in task (2), but for future instantiations of our framework we could use a logic-based representation of the temporary views and the observer's previous view. In this case, the confidentiality policy could be stated more conveniently as a set of logical sentences and Assumption 2 can be established by results on view computations for particular basic information requests, including queries to relational databases or incomplete databases, updates, see the summaries [5,6] and revisions [10]. Such requests can be jointly offered by information mediation, to be integrated into our framework as outlined in [9].

Value generalization, which is applied in task (3), is a fundamental method in database security to confine the information content of published data in a policy-compliant way, for example for k -anonymity, see the survey [17]. The extensive research on this method treats other important aspects not touched in this article, but relevant for the improvement of the framework in future work. One aspect is the combination of generalization hierarchies of several domains and the efficient exploration of all candidates for optimal generalization schemes [19]. Another aspect is the minimality of generalization schemes under other cost measures than the height of the subtree, which is used for the scheme in Section 5. The work [18] presents an efficient strategy by which the candidate space is explored for minimizing any cost measure. To prune the search space, cost lower-bounds are used which may be calculated by a generic method as a further contribution of the cited work. For the proposed framework, such methods might be useful to estimate the loss of information caused by declassification, and to provide the program developer with this estimate to assist him in the proper placement of declassification assignments.

Gradual release [2], which in our framework guarantees the isolation of realms to be bypassed only via declassification for task (1), is extended to the conditioned gradual release property in [4] which additionally confines the declassified information content. The specification, which expresses such a property, combines a security level typing for gradual release with declarations of sentences in relational logic for declassification, which define the values of which expressions may flow to which low variables via which declassification procedures. The static program analysis employs a security type system for the guarantee of gradual release and relational verification of the declassification procedures, linking the two results, typeability and verifiability, together by an analysis of execution paths via correspondence relations for the proof of conditioned gradual release.

Our combination of gradual release via declassification with a dynamic monitor follows this idea, but replaces static verification in relational logic with dynamic mechanisms of the monitor, i.e., flow tracking and value generalization. These mechanisms cannot be replaced by static relational verification for a policy-compliant declassification generally, because confidentiality policies often cannot be checked statically due to data-dependence. While we achieve data-level policy enforcement by means of value generalization here, future work might investigate how by purely static program analysis schema-level policies might be enforced. This has already been done for a security labeling of columns of a data table in [26] and might reasonably be extended to a declaration of confidential associations between columns.

Similarly to the task of flow tracking (2), a dynamic monitor achieves enforcement of assertions in relational logic by a dynamic tracking of valid assertions in [14]. The tracking considers alternative execution paths, which correspond to the actual execution path in a formal sense similar to correspondence relations in [4]. However, like the FlowTracker, the monitor does not explicitly inspect all such paths, but tracks them implicitly as the set of all paths which agree with the actual path in the evaluation of particular expressions as specified in relational logic sentences. If the monitor is unable to ensure the validity of assertions declared in the policy, it raises a security error, a reaction less meaningful than value generalization. However, the approximation of the set of corresponding execution paths might be useful to optimize the dynamic monitor in our framework.

Another method, which might be adapted for approximating the observer's knowledge gain during flow tracking for task (4), is studied in [20]. Knowledge about a hidden part of memory is represented as a distribution which maps each possible hidden part to a decimal indicating the part's probability. Such knowledge is approximated by a polyhedron which defines probability bounds for all possible hidden parts of memory. Operators for knowledge update, which is essential to any method of inference control, track the effects of observable program execution on this knowledge. The control enforces that the probability of each possible hidden part lays below a predefined threshold by updating the attacker's initial knowledge with observations from executing the complete program and rejecting the program if the threshold was exceeded.

Also we are aware that a security type system approximately decides whether a program satisfies the gradual release property for task (1), and non-interference as its special case, with false negatives, and dynamic monitoring of the whole program execution may reduce false negatives [24]. However, we chose security type systems, that guarantee the programming-language independent properties of gradual release and correspondence relations, as a unified approach. A type system can be enriched with other features such as flow lock policies [12] which define an event-based declassification mechanism.

Section 3.1 highlighted two particular challenges of task (4), the Java-based instantiation of the mediator framework, first, to synchronize flow tracking with low value computations by the program and, second, to bind temporary views to variables. The Symbolic PathFinder [22] extends the Java Virtual Machine of the Java PathFinder with mechanisms which interweave symbolic execution with Java byte code execution and which as such relate to these two challenges. First, listeners may be activated at particular events during byte code execution, such as the transition from the open to the protected processing realm. Furthermore, to attach symbolic information to variables, for each variable the object heap and the method stack store additional attributes which may be written and read by any byte code instruction given access to the variable. However, access to a method stack by another method is not allowed by the Java PathFinder Virtual Machine which poses a problem to flow tracking as discussed in Section 3.1. Finally, several execution paths may be traversed in parallel according to the selection of paths by a choice generator. However, the join of paths at certain events such as transition from the protected to the open realm is not supported by the Symbolic PathFinder. Altogether, the Symbolic PathFinder does not help to address the two managed challenges of flow tracking.

In conclusion, this work presents an extendible framework for the unified, holistic control of information flow from an abstract information state to a cooperation partner to effectively enforce a partner-specific confidentiality policy, and exemplarily lays out a Java-based instantiation of this framework outlining first solutions for the challenges incurred in such a task.

References

- [1] Paragon website. <http://www.cse.chalmers.se/research/group/paragon>. Accessed: September 2016.
- [2] A. Askarov and A. Sabelfeld. Gradual release: Unifying declassification, encryption and key release policies. In *2007 IEEE Symposium on Security and Privacy (S&P 2007)*, pages 207–221. IEEE Computer Society, 2007.
- [3] M. Balliu, M. Dam, and G. L. Guernic. Encover: Symbolic exploration for information flow security. In S. Chong, editor, *IEEE Computer Security Foundations Symposium – CSF 2012*, pages 30–44. IEEE Computer Society, Los Alamitos, 2012.
- [4] A. Banerjee, D. A. Naumann, and S. Rosenberg. Expressive declassification policies and modular static enforcement. In *IEEE Symposium on Security and Privacy – S & P 2008*, pages 339–353. IEEE Computer Society, Los Alamitos, 2008.
- [5] J. Biskup. Inference-usability confinement by maintaining inference-proof views of an information system. *International Journal of Computational Science and Engineering*, 7(1):17–37, 2012.

- [6] J. Biskup. Logic-oriented confidentiality policies for controlled interaction execution. In A. Madaan, S. Kikuchi, and S. Bhalla, editors, *Databases in Networked Information Systems – DNIS 2013*, volume 7813 of *LNCS*, pages 1–22. Springer, Berlin Heidelberg, 2013.
- [7] J. Biskup, P. A. Bonatti, C. Galdi, and L. Sauro. Optimality and complexity of inference-proof data filtering and CQE. In M. Kutylowski and J. Vaidya, editors, *Computer Security – ESORICS 2014*, volume 8713 of *LNCS*, pages 165–181. Springer International Publishing, 2014.
- [8] J. Biskup, J. Paredaens, T. Schwentick, and J. V. den Bussche. Solving equations in the relational algebra. *SIAM J. Comput.*, 33(5):1052–1066, 2004.
- [9] J. Biskup and C. Tados. Constructing inference-proof belief mediators. In P. Samarati, editor, *Data and Applications Security and Privacy XXIX - 29th Annual IFIP WG 11.3 Working Conference (DBSec 2015)*, volume 9149 of *LNCS*, pages 188–203. Springer, 2015.
- [10] J. Biskup and C. Tados. Preserving confidentiality while reacting on iterated queries and belief revisions. *Ann. Math. Artif. Intell.*, 73(1-2):75–123, 2015.
- [11] J. Biskup and T. Weibert. Keeping secrets in incomplete databases. *Int. J. Inf. Sec.*, 7(3):199–217, 2008.
- [12] N. Broberg, B. van Delft, and D. Sands. Paragon for practical programming with information-flow control. In C. Shan, editor, *Programming Languages and Systems – APLAS 2013*, volume 8301 of *LNCS*, pages 217–232. Springer International Publishing, 2013.
- [13] S. Bucur, V. Ureche, C. Zamfir, and G. Candea. Parallel symbolic execution for automated real-world software testing. In C. M. Kirsch and G. Heiser, editors, *Proceedings of the Sixth European Conference on Computer Systems (EuroSys 2011)*, pages 183–198. ACM, 2011.
- [14] A. Chudnov, G. Kuan, and D. A. Naumann. Information flow monitoring as abstract interpretation for relational logic. In *IEEE 27th Computer Security Foundations Symposium (CSF 2014)*, pages 48–62, 2014.
- [15] A. Doan, A. Y. Halevy, and Z. G. Ives. *Principles of Data Integration*. Morgan Kaufmann, San Francisco, 2012.
- [16] M. Fowler. *Patterns of Enterprise Application Architecture*. Pearson, Boston, 2003.
- [17] B. C. M. Fung, K. Wang, R. Chen, and P. S. Yu. Privacy-preserving data publishing: A survey of recent developments. *ACM Comput. Surv.*, 42(4), 2010.
- [18] R. J. B. Jr. and R. Agrawal. Data privacy through optimal k-anonymization. In *Proceedings of the 21st International Conference on Data Engineering, ICDE 2005, 5-8 April 2005, Tokyo, Japan*, pages 217–228, 2005.
- [19] K. LeFevre, D. J. DeWitt, and R. Ramakrishnan. Incognito: Efficient full-domain k-anonymity. In *Proceedings of the ACM SIGMOD International Conference on Management of Data*, pages 49–60, 2005.
- [20] P. Mardziel, S. Magill, M. Hicks, and M. Srivatsa. Dynamic enforcement of knowledge-based security policies using probabilistic abstract interpretation. *Journal of Computer Security*, 21(4):463–532, 2013.
- [21] F. Nielson, H. R. Nielson, and C. Hankin. *Principles of Program Analysis*. Springer, 1999.
- [22] C. S. Pasareanu, W. Visser, D. H. Bushnell, J. Geldenhuys, P. C. Mehltitz, and N. Rungta. Symbolic pathfinder: integrating symbolic execution with model checking for java bytecode analysis. *Autom. Softw. Eng.*, 20(3):391–425, 2013.
- [23] Q. Phan and P. Malacaria. Abstract model counting: a novel approach for quantification of information leaks. In S. Moriai, T. Jaeger, and K. Sakurai, editors, *9th ACM Symposium on Information, Computer and Communications Security, (ASIA CCS 2014)*, pages 283–292. ACM, 2014.
- [24] A. Russo and A. Sabelfeld. Dynamic vs. static flow-sensitive security analysis. In *IEEE Computer Security Foundations Symposium – CSF 2010*, pages 186–199. IEEE Computer Society, 2010.
- [25] A. Sabelfeld and D. Sands. Declassification: Dimensions and principles. *Journal of Computer Security*, 17(5):517–548, 2009.
- [26] D. Schoepe, D. Hedin, and A. Sabelfeld. SeLINQ: tracking information across application-database boundaries. In J. Jeuring and M. M. T. Chakravarty, editors, *Proceedings of the 19th ACM SIGPLAN international conference on Functional programming, Gothenburg, Sweden, September 1-3, 2014*, pages 25–38. ACM, 2014.
- [27] J. Zarouali. Entwurf und Implementierung eines Rahmenwerks zur Inferenzkontrolle für Java-Applikationen mittels Paragon. Masterarbeit, TU Dortmund, 2016.

Appendix

A. Correspondence relations as a proof tool

To argue about the observer's knowledge gain after declassification, in particular for the proof of Theorem 1, we need to match declassification assignments in two runs r and r' that the observer regards as alternatives at times t and t' , respectively, due to $O(r, t) = O(r', t')$. With such a motivation, we reuse correspondence relations and useful results from [4] in our notations. As considered for Property 2 (Gradual release), an *active* command is the command evaluated next in the one-step semantics. Moreover, in the situation that $p(r, t) \equiv hp; lp$ with the longest high-level prefix hp of $p(r, t)$ and a possibly empty low-level subprogram lp we call lp the *L-continuation* of $p(r, t)$ and write $Lcont(p(r, t))$. This is exactly the situation in which flow tracking might start for hp and end with the start of lp according to case (1) of Table 1. As such, this situation is considered for inductive arguments in proofs concerned with flow tracking.

Definition 5 (Correspondence (Definition 7.2 in [4])) *Let r and r' be runs and t, t' times. A correspondence from r to r' [until t and t' respectively] is a relation $Q \subseteq \{0, \dots, t\} \times \{0, \dots, t'\}$ such that $0 \in Q$ and for all i, j with $i \in Q, j \in Q$ the following properties hold:*

1. (*state agreement*) $mem_{low}(r, i) = mem_{low}(r', j)$;
2. (*level agreement*) active command of $p(r, i)$ is low iff active command of $p(r', j)$ is low;
3. (*code agreement low*) $p(r, i) = p(r', j)$ if the active command is low;
4. (*code agreement high*) $Lcont(p(r, i)) = Lcont(p(r', j))$ if the active command is high;
5. (*monotonicity*) if $i \in Q, j \in Q, i < i',$ and $i' \in Q, j' \in Q$ then $j \leq j'$; and symmetrically: if $i \in Q, j \in Q, j < j',$ and $i' \in Q, j' \in Q$ then $i \leq i'$;
6. (*completeness*) for every $i \in \{0, \dots, t\}$ there is some j with $i \in Q, j \in Q$, and symmetrically.

The following lemmata are ensured by every security type system that adheres to a weakened form of a no-read-up rule, as paraphrased in Section 2 under Item 1 (Isolation), and a complementary no-write-down rule which both are defined after the lemmata. As we have just anticipated as our main motivation for the use of correspondence relations, these lemmata ease inductive proofs of what knowledge the mediator subsystem reveals through declassification assignments. First, Lemma 2 enables us to match such assignments between the actual and an alternative run, that is a pair of runs at times t and t' such that $O(r, t) = O(r', t')$. For such a corresponding pair of runs Lemma 1 moreover enables us to relate the observer's perceptions of these runs and its knowledge thus gained.

Lemma 1 (Correspondence for O (Lemma 7.3 in [4])) *Let r, r' be runs and t, t' times such that there exists a correspondence between r and r' until t and t' , respectively. Then, for the observer subsystem it holds $O(r, t) = O(r', t')$.*

Lemma 2 (Correspondence (Lemma 7.5 in [4])) *Let r, r' be runs and t, t' times such that $O(r, t) = O(r', t')$ holds for the observer subsystem and in run r at time t and in run r' at time t' the active commands are low. Then there is a correspondence from r to r' until t and t' , respectively.*

If low computation steps depend only on what the observer is able to perceive, here low memory, its change and program termination (Table 2), such steps must be taken correspondingly in the actual and an alternative run during which the observer makes equal observations. The latter consequence is what Lemma 2 says, whereas the premise is subject of the following no-read-up rule, Property 5. This rule

says that low computation steps, except for declassification assignments, on low memory are determined by low memory only.⁵ Putting it differently, such steps are executed as if high memory and abstract information state were not accessible at all.

Property 5 (No-read-up without declassification (Lemma 6.3 b in [4])) *Let the active command in a program p be low, but no declassification assignment, and be evaluated in the step $\text{eval}(p, \text{mem}, \text{ais}) = (p^{\text{succ}}, \text{mem}^{\text{succ}}, \text{ais})$ given any memory mem and any abstract-information state ais . Then, for every memory mem' with $\text{mem}_{\text{low}} = \text{mem}'_{\text{low}}$ there exists $\text{mem}'^{\text{succ}}$ such that for every $\text{ais}' \in \mathcal{AIS}$ it holds $\text{eval}(p, \text{mem}', \text{ais}') = (p^{\text{succ}}, \text{mem}'^{\text{succ}}, \text{ais}')$ and $\text{mem}'_{\text{low}} = \text{mem}'^{\text{succ}}_{\text{low}}$.*

Single steps in a sequence of high level program execution in a run may be matched with high level steps in another run and another sequence by a correspondence relation. Computations must not be the same in the matched steps (code agreement high), but so must the low memory states. This only works if high computation steps do not change low memory as stated by the following no-write-down rule.

Property 6 (No-write-down (Lemma 6.3 c in [4])) *Let the active command in a program p be high and evaluated in the step $\text{eval}(p, \text{mem}, \text{ais}) = (p^{\text{succ}}, \text{mem}^{\text{succ}}, \text{ais})$ given any memory mem and abstract-information state ais . Then, it holds $\text{mem}_{\text{low}} = \text{mem}_{\text{low}}^{\text{succ}}$.*

Indeed the two properties suffice to establish the two lemmata.

Proposition 3 *Let LIP be a programming language with a one-step semantics eval . Let \vdash_{Γ} be a security level inference for LIP which adheres to the rules in Property 5 and Property 6. Then, for the mediator subsystem of Table 1 and the observer subsystem \mathcal{O} of Table 2 Lemma 1 and Lemma 2 hold.*

B. Sketch of induction step for Theorem 1

By induction on time t we show the following relationships between the observer's knowledge \mathcal{K} , the observer's previous view prev and the observer's inferred abstract information set $I\mathcal{AI}$, respectively:

$$\mathcal{K}(r, t) = \text{prev}(r, t) \tag{5}$$

$$\mathcal{K}(r, t + 1) = \mathcal{K}(r, t) \cap I\mathcal{AI}(\text{tempvs}(r, t)(x_{\text{src}}), \text{dt}, \mathcal{SC}, g). \tag{6}$$

Case 1: Let run r be such that $p(r, t) \equiv \text{decl}(x_{\text{src}}, x_{\text{dest}}); \text{restp}$ where $x_{\text{src}} \in \text{Hvars}$ and $x_{\text{dest}} \in \text{Lvars}$. In this case, (5) follows from (6) given the computation of prev by Algorithm 1.

“ \subseteq in (6)”: Consider $\text{ais} \in \mathcal{K}(r, t + 1)$ and let a run r' and a time t' be such that

$$\text{ais}(r', 0) = \text{ais} \text{ and } \mathcal{O}(r', t') = \mathcal{O}(r, t + 1). \tag{7}$$

Consider the latest times in both runs, in run r until time $t + 1$ and in run r' until time t' , when the active command is low. According to Table 2 execution of an high active command cannot be observed, so that we can assume that times $t + 1$ and t' are such times. In this situation, by Lemma 2, due to the equality $\mathcal{O}(r', t') = \mathcal{O}(r, t + 1)$ there is a correspondence Q from r to r' until $t + 1$ and t' respectively.

⁵ This is an intuitive, yet a little imprecise reading of the rule since the rule neglects the effect of the computation step on high memory. High memory may be neglected because the lemmata concern the observer subsystem \mathcal{O} and the existence of correspondence relations only.

We exploit this correspondence to match the declassification assignment in both runs. In the considered case, the active command in (r, t) is $\text{decl}(x_{src}, x_{dest})$ which is always low level if x_{dest} is as in this case. Since the correspondence is complete and monotone, there is $t'' \leq t'$ with $t \dot{Q} t''$. Since $t \dot{Q} t''$, we even know that $\text{p}(r, t) = \text{p}(r', t'')$ due to the level agreement and code agreement low. Therefore, the active command in (r', t'') is $\text{decl}(x_{src}, x_{dest})$, too.

To prove \subseteq in (6), we show first that run r' at t'' clusters the same blocks of the same R -indexed partition as r does at t . Then we conclude by showing that the abstract information state of run r' , which is ais by (7), lies in this cluster.

By Lemma 1, the correspondence $t \dot{Q} t''$ between r and r' implies $\text{O}(r, t) = \text{O}(r', t'')$. Hence, by Property 4 (Non-interference) the temporary views agree $\text{tempvs}(r, t)(x_{src}) = \text{tempvs}(r', t'')(x_{src})$ for x_{src} to be declassified in both (r, t) and (r', t'') . Also do the previous views agree by the induction hypothesis for (5). Hence, during declassification, by Algorithm 1 the censor computes the same security configuration and thus selects the same row in the distortion table. Since the observations in both runs agree in the next time step $t + 1$ and $t'' + 1$ (until t'), respectively, by (7), in both (r, t) and (r', t'') the same generalized value g is assigned to the destination variable x_{dest} . This value determines the inferred abstract information IAI of (2), given the temporary view of x_{src} and the row in the distortion table, which thus is the same set of states, as a cluster of the original blocks in the temporary view of x_{src} , in both runs at times $t + 1$ and $t'' + 1$, respectively.

Finally, we show $\text{ais} \in \mathcal{K}(r, t) \cap \text{IAI}$. First, since knowledge is monotone from $\text{ais} \in \mathcal{K}(r, t + 1)$ it follows $\text{ais} \in \mathcal{K}(r, t)$. Second, the abstract information state ais , which is $\text{ais}(r', 0)$ by the choice of r' in (7), is in IAI determined in (r, t) . To show this, we consider run r' at time t'' in which the censor determines the same set IAI as in (r, t) by our previous arguments. In run r' at time t'' , by Property 3 there is a block \mathcal{B}_u in $\text{tempvs}(r', t'')(x_{src})$ with $\text{mem}(r', t'')(x_{src}) = u$ and $\text{ais} = \text{ais}(r', 0) \in \mathcal{B}_u$. Moreover, we know that value u is generalized to the observed value g (possibly $u = g$) so that $\mathcal{B}_u \subseteq \text{IAI}$.

“ \supseteq in (6)”: Consider $\text{ais} \in \mathcal{K}(r, t) \cap \text{IAI}$. We can proceed along a similar line of argumentation as before, showing that the runs r' and r with $\text{O}(r', t'') = \text{O}(r, t)$ and $\text{ais}(r', 0) = \text{ais}$ use the same row in the distortion table. To conclude, we claim that the same generalized value is transferred in both runs, which is observed at $t'' + 1$ and $t + 1$, respectively. Due to equal observations at those times it finally follows $\text{ais} = \text{ais}(r', 0) \in \mathcal{K}(r, t + 1)$.

We show that in both runs the same generalized value is transferred to x_{dest} . In (r, t) , from the cluster of blocks that is put into union to IAI , we take the block \mathcal{B}_u that contains $\text{ais}(r', 0)$. This is possible because by precondition it holds $\text{ais}(r', 0) \in \text{IAI}$. First, by Property 4 (Non-interference) this block \mathcal{B}_u is also a block in the partition $\text{tempvs}(r', t'')$. Second, by taking Property 3 (Correctness) into account in each of the two runs, it follows that $\text{mem}(r, t)(x_{src}) = u$ and $\text{mem}(r', t'')(x_{src}) = u$. Recalling the arguments of the previous case, we know that the censor generalizes u to the same value g in both runs due to equal security configurations.

Case 2: Let r be such that $\text{p}(r, t) \equiv \text{decl}(x_{src}, x_{dest}); \text{restp}$ and $x_{src} \in \text{Lvars}$. Due to the monotonicity of knowledge, which ensures $\mathcal{K}(r, t + 1) \subseteq \mathcal{K}(r, t)$, we only need to consider $\text{ais} \in \mathcal{K}(r, t)$ and show $\text{ais} \in \mathcal{K}(r, t + 1)$. As in the previous case, we consider a run r' with $\text{ais}(r', 0) = \text{ais}$ and $\text{O}(r', t') = \text{O}(r, t)$. As exemplified above, we use a correspondence relation to show that $\text{decl}(x_{src}, x_{dest})$ is the active command in (r', t') , too, and, hence, due to the low label of x_{src} observations in both runs at times $t + 1$ and $t' + 1$ are equal. This equality shows $\text{ais} = \text{ais}(r', 0) \in \mathcal{K}(r, t + 1)$.

Case 3: Let r be such that $p(r, t) \equiv \text{decl}(x_{src}, x_{dest}); \text{restp}$ and $x_{dest} \in \text{Hvars}$. We may proceed as in the previous case noting that because both runs write to the high variable x_{dest} there are no observations at times $t + 1$ and $t' + 1$.

Case 4: Let $\text{decl}(x_{src}, x_{dest})$ be not the active command in (r, t) . We use gradual release in Property 2 and the induction hypothesis to show (5), whereas (6) according to Theorem 1 solely refers to the case where the active command is a declassification assignment with high source and low destination.

C. Sketch of induction step for Theorem 2

If in Table 1 any case applies, but the value generalization by the CIECensor in case (3) of the table, we can argue that $\mathcal{K}(r, t) = \mathcal{K}(r, t + 1)$ holds by reusing respective arguments from the proof sketch of Theorem 1 and then use the induction hypothesis. Otherwise, the CIECensor determines a security configuration $SC = (R', V)$ for the declassification of x_{src} with $x_{src} \in \text{Hvars}$, using the temporary view $(\mathcal{B}_w)_{w \in R'}$ of x_{src} . By Property 3 (Correctness) this view covers $\mathcal{K}(r, t)$ so that by (5) it holds $\mathcal{K}(r, t) \subseteq \text{prev}(r, t) \cap \bigcup_{w \in R'} \mathcal{B}_w$. Therefore, the whole range of values R' cannot be in any of the violating sets V contained in SC by induction hypothesis.

Finally, we assume the contrary that there exists $\mathcal{S} \in \text{pol}$ such that $\mathcal{K}(r, t + 1) \subseteq \mathcal{S}$ which by Theorem 1 can be rewritten to $\text{prev}(r, t) \cap \mathcal{IAI} \subseteq \mathcal{S}$ in case (3) of Table 1. This assumption implies $\{u \in R' \mid \text{dt}(SC, u) = g\} \in SC$ since \mathcal{IAI} is defined as the union of blocks with such an index u . Because we first argued that $R' \notin SC$, the latter conclusion contradicts Requirement 2 in Definition 2 of distortion tables.

D. Sketch of induction step for Theorem 3

We will show by induction on the times t in which the FlowTracker's status is *idle* in run r , thus including all times of declassification according to case (3) of Table 1, that for all $r' \in \text{Sys}$ and $t' \in \mathbb{N}_0$ such that $O(r', t') = O(r, t)$ it holds:

$$p(r, t) = p(r', t'), \quad (8)$$

$$\text{tempvs}(r, t) = \text{tempvs}(r', t') \text{ with domain Hvars}, \quad (9)$$

$$\text{for all } x \in \text{Hvars } \text{ais}(r, t) \in \mathcal{B}_v \text{ in } \text{tempvs}(r, t)(x) \text{ iff } \text{mem}(r, t)(x) = v, \text{ and} \quad (10)$$

$$\text{for all } x \in \text{Hvars } \text{tempvs}(r, t)(x) \text{ forms a partition covering } \mathcal{K}(r, t). \quad (11)$$

The interesting case is where at time $t - 1$ the FlowTracker's status is *tracking* so that at time t the FlowTracker changes the temporary views. Let t_{start} be the latest time before in run r where the status is *idle*. According to the definition of runs in Table 1, the program is $p(r, t_{start}) \equiv \text{hp}; \text{lp}$, a sequence of a high-level subprogram hp and a low-level subprogram lp , so that for any other such sequence $\text{hp}'; \text{lp}'$ the subprogram hp' is a prefix of hp .

Since $O(r', t') = O(r, t)$, there is a correspondence $t \ Q \ t'$ between r and r' by Lemma 2. The program in run r' at a corresponding time t'_{start} , determined by Q , is the same by the induction hypothesis,

using that $O(r', t'_{start}) = O(r, t_{start})$ by Lemma 1. For the same reason, all other arguments of the FlowTracker's computation $\text{eval}(\text{transToSym}(\text{transToET}(\text{hp}), \vdash_{\Gamma}))(\text{tempvs}, \text{mem}_{\text{low}})$ in (r, t_{start}) and (r', t'_{start}) are equal (the low memory due to state agreement low). So, we showed (8) and the equality in (9).

Regarding the domain in (9) and the equivalence of (10), we will consider the execution tree T generated from hp preserving the one-step semantics. Moreover, we will consider the memory mem_n produced by T after processing a node n and all expressions expr defined over high variables and over expressions in the image of init . Let Algorithm 4 translate expr to symexpr in the symbolic state $\text{symb}(n)$ with init and \vdash_{Γ} . Based on Assumption 2 (Temporary view initialization) and Property 2 (Gradual release), we can show by induction on the tree structure that for all nodes n of T the domain of $\text{symb}(n)$ is Hvars for (9) and it holds $\text{eval}(\text{expr})(\text{mem}_n, \text{ais}) = v$ iff $\text{ais} \in \mathcal{B}_v \in \text{eval}(\text{symexpr})(\text{tempvs}, \text{mem}_{\text{low}})$. Since this way we can verify correctness for the translation of all relevant operations of the tree along a path, including branch conditions, we can show correctness of the translation of the complete tree for (10).

Finally, we verify that for all $x \in \text{Hvars}$ $\text{tempvs}(r, t)(x)$ is indeed an R -indexed partition covering $\mathcal{K}(r, t)$. First, let $\text{ais} \in \mathcal{K}(r, t)$. We can show that there is \mathcal{B}_v in $\text{tempvs}(r, t)$ which contains ais by selecting a run r'' such that $\text{ais} = \text{ais}(r'', 0)$ and $O(r'', t'') = O(r, t)$ at a time t'' , then using (10) to first find the the desired block in $\text{tempvs}(r', t'')(x)$ with the block index $v = \text{mem}(r', t'')(x)$ and finally concluding with (9) that the block found is also in $\text{tempvs}(r, t)(x)$. Second, let \mathcal{B}_v and $\mathcal{B}_{v'}$ be two blocks in $\text{tempvs}(r, t)(x)$ with $x \in \text{Hvars}$. We can show that $\mathcal{B}_v \cap \mathcal{B}_{v'} \neq \emptyset$ implies $v = v'$ and thus $\mathcal{B}_v = \mathcal{B}_{v'}$.

E. Sketch of proof for Proposition 2

First, we argue that Algorithm 2 indeed computes a function on $(\{R' \in \mathcal{P}(R)\} \times \mathcal{P}(\mathcal{P}(R') \setminus R')) \times R$. So let $SC = (R', V) \in \{R' \in \mathcal{P}(R)\} \times \mathcal{P}(\mathcal{P}(R') \setminus R')$ and $w \in R$. Then, we claim the following three points: (1) an SC -subtree generalization scheme of Definition 3 exists, and hence can be computed in line 1 by exhaustively searching the finite space of all candidates. (2) This scheme is uniquely determined by SC and the generalization hierarchy T . Moreover, (3) if existent, the subtree G in line 2 is uniquely determined by \mathcal{G} and $w \in R$. So, following all three points, the algorithm computes a function.

We justify each of the above points: (1) The set $\mathcal{G} = \{R\}$ is always a candidate which satisfies all requirements of Definition 3, but minimality. Minimality is only fulfilled if there is no other candidate. Regarding the third requirement, we note that for all $I \in V$ it holds $I \subseteq R$ and $R \cap R' \not\subseteq I$ since $I \subseteq R'$, but $I \neq R'$ by Definition 1 (Security Configuration). (2) Let \mathcal{G} and \mathcal{G}' be two SC -subtree generalization schemes. We show that for any $G \in \mathcal{G}$ there exists $G' \in \mathcal{G}'$ such that $G' = G$. The proof of that will only exploit that \mathcal{G} is a subtree generalization scheme so that we could show the same for \mathcal{G}' . Hence, the two sets are equal. Starting the proof, we know that $\mathcal{G} \leq \mathcal{G}'$ by the forth requirement which particularly says that there exists $G' \in \mathcal{G}'$ such that $G \subseteq G'$. Likewise, there exists $G^* \in \mathcal{G}$ such that $G' \subseteq G^*$ so that we obtain the chain $G \subseteq G' \subseteq G^*$. Since $G, G^* \in \mathcal{G}$ and all such sets are disjoint, if unequal, it follows $G = G^*$ and hence $G = G'$. (3) This point is obvious because all subtrees are pairwise disjoint.

Now, let dt denote the function as computed by the algorithm. We conclude by verifying the two properties of a distortion table. (1) It is obvious that, if $V = \emptyset$, then $\mathcal{G} = \emptyset$ is the SC -subtree generalization scheme and hence Algorithm 2 returns w on every input value w . (2) We show that for all $SC = (R', V) \in \{R' \in \mathcal{P}(R)\} \times \mathcal{P}(\mathcal{P}(R') \setminus R')$ and $g \in R$ such that $\{w \in R \mid \text{dt}(SC, w) = g\} \cap R' \neq \emptyset$ there does not exist $I \in V$ such that $\{w \in R \mid \text{dt}(SC, w) = g\} \cap R' \subseteq I$. We need to discuss two cases.

Case 1. For all G in the SC -subtree generalization scheme \mathcal{G} it holds $g \notin G$.

In this case, it holds that $\{w \in R \mid \text{dt}(SC, w) = g\} = \{g\}$. Assume that there is $I \in V$ such that $\{g\} \cap R' \subseteq I$ and $\{g\} \cap R' \neq \emptyset$. Hence, we obtain $g \in I$. Since \mathcal{G} is a subtree-generalization scheme, it follows that there is a selection S of subtrees from \mathcal{G} such that $I \subseteq \bigcup_{G \in S} G$. This contradicts the case

considered.

Case 2. There is G in the SC -subtree generalization scheme \mathcal{G} such that $g \in G$.

Then, by the definition of the algorithm this G has the root value g and all values of G and only these are generalized to g , thus $\{w \in R \mid \text{dt}(SC, w) = g\} = G$. Assume that there exists $I \in V$ such that $G \cap R' \subseteq I$ and $G \cap R' \neq \emptyset$. By the definition of the generalization scheme there is a selection S of subtrees from \mathcal{G} such that $I \subseteq \bigcup_{G' \in S} G'$. Putting it all together, we obtain that $\emptyset \neq G \cap R' \subseteq I \subseteq \bigcup_{G' \in S} G'$ and hence $\bigcup_{G' \in S} G' = G$, because all different sets are pairwise disjoint. This means that $\bigcup_{G' \in S} G' \cap R' = G \cap R' \subseteq I$, contradicting $G' \cap R' \not\subseteq I$ for all $G' \in S$ as required when S has been selected.

F. Sketch of proof for Proposition 3

F.1. Claim: Lemma 1 implied by Property 5 and Property 6

By induction on time t we show that if there is a correspondence from r to r' until t and t' then it follows $O(r, t) = O(r', t')$. We will limit the proof sketch to the induction step. By monotonicity and completeness of Definition 5, it holds $t \ Q \ t'$ and $t - 1 \ Q \ t''$ for some $t'' \leq t'$ and $t \ Q \ t'''$ for all $t''' \in \{t'' + 1, \dots, t'\}$. The induction hypothesis says that $O(r, t - 1) = O(r', t'')$ holds. In the case of $t'' < t'$, we will argue that from the induction hypothesis and $t \ Q \ t'' + 1$ the equality $O(r, t) = O(r', t'' + 1)$ follows. This argument may be repeated for all $t''' \in \{t'' + 2, \dots, t'\}$ so that $O(r, t) = O(r', t''')$ also holds for all such t''' . Finally, we consider the special case of $t'' = t'$.

Case 1. The active command in $(r, t - 1)$ is low.

Code agreement low implies that the active command is the same in (r', t') . If it is not an assignment or one to a high variable, then the observer cannot perceive its execution in both runs according to Table 2 so that it holds $O(r, t) = O(r, t - 1)$ and $O(r', t'' + 1) = O(r', t')$. By induction hypothesis it follows $O(r, t) = O(r', t'' + 1)$.

If the active command in $(r, t - 1)$ assigns to a low variable, then by state agreement for $t \ Q \ t'' + 1$ in (r, t') the same value is written and thus observed according to Table 2. By induction hypothesis it follows $O(r, t) = O(r', t'' + 1)$.

Case 2. The active command in $(r, t - 1)$ is high.

By level agreement for $t - 1 \ Q \ t''$ the active command in (r', t'') is also high. Property 6 (No-write-down) ensures that low memory does not change in both runs so that there are no additional observations in both runs at times t and $t'' + 1$, respectively, according to Table 2 and hence it holds $O(r, t) = O(r', t'' + 1)$ by induction hypothesis.

Case 3. Other cases (of computation in (r, t)) according to Table 1.

In the table, we see that computations by the mediator other than program execution, which is treated by the above cases, are the computation of the function eval in case (1) (Start flow tracking) of the table and computation of the function censor in case (3) (Generalize value by CIECensor) of the table. These computations do not change low memory, as can be seen from the table, and hence cannot be observed according to Table 2.

Case 4. Special case $t'' = t'$.

By choice of t'' , it holds $t - 1 \ Q \ t''$ and hence $t - 1 \ Q \ t'$. The induction hypothesis, applied to the correspondence $t - 1 \ Q \ t'$, says that $O(r, t - 1) = O(r', t')$ holds. Moreover, as mentioned above, it holds $t \ Q \ t'$. Due to both correspondences from $t - 1$ and t to t' , the active command in $(r, t - 1)$ cannot be low. Otherwise, code agreement low for both $t - 1 \ Q \ t'$ and $t \ Q \ t'$ would imply $p(r, t - 1) \equiv p(r, t)$, but, before program termination, in Table 1 each transition in a run alters the current program. Hence, the active command in (r, t) is high.

According to Property 6 (No-write-down), the high active command in $(r, t - 1)$ may not change low memory, so that there are no additional observations in (r, t) according to Table 2 and it holds $O(r, t) = O(r, t - 1) = O(r', t')$.

F.2. Claim: Lemma 2 implied by Property 5 and Property 6

By induction on time t we show that if it holds $O(r, t) = O(r', t')$ and the active commands in (r, t) and (r', t') are low then there is a correspondence from r to r' until t and t' . We will limit the proof sketch to the induction step.

Let $t_{pre}^* < t$ be the latest previous time where the active command is low in r , and let $t'_{pre}^* < t'$ be the like time in r' . The induction hypothesis says that there is a correspondence from r to r' until t_{pre}^* and t'_{pre}^* . First, we start with $t_{pre}^* + 1$ and $t'_{pre}^* + 1$.

Case 1. $t_{pre}^* + 1 \neq t$ and $t'_{pre}^* + 1 \neq t'$.

We extend the correspondence to $t_{pre}^* + 1 \ Q \ t'_{pre}^* + 1$ and justify that for this extension the properties of a correspondence relation are still fulfilled.

First, by choice of t_{pre}^* and t'_{pre}^* , the active commands in $(r, t_{pre}^* + 1)$ and $(r', t'_{pre}^* + 1)$ are high and moreover we claim that $Lcont(p(r, t_{pre}^* + 1)) = Lcont(p(r', t'_{pre}^* + 1))$ holds. Hence, level agreement and code agreement high are fulfilled.

As we justify in the following the latter equality of the longest low level suffixes follows from the correspondence from r to r' until t_{pre}^* and t'_{pre}^* . At those times, the active commands are both low and, hence, due to code agreement low the programs to be executed in both runs are the same, $p(r, t_{pre}^*) = p(r', t'_{pre}^*)$.

Case 1–a. The active command in $p(r, t_{pre}^*)$, and hence in $p(r', t'_{pre}^*)$ is a declassification assignment. Consequently, the program in both runs has the form $decl(x_{src}, x_{dest}); restp$ and in the next execution step is reduced to $restp$ according to Table 1 so that the longest low level suffixes are both $Lcont(restp)$. By choice of t_{pre}^* and t'_{pre}^* , the low level execution steps at those times are observed, but afterwards there is no observation of the high execution until t and t' , respectively, according to Table 2, so that it holds $O(r, t_{pre}^* + 1) = O(r, t)$ and $O(r', t'_{pre}^* + 1) = O(r', t')$, respectively. Due to the precondition $O(r, t) = O(r', t')$ the same value is written to low memory in (r, t_{pre}^*) and (r', t'_{pre}^*) and thus state agreement for $t_{pre}^* + 1 \ Q \ t'_{pre}^* + 1$ is fulfilled by induction hypothesis.

Case 1–b. The active command in $p(r, t_{pre}^*)$, and hence in $p(r', t'_{pre}^*)$ is not a declassification assignment. By Property 5 (No-read-up), from state agreement low in (r, t_{pre}^*) and (r', t'_{pre}^*) we obtain that in the next step of both runs, at times $t_{pre}^* + 1$ and $t'_{pre}^* + 1$, respectively, the program codes are still equal and so are the longest low level suffixes, that is $Lcont(p(r, t_{pre}^* + 1)) = Lcont(p(r', t'_{pre}^* + 1))$.

Moreover, the latter argument with Property 5 implies that the low memory states in both runs still agree and hence state agreement is fulfilled.

Monotonicity and completeness hold by construction of the extended correspondence. With the previous arguments, we have verified all properties of a correspondence relation for the extension.

Case 2. $t_{pre}^* + 1 = t$ and $t'_{pre}^* + 1 = t'$.

Again we extend the correspondence to $t_{pre}^* + 1 \ Q \ t'_{pre}^* + 1$. By the precondition of the lemma, the active commands in $(r, t_{pre}^* + 1)$ and $(r', t'_{pre}^* + 1)$ are low and we can proceed as in the previous case to show $\mathfrak{p}(r, t_{pre}^* + 1) = \mathfrak{p}(r', t'_{pre}^* + 1)$ (code agreement low) and the other properties of correspondence relations.

Case 3. $t_{pre}^* + 1 = t$ and $t'_{pre}^* + 1 < t'$, or $t_{pre}^* + 1 < t$ and $t'_{pre}^* + 1 = t'$.

These cases cannot occur because as we have just argued the programs in the next steps of both runs, at $t_{pre}^* + 1$ and $t'_{pre}^* + 1$, respectively, are equal, but before t and t' , respectively, the active command is high and at t and t' , respectively, it is low.

Next, we use an inductive argument for each $t_{pre} > t_{pre}^* + 1$ and $t'_{pre} > t'_{pre}^* + 1$ until we reach t and t' respectively.

Case 1. $t_{pre} \neq t$ and $t'_{pre} \neq t'$.

By choice of t_{pre}^* and t'_{pre}^* , the active commands in (r, t_{pre}) and (r', t'_{pre}) are high. We extend the correspondence from r to r' until $t_{pre} - 1$ and $t'_{pre} - 1$ to $t_{pre} \ Q \ t'_{pre}$ and justify that for this extension the properties of a correspondence relation are still fulfilled. Level agreement holds by construction.

By choice of t_{pre} and t'_{pre} , in the previous steps, $t_{pre} - 1 > t_{pre}^*$ and $t'_{pre} - 1 > t'_{pre}^*$, the active commands are high. Therefore, Property 6 (No-write-down) ensures that the transition from the previous step to t_{pre} and t'_{pre} , respectively, does not change low memory. Hence, state agreement is still fulfilled.

Code agreement high holds at the previous steps and hence also at t_{pre} and t'_{pre} . Finally, monotonicity and completeness hold by construction of the extended correspondence.

Case 2. $t_{pre} \neq t$ and $t'_{pre} = t'$.

By choice of t_{pre}^* , the active command in (r, t_{pre}) is high, whereas by the precondition of the lemma in (r', t'_{pre}) it is low. We extend the correspondence from r to r' until $t_{pre} - 1$ and $t'_{pre} - 1$ to $t_{pre} \ Q \ t'_{pre} - 1$ and justify that for this extension the properties of a correspondence relation are still fulfilled.

In the previous step in r' , $t'_{pre} - 1 > t'_{pre}^*$, the active command is high so that level agreement is still fulfilled for the extension. Also the active command in $(r, t_{pre} - 1)$ is high. Therefore, the transition from the previous step to t_{pre} in r does not change low memory by Property 6 (No-write-down). Moreover, since by the inductive argument there is a correspondence $t_{pre} - 1 \ Q \ t'_{pre} - 1$, the low memory state is the same $\text{mem}_{\text{low}}(r, t_{pre} - 1) = \text{mem}_{\text{low}}(r', t'_{pre} - 1)$ and hence also $\text{mem}_{\text{low}}(r, t_{pre}) = \text{mem}_{\text{low}}(r', t'_{pre} - 1)$. This way, we have just argued that state agreement is fulfilled for the extended correspondence.

Finally, code agreement high holds for $t_{pre} - 1 \ Q \ t'_{pre} - 1$ and hence still for $t_{pre} \ Q \ t'_{pre} - 1$. Monotonicity and completeness are fulfilled by construction.

Case 3. $t_{pre} = t$ and $t'_{pre} \neq t'$.

This case can be treated analogously to the previous one.

Case 4. $t_{pre} = t$ and $t'_{pre} = t'$.

In this case, the active commands in both runs are low by precondition of the lemma. So we extend the correspondence to $t \ Q \ t'$ and show the required properties. Level agreement holds by construction.

Since for our inductive argument we consider $t - 1 > t_{pre}^*$ and $t' - 1 > t'_{pre}^*$, the active command in the previous step $t - 1$ and $t' - 1$, respectively, is high so that we can proceed as in Case 1.