

# Coalition formation for Multi-agent Pursuit based on Neural Network and AGRMF Model

Zhaoyi Pei, Songhao Piao, Mohammed Ei Souidi

**Abstract**—An approach for coalition formation of multi-agent pursuit based on neural network and AGRMF model is proposed. This paper constructs a novel neural work called AGRMF-ANN which consists of feature extraction part and group generation part. On one hand, The convolutional layers of feature extraction part can abstract the features of agent group role membership function (AGRMF) for all of the groups, on the other hand, those features will be fed to the group generation part based on self-organizing map (SOM) layer which is used to group the pursuers with similar features in the same group. Besides, we also come up the group attractiveness function (GAF) to evaluate the quality of groups and the pursuers contribution in order to adjust the main ability indicators of AGRMF and other weight of all neural network. The simulation experiment showed that this proposal can improve the effectiveness of coalition formation for multi-agent pursuit and ability to adopt pursuit-evasion problem with the scale of pursuer team growing.

**Index Terms**—multi-agent system; neural network; AGRMF; pursuit-evasion

## 1 INTRODUCTION

Nowadays, multi-agent systems (MAS) attract more attention in research concerning the distributed artificial intelligence. Many research on this subject findings have been applied to intelligent robots, and have achieved amazing results. NASA is exploring a multi-agent system known as swarmie for the exploration of extraterrestrial resources [1], each agent has a complete set of communication devices and sensors, it can independently discover potential value resources which can be explored by the partners they call after that. Such a system has a certain degree of robustness, even if part of it was damaged it would not be all paralyzed. The adaptive system research team of Harvard University designed a multi-robot system in 2014 to achieve complex behaviors such as self assembly just relying on the mutual communication between adjacent agents [2]. It is an ideal platform for studying complex systems and group behavior. The Autonomous Vehicle Emergency Recovery Tool (AVERT) studies the tasks which need agents closely coordinated to accomplish such as lifting weights, pushing boxes, etc. four robots based that tool can easily move and transport two tons of vehicles through collaboration [3].

These applications demonstrate the state of art of MAS. Pursuit problem is a growing field in MAS, with many applications such as search and rescue in disaster area, patrol on a larger scale and military combat. Cooperation formation of pursuers (agents hunting the evaders) is one of the key technologies of pursuit evasion. Because when multi-agent pursuit systems are facing multiple targets, it is bound for them to deal with the problem regarding the optimization of pursuers tasks coordination. It is optimization problem. For a multi-agent system, how to make all the pursuers turn material resources to good account relates to the difference of pursuers as well as that of evaders, and environmental dynamics, This problem is considered

as NP-hard problem and many novel and effective approach are proposed to solve this problem, one of which is to learn the each agent's attributes during the process of pursuit such as emotion model [4], Threshold method [5]. Mohammed El Habib Souidi, Piao Songhao came up a cooperation mechanism called agent group role membership function (AGRMF) model in 2015. [6] AGRMF learned from environment and the process of pursuit can reflect the membership between a pursuer and a group inspired by fuzzy logic principles, so that MAS will assign the tasks according to AGRMF instead of assigning them to any agent without considering their ability and position. This approach has proved to be effective, but it will be hard to set the main ability indicators [6] of each agent when the scale of MAS is too large which means there are many agents in a relative larger environment, what we want to do is make up for this deficiency.

This paper proposes a coalition formation mechanism of multi-agent pursuit based on neural network and AGRMF model, the pursuers use the special main ability indicators from AGRMF-ANN in face of given evaders, we apply the novel neural network AGRMF-ANN to abstract each pursuer's AGRMF feature and learn the main ability indicators, then the self-organizing map (SOM) fed by those features will create groups for pursuers, then pursuers in one group will be assigned their target according to AGRMF, in order to adjust the main ability indicators of AGRMF and other weights of all neural network, we come up the group attractiveness function (GAF) to evaluate the quality of groups and the pursuers contribution. Finally, we apply the markov decision process to promote pursuers get their own optimal motion planning after the formation generated during each iteration. [6]

The paper is organized as follows: in the section 2, we will introduce some related work about machine learning principles applications for multi-agent pursuit, in the section 3, we will describe the multi-agent pursuit problem in grid environment based on AGRMF model, the part of fea-

- Songhao Piao was with the School of Computer Science, Harbin Institute of Technology, Harbin, China, 150000.  
E-mail: piaosh@hit.edu.cn

tures extraction for pursuers and that of group generation will be discussed respectively in section 4 and section 5. The group attractiveness function will be deduced in section 6 as well as the network training process. The total algorithm inspired by our approach is showed in section 7.

## 2 RELATED WORK

There exist a lot of approaches based machine learning processing the pursuit-evasion problem. Taking into account the Reinforcement learning is considered as a famous process for solving motion optimization problem in the environment where agents can get delayed reward. In order to solve the problem in which the pursuers are at disadvantage regarding the motion speed in in comparison with the existing evaders, Mostafa D. Awgheda and Howard M. Schwartz use fuzzy reinforcement learning algorithm to learn different multi-pursuer single-superior-evader pursuit-evasion differential games with the capture region of the learning pursuer defined by Apollonius circle mechanism. [7] Ahmet Tunc Bilgin and Esra Kadioglu-Urtis proper a new approach based on Q learning with multiple agents characterized by independent learning. In their study, they also give the evaders the ability to learning optimized strategy from the environment. [8] Andrew Garland and Richard Alterman apply learning technology which can promote agents to use past runtime experience to solve coordination problems with personal goals, so that their future behavior can more accurately reflect past successes stored in their individual case. [9] To solve the problem regarding the identification of the best strategy to enclose an intruder for pursuers and adopt the huge environment, SHIMADA Yasuyuki and OHTSUKA Hirofumi discussed how to discretize patrol areas based on reinforcement learning. [10] Francisco Martinez-Gil and Miguel Lozano compared the two different learning algorithms based on Reinforcement learning :Iterative Vector Quantization with Q-Learning (ITVQQL) TS, Tile coding as the generalization method with the Sarsa(TS). The simulation results for pedestrian showed that the two RL framework had common advantage that they could generate emergent collective behavior which can help them arrive their destination collaborative. [11] Khaled M. Khalil and M. Abdel-Aziz designed a software framework for machine learning in interactive multi-agent systems based on Q-learning approach, this framework provides an interface for users to operate with the processes of agents learning activities and sharing information. [12]

Besides, many other approach such as neural network are also suitable for solving pursuit-evasion problem based on multi-agent system. Ding Wanga and Hongwen Ma focused on dealing with the existence of negative communication weights which can effect bipartite consensus in multi-agent system seriously and propose a distributed control algorithm based on RBFNN. [13] Jong Yih Kuo, and Hsiang-Fu Yu designed an adopt agent learning model including a special module called belief module which can help a pursuer learn plans from either success or failure experiences in the absence of environmental information. [14] Lin Zhao and Yingmin Jia applied the Lyapunov approach and graph theory on fault-tolerant parts included in controllers to

compensate the partial loss of actuator effectiveness faults. [15]

## 3 DESCRIPTION OF MULTI-AGENT PURSUIT PROBLEM

### 3.1 Pursuers

The set of pursuers is denoted by

$$P = \{p_1, p_2, \dots, p_n\}$$

. Each agent should be described by two additional Capacity parameters in order to determine membership function of AGR model:

**Self-conference Degree.** This parameter can reflect the ability of agents to play the role of pursuers which can be calculated by follows:

$$\forall Conf \in [0.1, 1] : \max(0.1, \frac{C_t}{C_s}) \quad (1)$$

where  $C_s$  is the number of tasks that the agent has finished with success

**Credit.** If there are tasks which the agent failed to finish, its credit will be influenced, the credit of an agent is denoted as follows:

$$\forall Credit \in [0.1, 1] : \min(1, 1 - \frac{C_b}{C_t - C_s}) \quad (2)$$

while  $C_b$  is the nubmer of tasks that the agent has to abandon.  $C_t$  is the number of tasks that the agent has participated.

distance from pursuer to evader in environment is a crucial criterion for the pursuit-evasion, because the pursuit will be easier if the pursuer is closer to the evader. The distance  $Dist$  between pursuer  $P$  and evader  $E$  is computed as follows:

$$Dist_{PE} = \sqrt{(cc_{P_i} - cc_{E_i})^2 + (cc_{P_j} - cc_{E_j})^2} \quad (3)$$

$(cc_{P_i}, cc_{P_j})$  is the Cartesian coordinates of the pursuer.  $(cc_{E_i}, cc_{E_j})$  is the Cartesian coordinates of the evader.

### 3.2 Evaders

The set of evaders is denoted by

$$E = \{e_1, e_2, \dots, e_n\}$$

each evader has its own pursuit difficulty which means how many pursuers are needed to catch that evader, the set of pursuit difficulty is denoted by

$$D = \{d_1, d_2, \dots, d_n\}$$

pursuer who catch evader  $e$  will get the reward which equal to  $d_e$ .

### 3.3 Organizer

This agent is the mainstay of the chase as it will create the chase groups and extract features of pursuers, therefore it is the place where AGRMF-ANN is deployed. The organiser should be trusted by all pursuers and can't disclose the parameters of pursuer to others.

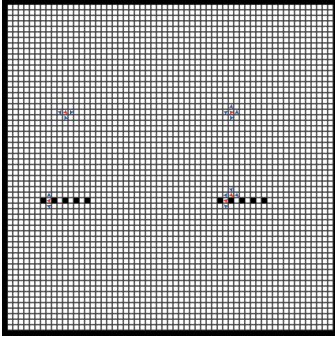

Fig. 1: instances of successful arrest

### 3.4 Rule of pursuit

One evader will be considered as arrested if the adjacent cells are occupied by other agents or obstacles as equation 4 and fig. 1.

$$d_n \leq \sum_{x \in neighbor(d_n)} P(x) + O(x) \quad (4)$$

Where  $neighbor(d_n)$  means the grid cells left to  $d_n$  or right to that, on top of  $d_n$  or under that.  $P(x)$  means the grid cell  $x$  is whether occupied by pursuers or not and  $O(x)$  means whether that is obstacle or not.

## 4 FEATURE EXTRACTION OF PURSUIT AGENTS

### 4.1 agent group role membership function

Agent group role membership Function (AGRMF) is an extension of agent-group-role model. Unlike other institutions, this approach allows agents to consider group as fuzzy set. Consequently, each group can be managed via the utilization of a membership function.

Instead of figuring out one explicit result that whether one special agent belongs to one of the groups or not comparing with ordinary AGR model, AGRMF admits degrees of membership to a given group. So that this change will provide more space to use different algorithm to optimize the result for the organization and more flexibility for re-organization comparing ordinary AGR model. Roles of one group can not be played by any agent without considering its property. The AGRMF( $\mu_{Group}(Agent)$ ) represents mission completion success probability as equation 5. The basic sequences of the coalition generation algorithm based on AGRMF model which is proposed by literature [16] is shown as algorithm 1.

$$\mu_{Group}(Agent) = \frac{Coe_f_1 * Pos + Coe_f_2 * Conf + Coe_f_3 * Credit}{\sum_{i=1}^3 Coe_f_i} \quad (5)$$

The main idea of this algorithm is to select the pursuer with the largest membership degree of target to join group. AGRMF is the most important part of the whole algorithm. the main ability indicators ( $Coe_f_1 - Coe_f_3$ ) which can reflect the contribution of each factor to the  $\mu_e$  and probability of pursuit success is critical parameters of each evader, the set of each evader own main ability of indicators will be hard to define when there are a large number of agents in

### Algorithm 1 getgroupofpursuers

---

**input:**  $U$  the set of vector of AGRMF of evader,  $n$  size of  $U$   
**output:** the list consisting of the set of pursuers take responsible for each pursuers

```

1: function GETGROUPOFPURSUEURS( $U, n$ )
2:   pursuersgorup: empty dictionary
3:   for each  $e \in E$  do
4:      $x \leftarrow 0$ 
5:     repeat
6:       for each  $p \in P$  do
7:         if ( $p \notin pursuergroup[e]$ ) &&  $u_e(p) = Max(u_e)$  then
8:           Add (pursuersgorup[e], p);
9:           Delete (P, p);
10:           $x \leftarrow x + 1$ 
11:         end if
12:       end for
13:     until  $x = e.d$ 
14:   end for
15: end function

```

---

large environment and it is not appropriate to set them as constants because of the variability of the environment. We will discuss the feature extraction part of our neural network which tries to solve this problem in the remainder of this section.

### 4.2 Convolutional Neural Network

BP network is a kind of multi-layer network which uses back propagation algorithm to learn from train set, the error of one layout will be propagated back to the previous one, so it will be calculated until it is propagated back from output layout to input layout, the weights' change is relay on the error of the layout which they belong to in order to make sure the output of the whole network approach the expectation. A fascinating characteristic of BP network is that it is able to find useful intermediate representations within the hidden layer inside the network. Any function can be approximated by a neural network with three layers with any small errors. [17]. But as far as practical applications are concerned, when the amount of data is large and the features of the samples are complex, it's a good idea to make the neural network thinner (that means more layers and less neurons of each layers), so convolutional Neural Network appeared.

CNN was proposed by leCun in literature [18] in 1989. Nowadays, CNN is widely applied image recognition, speech processing, artificial intelligence. The biggest difference between standard BP and CNN is that in CNN neurons adjacent layers are partial connected instead of fully connected, in other words, a neuron's sensing area comes from part of the previous layer as figure 3 and figure 2, rather than connect all neurons. The neurons of convolutional layers are also called filters. The formula for the forward calculation of the convolution layer are as follows:

$$x_j^l = f(\sum_{i \in M_j} X_i^{l-1} * k_{ij}^l + b_j^l) \quad (6)$$

The essence of the above is to let the convolution kernel do convolution on all associated feature maps in layer  $L - 1$ , and then sum up, plus a bias parameter, obtain the final excitation value inspired by activation function.

### 4.3 Feature Extraction of Pursuers

In this section, we will discuss the feature extraction part for pursuers of our neuron network, pursuer  $i$  can be represented by one feature vector

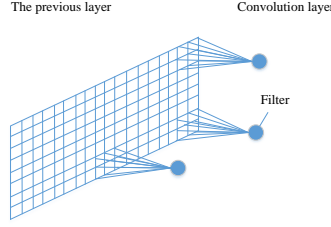
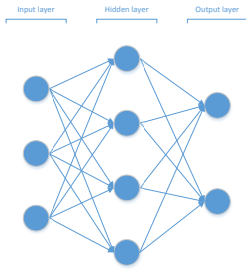

Fig. 2: BP neuron network Fig. 3: convolution neuron network

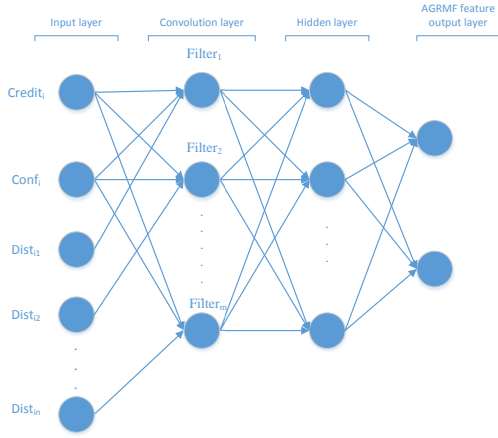

Fig. 4: feature extraction part for pursuers

$\vec{x}_i = \{Cedit_i, Conf_i, Dist_{i1}, Dist_{i2}, \dots, Dist_{im}\}$ , where the  $Dist_{im}$  means the distance between pursuer  $i$  and evader  $m$ . The input layer is followed by the convolutional layer. Each neuron of the convolutional layer is the filter of each pursuer, the filter of evader  $i$  just connects with  $Credit_i, Conf_i, Dist_{ij}$ . By means of convolution operations, stimulus of  $filter_j$  which also represents the  $\mu_j(i)$  is obtained by  $x_i$ . The weight of the filter represents the contribution rate of each attribute to the membership of the group and they can be regarded as main ability indicators, so the  $Coeff_1, Coef_2, Coef_3$  in equation 5 will be replaced by  $w_1, w_2, w_3$  of filters. Then, the hidden layer can improve the approximation ability of the neural network. The structure of this part is shown in Figure 4.

#### 4.4 Manual Data Synthesis

The number of input vectors collected by the method for each iteration proposed in section 4.3 is  $|P|$  which is not sufficient for training the neural network. We notice that the neighborhood of the pursuer can also well represent the characteristics of the agent as fig ?? when the scale of environment is large, the number of data can be increased from  $|P|$  to  $|P| * |Neighborhood|^{E|+1}$

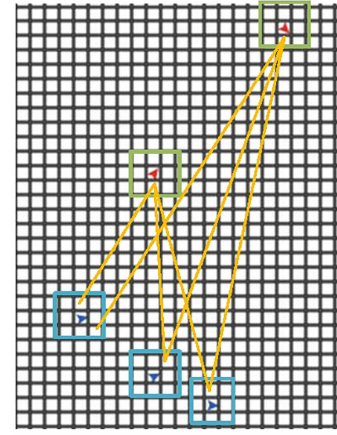

Fig. 5: Manual data synthesis

## 5 GROUPS GENERATION WITH FEATURE OF PURSUIT BASED ON SOM

### 5.1 Self Organized Map

The Self Organized Map is one of the most popular neural network models which is a type of unsupervised learning approach [19], SOM is widely applied for clustering data without knowing the class category of the input data. [20] the SOM is based on competitive learning network. Competitive learning network excavates characteristics of the input vector and cluster them. Provided training set as  $\{X^1, X^2, X^3, \dots, X^p\}$  without pre-assigned label, for each  $X$  in training set, the network outputs one winner node after competitive learning, not like the BP network outputs amplitude, the vector connected to the winner node will represent the  $X$ 's information best in the whole network, when one  $X$  input the network, there must be one node get the peak response, so the competitive learning is the process to make the winner node to get the peak response, output node  $i$  connects input node  $j$  with  $w_{ij}$ , for each  $X^p$ , define the response of output node  $i$  as equation 7

$$\sum_{j=1}^n W_{ij} * X_j = \vec{W}_i^T * \vec{X} \quad (7)$$

$y_i$  will be the winner node if it as equation 8.

$$y_i = \max_{k=1,2,3,\dots,m} (\vec{W}_k^T * \vec{X}) \quad (8)$$

which mean the node  $i$  get the peak response at this time, after normalizing the weights it is equivalent to expression 9.

$$|W_i - X_i| = \min(|W_i - X_i|) \quad (9)$$

The ordinary competitive learning network is enough to deal with the representative cluster problem, however, it is hard for it to deal with the huge input data set, the SOFM can overcome this shortcoming, [21] besides, making use of the topological structure of SOM, the relation between data can be clearly visualized. [22] A SOM maps the neurons upon one matrix of 2-dimensional or 3-dimensional generally just like fig 6. SOFM is based on the

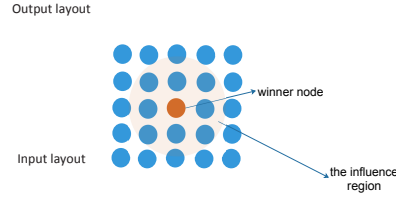
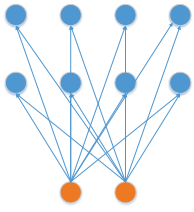

Fig. 6: structure of SOFM Fig. 7: influence region of winner neuron

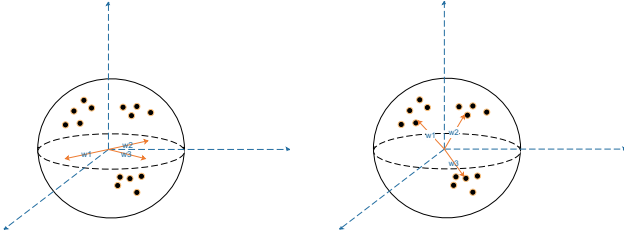

Fig. 8: network before trained Fig. 9: network after trained

competitive learning network but each neuron of output layout is connected closely with the neighboring neurons not like the basic competitive learning network where each neuron is independent. The connections is called lateral connections, each neuron has its own region of influence for each iteration as fig. 7. Each neuron compete with the neighboring neurons via lateral connections, the winner neurons will get the strongest inspirit and the neighboring neurons in its influence region will get the different inspirit or inhibition. The relative close neurons in the influence region will be inspirited by the winner neurons but the others be suppressed, the neurons out of the region will have no influence. By this way, the competition will be more effective, and the equation of weights' update will be changed as equation 10.

$$\begin{cases} w_{ji}(t+1) = w_{ji}(t) + \alpha(t)(x_i(t) - w_{ji}(t)) & j \in N_c(t) \\ w_{ji}(t+1) = w_{ji}(t) & j \notin N_c(t) \end{cases} \quad (10)$$

The  $\alpha(t)$  is learning rate, and  $N_c(t)$  is the region of influence, where  $t$  is the the number of current iteration they will change as equation 11 and equation 12 to make sure the network will achieve convergence.

$$\alpha(t) = \alpha(0)[1 - \frac{t}{T}] \quad (11)$$

$$N_c(t) = INT[N_c(0)(1 - \frac{t}{T})] \quad (12)$$

Actually,the competitive learning is the process of the weights of node to approach the center of group, just as fig.8 and fig.9 where the input space is a 2-dimensional space,  $w_1, w_2$  and  $w_3$  are weight vectors .

## 5.2 SOM Layer for Group Generation

The idea of our Generation group algorithm is to assign the pursuers with similar AGRMF feature vectors to the same group without requiring predefined number of group. Therefore, the SOM layer is added after feature extraction

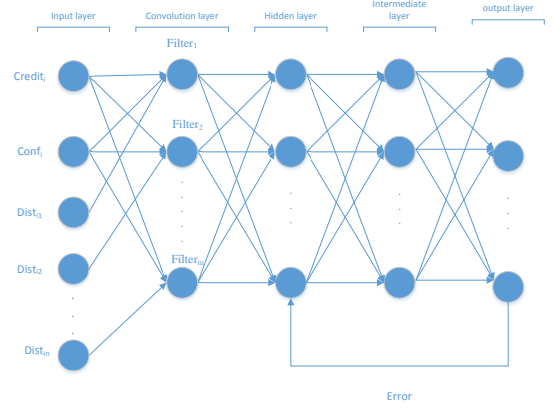

Fig. 10: neuron network for Coalition Formation

part. The complete construction of neuron network for coalition formation is shown as figure 10. The intermediate layer is output layer of AGRMF features as well as input layer of Generation Groups,The weights connecting the intermediate layer and output layer updates as equation 10. Error is passed from the output layer to the hidden layer which will be discussed in section 6. The weight vector of each neuron can fully represent the center of AGRMF features of pursuers whose winner neuron is that neuron When the neural network converges. The algorithms steps of training the SOM inspired by AGRMF feature vectors and getting final group result is presented as algorithm 2.

### Algorithm 2 getgroupofevaders

---

**input:**  $FU$  the set of AGRMF feature vectors of pursuers,  $n$  size of  $FU$   
**output:** the list consisting of index of group each pursuer's belongs to

```

1: function GETGROUPOFPURSUERS( $FU, n$ )
2:   List:empty list
3:    $\lambda$ :time of iteration
4:    $m$ :the number of output neuron
5:   for  $j$  0 to  $m$  do
6:     random initialize  $W_j$ 
7:   end for
8:   repeat
9:      $k \leftarrow 0$ 
10:    repeat
11:       $i \leftarrow 0$ 
12:       $f\mu_i \in FU$ 
13:       $o := win(W, f\mu_i)$ 
14:      updateweight( $o$ )
15:       $i \leftarrow i + 1$ 
16:    until  $i = n$ 
17:     $k \leftarrow k + 1$ 
18:  until  $k = \lambda$ 
19:  repeat
20:     $i \leftarrow 0$ 
21:     $f\mu_i \in U$ 
22:     $o := win(W, f\mu_i)$ 
23:    add( $o$ ,List)
24:     $i \leftarrow i + 1$ 
25:  until  $i = n$ 
26:  return List
27: end function

```

---

The algorithms steps are explained in the following manner:the step 2 to 7 is used to initialize the parameters and SOM, the step 8 to 18 is the learning process of SOFM where step 13 is inspired by equation 9 and step 14 is inspired by equation 10. Finally the list consisting of index of group each pursuer belongs to will be generated. The pursuers who get the same output from SOFM will be assigned to the same group,the pursuers of group  $g$  decides their target evader  $e$

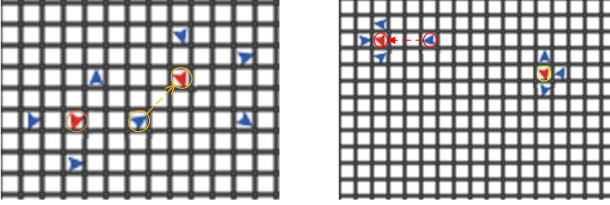

Fig. 11: status before reorga-Fig. 12: status after reorganization

according to their AGRMF as equation 13. each group will only own one target at the same time. Groups that have the same target will be merged into one group.

$$e = \max_{arg} \sum_{p \in g} (\mu_{e_1}(p), \mu_{e_2}(p) \dots \mu_{e_n}(p)) \quad (13)$$

## 6 TRAINING ALGORITHM OF OUR NEURAL NETWORK

### 6.1 group attractiveness function

Group attractiveness function (GAF) is proposed to evaluate the correctness of the coalition formation obtained by the neural network. Assigning a pursuer to a group that is attractive to it will be considered as a correct decision. Group  $g$ 's GAF for  $p'$  will be directly proportional to the difficulty of its target  $d$ , the AGRMF  $\mu_{p'}(G)$ , it is also inversely proportional to the sum of the distances from the pursuers to the target which will represent the difficulty of pursuit at current status. the  $GAF_g(p')$  is shown as equation. 14

$$GAF_g(p') = \frac{\mu_g(p') * d}{\sum_{p \in g} dis(p, E)} \quad (14)$$

It is beneficial to the promotion of the efficiency of the MAS that each pursuer leaves the original group to pursue the growth of its own interests [23], that is the meaning of reorganization. Each agent has to make a decision between the interests in the original group  $GAF_g(p)$  and the interests in the other groups  $\frac{\sum_{g \in \{G-g\}} (GAF_g(p))}{|G-g|}$ , the result also are determined by inertial factor  $c_p$  which represent the nature of pursuers to keep in origin group, This factor between 0 and 1 can be used to control the speed of the reorganization. The coalition evaluation function (CEF) is shown as equation 15.

$$\begin{cases} CEF(p) = 1 & C_p * GAF_g(p) > (1 - C_p) \frac{\sum_{g \in \{G-g\}} (GAF_g(p))}{|G-g|} \\ CEF(p) = 0 & C_p * GAF_g(p) < (1 - C_p) \frac{\sum_{g \in \{G-g\}} (GAF_g(p))}{|G-g|} \end{cases} \quad (15)$$

The role of CEF is shown in figure 11 and 12. there are two target with same value, The left target need 4 pursuers to capture but only 3 pursuers was suit to be assigned to catch it, lack of pursuer will cause the loss of this target, on the contrary, 3 pursuers are enough to catch the right target though there are 4 pursuers including the one with yellow circles. Suppose the inertial factor of that pursuer is 0.5. CEF will imply that agent whose AGRMF reached a certain standard to leave origin group and join another group this will be considered a better solution. coalition formation will be translated into classification problem with the effect of CEF, how to train AGRMF-ANN will be discussed in the next subsection.

## 6.2 Back propagation based on CEF

The learning algorithm of AGRMF feature extraction is a new back-propagation algorithm based on CEF, the label for each train sample of pursuer  $p$  can be defined according to  $CEF(p)$  which is calculated in last iteration. So the loss function can be shown as equation 15.

$$E(\vec{w}) = \frac{1}{2} (CEF(p) \sum_{d \in D} \sum_{k \in output}^q (win_k(d) - o_k(d))^2 + (1 - CEF(p)) (\sum_{d \in D} \sum_{k \in output}^q (win'_k(d) - o_k(d))^2) \quad (16)$$

$d$  is the feature vector of pursuer  $p$ ,  $o_k(d)$  is the output vector of AGRMF feature extraction part as well as the input vector of SOM layer for  $o_k(d)$ .  $w_o(k)$  is the weights of the winner neuron in SOM layer,  $w'_o(k)$  is the weights of the neuron of group  $g'$  which is  $\max_{arg} GAF(p)$ ,  $CEF(p)$  can be treated as a constant because it is a part of label and can not be changed at current iteration,  $E(\vec{w})$  is a continuous derivated function so that the back propagation algorithm can be used to update the weights of feature extraction part of AGRMF-ANN as equation 17.

$$\delta(w) = -\eta \nabla_w \frac{1}{2} (CEF(p) \sum_{d \in D} \sum_{k \in output}^q (win_k(d) - o_k(d))^2 + (1 - CEF(p)) (\sum_{d \in D} \sum_{k \in output}^q (win'_k(d) - o_k(d))^2) \quad (17)$$

## 7 SEQUENCES OF OUR COALITION ALGORITHM

### Algorithm 3 complete algorithm

---

```

1: initialize the neuron network
2: repeat
3:   for each  $e \in E$  do
4:     Broadcast (e.Pos, e.Re);
5:     Waiting-Response
6:   end for
7:   for each  $p \in P$  do
8:     SendResponse( $\vec{x}_p$ )
9:   end for
10:  GetResponse(X)
11:  train the SOM layer
12:  create-group()
13:  SendMessage(e,  $GAF$ )
14:  Waiting-Response()
15:  for each  $p \in P$  do
16:    SendResponse(CEF)
17:    if  $p.e \neq e$  then
18:      p.life = 0
19:    end if
20:     $p.e \leftarrow e$ 
21:    Launch of the chase
22:    p.life = p.life + 1
23:    if  $e.captured = true$  then
24:       $p.C_t \leftarrow p.C_t + 1$ 
25:       $p.C_s \leftarrow p.C_s + 1$ 
26:    end if
27:    if  $p.life = life$  then
28:       $p.C_t \leftarrow p.C_t + 1$ 
29:       $p.C_b \leftarrow p.C_b + 1$ 
30:    end if
31:  end for
32:  GetResponse( $\vec{CEF}$ )
33:  Train the feature extraction part
34: until  $\forall e \in E e.captured = true$ 
    
```

---

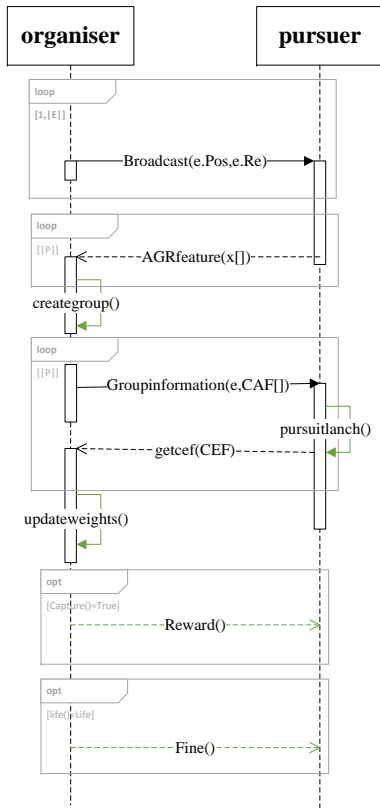

Fig. 13: sequences diagram of communications

The coalitions are short-lived and goal-oriented [6]. If a coalition lasts longer than the default requirement *life*, it will be considered as a failure. The algorithms shown in Algorithm 3 are explained in the following manner: The organizer initializes the neuron network (01). Then the pursuers start to catch evaders under the coordination of organizers until all evaders are captured (02-33). The organizer broadcasts position and value of each evader found in environment and waits the response from pursuers (03-06). The pursuers respond with their own feature vector  $\vec{x}_p$  (07-09). The organizer trains the SOM layer with the set of feature vectors  $X$  and sends target and  $\vec{GAF}$  to each pursuer after creating group  $p$  (10-14). The pursuer  $p$  responds with their  $CEF(p)$  and starts to get close to its target (15-30). The organizer trains its feature extraction part with  $\vec{CEF}$  (31-32). The sequence diagram describing organizer and pursuer communications is shown in Figure 13.

## 8 SIMULATION EXPERIMENT

Some experiments were done to verify the effectiveness of our overall algorithm, that of feature extraction part and that of group generation part separately. The pursuit environment in these simulations is a grid environment with 100 \* 100 grids, with 16 pursuers and 2 evader with  $d = 4, 1$  evader with  $d = 3, 1$  evader with  $d = 2$ . The evaders disappeared after being captured and the pursuers who captured them disappeared as well. We choose the algorithm based on principles of MDP which was proposed in literature [6] as motion strategy of pursuers.

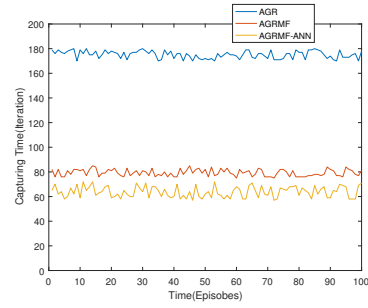

Fig. 14: Comparison of capture time

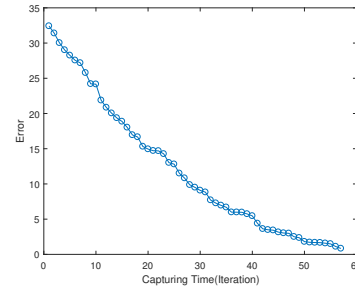

Fig. 15: development of the error

**Experiment 1.** This experiment verifies the feasibility of coalition formation of our algorithm based on AGRMF. Figure 14 shows the result of three different ways which are explained below after 100 experiments for each case:

- Case AGR : formation of the groups without mechanism integration (without membership function) based on AGR model referred to in literature [6]
- Case AGRMF : formation and reformation of the groups with the application of the coalition algorithm which was proposed in literature [6] before any new chase iteration
- Case AGRMF-ANN : coalition formation with the application of our coalition algorithm based on case AGRMF.

In case AGR, the capture of all evaders has consumed an average of 175.15 chase iterations. For case AGRMF, capture of evaders is performed after an average of 79.32 chase iterations. For case AGRMF-ANN, capture of the evaders is achieved after an average of 63.81 chase iterations. On the other hand, the error  $E$  of feature extraction of AGRMF-ANN's when it converges or stops its learning process for each iteration is shown as Figure 15, when the evaders are caught or when pursuers change their targets, the error drops quickly, this part proves that our algorithm for reorganization can promote pursuers pursuit the targets which can cause the error to reduce from a new state of AGRMF-ANN.

**Experiment 2.** This experiment mainly tests the function of feature extraction part of AGRMF-ANN according to comparison between two cases:

- case 1 : AGRMF-ANN without feature extraction part which means main ability indicators should never change and group generation part creates coalitions according to AGRMF directly.

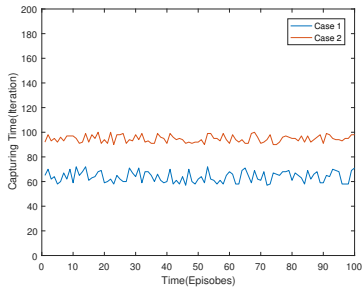

Fig. 16: capture time of feature extraction inspired by different algorithms

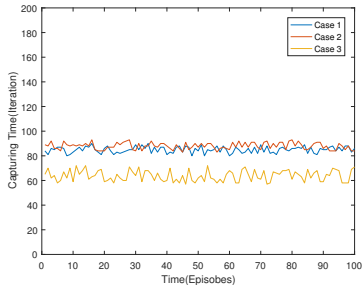

Fig. 17: capture time of group generation inspired by different approaches

- case 2 : AGRMF-ANN.

The average chase iterations for case 1 is 94.650.

**Experiment 3.**We pick up KMEANS and DBSCAN which represent the cluster algorithms based on partition and density respectively as contrasting objects to explain the advantage of group generation part inspired by our algorithm. These approaches all have their own advantage for data set with different characteristic. [24] However, for this kind of problem, the algorithm inspired by SOM perform best as shown in fig. 17. the result shows the density and the number of centers are changing dynamically during the process of chase, the competitive neuron network has a better ability to adapt to this change.

**Experiment 4.**In order to validate our algorithm’s ability to adapt to larger environments, we designed experiment 4. the number of pursuers and evaders scaled up as well as the size of environment on the basis of the previous environment. the capture time of the three case is shown as figure 18. Growth of rate of decline for capture time of case AGRMF-ANN compared with case AGRMF can be represented by a linear shown in figure 19. Because AGRMF - ANN can learn the attributes of some agents in the previous environment, it has advantages in the face of larger environments.

## 9 CONCLUSION

In this paper coalition formation for multi-agent pursuit based a novel neuron network called AGRMF-ANN consisting of feature extraction part and group generation part for to learn main ability indicators of AGRMF model is discussed. Besides, learning algorithm of AGRMF based on group attractiveness function(GAF) is also proposed. The

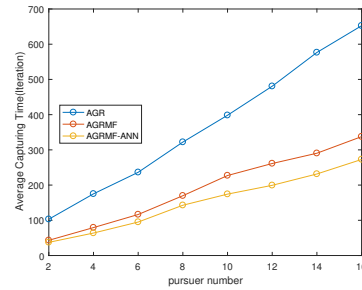

Fig. 18: development of capture time

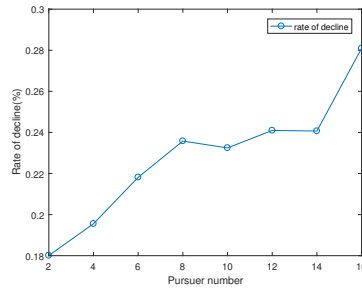

Fig. 19: rate of decline compared with AGRMF

simulation results shows effect on the capture time comparing with AGRMF and the two part effectiveness. Next, we will work to solve excessive load of originaser because the entire network is deployed on it and try to design an approach based on AGRMF-ANN can be applied for the environment of continuous space.

## FUNDING

This paper is supported by National Natural Science Foundation of China [grant number 61375081]; a special fund project of Harbin science and technology innovation talents research [grant number RC2013XK010002].

## REFERENCES

- [1] Ducan B, Ulam P, behavior as a model for multi-robot systems[C]. Robot and Biomimetics (ROBIO), 2009 IEEE International Conference on. 2009:25-32
- [2] Michael Rubenstein, Alejandro Cornejo, Radhika Nagpal. Programmable self-assembly in a thousand-robot swarm[J]. Science, 2014, 345(6178):795-799
- [3] Richard May, Ing Bernd Bickcht, The avert project[EB/OL]. (2015-3-1)[2016-1-5] <http://new.avertproject.eu/>.
- [4] de Oliveira D, Jr. P R F, Bazzan A L C. A Swarm Based Approach for Task Allocation in Dynamic Agents Organizations[J]. Autonomous Agents and MultiAgents Systems, International Joint Conference on, 2004, 3:1252-1253
- [5] Gage A, Murphy R R. Affective Recruitment of Distributed Heterogeneous Agents[C]. Proceeding of the 19th National Conference on Artificial Intelligence, 2004:14-19
- [6] Mohammed El Habib Soudi, Piao Songhao. (2015) Multi-agent cooperation pursuit based on an extension of AALAADIN organisational model. Journal of Experimental Theoretical Artificial Intelligence
- [7] MD Awgheda, HM Schwartz. A. Decentralized Fuzzy Learning Algorithm for Pursuit-Evasion Differential Games with Superior Evaders Kluwer Academic Publishers, 2016, 83(1):35-53
- [8] AT Bilgin E Kadioglu-Urtis. An Approach to Multi-Agent Pursuit Evasion Games Using Reinforcement Learning. International Conference on Advanced Robotics, 2015:164-169



- [9] AA Garland R. Alterman. Autonomous Agents that Learn to Better Coordinate. *Autonomous Agents and Multi-Agent Systems*. 2004, 8(3):267-301
- [10] S Yasuyuki, O Hirofumi. Cooperative Capture by Multi-Agent using Reinforcement Learning application for security patrol systems. *Asian Control Conference*, 2015
- [11] F Martinez-Gil, M Lozano. Emergent collective behaviors in a multi-agent reinforcement learning pedestrian simulation: a case study. *International Workshop on Multi-agent-based Simulation*, 2014, 9002:228-238
- [12] KM Khalil, M Abdel-Aziz. MLIMAS: A Framework for Machine Learning in Interactive Multi-Agent Systems. *Procedia Computer Science*, 2015, 65:827-835
- [13] D Wang, H Ma, D Liu. Distributed control algorithm for bipartite consensus of the nonlinear time-delayed multi-agent systems with neural networks. *Neurocomputing*, 2016, 174:928-936
- [14] JY Kuo, HF Yu. Multiagent Cooperative Learning Strategies for Pursuit-Evasion Games. *Mathematical Problems in Engineering*, 2015, 2015(2):1-13
- [15] ZYJ Lin. Neural network-based adaptive consensus tracking control for multi-agent systems under actuator faults. *International Journal of Systems Science*, 2014, 47(8):1-12
- [16] Mohammed El Habib Souidi, Piao Songhao. (2015) Multi-agent cooperation pursuit based on an extension of AALAADIN organisational model. *Journal of Experimental Theoretical Artificial Intelligence*
- [17] Cybenko G. Continuous valued neural networks with two hidden layers are sufficient (Technical Report). Department of Computer Science. Tufts University. Medford, MA
- [18] Backpropagation applied to handwritten zip code recognition
- [19] IM Stephanakis, IP Chochliouros. Anomaly Detection In Secure Cloud Environments Using a Self-Organizing Feature Map (SOFM) Model For Clustering Sets of R-Ordered Vector-Structured Features *International Conference*, 2015:1-9
- [20] J Vesanto, E Alhoniemi. Clustering of the Self-Organizing Map. *IEEE Transactions on Neural Networks*, 2000, 11(3):586-600
- [21] R Nakao, T Abe, S Funayama. Horizontally Transferred Genetic Elements in the Tsetse Fly Genome: An Alignment-Free Clustering Approach Using Batch Learning Self-Organising Map (BL-SOM). *Biomed Research International*, 2016.
- [22] E Mohebi, A Bagirov. Constrained Self Organizing Maps for Data Clusters Visualization. *Neural Processing Letters*, 2016, 43(3):849-869
- [23] Mohammed El Habib Souidi, Piao Songhao. (2015). A New Decentralized Approach of Multiagent Cooperative Pursuit Based on the Iterated Elimination of Dominated Strategies Model. *Mathematical Problems in Engineering*, 2016, 2016 (3) :1-11
- [24] Karishmatyagi, Viet Dadri. A Comparison of Sofm With K-Mean Clustering And Ann Pattern Reorganization: A Review. *International Journal of Engineering Research and Development* e-ISSN: 2278-067X, p-ISSN: 2278-800X, www.ijerd.com Volume 7, Issue 3 (May 2013), PP. 44-55