

Spectral Domain Sampling of Graph Signals

Yuichi Tanaka, *Member, IEEE*

Abstract—Sampling methods for graph signals in the graph spectral domain are proposed. Conventional sampling of graph signals can be regarded as sampling in the graph vertex domain, but it does not have desired characteristics in regard to the graph spectral domain. Down- and upsampled graph signals by using our methods inherit the frequency domain characteristics of sampled signals defined in the time/spatial domain. Properties of the sampling effects are studied theoretically and experimentally in comparison with the conventional sampling method in the vertex domain. Fractional sampling and Laplacian pyramid of graph signals are also shown as possible applications.

Index Terms—Graph signal processing, sampling, graph Fourier transform, graph Laplacian pyramid, fractional sampling

I. INTRODUCTION

A. Motivation

Sampling is a fundamental tool in digital signal processing [1]–[4]. It converts rates of a signal and is a key tool for multirate signal processing. For signals in the time or spatial domain, e.g., audio, speech, and image signals, the definition of sampling is very intuitive; that is, for downsampling by two, every other sample is taken, and for upsampling, zeros are inserted between two samples.

In the frequency domain, downsampling broadens the bandwidth [3]–[6], thereby causing aliasing of non-bandlimited signals. On the other hand, upsampling narrows the bandwidth and creates imaging components at the same time. To avoid such aliasing and imaging, a low-pass filter is applied to signals before downsampling and after upsampling.

This intuitive sampling way is also always considered in graph signal processing [7], [8], which is a rapidly growing research area concerning signal processing. Many potential applications of graph signal processing, for example, analyzing, restoring, and compressing signals on irregularly structured networks (such as data on social/transportation/neuronal networks, point cloud attributes, and multimedia signals), have been found [9]–[21].

A graph signal is defined as a discrete signal $\mathbf{f} \in \mathbb{R}^N$ whose n th sample $f[n]$ is located on the n th vertex of a graph (graph and graph signal are formally defined later). In graph signal processing, downsampling corresponds to reducing the size of the graph as well as reducing the number of samples. Upsampling corresponds to expanding the graph as well as increasing the number of samples. Many approaches to reduce the size of graphs, which try to keep (some of) the

characteristics of the original graph, have been proposed [22]–[29]. However, few approaches for increasing the size of the graph have been proposed, since it is necessary to estimate the characteristics of the expanded graph [30], [31].

In regard to signal processing and (spectral) graph theory, several techniques for reducing graph size have been proposed; however, sampling of a graph signal itself has been limited to an intuitive way, namely, just keeping the original signal values on the vertices that remain in the reduced-size graph. This approach can be regarded as “vertex domain-based,” and it has an intuitive relationship with its counterpart for time domain signals. However, as mentioned later, *vertex domain sampling does not inherit the frequency domain properties of sampled signals in the time domain*. This fact could be a problem when multirate systems for graph signals (like graph wavelets and filter banks) [25], [30], [32]–[42] and multiscale transforms [28], [31] are designed, since we cannot utilize our knowledge on classical signal processing. Therefore, the sampling of graph signals has to be carefully considered and designed to satisfy the frequency domain requirements.

In this study, methods for sampling graph signals in the graph spectral domain are proposed. The sampled graph signals with our methods naturally inherit the frequency characteristics of time domain signals, e.g., increased (decreased) bandwidths. Additionally, vertices in the original graph and those in the reduced (increased) graph do not necessarily have a one-to-one relationship. To intuitively understand the proposed sampling approach, properties of graph signals sampled in the graph spectral domain are experimentally determined and compared with those sampled by the vertex domain method. In comparison with vertex domain sampling, the proposed sampling method is applied to fractional sampling and Laplacian pyramid representation for graph signals.

This paper is organized as follows. The following subsections clarify our contributions and give notations and preliminaries concerning graph signal processing. Sampling methods for classical signal processing and conventional vertex domain sampling are introduced in Section II. The proposed sampling methods are presented in Section III. Effects of spectral domain sampling with signals on some graphs are demonstrated in Section IV. A few potential applications of the proposed method in comparison with the existing approach are given in Section V. Finally, the conclusions of this study are presented in Section VI.

B. Related Works

Downsampling of graph signals in the vertex domain has been extensively studied. In this study, we assume that the sampled signal is also a graph signal; that is, the sampled signal must have a corresponding reduced- or increased-size

This work was supported in part by JST PRESTO under Grant JP-MJPR1656.

The author is with Graduate School of BASE, Tokyo University of Agriculture and Technology, Koganei, Tokyo, 184-8588 Japan, and also with PRESTO, Japan Science and Technology Agency, Kawaguchi, Saitama, 332-0012, Japan (email: ytnk@cc.tuat.ac.jp).

graph. Several methods for reducing graph size have been proposed. For example, graph coloring [25], [29], [33], [43], Kron reduction [26], [28], maximum spanning trees [27], weighted max-cut [22], and graph coarsening using algebraic distance [23] select vertices remaining after downsampling and reconnect them if needed. These examples are vertex domain methods and usually need one-to-one mapping from vertices of the reduced-size graph to those of the original graph. A method for multiscale graph reduction that does not necessarily need one-to-one mapping (but is still a vertex domain downsampling) was proposed by Tremblay and Borgnat [41]. The relationship between the downsampling-then-upsampling operation in the vertex domain and the DFT domain counterpart when the downsampling and upsampling were performed for a specific graph (called Ω -structure in [40]) was revealed by Teke and Vaidyanathan [40]. However, these proposals were based on a vertex domain approach.

The contributions in this paper are summarized below:

- Vertex domain sampling is shown not to inherit the desirable spectral properties.
- Sampling of graph signals defined on the graph spectral domain is proposed for the first time.
- The proposed sampling methods have spectral domain characteristics expected as a counterpart of sampling in the frequency (i.e., DFT) domain.

C. Notations

A graph \mathcal{G} is represented as $\mathcal{G} = (\mathcal{V}, \mathcal{E})$, where \mathcal{V} and \mathcal{E} denote sets of nodes and edges, respectively. Number of nodes is given as $N = |\mathcal{V}|$, unless otherwise specified. The (m, n) -th element of adjacency matrix \mathbf{A} is w_{mn} if m and n are connected, or zero otherwise, where w_{mn} denotes the weight of the edge between m and n . Degree matrix \mathbf{D} is a diagonal matrix, and its m th diagonal element is $d_{mm} = \sum_n w_{mn}$.

Graph signal processing uses different variation operators according to applications and assumed signal and/or network models. Hereafter, the variation operator considered is a combinatorial graph Laplacian for a finite undirected graph with no loops or multiple links $\mathbf{L} := \mathbf{D} - \mathbf{A}$. However, it is extended to other variation operators, such as an adjacency matrix, with slight modifications as long as the target variation operator is diagonalizable.

The key symbols are listed as follows:

- 1) $\mathbf{f} \in \mathbb{R}^N$: Graph signal. The n th sample $f[n]$ is located on the n th vertex of the graph.
- 2) \mathbf{u}_i : The i th eigenvector of \mathbf{L} .
- 3) λ_i : The i th eigenvalue of \mathbf{L} , i.e., $\mathbf{L}\mathbf{u}_i = \lambda_i\mathbf{u}_i$.

Since \mathbf{L} is a real symmetric matrix, \mathbf{L} is always decomposed into $\mathbf{L} = \mathbf{U}\mathbf{\Lambda}\mathbf{U}^*$, where $\mathbf{U} = [\mathbf{u}_0, \dots, \mathbf{u}_{N-1}]$ is the orthogonal matrix, $\mathbf{\Lambda} = \text{diag}(\lambda_0, \lambda_1, \dots, \lambda_{N-1})$, and \cdot^* represents the conjugate transpose of a matrix. In this paper, λ_i is often called *graph frequency*. Although the order of the eigenvectors is arbitrary, it is usually ordered as $0 = \lambda_0 < \lambda_1 \leq \dots \leq \lambda_{N-1} = \lambda_{\max}$ for connected graphs. Hereafter, this order is

used unless otherwise specified. The graph Fourier transform is defined as

$$\tilde{f}[i] = \langle \mathbf{u}_i, \mathbf{f} \rangle = \sum_{n=0}^{N-1} u_i^*[n]f[n]. \quad (1)$$

II. REVIEW

First, sampling of time domain signals in classical signal processing is reviewed. Then, its intuitive counterpart in graph signal processing is presented.

A. Sampling of Classical Signal Processing

In classical signal processing, sampling is very intuitive. Down- and upsampling of one-dimensional signals in both the time and frequency domains is reviewed in the following. For the sake of simplicity, \mathbf{f} is assumed to be an ordinary time domain signal with N samples.

First, downsampling is defined. For simplicity, it is assumed that the length of the original signal, N , is a multiple of downsampling factor M . Let $F[k] := \sum_{n=0}^{N-1} f[n]e^{-j\frac{2\pi k}{N}n}$ be the DFT of time domain signal \mathbf{f} . The following sampling strategies are illustrated in Fig. 1.

Definition 1 (Downsampling). *When a time domain signal $\mathbf{f} \in \mathbb{R}^N$ is downsampled to $\mathbf{f}_d \in \mathbb{R}^{N/M}$, the following statements (D1)–(D3) are equivalent [1]–[4].*

(D1) *Time domain*: Keeping every M th sample.

$$f_d[n] = f[Mn]. \quad (2)$$

(D2) *Frequency domain (index)*: Keeping every M th sample of the DFT spectrum $F[k]$ and summing aliasing terms.

$$F_d[k] = \sum_{p=0}^{M-1} F\left[\frac{pN}{M} + k\right]. \quad (3)$$

(D3) *Frequency domain (spectrum)*: Sampling the stretched discrete-time Fourier transform (DTFT) spectrum $F(\omega) = \sum_{n=0}^{N-1} f[n]e^{-j\omega n}$.

$$F_d[k] = F_D\left(\frac{2\pi M}{N}k\right) \quad (4)$$

where

$$F_D(\omega) = \frac{1}{M} \sum_{p=0}^{M-1} F\left(\frac{\omega - 2\pi p}{M}\right). \quad (5)$$

The upsampling operator can be similarly defined as follows and it is illustrated in Fig. 2.

Definition 2 (Upsampling). *The following statements, (U1)–(U3), concerning upsampling of a time domain signal $\mathbf{f} \in \mathbb{R}^N$ by L into $\mathbf{f}_u \in \mathbb{R}^{NL}$ are equivalent to each other [3].*

(U1) *Time domain*: Inserting zeros.

$$f_u[n] = \begin{cases} f[n/L] & \text{if } n = mL \\ 0 & \text{otherwise.} \end{cases} \quad (6)$$

(U2) *Frequency domain (index)*: Repeating the DFT spectrum L times.

$$F_u[pN + k] = F[k] \quad (7)$$

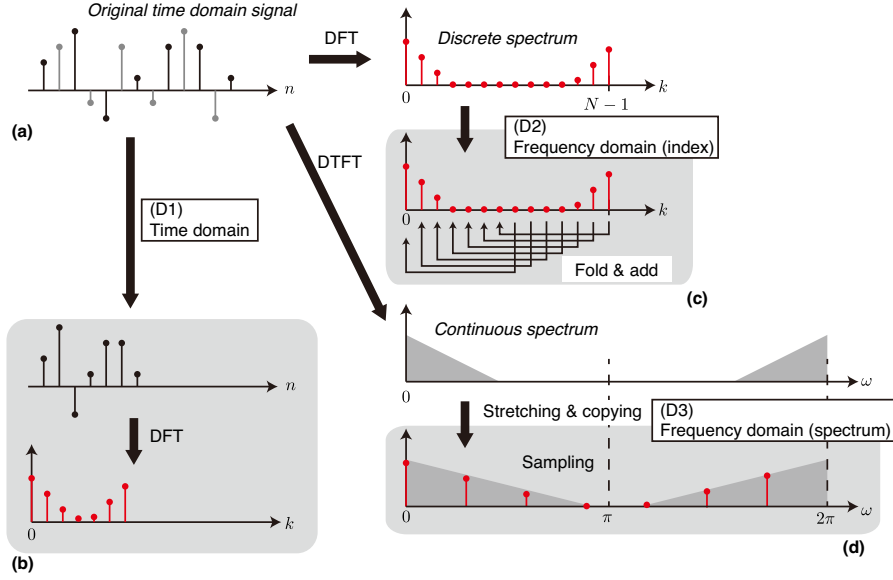

Fig. 1. Downsampling of time domain signals. The signal is downsampled by two and bandlimited. The shaded areas represent identical signals. (a) Original signal. The gray-colored samples are removed. (b) Downsampling strategy (D1): direct downsampling in the time domain. (c) Downsampling strategy (D2): frequency domain downsampling based on the signal index. (d) Downsampling strategy (D3): frequency domain downsampling based on the continuous spectrum.

where $p = 0, 1, \dots, L - 1$.

(U3) *Frequency domain (spectrum)*: Sampling the compressed DTFT spectrum $F(\omega)$.

$$F_u[pN + k] = F\left(\frac{2\pi}{N}k\right) \quad (8)$$

where $p = 0, 1, \dots, L - 1$.

Definitions 1 and 2 are always true in classical signal processing because DFT spectrum $F[k]$ is the sampled version of $F(\omega)$ with equal interval $\frac{2\pi}{N}$; i.e., $F[k] = F\left(\frac{2\pi}{N}k\right)$.

B. Vertex Domain Sampling of Graph Signals

The conventional and widely used method for sampling graph signals in the vertex domain, which corresponds to the intuitive counterpart of (D1) and (U1) in classical signal processing, is defined as follows:

Definition 3 (Downsampling of graph signals in vertex domain). Let \mathcal{G}_0 and \mathcal{G}_1 be the original graph and the reduced-size graph, respectively, where every vertex in \mathcal{G}_1 has one-to-one correspondence to one of the vertices in \mathcal{G}_0 . The original signal is $\mathbf{f} \in \mathbb{R}^N$. In the vertex domain, downsampling of \mathbf{f} to $\mathbf{f}_d \in \mathbb{R}^{|\mathcal{V}_1|}$ is defined as follows.

(GD1) *Vertex domain*: Keeping samples in \mathcal{V}_1 .

$$f_d[n] = f[n'] \text{ if } v_{n'} \in \mathcal{V}_0 \text{ corresponds to } v_n \in \mathcal{V}_1. \quad (9)$$

Definition 4 (Upsampling of graph signals in vertex domain). \mathcal{G}_0 and \mathcal{G}_1 are the same as Definition 3. The original signal at this time is $\mathbf{f} \in \mathbb{R}^{|\mathcal{V}_1|}$ and its sample is associated with \mathcal{G}_1 . Upsampling in the vertex domain, i.e., mapping from \mathbf{f} to $\mathbf{f}_u \in \mathbb{R}^N$, is defined as follows.

(GU1) *Vertex domain*: Placing samples on \mathcal{V}_1 into the corresponding vertices in \mathcal{G}_0 .

$$f_u[n] = \begin{cases} f[n'] & \text{if } v_{n'} \in \mathcal{V}_1 \text{ corresponds to } v_n \in \mathcal{V}_0 \\ 0 & \text{otherwise.} \end{cases} \quad (10)$$

C. Illustrative Examples

Problems specific to graph signal processing are described with a few intuitive examples as follows.

The classical case is the first example. In this case, it is assumed that a time domain signal is bandlimited: \mathbf{f} has zero response at $\omega > |\pi/M|$. After downsampling by M , the spectrum of \mathbf{f}_d is stretched by M . If the signal is *not* bandlimited, aliasing occurs. Since (D1)–(D3) are equivalent, they present the same stretching effect.

In contrast, this equivalence is not the case for vertex domain sampling of graph signals. The spectra of the graph signal sampled by (GD1) and (GU1) are represented as $\tilde{\mathbf{f}}_d = \mathbf{U}_1^* \mathbf{f}_d$ and $\tilde{\mathbf{f}}_u = \mathbf{U}_0^* \mathbf{f}_u$. Indeed $\tilde{\mathbf{f}}_d$ ($\tilde{\mathbf{f}}_u$) depends on the original and reduced-(increased)-size graph Laplacians and the method used for graph reduction (expansion). Therefore, two simple cases are considered: ring and path graphs¹. It is assumed that N is even and the downsampling/upsampling ratio is 2. Furthermore, it is also assumed that the size of the graph is reduced (or increased) in the most-natural way: Every other vertex is taken for downsampling, and a vertex is placed between every pair of vertices for upsampling. The spectra $\tilde{\mathbf{f}}_d$ sampled by (GD1) and $\tilde{\mathbf{f}}_u$ sampled by (GU1) are shown in Figs. 3(a) and (b), respectively. Clearly, the characteristics in the graph spectral domain are *not* as expected. The spectra

¹In this example, eigenvectors of the ring graph are real-valued vectors.

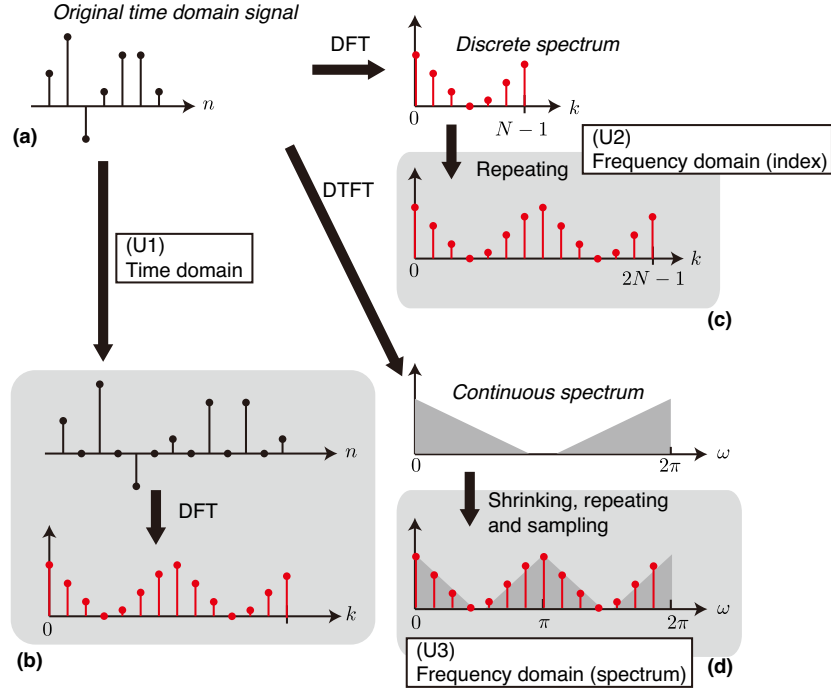

Fig. 2. Upsampling of time domain signals. The signal is upsampled by two. The shaded areas represent identical signals. (a) Original signal. (b) Upsampling strategy (U1): direct upsampling in the time domain. (c) Upsampling strategy (U2): frequency domain upsampling based on the signal index. (d) Upsampling strategy (U3): frequency domain upsampling based on the continuous spectrum.

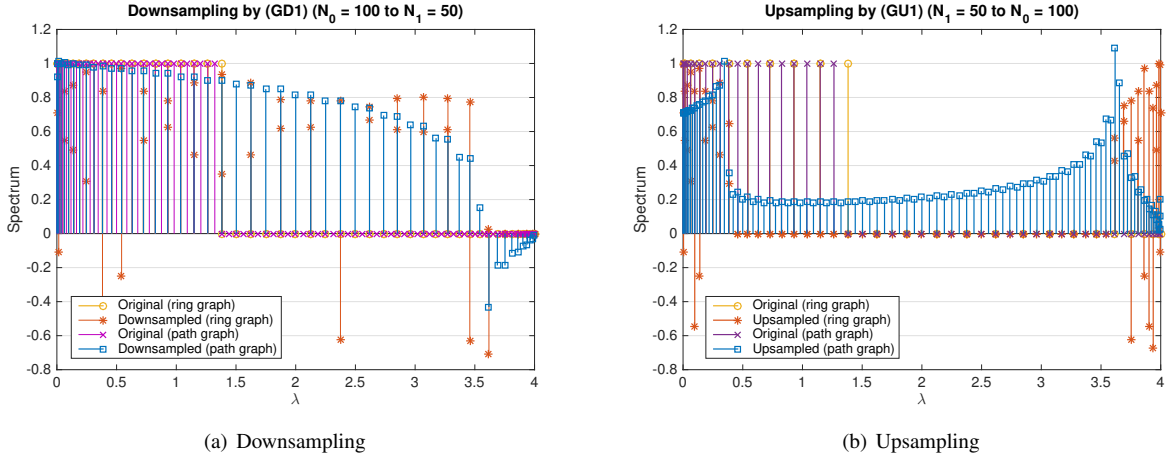

Fig. 3. Spectral properties of sampled graph signals in the vertex domain.

are not stretched (or shrunk) as in Fig. 3 and are completely different from the frequency domain counterpart.

This is our motivation in this study. To solve the above problem, we define sampling operators of graph signals in the spectral domain.

III. SPECTRAL DOMAIN SAMPLING

Two methods for down- and upsampling of graph signals in the graph spectral domain are proposed hereafter, and their characteristics are described. Since the spectrum of graph signals is generally one-sided, namely, it can only be defined in the positive λ , how to stretch or shrink the spectrum has a certain degree of freedom. First, down- and upsampling in the spectral domain (having an immediate relationship with DFT

domain sampling in classical signal processing) is introduced, and then slightly modified versions of them are explained.

A. Downsampling

Definition 5 (Downsampling of graph signals in graph spectral domain). Let $\mathbf{L}_0 \in \mathbb{R}^{N \times N}$ and $\mathbf{L}_1 \in \mathbb{R}^{N/M \times N/M}$ respectively be the graph Laplacian for the original graph and that for the reduced-size graph², respectively, and assume that their eigendecompositions are given by $\mathbf{L}_0 = \mathbf{U}_0 \mathbf{\Lambda}_0 \mathbf{U}_0^*$ and $\mathbf{L}_1 = \mathbf{U}_1 \mathbf{\Lambda}_1 \mathbf{U}_1^*$, where $\mathbf{\Lambda}_i = \text{diag}(\lambda_{i,0}, \lambda_{i,1}, \dots, \lambda_{i,\max})$. The downsampled graph signal $\mathbf{f}_d \in \mathbb{R}^{N/M}$ in the graph spectral domain is defined as follows.

² M is assumed as a divisor of N for the sake of simplicity.

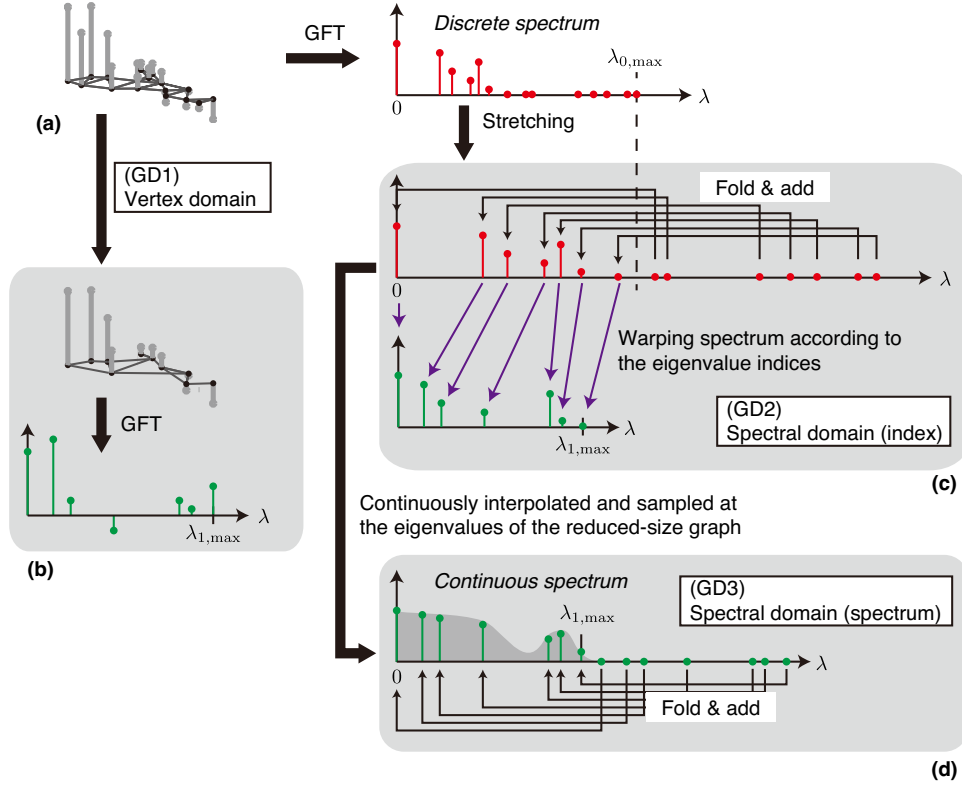

Fig. 4. Downsampling of signals on graphs. The signal is downsampled by two and bandlimited. The shaded areas represent *different* signals. (a) Original graph signal. (b) Downsampling strategy (GD1): direct downsampling in the vertex domain. (c) Downsampling strategy (GD2): graph-spectral domain downsampling based on the signal index. (d) Downsampling strategy (GD3): graph-spectral domain downsampling based on the continuous spectrum.

(GD2) *Graph spectral domain (index)*: The spectral response is divided by M and a set of N/M coefficients are summed up.

$$\tilde{f}_d[k] = \sum_{p=0}^{M-1} \tilde{f} \left[\frac{pN}{M} + k \right]. \quad (11)$$

In a matrix form, it can easily be represented as

$$\mathbf{f}_d = \mathbf{U}_1 \mathbf{S}_d \mathbf{U}_0^* \mathbf{f}, \quad (12)$$

where $\mathbf{S}_d = [\mathbf{I}_{N/M} \ \mathbf{I}_{N/M} \ \dots]$. This downsampling strategy is illustrated in Fig. 4(c).

(GD3) *Graph spectral domain (spectrum)*: The original discrete spectrum is stretched by M and continuously interpolated. Then it is sampled according to the eigenvalue distribution of \mathbf{L}_1 and summed up.

$$\tilde{f}_d[k] = \sum_{p=0}^{M-1} \tilde{f}_{\text{int}} \left(\frac{\rho}{M} (\lambda_{1,k} + p\lambda_{1,\max}) \right), \quad (13)$$

where $\tilde{f}_{\text{int}}(\lambda)$ ($\lambda \in [0, \lambda_{0,\max}]$) is the continuously interpolated version of $f[k]$ and $\rho = \lambda_{0,\max}/\lambda_{1,\max}$.

The above-mentioned downsampling strategy is illustrated in Fig. 4(d). It is clear that (GD2) and (GD3) are the counterparts of (D2) and (D3) of classical signal processing.

As shown in Section III-D, the above definition of (GD2) has an immediate relationship to (D2) and (GD1) and practically it does not have a problem as long as the signal is bandlimited. However, even if a slight aliasing occurs, (GD2) and

(GD3) affects low-graph frequency-components (presented in Section IV-D). This is due to the one-sided spectrum nature of $\tilde{\mathbf{f}}$. In contrast, in classical signal processing, a slight aliasing only affects high-frequency components. (GD2) and (GD3) are therefore defined slightly differently in order to realize a conceptual relationship to the classical sampling in the frequency domain as follows:

(GD2') $\tilde{\mathbf{f}}$ is evenly divided by M . Then odd-numbered portions are flipped and summed up.

$$\begin{aligned} \tilde{f}_d[k] = & \sum_{p=0}^{\lceil M/2 \rceil - 1} \tilde{f} \left[\frac{2pN}{M} + k \right] \\ & + \sum_{p=0}^{\lfloor M/2 \rfloor - 1} \tilde{f} \left[\frac{2(p+1)N}{M} - k - 1 \right]. \end{aligned} \quad (14)$$

The above equation is easily represented as the following matrix form:

$$\mathbf{f}_d = \mathbf{U}_1 \mathbf{S}'_d \mathbf{U}_0^* \mathbf{f}, \quad (15)$$

where $\mathbf{S}'_d = [\mathbf{I}_{N/M} \ \mathbf{J}_{N/M} \ \mathbf{I}_{N/M} \ \dots]$, in which \mathbf{J} is the counter-identity matrix.

(GD3') The continuously interpolated spectrum is sampled symmetrically according to the eigenvalue distribution of

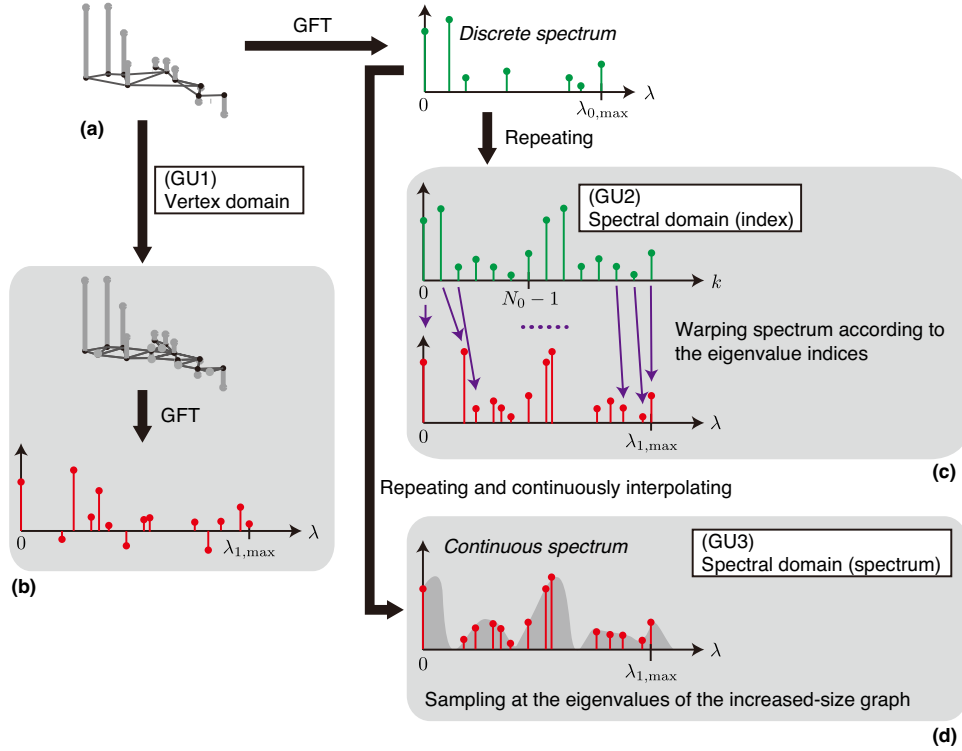

Fig. 5. Upsampling of signals on graphs. The signal is upsampled by two. The shaded areas represent *different* signals. (a) Original graph signal. (b) Upsampling strategy (GU1): direct upsampling in the vertex domain. (c) Upsampling strategy (GU2): graph-spectral domain upsampling based on the signal index. (d) Upsampling strategy (GU3): graph-spectral domain upsampling based on the continuous spectrum.

\mathbf{L}_1 and summed up.

$$\begin{aligned} \tilde{f}_a[k] = & \sum_{p=0}^{\lfloor M/2 \rfloor - 1} \tilde{f}_{\text{int}} \left(\frac{\rho}{M} (\lambda_{1,k} + 2p\lambda_{1,\max}) \right) \\ & + \sum_{p=0}^{\lfloor M/2 \rfloor - 1} \tilde{f}_{\text{int}} \left(\frac{\rho}{M} (-\lambda_{1,k} + 2(p+1)\lambda_{1,\max}) \right). \end{aligned} \quad (16)$$

B. Upsampling

Definition 6 (Upsampling of graph signals in the graph spectral domain). Let $\mathbf{L}_0 \in \mathbb{R}^{N \times N}$ and $\mathbf{L}_1 \in \mathbb{R}^{NL \times NL}$ be the graph Laplacians for the original graph and that for the increased-size graph, respectively. The upsampled graph signal $\mathbf{f}_u \in \mathbb{R}^{NL}$ in the graph spectral domain is defined as follows.

(GU2) *Graph spectral domain (index)*: Repeating the original spectrum L times.

$$\tilde{f}_u[pN + k] = \tilde{f}[k], \quad p = 0, \dots, L - 1 \quad (17)$$

(GU3) *Graph spectral domain (spectrum)*: The original spectrum is repeated L times and continuously interpolated. Then the interpolated spectrum is sampled according to the eigenvalue distribution of λ_1 .

$$\tilde{f}_u[pN + k] = \tilde{f}_{\text{intrep}}(\rho L \lambda_{1,k}), \quad p = 0, \dots, L - 1 \quad (18)$$

where $\tilde{f}_{\text{intrep}}(\lambda)$ ($\lambda \in [0, L\lambda_{0,\max}]$) is the interpolated version of $\underbrace{[\mathbf{f}^\top \quad \mathbf{f}^\top \quad \mathbf{J}_N \quad \dots]^\top}_L$.

The above-mentioned upsampling methods are illustrated in Fig. 5, which are also the counterparts of (U2) and (U3).

In the same manner as downsampling, a folded version of (GU2) and (GU3) can be defined as follows.

(GU2') Repeating the original and flipped spectra alternatively.

$$\tilde{f}_u[pN + k] = \begin{cases} \tilde{f}[k] & p = 0, 2, \dots, \lfloor L/2 \rfloor - 1 \\ \tilde{f}[N - k - 1] & p = 1, 3, \dots, \lfloor L/2 \rfloor - 1 \end{cases} \quad (19)$$

(GU3') The original and flipped spectra are repeated L times alternatively, and they are continuously interpolated. Then the interpolated spectra are sampled according to the eigenvalue distribution of λ_1 .

$$\tilde{f}_u[pN + k] = \tilde{f}'_{\text{intrep}}(\rho L \lambda_{1,k}), \quad p = 0, \dots, L - 1 \quad (20)$$

where $\tilde{f}'_{\text{intrep}}(\lambda)$ is the interpolated version of $\underbrace{[\mathbf{f}^\top \quad \mathbf{f}^\top \quad \mathbf{J}_N \quad \dots]^\top}_L$.

C. Avoiding Aliasing and Imaging

Definitions 5 and 6 indicate that aliasing (due to downsampling) and imaging (due to upsampling) can be avoided by using appropriate graph low-pass filters. For (GD2) and (GU2), the ideal filter characteristic in the graph spectral domain is defined as follows:

$$H[k] = \begin{cases} 1 & \text{if } k \leq \frac{N}{M} \text{ (GD2) or } k \leq N \text{ (GU2),} \\ 0 & \text{otherwise.} \end{cases} \quad (21)$$

In contrast, for (GD3) and (GU3), the filter characteristic can be defined as the width of the spectrum:

$$H(\lambda) = \begin{cases} 1 & \text{if } \lambda \leq \frac{\lambda_{1,\max}}{M} \text{ (GD3) or } \lambda \leq \frac{\lambda_{1,\max}}{L} \text{ (GU3),} \\ 0 & \text{otherwise.} \end{cases} \quad (22)$$

The above-described low-pass filters also avoid aliasing or imaging when (GD2'), (GD3'), (GU2') and (GU3') are used instead of their original versions. Since (GD1) and (GU1) do not have an intuitive relationship between the main frequency component and the aliasing or imaging ones, it is generally difficult to avoid them by using a low-pass filter.

D. Interconnections between Sampling Approaches

From the definitions of (D2) and (GD2), the following relation can be immediately confirmed.

Corollary 1. *It is assumed that \mathcal{G}_0 and \mathcal{G}_1 are ring graphs with N and N/M vertices, respectively, where N is a multiple of M . Additionally, \mathbf{U}_i^* ($i \in \{0, 1\}$) is assumed to be the DFT matrix³. If graph signal $\mathbf{f} \in \mathbb{R}^N$ on vertices of \mathcal{G}_0 is downsampled by (GD2), the downsampled signal $\mathbf{f}_d \in \mathbb{R}^{N/M}$ is equivalent to the signal downsampled by (D1)–(D3). It also means (GD1) and (GD2) are equivalent if every M th sample on the ring graph is remained by (GD1).*

Similarly, (U2), (GU1), and (GU2) have the following relationship:

Corollary 2. *\mathcal{G}_0 and \mathcal{G}_1 are the same as Corollary 1. If graph signal $\mathbf{f} \in \mathbb{R}^{N/M}$ on the vertices of \mathcal{G}_1 is upsampled by (GU2) to $\mathbf{f}_u \in \mathbb{R}^N$, (U1)–(U3) and (GU2) are equivalent. It also means (GU1) and (GU2) are equivalent in this case.*

E. Limitations

The above-described definitions of graph-signal sampling in the spectral domain inherit properties of sampling in the frequency domain for classical signal processing. However, in general, they do not preserve signal values in the vertex domain. It can therefore be said that definitions (GD2), (GD3), (GU2), and (GU3) only hold partial requirements of down- and upsampling of signals. The vertex domain signals after the proposed downsampling are shown in Section V-A.

IV. ILLUSTRATIVE EXAMPLES

As previously mentioned, sampling in classical signal processing introduces the same frequency characteristic regardless of whether (D1)–(D3) or (U1)–(U3) is used. However, (GD1)–(GD3) or (GU1)–(GU3) have large differences, mainly due to the distribution of eigenvalues of a graph Laplacian. For clear understanding of the differences, some toy examples for different graphs are presented in the following.

For (GD3) and (GU3), an appropriate interpolation method should be selected. For example, the interpolator could be estimated from an approximated Laplace-Beltrami operator if vertices are a point cloud in d -dimensional space [45]. In this

study, however, no assumptions concerning the corresponding underlying manifold of \mathcal{G} are made. Therefore, a simple linear interpolation for (GD3) and (GU3) are used hereafter. An accurately designed interpolator would improve the sampling performance, and it is an open problem.

A. Sampling on Path Graph

When the size of the path graph is reduced, every other vertex is taken in an intuitive way. During upsampling, it is also intuitive to place a new vertex between every pair of neighboring vertices. Both downsampling and upsampling for the path graph case are therefore presented in the following.

First, a downsampling example is described. (GD1)–(GD3) for the downsampling by two of the signal on the path graph with $N = 100$ are compared in Fig. 6(a). Bandwidth of the graph signal is set sufficiently narrow; therefore, aliasing is not expected to occur if the signal is downsampled by two. The figure shows that (GD1) has an undershoot in the highest-graph-frequency regions and that its spectral response is gradually decayed. On the other hand, (GD2) and (GD3) do not produce such effects, but they have different characteristics. That is, (GD2) has a relatively broad bandwidth because of the eigenvalue distribution of the path graph: They are dense in the low- and high-graph-frequency regions, whereas they are sparse in the mid-graph-frequency regions.

For upsampling, a graph signal having a narrow bandwidth is also prepared. At this time, the original graph has $N = 50$ vertices, and the signal is upsampled by two. It is expected to have one main and one imaging component after upsampling. The upsampling example is shown in Fig. 6(b). Despite the bandlimited input, the spectrum upsampled by (GU1) has nonzero responses for all eigenvalues. As in the case of downsampling, (GU2) and (GU3) show the expected spectrum, but their bandwidths depend on the distribution of eigenvalues similar to the downsampling case.

B. Sampling on Grid Graph

A downsampling example of a 2-D grid graph is shown next. The original graph has $N = 256$ vertices evenly distributed in 2-D space $[0, 1) \times [0, 1)$. The reduced-size graph has $N = 64$ vertices, i.e., $M = 4$. As in the case of the path graph, it is easy to determine the remaining vertices after downsampling. One vertex in every four is selected. The spectra are shown in Fig. 6(c). As expected, they are stretched by four on the basis of the spectrum index (for downsampling by (GD2)) or the width of the spectrum (for downsampling by (GD3)). In contrast, the downsampled spectrum no longer has expected characteristics when (GD1) is used.

C. Sampling on Random Regular Graph

The last example is sampling on a random regular graph. $N = 100$ is set, and every node is randomly connected to ten other vertices. The smallest eigenvalue of the graph Laplacian is apart from the remaining ones. A reduced-size graph with $N = 50$ is constructed on the basis of the method presented in [28]; that is, it is no longer a regular graph due to the

³The DFT matrix diagonalizes the graph Laplacian of the ring graph [44].

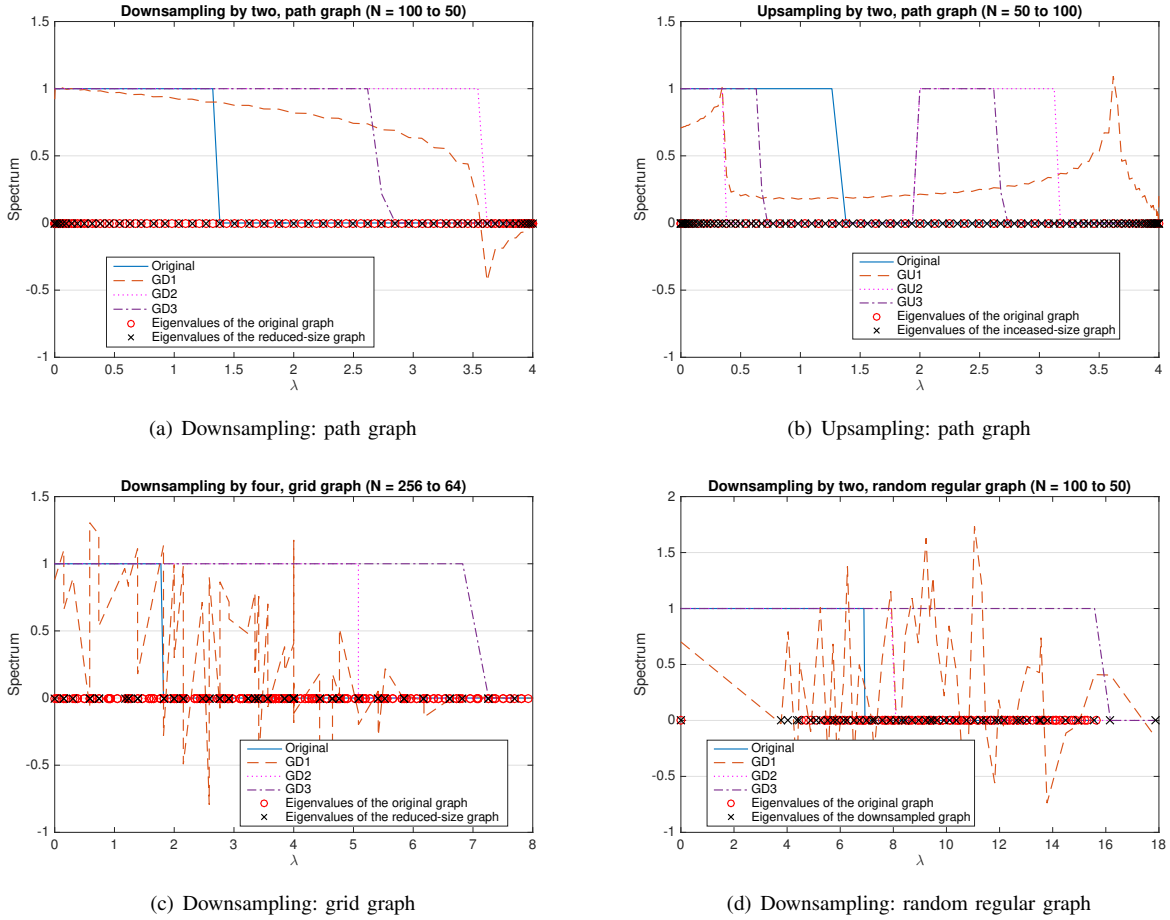

Fig. 6. Illustrative examples of graph signal sampling.

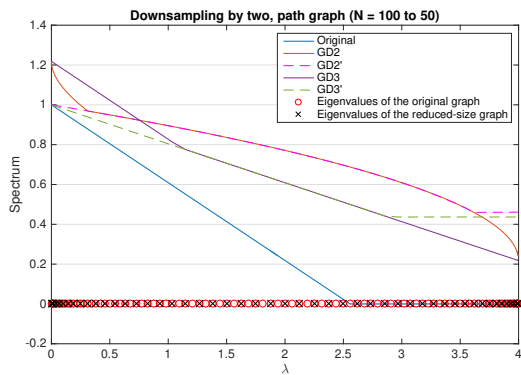

Fig. 7. Illustrative examples of aliasing effects.

requirement of the one-to-one vertex mapping of (GD1). It is later relaxed by using our approach described in Section V-A. The spectra of the downsampled signals are shown in Fig. 6(d). Although the eigenvalues of the graph Laplacian are not distributed uniformly, the spectral characteristics due to downsampling are considered reasonable.

D. Aliasing Effects

Next, the aliasing effect for non-bandlimited graph signals is demonstrated. Aliasing effects of (GD2), (GD2'), (GD3) and (GD3') are compared in Fig. 7. The graph used is a path graph with $N = 100$, and the signal is downsampled by two as in the previous example. However, the graph signal is *not* bandlimited from both the index and spectral perspectives. Though (GD2) has an immediate relationship with (D1)–(D3), the aliasing effect is significant even when the spectra overlap little; that is, it affects the spectrum at low graph frequency. A similar effect occurs for (GD3). In contrast, if the modified downsampling methods (GD2') and (GD3') are used, their effects on the spectrum are slight as expected. Therefore, to avoid a large side effect, it is recommended to use (GD2') and (GD3').

V. APPLICATIONS

Possible applications using sampling on the graph spectral domain are introduced in the following. As with the proposed method, (GD k ') and (GU k ') ($k \in \{2, 3\}$) are used instead of (GD k) and (GU k), since they show slightly better performances.

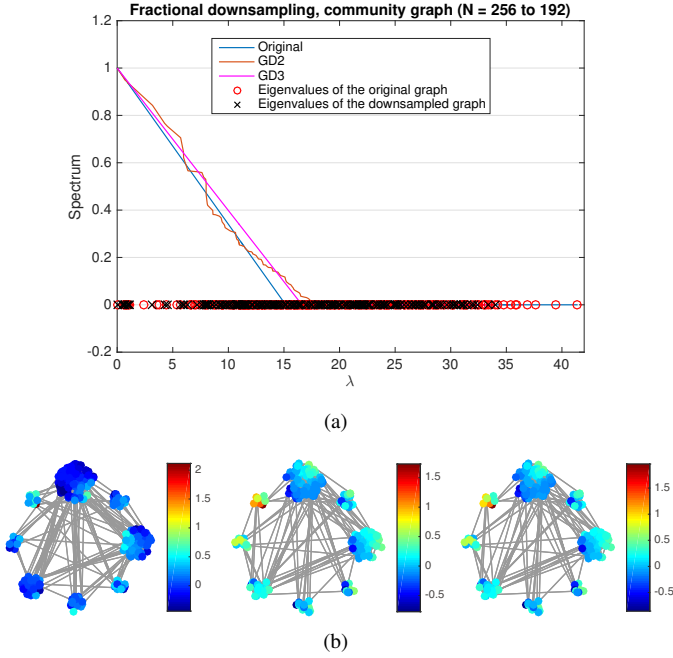

Fig. 8. Fractional downsampling of the signal on *Community Graph* with eight communities. The original graph has 256 vertices and the reduced one has 192 vertices. (a) Spectrum of the original and downsampled signals. (b) Signals in the vertex domain. From top to bottom: the original signal, signal downsampled by (GD2), and signal downsampled by (GD3).

A. Fractional Sampling

Fractional sampling is useful in classical signal processing. In graph signal processing, it would also be useful for reducing (increasing) the number of samples while avoiding aliasing (imaging), if it were possible to perform downsampling (up-sampling) having the spectral domain effects similar to those of the frequency domain. Therefore, the proposed spectral domain sampling would be suitable for fractional sampling.

For simplicity, fractional downsampling is considered here. In the classical case, the input signal is firstly upsampled by L and then downsampled by M to obtain the downsampled signal with rate M/L . However, graph setting would be problematic if this approach was used straightforwardly because three graph Laplacians would have to be prepared: the original, upsampled, and downsampled ones. Especially preparing the upsampled (oversampled) one is difficult, since an increased-size graph Laplacian has to be estimated.

Instead, a different approach can be used; that is, the spectrum is stretched by M/L . This approach is slightly different from (GD2) and (GD3) described in Section III, but it is a natural extension.

Interestingly, in contrast to most of the vertex domain approaches, spectral domain sampling does not necessarily have one-to-one vertex mapping between the original and the reduced-size graphs. This is because the proposed sampling approach *translates* the original spectral information into a different graph rather than copying the signal value itself.

An example of fractional sampling of a signal on a community graph is shown in Fig. 8. The original graph has eight communities and $N = 256$. The signal is downsampled to

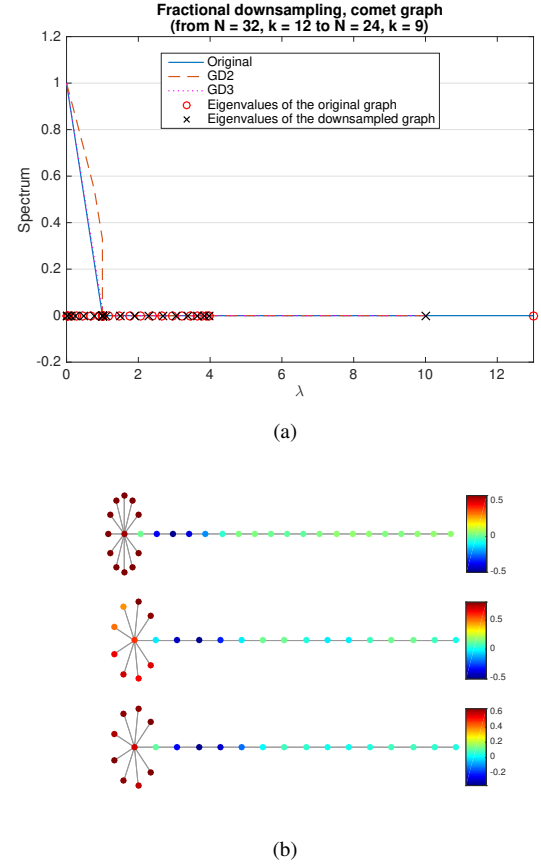

Fig. 9. Fractional downsampling of the signal on *Comet Graph*. The original graph has 32 vertices with the degree of the center vertex 12, and the reduced-size graph has 24 vertices with the degree of the center vertex 9. (a) Spectrum of the original and downsampled signals. (b) Signals in the vertex domain. From top to bottom: the original signal, signal downsampled by (GD2), and signal downsampled by (GD3).

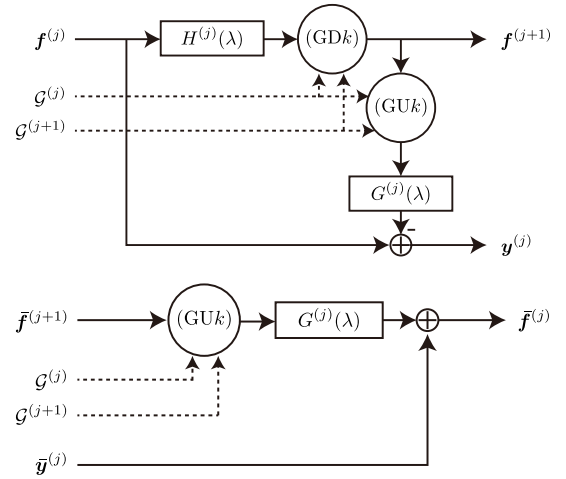

Fig. 10. Graph Laplacian pyramid at the j th level. $\mathbf{f}^{(j)}$ is the j th-level input, and $\mathbf{y}^{(j)}$ is the prediction error at the j th level. $H^{(j)}(\lambda)$ and $G^{(j)}(\lambda)$ are arbitrary graph low-pass filters for approximation and prediction, respectively. $\mathcal{G}^{(j)}$ is the graph at the j th-level decomposition. Top: analysis transform; bottom: synthesis transform.

$N = 192$, i.e., the downsampling ratio is $4/3$. The reduced-size graph also has eight communities, but the original and reduced-size graphs do not have a one-to-one relationship.

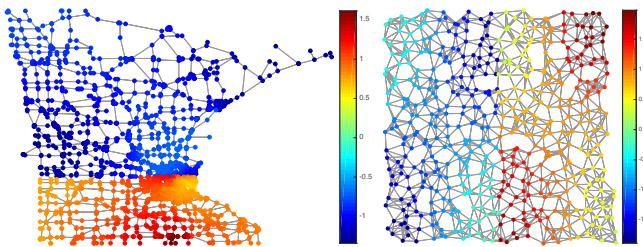

Fig. 11. Input signals on graphs. (Top) Graph signal on *Minnesota Traffic Graph*. (Bottom) Graph signal on random sensor graph.

Though the signal values are not exactly equal to the original signal, they are fairly close.

Additionally, fractional sampling of a signal on a comet graph is also performed. For the original comet graph, $N = 32$ is set, and the degree of the center vertex is set as 12, whereas for the reduced-size graph, $N = 24$, and the degree of the center vertex is 9. As a result, the downsampling ratio is $4/3$. The signal is set to be bandlimited as shown in Fig. 9(a) with the spectra of the downsampled signals. The original and the downsampled signals in the vertex domain are shown in Fig. 9(b). It is clear that the downsampled signals have similar characteristics to the original one even in the vertex domain.

B. Graph Laplacian Pyramid

To demonstrate the effectiveness of the spectral domain sampling, the proposed methods are applied to a Laplacian pyramid for graph signals [28]. It yields one coarsest approximation and several subband signals for finer scales. As shown in Fig. 10, downsampling and upsampling are performed at each decomposition level, so sampling strategies can be compared. In [28], the downsampled signal is interpolated by using the method proposed in [46] to reduce the prediction error as much as possible; however, in the present study, the symmetric structure is used; that is, simple upsampling followed by low-pass filtering is used as in the case of the original Laplacian pyramid for time/spatial domain signals [47] since the purpose of this subsection is to compare pure downsampling or upsampling performances through experiment.

Two graph signals on *Minnesota Traffic Graph* and a random sensor graph are decomposed. The signals are shown in Fig. 11. The former signal is decomposed into three levels, whereas the latter is decomposed to five levels. The graph-reduction method used is based on Kron reduction [26] with edge sparsification. The low-pass filter used is $h(\lambda) = g(\lambda) = 1/(1 + 2\lambda)$ for all levels with Chebychev polynomial approximation [32], [48].

First, decomposed signals in each subband are shown in scale-by-scale. The signals on the *Minnesota Traffic Graph* are shown in Fig. 12. It can be seen from the figure that a sharp transition between the upper and lower parts of the graph is remained in all levels when the pyramid with (GD1) and (GU1) is applied. It indicates the high-graph-frequency components are not extracted to the corresponding high frequency subbands. In contrast, the proposed sampling

method extracts middle to high graph frequencies that vary at the decomposition level.

Furthermore, these pyramids are applied to nonlinear approximation. All coefficients in the coarsest subband are kept, and N_{kept} coefficients, having the largest magnitude in the high-frequency subband, are kept for reconstruction. Remaining coefficients are set to zero. Normalized errors $\|\mathbf{f} - \mathbf{f}_{\text{pred}}\|_2 / \|\mathbf{f}\|_2$ according to the fraction of kept coefficients N_{kept}/N , where \mathbf{f}_{pred} is the reconstructed graph signal after nonlinear approximation, are compared in Fig. 13. It is clear from the figure that the pyramids with spectral domain sampling outperform that taking the vertex domain approach. Overall, in this example, the index-based methods (GD2) and (GU2) are better than the spectrum-based methods (GD3) and (GU3) in terms of the decomposition quality and the reconstruction error.

VI. CONCLUSIONS

Methods for sampling graph signals in the graph spectral domain are proposed. As a counterpart of sampling in classical signal processing, in contrast to the conventional vertex domain approach, sampling in the spectral domain is attempted. The proposed methods inherit the expected spectral properties of the sampled signals, such as the bandwidths broadened by downsampling. Illustrative examples and a few applications demonstrate the validity of the proposed sampling methods as possible alternatives to the intuitive sampling way. The spectral domain sampling could be applied to all graph signal processing systems that includes down- and upsampling of signals. Future works include devising a fast computation method of spectral domain sampling and designing multirate graph signal processing systems.

REFERENCES

- [1] A. V. Oppenheim and R. W. Schaffer, *Discrete-Time Signal Processing*, 3rd ed. Pearson, 2009.
- [2] L. R. Rabiner and R. W. Schaffer, *Digital Processing of Speech Signals*. Prentice Hall, 1978.
- [3] P. P. Vaidyanathan, *Multirate Systems and Filter Banks*. NJ: Prentice-Hall, 1993.
- [4] M. Vetterli, J. Kovačević, and V. K. Goyal, *Foundations of Signal Processing*. Cambridge University Press, 2014.
- [5] M. Vetterli and J. Kovačević, *Wavelets and subband coding*. NJ: Prentice-Hall, 1995.
- [6] G. Strang and T. Q. Nguyen, *Wavelets and Filter Banks*. MA: Wellesley-Cambridge, 1996.
- [7] D. I. Shuman, S. K. Narang, P. Frossard, A. Ortega, and P. Vandergheynst, "The emerging field of signal processing on graphs: Extending high-dimensional data analysis to networks and other irregular domains," *IEEE Signal Process. Mag.*, vol. 30, no. 3, pp. 83–98, 2013.
- [8] A. Sandryhaila and J. M. F. Moura, "Discrete signal processing on graphs," *IEEE Trans. Signal Process.*, vol. 61, pp. 1644–1656, 2013.
- [9] N. Leonardi and D. Van De Ville, "Tight wavelet frames on multislice graphs," *IEEE Trans. Signal Process.*, vol. 16, pp. 3357–3367, 2013.
- [10] J. Zhang and J. M. F. Moura, "Diffusion in social networks as SIS epidemics: Beyond full mixing and complete graphs," *IEEE J. Sel. Topics Signal Process.*, vol. 8, no. 4, pp. 537–551, 2014.
- [11] S. Ono, I. Yamada, and I. Kumazawa, "Total generalized variation for graph signals," in *ICASSP'15*, 2015, pp. 5456–5460.
- [12] W. Hu, G. Cheung, A. Ortega, and O. C. Au, "Multiresolution graph Fourier transform for compression of piecewise smooth images," *IEEE Trans. Image Process.*, vol. 24, no. 1, pp. 419–433, 2015.
- [13] B. A. Miller, M. S. Beard, P. J. Wolfe, and N. T. Bliss, "A spectral framework for anomalous subgraph detection," *IEEE Trans. Signal Process.*, vol. 63, no. 16, pp. 4191–4206, 2015.

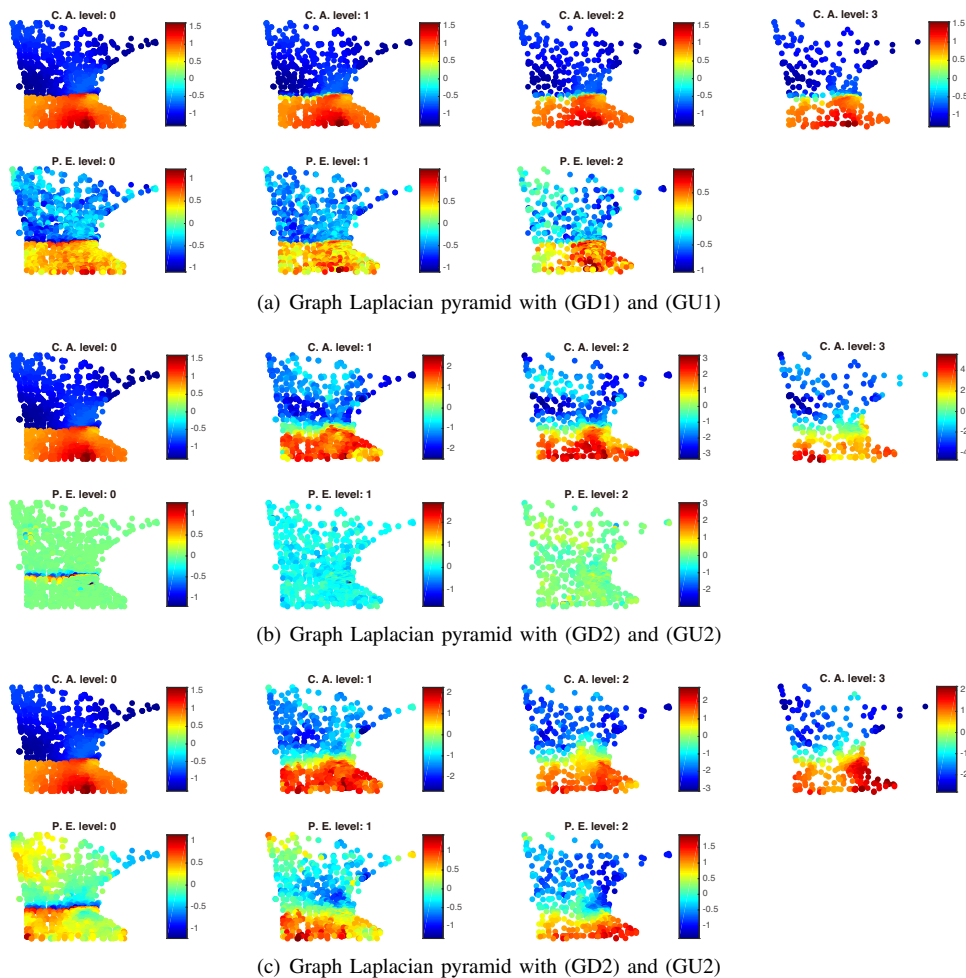

Fig. 12. Decomposed signals by graph Laplacian pyramid according to various levels. Top row: coarse approximations, bottom row: prediction errors.

- [14] M. Onuki, S. Ono, M. Yamagishi, and Y. Tanaka, "Graph signal denoising via trilateral filter on graph spectral domain," *IEEE Trans. Signal Inf. Process. Netw.*, vol. 2, no. 2, pp. 137–148, 2016.
- [15] S. Segarra, G. Mateos, A. G. Marques, and A. Ribeiro, "Blind identification of graph filters," *IEEE Trans. Signal Process.*, vol. 65, no. 5, pp. 1146–1159, 2016.
- [16] H. Higashi, T. M. Rutkowski, T. Tanaka, and Y. Tanaka, "Multilinear discriminant analysis with subspace constraints for single-trial classification of event-related potentials," *IEEE J. Sel. Topics Signal Process.*, vol. 10, no. 7, pp. 1295–1305, 2016.
- [17] G. Pang, J. and Cheung, "Graph Laplacian regularization for image denoising: Analysis in the continuous domain," *IEEE Trans. Image Process.*, vol. 26, no. 4, pp. 1770–1785, 2017.
- [18] N. Shahid, N. Perraudin, V. Kalofolias, G. Puy, and P. Vandergheynst, "Fast robust PCA on graphs," *IEEE J. Sel. Topics Signal Process.*, vol. 10, no. 4, pp. 740–756, 2016.
- [19] K. Yamamoto, M. Onuki, and Y. Tanaka, "Deblurring of point cloud attributes in graph spectral domain," in *Proc. ICIP'16*, 2016, pp. 1559–1563.
- [20] X. Liu, G. Cheung, X. Wu, and D. Zhao, "Random walk graph Laplacian-based smoothness prior for soft decoding of JPEG images," *IEEE Trans. Image Process.*, vol. 26, no. 2, pp. 509–524, 2017.
- [21] N. Perraudin and P. Vandergheynst, "Stationary signal processing on graphs," *IEEE Trans. Signal Process.*, vol. 65, no. 13, pp. 3462–3477, 2017.
- [22] S. K. Narang and A. Ortega, "Local two-channel critically sampled filterbanks on graphs," in *Proc. ICIP'10*, 2010, pp. 333–336.
- [23] D. Ron, I. Safro, and A. Brandt, "Relaxation-based coarsening and multiscale graph organization," *Multiscale Modeling & Simulation*, vol. 9, no. 1, pp. 407–423, 2011.
- [24] S. K. Narang and A. Ortega, "Downsampling graphs using spectral theory," in *Proc. ICASSP'11*, 2011, pp. 4208–4211.
- [25] —, "Perfect reconstruction two-channel wavelet filter banks for graph structured data," *IEEE Trans. Signal Process.*, vol. 60, no. 6, pp. 2786–2799, 2012. [Online]. Available: http://biron.usc.edu/wiki/index.php/Graph_Filterbanks
- [26] F. Dorfler and F. Bullo, "Kron reduction of graphs with applications to electrical networks," *IEEE Trans. Circuits Syst. I*, vol. 60, no. 1, pp. 150–163, 2013.
- [27] H. Q. Nguyen and M. N. Do, "Downsampling of signals on graphs via maximum spanning trees," *IEEE Trans. Signal Process.*, vol. 63, no. 1, pp. 182–191, 2015.
- [28] D. I. Shuman, M. J. Faraji, and P. Vandergheynst, "A multiscale pyramid transform for graph signals," *IEEE Trans. Signal Process.*, vol. 64, no. 8, pp. 2119–2134, 2016.
- [29] B. Aspvall and J. R. Gilbert, "Graph coloring using eigenvalue decomposition," *SIAM Journal on Algebraic Discrete Methods*, vol. 5, no. 4, pp. 526–538, 1984.
- [30] Y. Tanaka and A. Sakiyama, "M-channel oversampled graph filter banks," *IEEE Trans. Signal Process.*, vol. 62, no. 14, pp. 3578–3590, 2014.
- [31] A. Sakiyama and Y. Tanaka, "Oversampled graph Laplacian matrix for graph filter banks," *IEEE Trans. Signal Process.*, vol. 62, no. 24, pp. 6425–6437, 2014.
- [32] D. K. Hammond, P. Vandergheynst, and R. Gribonval, "Wavelets on graphs via spectral graph theory," *Applied and Computational Harmonic Analysis*, vol. 30, no. 2, pp. 129–150, 2011. [Online]. Available: <http://wiki.epfl.ch/sgwt>
- [33] S. K. Narang and A. Ortega, "Compact support biorthogonal wavelet filterbanks for arbitrary undirected graphs," *IEEE Trans. Signal Process.*, vol. 61, pp. 4673–4685, 2013. [Online]. Available:

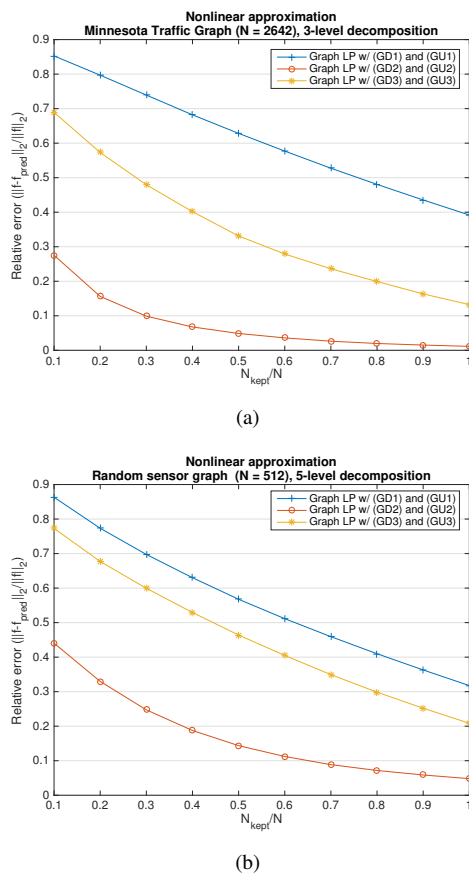

Fig. 13. Nonlinear approximation with graph Laplacian pyramid. (a) *Minnesota Traffic Graph* and (b) random sensor graph.

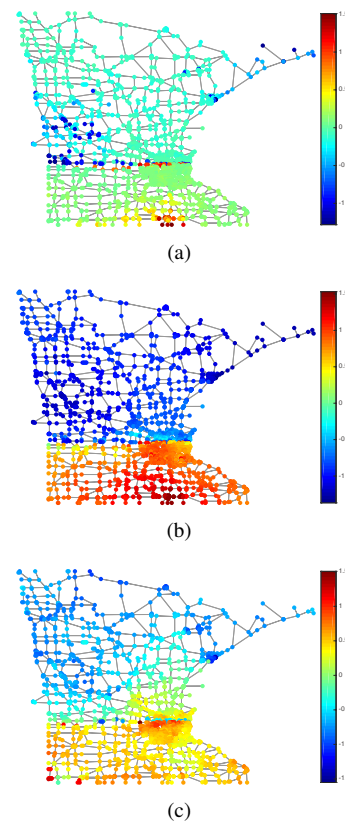

Fig. 14. Nonlinear approximation with graph Laplacian pyramid. $N_{\text{kept}} = 0.2N$. From left to right: signal reconstructed using (GD1) and (GU1), signal reconstructed using (GD2) and (GU2), and signal reconstructed using (GD3) and (GU3).

http://biron.usc.edu/wiki/index.php/Graph_Filterbanks

[34] D. I. Shuman, B. Ricaud, and P. Vandergheynst, "Vertex-frequency analysis on graphs," *submitted to Applied and Computational Harmonic Analysis*, 2013.

[35] D. I. Shuman, C. Wiesmeyr, N. Holighaus, and P. Vandergheynst, "Spectrum-adapted tight graph wavelet and vertex-frequency frames," *IEEE Trans. Signal Process.*, vol. 63, no. 16, pp. 4223–4235, 2015. [Online]. Available: <http://documents.epfl.ch/users/s/sh/shuman/www/publications.html>

[36] D. B. H. Tay, Y. Tanaka, and A. Sakiyama, "Near orthogonal oversampled graph filter banks," *IEEE Signal Process. Lett.*, vol. 23, no. 2, pp. 277–281, 2015.

[37] V. N. Ekambaram, G. C. Fanti, B. Ayazifar, and K. Ramchandran, "Spline-like wavelet filterbanks for multiresolution analysis of graph-structured data," *IEEE Trans. Signal Inf. Process. Netw.*, vol. 1, no. 4, pp. 268–278, 2015.

[38] A. Sakiyama, K. Watanabe, and Y. Tanaka, "Spectral graph wavelets and filter banks with low approximation error," *IEEE Trans. Signal Inf. Process. Netw.*, vol. 2, no. 3, pp. 230–245, 2016.

[39] O. Teke and P. P. Vaidyanathan, "Extending classical multirate signal processing theory to graphs—Part I: Fundamentals," *IEEE Trans. Signal Process.*, vol. 65, no. 2, pp. 409–422, 2016.

[40] —, "Extending classical multirate signal processing theory to graphs—Part II: M -Channel filter banks," *IEEE Trans. Signal Process.*, vol. 65, no. 2, pp. 423–437, 2016.

[41] N. Tremblay and P. Borgnat, "Subgraph-based filterbanks for graph signals," *IEEE Trans. Signal Process.*, vol. 64, no. 15, pp. 3827–3840, 2016.

[42] Y. Jin and D. I. Shuman, "An m -channel critically sampled filter bank for graph signals," *arXiv preprint arXiv:1608.03171*, 2016.

[43] F. Harary, D. Hsu, and Z. Miller, "The biparticity of a graph," *J. Graph Theory*, vol. 1, no. 2, pp. 131–133, 1977.

[44] G. Strang, "The discrete cosine transform," *SIAM Rev.*, vol. 41, no. 1, pp. 135–147, 1999.

[45] M. Belkin, J. Sun, and Y. Wang, "Constructing laplace operator from point clouds in \mathbb{R}^d ," in *Proc. 20th Annual ACM-SIAM Symposium on Discrete Algorithms (SODA 2009)*, 2009, pp. 1031–1040.

[46] I. Pesenson, "Variational splines and paley-wiener spaces on combinatorial graphs," *Constructive Approximation*, vol. 29, no. 1, pp. 1–21, 2009.

[47] P. Burt and E. Adelson, "The Laplacian pyramid as a compact image code," *IEEE Trans. Commun.*, vol. 31, no. 4, pp. 532–540, 1983.

[48] D. I. Shuman, P. Vandergheynst, and P. Frossard, "Chebyshev polynomial approximation for distributed signal processing," in *Proc. DCOSS'11*, 2011, pp. 1–8.