

# Parameterized Complexity of the List Coloring Reconfiguration Problem with Graph Parameters<sup>\*</sup>

Tatsuhiko Hatanaka, Takehiro Ito, and Xiao Zhou

Graduate School of Information Sciences, Tohoku University,  
Aoba-yama 6-6-05, Sendai 980-8579, Japan.  
{hatanaka, takehiro, zhou}@ecei.tohoku.ac.jp

**Abstract.** Let  $G$  be a graph such that each vertex has its list of available colors, and assume that each list is a subset of the common set consisting of  $k$  colors. For two given list colorings of  $G$ , we study the problem of transforming one into the other by changing only one vertex color assignment at a time, while at all times maintaining a list coloring. This problem is known to be PSPACE-complete even for bounded bandwidth graphs and a fixed constant  $k$ . In this paper, we study the fixed-parameter tractability of the problem when parameterized by several graph parameters. We first give a fixed-parameter algorithm for the problem when parameterized by  $k$  and the modular-width of an input graph. We next give a fixed-parameter algorithm for the shortest variant when parameterized by  $k$  and the size of a minimum vertex cover of an input graph. As corollaries, we show that the problem for cographs and the shortest variant for split graphs are fixed-parameter tractable even when only  $k$  is taken as a parameter. On the other hand, we prove that the problem is W[1]-hard when parameterized only by the size of a minimum vertex cover of an input graph.

## 1 Introduction

Recently, the framework of *reconfiguration* [16] has been extensively studied in the field of theoretical computer science. This framework models several situations where we wish to find a step-by-step transformation between two feasible solutions of a combinatorial (search) problem such that all intermediate solutions are also feasible and each step respects a fixed reconfiguration rule. This reconfiguration framework has been applied to several well-studied combinatorial problems. (See a survey [15].)

### 1.1 Our problem

In this paper, we study a reconfiguration problem for list (vertex) colorings in a graph, which was introduced by Bonsma and Cereceda [2].

---

<sup>\*</sup> This work is partially supported by JST CREST Grant Number JPMJCR1402, and by JSPS KAKENHI Grant Numbers JP16J02175, JP16K00003, and JP16K00004.

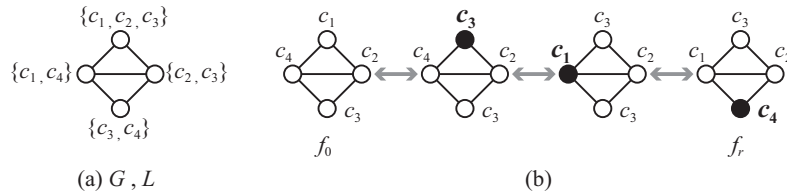

**Fig. 1.** A reconfiguration sequence between two  $L$ -colorings  $f_0$  and  $f_t$  of  $G$ .

Let  $C = \{c_1, c_2, \dots, c_k\}$  be the set of  $k$  colors, called the *color set*. A (proper)  $k$ -coloring of a graph  $G = (V, E)$  is a mapping  $f: V \rightarrow C$  such that  $f(v) \neq f(w)$  for every edge  $vw \in E$ . In *list coloring*, each vertex  $v \in V$  has a set  $L(v) \subseteq C$  of colors, called the *list of  $v$* ; sometimes, the list assignment  $L: V \rightarrow 2^C$  itself is called a *list*. Then, a  $k$ -coloring  $f$  of  $G$  is called an  $L$ -coloring of  $G$  if  $f(v) \in L(v)$  holds for every vertex  $v \in V$ . Therefore, a  $k$ -coloring of  $G$  is simply an  $L$ -coloring of  $G$  when  $L(v) = C$  holds for every vertex  $v$  of  $G$ , and hence  $L$ -coloring is a generalization of  $k$ -coloring. Figure 1(b) illustrates four  $L$ -colorings of the same graph  $G$  in Fig. 1(a); the color assigned to each vertex is attached to the vertex.

In the reconfiguration framework, two  $L$ -colorings  $f$  and  $f'$  of a graph  $G = (V, E)$  are said to be *adjacent* if  $|\{v \in V: f(v) \neq f'(v)\}| = 1$  holds, that is,  $f'$  can be obtained from  $f$  by recoloring exactly one vertex. A sequence  $\langle f_0, f_1, \dots, f_\ell \rangle$  of  $L$ -colorings of  $G$  is called a *reconfiguration sequence* between  $f_0$  and  $f_\ell$  (of length  $\ell$ ) if  $f_{i-1}$  and  $f_i$  are adjacent for each  $i \in \{1, 2, \dots, \ell\}$ . Two  $L$ -colorings  $f$  and  $f'$  are *reconfigurable* if there exists a reconfiguration sequence between them. The LIST COLORING RECONFIGURATION problem is to determine whether two given  $L$ -colorings  $f_0$  and  $f_t$  are reconfigurable, or not. Figure 1 shows an example of a yes-instance of LIST COLORING RECONFIGURATION, where the vertex whose color assignment was changed from the previous one is depicted by a black circle.

## 1.2 Known and related results

LIST COLORING RECONFIGURATION is one of the most well-studied reconfiguration problems, as well as COLORING RECONFIGURATION which is a special case of the problem such that  $L(v) = \{c_1, c_2, \dots, c_k\}$  holds for every vertex  $v$ . These problems have been studied intensively from various viewpoints [1–4, 7, 8, 14, 17, 20] including the generalizations [6, 21].

Bonsma and Cereceda [2] proved that COLORING RECONFIGURATION is PSPACE-complete even for bipartite graphs and any fixed constant  $k \geq 4$ . On the other hand, Cereceda et al. [8] gave a polynomial-time algorithm solving COLORING RECONFIGURATION for any graph and  $k \leq 3$ ; the algorithm can be applied to LIST COLORING RECONFIGURATION, too. In particular, the former result implies that there is no fixed-parameter algorithm for COLORING RECONFIGURATION (and hence LIST COLORING RECONFIGURATION) when parameterized by only  $k$  under the assumption of  $P \neq PSPACE$ .

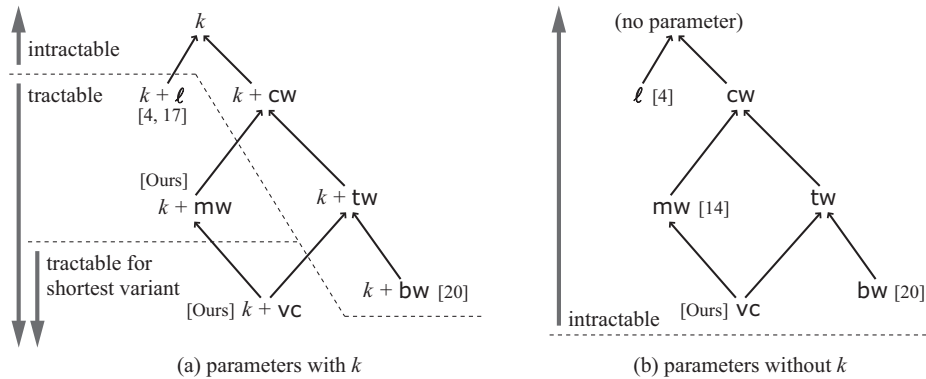

**Fig. 2.** All results (including known ones) for LIST COLORING RECONFIGURATION from the viewpoint of parameterized complexity, where  $cw$ ,  $tw$ ,  $bw$ ,  $mw$ , and  $vc$  are the upper bounds on the cliquewidth, treewidth, bandwidth, modular-width, and the size of a minimum vertex cover of an input graph, respectively.

Bonsma et al. [4] and Johnson et al. [17] independently developed a fixed-parameter algorithm to solve COLORING RECONFIGURATION when parameterized by  $k + \ell$ , where  $\ell$  is the upper bound on the length of reconfiguration sequences, and again their algorithms can be applied to LIST COLORING RECONFIGURATION. In contrast, if COLORING RECONFIGURATION is parameterized only by  $\ell$ , then it is  $W[1]$ -hard when  $k$  is an input [4] and does not admit a polynomial kernelization when  $k$  is fixed unless the polynomial hierarchy collapses [17].

Hatanaka et al. [14] proved that LIST COLORING RECONFIGURATION is PSPACE-complete even for complete split graphs, whose modular-width is zero. Wrochna [20] proved that LIST COLORING RECONFIGURATION is PSPACE-complete even when  $k$  and the bandwidth of an input graph are bounded by some constant; thus the treewidth and the cliquewidth of an input graph are also bounded.

### 1.3 Our contribution

To the best of our knowledge, known algorithmic results mostly employed the length  $\ell$  of reconfiguration sequences as a parameter [4, 17], and no fixed-parameter algorithm is known when parameterized by graph parameters. Therefore, we study LIST COLORING RECONFIGURATION when parameterized by several graph parameters, and paint an interesting map of graph parameters which shows the boundary between fixed-parameter tractability and intractability. Our map is Fig. 2 which shows both known and our results, where an arrow  $\alpha \rightarrow \beta$

indicates that the parameter  $\alpha$  is “stronger” than  $\beta$ , that is,  $\beta$  is bounded if  $\alpha$  is bounded. (For relationships of parameters, see, e.g., [11, 18].)

More specifically, we first give a fixed-parameter algorithm solving LIST COLORING RECONFIGURATION when parameterized by  $k$  and the modular-width  $\text{mw}$  of an input graph. (The definition of modular-width will be given in Section 2.1.) Note that, according to the known results [2, 14], we cannot construct a fixed-parameter algorithm for general graphs when only one of  $k$  and  $\text{mw}$  is taken as a parameter under the assumption of  $\text{P} \neq \text{PSPACE}$ . However, as later shown in Corollary 1, our algorithm implies that the problem is fixed-parameter tractable for cographs even when only  $k$  is taken as a parameter.

We then consider the shortest variant which computes the length of a shortest reconfiguration sequence (i.e., the minimum number of recoloring steps) for a yes-instance of LIST COLORING RECONFIGURATION, and show that it admits a fixed-parameter algorithm when parameterized by  $k$  and the size of a minimum vertex cover of an input graph. Moreover, as a corollary, we show that the shortest variant is fixed-parameter tractable for split graphs even when only  $k$  is taken as a parameter.

Finally, we prove that LIST COLORING RECONFIGURATION is  $W[1]$ -hard when parameterized only by the size of a minimum vertex cover of an input graph.

## 2 Preliminaries

We assume without loss of generality that graphs are simple and connected. Let  $G = (V, E)$  be a graph with vertex set  $V$  and edge set  $E$ ; we sometimes denote by  $V(G)$  and  $E(G)$  the vertex set and the edge set of  $G$ , respectively. For a vertex  $v$  in  $G$ , we denote by  $N(G, v)$  the neighborhood  $\{u \in V : uv \in E\}$  of  $v$  in  $G$ . For a vertex subset  $V' \subseteq V$ , we denote by  $G[V']$  the subgraph of  $G$  induced by  $V'$ , and denote  $G \setminus V' = G[V(G) \setminus V']$ . For a subgraph  $H$  of  $G$ , we denote  $G \setminus H = G \setminus V(H)$ . Let  $\omega(G)$  be the size of a maximum clique of  $G$ . We have the following simple observation.

**Observation 1** *Let  $G$  be a graph with a list  $L: V(G) \rightarrow 2^C$ . If  $G$  has an  $L$ -coloring, then  $\omega(G) \leq |C|$ .*

A graph is *split* if its vertex set can be partitioned into a clique and an independent set. A graph is a *cograph* (or a  $P_4$ -free graph) if it contains no induced path with four vertices.

### 2.1 Modules and modular decomposition

A *module* of a graph  $G = (V, E)$  is a vertex subset  $M \subseteq V$  such that  $N(G, v) \setminus M = N(G, w) \setminus M$  for every two vertices  $v$  and  $w$  in  $M$ . In other words, the module  $M$  is the set of vertices whose neighborhoods in  $G \setminus M$  are the same. For example, the graph in Fig. 3(a) has a module  $M = \{v_3, v_4\}$  for which  $N(G, v_3) \setminus M = N(G, v_4) \setminus M = \{v_1, v_2, v_6\}$  holds. Note that the vertex set  $V$  of  $G$ , the set consisting of only a single vertex, and the empty set  $\emptyset$  are all modules of  $G$ ;

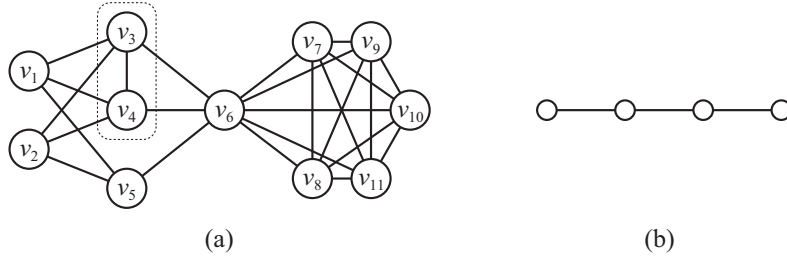

**Fig. 3.** (a) An example of module and (b) a prime.

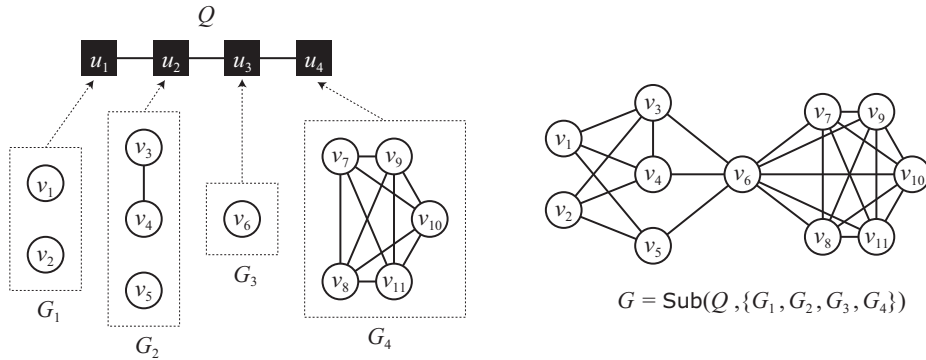

**Fig. 4.** An example of substitution operation.

they are called *trivial*. A graph  $G$  is a *prime* if all of its modules are trivial; for an example, see Fig. 3(b).

We now introduce the notion of modular decomposition, which was first presented by Gallai in 1967 as a graph decomposition technique [12]. For a survey, see, e.g., [13].

We first define the *substitution* operation, which constructs one graph from more than one graphs. Let  $Q$  be a graph, called a *quotient graph*, consisting of  $p$  ( $\geq 2$ ) nodes  $u_1, u_2, \dots, u_p$ , and let  $\mathcal{F} = \{G_1, G_2, \dots, G_p\}$  be a family of vertex-disjoint graphs such that  $G_i$  corresponds to  $u_i$  for every  $i \in \{1, 2, \dots, p\}$ . The  *$Q$ -substitution* of  $\mathcal{F}$ , denoted by  $\text{Sub}(Q, \mathcal{F})$ , is the graph which is obtained by taking a union of all graphs in  $\mathcal{F}$  and then connecting every pair of vertices  $v \in V(G_i)$  and  $w \in V(G_j)$  by an edge if and only if  $u_i$  and  $u_j$  are adjacent in  $Q$ . That is, the vertex set of  $\text{Sub}(Q, \mathcal{F})$  is  $\bigcup\{V(G_i) : G_i \in \mathcal{F}\}$ , and the edge set of  $\text{Sub}(Q, \mathcal{F})$  is the union of  $\bigcup\{E(G_i) : G_i \in \mathcal{F}\}$  and  $\{vw : v \in V(G_i), w \in V(G_j), u_i u_j \in E(Q)\}$ . (See Fig. 4 as an example.)

A *substitution tree* is a rooted tree  $T$  such that each non-leaf node  $x \in V(T)$  is associated with a quotient graph  $Q(x)$  and has  $|V(Q(x))|$  child

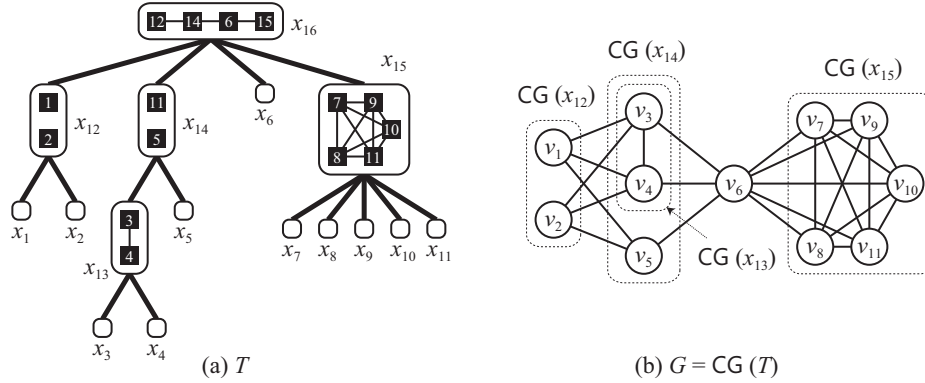

**Fig. 5.** (a) A substitution tree  $T$  for (b) a graph  $G$ .

nodes. For each node  $x \in V(T)$ , we can recursively define the *corresponding graph*  $\text{CG}(x)$  as follows: If  $x$  is a leaf,  $\text{CG}(x)$  consists of a single vertex. Otherwise, let  $y_1, y_2, \dots, y_p$  be  $p = |V(Q(x))|$  children of  $x$ , then  $\text{CG}(x) = \text{Sub}(Q(x), \{\text{CG}(y_1), \text{CG}(y_2), \dots, \text{CG}(y_p)\})$ . For the root  $r$  of  $T$ ,  $\text{CG}(r)$  is called the *corresponding graph of  $T$* , and we denote  $\text{CG}(T) := \text{CG}(r)$ . We say that  $T$  is a substitution tree for a graph  $G$  if  $\text{CG}(T) = G$ , and refer to a *node* in  $T$  in order to distinguish it from a vertex in  $G$ . Figure 5(a) illustrates a substitution tree for the graph  $G$  in Fig. 5(b); each leaf  $x_i$ ,  $i \in \{1, 2, \dots, 11\}$ , corresponds to the subgraph of  $G$  consisting of a single vertex  $v_i$ . We note that the vertex set  $V(\text{CG}(x))$  of each corresponding graph  $\text{CG}(x)$ ,  $x \in V(T)$ , forms a module of  $\text{CG}(T)$ .

A *modular decomposition tree*  $T$  (an *MD-tree* for short) for a graph  $G$  is a substitution tree for  $G$  which satisfies the following three conditions:

- Each node  $x \in V(T)$  applies to one of the following three types:
  - a *series* node, whose quotient graph  $Q(x)$  is a complete graph;
  - a *parallel* node, whose quotient graph  $Q(x)$  is an edge-less graph; and
  - a *prime* node, whose quotient graph  $Q(x)$  is a prime with at least four vertices.
- No edge connects two series nodes.
- No edge connects two parallel nodes.

It is known that any graph  $G$  has a unique MD-tree with  $O(|V(G)|)$  nodes, and it can be computed in time  $O(|V(G)| + |E(G)|)$  [19]. We denote by  $\text{MD}(G)$  the unique MD-tree for a graph  $G$ . The *modular-width*  $\text{mw}(G)$  of a graph  $G$  is the maximum number of children of a prime node in its MD-tree  $\text{MD}(G)$ . The substitution tree  $T$  in Fig. 5(a) is indeed the MD-tree for the graph  $G$  in Fig. 5(b), and hence  $\text{mw}(G) = 4$ ; note that only  $x_{16}$  is a prime node in  $T$ .

We now define a variant of MD-trees, which will make our proofs and analyses simpler. A *pseudo modular decomposition tree*  $T$  (a *PMD-tree* for short) for a graph  $G$  is a substitution tree for  $G$  which satisfies the following two conditions:

- Each node  $x \in V(T)$  applies to one of the following three types:
  - a *2-join* node, whose quotient graph  $Q(x)$  is a complete graph with exactly two vertices;
  - a *parallel* node, whose quotient graph  $Q(x)$  is an edge-less graph; and
  - a *prime* node, whose quotient graph  $Q(x)$  is a prime with at least four vertices.
- No edge connects two parallel nodes.

**Proposition 1.** *For any graph  $G$ , there exists a PMD-tree  $T$  with  $O(|V(G)|)$  nodes such that each prime node  $x \in V(T)$  has at most  $\text{mw}(G)$  children, and it can be constructed in polynomial time.*

*Proof.* Recall that an MD-tree  $\text{MD}(G)$  for a graph  $G$  can be constructed in linear time. Given an MD-tree  $\text{MD}(G)$  for a graph  $G$ , we thus construct a PMD-tree  $T$  such that  $\text{CG}(T) = \text{CG}(\text{MD}(G))$  as follows. For each series node  $x$  of  $\text{MD}(G)$  having  $m$  ( $\geq 3$ ) children  $y_1, y_2, \dots, y_m$ , we replace it with a binary tree consisting of  $m - 1$  nodes  $x_1, x_2, \dots, x_{m-1}$  such that  $x_i$  has two children  $y_i$  and  $x_{i+1}$  for each  $i \in \{1, 2, \dots, m - 2\}$  and  $x_{m-1}$  has two children  $y_{m-1}$  and  $y_m$ . A quotient graph  $Q(x_i)$  of each new node  $x_i$  is defined as a complete graph with exactly two vertices. Then,  $T$  is a PMD-tree for  $G$ , it has at most  $O(|V(G)|)$  nodes, and each prime node  $x \in V(T)$  has at most  $\text{mw}(G)$  children. Moreover, this process can be done in time polynomial in  $|V(\text{MD}(G))| = O(|V(G)|)$ .  $\square$

We denote by  $\text{PMD}(G)$  a substitution tree for  $G$  such that each prime node  $x \in V(T)$  has at most  $\text{mw}(G)$  children. The *pseudo modular-width*  $\text{pmw}(G)$  of a graph  $G$  is the maximum number of children of a non-parallel node in its PMD-tree. Notice that  $\text{pmw}(G) = \max\{2, \text{mw}(G)\}$  holds.

## 2.2 Other notation

Let  $G$  be a graph, and let  $L: V(G) \rightarrow 2^C$  be a list. For two  $L$ -colorings  $f$  and  $f'$  of a graph  $G = (V, E)$ , we define the *difference*  $\text{dif}(f, f')$  between  $f$  and  $f'$  as the set  $\{v \in V: f(v) \neq f'(v)\}$ . Notice that  $f$  and  $f'$  are adjacent if and only if  $|\text{dif}(f, f')| = 1$ .

We express an instance  $\mathcal{I}$  of LIST COLORING RECONFIGURATION by a 4-tuple  $(G, L, f_0, f_t)$  consisting of a graph  $G$ , a list  $L$ , and *initial* and *target*  $L$ -colorings  $f_0$  and  $f_t$  of  $G$ .

Finally, we introduce a notion of “restriction” of mappings and instances. Consider an arbitrary mapping  $\mu: V(G) \rightarrow S$ , where  $G$  is a graph and  $S$  is any set. For a subgraph  $H$  of  $G$ , we denote by  $\mu^H$  the *restriction* of  $\mu$  on  $V(H)$ , that is,  $\mu^H$  is a mapping from  $V(H)$  to  $S$  such that  $\mu^H(v) = \mu(v)$  for each vertex  $v \in V(H)$ . Let  $\mathcal{I} = (G, L, f_0, f_t)$  be an instance of LIST COLORING RECONFIGURATION. For a subgraph  $H$  of  $G$ , we define the *restriction*  $\mathcal{I}^H$  of  $\mathcal{I}$  (on  $H$ ) as the instance  $(H, L^H, f_0^H, f_t^H)$  of LIST COLORING RECONFIGURATION. Notice that  $f_0^H$  and  $f_t^H$  are proper  $L^H$ -colorings of  $H$ .

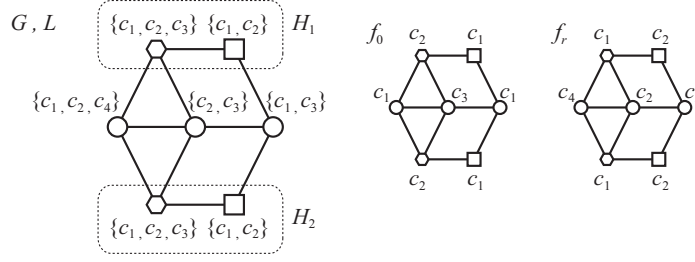

**Fig. 6.** An instance  $\mathcal{I} = (G, L, f_0, f_t)$  of LIST COLORING RECONFIGURATION, and two identical subgraphs  $H_1$  and  $H_2$ .

### 3 Fixed-Parameter Algorithm for Bounded Modular-Width Graphs

The following is our main theorem of this section.

**Theorem 1.** LIST COLORING RECONFIGURATION is fixed-parameter tractable when parameterized by  $k + \text{mw}$ , where  $k$  and  $\text{mw}$  are the upper bounds on the size of the color set and the modular-width of an input graph, respectively.

Because it is known that any cograph has modular-width zero, we have the following result as a corollary of Theorem 1.

**Corollary 1.** LIST COLORING RECONFIGURATION is fixed-parameter tractable for cographs when parameterized by the size  $k$  of the color set.

Recall that  $\text{pmw}(G) = \max\{2, \text{mw}(G)\}$ , and hence  $\text{pmw}(G) \leq \text{mw}(G) + 2$ . Therefore, as a proof of Theorem 1, it suffices to give a fixed-parameter algorithm for LIST COLORING RECONFIGURATION with respect to  $k + \text{pmw}$ , where  $\text{pmw}$  is an upper bound on  $\text{pmw}(G)$ .

#### 3.1 Reduction rule

In this subsection, we give a useful lemma, which compresses an input graph into a smaller graph with keeping the reconfigurability.

Let  $\mathcal{I} = (G, L, f_0, f_t)$  be an instance of LIST COLORING RECONFIGURATION. For each vertex  $v \in V(G)$ , we define a *vertex assignment*  $A(v)$  as a triple  $(L(v), f_0(v), f_t(v))$  consisting of a list, and initial and target color assignments of  $v$ . Let  $H_1$  and  $H_2$  be two induced subgraphs of  $G$  such that  $|V(H_1)| = |V(H_2)|$  and  $V(H_1) \cap V(H_2) = \emptyset$ . Then,  $H_1$  and  $H_2$  are *identical* (on  $\mathcal{I}$ ) if there exists a bijective function  $\phi: V(H_1) \rightarrow V(H_2)$  which satisfies all the following two conditions:

1.  $H_1$  and  $H_2$  are isomorphic under  $\phi$ , that is,  $vw \in E(H_1)$  if and only if  $\phi(v)\phi(w) \in E(H_2)$ .



2. For all vertices  $v \in V(H_1)$ ,
  - (a)  $N(G, v) \setminus V(H_1) = N(G, \phi(v)) \setminus V(H_2)$ ; and
  - (b)  $A(v) = A(\phi(v))$ , that is,  $L(v) = L(\phi(v))$ ,  $f_0(v) = f_0(\phi(v))$  and  $f_t(v) = f_t(\phi(v))$ .

We note that the condition 2(a) implies that there is no edge between  $H_1$  and  $H_2$ . Figure 6 shows an example of identical subgraphs  $H_1$  and  $H_2$  on  $\mathcal{I} = (G, L, f_0, f_t)$ , where the bijective function maps each vertex in  $H_1$  to a vertex in  $H_2$  with the same shape.

We now prove the following key lemma, which holds for any graph.

**Lemma 1.** (Reduction rule) *Let  $\mathcal{I} = (G, L, f_0, f_t)$  be an instance of LIST COLORING RECONFIGURATION, and let  $H_1$  and  $H_2$  be two identical subgraphs of  $G$ . Then,  $\mathcal{I}^{G \setminus H_2}$  is a yes-instance if and only if  $\mathcal{I}$  is.*

*Proof.* We assume that  $H_1$  and  $H_2$  are identical under a bijective function  $\phi: V(H_1) \rightarrow V(H_2)$ , and let  $G' = G \setminus H_2$ .

We first prove the if direction. Suppose that  $\mathcal{I}$  is a yes-instance. Then, there exists a reconfiguration sequence  $\langle f_0, f_1, \dots, f_\ell \rangle$  for  $\mathcal{I}$ , where  $f_\ell = f_t$ . For each  $i \in \{0, 1, \dots, \ell\}$ , since  $f_i$  is an  $L$ -coloring of  $G$ ,  $f_i^{G'}$  is an  $L^{G'}$ -coloring of  $G'$ . Therefore, by removing all consecutive duplicate  $L^{G'}$ -colorings,  $\langle f_0^{G'}, f_1^{G'}, \dots, f_{\ell'}^{G'} \rangle$  is a reconfiguration sequence for  $\mathcal{I}^{G'}$ . Thus  $\mathcal{I}^{G'}$  is a yes-instance.

We now prove the only-if direction. Suppose that  $\mathcal{I}^{G'}$  is a yes-instance. Then, there exists a reconfiguration sequence  $\mathcal{S}' = \langle g_0, g_1, \dots, g_\ell \rangle$  for  $\mathcal{I}^{G'}$  with  $g_0 = f_0^{G'}$  and  $g_\ell = f_t^{G'}$ . Our goal is to construct a reconfiguration sequence  $\mathcal{S}$  for  $\mathcal{I}$  from  $\mathcal{S}'$ . For each  $i \in \{0, 1, \dots, \ell\}$ , we first extend  $g_i$  to  $\widehat{f}_i$  as follows:

$$\widehat{f}_i(v) = \begin{cases} g_i(\phi^{-1}(v)) & \text{if } v \in V(H_2); \\ g_i(v) & \text{otherwise.} \end{cases}$$

We claim that  $\widehat{f}_i$  is a proper  $L$ -coloring of  $G$ . To show this, it suffices to check that  $\widehat{f}_i(v) \neq \widehat{f}_i(w)$  holds for each  $v \in V(H_2)$  and its neighbors  $w \in N(G, v)$ . If  $w \in V(H_2)$ ,  $\widehat{f}_i(v) = g_i(\phi^{-1}(v)) \neq g_i(\phi^{-1}(w)) = \widehat{f}_i(w)$  holds because  $\phi^{-1}(v)\phi^{-1}(w) \in E(G')$  and  $g_i$  is an  $L^{G'}$ -coloring. Otherwise,  $\widehat{f}_i(v) = g_i(\phi^{-1}(v)) \neq g_i(w) = \widehat{f}_i(w)$  holds because  $\phi^{-1}(v)w \in E(G')$  and  $g_i$  is an  $L^{G'}$ -coloring. Therefore, the obtained sequence  $\widehat{\mathcal{S}}$  consists only of  $L$ -colorings of  $G$ . However, there may exist several indices  $i \in \{0, 1, \dots, \ell - 1\}$  such that  $\widehat{f}_i$  and  $\widehat{f}_{i+1}$  are not adjacent, because  $|\text{dif}(\widehat{f}_i, \widehat{f}_{i+1})| > 1$  may hold. Recall that  $g_i$  and  $g_{i+1}$  are adjacent for each  $i \in \{0, 1, \dots, \ell - 1\}$ , that is,  $\text{dif}(g_i, g_{i+1}) = \{w\}$  for some vertex  $w \in V(G')$ . If  $w \notin V(H_1)$ ,  $\text{dif}(\widehat{f}_i, \widehat{f}_{i+1}) = \{w\}$  holds, and hence  $\widehat{f}_i$  and  $\widehat{f}_{i+1}$  are adjacent. Otherwise,  $\text{dif}(\widehat{f}_i, \widehat{f}_{i+1}) = \{w, \phi(w)\}$  holds, and hence  $\widehat{f}_i$  and  $\widehat{f}_{i+1}$  are not adjacent. In this case, between  $\widehat{f}_i$  and  $\widehat{f}_{i+1}$ , we insert an  $L$ -coloring  $\widetilde{f}_i$  of  $G$  defined as follows:

$$\widetilde{f}_i(v) = \begin{cases} \widehat{f}_{i+1}(v) & \text{if } v = w; \\ \widehat{f}_i(v) & \text{if } v = \phi(w); \\ \widehat{f}_i(v) & \text{otherwise.} \end{cases}$$

Observe that  $\tilde{f}_i$  is a proper  $L$ -coloring of  $G$ . Moreover, both  $\text{dif}(\widehat{f}_i, \tilde{f}_i) = \{w\}$  and  $\text{dif}(\tilde{f}_i, \widehat{f}_{i+1}) = \{\phi(w)\}$  hold. Thus, we obtain a proper reconfiguration sequence  $\mathcal{S}$  for  $\mathcal{I}$  as claimed.  $\square$

### 3.2 Kernelization

Let  $\mathcal{I} = (G, L, f_0, f_t)$  be an instance of LIST COLORING RECONFIGURATION. Suppose that the color set  $C$  has at most  $k$  colors,  $G$  is a connected graph with  $\text{pmw}(G) \leq \text{pmw}$ , and all vertices of  $G$  are totally ordered according to an arbitrary binary relation  $\prec$ .

**Sufficient condition for identical subgraphs.** We first give a sufficient condition for which two nodes in a PMD-tree  $\text{PMD}(G)$  for  $G$  correspond to identical subgraphs. Let  $x \in V(\text{PMD}(G))$  be a node, let  $p := |V(\text{CG}(x))|$ , and assume that all vertices in  $V(\text{CG}(x))$  are labeled as  $v_1, v_2, \dots, v_p$  according to  $\prec$ ; that is,  $v_i \prec v_j$  holds for each  $i, j$  with  $1 \leq i < j \leq p$ . Let  $m \geq p$  be some integer which will be defined later. We now define an  $(m+1) \times m$  matrix  $\mathcal{M}_m(x)$  as follows:

$$(\mathcal{M}_m(x))_{i,j} = \begin{cases} 1 & \text{if } i, j \leq p \text{ and } v_i v_j \in E(\text{CG}(x)); \\ 0 & \text{if } i, j \leq p \text{ and } v_i v_j \notin E(\text{CG}(x)); \\ 0 & \text{if } p < i \leq m \text{ or } p < j \leq m; \\ A(v_j) & \text{if } i = m+1 \text{ and } j \leq p; \\ \emptyset & \text{otherwise,} \end{cases}$$

where  $(\mathcal{M}_m(x))_{i,j}$  denotes an  $(i, j)$ -element of  $\mathcal{M}_m(x)$ . Notice that  $\mathcal{M}_m(x)$  contains an adjacency matrix of  $\text{CG}(x)$  at its upper left  $p \times p$  submatrix, and the bottommost row represents the vertex assignment of each vertex in  $V(\text{CG}(x))$ . We call  $\mathcal{M}_m(x)$  an  $m$ -ID-matrix of  $x$ . For example, consider the node  $x_{13}$  in Fig. 5(a). Then,  $p = 2$ , and a 4-ID-matrix of  $x_{13}$  is as follows:

$$\mathcal{M}_4(x_{13}) = \begin{bmatrix} 0 & 1 & 0 & 0 \\ 1 & 0 & 0 & 0 \\ 0 & 0 & 0 & 0 \\ 0 & 0 & 0 & 0 \\ A(x_3) & A(x_4) & \emptyset & \emptyset \end{bmatrix}$$

**Lemma 2.** *Let  $y_1$  and  $y_2$  be two children of a parallel node  $x$  in  $\text{PMD}(G)$ , and let  $m$  be an integer with  $m \geq \max\{|V(\text{CG}(y_1))|, |V(\text{CG}(y_2))|\}$ . If  $\mathcal{M}_m(y_1) = \mathcal{M}_m(y_2)$  holds, then  $\text{CG}(y_1)$  and  $\text{CG}(y_2)$  are identical.*

*Proof.* Let  $p_1 := |V(\text{CG}(y_1))|$  and  $p_2 := |V(\text{CG}(y_2))|$ . Observe that  $(\mathcal{M}_m(y_1))_{m+1,j} \neq \emptyset$  if and only if  $j \leq p_1$ , and  $(\mathcal{M}_m(y_2))_{m+1,j} \neq \emptyset$  if and only if  $j \leq p_2$ . By the assumption that  $(\mathcal{M}_m(y_1))_{m+1,j} = (\mathcal{M}_m(y_2))_{m+1,j}$  for all  $j \in \{1, 2, \dots, m\}$ , we have  $p_1 = p_2$ ; we denote by  $p$  this value.

We now check that  $\text{CG}(y_1)$  and  $\text{CG}(y_2)$  are identical. The condition 1 of identical subgraphs holds, because the upper left  $p \times p$  submatrices in  $\mathcal{M}_m(y_1)$  and

$\mathcal{M}_m(y_2)$  correspond to the adjacency matrices of  $\text{CG}(y_1)$  and  $\text{CG}(y_2)$ , respectively. The condition 2(b) holds, because the bottommost rows are the same in  $\mathcal{M}_m(y_1)$  and  $\mathcal{M}_m(y_2)$ . Finally, we claim that the condition 2(a) holds, as follows. Since  $x$  is a parallel node,  $N(G, v) \setminus V(\text{CG}(y_1)) = N(G, v) \setminus V(\text{CG}(x))$  holds for all vertices  $v$  in  $\text{CG}(y_1)$ . Similarly,  $N(G, w) \setminus V(\text{CG}(y_2)) = N(G, w) \setminus V(\text{CG}(x))$  holds for all vertices  $w$  in  $\text{CG}(y_2)$ . Recall that  $V(\text{CG}(x))$  is a module of  $G$ , that is,  $N(G, v) \setminus V(\text{CG}(x)) = N(G, v') \setminus V(\text{CG}(x))$  holds for any vertices  $v, v' \in V(\text{CG}(x))$ . Therefore,  $N(G, v) \setminus V(\text{CG}(y_1)) = N(G, w) \setminus V(\text{CG}(y_2))$  holds any pair of  $v \in V(\text{CG}(y_1))$  and  $w \in V(\text{CG}(y_2))$ . Thus, the condition 2(a) holds.  $\square$

**Kernelization algorithm.** We now describe how to kernelize an input instance. (See Fig. 7 as an example.) Our algorithm traverses a PMD-tree  $\text{PMD}(G)$  of  $G$  by a depth-first search in post-order starting from the root of  $\text{PMD}(G)$ , that is, the algorithm processes a node of  $\text{PMD}(G)$  after its all children are processed.

Let  $x \in V(\text{PMD}(G))$  be a node which is currently visited. If  $x$  is a non-parallel node, we do nothing. Otherwise (i.e., if  $x$  is a parallel node,) let  $Y$  be the set of all children of  $x$ , and let  $m := \max_{y \in Y} |V(\text{CG}(y))|$ . We first construct  $m$ -ID-matrices of all children of  $x$ . If there exist two nodes  $y_1$  and  $y_2$  such that  $\mathcal{M}_m(y_1) = \mathcal{M}_m(y_2)$ , then  $\text{CG}(y_1)$  and  $\text{CG}(y_2)$  are identical; and hence we remove  $\text{CG}(y_2)$  from  $G$  by Lemma 1. Then, we modify  $\text{PMD}(G)$  in order to keep it still being a PMD-tree for the resulting graph as follows. We remove a subtree rooted at  $y_2$  from  $\text{PMD}(G)$ , and delete a node corresponding to  $y_2$  from a quotient graph  $\text{Q}(x)$  of  $x$ . If this removal makes  $x$  having only one child  $y$  in the PMD-tree, we contract the edge  $xy$  into a new node  $x'$  such that  $\text{Q}(x') = \text{Q}(x)$ .

The running time of this kernelization can be estimated as follows. For each node  $x \in V(\text{PMD}(G))$ , the construction of  $m$ -ID-matrices can be done in time  $O(|Y| \cdot m^2) = O(|V(G)|^3)$ . We can check if  $\mathcal{M}_m(y_1) = \mathcal{M}_m(y_2)$  for each pair of children  $y_1$  and  $y_2$  of  $x$  in time  $O(m^2) = O(|V(G)|^2)$ . Moreover, a modification of  $\text{PMD}(G)$ , which follows an application of Lemma 1, can be done in polynomial time. Recall that the number of children of  $x$  and the size of a PMD-tree  $\text{PMD}(G)$  are both bounded linearly in  $|V(G)|$ , and hence our kernelization can be done in polynomial time.

**Size of the kernelized instance.** We finally prove that the size of the obtained instance  $\mathcal{I}' = (G', L', f'_0, f'_t)$  depends only on  $k + \text{pmw}$ ; recall that  $\text{pmw}$  is the upper bound on  $\text{pmw}(G)$ . By Observation 1, we can assume that the maximum clique size  $\omega(G')$  is at most  $k$ . In addition,  $G'$  is connected since  $G$  is connected and an application of Lemma 1 does not affect the connectivity of the graph. Therefore, it suffices to prove the following lemma.

**Lemma 3.** *The graph  $G'$  has at most  $h_{k, \text{pmw}}(\omega(G'))$  vertices, where  $h_{k, \text{pmw}}(i)$  is recursively defined for an integer  $i \geq 1$  as follows:*

$$h_{k, \text{pmw}}(i) = \begin{cases} 1 & \text{if } i = 1; \\ \text{pmw} \cdot h_{k, \text{pmw}}(i-1) \cdot \sqrt{2}^{(h_{k, \text{pmw}}(i-1))^2} \cdot (2^k \cdot k^2)^{h_{k, \text{pmw}}(i-1)} & \text{otherwise.} \end{cases}$$

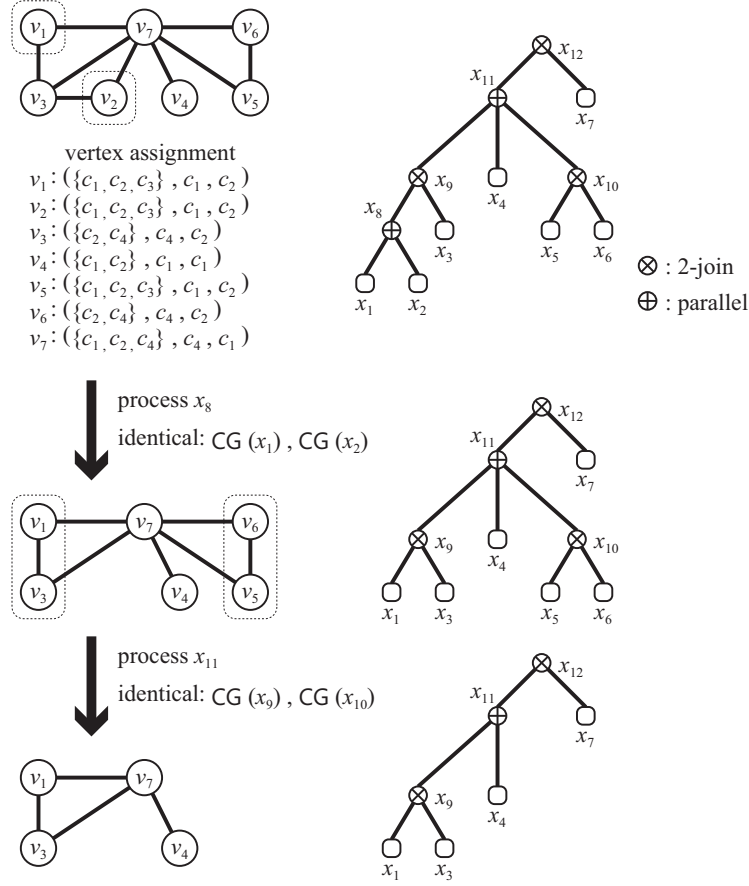

**Fig. 7.** An example of an application of our algorithm. We first focus on  $x_8$ , which is a parallel node whose children are already kernelized, and find that  $\mathcal{M}_1(x_1) = \mathcal{M}_1(x_2)$  holds. Therefore, we delete  $\text{CG}(x_1)$  from the input graph. Then,  $x_8$  has only one child now, and hence we contract an edge  $x_8x_9$  in order to maintain being a PMD-tree. We next focus on  $x_{11}$  and find that  $\mathcal{M}_2(x_9) = \mathcal{M}_2(x_{10})$  holds. After removing  $\text{CG}(x_{10})$  from the current graph and fixing a PMD-tree, we have processed all parallel nodes.

In particular,  $h_{k, \text{pmw}}(\omega(G'))$  depends only on  $k + \text{pmw}$ .

*Proof.* We prove the lemma by induction on  $\omega(G')$ . If  $\omega(G') = 1$ , then we have  $|V(G')| = 1 = h_{k, \text{pmw}}(1)$  since  $G'$  is connected.

We thus assume in the remainder of the proof that  $\omega(G') > 1$ . Then, the root  $r$  of a PMD-tree for  $G'$  must be a non-parallel node since  $G'$  is connected. Because  $r$  has at most  $\text{pmw}(G') \leq \text{pmw}$  children, it suffices to show that the

corresponding graph of each child of  $r$  has at most

$$h_{k,\text{pmw}}(\omega(G') - 1) \cdot \sqrt{2}^{(h_{k,\text{pmw}}(\omega(G')-1))^2} \cdot (2^k \cdot k^2)^{h_{k,\text{pmw}}(\omega(G')-1)}$$

vertices. We will prove this by showing the following two claims for any child  $x$  of  $r$ :

- (A)  $|V(H)| \leq h_{k,\text{pmw}}(\omega(G') - 1)$  holds for any connected component  $H$  of  $\text{CG}(x)$ ; and
- (B)  $\text{CG}(x)$  has at most  $\sqrt{2}^{(h_{k,\text{pmw}}(\omega(G')-1))^2} \cdot (2^k \cdot k^2)^{h_{k,\text{pmw}}(\omega(G')-1)}$  connected components.

In order to prove the claim (A), we first claim that  $\omega(\text{CG}(x)) < \omega(G')$  holds. Assume for a contradiction that  $\text{CG}(x)$  contains a clique  $X$  of size  $\omega(G')$ . Let  $\hat{x}$  be a node of a quotient graph  $\text{Q}(r)$  which corresponds to  $x$ . By the definition,  $\text{Q}(r)$  is connected, and hence there exists a node  $\hat{y} \in V(\text{Q}(r))$  which is adjacent to  $\hat{x}$ . Let  $y \in \text{PMD}(G)$  be the child of  $r$  corresponding to  $\hat{y}$ . Recall that all vertices in  $X$  are connected with at least one vertex  $v$  in  $V(\text{CG}(y))$  by the substitution operation, which means that  $G'$  has a clique  $X \cup \{v\}$  of size  $\omega(G') + 1$ . This contradicts the assumption that the maximum clique size of  $G'$  is  $\omega(G')$ ; this completes the proof of the claim. Note that  $\omega(H) \leq \omega(\text{CG}(x)) < \omega(G')$  holds for any connected component  $H$  of  $\text{CG}(x)$ . Therefore,  $|V(H)| \leq h_{k,\text{pmw}}(\omega(G') - 1)$  follows from the induction hypothesis.

We next prove the claim (B). If  $x$  is a non-parallel node,  $\text{CG}(x)$  is connected and hence we are done. The remaining case is where  $x$  is a parallel node. Let  $H$  be a connected component of  $\text{CG}(x)$ , and let  $Y$  be the set of all children of  $x$ . Then, there exists exactly one child  $y \in Y$  such that  $V(\text{CG}(y)) \supseteq V(H)$ . Since a PMD-tree has no edge joining two parallel nodes,  $y$  is not a parallel node. Thus,  $\text{CG}(y)$  is connected, and hence we indeed have  $V(\text{CG}(y)) = V(H)$ . Therefore, it suffices to bound the size of  $Y$  instead of the number of connected components in  $\text{CG}(x)$ . Let  $m := \max_{y \in Y} |V(\text{CG}(y))|$ . Since  $G'$  is already kernelized,  $\mathcal{M}_m(y_1) \neq \mathcal{M}_m(y_2)$  holds for any two children  $y_1, y_2 \in Y$ . Therefore,  $|Y|$  cannot exceed the number of distinct  $m$ -ID-matrices. Recall that the upper  $m \times m$  submatrix consists of  $m^2$  values from  $\{0, 1\}$ , its  $(i, i)$ -element is 0 for each  $i \in \{1, 2, \dots, m\}$ , and it is symmetric. Therefore, the number of such  $m \times m$  submatrices can be bounded by  $2^{m^2/2} = \sqrt{2}^{m^2}$ . Recall that all elements of the  $(m+1)$ -st row are chosen from the set  $2^C \times C \times C$ , where  $C$  is the color set of size at most  $k$ . Therefore, the number of such  $1 \times m$  submatrices can be bounded by  $(2^k \cdot k^2)^m$ . By the claim (A), we have  $m = \max_{y \in Y} |V(\text{CG}(y))| \leq h_{k,\text{pmw}}(\omega(G') - 1)$ . Therefore, the size of  $Y$ , and hence the number of connected components in  $\text{CG}(x)$ , can be bounded by

$$\sqrt{2}^{(h_{k,\text{pmw}}(\omega(G')-1))^2} \cdot (2^k \cdot k^2)^{h_{k,\text{pmw}}(\omega(G')-1)}.$$

From the claims (A) and (B), we have the following inequality.

$$|V(G')| \leq w \times h_{k,\text{pmw}}(\omega(G') - 1) \times \sqrt{2}^{(h_{k,\text{pmw}}(\omega(G')-1))^2} \cdot (2^k \cdot k^2)^{h_{k,\text{pmw}}(\omega(G')-1)}$$

as claimed. In particular, we can conclude that  $h_{k, \text{pmw}}(\omega(G'))$  depends only on  $k + \text{pmw}$ , because  $\omega(G') \leq k$ .  $\square$

Finally, we prove Theorem 1. By the above discussions, we can compute the kernelized instance  $\mathcal{I}' = \mathcal{I}^{G'}$  of LIST COLORING RECONFIGURATION in polynomial time. Because the size of  $\mathcal{I}'$  depends only on  $k + \text{pmw}$ , we can solve  $\mathcal{I}'$  by enumerating all  $L^{G'}$ -colorings. The running time for this enumeration depends only on  $k + \text{pmw}$ , and hence we obtain a fixed-parameter algorithm for LIST COLORING RECONFIGURATION.

This completes the proof of Theorem 1.

## 4 Shortest Variant

In this section, we study the shortest variant, LIST COLORING SHORTEST RECONFIGURATION. We note that the shortest length can be expressed by a polynomial number of bits, because there are at most  $k^n$  colorings for a graph with  $n$  vertices and  $k$  colors. Therefore, the answer can be output in polynomial time. The following is our result.

**Theorem 2.** LIST COLORING SHORTEST RECONFIGURATION is fixed-parameter tractable when parameterized by  $k + \text{vc}$ , where  $k$  and  $\text{vc}$  are the upper bounds on the sizes of the color set and a minimum vertex cover of an input graph, respectively.

As a corollary, we have the following result.

**Corollary 2.** LIST COLORING SHORTEST RECONFIGURATION is fixed-parameter tractable for split graphs when parameterized by the size  $k$  of the color set.

*Proof.* Let  $\mathcal{I} = (G, L, f_0, f_t)$  be an instance of LIST COLORING SHORTEST RECONFIGURATION such that  $G$  is a split graph. Assume that the vertex set of  $G$  can be partitioned into a clique  $V'$  and an independent set  $V''$ . By Observation 1, we have  $|V'| \leq \omega(G) \leq k$ . Observe that  $V'$  forms a vertex cover of  $G$ . Thus,  $\text{vc} \leq |V'| \leq k$  holds for split graphs.  $\square$

As a proof of Theorem 2, we give such a fixed-parameter algorithm. Our basic idea is the same as the fixed-parameter algorithm in Section 3. However, in order to compute the shortest length, we consider a more general “weighted” version of LIST COLORING SHORTEST RECONFIGURATION, which is defined as follows. Let  $\mathcal{I} = (G, L, f_0, f_t)$  be an instance of LIST COLORING RECONFIGURATION, and assume that each vertex  $v \in V(G)$  has a *weight*  $w(v) \in \mathbb{N}$ , where  $\mathbb{N}$  is the set of all positive integers. For two adjacent  $L$ -colorings  $f$  and  $f'$  of a graph  $G$ , we define the *gap*  $\text{gap}_w(f, f')$  between  $f$  and  $f'$  as the weight  $w(v)$  of  $v$ , where  $v$  is a unique vertex in  $\text{dif}(f, f')$ . The *length*  $\text{len}_w(\mathcal{S})$  of a reconfiguration sequence  $\mathcal{S} = \langle f_0, f_1, \dots, f_\ell \rangle$  is defined as  $\text{len}_w(\mathcal{S}) = \sum_{i=1}^{\ell} \text{gap}_w(f_{i-1}, f_i)$ . We denote by  $\text{OPT}(\mathcal{I}, w)$  the length of a shortest reconfiguration sequence between  $f_0$  and  $f_t$ ; we define  $\text{OPT}(\mathcal{I}, w) = +\infty$  if  $\mathcal{I}$  is a no-instance of LIST COLORING

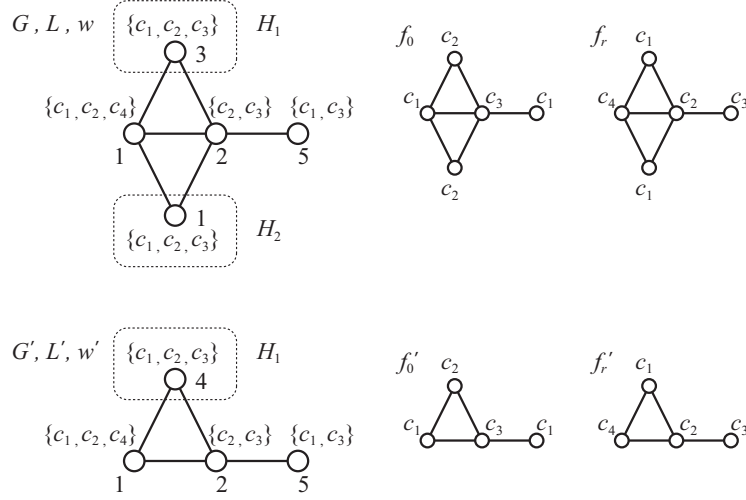

**Fig. 8.** Two identical subgraphs  $H_1$  and  $H_2$  for an instance  $(\mathcal{I} = (G, L, f_0, f_t), w)$ , and a new instance  $(\mathcal{I}', w')$ .

RECONFIGURATION. Then, LIST COLORING SHORTEST RECONFIGURATION can be seen as computing  $\text{OPT}(\mathcal{I}, w)$  for the case where every vertex has weight one. Thus, to prove Theorem 2, it suffices to construct a fixed-parameter algorithm for the weighted version when parameterized by  $k + \text{vc}$ .

As with Section 3, we again use the concept of kernelization to prove Theorem 2. More precisely, for a given instance  $(\mathcal{I}, w)$ , we first construct an instance  $(\mathcal{I}' = (G', L', f'_0, f'_t), w')$  in polynomial time such that the size of  $\mathcal{I}'$  depends only on  $k + \text{vc}$ , and  $\text{OPT}(\mathcal{I}, w) = \text{OPT}(\mathcal{I}', w')$  holds. Then, we can compute  $\text{OPT}(\mathcal{I}', w')$  by computing a (weighted) shortest path between  $f'_0$  and  $f'_t$  in an edge-weighted graph defined as follows: the vertex set consists of all  $L'$ -colorings of  $G'$ , and each pair of adjacent  $L'$ -colorings are connected by an edge with a weight corresponding to the gap between them.

#### 4.1 Reduction rule for the weighted version

In this subsection, we give the counterpart of Lemma 1 for the weighted version.

We first introduce some notation. Let  $\mathcal{S} = \langle f_0, f_1, \dots, f_\ell \rangle$  be a reconfiguration sequence for an instance  $\mathcal{I} = (G, L, f_0, f_t)$  of LIST COLORING RECONFIGURATION. For each vertex  $v \in V(G)$ , we denote by  $\#(\mathcal{S}, v)$  the number of indices  $i$  such that  $\text{dif}(f_{i-1}, f_i) = \{v\}$ . In other words,  $\#(\mathcal{S}, v)$  is the number of steps recoloring  $v$  in  $\mathcal{S}$ . Notice that  $\text{len}_w(\mathcal{S}) = \sum_{v \in V(G)} w(v) \cdot \#(\mathcal{S}, v)$  holds for any weight function  $w: V(G) \rightarrow \mathbb{N}$ .

Let  $(\mathcal{I} = (G, L, f_0, f_t), w)$  be an instance of the weighted version, and assume that there exist two identical subgraphs  $H_1$  and  $H_2$  of  $G$ , both of which consist

of single vertices, say,  $V(H_1) = \{v_1\}$  and  $V(H_2) = \{v_2\}$ . We now define a new instance  $(\mathcal{I}', w')$  as follows (see also Fig. 8):

- $\mathcal{I}' = \mathcal{I}^{G \setminus H_2}$ ; and
- $w'(v_1) = w(v_1) + w(v_2)$  and  $w'(v) = w(v)$  for any  $v \in V(G) \setminus \{v_1, v_2\}$ .

Intuitively,  $v_2$  is merged into  $v_1$  together with its weight. Then, we have the following lemma.

**Lemma 4.**  $\text{OPT}(\mathcal{I}, w) = \text{OPT}(\mathcal{I}', w')$ .

*Proof.* For the notational convenience, we denote  $G' := G \setminus H_2$ . By Lemma 1,  $\text{OPT}(\mathcal{I}, w) = +\infty$  if and only if  $\text{OPT}(\mathcal{I}', w') = +\infty$ . Therefore, we assume that  $\text{OPT}(\mathcal{I}', w') \neq +\infty$  and  $\text{OPT}(\mathcal{I}, w) \neq +\infty$ .

We first show that  $\text{OPT}(\mathcal{I}, w) \leq \text{OPT}(\mathcal{I}', w')$ . Since  $\text{OPT}(\mathcal{I}, w) \leq \text{len}_w(\mathcal{S})$  holds for any reconfiguration sequence  $\mathcal{S}$  for  $\mathcal{I}$ , it suffices to show that there exists a reconfiguration sequence for  $\mathcal{I}$  whose length is at most  $\text{OPT}(\mathcal{I}', w')$ . Let  $\mathcal{S}'$  be a shortest reconfiguration sequence for  $\mathcal{I}'$  such that  $\text{len}_{w'}(\mathcal{S}') = \text{OPT}(\mathcal{I}', w')$ . Following the only-if direction proof of Lemma 1, we can construct a reconfiguration sequence  $\mathcal{S}$  for  $\mathcal{I}$  such that  $\#(\mathcal{S}, v_1) = \#(\mathcal{S}, v_2) = \#(\mathcal{S}', v_1)$  and  $\#(\mathcal{S}, v) = \#(\mathcal{S}', v)$  for any  $v \in V(G) \setminus \{v_1, v_2\}$ . Therefore,

$$\begin{aligned}
\text{len}_w(\mathcal{S}) &= \sum_{v \in V(G)} w(v) \cdot \#(\mathcal{S}, v) \\
&= w(v_1) \cdot \#(\mathcal{S}, v_1) + w(v_2) \cdot \#(\mathcal{S}, v_2) + \sum_{v \in V(G) \setminus \{v_1, v_2\}} w(v) \cdot \#(\mathcal{S}, v) \\
&= (w(v_1) + w(v_2)) \cdot \#(\mathcal{S}, v_1) + \sum_{v \in V(G) \setminus \{v_1, v_2\}} w(v) \cdot \#(\mathcal{S}, v) \\
&= w'(v_1) \cdot \#(\mathcal{S}', v_1) + \sum_{v \in V(G) \setminus \{v_1, v_2\}} w'(v) \cdot \#(\mathcal{S}', v) \\
&= \sum_{v \in V(G')} w'(v) \cdot \#(\mathcal{S}', v) \\
&= \text{len}_{w'}(\mathcal{S}') \\
&= \text{OPT}(\mathcal{I}', w').
\end{aligned}$$

Thus,  $\mathcal{S}$  is a desired reconfiguration sequence for  $\mathcal{I}$ .

We next show that  $\text{OPT}(\mathcal{I}', w') \leq \text{OPT}(\mathcal{I}, w)$ . Since  $\text{OPT}(\mathcal{I}', w') \leq \text{len}_{w'}(\mathcal{S}')$  holds for any reconfiguration sequence  $\mathcal{S}'$  for  $\mathcal{I}'$ , it suffices to show that there exists a reconfiguration sequence for  $\mathcal{I}'$  whose length is at most  $\text{OPT}(\mathcal{I}, w)$ . Let  $\mathcal{S}$  be a shortest reconfiguration sequence for  $\mathcal{I}$  such that  $\text{len}_w(\mathcal{S}) = \text{OPT}(\mathcal{I}, w)$ . We now construct a reconfiguration sequence for  $\mathcal{I}'$  from  $\mathcal{S}$  such that  $\text{len}_{w'}(\mathcal{S}') \leq \text{OPT}(\mathcal{I}, w)$  as follows.

**Case 1.**  $\#(\mathcal{S}, v_1) \leq \#(\mathcal{S}, v_2)$ : In this case, we restrict all  $L$ -colorings in  $\mathcal{S}$  on  $V(G')$  to obtain a reconfiguration sequence  $\mathcal{S}_1$  for  $\mathcal{I}^{G'} = \mathcal{I}'$ ; recall the if direction proof of Lemma 1. From the construction,  $\#(\mathcal{S}_1, v_1) = \#(\mathcal{S}, v_1) \leq \#(\mathcal{S}, v_2)$  and  $\#(\mathcal{S}_1, v) = \#(\mathcal{S}, v)$  holds for any vertex  $v \in V(G') = V(G) \setminus \{v_1, v_2\}$ .



$\{v_2\}$ . Therefore, we have

$$\begin{aligned}
\text{len}_{w'}(\mathcal{S}_1) &= \sum_{v \in V(G')} w'(v) \cdot \#(\mathcal{S}_1, v) \\
&= w'(v_1) \cdot \#(\mathcal{S}_1, v_1) + \sum_{v \in V(G') \setminus \{v_1\}} w'(v) \cdot \#(\mathcal{S}_1, v) \\
&= (w(v_1) + w(v_2)) \cdot \#(\mathcal{S}, v_1) + \sum_{v \in V(G) \setminus \{v_1, v_2\}} w(v) \cdot \#(\mathcal{S}, v) \\
&\leq w(v_1) \cdot \#(\mathcal{S}, v_1) + w(v_2) \cdot \#(\mathcal{S}, v_2) + \sum_{v \in V(G) \setminus \{v_1, v_2\}} w(v) \cdot \#(\mathcal{S}, v) \\
&= \sum_{v \in V(G)} w(v) \cdot \#(\mathcal{S}, v) \\
&= \text{len}_w(\mathcal{S}) \\
&= \text{OPT}(\mathcal{I}, w).
\end{aligned}$$

Thus,  $\mathcal{S}_1$  is a desired reconfiguration sequence for  $\mathcal{I}'$ .

**Case 2.**  $\#(\mathcal{S}, v_1) > \#(\mathcal{S}, v_2)$ : In this case, instead of restricting  $L$ -colorings in  $\mathcal{S}$  on  $V(G')$ , we restrict them on  $V(G \setminus H_1)$  and obtain a reconfiguration sequence  $\mathcal{S}_2$  for  $\mathcal{I}^{G \setminus H_1}$ . Then, because  $H_1$  and  $H_2$  are identical, we can easily “rephrase”  $\mathcal{S}_2$  as a reconfiguration sequence  $\mathcal{S}'_2$  for  $\mathcal{I}'$ . By the same arguments as the case 1 above, we have  $\text{len}_{w'}(\mathcal{S}'_2) < \text{len}_w(\mathcal{S}) = \text{OPT}(\mathcal{I}, w)$ . Thus,  $\mathcal{S}'_2$  is a desired reconfiguration sequence for  $\mathcal{I}'$ .

In this way, we have shown that  $\text{OPT}(\mathcal{I}, w) = \text{OPT}(\mathcal{I}', w')$  as claimed.  $\square$

## 4.2 Kernelization

Finally, we give a kernelization algorithm as follows.

Let  $(\mathcal{I} = (G, L, f_0, f_t), w)$  be an instance of the weighted version such that  $G$  has a vertex cover of size at most  $\text{vc}$ . Because such a vertex cover can be computed in time  $O(2^{\text{vc}} \cdot |V(G)|)$  [9], we now assume that we are given a vertex cover  $V_C$  of size at most  $\text{vc}$ . Notice that  $V_I := V \setminus V_C$  forms an independent set of  $G$ . Suppose that there exist two vertices  $v_1, v_2 \in V_I$  such that  $N(G, v_1) = N(G, v_2)$  and  $A(v_1) = A(v_2)$  hold. Then, induced subgraphs  $G[\{v_1\}]$  and  $G[\{v_2\}]$  are identical. Therefore, we can apply Lemma 4 to remove  $v_2$  from  $G$ , and modify a weight function without changing the optimality. As a kernelization, we repeatedly apply Lemma 4 for all such pairs of vertices in  $V_I$ , which can be done in polynomial time. Let  $G'$  be the resulting subgraph of  $G$ , and let  $V'_I := V(G') \setminus V_C$ . Since  $V_C$  is of size at most  $\text{vc}$ , it suffices to prove the following lemma.

**Lemma 5.**  $|V'_I| \leq 2^{\text{vc}} \cdot 2^k \cdot k^2$ .

*Proof.* Recall that  $V'_I$  contains no pair of vertices which induce identical subgraphs, and hence any pair of vertices  $v_1, v_2 \in V'_I$  does not satisfy at least one of  $N(G, v_1) = N(G, v_2)$  and  $A(v_1) = A(v_2)$ . Therefore,  $|V'_I|$  can be bounded by the number of distinct combinations of the neighborhood and the vertex assignment. Since  $V'_I$  is an independent set,  $N(G', v) \subseteq V_C$  for each vertex  $v \in V'_I$ . Recall that  $|V_C| \leq \text{vc}$ , and hence the number of (possible) neighborhoods can be bounded by  $2^{\text{vc}}$ . Since there are at most  $k$  colors, the number of (possible) vertex assignments can be bounded by  $2^k \cdot k^2$ . We thus have  $|V'_I| \leq 2^{\text{vc}} \cdot 2^k \cdot k^2$  as claimed.  $\square$

This completes the proof of Theorem 2.

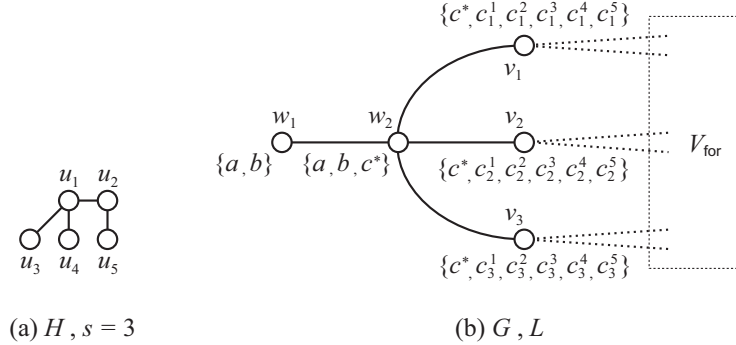

**Fig. 9.** (a) An instance  $H$  of INDEPENDENT SET, and (b) the graph  $G$  and the list  $L$ . The set  $V_{\text{for}}$  contains vertices of  $(i, j; p, q)$ -forbidding gadgets for all  $(i, j) \in \{(1, 2), (1, 3), (2, 3)\}$  and all  $(p, q) \in \{(1, 1), (2, 2), (3, 3), (4, 4), (5, 5), (1, 2), (2, 1), (1, 3), (3, 1), (1, 4), (4, 1), (2, 5), (5, 2)\}$ ; thus  $|V_{\text{for}}| = 39$ .

## 5 W[1]-hardness

Because even the shortest variant is fixed-parameter tractable when parameterized by  $k + \text{vc}$ , one may expect that  $\text{vc}$  is a strong parameter and the problem is fixed-parameter tractable with only  $\text{vc}$ . However, we prove the following theorem in this section.

**Theorem 3.** LIST COLORING RECONFIGURATION is  $W[1]$ -hard when parameterized by  $\text{vc}$ , where  $\text{vc}$  is the upper bound on the size of a minimum vertex cover of an input graph.

Recall that LIST COLORING RECONFIGURATION is PSPACE-complete even for a fixed constant  $k \geq 4$ . Therefore, the problem is intractable if we take only one parameter, either  $k$  or  $\text{vc}$ .

In order to prove Theorem 3, we give an FPT-reduction from the INDEPENDENT SET problem when parameterized by the solution size  $s$ , in which we are given a graph  $H$  and an integer  $s \geq 0$ , and asked whether  $H$  has an independent set of size at least  $s$ . This problem is known to be  $W[1]$ -hard [9].

### 5.1 Construction

Let  $H$  be a graph with  $n$  vertices  $u_1, u_2, \dots, u_n$ , and  $s$  be an integer as an input for INDEPENDENT SET. Then, we construct the corresponding instance  $(G, L, f_0, f_t)$  of LIST COLORING RECONFIGURATION as follows. (See also Fig. 9.)

We first create  $s$  vertices  $v_1, v_2, \dots, v_s$ , which are called *selection vertices*; let  $V_{\text{sel}}$  be the set of all selection vertices. For each  $i \in \{1, 2, \dots, s\}$ , we set  $L(v_i) = \{c^*, c_i^1, c_i^2, \dots, c_i^n\}$ . In our reduction, we will construct  $G$  and  $L$  so that assigning the color  $c_i^p$ ,  $p \in \{1, 2, \dots, n\}$ , to  $v_i \in V_{\text{sel}}$  corresponds to choosing the

vertex  $u_p \in V(H)$  as a vertex in an independent set of  $H$ . Then, in order to make a correspondence between a color assignment to  $V_{\text{sel}}$  and an independent set of size  $s$  in  $H$ , we need to construct the following properties:

- For each  $p \in \{1, 2, \dots, n\}$ , we use at most one color from  $\{c_1^p, c_2^p, \dots, c_s^p\}$ ; this ensures that each vertex  $u_p \in V(H)$  can be chosen at most once as an independent set.
- For each  $p, q \in \{1, 2, \dots, n\}$  with  $u_p u_q \in E(H)$ , we use at most one color from  $\{c_1^p, c_2^p, \dots, c_s^p, c_1^q, c_2^q, \dots, c_s^q\}$ ; then, no two adjacent vertices in  $H$  are chosen as an independent set.

To do this, we define an  $(i, j; p, q)$ -forbidding gadget for  $i, j \in \{1, 2, \dots, s\}$  and  $p, q \in \{1, 2, \dots, n\}$ . The  $(i, j; p, q)$ -*forbidding gadget* is a vertex  $w$  which is adjacent to  $v_i$  and  $v_j$  and has a list  $L(w) = \{c_i^q, c_j^p\}$ . Observe that the vertex  $w$  forbids that  $v_i$  and  $v_j$  are simultaneously colored with  $c_i^p$  and  $c_j^q$ , respectively. In order to satisfy the desired properties above, we now add our gadgets as follows: for all  $i, j \in \{1, 2, \dots, s\}$  with  $i < j$ ,

- add an  $(i, j; p, p)$ -forbidding gadget for every vertex  $u_p \in V(H)$ ; and
- add  $(i, j; p, q)$ - and  $(i, j, q, p)$ -forbidding gadgets for every edge  $u_p u_q \in E(H)$ .

We denote by  $V_{\text{for}}$  the set of all vertices in the forbidding gadgets. We finally create an edge consisting of two vertices  $w_1$  and  $w_2$  such that  $L(w_1) = \{a, b\}$  and  $L(w_2) = \{a, b, c^*\}$ , and connect  $w_2$  with all selection vertices in  $V_{\text{sel}}$ .

Finally, we construct two  $L$ -colorings  $f_0$  and  $f_t$  of  $G$  as follows:

- for each  $v_i \in V_{\text{sel}}$ ,  $f_0(v_i) = f_t(v_i) = c^*$ ;
- for each  $w \in V_{\text{for}}$ ,  $f_0(w)$  and  $f_t(w)$  are arbitrary chosen colors from  $L(w)$ ; and
- $f_0(w_1) = f_t(w_2) = a$ , and  $f_t(w_1) = f_0(w_2) = b$ .

Note that both  $f_0$  and  $f_t$  are proper  $L$ -colorings of  $G$ .

In this way, we complete the construction of  $(G, L, f_0, f_t)$ .

## 5.2 Correctness of the reduction

In this subsection, we prove the following three statements:

- $(G, L, f_0, f_t)$  can be constructed in time polynomial in the size of  $H$ .
- The upper bound  $\text{vc}$  on the size of a minimum vertex cover of  $G$  depends only on  $s$ .
- $H$  is a yes-instance of INDEPENDENT SET if and only if  $(G, L, f_0, f_t)$  is a yes-instance of LIST COLORING RECONFIGURATION.

In order to prove the first statement, it suffices to show that the size of  $(G, L, f_0, f_t)$  is bounded polynomially in  $n = |V(H)|$ . From the construction, we have  $|V(G)| = |V_{\text{sel}}| + |V_{\text{for}}| + |\{w_1, w_2\}| \leq s + s^2 \times (|V(H)| + 2|E(H)|) + 2 = O(n^4)$ . In addition, each list contains  $O(n)$  colors. Therefore, the construction can be done in time  $O(n^{O(1)})$ .

The second statement immediately follows from the fact that  $\{w_2\} \cup V_{\text{sel}}$  is a vertex cover in  $G$  of size  $s + 1$ ; observe that  $G \setminus V' = G[\{w_1\} \cup V_{\text{for}}]$  contains no edge.

Finally, we prove the last statement as follows.

**Lemma 6.**  *$H$  is a yes-instance of INDEPENDENT SET if and only if  $(G, L, f_0, f_t)$  is a yes-instance of LIST COLORING RECONFIGURATION.*

*Proof.* We first prove the if direction. Assume that there exists a reconfiguration sequence  $\mathcal{S}$  for  $(G, L, f_0, f_t)$ . Then,  $\mathcal{S}$  must contain at least one  $L$ -coloring  $f$  such that  $f(w_2) = c^*$  in order to recolor  $w_1$  from  $a$  to  $b$ . Since  $w_2$  is adjacent to all vertices in  $V_{\text{sel}}$ ,  $f(v_i) \neq c^*$  holds for every  $v_i \in V_{\text{sel}}$ . Then, by the construction, the vertex set  $\{u_p: c_i^p = f(v_i), v_i \in V_{\text{sel}}\}$  is an independent set in  $H$  of size  $|V_{\text{sel}}| = s$ .

We then prove the only-if direction. We construct a reconfiguration sequence for  $(G, L, f_0, f_t)$  which passes through two  $L$ -colorings  $f'_0$  and  $f'_t$  defined as follows.

From the assumption,  $H$  has an independent set  $I$  of size  $s$ , say,  $I = \{u_1, u_2, \dots, u_s\}$ . Then, we define  $f'_0$  as follows:

- for each  $v_i \in V_{\text{sel}}$ ,  $f'_0(v_i) = c_i^i$ ;
- for each  $(i, j; p, q)$ -forbidding vertex  $w \in V_{\text{for}}$ ,  $f'_0(w)$  is an arbitrary chosen color from  $L(w) \setminus \{c_i^i, c_j^j\}$ ; and
- $f'_0(w_1) = f_0(w_1) = a$  and  $f'_0(w_2) = f_0(w_2) = b$ .

Note that  $f'_0$  is a proper  $L$ -coloring of  $G$ . We next show that  $f_0$  and  $f'_0$  are reconfigurable. We first recolor all vertex  $w \in V_{\text{for}}$  to the colors  $f'_0(w)$  ( $\neq c^*$ ) in an arbitrary order. This can be done, since  $f_0(v_i) = c^*$  for all  $v_i \in V_{\text{sel}}$  and  $V_{\text{for}}$  is an independent set in  $G$ . We then recolor all vertices  $v_i \in V_{\text{sel}}$  to the colors  $f'_0(v_i)$  in an arbitrary order. This also can be done, since  $f'_0$  is a proper  $L$ -coloring and  $V_{\text{sel}}$  is an independent set in  $G$ . Thus,  $f_0$  and  $f'_0$  are reconfigurable.

By the similar arguments as  $f_0$ , we define  $f'_t$  as follows:

- for each  $v_i \in V_{\text{sel}}$ ,  $f'_t(v_i) = c_i^i$ ;
- for each  $(i, j; p, q)$ -forbidding vertex  $w \in V_{\text{for}}$ ,  $f'_t(w)$  is an arbitrary chosen color from  $L(w) \setminus \{c_i^i, c_j^j\}$ ; and
- $f'_t(w_1) = f_t(w_1) = b$  and  $f'_t(w_2) = f_t(w_2) = a$ .

Then,  $f_t$  and  $f'_t$  are reconfigurable.

Finally, we prove that  $f'_0$  and  $f'_t$  are reconfigurable. Recall that  $f'_0(w_1) = f'_t(w_2) = a$ ,  $f'_t(w_1) = f'_0(w_2) = b$ , and  $f'_0(v_i) = f'_t(v_i) \neq c^*$  for all  $v_i \in V_{\text{sel}}$ . Then, we can swap the color  $a$  and  $b$  by the following three steps:

- recolor  $w_2$  to  $c^*$ ;
- recolor  $w_1$  to  $b$ ; and
- recolor  $w_2$  to  $a$ .

After that, we can recolor all vertices  $w \in V_{\text{for}}$  to the colors  $f'_t(w)$  in the arbitrary order, since  $V_{\text{for}}$  is an independent in  $G$ .

Therefore,  $(G, L, f_0, f_t)$  is a yes-instance of LIST COLORING RECONFIGURATION.  $\square$

This completes the proof of Theorem 3.

## 6 Conclusion

In this paper, we have studied LIST COLORING RECONFIGURATION from the viewpoint of parametrized complexity, in particular, with several graph parameters, and painted an interesting map of graph parameters in Fig. 2 which shows the boundary between fixed-parameter tractability and intractability.

## References

1. Bonamy, M., Bousquet, N.: Recoloring bounded treewidth graphs. *Electronic Notes in Discrete Mathematics* 44, pp. 257–262 (2013)
2. Bonsma, P., Cereceda, L.: Finding paths between graph colourings: PSPACE-completeness and superpolynomial distances. *Theoretical Computer Science* 410, pp. 5215–5226 (2009)
3. Bonamy, M., Johnson, M., Lignos, I., Patel, V., Paulusma, D.: Reconfiguration graphs for vertex colourings of chordal and chordal bipartite graphs. *J. Combinatorial Optimization* 27, pp. 132–143 (2014)
4. Bonsma, P., Mouawad, A.E., Nishimura, N., Raman, V.: The complexity of bounded length graph recoloring and CSP reconfiguration. *Proc. of IPEC 2014, LNCS 8894*, pp. 110–121 (2014)
5. Brandstädt, A., Le, V.B., Spinrad, J.P.: *Graph Classes: A Survey*. SIAM (1999)
6. Brewster, R.C., McGuinness, S., Moore, B., Noel, J.A.: A dichotomy theorem for circular colouring reconfiguration. *Theoretical Computer Science* 639, pp. 1–13 (2016)
7. Cereceda, L.: *Mixing Graph Colourings*. Ph.D. Thesis, London School of Economics and Political Science (2007)
8. Cereceda, L., van den Heuvel, J., Johnson, M.: Finding paths between 3-colorings. *J. Graph Theory* 67, pp. 69–82 (2011)
9. Downey, R., G., Fellows, M., R.: *Parameterized Complexity*. Springer-Verlag New York (1999)
10. Dyer, M., Flaxman, A., Frieze, A., Vigoda, E.: Randomly colouring sparse random graphs with fewer colours than the maximum degree. *Random Structures Algorithms* 29, pp. 450–465 (2006)
11. Gajarský, J., Lampis, M., Ordyniak, S.: Parameterized algorithms for modular-width. *Proc. of IPEC 2013, LNCS 8246*, pp. 163–176 (2013)
12. Gallai, T.: Transitivity orientierbare Graphen. *Acta Mathematica Academiae Scientiarum Hungarica* 18, Issue 1-2, pp. 25–66 (1967)
13. Habib, M., Paul, C.: A survey of the algorithmic aspects of modular decomposition. *Computer Science Review* 4, issue 1, pp. 41–59 (2010)
14. Hatanaka, T., Ito, T., Zhou, X.: The list coloring reconfiguration problem for bounded pathwidth graphs. *IEICE Trans. on Fundamentals of Electronics, Communications and Computer Sciences* E98-A, No. 6, pp. 1168–1178 (2015)
15. van den Heuvel, J.: *The complexity of change*. Cambridge University Press, pp. 127–160 (2013)
16. Ito, T., Demaine, E.D., Harvey, N.J.A., Papadimitriou, C.H., Sideri, M., Uehara, R., Uno, Y.: On the complexity of reconfiguration problems. *Theoretical Computer Science* 412, pp. 1054–1065 (2011)

17. Johnson, M., Kratsch, D., Kratsch, S., Patel, V., Paulusma, D.: Finding shortest paths between graph colourings. *Algorithmica* 75, Issue 2, pp. 295–321 (2016)
18. Kannan, S., Naor, M., Rudich, S.: Implicit representation of graphs. *SIAM J. Discrete Mathematics* 5, pp. 596–603 (1992)
19. McConnell, R.M., de Montgolfier, F.: Linear-time modular decomposition of directed graphs. *Discrete Applied Mathematics* 145, pp. 198–209 (2005)
20. Wrochna, M.: Reconfiguration in bounded bandwidth and treedepth. [arXiv:1405.0847](https://arxiv.org/abs/1405.0847) (2014)
21. Wrochna, M.: Homomorphism reconfiguration via homotopy. *Proc. of STACS 2015, LIPIcs* 30, pp. 730–742 (2015)