

# BELIEFS IN MARKOV TREES - FROM LOCAL COMPUTATIONS TO LOCAL VALUATION

MIECZYSLAW A. KŁOPOTEK

*Institute of Computer Science, Polish Academy of Sciences  
PL 01-237 Warsaw, 21 Ordona St., Poland*

## ABSTRACT

This paper is devoted to expressiveness of hypergraphs for which uncertainty propagation by local computations via Shenoy/Shafer method applies. It is demonstrated that for this propagation method for a given joint belief distribution no valuation of hyperedges of a hypergraph may provide with simpler hypergraph structure than valuation of hyperedges by conditional distributions. This has vital implication that methods recovering belief networks from data have no better alternative for finding the simplest hypergraph structure for belief propagation. A method for recovery tree-structured belief networks has been developed and specialized for Dempster-Shafer belief functions.

## 1. INTRODUCTION

Shenoy and Shafer [16] presented an axiomatic system and a method for calculation of conditional beliefs by local computations. The method enables to reduce space requirements for representation of multivariate joint belief distributions. Shenoy and Shafer have shown that their framework is suitable both for bayesian and Dempster-Shafer belief distributions. They generalize in their paper similar works of other authors who concentrated on uncertainty propagation in bayesian networks [2], [14], [12], and for DS belief functions [15], [7].

One important innovation of Shenoy and Shafer [16] was to separate the notion of factorization from the notion of conditionality. Other authors insisted previously [14], [12] that factors in bayesian networks be conditional distributions.

The goal of this paper is to investigate to what extent this innovation is really significant and what impact it may have on development of algorithms for recovery (identification) of belief networks (factorization of belief distribution) from data.

## 2. SHENOY/SHAFER FRAMEWORK

We recall below some definitions from [16]:

*Hypergraphs:* A nonempty set  $H$  of nonempty subsets of a finite set  $S$  be called a hypergraph on  $S$ . The elements of  $H$  be called hyperedges. Elements of  $S$  be called vertices.  $H$  and  $H'$  be both hypergraphs on  $S$ , then we call a hypergraph  $H'$  a *reduced*

*hypergraph* of the hypergraph  $H$ , iff for every  $h' \in H'$  also  $h' \in H$  holds, and for every  $h \in H$  there exists such a  $h' \in H'$  that  $h \subseteq h'$ . A hypergraph  $H$  *covers* a hypergraph  $H'$  iff for every  $h' \in H'$  there exists such a  $h \in H$  that  $h' \subseteq h$ .

*Hypertrees*:  $t$  and  $b$  be distinct hyperedges in a hypergraph  $H$ ,  $t \cap b \neq \emptyset$ , and  $b$  contains every vertex of  $t$  that is contained in a hyperedge of  $H$  other than  $t$ ; if  $X \in t$  and  $X \in h$ , where  $h \in H$  and  $h \neq t$ , then  $X \in b$ . Then we call  $t$  a twig of  $H$ , and we call  $b$  a branch for  $t$ . A twig may have more than one branch. We call a hypergraph a hypertree if there is an ordering of its hyperedges, say  $h_1, h_2, \dots, h_n$  such that  $h_k$  is a twig in the hypergraph  $\{h_1, h_2, \dots, h_k\}$  whenever  $2 \leq k \leq n$ . We call any such ordering of hyperedges a hypertree construction sequence for the hypertree. The first hyperedge in the hypertree construction sequence be called the root of the hypertree construction sequence.

*Factorization*: Suppose  $A$  is a valuation on a finite set of variables  $\mathbf{V}$ , and suppose  $HV$  is a hypergraph on  $\mathbf{V}$ . If  $A$  is equal to the combination of valuations of all hyperedges  $h$  of  $HV$  then we say that  $A$  factorizes on  $HV$ .

*Conditioning*: Suppose  $BEL$  is a belief distribution, and  $BEL_E$  is an indicator potential capturing the evidence  $E$ . Then conditional belief function conditioned on  $E$ ,  $BEL(.|E)$ , is defined as  $BEL(.|E) = BEL \odot BEL_E$  (see [16] p.191 for probabilistic case,  $Bel_E$  may be a simple support function in DS case), The axiom A3 states that to compute  $(G \odot H)^{\downarrow g}$  it is not necessary to compute  $G \odot H$  first.

Shenoy and Shafer consider it unimportant whether or not the factorization should refer to conditional probabilities in case of probabilistic belief networks. But for expert system inference engine it is of primary importance how contents of knowledge base should be understood by a user as it should at least justify its conclusions by elements of knowledge base. So if a belief network (or a hypergraph) is to be used as knowledge base, as much elements as possible have to refer to experience of the user.

In our opinion, the major reason for this remark of Shenoy and Shafer is that in fact the Dempster-Shafer belief function cannot be decomposed in terms of any conditional belief function as defined in the literature [9]. But an intriguing question remains whether replacement of conditional belief function with a any belief function in the factorization extends essentially the class of such factorizations.

### 3. HYPERGRAPHS AND BELIEF NETWORKS

The axiomatization system of Shenoy/Shafer refers to the notion of factorization along a hypergraph. On the other hand other authors insisted on a decomposition into a belief network. We investigate below implications of this disagreement

**Definition 1** We define a mapping  $\overline{\odot} : VV \times VV \rightarrow VV$  called *decombination* such that: if  $BEL_{12} = BEL_1 \overline{\odot} BEL_2$  then  $BEL_1 = BEL_2 \odot BEL_{12}$ .

In case of probabilities, decombination means memberwise division:  $Pr_{12}(A) = Pr_1(A)/Pr_2(A)$ . In case of DS pseudo-belief functions it means the operator  $\ominus$  yielding a DS pseudo-belief function such that: whenever  $Bel_{12} = Bel_1 \ominus Bel_2$  then  $Q_{12}(A) = c \cdot Q_1/Q_2$ . Both for probabilities and for DS belief functions decombination

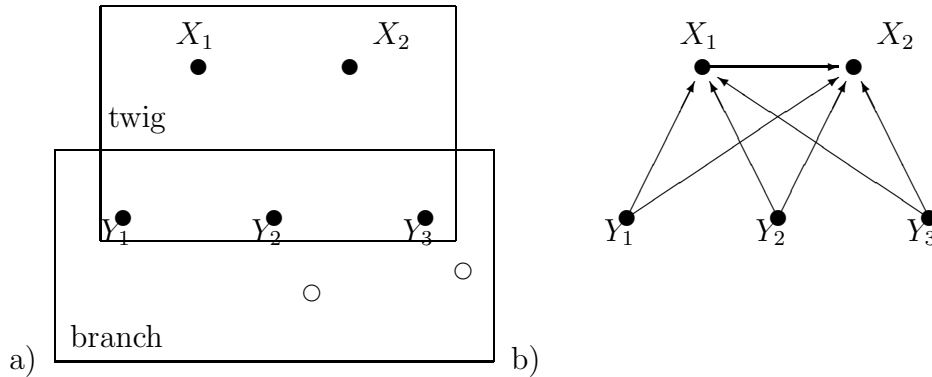

Figure 1: An example of a) a twig in hypertree and b) its fragment of belief network

may be not uniquely determined. Moreover, for DS belief functions not always a decomposed DS belief function will exist. Hence we extend the domain to DS pseudo-belief functions which is closed under this operator. We claim here without a proof (which is simple) that DS pseudo-belief functions fit the axiomatic framework of Shenoy/Shافر. Moreover, we claim that if an (ordinary) DS belief function is represented by a factorization in DS pseudo-belief functions, then any propagation of uncertainty yields the very same results as when it would have been factorized into ordinary DS belief functions.

**Definition 2** *By mk-conditioning  $|$  of a belief function  $BEL$  on a set of variables  $h$  we understand the transformation:  $BEL|_h = BEL \overline{\odot} BEL^{\downarrow h}$ .*

Notably, mk-conditioning means in case of probability functions proper conditioning. In case of DS pseudo-belief functions the operator  $|$  has meaning entirely different from traditionally used notion of conditionality (compare [9]) - mk-conditioning is a technical term used exclusively for valuation of nodes in belief networks. Notice: some other authors e.g. [3] recognized also the necessity of introduction of two different notions in the context of the Shenoy/Shافر axiomatic framework (compare a priori and a posteriori conditionals in [3]). [3] introduces 3 additional axioms governing the 'a priori' conditionality to enable propagation with them. Our mk-conditionality is bound only to the assumption of executability of the  $\overline{\odot}$  operation and does not assume any further properties of it. We will discuss the consequences of this difference elsewhere. Let us define now the general notion of belief networks (generalizing definition of belief network from [6] - bayesian networks, and [10] - DS networks). :

**Definition 3** *A belief network is a pair  $(D, BEL)$  where  $D$  is a dag (directed acyclic graph) and  $BEL$  is a belief distribution called the underlying distribution. Each node  $i$  in  $D$  corresponds to a variable  $X_i$  in  $BEL$ , a set of nodes  $I$  corresponds to a set of variables  $X_I$  and  $x_i, x_I$  denote values drawn from the domain of  $X_i$  and from the (cross product) domain of  $X_I$  respectively. Each node in the network is regarded as*

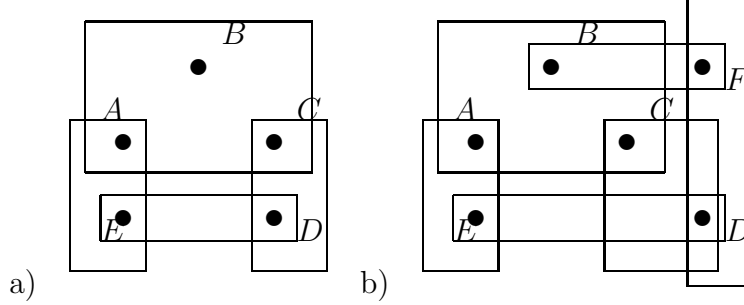

Figure 2: An example of hypergraphs a) with b) without compatible belief network

a storage cell for any distribution  $BEL^{\downarrow\{X_i\} \cup X_{\pi(i)} | X_{\pi(i)}}$  where  $X_{\pi(i)}$  is a set of nodes corresponding to the parent nodes  $\pi(i)$  of  $i$ . The underlying distribution represented by a belief network is computed via:

$$BEL = \bigodot_{i=1}^n BEL^{\downarrow\{X_i\} \cup X_{\pi(i)} | X_{\pi(i)}}$$

Please notice the local character of valuation of a node: to value the node  $i$  corresponding to variable  $X_i$  only the marginal  $BEL^{\downarrow\{X_i\} \cup X_{\pi(i)}}$  needs to be known (e.g. from data) and not the entire belief distribution.

There exists a straight forward transformation of a belief network structure into a hypergraph, and hence of a belief network into a hypergraph: for every node  $i$  of the underlying dag define a hyperedge as the set  $\{X_i\} \cup X_{\pi(i)}$ ; then the valuation of this hyperedge define as  $BEL^{\downarrow\{X_i\} \cup X_{\pi(i)} | X_{\pi(i)}}$ . We say that the hypergraph obtained in this way is *induced* by the belief network.

Let us consider now the inverse operation: transformation of a valuated hypergraph into a belief network. As the first stage we consider structures of a hypergraph and of a belief network (the underlying dag). we say that a belief network is *compatible* with a hypergraph iff the reduced set of hyperedges induced by the belief network is identical with the reduced hypergraph.

**Example 1** Let us consider the following hypergraph (see Fig.2.a):  $\{\{A,B,C\}, \{C,D\}, \{D,E\}, \{A, E\}\}$ . the following belief network structures are compatible with this hypergraph:  $\{A, C \rightarrow B, C \rightarrow D, D \rightarrow E, E \rightarrow A\}$  (see Fig.3.a)),  $\{A, C \rightarrow B, D \rightarrow C, D \rightarrow E, E \rightarrow A\}$ , (see Fig.3.b)),  $\{A, C \rightarrow B, D \rightarrow C, E \rightarrow D, E \rightarrow A\}$ , (see Fig.3.c)),  $\{A, C \rightarrow B, D \rightarrow C, E \rightarrow D, A \rightarrow E\}$ . (see Fig.3.d)),  $\diamond$

**Example 2** Let us consider the following hypergraph (see Fig.2.b):  $\{\{A,B,C\}, \{C,D\}, \{D,E\}, \{A, E\}, \{B,F\}, \{F,D\}\}$ . No belief network structure is compatible with it.  $\diamond$

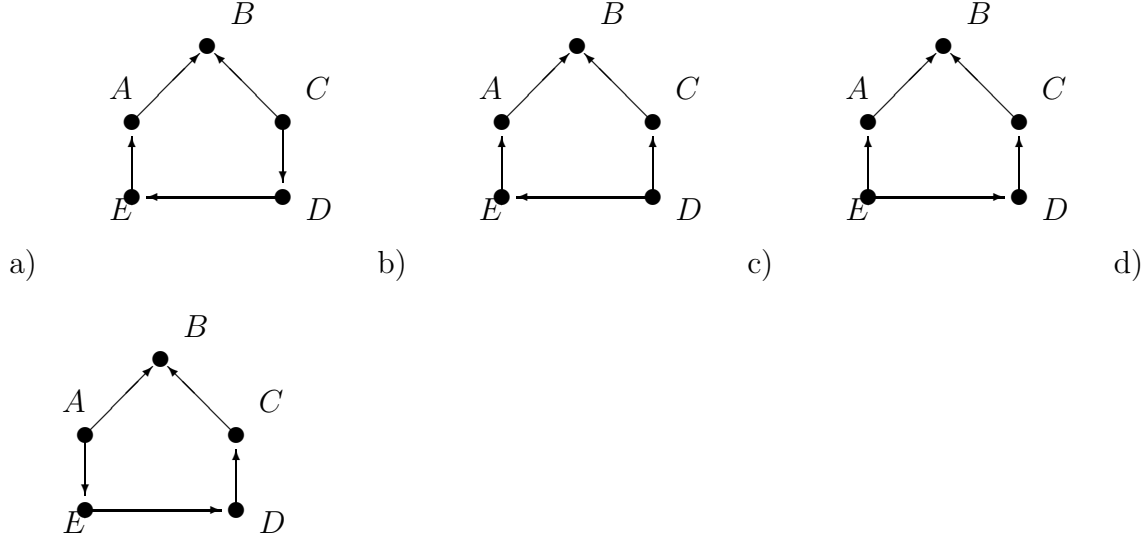

Figure 3: An example of belief networks corresponding to a hypergraph from Fig.2 a)

The missing compatibility is connected with the fact that a hypergraph may represent a cyclic graph. Even if a compatible belief network has been found we may have troubles with valuations. In Example 1 an unfriendly valuation of hyperedge  $\{A,C,B\}$  may require an edge  $AC$  in a belief network representing the same distribution, but it will make the hypergraph incompatible (as e.g. hyperedge  $\{A,C,E\}$  would be induced). This may be demonstrated as follows:

**Definition 4** If  $X_J, X_K, X_L$  are three disjoint sets of variables of a distribution  $BEL$ , then  $X_J, X_K$  are said to be conditionally independent given  $X_L$  (denoted  $I(X_J, X_K|X_L)_{BEL}$  iff

$$BEL \downarrow^{X_J \cup X_K \cup X_L | X_L} \odot BEL \downarrow^{X_L} = BEL \downarrow^{X_J \cup X_L | X_L} \odot BEL \downarrow^{X_K \cup X_L | X_L} \odot BEL \downarrow^{X_L}$$

$I(X_J, X_K|X_L)_{BEL}$  is called a conditional independence statement

Let  $I(J, K|L)_D$  denote d-separation in a graph [6].:

**THEOREM 1** Let  $BEL_D = \{BEL | (D, BEL) \text{ be a belief network}\}$ . Then:  $I(J, K|L)_D$  iff  $I(X_J, X_K|X_L)_{BEL}$  for all  $BEL \in BEL_D$ .

Proof of this theorem may be constructed analogously to the one for DS belief networks in [10]. Now we see in the above example that nodes  $D$  and  $E$  d-separate nodes  $A$  and  $C$ . Hence within any belief network based on one of the three dags mentioned  $A$  will be conditionally independent from  $C$  given  $D$  and  $E$ . But one can easily check that with general type of hypergraph valuation nodes  $A$  and  $C$  may be rendered dependent. The sad result of this section is, that really

**THEOREM 2** *Hypergraphs considered by Shenoy/Shافر [16] may for a given joint belief distribution have simpler structure than (be properly covered by) the closest hypergraph induced by a belief network.*

## 4. HYPERTREES AND BELIEF NETWORKS

Notably, though the axiomatic system of Shenoy/Shافر refers to hypergraph factorization of a joint belief distribution, the actual propagation is run on a hypertree (or more precisely, on one construction sequence of a hypertree, that is on Markov tree) covering that hypergraph. Covering a hypergraph with a hypertree is a trivial task, yet finding the optimal one (with as small number of variables in each hyperedge of the hypertree as possible) may be very difficult [16].

Let us look closer at the outcome of the process of covering with a reduced hypertree factorization, or more precisely, at the relationship of a hypertree construction sequence and a belief network constructed out of it in the following way: If  $h_k$  is a twig in the sequence  $\{h_1, \dots, h_k\}$  and  $h_{i_k}$  its branch with  $i_k < k$ , then let us span the following directed edges in a belief network: First make a complete directed acyclic graph out of nodes  $h_k - h_{i_k}$ . Then add edges  $Y_l \rightarrow X_j$  for every  $Y_l \in h_k \cap h_{i_k}$  and every  $X_j \in h_k - h_{i_k}$ . (see Fig.1). Repeat this for every  $k=2, \dots, n$ . nodes contained in  $h_1$ ).

For  $k=1$  proceed as if  $h_1$  were a twig with an empty set as a branch for it.

It is easily checked that the hypergraph induced by a belief network structure obtained in this way is in fact a hypertree (if reduced, then exactly the original reduced hypertree). Let us turn now to valuations. Let  $BEL_i$  be the valuation originally attached to the hyperedge  $h_i$ . then  $BEL = BEL_1 \odot \dots \odot BEL_n$ . (see Fig.4 a)). What conditional belief is to be attached to  $h_n$ ? First marginalize:  $BEL'_n = BEL_1 \downarrow^{h_1 \cap h_n} \odot \dots \odot BEL_{n-1} \downarrow^{h_{n-1} \cap h_n} \odot BEL_n$ . (see Fig.4 b), c)) Now calculate:  $BEL''_n = BEL'_n \uparrow^{h_n \cap h_{i_n}}$ , and  $BEL'''_n = BEL'_n \downarrow^{h_n \cap h_{i_n}}$ . Let  $BEL_{*k} = BEL_k \overline{\odot} BEL_k \downarrow^{h_1 \cap h_n}$  for  $k=1, \dots, i_n-1, i_n+1, \dots, (n-1)$ , (see Fig.4 d)) and let  $BEL_{*i_n} = (BEL_{i_n} \overline{\odot} BEL_{i_n} \downarrow^{h_1 \cap h_n}) \odot BEL'''_n$ . Obviously,  $BEL = BEL_{*1} \odot \dots \odot BEL_{*(n-1)} \odot BEL''_n$  (see Fig.4 e)). Now let us consider a new hypertree only with hyperedges  $h_1, \dots, h_{n-1}$ , and with valuations equal to those marked with asterisk (\*), and repeat the process until only one hyperedge is left, the now valuation of which is considered as  $BEL''_1$ . In the process, a new factorization is obtained:  $BEL = BEL''_1 \odot \dots \odot BEL''_n$ . If now for a hyperedge  $h_k$   $card(h_k - h_{i_k}) = 1$ , then we assign  $BEL''_k$  to the node of the belief network corresponding to  $h_k - h_{i_k}$ . If for a hyperedge  $h_k$   $card(h_k - h_{i_k}) > 1$ , then we split  $BEL''_k$  as follows: Let  $h_k - h_{i_k} = \{X_{k1}, X_{k2}, \dots, X_{km}\}$  and the indices shall correspond to the order in the belief network induced by the above construction procedure. Then

$$BEL''_k = BEL \downarrow^{h_k | h_k \cap h_{i_k}} = \bigodot_{j=1}^m BEL \downarrow^{(h_k \cap h_{i_k}) \cup \{X_{k1}, \dots, X_{kj}\} | (h_k \cap h_{i_k}) \cup \{X_{k1}, \dots, X_{kj}\} - \{X_{kj}\}}$$

and we assign valuation  $BEL \downarrow^{(h_k \cap h_{i_k}) \cup \{X_{k1}, \dots, X_{kj}\} | (h_k \cap h_{i_k}) \cup \{X_{k1}, \dots, X_{kj}\} - \{X_{kj}\}}$  to the node

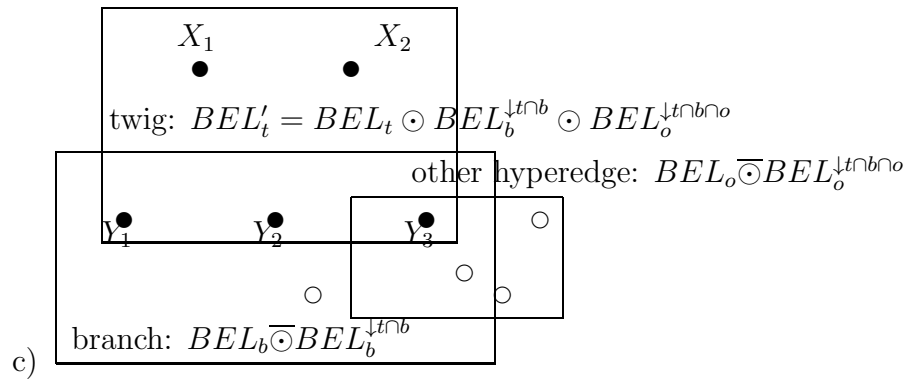
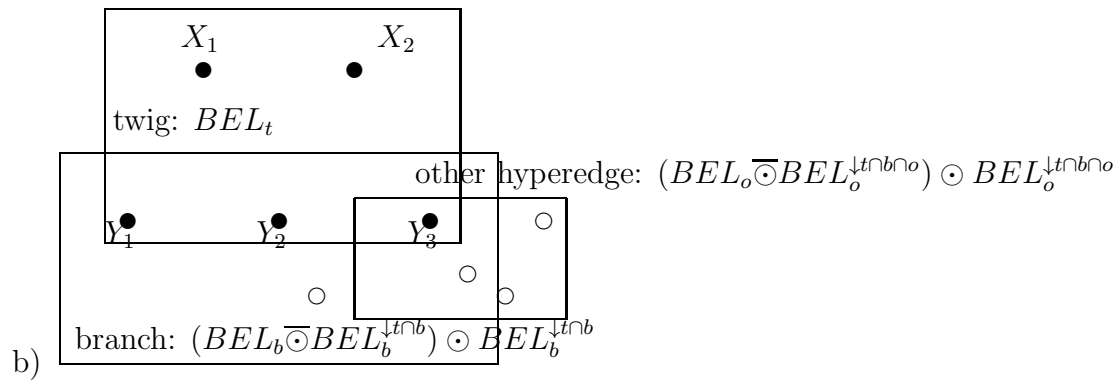
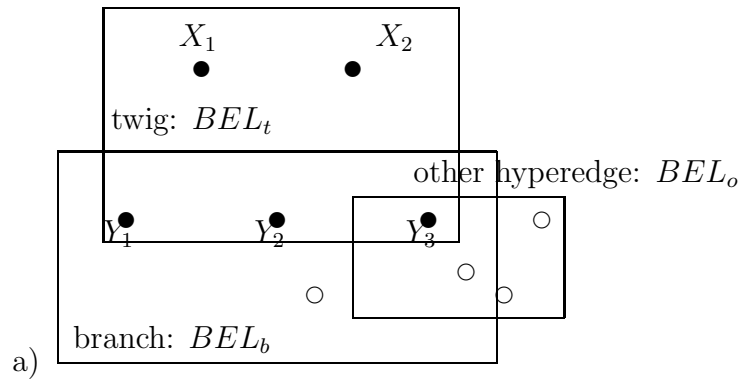

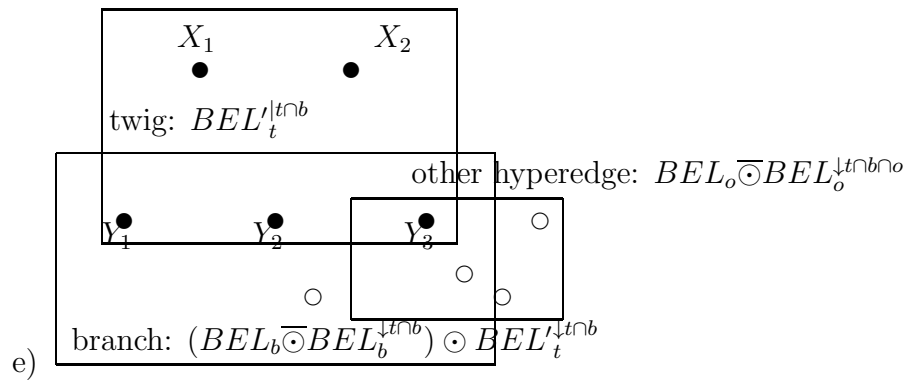
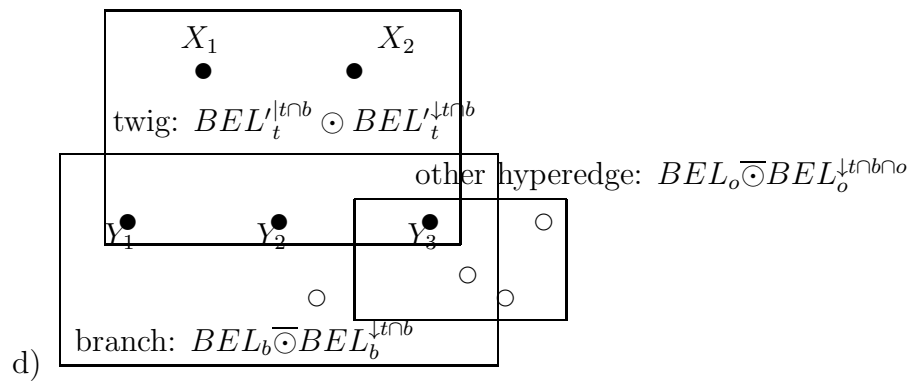

Figure 4: An example of valuation transformation



corresponding to  $X_{kj}$  in the network structure. It is easily checked that:

- THEOREM 3** (i) *The network obtained by the above construction of its structure and valuation from hypertree factorization is a belief network.*  
(ii) *This belief network represents exactly the joint belief distribution of the hypertree*  
(iii) *This belief network induces exactly the original reduced hypertree structure*

The above theorem implies that any hypergraph suitable for propagation must have a compatible belief network. Hence seeking for belief network decompositions of joint belief distributions is sufficient for finding any suitable factorization.

## 5. BELIEF TREES AND HYPERTREES

Let us consider now a special class of hypertrees: connected hypertrees with cardinality of each hyperedge equal 2. It is easy to demonstrate that such hypertrees correspond exactly to directed trees. Furthermore, valuated hypergraphs of this form correspond to belief networks with directed trees as underlying dag structures. Hence we can conclude that any factorization in form of connected hypertrees with cardinality of each hyperedge equal 2 may be recovered from data by algorithms recovering belief trees from data. This does not hold e.g. for poly-trees.

Algorithms recovering general type belief networks from data are still to be invented. Major obstacle for such algorithms is the badly defined relationship between various types of representation of uncertainty and the empirical data. This topic will not be discussed here. Instead we will assume that there exists a measure  $\delta(BEL_1, BEL_2)$  equal to zero whenever both belief distributions  $BEL_1, BEL_2$  are identical and being positive otherwise. Furthermore, we assume that  $\delta$  grows with stronger deviation of both distributions without specifying it further. The algorithm of Chow/Liu [4] for recovery of tree structure of a probability distribution is well known and has been deeply investigated, so we will omit its description. It requires a distance measure  $DEP(X, Y)$  between each two variables  $X, Y$  rooted in empirical data and spans a maximum weight spanning unoriented tree between the nodes. Then any orientation of the tree is the underlying dag structure where valuations are calculated as conditional probabilities. To accommodate it for general belief trees one needs a proper measure of distance between variables. As claimed earlier in [1], this distance measure has to fulfill the following requirement:  $\min(DEP(X, Y), DEP(Y, Z)) > DEP(X, Z)$  for any  $X, Y, Z$  such that there exists a directed path between  $X$  and  $Y$ , and between  $Y$  and  $Z$ . For probabilistic belief networks one of such functions is known to be Kullback-Leibler distance:

$$DEP_0(X, Y) = \sum_{x,y} P(x, y) \cdot \log \frac{P(x, y)}{P(x) * P(y)}$$

If we have the measure  $\delta$  available, we can construct the measure  $DEP$  as follows: By the ternary joint distribution of the variables  $X_1, X_3$  with background  $X_3$  we understand the function:

$$BEL^{\downarrow X_1 \times X_2 | X_3} = (BEL^{\downarrow X_1 \times X_3 | X_3} \odot BEL^{\downarrow X_2 \times X_3 | X_3} \odot BEL^{\downarrow X_3})^{\downarrow X_1 \times X_2}$$

Then we introduce:

$$DEP_{BN}(X_1, X_2) = \min(\delta(BEL^{\downarrow X_1} \odot BEL^{\downarrow X_2}, BEL^{\downarrow X_1 \times X_2}), \\ \min_{X_3; X_3 \in \mathbf{V} - X_1, X_2} \delta(BEL^{\downarrow X_1 \times X_2 [X_3]}, BEL^{\downarrow X_1 \times X_2}))$$

with  $\mathbf{V}$  being the set of all variables. The following theorem is easy to prove:

**THEOREM 4**  $\min(DEP_{BN}(X, Y), DEP_{BN}(Y, Z)) > DEP_{BN}(X, Z)$  for any  $X, Y, Z$  such that there exists a directed path between  $X$  and  $Y$ , and between  $Y$  and  $Z$ .

This suffices to extend the Chow/Liu algorithm to recover general belief tree networks from data. To demonstrate the validity of this general theorem, its specialization was implemented for the Dempster-Shafer belief networks. The following  $\delta$  function was used: Let  $Bel_1$  be a DS belief function and  $Bel_2$  be a DS pseudo-belief function approximating it. Let

$$\delta(Bel_2, Bel_1) = \sum_{A; m_1(A) > 0} m_1(A) \cdot \left| \ln \frac{Q_1(A)}{Q_2(A)} \right|$$

where the assumption is made that natural logarithm of a non-positive number is plus infinity.  $|\cdot|$  is the absolute value operator. The values of  $\delta$  in variable  $Bel_2$  with parameter  $Bel_1$  range:  $[0, +\infty)$ . For randomly generated tree-like DS belief distributions, if we were working directly with these distributions, as expected, the algorithm yielded perfect decomposition into the original tree. For random samples generated from such distributions, the structure was recovered properly for reasonable sample sizes (200 for up to 8 variables). Recovery of the joint distribution was not too perfect, as the space of possible value combination is tremendous and probably quite large sample sizes would be necessary. It is worth mentioning, that even with some departures from truly tree structure a distribution could be obtained which reasonable approximated the original one.

## 6. CONCLUSIONS

In this paper it has been shown that valuated hypertrees may be represented equivalently by belief networks. This is of special importance for propagation of uncertainty within the Shenoy/Shافر axiomatic framework for local computations. Namely, the simplest possible hypertree factorizations of a belief distribution may be obtained by methods recovering belief network structure from data and then the valuation of hyperedges may be carried out by local computation from marginals of the belief distribution. Another contribution of this paper is to extend the Chow/Liu algorithm of recovering tree-like belief network structures for probability distributions onto general type belief distributions fitting the axiomatic framework of Shenoy/Shافر.

## REFERENCES

- [1] S. Acid, L.M. deCampos, A. Gonzales, R. Molina and N. Perez de la Blanca, "Learning with CASTLE", *Symbolic and Quantitative Approaches to Uncertainty*, (Kruse R., Siegel P. Eds), Lecture Notes In Computer Science **548**, Springer-Verlag 1991, 99-106
- [2] C. Cannings, E.A. Thompson and M.H. Skolnick, "Probability functions on complex pedigrees", *Advances in Applied Probability*, **10**, (1978),26-61.
- [3] J. Cano, M. Delgado and S. Moral, "An axiomatic framework for propagating uncertainty in directed acyclic networks", *International Journal of Approximate Reasoning*. 1993:**8**, 253-280.
- [4] C.K. Chow, C.N. Liu, "Approximating discrete probability distributions with dependence trees", *IEEE Transactions on Information Theory*, Vol. **IT-14**, No.3, (1968), 462-467
- [5] Dempster A.P., Kong A.: Uncertain evidence and artificial analysis, Research Report S-108, Department of Statistics, Harvard University (1986).
- [6] D. Geiger, T. Verma and J. Pearl, "d-Separation: From theorems to algorithms", in : *Uncertainty in Artificial Intelligence 5* (M.Henrion, R.D.Shachter, L.N.Kamal and J.F.Lemmer Eds), Elsevier Science Publishers B.V. (North-Holland), 1990, 139-148.
- [7] Y. Hsia and P. Shenoy, "An evidential language for expert systems", *Methodologies for Intelligent System 4*, (Z. Raś.Ed.), North Holland (1989), 9-16
- [8] C.W. Kelly III and S. Barclay, "A general Bayesian model for hierarchical inference", *Organizational Behavior and Human Performance*, **10**(1973), 388-403
- [9] M.A. Kłopotek, Probabilistyczne ujęcia teorii Dempstera-Shafera - Krytyczna analiza w świetle zagadnienia identyfikacji struktury z danych,"Probabilistic approaches to Dempster-Shafer theory - Critical analysis in the light of the problem of identification of structure from data" (in Polish), *Proc. VI National Conference on Cybernetics, Intelligence, Development*, 28-29 September 1993, Siedlce, Poland, 80-93
- [10] M.A. Kłopotek, "Dempsterian-Shaferian Belief Network From Data", submitted
- [11] Kong A.: Multivariate belief functions and graphical models, doctoral dissertation, Department of Statistics, Harvard University (1986).
- [12] S.L. Lauritzen and D.J. Spiegelhalter, "Local computations with probabilities on graphical structures and their application to expert system (with discussion)", *Journal of the Royal Statistical Society, Series B*, **50**(2)1988, 157-224.
- [13] K. Mellouli, "On the propagation of beliefs in networks using the Dempster-Shafer theory of evidence", doctoral dissertation, School of Business, University of Kansas, (1987).
- [14] J. Pearl, "Fusion, propagation and structuring in belief networks", *Artificial Intelligence* **29**(1986), 241-288.

- [15] G Shafer, P, Shenoy and K. Mellouli, "Propagating belief functions in quantitative Markov trees", *International Journal of Approximate Reasoning*. 1987:**1**, (4), 349-400.
- [16] P. Shenoy and G. Shafer, "Axioms for probability and belief-function propagation", *Uncertainty in Artificial Intelligence 4* (Shachter R.D., Levitt T.S., Kanal L.N., Lemmer J.F. Eds), Elsevier Science Publishers B.V. (North Holland), 1990, 169-198.
- [17] Spirtes P., Glymour C., Scheines R.: Causality from probability, in *Evolving knowledge in natural and artificial intelligence*, (G. McKee Ed.), Pitman, London, 1990.
- [18] D.K. Zarley, Y Hsia, G. Shafer, "Evidential reasoning using DELIEF", *Proc. of the Seventh National Conference on Artificial Intelligence (AAAI-88)*, **1**, Minneapolis, MN, 1988, 205-209.