

This is a preprint of the paper:

David Megías, Amna Qureshi, “Collusion-resistant and privacy-preserving P2P multimedia distribution based on recombined fingerprinting”, *Expert Systems with Applications*, Volume 71, 1st April 2017, Pages 147-172, ISSN 0957-4174, <http://dx.doi.org/10.1016/j.eswa.2016.11.015>.

arXiv:1703.01348v1 [cs.CR] 3 Mar 2017

Collusion-resistant and privacy-preserving P2P multimedia distribution based on recombined fingerprinting

David Megías, Amna Qureshi

*Estudis d'Informàtica Multimèdia i Telecomunicació,
Internet Interdisciplinary Institute (IN3),
Universitat Oberta de Catalunya (UOC),
Barcelona, Spain.
Email: {dmegias, aqureshi}@uoc.edu*

Abstract

Recombined fingerprints have been suggested as a convenient approach to improve the efficiency of anonymous fingerprinting for the legal distribution of copyrighted multimedia contents in P2P systems. The recombination idea is inspired by the principles of mating, recombination and heredity of the DNA sequences of living beings, but applied to binary sequences, like in genetic algorithms. However, the existing recombination-based fingerprinting systems do not provide a convenient solution for collusion resistance, since they require “double-layer” fingerprinting codes, making the practical implementation of such systems a challenging task. In fact, collusion resistance is regarded as the most relevant requirement of a fingerprinting scheme, and the lack of any acceptable solution to this problem would possibly deter content merchants from deploying any practical implementation of the recombination approach. In this paper, this drawback is overcome by introducing **two non-trivial improvements**, paving the way for a future real-life application of recombination-based systems. First, Nuida et al.'s collusion-resistant codes are used in segment-wise fashion **for the first time**. Second, **a novel version of the traitor-tracing algorithm** is proposed in the encrypted domain, also for the first time, making it possible to provide the buyers with security against framing. In addition, the proposed method avoids the use of public-key cryptography for the multimedia content and expensive cryptographic protocols, leading to excellent performance in terms of both computational and communication burdens. In fact, after bootstrapping, the merchant is no longer required to participate in any file transfer, reducing the investment in equipment required for content distribution to the bare minimum. The paper also analyzes the security and privacy properties of the proposed system both formally and informally, whereas the collusion resistance and the performance of the method are shown by means of experiments and simulations.

Keywords: P2P content distribution; Collusion-resistant fingerprinting; Recombined fingerprints; Privacy

1. Introduction

The reduced costs, scalability and ease of content dissemination in the digital era provide content providers with a lucrative opportunity to generate revenues through P2P systems. These benefits are the major motivation for media

companies to adopt the P2P technology. However, content providers have been reluctant in choosing the P2P paradigm as a distribution vehicle to monetize digital content, since these systems are plagued with piracy. The ability to make perfect copies and the ease with which these copies can then be distributed has given rise to significant problems regarding the misuse, illegal copying and re-distribution. Copyright holders encounter uncertainties regarding the adoption or rejection of P2P networks to spread content over the Internet, since they apparently fear losing control of content distribution and worry about the promotion of illegal activity. Also, tracing a copyright violator in a P2P system with millions of connected users is an immense task. Therefore, ensuring the appropriate use of copyrighted multimedia content in P2P systems has become increasingly critical. The copyright infringement problem motivates the development of content protection techniques. Encryption can provide multimedia data with desired security during transmission by preventing them from unauthorized accessing. However, once a piece of digital content is decrypted, a dishonest customer may re-distribute it arbitrarily. Similarly, classic Digital Rights Management (DRM) systems (iTunes, 2001; DRM, 2008) that are considered as a second line of defense against copyright violation, does not prove to be an effective access control against a user with the knowledge and determination to violate it. For content owners, digital watermarking proves to be a more effective anti-piracy solution. Digital watermarking has become a significant area of research and development, and the usage of these techniques is now being considered a requisite to address the issues faced by the proliferation of digital content. Watermarking consists of embedding a watermark, into the content that can be used later on to check the source of the content. There are two forms of watermarking, copyright watermarking and fingerprint watermarking (fingerprinting). In copyright watermarking, a watermark is embedded into the content, which indicates copyright holders identification. This is used to declare the copyright and cannot be used to trace the copyright violator. On the other hand, fingerprinting techniques involve the generation of a fingerprint (a buyer-specific identification mark), the embedding operation and the development of a traitor-tracing mechanism from re-distributed copies.

In this paper, we consider two main types of participants: the merchant, who retails several items, and the buyer, who purchases (receives) an item. Traditionally, the fingerprinting scheme is usually encapsulated by running a fingerprinting protocol between the buyer and the merchant, which should prevent both parties from cheating. However, for most existing fingerprinting protocols, security comes at the cost of the buyer's privacy. In particular, in symmetric fingerprinting protocols, it is assumed that the merchants are trustworthy and always perform embedding honestly (Cox et al., 1997). However, when the buyer downloads the fingerprinted copy, the merchant can link the buyer's identity to the unique fingerprint in that copy. Apart from knowing the identity of the buyer, the merchant could also frame him/her by releasing a copy bound to him/her and accuse him/her of illegal re-distribution. Asymmetric fingerprinting schemes (Pfitzmann and Schunter, 1996) were introduced to overcome this problem. In these schemes, the fingerprint is generated through a secure dyadic protocol between the merchant and the buyer. At the end of the transaction, the merchant learns a part of the fingerprint, called the halfword, which is used to trace the buyer's identity but is not enough to frame him/her. The complete fingerprinted item is only delivered to the buyer, and thus, the merchant does not have access to the fingerprinted content obtained by the buyer. However, in both the symmetric and the

asymmetric cases, the merchant still learns the identity of all buyers. This problem was solved by Qian and Nahrstedt (1998) by introducing anonymous fingerprinting. Anonymous fingerprinting schemes retain the asymmetric property and also protect the privacy of a buyer, whose identity is only revealed and disclosed in case of illegal re-distribution. Thus, an anonymous fingerprinting protocol ensures copyright protection, privacy and security for both the buyer and the merchant simultaneously. Many fingerprinting schemes (Pfitzmann and Waidner, 1997; Pfitzmann and Sadeghi, 1999; Memon and Wong, 2001) employed trusted third parties to provide fairness and anonymity to the merchant and the buyer, respectively. Various fingerprinting schemes do not involve trusted parties for the execution of the protocols (Choi et al., 2003; Deng and Preneel, 2008). Other proposals, such as (Camenisch, 2000), require a trusted third party only when a malicious buyer is identified and legal actions shall be taken against him/her.

Some fingerprinting protocols are based on bit-commitment schemes (Pfitzmann and Schunter, 1996; Biehl and Meyer, 2002), which require high enciphering rates to achieve security. Other proposals, like (Kuribayashi and Tanaka, 2005; Prins et al., 2007; Rial et al., 2010), take advantage of the homomorphic property of some public-key cryptosystem. The homomorphic property allows the merchant to embed the fingerprint in the encrypted domain in such a way that only the buyer obtains the decrypted fingerprinted content. However, the use of homomorphic encryption expands data and substantially increases the communication bandwidth required for data transfers. Thus, in any case, all the proposed fingerprinting schemes involve complex cryptographic protocols, which require high bandwidth and heavy computational costs.

A major challenge in digital fingerprinting is to thwart collusion attacks, in which several buyers, who receive copies of the same content but embedded with different fingerprints, conspire to create a new copy in which the original fingerprints are either removed or attenuated. If not properly designed, a fingerprinting system might fail to detect the traces of any fingerprints under collusion attacks with only a few colluders. Anti-collusion codes are specifically designed to counter this threat. Indeed, if the fingerprints embedded into content are codewords of anti-collusion codes, then the structure of the code allows the retrieval of the identity of at least one of the colluders. A growing number of techniques (Boneh and Shaw, 1999; Chor et al., 2000; Domingo-Ferrer and Herrera-Joancomartí, 2000; Tardos, 2003; Sebé and Domingo-Ferrer, 2003; Nuida et al., 2007) have been proposed in the literature to provide collusion resistance in multimedia fingerprinting systems. In most of the existing fingerprinting schemes, it is assumed that the use of anti-collusion codes can make the schemes secure against collusion attacks without giving any proof of concept.

More recently, other asymmetric fingerprinting schemes relying on c -secure codes have been proposed. In (Charpentier et al., 2011), the buyer selects the fingerprint bits from a list controlled by the merchant, but the system uses an oblivious transfer protocol which requires heavy computations. In addition, the number of communication rounds between buyer and merchant has a linear relation with the length of the code, making it impractical for most real-world scenarios. On the other hand, the system of (Pehlivanoglu, 2013) can be applied with a constant communication cost at the price of a longer codeword based on Bone-Shaw codes.

Most of the fingerprinting systems (Pfitzmann and Schunter, 1996; Camenisch, 2000; Memon and Wong, 2001;

Choi et al., 2003; Kuribayashi and Tanaka, 2005; Prins et al., 2007; Deng and Preneel, 2008; Rial et al., 2010) found in literature are based on the traditional client-server model, where a merchant acts as a server and the buyers are the clients. Thus, the buyers obtain their fingerprinted copies of the content from the merchant in a centralized manner. This approach is non-scalable, since, for N buyers, the merchant has to run the embedding algorithm N times to produce N fingerprinted copies. Also, the existing fingerprinting schemes involve expensive cryptographic protocols to provide secure and privacy-preserving content distribution. Often, these protocols require the presence of trusted third parties to satisfy the security and privacy requirements of anonymous fingerprinting (Deng and Preneel, 2008). Thus, these solutions are much less scalable for the merchant and involve higher CPU costs and bandwidth requirements. From the merchant's view point, the efficiency of the content distribution system is evaluated in terms of scalability and computational and communication costs. Hence, P2P distribution would be a more convenient approach for the merchant to reduce the delivery costs. However, as mentioned above, today's P2P content distribution systems are severely abused by illegal re-distributions and the multimedia producers encounter uncertainties regarding the adoption or rejection of P2P networks to spread content over the Internet. Many systems can be found in the literature that include content protection mechanisms to solve the copyright infringement problem in P2P systems. However, a collection of identifiable personal data within P2P systems using copyright protection mechanisms raises a privacy concern among the end users. The literature review shows that very few researchers have worked on P2P content distribution systems that provide preservation of both content providers ownership properties and content receivers privacy. The next section reviews the related work on P2P content distribution systems in which either one or both copyright and privacy protection properties are satisfied.

1.1. Previous works on P2P content distribution systems

The P2P content distribution systems described in the following paragraphs are designed with an intention to satisfy both copyright protection and user privacy.

Sun et al. (2009) proposed an identity-based DRM system with privacy enhancement. Their DRM system retains user privacy by hiding the relationship information between users and the digital contents the users own. In order to provide strong privacy and anonymous consumption, restrictive partial blind signatures are adopted in the system. Moreover, a content key management protocol is proposed in the system to protect the users against malicious servers, and prevent them from obtaining a complete content key. However, the proposed system, in spite of employing an anonymous authentication technique to provide anonymity, does not offer traceability due to use of untraceable blind signatures.

Win et al. (2011) proposed a privacy-preserving content distribution mechanism without requiring trust over any third party, by using the mechanisms of blind decryption and one-way hash chains. In the system, a privacy-preserving revocation mechanism preserves users' anonymity even if the user has been blocked for his/her misbehavior. The scheme provides privacy protection to the users by generating an anonymous token set. The proposed user only interacts with other entities in the system using these anonymous tokens. However, the proposed system does not

provide any secure key management mechanism and does not support accountability parameters, i.e. it fails to discover the traitor responsible for constraints violation in the DRM system.

Domingo-Ferrer and Megías (2013) proposed a P2P protocol for distributed multicast of fingerprinted content in which cryptographic primitives and a robust watermarking technique are used to produce different marked copies of the content for the requesting buyers. Domingo-Ferrer and Megías used the reward and punishment concepts of game theory to ensure that peers rationally cooperate in P2P fashion for fingerprint embedding and content distribution. However, the system requires the implementation of a secure multi-party computation protocol between buyers for embedding the fingerprint in each transaction, resulting in increased computational and communication costs at the buyer's end. A similar idea is presented in (Domingo-Ferrer, 2011), where the embedded information contains an expiration date used to enforce digital oblivion.

Qureshi et al. (2014, 2015) proposed a P2P content distribution framework for preserving privacy and security of the user and the merchant based on homomorphic encryption. In this framework, a few discrete wavelet transform low-frequency (approximation) coefficients are selected according to a secret key for embedding an encrypted fingerprint, exploiting the properties of a homomorphic cryptosystem. Although the selective public-key encryption of the multimedia content, which affects only a few coefficients, results in lesser data expansion, it imposes a computational burden on a merchant and an increased complexity for file reconstruction at the buyer's end. More recently, Qureshi et al. (2016) took advantage of some of these ideas, but replaced homomorphic encryption by fragmentation, symmetric encryption, permutation and distribution of the fragments through a collection of proxy peers. Furthermore, the embedding step is pre-computed using a string of all '1's and one of all '0's and, hence, no actual embedding is required for each transaction. The proxy peers are responsible of selecting the appropriate coefficient ('0' version or '1' version) according to the specific fingerprint's bit. Permutation and symmetric encryption protect the cleartext of both the content and the fingerprint, yielding buyer frameproofness.

In (Megías and Domingo-Ferrer, 2013, 2014), the novel concept of fingerprinting through a recombination mechanism is proposed for a P2P-based distribution scenario. The remarkable advantage of this system is that the fingerprint embedding is required only for a few seed buyers, whereas the fingerprint of a non-seed buyer is automatically obtained as a recombination of the segments of the fingerprints of his/her source buyers. However, the traitor-tracing process requires an expensive graph search and the cooperation of some innocent buyers for tracing a copyright violator. Moreover, honest and committed proxies are required in the distribution protocol for the generation of valid fingerprints, which are encoded in two layers: the segment layer (segment-level) and the hash layer (hash-level). The segment-level encoding requires that each segment of the fingerprint is a codeword of a collusion-resistant code. In a second layer, a hash is constructed across the segments that must also be a codeword of some collusion-resistant code. The construction of a valid hash-level codeword requires the cooperation of the proxy peers.

Megías (2015) proposed an improved version of the automatic recombined fingerprinting mechanism in which malicious proxies are considered in the distribution protocol. A four-party anonymous communication protocol is proposed to prevent malicious proxies from accessing the cleartext of the fingerprinted content. The proposed scheme

provides a convenient solution for the legal distribution of multimedia contents with copyright protection while preserving the privacy of buyers, whose identities are only revealed in case of illegal re-distribution. In addition, the scheme uses standard database search for traitor tracing unlike the system in (Megías and Domingo-Ferrer, 2013, 2014), which requires an expensive graph search to identify an illegal re-distributor. However, the scheme proposed by Megías (2015) still requires a two-layer anti-collusion encoding of the fingerprint, which results in a longer fingerprint and requires a complex protocol to construct valid fingerprints during P2P distribution.

Unlike the P2P content distribution systems described in the above paragraphs, the P2P distribution systems described in the following paragraph either provide copyright protection or user privacy.

A fingerprint generation and embedding method was proposed by Li et al. (2010) for complex P2P file sharing networks for copyright protection. In this system, wavelet transforms and principal component analysis (PCA) techniques are used for the fingerprint generation. The wavelet technique provides a scalable approximation matrix that contains the most important low-frequency information and the PCA technique determines the orthogonal eigenvectors, which makes it possible to maximally distinguish the different fingerprints. The proposed scheme is scalable since it is able to generate a large number of unique fingerprints. The proposed framework provides a novel solution of legal content distribution, but it does not include collusion resistance or user privacy.

Hu and Li (2010) proposed an asymmetric fingerprinting protocol based on a 1-out-of-2 oblivious transfer protocol from the communication point of view. In the proposed scheme, multicast is exploited to reduce the bandwidth usage. The protocol uses an approach similar to the chameleon encryption, and applying 1-out-of-2 oblivious transfer, a decryption key is transmitted so that the sender does not know it. However, in the proposed fingerprinting protocol, the sender can guess the key used by the recipient with a non-negligible probability $1/n$, and the sender can even cheat in the oblivious transfer by offering the same key n times, so that he/she will know the key used by the recipient. Furthermore, the proposed scheme fails to provide collusion resistance and end user's privacy.

In (Ye et al., 2016), a secure multimedia distribution framework is proposed, which combines multimedia encryption, copy detection, and digital fingerprinting to prevent widespread piracy. To deter legitimate users from illegally re-distributing the decrypted content, the scheme employs the ideas of joint copy detection and fingerprinting. Copy detection uses the content itself, rather than other information, to verify whether a protected multimedia content is a re-distributed copy or not. Fingerprinting of multimedia content using digital watermarks is an effective means of determining original owners of pirated copies by tracing down the distributor via the fingerprinting signals. Though the proposed system provides copyright protection, it fails to provide user privacy.

OneSwarm, proposed by Isdal et al. (2010), is a privacy-preserving P2P system for file sharing in which the peers can query for content and download it from other users. OneSwarm provides privacy using a much different method than onion routing. The architecture of OneSwarm is based on a dense topology of peers to ensure the availability of the content, probabilistic forwarding of queries to neighbors to thwart traffic analysis, and application-level delays to thwart timing attacks. This system protects user privacy, but does not provide copyright protection.

Tsujio and Okabe (2015) proposed a P2P article distribution system considering both users privacy and criminal

investigation. In the system, if many users prioritize privacy, their anonymity is protected, but if many users prioritize criminal investigation, they can trace the publisher of an article. The proposed system constructs a P2P network and spreads published articles by relaying between peers. When a peer relays an article, it records a relaying log in its local storage so that a user can trace the distribution path later on. If all users along the path from the publisher agree to cooperate in gathering their logs, they will be able to trace to the publisher. The system is not operated by a specific administrator and, hence, Pretty Good Privacy (PGP) Web of Trust (WoT) is adopted for publishing certificates. Though the proposed system protects the privacy of users from surveillance, it does not include any content protection mechanism that could protect the authors' copyrights.

Chae et al. (2016) proposed a system to prevent privacy data leakage through P2P file distribution systems. The proposed system identifies the sensitive or private data, and removes the information by the privacy data leaking risk factor from the sharing file. This process solved the issues of data loss prevention systems, such as the high detecting-error of the privacy data and invasion of privacy issues, but does not include any copyright protection mechanism.

Table 1 compares the P2P distribution systems in terms of adopted content protection techniques, content protection properties (copyright protection, traceability), privacy protection properties (revocable, user, data), and security against attacks (collusion/malicious, communication). In this table, a cell is marked with "No" when no content protection technologies, or security and privacy properties, are used or guaranteed by the P2P content distribution system, respectively.

The following observations can be made with respect to the security properties:

- Domingo-Ferrer and Megías (2013); Qureshi et al. (2015, 2016); Megías and Domingo-Ferrer (2014); Megías (2015); Li et al. (2010); Hu and Li (2010); Ye et al. (2016), guarantee copyright protection by using fingerprinting techniques. The systems proposed by Sun et al. (2009) and Win et al. (2011) guarantee copyright protection by using DRM techniques. The remaining P2P content distribution systems do not offer copyright protection.
- The systems proposed by Domingo-Ferrer and Megías (2013); Qureshi et al. (2015, 2016); Megías and Domingo-Ferrer (2014); Megías (2015); Li et al. (2010); Hu and Li (2010); Ye et al. (2016) guarantee traceability of copyright violators by using digital fingerprinting techniques. The systems proposed by Sun et al. (2009); Win et al. (2011) offer copyright protection based on DRM techniques but fail to provide traceability. Similarly, the system proposed by Tsujio and Okabe (2015) provides traceability of a publisher by using a cooperation technique.

Table 1: Comparison of P2P systems based on used security techniques and security and privacy properties

P2P Systems	Focus on:	Content Protection Mechanism		Security Properties		Privacy Properties			Security against Attacks		
		DRM	Finger-printing	Copyright Protection	Traceability	Revocable Privacy	User Privacy	Data Privacy	Collusion Attacks		Comm. Attacks
									Content Protection System	Privacy Protection System	
Sun et al. (2009)	Copyright and Privacy Protection	Yes	No	Yes	No	No	Yes	Yes	Yes	No	No
Win et al. (2011)		Yes	No	Yes	No	Yes	Yes	Yes	No	Yes	No
Domingo-Ferrer & Megías (2013)		No	Yes	Yes	Yes	Yes	Yes	Yes	Yes	Yes	No
Qureshi et al. (2015)		No	Yes	Yes	Yes	Yes	Yes	Yes	Yes	Yes	Yes
Qureshi et al. (2016)		No	Yes	Yes	Yes	Yes	Yes	Yes	Yes	Yes	Yes
Megías & Domingo-Ferrer (2014)		No	Yes	Yes	Yes	Yes	Yes	Yes	Yes	Yes	Yes
Megías (2015)		No	Yes	Yes	Yes	Yes	Yes	Yes	Yes	Yes	Yes
Li et al. (2010)		Copyright Protection	No	Yes	Yes	Yes	No	No	Yes	No	No
Hu & Li (2010)	No		Yes	Yes	Yes	No	No	Yes	No	No	No
Ye et al. (2016)	No		Yes	Yes	Yes	No	No	Yes	No	No	No
Isdal et al. (2010)	Privacy Protection	No	No	No	No	No	Yes	Yes	No	Yes	Yes
Tsujio & Okabe (2015)		No	No	No	Yes	No	Yes	Yes	No	No	Yes
Chae et al. (2016)		No	No	No	No	No	Yes	Yes	No	No	No

Similarly, the following observations can be made from Table 1 in terms of privacy properties:

- Win et al. (2011); Domingo-Ferrer and Megías (2013); Qureshi et al. (2015, 2016); Megías and Domingo-Ferrer (2014); Megías (2015) guarantee revocable privacy. In these systems, the real identity of the users is only revealed by the trusted third party, i.e. the registration authority, in case a user is found guilty of copyright violation. The remaining systems either provide full anonymity or no anonymity at all to the users.
- Sun et al. (2009); Win et al. (2011); Domingo-Ferrer and Megías (2013); Qureshi et al. (2015, 2016); Megías and Domingo-Ferrer (2014); Megías (2015); Isdal et al. (2010); Tsujio and Okabe (2015); Chae et al. (2016) guarantee mutual anonymity to the users of the P2P system due to pseudonymity and anonymous authentication and communication techniques.
- All the compared systems guarantee data protection from unauthorized access and manipulation due to the use of symmetric/asymmetric/hybrid encryption techniques.

The following observations can be made with respect to security against collusion and communication attacks:

- In the systems proposed by Domingo-Ferrer and Megías (2013); Qureshi et al. (2015, 2016); Megías and Domingo-Ferrer (2014); Megías (2015), the security against collusion attacks is guaranteed due to use of collusion-resistant fingerprinting. The system proposed by Sun et al. (2009) offers security against collusion attacks by using a content-key management protocol. Similarly, in the P2P distribution systems proposed by Win et al. (2011); Domingo-Ferrer and Megías (2013); Qureshi et al. (2015, 2016); Megías and Domingo-Ferrer (2014); Megías (2015); Isdal et al. (2010), the privacy of the users is preserved against malicious/collusion attacks that attempt to deanonymize the users.
- The communication channel used for transferring the data between two users of the systems of Qureshi et al. (2015, 2016); Megías and Domingo-Ferrer (2014); Megías (2015); Isdal et al. (2010); Tsujio and Okabe (2015) are protected against malicious attacks such as man-in-the-middle attacks, denial of service and replay attacks. In the other systems, the protection against communication attacks is either not provided or not discussed.

It is apparent, from Table 1, that most of the presented P2P distribution systems focus on either providing copyright protection to content owners or privacy to end users. Only a few P2P content distribution systems (Domingo-Ferrer and Megías, 2013; Megías and Domingo-Ferrer, 2014; Megías, 2015; Qureshi et al., 2015, 2016) exist that focus on **both** copyright protection (with collusion resistance) and user privacy and anonymity. For this reason, these are the systems selected for a detailed comparison with the proposed scheme in Section 4.2.

1.2. Contribution and plan of the paper

The main contribution of this paper is to introduce a new fingerprinting protocol based on recombination approach that provides a secure, anonymous and efficient collusion-resistant-based asymmetric fingerprinting scheme within a

P2P content distribution system. Following are the properties of our contribution:

1. In order to provide collusion resistance against c colluders, state-of-the-art collusion-resistant fingerprinting codes (Nuida et al. (2007) codes) are employed, which provide small length fingerprint codewords. **To the best of our knowledge, these codes are used segment-wise for the first time in our proposal.** The segment-wise construction of the fingerprint using Nuida et al.'s codewords prevents the two-layer encoding required by the previous recombination-based proposals (Megías and Domingo-Ferrer, 2014; Megías, 2015) and simplifies the distribution protocol to a great extent. Unlike (Megías and Domingo-Ferrer, 2014; Megías, 2015), the proposed scheme does not require the cooperation of the proxy peers to construct a valid hash-level code to be used for colluder(s) tracing. Hence, the fingerprint generated by recombination is always valid and does not require further verification, which is a clear advantage compared to the schemes proposed in (Megías and Domingo-Ferrer, 2013, 2014; Megías, 2015).
2. The proposed scheme provides traceability for the identification of the colluder(s). **The standard Nuida et al.'s traitor-tracing algorithm has been redesigned to perform traitor tracing in the encrypted domain** such that buyer frameproofness is retained. We believe that this is the first time that the traitor-tracing algorithm is performed in an encrypted domain. The scores of the colluder(s) calculated using the proposed tracing protocol match those that would be calculated in the cleartext domain.
3. The use of Nuida et al.'s codewords to construct fingerprints in a segment-wise form is analysed and a threshold to identify the colluders (with no false positives or negatives) in the traitor-tracing protocol is derived. Simulations with the proposed traitor-tracing system (with collusion) are provided to show the resistance of the fingerprinting scheme against various collusion attacks.
4. To perform efficiently in P2P network, differing from the existing fingerprinting schemes (Qureshi et al., 2014, 2015), heavy-burden operations, such as public-key cryptography, are applied only for data signing and for the encryption of short bit strings, such as the binary fingerprints. In the distribution protocol, symmetric cryptography is used to encrypt the fragments of the content in order to provide data security.
5. Formal and informal proofs are made available to show that the system exhibits security and revocable privacy to the content owners and the buyers, respectively.

The rest of this paper is organized as follows. Section 2 reviews the main features of the proposals suggested in (Megías and Domingo-Ferrer, 2013, 2014) and (Megías, 2015), and also highlights the main drawbacks of these systems. Section 3 details the protocols and algorithms of the proposed system in order to overcome the drawbacks of the mentioned schemes. Section 4 discusses the features of the new system and compares it with existing anonymous fingerprinting proposals for P2P distribution networks. Section 5 analyses the security and privacy of the proposed system. This section also presents simulated and theoretical results designed to evaluate the collusion resistance of the new fingerprinting scheme. Finally, Section 6 summarizes the conclusions and future research issues.

2. Related work

The fingerprinting system presented in this paper stems from the work proposed in (Megías and Domingo-Ferrer, 2013, 2014) and (Megías, 2015), which introduced the concept of automatically recombined fingerprints for P2P networks. In the following sections, we present the main features and drawbacks of these systems.

2.1. Features of the system proposed by Megías and Domingo-Ferrer (2013, 2014)

The main features of the fingerprinting scheme proposed in (Megías and Domingo-Ferrer, 2013, 2014) are the following:

- The system consists of a merchant, seed buyers, non-seed buyers, a group of P2P proxies, a transaction monitor and a tracing authority. The proxy (or a set of proxies) and the tracing authority are considered as trusted parties, whereas the remaining entities are not trusted.
- The content is divided into several ordered fragments and each of them is embedded separately with a binary sequence.
- The binary sequence embedded in each fragment is called a “segment” and the concatenation of all the segments forms the binary fingerprint.
- The merchant creates a set of M seed copies and distributes them to the M seed buyers. The fingerprints are generated by the merchant in such a way that they have low pair-wise correlation.
- A non-seed buyer obtains the fragments of the content from at least two other buyers and his/her fingerprint is built as a recombination of the segments of his/her parents as shown in Figure 1.
- The embedding process is required only for M seed buyers. For the non-seed buyers of the system, different fingerprints are created without any further execution of the embedding scheme.
- To ensure anonymous communication between buyers, an onion routing-like protocol using a P2P proxy (or a chain of proxies) is used within the system.
- The proxies do not know the real identities, only pseudonyms, of the source and destination buyers. In the anonymous data transfer protocol, the proxies are responsible for forwarding a one-time symmetric session key from the child buyer to the parent buyer in order to encrypt the fragments of the content for data security.
- The proxies register each transaction at the transaction monitor and also inform it about the number of fragments transferred to the buyer. For each fragment, the proxies receive a single-bit hash of the corresponding segment. Each proxy forms a bit string with the hash bits of all the transferred segments and encrypts this string using the public key of the transaction monitor. When the child buyer receives all the fragments of the complete content, the proxies share their encrypted strings, concatenate them, and encrypt them again, one time per each parent

buyer, using the public-key of the parent buyer, creating the encrypted version of the hash. Thus, no proxy has access to the complete cleartext of the fingerprint's hash. The transaction monitor contacts all the corresponding proxies to request the encrypted hash and stores it in its transaction database (one time per parent buyer).

- The transaction monitor keeps a record of each transaction in order to keep track of data transfer between the buyers. These records contain the identifier of the purchased content (e.g. a perceptual hash), the pseudonyms of the involved buyers (source and destination) and the encrypted hash of the fingerprint. The hash of the fingerprint is encrypted using the public key of the transaction monitor and the public key of each parent buyer. In the execution of the traitor-tracing protocol, the private key of at least one parent buyer is required by the transaction monitor to decrypt the encrypted hash.
- The merchant has access to the buyers' database, thus only he/she knows the true identities of the seed and non-seed buyers of the system.
- In case an illegally re-distributed copy is found, the re-distributor is identified through a graph search directed by a binary correlation function between the fingerprint extracted from the re-distributed copy and the fingerprints of the tested buyers. Cooperation is required from some honest buyers during the search process. The fingerprints' hashes stored in the transaction monitor are enough to prevent those buyers from cheating in this step.

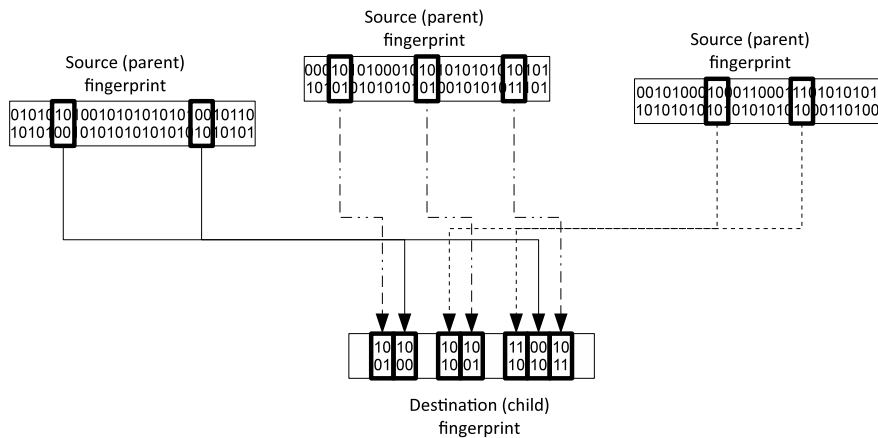

Figure 1: Automatic recombined fingerprint construction

- In each step of the traitor-tracing protocol, the buyer with the maximum correlation is chosen as the most likely ancestor of the illegal re-distributor. Occasionally, a higher correlation may be obtained for a non-ancestor of the buyer of the illegally re-distributed copy, which would require the exhaustion of a sub-graph and backtracking.
- The search ends when perfect correlation is found between the traced fingerprint and the fingerprint of the tested buyer. In case a buyer refuses to cooperate with the tracing authority in the tracing-tracing protocol, the

fingerprint hash recorded by the transaction monitor can be used as an evidence against him/her.

- Anti-collusion codes are used in the protocol to provide collusion resistance against attackers. Each segment is encoded with an anti-collusion code, which can be used to reconstruct the segment of at least one of the colluders.
- The fingerprints are constructed in such a way that their hashes are also codewords of some collusion-resistant code. Thus, in the traitor-tracing protocol, once the segments are reconstructed by the tracing authority, the hash of at least one of the colluders can be obtained. However, during the distribution protocol, the fragments must be distributed by the proxies following some (non-specified) protocol, with the participation of the transaction monitor, to construct a valid anti-collusion codeword for each hash.
- To obtain a segment with the required hash bit, the proxies contact the potential parents subsequently, since only the parents having that particular hash bit would be accepted as the source for the specific fragment of the content. In this way, a valid codeword is formed for the hash.
- In case of collusion, in order to identify an illegal re-distributor in the traitor-tracing protocol, the correlation function is applied with the hash of the traced fingerprint and that of a tested buyer as inputs, instead of using the fingerprints.

In comparison to previous fingerprinting schemes (Pfitzmann and Schunter, 1996; Camenisch, 2000; Kuribayashi and Tanaka, 2005; Rial et al., 2010), which require highly demanding technologies such as public-key encryption of the contents, secure multi-party protocols or zero knowledge proofs, the system proposed in (Megías and Domingo-Ferrer, 2013, 2014) offers remarkable advantages to both buyers and the merchant in terms of computational and communication costs: 1) the embedding is required only for a few seed buyers (M) and the fingerprint of the other buyers are automatically generated as a recombination of segments; 2) the fingerprints of non-seed buyers are unknown to the merchant (achieving buyer frameproofness); 3) transactions between buyers are fully anonymous; 4) public-key cryptography is restricted to the transmission of short-bit strings; and 5) an illegal re-distributor can be identified through the traitor-tracing protocol.

2.2. Drawbacks of the system proposed by Megías and Domingo-Ferrer (2013, 2014)

Despite the advantages of this scheme, detailed in Section 2.1, it exhibits the following shortcomings:

1. The traitor-tracing process requires an expensive graph search in order to identify an illegal re-distributor.
2. Some innocent buyers are requested to cooperate with the tracing authority in the traitor-tracing protocol. This participation can result in the following problems:

- The number of tested buyers in the traitor-tracing process is not known a priori. Thus, in a worst-case situation, the whole set of the buyers would have to be checked in order to find the illegal re-distributor, resulting in increased computational and communication costs.

As remarked above, the graph search carried out for traitor tracing may require backtracking, as shown in a graphical example in Figure 2, where buyer B_{48} is the illegal re-distributor of the content. The graph search jumps from buyer B_4 to buyer B_{51} skipping the illegal re-distributor (B_{48}). Once the sub-graph beyond B_{51} is exhausted, the traitor-tracing system backtracks and goes back to buyer B_{17} , as shown by a dotted arrow, before finally reaching the illegal re-distributor after two more hops.

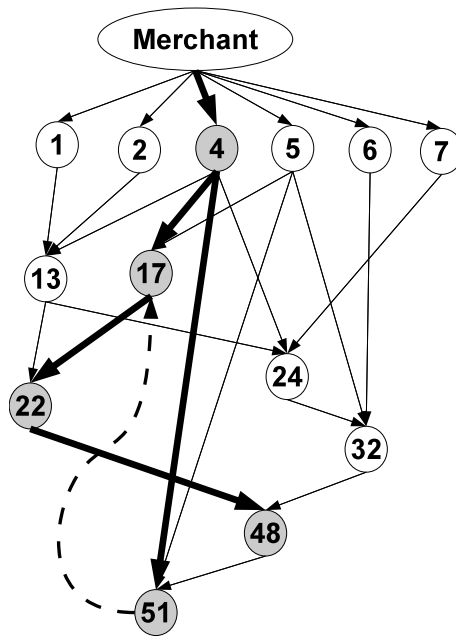

Figure 2: Traitor-tracing graph search protocol

- In some distribution scenarios, if a buyer is unable to participate in the traitor-tracing protocol either due to a genuine problem or a malicious reason, it may result in non-traceability of an illegal re-distributor.
 - The privacy of an honest buyer is surrendered to some extent, since the tracing authority can associate the purchased content with the buyer's sensitive information such as his/her IP address.
 - The fingerprint of the buyer does not remain secret, since the tracing authority needs to compute the correlation between the buyer's and the traced fingerprint. Thus, in case a malicious buyer re-distributes the content illegally, he/she can argue that his/her fingerprint could have been leaked during the traitor-tracing process of a former illegal re-distribution.
3. The distribution protocol relies on honest proxies for data transfer between the buyers of the system. This trust on the proxies is detrimental to the privacy interests of the buyers, since the proxies could act maliciously

and use the session keys transmitted from the parent buyer to the child buyer so as to decrypt the transferred encrypted content. Consequently, a collusion of all malicious proxies is enough to obtain the fingerprinted content and frame an honest buyer for illegal re-distribution.

4. The anti-collusion mechanism used in this system has several drawbacks that are shared with its improved version Megías (2015), as detailed in Section 2.4.

2.3. Features of the system proposed by Megías (2015)

The use of automatic recombined fingerprints proposed in (Megías and Domingo-Ferrer, 2013, 2014) allows the multimedia producers and merchants to save bandwidth and CPU time thanks to the P2P distribution of the content and the automatic generation of fingerprints through recombination. In addition, the system provides buyers with privacy preservation and buyer frameproofness. The traceability of a source responsible for an illegal re-distribution of the content is also possible. However, the aforementioned system has some shortcomings that can make it inefficient and impractical under certain circumstances, as detailed in Section 2.2.

To overcome the major drawbacks of (Megías and Domingo-Ferrer, 2013, 2014), Megías (2015) proposed a more efficient and practical content distribution system using recombined fingerprints as its main building block. This modified system inherits some features from the scheme described in (Megías and Domingo-Ferrer, 2013, 2014). Thus, only the novel and improved features of the referred method are highlighted below:

- Proxies are not trusted and the security against malicious proxies is obtained through a four-party anonymous communication protocol that prevents proxies from accessing the cleartext of the fragments of the content.
- In addition to the pseudonyms of the involved buyers, the perceptual content hash, the encrypted hash of the fingerprint, and the transaction date and time, the transaction monitor also stores the fingerprints of the buyers in encrypted form.
- The hash of the fingerprint is encrypted only with the public key of the transaction monitor (K_c).
- Each fragment of the content is transmitted, with a fingerprint's segment g_j embedded into it, together with an encrypted version of the segment $E(g_j, K_c)$.
- Each proxy selects a set of m contiguous fragments of the content that carry m contiguous segments of the fingerprint embedded into them. The proxies also store the corresponding encrypted segments, $E(g_j, K_c)$. The construction of the fingerprint with segments and sets of contiguous fragments is illustrated in Figure 3. The number of segments n_s does not need to be a multiple of m , since a larger set in can be arranged for the last set of segments of the fingerprint, as shown in the figure. For example, if $m = 10$ and the total number of segments is $n_s = 74$, the last set of segments (s_L) would be formed by 14 segments instead of 10. In any case, we have $0 \leq n_s - Lm < m$.

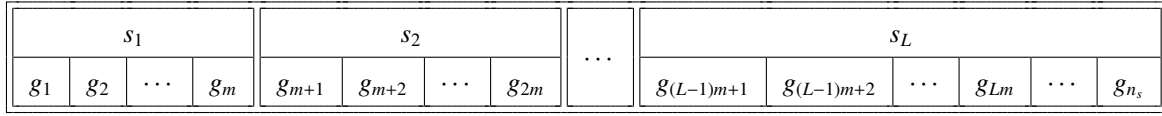

Figure 3: Fingerprint's segments (g_j) and sets (s_k) of m contiguous segments

- The proxy encrypts the concatenation of m contiguous encrypted segments using the public key of the tracing authority (K_a) and sends it to the transaction monitor. The possibility of a proxy accessing the complete sequence of the encrypted segments is unrealisable due to the fact that each buyer is required to choose at least two proxies.
- The transaction monitor serves as a temporary database for storing the session keys shared between the parent and child buyers in the anonymous data transfer protocol. A pseudorandom number r is generated by a parent buyer and is used as a handle for the shared key K , which is sent by the parent to the transaction monitor. During data transfer, the parent buyer sends r to the child buyer through the proxy. On receiving r , the child buyer sends it to the transaction monitor, who replies with the corresponding session key K . The corresponding register is blocked and, after a certain time, it is finally removed by the transaction monitor.
- A malicious proxy who tried to access the database to retrieve K in order to obtain the cleartext of the fragments of the transferred content would be detectable, since the register containing K would be either blocked or removed by the transaction monitor (either for the proxy or for the child buyer).
- In case an illegally re-distributed copy is found, the tracing authority extracts the fingerprint from it and uses the public key of the transaction monitor and its own public key to produce the encrypted fingerprint. This encrypted fingerprint is searched in the database of the transaction monitor to disclose the pseudonym of the illegal re-distributor.
- In case of collusion, the hash of at least a colluder can be reconstructed from the colluded fingerprint. This hash is encrypted by the transaction monitor and searched in the transaction database to retrieve the pseudonym of the colluder.
- Finally, the merchant reveals the real identity of the copyright violator by searching the pseudonym provided by the transaction monitor in his/her database of buyers.

2.4. Drawbacks of the system proposed by Megías (2015)

Megías (2015) provided several significant improvements in the fingerprinting scheme of (Megías and Domingo-Ferrer, 2013, 2014) to overcome the major drawbacks of the recombination-based fingerprinting approach, such as a simpler traitor-tracing algorithm, which does not require cooperation of honest buyers for tracing a copyright violator, and a four-party anonymous communication protocol that prevents malicious proxies from framing an innocent buyer

for illegal re-distribution. Though the system satisfies all the necessary security and privacy requirements of an anonymous fingerprinting scheme, it still exhibits the following drawbacks:

1. The fingerprinting scheme requires a two-layer anti-collusion code (segment level and fingerprint level), which results in a longer codeword.
2. As in the original scheme (Megías and Domingo-Ferrer, 2013, 2014), the system in (Megías, 2015) requires the hash of the fingerprint to trace an illegal re-distributor in case of collusion of several buyers. To achieve this goal, the hash of the fingerprint must be a valid codeword of some anti-collusion code. Thus, the monitor requires the cooperation of the proxies to construct a valid hash-level codeword. This demands a communication channel between the P2P proxies who are carrying the content from at least two parent (source) buyers to the child (destination) buyer. These proxy peers must communicate with each other in the presence of the transaction monitor, who must verify that the constructed fingerprint hash is valid, by indicating the correct hash bits for specific segments. Hence, a complex (non-specified) protocol involving all proxies (of the same file transfer) and the transaction monitor is needed to generate a valid fingerprint. This protocol must be secure enough to guarantee that the proxies cannot collude to disclose the whole hash-level codeword, which may compromise an innocent buyer.

Megías (2015) did not address these problems, both of them related to the two-layer anti-collusion coding of the fingerprint. As shown below, this drawback can be overcome by introducing state-of-the-art collusion-resistant codes only at segment level (the requirement of a hash-level codeword can be removed) combined with a less complex traitor-tracing protocol. Thus, the system proposed in this paper is designed to remove these drawbacks and improve the collusion resistance mechanism of recombined fingerprinting.

3. Proposed system

This section describes the novel system, which is designed to retain the basic idea of automatically recombined fingerprints proposed in (Megías and Domingo-Ferrer, 2013, 2014; Megías, 2015) and solves the major problems of the system of (Megías, 2015), which are discussed in Section 2.4.

3.1. System entities

The proposed system involves six entities and the function of each entity is defined as follows:

- **Merchant:** A merchant (Me) is an entity that has access to the database of the buyers. Thus, he/she is the only party who knows the true identities of the buyers of the system. It also receives the payments associated to the purchases of the buyers.
- **Seed buyers:** The seed buyers (B_i for $i = 1, \dots, M$) are dummy buyers of the system. These buyers receive the fingerprinted copies of the content from the transaction monitor that are used by the system to bootstrap the

P2P distribution protocol. The seed buyers are contacted by the buyers of other generations to obtain further copies of the content.

- **Other buyers:** The other buyers (B_i for $i = M+1, \dots, N$, with $M \ll N$) obtain their fingerprinted copies through the P2P distribution system such that the binary fingerprint of their copy is a binary sequence automatically formed as the recombination of the segments of the embedded fingerprints of their parents (source buyers). Once a buyer obtains the content, he/she can become the source of the content for other buyers.
- **Proxies:** A proxy is an entity that is used to create an anonymous connection between the buyers such that each source and destination buyer does not lose his/her anonymity. They provide anonymous communication between buyers through a specific protocol similar to an onion routing mechanism, based on Chaum's mix networks (Chaum, 1981). The proxies are also responsible for selecting at least two buyers (parents) as the sources of the content fragments for a destination buyer in the anonymous P2P distribution protocol.
- **Transaction monitor:** The transaction monitor (MO) is an entity that generates collusion-resistant fingerprint codes for the M seed buyers and embeds these codes into the fragments of the multimedia content in order to produce M fingerprinted seed copies. MO is also responsible for maintaining a transaction database that keeps record of the permuted and encrypted fingerprints embedded in the purchased contents along with the pseudonyms of the buyers involved in the transactions.
- **Tracing authority:** In our system, the tracing of illegal re-distributors is carried out by a tracing authority (T_A) in cooperation with MO . This is due to the fact that the presence of a single party responsible for both fingerprint generation and tracing of an illegal re-distributor could result in a security compromise of a buyer, if the foregoing entity unexpectedly behaves in a malicious manner. Since the database of the buyers' fingerprints is maintained by MO , it could falsely accuse or frame an honest buyer either for an illegal re-distribution of the content (piracy) or forming a coalition with other malicious party (collusion). In the proposed system, T_A is responsible for tracing illegal re-distributors by executing a relevant part of the traitor-tracing protocol in case of piracy claim. As detailed below, this traitor tracing is carried out by T_A in conjunction with MO .

3.2. Design requirements and assumptions

In this section, the design requirements and security assumptions of the system are described.

3.2.1. Design requirements

In the following, the design requirements related to the construction of the proposed system are defined:

- The fingerprinting scheme should be collusion resistant against a given maximum number of colluders ($c \leq c_0$) as specified by Nuida et al. (2007) codes.

- At the time of registration, each buyer can authenticate himself/herself to Me and obtain a pseudonym for use within the system. Once a pseudonym is obtained, each buyer should sign a document (AGR) using his/her private key, that certifies the association between the pseudonym and his/her real identity.
- The real identity of B_i should remain anonymous during transactions unless he/she is proven guilty of copyright violation.
- The possible collusion of malicious proxies should be unable to frame an honest buyer. Similarly, any malicious party should not be able to construct the fingerprinted copy corresponding to any buyer to frame an honest user of the system.
- The identity of B_i should not be linked to his/her activities such as purchasing, transferring of content and so on.
- MO and the proxies should not have access to either the real identities of the buyers or the cleartext of the fingerprints.
- Each buyer must choose at least two proxies (or chains of proxies) in the P2P distribution protocol.
- The communication between the peer buyers within the P2P distribution system must be anonymous in order to preserve the buyers' privacy.
- The data transferred through proxies should be encrypted in such a way that only the sender and the receiver have access to their cleartext.
- In case Me finds a pirated copy, T_A should be able to trace and identify an illegal re-distributor with the help of MO .
- In the traitor-tracing protocol, T_A , with the help of MO , should be able to identify the illegal re-distributor without requiring the cleartext of the fingerprint of honest buyers, i.e. the traitor-tracing algorithm of Nuida et al. (2007) codes should be executed in the encrypted domain.

3.2.2. Security assumptions

The security assumptions of the proposed system are the following:

- Me is not trusted either for content distribution or for the association of pseudonyms with the corresponding real identities of the buyers. Hence, proofs (AGR) shall be provided by the merchant to authenticate the provided information.
- The M seed buyers are fake buyers or dummies that serve as special-purpose servers for the other generation ($M+1, \dots, N$) buyers. The seed buyers will not participate in any collusion and thus, their fingerprints are never

used in the traitor-tracing protocol. MO is not required to keep a record of the fingerprints corresponding to the M seed buyers.

- The $N - M$ non-seed buyers B_i (for $i = M + 1, \dots, N$) are not trusted entities of the system and the protocols are designed to guarantee that they are transferring authenticated fragments of the content when they become sources of the content for other buyers. MO is trusted for managing the session key database and the transaction database used in the anonymous P2P content distribution protocol. The details are provided in the description of Protocols 1 and 2.
- MO reveals the true pseudonym corresponding to one or more illegal re-distributors or colluders in the traitor-tracing protocol.
- Each binary fingerprint f_i of a seed buyer, generated by MO , is composed of multiple ordered segments g_j , where each segment is generated by using Nuida et al. (2007) c -secure fingerprinting codes. The length of the fingerprint l is a known constant of the system.
- T_A is a trusted entity. Hence, it is expected that T_A does not form a coalition with any other party to frame an innocent buyer or break anyone's privacy.
- The length of a permutation key σ , generated by T_A , is equal to the size of the fingerprint, i.e. l . The purpose of σ is to prevent MO from disclosing the fingerprint of any innocent buyer through the inspection of the encrypted fingerprints stored in his/her database. σ is kept secret from Me , MO and the proxies for the security of the stored fingerprints.
- The fragments of the content transferred through the proxies in the anonymous distribution protocol are encrypted using symmetric cryptography.
- The watermarking method used for embedding the fingerprint f_i in the seed copies is imperceptible, secure and robust against common signal processing attacks.
- Each entity (Me , MO , B_i , T_A , proxies) is supposed to have a public key K_p and a private key K_s .
- The public keys must be authenticated so that a party who uses these keys knows that these belong to the legitimate parties. To achieve this, the existence of a PKI is assumed.

3.3. Attack model

This section describes the main attacks that may be performed on the protocols of the proposed system. These attacks can be aimed to break either the security or the privacy properties of the system. In order to design a secure and privacy-preserving distribution system, the following three properties shall be guaranteed:

- **Copyright protection:** This property requires that a non-seed buyer accused of illegally re-distributing a content should not be able to repudiate his/her guilt of copyright violation.
- **Buyer frameproofness:** It requires that any malicious party of the system or a possible collusion of such parties should not be able to accuse an innocent buyer of illegal re-distribution.
- **Buyer's privacy:** The identity of a buyer should remain anonymous during transactions and it should not be linked to his/her online activities.

In the following, we describe an attack model for the proposed system related to the buyer's privacy and security attacks from malicious entities and the resistance of a fingerprint against collusion attacks.

3.3.1. Framing attacks

The following type of attacks are aimed to accuse (frame) an innocent buyer of illegal re-distribution of the purchased content.

1. **Proxy authentication attacks:** An attacker may impersonate a proxy in the system and try to obtain fragments of a content from different buyers in order to create a fake colluded copy of the content. Consequently, in the traitor-tracing algorithm, one or more honest buyers may be identified as traitors, since these buyers provided their fragments to the fake proxy in the distribution protocol.
2. **Man-in-the-middle attack:** An attacker may attempt to eavesdrop on a communication between a buyer and one or more of his/her proxies and store all the fragments of the content.
3. **Database attack:** An attacker may try to obtain the fingerprint of a buyer stored in *MO*'s database.
4. **Conspiracy attacks:** A possible coalition of one or more of the participants (proxies, *Me*, *B_i*, *MO* or *T_A*) in the distribution and traitor-tracing protocols may try to obtain the fingerprint or the fingerprinted content linked to a particular honest buyer.
5. **Ciphertext only attacks:** *MO* may try to disclose the fingerprint of an honest buyer through inspection of the encrypted fingerprints stored in his/her database, since *MO* could try to differentiate between encrypted '0's and '1's.

3.3.2. Collusion attacks

Collusion has been the main research challenge in the realm of fingerprinting. The general weakness of digital fingerprinting occurs when a coalition of buyers compare their uniquely fingerprinted copies of the content to exploit the differences among them trying to remove or alter the fingerprint. The objective of such attack is to evade being traced and, at the same time, possibly frame an innocent buyer. This attack is known as collusion attack and such group of collaborating buyers is called a set of colluders (or a coalition). If a digital fingerprint is not properly

designed, a fingerprinting system might fail to detect the traces of any fingerprints under collusion attacks with only a few colluders. To ensure the reliable tracing of true traitors and avoid framing honest buyers, the following collusion attacks are considered in the system:

1. **Averaging attack.** In an averaging attack, attackers with a total of Q fingerprinted copies of the same content collude to produce a pirated copy Y . The fingerprinted signals are typically averaged with an equal weight for each user:

$$Y(i) = \frac{y_0(i) + y_1(i) + \dots + y_{Q-1}(i)}{Q}.$$

2. **Minimum attack.** Under this attack, the colluders create a copy Y whose i -th ($i = 1, 2, \dots, l$) component is the minimum of the i -th components of the observed marked copies:

$$Y(i) = \min \{y_0(i), y_1(i), \dots, y_{Q-1}(i)\}.$$

3. **Maximum attack.** The colluders create an attacked copy Y by taking the maximum value of the i -th components of their individual marked copies:

$$Y(i) = \max \{y_0(i), y_1(i), \dots, y_{Q-1}(i)\}.$$

The security of the system against the framing and collusion attacks is discussed in Section 5.

3.4. Architecture of the system

This section describes the architecture of the proposed system. Fig. 4 shows the structure of the system that contains six main entities: merchant, parent buyer, child buyer, monitor, proxy peers and tracing authority. These entities are involved in three key protocols of the system: bootstrapping, file distribution, and traitor tracing.

In the bootstrapping protocol, MO generates Nuida et al.'s codewords for M seed buyers. Then MO , executes the embedding algorithm to embed these codewords into the fragments of the multimedia content provided by the merchant. The embedding algorithm produces M seed copies, which are transferred to the seed buyers. Also, MO encrypts the segments of the fingerprint codewords with the public key of T_A , and then signs these encrypted segments using its secret key.

The P2P distribution protocol involves MO , the parent buyer, the proxy peers, and the child buyer. The proposed system is configured to select the proxy peers automatically for the content distribution between the parent and the child buyers. When a child buyer requests a content from the merchant, a list of proxy peers is provided to him/her. The child buyer selects the proxy peers from the list to initiate the distribution protocol. After receiving a request from the child buyer, each proxy peer chooses at least two parent buyers, and sends the request to these parent buyers

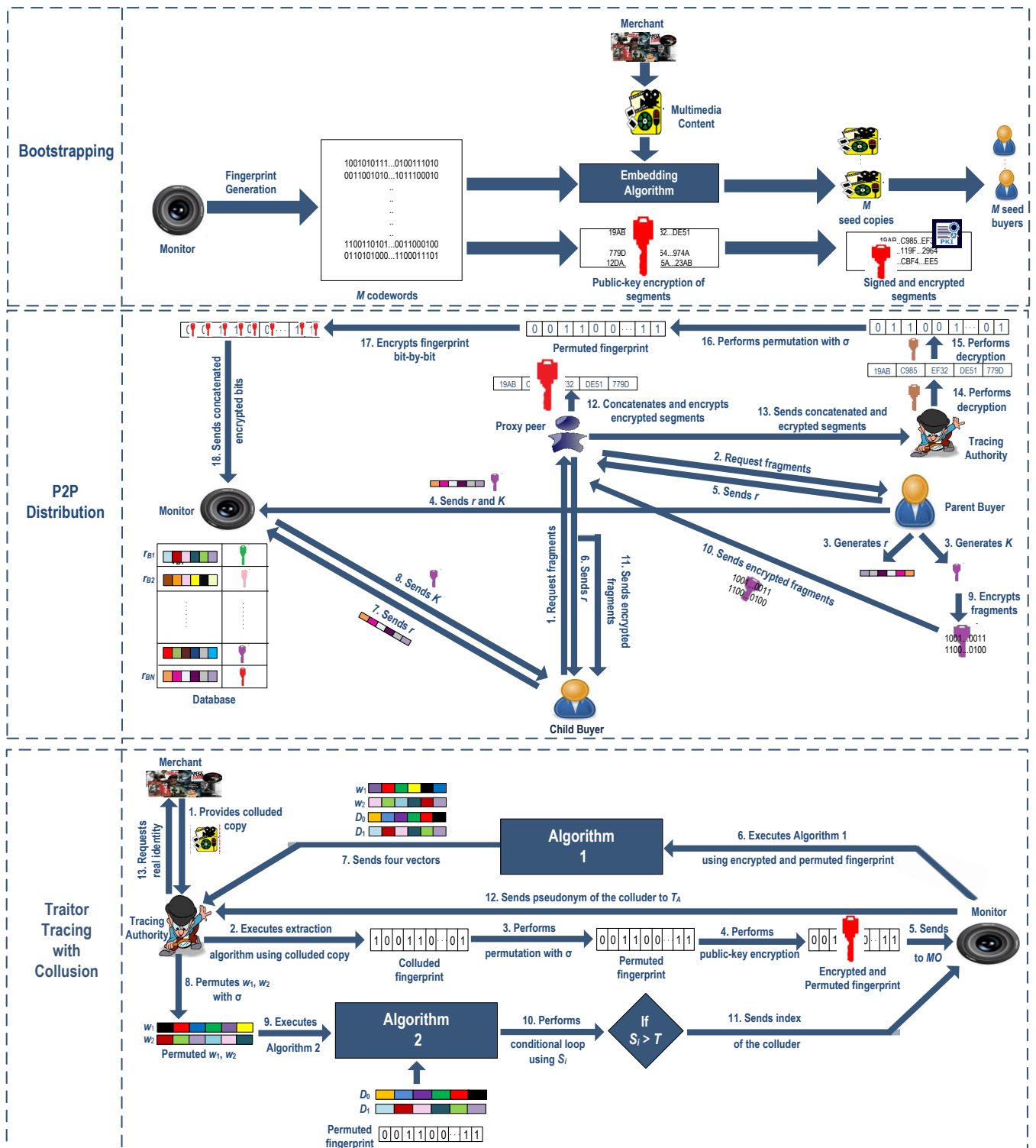

Figure 4: System architecture

for content transfer. The details of anonymous content transfer between the parent buyers and the child buyer are provided in Protocol 2 in Section 3.5. During the execution of Protocol 2, each proxy stores the corresponding encrypted segments. After the content is transferred anonymously between the buyers, each proxy peer concatenates the stored segments, encrypts the concatenated segments and sends it to T_A . T_A performs the decryption of the encrypted fingerprint with its private key to obtain the encrypted segments, which are re-decrypted by T_A to obtain the cleartext of the fingerprint. T_A sends the permuted and the encrypted fingerprint to MO , who stores the received fingerprints in the transaction database. The details of the distribution protocol are provided in Protocol 1.

The traitor-tracing protocol with collusion is performed between the merchant, MO and T_A . The tracing protocol is initiated by the merchant, who provides the colluded copy to T_A . After receiving the colluded copy, T_A extracts the colluded fingerprint from the content using the extraction algorithm. T_A applies permutation and encryption on the colluded fingerprint, and sends it to MO . MO performs the traitor-tracing algorithm of Nuida et al.'s codes in the encrypted domain and outputs four vectors: w_1 , w_2 , D_0 and D_1 (the details are provided in Algorithm 1). MO sends these four vectors to T_A , who calculates the scores the colluders using these vectors and the permuted fingerprint (details of score calculation are provided in Algorithm 2). Once all the scores have been obtained, T_A computes the highest scores S_i that are above a given threshold value (\mathcal{T}), and contacts MO to reveal the corresponding pseudonym. MO sends the pseudonym of the colluder to T_A , who then sends the request to the merchant to reveal the real identity of the colluder.

3.5. P2P distribution protocol

In the improved system of Megías (2015), the fingerprints of the buyers, encrypted with the public keys of both MO and T_A , are stored by MO in its transaction database. The new proposal is to store the fingerprints of the buyers in permuted and encrypted form. T_A permutes and encrypts the fingerprint using a permutation key (σ) and its own public key (K_{pA}), respectively, and then sends the result to MO .

Protocol 1 (P2P Distribution Protocol)

- 1: For $i \in \{1, 2, \dots, M\}$, MO generates the i -th seed copy by embedding a Nuida et al.'s c -secure fingerprint (Nuida et al., 2007) in each fragment of the content using any transparent, secure and robust watermarking scheme. The details of the fingerprint generation algorithm can be found in (Nuida et al., 2007).
- 2: For $i \in \{1, 2, \dots, M\}$, MO forwards the i -th seed copy to the i -th seed buyer.
- 3: For $i \in \{M + 1, M + 2, \dots, N\}$, the i -th buyer obtains his/her copy of the content by combining the fragments obtained from a set S_i of parent buyers such that $S_i \subseteq \{B_1, B_2, \dots, B_{i-1}\}$ and $|S_i| > 1$, where $|\cdot|$ is the cardinality operator. Each transaction is performed via a proxy (or a chain of proxies).
- 4: Each fragment of the content contains a fingerprint's segment g_j (with $j = 1, \dots, m$) embedded into it. The fragment is transmitted together with an encrypted version of the segment $E_{K_{pA}}(g_j)$, where K_{pA} is the public key of the tracing authority.
- 5: Each proxy selects a set of m contiguous fragments of the content (Figure 3) and facilitates the anonymous communication between parents and child for the transmission of those fragments (see Protocol 2). These m contiguous fragments carry m contiguous segments of the fingerprint embedded into them. After the execution of this step, the proxy stores the corresponding $E_{K_{pA}}(g_j)$.
- 6: The proxy concatenates m contiguous encrypted segments, encrypts the concatenation using K_{pA} and sends the result to T_A .
- 7: T_A performs the decryption on the encrypted fingerprint with its private key K_{sA} to obtain the m contiguous encrypted segments ($E_{K_{pA}}(g_j)$). Once the authority receives all the segments of a fingerprint, T_A further decrypts $E_{K_{pA}}(g_j)$ with K_{sA} to obtain the cleartext of the fingerprint f_i .
- 8: T_A uses a secret permutation key σ and permutes f_i with σ to obtain $\sigma(f_i)$. T_A keeps σ since it will be required in the traitor-tracing protocol. Then, T_A encrypts each bit of $\sigma(f_i)$ to produce $E_{K_{pA}}(\mathcal{F}(\sigma(f_i)^{(j)}, r_j))$, where K_{pA} is the public key of T_A , \mathcal{F} is some "invertible" function (possibly public) and r_j is a secret pseudo-random sequence. \mathcal{F} shall be invertible in the sense that there exists some "inverse" function \mathcal{G} such that $\mathcal{G}(\mathcal{F}(x, r_j), r_j) = x$. Both the function \mathcal{G} and the sequence r_j will be required for decryption.
- 9: T_A concatenates the permuted and encrypted fingerprint bits to produce E_{f_i} and sends it to MO .

$$E(\sigma(f_i)) = E_{K_{pA}}(\mathcal{F}(\sigma(f_i)^{(1)}, r_1)) \parallel E_{K_{pA}}(\mathcal{F}(\sigma(f_i)^{(2)}, r_2)) \parallel \dots \parallel E_{K_{pA}}(\mathcal{F}(\sigma(f_i)^{(l)}, r_l)). \quad (1)$$

Where \parallel denotes the concatenation operator.

- 10: The transaction register, created by MO for each transaction, stores the following information:
 - P_i : Pseudonym of the buyer B_i
 - $H(c)$: Perceptual content hash (used for file indexing)
 - $E(\sigma(f_i))$: Permuted and encrypted fingerprint of the buyer B_i
 - d : Transaction date and time (for billing purposes)
-

The new P2P distribution system is detailed in Protocol 1, from which the following issues can be highlighted:

1. In the first step of the protocol, we can use many different watermarking algorithms, for example (Fallahpour and Megías, 2010) for audio, or (Leelavathy et al., 2011) for still images and video.
2. Eq. 1, in Step 9 of the protocol, implies that MO cannot decrypt $E(\sigma(f_i))$ without the private key (K_{sA}) of T_A , and it is also unable to create a new fingerprint by examining the encrypted fingerprints due to an additional layer of security, namely, the permutation of the fingerprint. Also, no single proxy has access to the complete sequence of encrypted segments, since at least two proxies must be chosen by each buyer as described in Section 3.2.1.
3. In Step 8, the fingerprint is encrypted bitwise by T_A , using a public-key cryptosystem, an “invertible” function \mathcal{F} and a fixed vector of pseudo-random numbers $r_j \in \mathbb{Z}_n^*$. This vector is generated by T_A , with length equal to l . The function \mathcal{F} is used combined with the pseudorandom sequence r_j in order to produce different values for binary ‘1’s and ‘0’s at different positions of the fingerprint.
4. Both \mathcal{F} and the sequence r_j must be the same for the different fingerprints associated to the same content. After decryption, the “inverse” function \mathcal{G} and the secret sequence r_j are also required to recover the correct bit, as follows:

$$\mathcal{G}\left(D_{K_{sA}}\left(E_{K_{pA}}\left(\mathcal{F}\left(\sigma(f_i)^{(j)}, r_j\right)\right)\right), r_j\right) = \sigma(f_i)^{(j)}.$$

In the sequel, we use $E\left(\sigma(f_i)^{(j)}\right)$ to refer to $E_{K_{pA}}\left(\mathcal{F}\left(\sigma(f_i)^{(j)}, r_j\right)\right)$ for the sake of notational simplicity.

5. A possible implementation of this encryption/decryption is the Paillier’s cryptosystem (Paillier, 1999), which already includes a pseudo-random number for encryption. This choice makes it possible to avoid applying the functions \mathcal{F} and \mathcal{G} , since they can be considered to be included in the cryptosystem itself. Because of this, we have taken this approach for implementation, although any other public-key cryptosystem could have been used together with appropriate functions \mathcal{F} and \mathcal{G} , and a secret sequence r_j .

Paillier is a probabilistic public-key cryptosystem in which a public key is used to encrypt the cleartext, whereas a private key is required to decrypt a ciphertext, and both keys are computationally not easily derived from each other. Paillier is probabilistic in the sense that same cleartext m_1 is represented by different ciphertexts. This is due to the fact that in the encryption function of Paillier cryptosystem, a random number $r \in \mathbb{Z}_n^*$ is chosen so as to produce different ciphertexts for the same cleartext m_1 . The cryptosystem has the property that all the ciphertexts would decrypt to the same cleartext m_1 . This property is very useful when the range of possible cleartext is small, e.g. a single bit data (‘0’ or ‘1’). In the absence of such an encryption function, an adversary could statistically determine the proportion of the inputs and gain useful information about the data. With this implementation, we can simply use $E_{K_{pA}}(x, r_j)$ and $D_{K_{sA}}(y, r_j)$ instead of $E_{K_{pA}}(\mathcal{F}(x, r_j))$ and $\mathcal{G}(D_{K_{sA}}(y), r_j)$, respectively.

6. However, the encryption of the fingerprints of all the buyers with the same vector r_j has a drawback. Since MO stores the encrypted fingerprints of all the buyers in its database, it may randomly pick two fingerprints, inspect them and find identical ciphertexts at different positions of these observed fingerprints. Consequently, MO could try to infer the possible cleartext value ('0' or '1') of these identical ciphertexts and may attempt to guess some buyer's fingerprint. This drawback is circumvented in our protocol with an additional layer of security, i.e. the permutation of the encrypted fingerprint's bits with σ . In this way, even if MO could infer the values of the cleartext of all the bits of a chose fingerprints of (say) length $l = 5,000$ bits, it would still require to compute about $l! = 5,000!$ permutations to obtain the valid fingerprint, which would be computationally infeasible.
7. For the anonymous transfer of fragments between buyers in Step 3, Protocol 2 is executed. This is the same four-party anonymous communication protocol used in Megías (2015) to prevent the proxies from accessing the cleartext of the transferred content between the parents and a child buyer. This protocol protects the symmetric keys shared between the source and the destination buyers using MO as a temporary key database. In case a malicious proxy tried to access the database to retrieve the symmetric key, the corresponding record would be erased or blocked, if already retrieved by the legitimate buyer. If the database query of the malicious proxy occurred before that of the legitimate buyer, the latter would find the record either erased or blocked. Hence, the malicious access by the proxy would be detectable.

Protocol 2 (Anonymous Content Transfer Between Buyers)

- 1: The parent buyer chooses a symmetric (session) key K .
 - 2: The parent chooses a pseudorandom binary sequence r to be used as a handle (primary database key) for K . The space for r should be large enough (e.g. 128 bits) to avoid collisions.
 - 3: The parent buyer sends (r, K) to MO , who stores it in a database.
 - 4: The parent buyer sends r to the proxy and the proxy forwards r to the child buyer.
 - 5: The child buyer sends the r to MO , who replies with the corresponding key K .
 - 6: MO blocks the register (r, K) for a given period of time. When the specific time is passed, MO removes the register from its database.
 - 7: The parent buyer sends the requested fragments, encrypted with K , to the proxy.
 - 8: The proxy forwards all fragments to the child buyer, who can decrypt them using K .
-

A security analysis of both protocols (1 and 2) is provided in Section 5.1.1.

3.6. Proposed traitor-tracing protocol

The basic traitor-tracing protocol (without collusion) of the system proposed by Megías (2015) performs a simple database search to identify an illegal re-distributor. In this protocol, T_A extracts the fingerprint from the pirated copy,

encrypts it with the public key of MO and its own public key to produce an encrypted fingerprint. This encrypted fingerprint is efficiently searched in the database of MO , who reveals the pseudonym of the buyer whose encrypted fingerprint matches the encrypted fingerprint extracted from the pirated copy.

Similarly, in the new basic traitor-tracing protocol (Protocol 3) without collusion, T_A first extracts a fingerprint from an illegally re-distributed copy using the same watermarking scheme that was used for embedding the fingerprint in Protocol 1. Then, T_A permutes the extracted fingerprint f' using σ , encrypts $\sigma(f')$ with K_{pA} (using also the function \mathcal{F} and the sequence r_j), concatenates the permuted and encrypted bits, and sends the result to MO . MO searches the permuted and encrypted fingerprint in its database and, if found, reveals the corresponding pseudonym to T_A . The real identity of the traitor is disclosed by Me , who has an access to the buyers' database. In Protocol 3, an illegal re-distributor is identified without the involvement of any buyer and, also, without requiring decryption of any segment of the fingerprint.

Protocol 3 (Basic traitor tracing without collusion)

- 1: The fingerprint f' of the illegally re-distributed copy is extracted by T_A using the extraction method and the extraction keys provided by MO .
 - 2: f' is permuted by T_A using σ to produce $\sigma(f')$.
 - 3: Each bit of $\sigma(f')$ is then encrypted with K_{pA} (using also \mathcal{F} and r_i), resulting in permuted and encrypted fingerprint $E(\sigma(f'))$ as per Eq. 1.
 - 4: T_A sends $E(\sigma(f'))$ to MO .
 - 5: MO searches $E(\sigma(f'))$ in its database. If a matching record is found, the corresponding pseudonym is revealed to T_A . Otherwise, an empty set is sent to T_A .
 - 6: If a pseudonym is obtained, T_A sends a request to Me to provide the real identity of the traced buyer. Then, Me checks his/her database of buyers and retrieves the real identity and AGR corresponding to the pseudonym received from T_A . If no pseudonym is obtained, the traitor-tracing protocol with collusion (Protocol 4) must be run.
-

In case a traitor is not identified in Protocol 3, the traitor-tracing protocol with collusion (Protocol 4) is executed to identify a colluder or a set of colluders. The traitor-tracing protocol of (Megías, 2015), in case of collusion of several buyers, requires a decrypted fingerprint's hash to trace a colluder. In this regard, MO requires the cooperation of the involved proxies to construct a valid codeword for each hash when the content is distributed to each buyer. The hash $h(f')$ of a colluder can be reconstructed from the fingerprint f' extracted from the colluded copy. This hash is then encrypted using the public key of MO to produce $E_{K_{pMO}}(h_{f'})$. Then, $E_{K_{pMO}}(h_{f'})$ is searched in the database of MO , instead of the encrypted fingerprint. As described in (Megías, 2015), with a large enough hash space, hash collisions would be almost negligible and a colluder would still be identified in the vast majority of the cases.

Protocol 4 (Traitor tracing with collusion)

- 1: T_A extracts the colluded fingerprint f' from the content, permutes it using the permutation key σ , encrypts it bitwise, obtaining $E(f')$, and sends it MO .
 - 2: MO computes four vectors $\omega_1, \omega_2, D_0, D_1$ using Algorithm 1 for all buyers B_i , and sends them to T_A .
 - 3: T_A performs the permutation of the received ω_1, ω_2 , using σ , in Algorithm 2.
 - 4: The score S_i of the each buyer B_i is computed by T_A , using D_0, D_1 , and the permuted ω_1, ω_2 and f' , in Algorithm 2.
 - 5: T_A obtains the indexes of the colluders (at least one) with the highest scores (greater than the global threshold \mathcal{T}) and sends them to MO .
 - 6: MO sends the pseudonyms of the colluders to T_A (corresponding to the indexes of the previous step). The real identities of the buyers is not known by T_A , only the pseudonyms are revealed.
 - 7: In order to obtain the real identity of the colluders, T_A contacts Me , since only he/she has the access to buyers' database, who associates the pseudonyms with the corresponding real identities. Me also provides a proof (AGR) of the association between the pseudonyms and the identities.
-

In the new traitor-tracing system with collusion, T_A extracts the fingerprint f' from the colluded copy, permutes f' using σ , and encrypts the result with K_{pA} (using also \mathcal{F} and r_j) to produce $E(\sigma(f'))$ as per Eq. 1. Then, T_A sends $E(\sigma(f'))$ to MO , who performs the first part of the traitor-tracing algorithm (Algorithm 1) of Nuida et al.'s fingerprinting codes.

The standard traitor-tracing algorithm published by Nuida et al. (2007) is carried out in the cleartext domain by comparing the traced and the tested fingerprints, and outputs the set of colluders with the highest scores. In the proposed system, due to the requirement of buyer frameproofness (see Section 3.2.1), MO stores the permuted and encrypted fingerprints in his/her transaction database. Thus, in order to perform Nuida et al.'s traitor-tracing algorithm in cleartext, MO would need the private key of T_A (and also the sequence r_j and the function \mathcal{G}) together with σ . Since T_A is the trusted party of the system, only it can perform operations on a cleartext fingerprint. Therefore, in order to protect the frameproofness of innocent buyers, it is required that MO performs the traitor-tracing algorithm of Nuida et al.'s codes in the encrypted domain, in such a way that the scores of the colluders obtained in the encrypted domain match those that would be calculated in the cleartext domain.

In the standard Nuida et al.'s traitor-tracing algorithm, the scores are calculated on the basis of bit differences or similarities between the traced fingerprint f' and the tested fingerprint f_i . The scores obtained through the modified Nuida et al.'s traitor-tracing protocol (i.e. in the encrypted domain) are identical to those obtained using standard Nuida et al.'s traitor-tracing algorithm. The detailed description of the modified Nuida et al.'s traitor-tracing protocol is provided in Protocol 4. It can be noticed that part of the computations (Algorithm 1) are carried out by MO and the rest are performed by the tracing authority (Algorithm 2). The reason for this is that only the authority knows the permutation key σ used to shuffle the bits of fingerprints, in such a way that the cleartext of the fingerprints are never

Algorithm 1 Traitor-tracing algorithm performed by *MO*

function NUIDA ET AL.'S TRAITOR-TRACING ALGORITHM

Input parameters: $E(\sigma(f'))$, p , $E(\sigma(f_i))$

Output parameters: ω_1 , ω_2 , D_0 , D_1

Use function $\phi(x) \doteq \sqrt{(1-x)/x}$, for $x \in [0, 1]$.

begin

for $k \in \{1, 2, \dots, l\}$ **do**

$\omega_1^{(k)} \leftarrow \phi(1 - p^{(k)})$

▷ Calculate two vectors of the scores $\omega_1^{(k)}$ and $\omega_2^{(k)}$ using $\phi(p)$

$\omega_2^{(k)} \leftarrow \phi(p^{(k)})$

if $E(\sigma(f')^{(k)}) = E(\sigma(f_i)^{(k)})$ **then**

$D_0^{(k)} \leftarrow +1$

$D_1^{(k)} \leftarrow +2$

else

$D_0^{(k)} \leftarrow -2$

$D_1^{(k)} \leftarrow -1$

end if

end for

return ω_1 , ω_2 , D_0 , D_1

end function

available for the monitor, yielding buyer frameproofness.

Since *MO* needs to perform the traitor-tracing algorithm in the encrypted domain, the scores will be calculated using $E(\sigma(f'))$, $E(\sigma(f_i))$ and p as inputs, where p is the secret vector used by *MO* in the generation of the segment codewords. Since traitor-tracing is performed using the permuted fingerprints, p should also be permuted in order to compute the scores of the buyers. However, *MO* cannot carry out this permutation, because σ is known only by T_A . A possibility to overcome this difficulty would be to send p to T_A , who would perform the permutation on p and send the result back to *MO*. However, this solution would not be viable, since *MO* could observe the differences between p and $\sigma(p)$, infer σ , and try to use the permutation key to disclose a valid fingerprint. Another possibility would be to send p and $E(\sigma(f_i))$ from *MO* to T_A , who would perform permutation on p and then calculate the scores of the buyers. However, this exchange of encrypted fingerprints (the whole database) would not be efficient, since it would require enormous communication costs (e.g. if millions of users have purchased the traced content). Also, as discussed in Section 3.1, traitor-tracing is considered more effective and reliable when this functionality is performed by an entity different from the party responsible for the generation of the fingerprints.

In the proposed traitor-tracing algorithm with collusion (Algorithm 1), *MO* calculates two vectors, ω_1 and ω_2 ,

Algorithm 2 Traitor-tracing algorithm performed by T_A

function NUIDA ET AL.'S TRAITOR-TRACING ALGORITHM

Input parameters: $\omega_1, \omega_2, D_0, D_1, f', \sigma$

Output parameter: S_i

Use function $\text{sign}(x) \doteq \begin{cases} 1, & \text{if } x \geq 0, \\ -1, & \text{otherwise.} \end{cases}$

begin

$W_1 \leftarrow \sigma(\omega_1)$

$W_2 \leftarrow \sigma(\omega_2)$

for $k \in \{1, 2, \dots, l\}$ **do**

$j \leftarrow \sigma(f')^{(k)}$

$S_i^{(k)} \leftarrow \text{sign}(D_j^{(k)}) \cdot W_{|D_j^{(k)}|}^{(k)}$

end for

$S_i \leftarrow \frac{1}{l} \sum_{k=1}^l S_i^{(k)}$

return S_i

end function

using vector p , instead of sending p to T_A . Obviously, T_A could compute p from ω_1 and ω_2 , but T_A is a trusted entity (Section 3.2.2) and it is not expected to behave maliciously. Then, MO compares the encrypted bits $E(\sigma(f_i))$ and $E(\sigma(f'))$ and outputs two vectors (D_0 and D_1), which contain pairs of either positive or negative indexes of ω_1 and ω_2 . Later on, D_0 will be used when the corresponding cleartext is '0', whereas D_1 is used for a cleartext equal to '1'.

In the original Nuida et al.'s traitor-tracing algorithm, in case of identical bits in $f_i^{(k)}$ and $f'^{(k)}$ (either both '1's or both '0's), a positive score equal to $\omega_1^{(k)}$ or $\omega_2^{(k)}$ is assigned to that bit position. On the other hand, a differing bit between $f_i^{(k)}$ and $f'^{(k)}$ results in a negative score, either $\omega_1^{(k)}$ or $\omega_2^{(k)}$. The same approach is adopted in Algorithm 1, where in case of an equality result between $E(\sigma(f')^{(k)})$ and $E(\sigma(f_i)^{(k)})$, MO assigns a value with a positive sign (indicated by '+') to the "subscript vectors" $D_0^{(k)}$ and $D_1^{(k)}$. Similarly, in case of inequality, a negative value (indicated by '-') is assigned to the "subscript vectors". In the final step of Algorithm 1, MO returns the output (ω_1, ω_2, D_0 and D_1) that will be sent to T_A , who further carries out the remaining steps of the original Nuida et al.'s traitor-tracing algorithm (as described in Algorithm 2).

In Algorithm 2, T_A computes a score of the buyer with $\omega_1, \omega_2, D_0, D_1$ and $f'^{(k)}$ and σ as its inputs. Here, the cleartext bits $f'^{(k)}$ are required by T_A in order to determine the correct score for each bit position, which will make it possible to select the appropriate value $\omega_1^{(k)}$ or $\omega_2^{(k)}$. The absolute value of $D_0^{(k)}$ or $D_1^{(k)}$ is used as a subscript for the selection of the appropriate value, whereas the sign of $D_0^{(k)}$ or $D_1^{(k)}$ is used to determine the sign of the score of that particular bit. It is worth pointing out that T_A first performs the permutation σ on f', ω_1 and ω_2 to yield $\sigma(f'), W_1$ and W_2 , respectively.

In short, T_A computes the scores of a buyer bit-by-bit by using the bits of $\sigma(f')^{(k)}$ in the following way: If $\sigma(f')^{(k)}$ is equal to '0', T_A selects $D_0^{(k)}$, which points towards the value contained in either $W_1^{(k)}$ (positive case) or $W_2^{(k)}$ (negative case), depending on the result of the comparison carried out by MO in Algorithm 2, along with its sign. Alternatively, if $\sigma(f')^{(k)} = '1'$, T_A selects $D_1^{(k)}$, which refers to a positive value stored in W_2 or a negative value stored in W_1 , to compute the score for that bit. When all bitwise scores of a buyer have been computed, T_A calculates the total score of that buyer by taking the average of the all bitwise scores.

Finally, once all the scores for all buyers have been obtained, T_A computes the highest scores (which shall be above a given threshold \mathcal{T}) and contacts MO to reveal the corresponding pseudonyms. Simulated results and a theoretical analysis of the traitor-tracing protocol with collusion are provided in Section 5.2.

4. Features of the proposed system and comparative analysis

In this section, we discuss how the drawbacks of (Megías, 2015) are circumvented by the new protocols and algorithms. Besides, we compare the features and shortcomings of existing anonymous fingerprinting schemes for P2P networks with the proposed system.

4.1. Features of the proposed system

As discussed in Section 2.4, the system proposed by Megías (2015) exhibits two major drawbacks: 1) the fingerprinting scheme requires a two-layer anti-collusion code, which results in a longer codeword, and 2) the construction of a valid hash-level anti-collusion code requires the participation of the proxies, supervised by MO , with a non-specified protocol to guarantee that the hash-level codeword is valid. Both drawbacks are caused by the requirement of the two-layer fingerprint encoding in order to obtain collusion resistance.

In the proposed work, this first drawback is overcome by using the state-of-the-art Nuida et al.'s codes in a segment-wise form. Nuida et al.'s codes provide outstandingly short code lengths. For example, 10 different codewords providing collusion resistance against $c \leq c_0 = 4$ colluders can be obtained with codewords of length $l_0 = 788$ bits. If l_0 is the length of a codeword with collusion resistance against $c \leq c_0$ colluders, the total fingerprint will have length $l = l_0 n_s$, where n_s is the number of segments of the fingerprint, as shown in Figure 3. If we build a fingerprint with 74 segments to provide collusion resistance against $c \leq 4$ colluders, with 10 different codewords (i.e. the number of seed buyers should be no greater $M \leq 10$), we require fingerprints with $l = 788 \cdot 74 = 58,312$ bits, much shorter than those required by the systems in (Megías and Domingo-Ferrer, 2014; Megías, 2015). Note that 74 segments is more than enough to guarantee the numerical explosion of the fingerprint space. If 10 different values (codewords) are available for each segment (as required if we have $M = 10$ seed buyers), the number of possible fingerprints becomes 10^{74} , many orders of magnitude larger than the population of the Earth.

On the other hand, in (Megías, 2015), the length of the fingerprint is obtained by multiplying the length of the segment-level code by the length of the hash-level code, which may result in too long fingerprints for real applications.

E.g. if the length of the segment-level codewords is, again, 788 bits (providing resistance against $c \leq 4$ colluders and 10 different codewords), and that of the hash-level codewords is 1,577 bits for resistance against $c \leq 4$ colluders and 100,000 different codewords (which would be the maximum number of buyers for that content), the whole fingerprint would be $788 \cdot 1,577 = 1,242,676$ bits long, which could be unsuitable for many applications (e.g. relatively short music files). Note that 58,312 bits are enough for 10^{74} buyers with the proposed system, whereas 1,242,676 bits only suffice for 100,000 buyers with the system of (Megías, 2015), in both cases providing resistance against $c \leq 4$ colluders.

Similarly, the second drawback is overcome by the proposed system since any recombination of segments produces a valid fingerprint. Thus, we no longer require the construction of a hash-level anti-collusion codeword among segments. In Megías (2015), a valid hash-level codeword must be constructed with the help of the proxies and the supervision of MO . In order to obtain a valid codeword, the proxies need to contact more parents, due to the fact that the hash-level collusion-resistant code may require a specific hash bit ('0' or '1') for a particular position. If no parent is available with that particular hash bit, the proxy must wait for an undetermined period until a valid segment becomes available from some parent.

The construction of the fingerprints is, thus, much simpler in the proposed system, since any recombination of segments yields a valid fingerprint. Hence, the new distribution protocol does not require the verification of the fingerprint. In addition, in the proposed distribution protocol, MO stores the fingerprint of each buyer permuted and encrypted by T_A , which is a trusted party, using σ and its public key (K_{pA}). A signature of both the segment and the corresponding content's fragment can be transmitted alongside the segment to prevent proxies from cheating. This signature approach is also used in (Megías, 2015) and (Megías and Domingo-Ferrer, 2014) to prevent the proxies from reporting fake segments in the distribution protocol.

Finally, a new protocol for traitor tracing (Protocol 4) is proposed, in which guilty buyers with the highest scores (above some threshold) are successfully traced and identified. The standard Nuida et al.'s traitor-tracing system has been modified to work in the encrypted domain (yielding the same result as the cleartext counterpart). Hence, the traitor-tracing protocol is executed without requiring MO or T_A to decrypt any single segment of the buyers' fingerprints and, also, without requiring the cooperation of any single buyer of the system.

4.2. Comparative analysis

In this section, we provide a comparative analysis of the properties of the suggested scheme against existing recent anonymous fingerprinting schemes for P2P systems (Domingo-Ferrer and Megías, 2013; Megías and Domingo-Ferrer, 2014; Megías, 2015; Qureshi et al., 2015, 2016). The comparison, summarized in Table 2, considers the following desirable properties for large-scale P2P anonymous fingerprinting schemes:

1. **Embedding required for only a few fingerprints:** Whether the system works by embedding only a small number of fingerprints. The smaller the number of embeddings, the most efficient the distribution becomes either for the merchant or for the peer buyers (or both).

2. **Guaranteed traitor tracing:** Whether the system guarantees traitor tracing when the number of colluders c does not exceed the collusion resistance capacity of the fingerprinting code ($c \leq c_0$).
3. **Single-level anti-collusion code:** Whether the system works with a single-level anti-collusion code or requires several levels of coding.
4. **Fully P2P distribution system:** Whether the distribution of all the files occurs in a fully P2P manner.
5. **Avoids public-key encryption of contents:** Whether the system avoids public-key encryption of the contents.
6. **Efficient protocols:** Whether the protocols are efficient (avoiding costly mechanisms, such as zero-knowledge proofs or secure multi-party computations).

	Embedding required for only a few fingerprints	Guaranteed traitor tracing	Single-level anti-collusion code	Fully P2P distribution system	Avoids public-key encryption of contents	Efficient protocols
Domingo-Ferrer and Megías (2013)	No	Yes	Yes	No	Yes	No
Megías and Domingo-Ferrer (2014)	Yes	No	No	Yes	Yes	Partially
Megías (2015)	Yes	Yes	No	Yes	Yes	Partially
Qureshi et al. (2015)	No	Yes	Yes	No	Partially	Yes, partially centralized
Qureshi et al. (2016)	Yes	Yes	Yes	No	Yes	Yes, partially centralized
Proposed	Yes	Yes	Yes	Yes	Yes	Yes

Table 2: Comparative analysis of P2P-based anonymous fingerprinting schemes

The comparative analysis of Table 2 points out the following issues:

- The system of (Domingo-Ferrer and Megías, 2013) requires a specific embedding per each buyer, although this embedding is carried out by peer buyers except for the first generation, for which the merchant is the party who

embeds the fingerprint. The main drawbacks of this system are: 1) it does not provide a fully P2P distribution scheme, since the transfers are carried in tree form (not a graph), and 2) it requires a non-specified complex and costly secure multi-party computation protocol for each file transfer to guarantee frameproofness.

- The scheme proposed in (Megías and Domingo-Ferrer, 2014) entails two major drawbacks: 1) the co-operation of innocent buyers in traitor tracing may lead to situations in which an illegal re-distributor cannot be traced by the authority, and 2) it requires a double layer anti-collusion code (one for the fingerprint segments and another one for the fingerprint hash). To create the hash level codeword, the proxies and the monitor will have to deploy a complex protocol in such a way that the codeword is not revealed to any single party. This protocol is unlikely to be efficient (it will require multi-party secure computation or a similar approach).
- The system of (Megías, 2015) solves most of the drawbacks of the previous scheme, but still requires the two-layer encoding of the fingerprint, which entails the problems discussed above.
- The proposal of (Qureshi et al., 2015) requires the merchant to participate in the distribution protocol and embed the fingerprint in a short-sized base file (for each single buyer), whereas a much larger supplementary file –useless without the former– is distributed through the P2P network. The distribution of the base file requires embedding the fingerprint in the encrypted domain and, hence, the contents are partially encrypted (using homomorphic encryption). As a result, the merchant is involved in computations and transfers for each single purchase, and hence the distribution is not purely P2P.
- Recently, the system proposed in (Qureshi et al., 2016) uses some of the ideas of Qureshi et al. (2015), but replaces homomorphic encryption by fragmentation, symmetric encryption, permutation and distribution of the fragments through a collection of proxy peers. In addition, the embedding is pre-computed by embedding a string of all 1's and one of all 0's in the original content. The appropriate bit for each coefficient is selected by the proxies from the pre-computed values. Although the protocol for the creation and distribution of the base file is much lighter than the one of Qureshi et al. (2015), it still requires the participation of the merchant for each file transfer. Hence, the distribution is not fully P2P. The P2P network is used only for the distribution of the large-sized supplementary file. Therefore, as scalability is concerned, the computational and communication costs for the merchant will grow linearly with the number of buyers.
- Finally, the system proposed in this paper provides the most scalable and efficient solution. The merchant only needs to embed the fingerprint for the seed buyers, whose number (M) will be typically small (e.g. around 10). Thereafter, all the transfers are carried out in a purely P2P fashion, and the recombination of the segments of the fingerprints is enough to produce unique identifiers of buyers due to numerical explosion. Public-key encryption is required only for short strings and not for the multimedia contents. The introduction of Nuida et al.'s codes makes it possible to work with a single-level collusion-resistant code, resulting in a simple P2P

distribution protocol. The standard traitor-tracing algorithm has been replaced by a protocol between the monitor and the authority, in which permuted and encrypted fingerprints are used, making it possible to distinguish between colluders and innocent buyers. The operation of such protocol is analyzed in the following section, both theoretically and by means of simulations.

Among the analyzed systems, the proposed work is the one that provides the best properties. After bootstrapping, all transfers occur within the P2P network without any participation of the merchant. This provides excellent efficiency and scalability, with reduced costs for the merchant, which may give rise to cheaper prices for the buyers. Consequently, in this paper, we successfully overcome the results of prior art (Megías and Domingo-Ferrer, 2014; Megías, 2015; Qureshi et al., 2015, 2016) The new proposal is much more practical and easier to implement. Hence, if digital media producers decided to adopt this paradigm, they would not be afraid of the illegal usage and re-distribution of their products, making it possible to fight against the reluctance to use P2P networks due to piracy. Therefore, we provide a much more efficient, scalable and cheap solution for content providers.

4.3. Discussion

This section discusses the strengths, weaknesses, and limitations of the proposed fingerprinting system.

A. Strengths of the system: The notable features of the proposed system that make it novel and effective are the following:

- Distribution produces automatic fingerprinting by recombination with no additional embedding. After bootstrapping, we only need to recombine the existing fingerprints in each transaction.
- The computational and communication costs for the merchant are zero per each transaction, which is quite novel in fingerprinting scenarios. Once the system is started, the merchant does not need to participate in any transfer.
- The proposed scheme prevents the double layer encoding of the fingerprint required by the previous recombination-based schemes (Megías and Domingo-Ferrer, 2014, 2013; Megías, 2015). This two-layer encoding was very problematic, since it produced long fingerprints and also required supervision by the monitor in the distribution system (not all recombined fingerprints were valid).

B. Disadvantages of the system: This part of the section discusses the weaknesses of the system, and also the countermeasures to mitigate these disadvantages.

- The first weakness of the system is related to the anonymous communication protocol between peer buyers that uses onion routing-like protocol, which causes a cryptographic overhead. This overhead is due to encryptions

and decryptions, and increase in the routing path to provide anonymity between two communicating parties. Any system that provides anonymous communication to prevent direct connection between a sender and a receiver has to bear the costs arising from encryption/decryption operations and increased routing traffic. To mitigate this weakness, we used symmetric cryptography instead of asymmetric to reduce the cryptographic overhead.

- The second disadvantage is related to the size of a fingerprint, which is shorter than in previous recombined approaches, but still can have a size of several kilobytes, resulting in a database of fingerprints of several megabytes (MBs) or even gigabytes (GBs) for each content. However, with the advancement in the storage technology and reduced costs, we envision high capacity storage devices in the deployment of our system that could easily store fingerprints databases of the order of GBs.
- The third weakness of the system corresponds to tracing colluder(s) in an encrypted domain in traitor-tracing protocol (Protocol 4), which causes computational overhead for the tracing authority. To subdue this issue, a cloud-based service could be used, that would be solely responsible for executing the traitor-tracing protocol. Since the traitor-tracing protocol with collusion (Protocol 4) is executed in an encrypted domain, the use of cloud would not raise any security or privacy concerns.

C. Limitations of the system: In the following, we discuss the constraints of the proposed system with respect to the anonymous fingerprinting scheme:

- The recombination scheme works as long as there are at least two parents available per each transaction. Otherwise, the fingerprint obtained by a child would be identical to that of his/her only parent, what is unsuitable for traitor tracing.
- Randomness is required for a correct recombination of segments. The proxies should not simply take the first half fragments from a parent and the second half fragments from a second one. This would produce identical fingerprints during distribution and, hence, the traitor-tracing protocol would result in incorrect results. For example, if a proxy chooses two parents for 10 fragments, he/she may select fragments 1, 4, 6, 8 and 9 from one parent, and 2, 3, 5, 7 and 10 from the other one, instead of choosing 1 – 5 and 6 – 10. This must be carefully enforced in the distribution protocol. Malicious proxies deviating from the distribution protocol should be detected to prevent repeated fingerprints.
- Also, the proxies should not deviate from the protocols in other key steps, such as those required to store the encrypted fingerprints in the transaction monitor's database. Although the protocols introduce controls to detect malicious proxies, there must be a constant supervision of the proxies to detect them quickly and prevent a flawed fingerprint database that could undermine the tracing system.

- Although n_s segments can yield, theoretically, M^{n_s} different fingerprints, this is not really true, since two fingerprints differing only in a few segments would be considered identical by the traitor-tracing protocol. This is also related to the second weakness of this list. The larger the number of segments (n_s), and the larger the number of seed buyers (M), the probability of having two equivalent fingerprints becomes vanishingly small. With the numbers selected for the experiments ($n_s = 74$ and $M = 10$) and a good random selection of the fragments, two equivalent fingerprints would be almost impossible even for billions of buyers (since 10^{74} is a huge number compared to 10^9).
- Finally, the fragments should be transferred completely from parent to child (through the proxies). The fragments can be further re-fragmented by the network protocols, but each fragment should be reconstructed completely at the child's end.

5. Theoretical analysis and simulation results

This section analyzes how the design goals (described in Section 3.2) of the proposed system are achieved. Firstly, formal and informal analyses concerning the correctness of the protocols of the proposed system, in terms of security and privacy, are presented. Secondly, the novel traitor-tracing protocol presented in Section 3.6 is examined both theoretically (in order to derive the appropriate global threshold \mathcal{T}) and by means of simulations. The effectiveness of the traitor-tracing mechanism against linear (averaging) and non-linear (maximum and minimum) collusion attacks is presented in Section 3.3.2 using simulated experiments.

5.1. Security and privacy analysis

In this section, formal and informal discussions are provided for the security and privacy of the system according to the design requirements and the attack model presented in Sections 3.2 and 3.3.

5.1.1. Formal analysis of the protocols

Formal theorems and their corresponding proofs are provided in this section to analyze the security of the proposed protocols: P2P distribution (Protocol 1), anonymous communication (Protocol 2) and traitor tracing (Protocols 3 and 4).

Theorem 1. *Malicious parties cannot frame an innocent buyer in Protocol 1.*

PROOF. There would be two ways of framing an innocent buyer B_i in Protocol 1:

1. If another party gains access to the cleartext content of that buyer and re-distributes it.
2. If the fingerprint f_j , corresponding to a buyer B_j with $j \neq i$, is linked to the pseudonym of buyer B_i instead of B_j in the transaction database. If B_j re-distributed his/her content later on, the pseudonym of B_i would be retrieved instead of that of B_j .

Both attacks would require the participation of the transaction monitor MO , which is a trusted party for the management of the session keys and the transaction database. The infeasibility of these two alternatives is discussed below.

1. The transmission of the fragments of the content from parents to a child occurs in Step 5 of Protocol 1. This transmission is carried out as detailed in Protocol 2. In this protocol, the fragments are transmitted from parents to child encrypted with different session keys (K). These keys are managed and protected by MO as described in the steps of Protocol 2. The monitor MO is a trusted party in Protocol 2 for the management of the session keys (see the security assumptions in Section 3.2.2). Hence, this kind of attack is not possible due to the trustiness of MO for the management of the session keys.
2. The transaction register, created in Step 10 of Protocol 2, contains the fingerprint of each buyer previously encrypted and permuted by the authority ($E(\sigma(f_i))$, for all i). MO cannot link the fingerprint f_j of the buyer B_j to a different buyer B_i , for some $j \neq i$, since, as detailed in the security assumptions, the monitor is trusted for the management of the transaction database.

Both possibilities are thus discarded due to the security assumptions related to MO . Any collusion of proxies and the monitor can also be discarded by the same security assumption (trustiness of MO). \square

Remark 1. Even if MO were malicious and did not respect the security of the session keys, a conspiracy attack with the proxies to decrypt all the fragments of the content for the buyer B_i would require that **all** the proxies (which must be at least two for each purchase) colluded with MO . Thus, the minimum coalition required to frame an innocent buyer would be formed by at least three malicious parties: MO and two malicious proxies. Forming such coalition would be too risky for MO , since one (or more) of the proxies may be honest and refuse to become part of the collusion. Then, the honest proxy (or proxies) could report the collusion between MO and the remaining proxies to T_A , who would take the necessary actions against MO and the involved malicious proxies.

Theorem 2. *In Protocol 2, a malicious proxy trying to obtain the symmetric keys from the database of MO would be detected.*

This theorem is already provided and proved in (Megías, 2015).

Theorem 3. *If there is no collusion, the identity of the illegal re-distributor of the content X' can be recovered in Protocol 3 without requiring the decryption of any of the fingerprints stored in MO 's database.*

PROOF. Given the re-distributed copy X' of the content, the basic traitor tracing mechanism (without collusion) is carried out as follows:

1. X' is sent to the tracing authority T_A . Then Protocol 3 is run in the following steps.

2. T_A extracts the fingerprint f' from the content X' using the extraction algorithm as follows:

$$f' \leftarrow \text{Extract}(X', \text{parameters}).$$

3. T_A computes $E(\sigma(f'))$ as per Eq. 1 (provided in Step 9 of Protocol 1), replacing f_i with f' . In this step, T_A uses σ , K_{pA} , \mathcal{F} and the sequence r_j .

4. T_A sends $E(\sigma(f'))$ to MO .

5. MO searches $E(\sigma(f'))$ in the transaction database that contains $\{E(\sigma(f_i))\}$ for all the buyers, and returns the pseudonym of the corresponding buyer (B') to T_A . As detailed in the assumptions of Section 3.2.2, MO cannot cheat in this step.

6. T_A sends the pseudonym of B' to Me and requests the real identity $\text{Id}(B')$ of the buyer corresponding to the pseudonym of B' .

7. Me sends the corresponding real identity, $\text{Id}(B')$, retrieved from the buyers database, to T_A .

As it can be seen, the re-distributor is identified as $\text{Id}(B')$ using only the encrypted and permuted fingerprint $E(\sigma(f'))$ as computed by the tracing authority T_A in Step 3 above. None of the fingerprints stored in the transaction database of MO is decrypted in Step 5 above, which completes the proof. \square

Theorem 4. *In case of collusion of $c \leq c_0$ buyers, a set of c colluders can be traced efficiently in Protocol 4 using Nuida et al.'s traitor-tracing algorithm in the encrypted domain.*

PROOF. Given the re-distributed and pirated copy Y , the traitor tracing mechanism (with collusion) is carried out as follows:

1. Y is sent to the tracing authority T_A . Then Protocol 4 is run in the following steps.

2. T_A extracts the fingerprint f' from the pirated content Y using the extraction algorithm as follows:

$$f' \leftarrow \text{Extract}(Y, \text{parameters}).$$

3. T_A computes $E(\sigma(f'))$ as per Eq. 1 (provided in Step 9 of Protocol 1), replacing f_i with f' . In this step, T_A uses σ , K_{pA} , \mathcal{F} and the sequence r_j .

4. T_A sends $E(\sigma(f'))$ to MO .

5. MO runs Algorithm 1: $(\omega_1, \omega_2, D_0, D_1) \leftarrow \text{Algorithm 1}(E(\sigma(f')), p, \{E(\sigma(f_i))\})$. The obtained outputs ω_1 , ω_2 , D_0 and D_1 are sent to T_A .

6. T_A runs Algorithm 2: $\{S_i\} \leftarrow \text{Algorithm 2}(\omega_1, \omega_2, D_0, D_1, f', \sigma)$ and obtains the scores for all buyers in the transaction database.

7. T_A finds $\{j : S_j > \mathcal{T}\}$ from the set $\{S_i\}$ (the indexes of the scores greater than the global threshold), and sends the obtained set of indexes $\{j\}$ to MO .
8. MO retrieves, from the transaction database, the pseudonyms of the buyers $\{B_j\}$ corresponding to the set of indexes $\{j\}$ obtained in the previous step, and returns them to T_A . As detailed in the assumptions of Section 3.2.2, MO cannot cheat in this step.
9. T_A sends the set of pseudonyms of the buyers $\{B_j\}$ to Me , and requests the real identities $\{\text{Id}(B_j)\}$ of the buyers corresponding to those pseudonyms.
10. Me sends the set of the corresponding real identities, $\{\text{Id}(B_j)\}$, retrieved from the buyers database, to T_A .

Hence, the colluders are identified as $\{\text{Id}(B_j)\}$, provided that the total number of colluders c satisfies $c \leq c_0$. The traitor tracing protocol uses only the encrypted and permuted fingerprint $E(\sigma(f'))$ as computed by the tracing authority T_A in Step 3 above. None of the fingerprints stored in the transaction database of MO ($\{E(\sigma(f_i))\}$) is decrypted in Step 5 above. Nuida et al.'s traitor-tracing algorithm is carried out in the encrypted domain in Steps 5 and 6 provided above (through Algorithms 1 and 2), which completes the proof. \square

5.1.2. Security and privacy attacks on the protocols

This section discusses several attack scenarios presented in Sections 3.3 and 3.3.1, which may occur during the execution of the four protocols of the system.

1. **Buyer frameproofness:** The possible collusion of proxies and MO cannot frame an honest buyer and held him/her responsible for illegal re-distribution (formally proved in Theorem 1). However, other attacks may be possible, namely 1) a malicious MO may try to disclose the fingerprint of an honest buyer through the inspection of the fingerprints stored in its database; 2) all the proxies of the same transfer may act maliciously and combine their segments to obtain an honest buyer's fingerprint; 3) a malicious party may try a brute force attack to decrypt the segments to disclose some buyer's fingerprint; and 4) a collusion between MO and T_A may try to frame an innocent buyer. These four scenarios are discussed below.

In the first scenario, MO cannot reconstruct any buyer's fingerprint directly without the private key of T_A . However, for each bit position of the encrypted fingerprints, there are only two possible values (which are different for different positions), which correspond to encrypted binary bits ('0' and '1'). The ciphertext only attack reported in Section 3.3 would consist of trying to differentiate between encrypted '0's and '1's. Nevertheless, even if MO managed to differentiate between all the encrypted '0's and '1's, it would be impossible for it to reconstruct any buyer's fingerprint because of the permutation of the fingerprints' bits. Without the permutation key σ , known only by T_A , MO would need to compute roughly $l!$ combinations to obtain a correct fingerprint, which would be computationally infeasible for a sufficiently large size of the fingerprint.

In the second case, the proxies need the secret key of T_A to decrypt each segment of the fingerprint and, hence, they cannot obtain the cleartext of any part of the fingerprint. In addition, they cannot access the decrypted fragments of the contents, as proven in Theorem 2.

In the third scenario, some malicious party having access to the fragments of the content of the M seed buyers may try a brute force attack to disclose a fingerprint. Each fragment of the content contains a segment embedded into it and, hence, the cleartext segments could be extracted from the fragments if the malicious party had access to the extraction algorithm and keys. Once the cleartext segments are available to the malicious party, they can be encrypted with the public key of T_A . If this attacking party also intercepts the encrypted segments sent from the proxies to T_A , by inspection, he/she may try to associate the encrypted segments with their cleartext counterparts. However, the segments are not encrypted one by one (in Protocol 1), but grouped in sets of m contiguous segments (Step 5). As discussed in (Megías, 2015), due to numerical explosion, this prevents such a brute force attack. For example, if $M = 10$ and $m = 32$, there would be 10^{32} possible combinations for each set of m consecutive segments, which would be more than enough for security against this kind of attack.

Finally, in the last scenario, the collusion can be disregarded since T_A is an entity that is trusted by all the parties of the system (as described in Section 3.1).

2. **Proxy authentication attack:** This attack can be resisted by employing an anonymous two-party authenticated key exchange protocol (Wang et al., 2012) in Protocol 2. When a child buyer selects a proxy peer to obtain the fragments of a content from the parent buyers, he/she can initiate an anonymous two-party authentication protocol with that proxy. After successful authentication, the proxy transfers the fragments of the content from the parent buyers to the child buyer. The details of such anonymous key exchange protocol and its security analysis can be found in (Qureshi et al., 2015).
3. **Man-in-the middle attack:** It is impossible for an attacker to intercept and decrypt the messages between a buyer and a proxy, since he/she would require the session key used for encrypting the content. In order to obtain the session key K , the attacker needs to eavesdrop on the communication between MO and the child buyer. However, the deployment of PKI in the system (Section 3.2.2) ensures mutual authentication between entities (MO , B_i , proxy) and thus, the communication between the entities is authenticated and the possibility of eavesdropping can be defied.
4. **Database attack:** An attacker cannot obtain the fingerprint stored at MO 's end, since only MO has an access to transaction database. However, it may be possible for the attacker to try to eavesdrop on the communication between T_A and MO to obtain the fingerprint. This attack is resisted due to two facts: 1) the fingerprint transferred from T_A to MO is permuted with a random permutation key σ and encrypted with the public key of T_A , and 2) the communication between MO and T_A is authenticated due to the existence of a PKI in the system.
5. **Copyright protection:** In order to prevent a guilty buyer from repudiating an act of illegal re-distribution, it

is necessary that the fingerprint embedded in the buyer's copy and its corresponding permuted and encrypted fingerprint recorded by MO be identical. However, there are two possible ways by which the buyer could deny his/her wrongful act, namely 1) if the fingerprint leaks during the execution of the traitor-tracing protocol; and 2) if fake segments are reported by one or more proxies to T_A in Protocol 1.

The first possibility can be disregarded since T_A is an entity that is trusted by all the parties of the system (as described in Section 3.2.2). Thus, a buyer cannot accuse T_A of leaking the fingerprint in the execution of any protocol. For security against the second scenario, the proposed scheme adopts the same approach as mentioned in Megías (2015), i.e. the encrypted fragments of the content and the encrypted embedded segments are both signed. In this way, T_A could randomly request the verification of the signatures of the set of contiguous segments reported by a proxy. If the signature verification failed, the proxy would be accused of malicious behavior.

6. **Buyer's privacy:** In order to protect buyer's privacy from a possible coalition of the transaction monitor and the merchant, or similarly, one of the proxies chosen by the buyer and the merchant, we can use the same approach as the scheme of Megías (2015). As discussed in (Megías, 2015), for the first case, the proxies can encrypt the pseudonyms of the buyers with the public key of T_A , so that the coalition of Me with MO cannot break a buyer's privacy. In the second case, the idea of encrypting the buyer's pseudonym with the public key of T_A would not work, since a malicious proxy could decide not to encrypt the pseudonym and form a coalition with Me to break the privacy of a buyer. However, Me would not be interested in breaking the privacy of his/her clients, since privacy is considered to be one of the clear advantages of the proposed distribution system. Nevertheless, in case Me acts maliciously and forms a coalition with a proxy, this possibility can be circumvented by adopting the approach proposed in (Qureshi et al., 2015), where a trusted party, called the certification authority CA_R , is responsible of issuing certificates to the buyer. CA_R will help each buyer in the generation of his/her pseudonym by providing a secret number. The certificate is used to prove that the pseudonym is correctly registered to CA_R and only CA_R knows about the real identity of the buyer. We can use the same approach here to prevent a malicious Me from breaking a buyer's privacy. Instead of having Me to manage the buyers' database, CA_R could be introduced in the system to authenticate a buyer at time of registration. Once authenticated, CA_R would generate a random number and share it with the buyer for the the generation of a pseudonym. Accordingly, the real identity of the guilty buyer would be disclosed by CA_R in the traitor-tracing protocols (Protocols 3 and 4), instead of Me .

Finally, a buyer's privacy could be threatened by the communication between child and parent through a unique proxy. As discussed by (Megías, 2015), this scenario can be evaded by enforcing a child buyer to select a chain of three or more proxies for each set of fragments, such that only two of the proxies of the chain would have access to pseudonyms (either the parents' or the child's).

5.2. Theoretical and simulation results for the anti-collusion mechanism

In this section, we present the theoretical and simulation results of the fingerprinting scheme against different types of collusion attacks.

5.2.1. Theoretical analysis of the traitor-tracing protocol

This section presents a theoretical analysis of the calculation of the fingerprints's scores in the traitor-tracing protocol (Protocol 4).

In both the standard and the modified versions of Nuida et al.'s traitor-tracing mechanism, the (bitwise) score $s_i^{(k)}$ of the i -th buyer (B_i), for $k = 1, \dots, l$, is computed using an accusation function w , which depends on a discrete bias distribution function P , which is a sequence of random values $0 < p^{(k)} < 1$. The total score s_i of B_i is obtained by taking the average of all bitwise scores for the corresponding fingerprint f_i . The values of w decrease as P increases. This implies that the higher the probability of the symbol at this position, the smaller positive amount will be contributed to the total score, and vice versa. According to the marking assumption, a colluded fingerprint consists of the combination of detectable and undetectable positions. The undetectable positions are those for which the embedded bit is the same for all colluders. On the other hand, the bits of the detectable positions are not identical for all colluders. The colluded fingerprint is formed by copying the bit values for all the undetectable positions and "random values" ('0's, '1's or erasures) in the detectable positions. The values of the undetectable positions are not really random, since they depend on the specific collusion attack (minimum, maximum or average, for example). The colluded fingerprint is then used as an input in the traitor-tracing protocol (Protocol 4) to identify a set of colluders.

It can be seen, in Algorithms 1 and 2, that $s_i^{(k)}$ results in a positive value when the (permuted and encrypted) bits of the colluded and tested fingerprints are identical, and negative in case of a bit difference. Thus, it may be inferred from this calculation criterion that the bitwise scores of the colluders must result in all positive values and, similarly, that the bitwise scores of the innocent buyers must result in all negative values. However, this statement cannot hold true, since the colluded fingerprint is generated assuming the marking assumption, i.e. it consists of undetectable and detectable bits. For colluders, all undetectable bits will provide a positive score with the tested fingerprint, whereas the detectable bits can provide positive or negative scores. Similarly, for non-colluders, some of the bits of the fingerprint can, by chance, be identical to that of the colluded fingerprint, contributing with a positive score. The remaining bits will contribute with a negative score. Thus, in the score computation for a colluder or an innocent buyer, the bitwise scores can result in both positive and negative values. However, for a colluder, a higher number of positive bitwise scores would contribute to its total score (since Nuida et al.'s traitor-tracing algorithm outputs the guilty buyers with the highest scores). Similarly, the positive values due to the marking assumption can result in a positive score for an innocent buyer, but this score would be comparatively much smaller than that of the colluder (as evident from the simulation results presented in Section 5.2.2). Therefore, it can be concluded that, for colluders, the number of positive bitwise scores must be greater than the number of positive bitwise scores for innocent buyers. According to this discussion, a global threshold can be defined to determine whether the codeword belongs to a colluder or an

innocent buyer.

The above discussion holds when the whole fingerprint is a codeword of Nuida et al.'s codes. However, in the proposed work, the fingerprint is generated segment-wise by embedding different codewords of Nuida et al.'s codes in different positions of the fingerprint. The following analysis shows how the traitor-tracing algorithm also works segment-wise, as in the proposed method, since the following features hold:

1. Each segment $g_j, j = 1, \dots, n_s$ of a fingerprint is a codeword of the Nuida et al.'s codes resistant against $c \leq c_0$ colluders.
2. For each segment position, there are M different values, with M being a small number (the number of seed buyers). Hence, the segments will be relatively short codewords¹.
3. The number of seed buyers must be larger than the collusion resistant capacity of the codes: $M > c_0$ (for example, we can choose $M \geq 2c_0$).
4. If the number of colluders c satisfies $c \leq c_0$, all the segments g_j of all the colluders will contribute with a high score \mathcal{S}_j such that $T_{\min} \leq \mathcal{S}_j \leq T_{\max}$, where T_{\min} and T_{\max} are some thresholds. The segment score \mathcal{S}_j will be the average of the bitwise scores obtained for all bits in that segment.
5. Hence, for a colluder, the score for each segment will be T_a on average, for some T_a such that $T_{\min} \leq T_a \leq T_{\max}$.
6. The total number of segments available for a position is M and, thus, a non-colluder has probability c/M of each segment being equal to the same segment of one of the colluders. These segments will contribute with high scores \mathcal{S}_j such that $T_{\min} \leq \mathcal{S}_j \leq T_{\max}$, which are T_a on average.
7. On the other hand, for a non-colluder, the remaining segments contribute with a low score $\mathcal{S}_j \leq t_{\max}$, where t_{\max} is a threshold such that $t_{\max} < T_{\min}$. The probability of a segment being different to those of all colluders is $(M - c)/M$. These scores will be typically negative.

Under these conditions, we can make the following approximations:

1. The score for all colluders will be above T_{\min} always, and T_a on average, since all of their segments produce such positive scores.
2. For non-colluders, there will be, on average:
 - $(c/M) \cdot n_s$ segments contributing with scores above T_{\min} , and T_a on average.
 - $(M - c)/M \cdot n_s$ segments contributing with small scores below t_{\max} , usually negative on average.

¹The same codebook can be used for all segment positions of the fingerprint, or a different codebook can be generated for each position. This makes no difference in the final result.

Hence, the scores of non-colluders will be typically below $(c/M)T_a \leq (c_0/M)T_a$. If, as suggested, we choose the number of seed buyers such that $M \geq 2c_0$, then we have that the scores of non-colluders will be typically below

$$\frac{c_0}{M}T_a \leq \frac{c_0}{2c_0}T_a = 0.5T_a,$$

and clearly distinguishable from those of colluders, which will be around T_a . This is illustrated by means of simulations in the next section.

In this situation we can define a global threshold (\mathcal{T}) to distinguish between non-colluders and colluders. Given that $M \geq 2c_0$, a threshold around $0.75T_a$ will be sufficient to separate colluders (whose scores will be around T_a) from non-colluders (whose scores will be typically below $0.5T_a$). Even if a non-colluder happens to provide, by chance, a score somewhat larger than $0.5T_a$, it will still be far from $0.75T_a$. Hence, we can use $\mathcal{T} = 0.75T_a$ as a global threshold to discriminate between colluders and innocent buyers.

5.2.2. Simulation results

This section presents simulated experiments results to illustrate the security of the proposed fingerprinting scheme against the linear (averaging) and non-linear (minimum and maximum) collusion attacks described in Section 3.3.2. In all the simulations presented in this section, the recombined fingerprints are 58,312-bit sequences, divided into 74 segments of 788 bits each. The number of seed buyers was assumed to be $M = 10$. For the seed buyers, the segment codewords were generated using the Nuida et al.'s fingerprint generation algorithm (Nuida et al., 2007) with the following inputs: 10 different codewords for segment (which must be equal to the number of seed buyers), $c_0 = 4$ and $\varepsilon = 10^{-3}$. Including the seed buyers (first generation), \mathcal{K} generations of buyers were produced using an exponential growth approach (Megías and Domingo-Ferrer, 2014). For non-seed buyers, the fingerprints were generated using the recombination approach, choosing between two and four parents per buyer at random from all the previous generations, including the seed buyers. This implies that the average number of parents per non-seed buyer was three.

We have performed the experiments for $\mathcal{K} = 10$ generations, which results in a total population of $N = M \cdot 2^{\mathcal{K}-1} = 10 \cdot 2^9 = 5,120$ buyers (including the seed buyers). The fingerprints stored in MO 's database were encrypted using the 1024-bit Paillier cryptosystem. With these settings, 1,000 random bit collusions were generated for each attack (average, maximum and minimum) with the number of colluders restricted to $c = 4$. For each colluded copy, the traitor-tracing protocol with collusion (detailed in Section 3.6) was applied.

In the following, we present the simulations results for these linear and non-linear collusion attacks:

1. **Average attack:** We generated 1,000 random collusions by taking the average of the corresponding bits of the fingerprints of the four colluders. Then, the traitor-tracing protocol (Protocol 4) was carried out by T_A and MO to output the pseudonyms of the colluders. In the traitor-tracing protocol, each colluded fingerprint was tested with all the buyers' fingerprints stored at MO 's end, and the corresponding scores were calculated in the

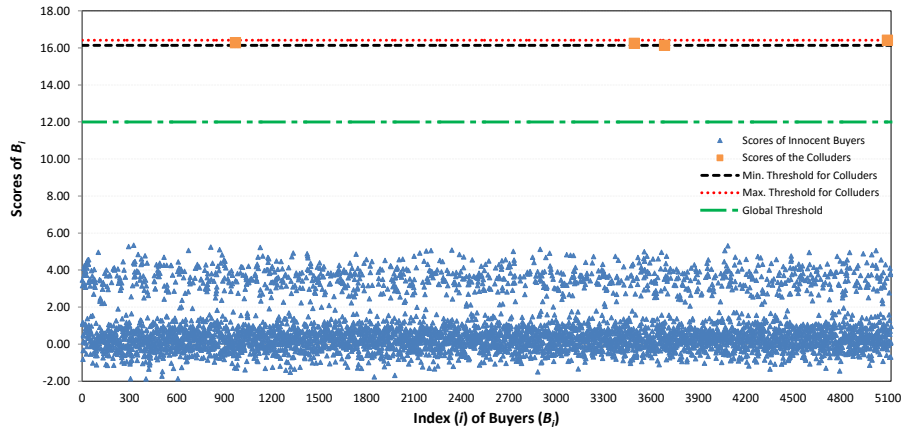

(a) Average attack: colluders' set = $\{B_{970}, B_{3495}, B_{3686}, B_{5097}\}$

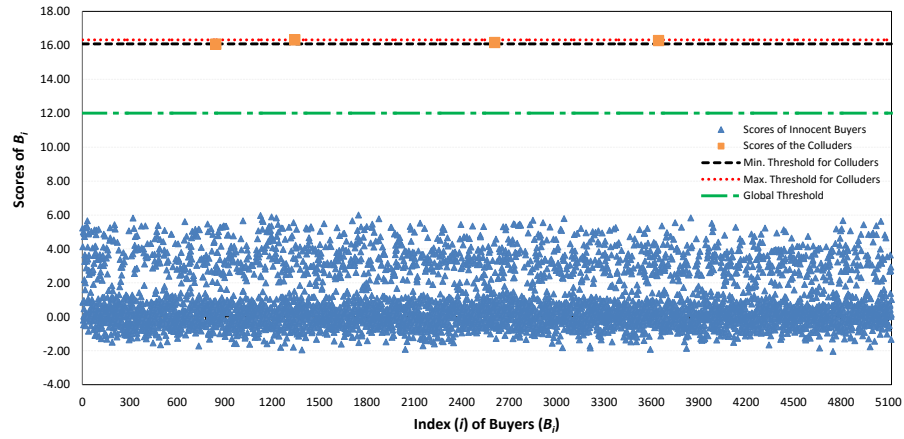

(b) Minimum attack: colluders' set = $\{B_{844}, B_{1353}, B_{2609}, B_{3654}\}$

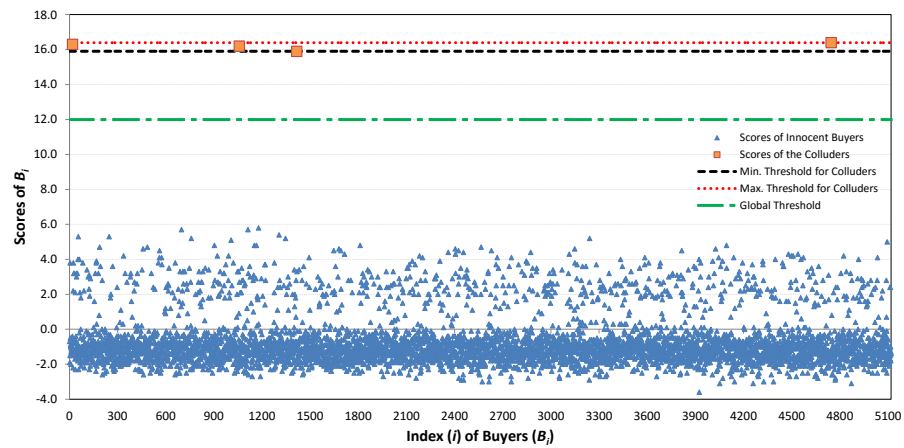

(c) Maximum attack: colluders' set = $\{B_{19}, B_{1058}, B_{1416}, B_{4746}\}$

Figure 5: Scores of buyers for collusion attacks (four colluders)

encrypted domain. The protocol provided the pseudonyms of the colluders as the buyers with the highest scores, whereas innocent buyers yielded much lower scores. In all 1,000 cases, the four colluders were successfully identified and no innocent buyer was wrongfully accused.

The collusion resistance of Protocol 4 under the average attack is illustrated in Figure 5a for one of those 1,000 simulations. As it can be seen, the four colluders can be easily identified with a score in the range [16.28, 16.42], whereas the remaining 5,116 buyers provided scores in the range [-2.00, 5.30]. Since the score of the colluders was around 16 (in fact higher), we could safely set the global threshold to be $\mathcal{T} = 0.75 \cdot 16 = 12$ to discriminate between colluders and innocent buyers with no false positives or negatives.

2. **Minimum attack:** Another 1,000 simulations were carried out for the minimum attack with analogous results. Figure 5b illustrates the collusion resistance of the fingerprinting scheme against the minimum attack for one of those 1,000 simulations. Through the traitor-tracing protocol, the buyers with scores between [16.08, 16.28] were identified as colluders, whereas, the buyers with scores in the range [-2.04, 5.97] were output as innocent buyers. As in the averaging attack, the minimum attack yielded 100% colluders detection rate with 0% false accusation rate. The same global threshold $\mathcal{T} = 12$ was used.
3. **Maximum attack:** Again, under this attack, 1,000 random colluded fingerprints were formed by taking the maximum of the corresponding bits of the fingerprints of four randomly selected colluders, with the same performance as in the previous collusion attacks. Figure 5c shows the results obtained for one of those 1,000 simulations, and it can be seen that all four colluders were successfully identified with a score in [15.90, 16.40], whereas the innocent buyers provided scores in the range [-4.00, 5.80]. The same global threshold used in the other two collusion attacks, $\mathcal{T} = 12$, provided the correct identification of all colluders with no false positives or negatives.

In Figure 5, it can be seen that T_{\min} and T_{\max} vary in different experiments. Values around 16 for the scores of colluders are usual, but some other values were obtained in some simulations. The range for colluders' scores considering the three attacks in the 1,000 simulations was [14.03, 23.05]. Similarly, the scores for non-colluders varied in different simulations, but they were always in the range [-4.00, 5.97]. This confirms that the global threshold $\mathcal{T} = 12$ works for the $1,000 \times 3$ simulated collusions with no false positives or negatives. The scores of the two sets of colluders which lead to the maximum (23.05) and minimum (14.03) values obtained after 1,000 simulations are depicted in Figure 6.

It is worth pointing out that more than four colluders could be identified through Protocol 4 if the fingerprint were generated with $c_0 > 4$ and the number of seed buyers was adjusted accordingly, so as to satisfy $M \geq 2c_0$. However, the larger the collusion resistance of the code, the longer the codewords become and, hence, the longer the fingerprint results. An increase in the length l of the fingerprint requires embedding more bits in the content and the embedding algorithm must provide more capacity. Embedding more bits will have an effect on the quality of the content since,

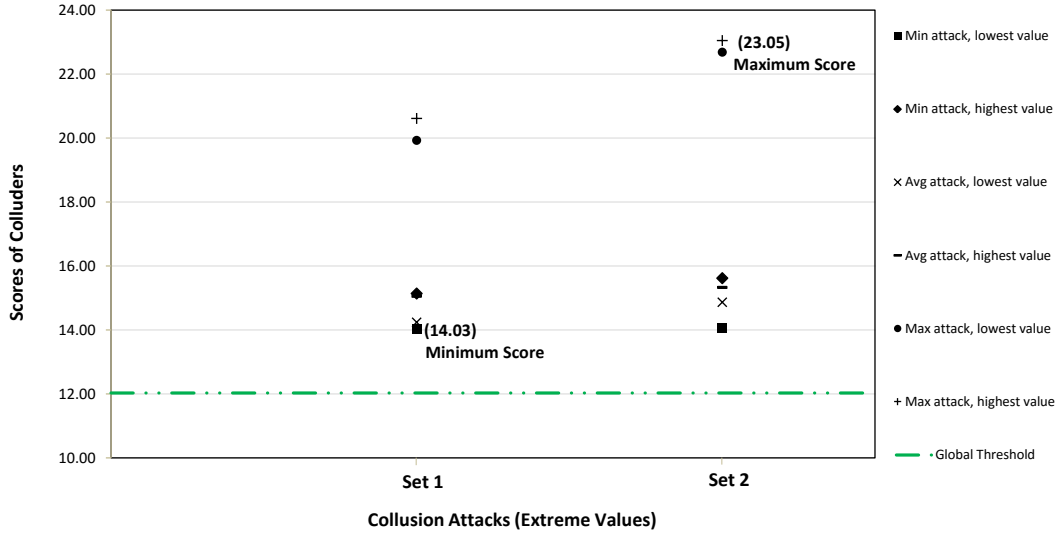

Figure 6: Extreme scores obtained for the colluders

typically, the perceptual quality decreases when capacity increases. Thus, the value c_0 shall be selected taking into account the trade-off between collusion resistance and perceptual quality.

5.3. Performance analysis

This section presents a performance analysis of the proposed system in terms of the computational (especially cryptographic) effort required by the entities and the communication cost. To show the performance of the system, the experiments were carried out in Matlab 7.0 and Java on the audio file “LoopyMusic”, on a workstation equipped with an Intel i-7 processor at 3.4 GHz and 8 GB of RAM. The distribution protocol is implemented in Matlab 7.0, except the public-key (1024-bit Paillier) encryption of the content that is implemented in the Java programming language. The details of the “LoopyMusic” audio file are presented in Table 3.

Table 3: Details of “LoopyMusic”

Details	Loopy Music
Time Length (min:sec)	00:10
File Size (MB)	0.89
Format	WAV
Bits per Sample	16
Sample Rate (Hz)	44100
Channel Mode	Mono

The bootstrapping of the proposed system is initialized by Me , who provides the multimedia content (“LoopyMu-

sic”) to the *MO* to carry out the remaining part of the bootstrapping process. *MO* is responsible for the the generation of $M = 10$ different Nuida et al. (2007)’s c -secure codes and $M = 10$ seed copies of “LoopyMusic”. In each seed copy, the fingerprint codes of length $l = 58,312$ bits that provide resistance against $c = 4$ colluders, are embedded into 74 segments (with a codeword of 788 bits per segment) of the audio content using the robust, secure and transparent audio watermarking algorithm proposed by Wang et al. (2013). In addition, for each seed copy, *MO* encrypts each segment embedded into the fragments of “LoopyMusic” using the public key of the tracing authority. Table 4 presents the overhead of *MO* for bootstrapping of the system.

Table 4: Bootstrapping overhead

File Name	CPU Time (secs)				
	Fingerprint generation	Embedding (Generation of seed copies)	Communication with seed buyers	Public-key encryption of segments	Total Time
LoopyMusic	0.33	1.65	0.05	8.59	10.62

The overhead of *MO* for the generation of 10 seed copies is one-time cost only (it could be performed by *MO* in an offline mode). Once the system is bootstrapped, the child buyers obtain their fingerprinted copies of the content by recombining fragments of the content received from the parent buyers. From Table 4, it can be seen that 1024-bit public-key encryption of the segments contributes to most of the computational costs. It is pertinent to mention that the only overhead (a few seconds depending on the size of the file) for the *Me* is the transfer of the original content to *MO* in the bootstrapping process.

Tables 5, 6, 7 and 8 show the overhead costs calculated for each party (parent buyer, *MO*, proxy and child buyer) involved in the anonymous distribution of the fragments of “LoopyMusic” between parent and child buyers. We have calculated the costs for a scenario where a child buyer requests a single copy of “LoopyMusic” from the merchant. Five proxies are used to transfer the fragments of the content from at least three parent buyers (minimum requirement is two parent buyers).

Table 5: Overhead costs of a parent buyer

File Name	CPU Time (secs)				
	Session key and Random number generation	Communication with <i>MO</i>	Symmetric encryption of fragments	Communication with proxies	Total Time
LoopyMusic	0.02	0.003	3.40	0.30	3.72

Table 5 presents the overhead costs of a parent buyer equal to 3.72 seconds, which includes session key (K) and random number (r) generation, communication with *MO* –transfer of (r, K) –, symmetric encryption of the fragments

requested by each proxy using K , and communication with each proxy (transfer of r and encrypted fragments). All three parent buyers involved in anonymous content transfer execute the assigned functions in parallel without interfering with each other and, thus resulting in the total overhead equal to 3.72 seconds instead of 11.16 seconds.

Table 6: Overhead costs of MO

File Name	CPU Time (secs)
	Communication with child buyer
LoopyMusic	0.09

In Table 6, we can see that MO takes fraction of a second to send the corresponding K to the child buyer.

Table 7: Overhead costs of a proxy

File Name	CPU Time (secs)				Total Time
	Communication with child buyer	Concatenation of encrypted fragments	Public-key encryption of concatenated fragments	Communication with T_A	
LoopyMusic	0.30	0.03	0.65	0.05	1.03

The proxies are solely responsible for transferring the encrypted fragments from the parent buyer to the child buyer in the anonymous distribution protocol. Table 7 presents the overhead cost of five proxies equal to 1.03 seconds that include communication with the child buyer (transfer of r and encrypted fragments), concatenation of the encrypted fragments, encryption of the concatenated fragments with the public key of T_A , and transfer of the encrypted fragments to T_A . Similar to parent buyers, all proxies execute the assigned functions in parallel, thus reducing the overall distribution time. Thus, it can be easily seen that the overhead contributed by proxies in the distribution protocol is small.

Table 8: Overhead costs of a child buyer

File Name	CPU Time (secs)		
	Communication with MO	Symmetric decryption of content	Total Time
LoopyMusic	0.001	1.10	1.10

In the distribution protocol, a child buyer performs two tasks, i.e. communication with MO (transfer of r to MO in order to receive the corresponding K) and decryption of the received encrypted fragments with K . From Table 8, it can be seen that it hardly takes a second for a child buyer to decrypt the received fragments.

From the overheads presented in Tables 5, 6, 7 and 8, it can be concluded that the anonymous content transfer between parent buyers and a child buyer is executed in 5.94 seconds ($3.72 + 0.09 + 1.03 + 1.10$). This is the overall time required for transferring the file for each buyer.

5.3.1. Comparative analysis with Qureshi et al. (2016)

This section carries out a comparative analysis of the proposed system with PSUM presented in (Qureshi et al., 2016). The comparison focuses on the performance of the systems in terms of computational and communication costs. The reason for selecting PSUM for comparison is the fact that PSUM is more efficient than the systems proposed by Megías and Domingo-Ferrer (2013); Megías (2015) and Qureshi et al. (2015) (as evident from the analysis presented in Table 2 in Section 4.2).

Table 9 shows the computation time of bootstrapping the system using the “LoopyMusic” audio file for the proposed system and PSUM (Qureshi et al., 2016).

Table 9: Comparison of bootstrapping time

File Name	Bootstrapping performed by <i>MO</i>				
	CPU Time in secs for the proposed system				
	Functions				
	Fingerprint generation	Embedding	Communication with seed buyers	Public-key encryption	Total Time
LoopyMusic	0.33	1.65	0.05	8.59	10.62
File Name	Bootstrapping performed by <i>Me</i>				
	CPU Time in secs for PSUM				
	Function				
	DWT+Embedding				Total Time
LoopyMusic	0.19				0.19

The last column in Table 9 contains the total CPU time of bootstrapping process for both the systems. Please note that bootstrapping is carried out by the monitor in the proposed system, but by the merchant in PSUM. It can be seen that the computational cost of PSUM is comparatively shorter than that of the proposed system. In the proposed system, the public-key encryption of the content is the most expensive operation. However, it must be taken into account that bootstrapping only occurs once in the proposed system, before the first transaction to purchase the content.

Table 10: Comparison of communication time

File Name	Anonymous content transfer between parent and child buyers				
	CPU Time in secs for the proposed system				
	Functions				
	Overhead of <i>Me</i>	Overhead of buyer (parent+child)	Overhead of <i>MO</i>	Overhead of proxy	Total Time
LoopyMusic	0.00	4.82	0.09	1.03	5.94
File Name	Anonymous Content transfer between a merchant and a buyer				
	CPU Time in secs for PSUM				
	Functions				
	Overhead of <i>Me</i>	Overhead of a buyer	Overhead of <i>MO</i>	Overhead of Proxy	Total Time
LoopyMusic	2.19	3.35	6.33	2.51	14.38

In Table 10, we compare the communication time of proposed system for “LoopyMusic” with the published response time results of Qureshi et al. (2016)’s PSUM. In PSUM, the communication time is calculated as the time taken in base file (a small size file in which approximation coefficients are embedded with the fingerprint) distribution from the merchant to the buyer through proxy peers in the presence of the *MO*, whereas, in the proposed system, the communication time is calculated as the time taken in file distribution from at least three parent buyers to the child buyer through proxy peers.

In PSUM, the overhead cost of *Me* (2.19 seconds) includes decryption of the session and permutation keys, permutation of the approximation coefficients and symmetric encryption of the permuted coefficients. This overhead cost is linear to the number of file requests received from the buyer. If *Me* receives multiple requests of the same content from different buyers, the overhead cost would increase linearly. In the proposed system, the overhead of *Me* is zero since it is not involved in the file distribution protocol, thus providing **the most practical and efficient content distribution solution to the merchant**. The overhead of *Me* is zero in the proposed system since it is not involved in the file distribution protocol (*Me* participates only in the bootstrapping process) between a parent and a child buyer. The overhead cost of a buyer (3.35 seconds) in PSUM includes generation of an anonymous key pair, a certificate, permutation and session keys, and file reconstruction (symmetric decryption, inverse permutation and DWT, and conversion to original audio format). On the other hand, in the proposed system, the overhead costs of a parent and a child buyer contributes to the overall buyer overhead, in which the child buyer performs its tasks in 1.10 seconds and the parent buyer executes its operations in 3.72 seconds. In PSUM, the increased overhead of *MO* is due to the fact it is responsible for generation of 10^4 *c*-secure codewords (which takes 6.01 seconds and contributes highly to the overall overhead), fingerprint segmentation and permutation (0.02 seconds) and communication with the merchant, the buyer and the proxies (0.30 seconds). The overhead of the *MO* is minimal (0.09 seconds) in the proposed system. For the

proxy peers of PSUM, the overhead cost is equal to 2.51 seconds, which includes transferring of the encrypted and permuted coefficients from the merchant to the buyer, while, the proxy peers in the proposed system takes hardly a second to perform the assigned functions (as shown in Table 7).

It can be seen from the last column of Table 10, that the total file distribution time in the proposed system (5.94 seconds) is comparatively shorter than the distribution time using the scheme of Qureshi et al. (2016) (14.38 seconds). Thus, it is evident, from the results shown in Table 10, that the proposed distribution protocol of the proposed system permits to **reduce the communicational burdens of secure fingerprinted content distribution**.

6. Conclusions

This paper presents a novel P2P content distribution system with copyright and privacy protection to the merchant and the end users, respectively. The proposed system exploits the recombined fingerprints idea suggested in (Megías and Domingo-Ferrer, 2014; Megías, 2015), which was inspired from the DNA sequences of the living beings. This strategy, which resembles the approach taken in genetic algorithms, is exploited here for multimedia distribution. However, the existing systems based on the recombination approach exhibit some shortcomings that make them inefficient and impractical under certain circumstances. To overcome the drawbacks of prior art, the first contribution of this paper is the use of state-of-the-art Nuida et al.'s (2007) codes **at segment level**. Nuida et al.'s codes are shown to work in segment-wise fashion for the first time, in such a way that each segment of the fingerprint is a codeword. The small number of seed buyers makes it possible to obtain short codewords for each segment, resulting in remarkably short fingerprints, and prevents the two-layer encoding required by the previous recombination-based proposals. Also, the proxies in the proposed system do not need to communicate with each other in the presence of the monitor to construct a valid fingerprint at hash level, since the requirement for a hash of the fingerprint has been completely removed in the proposed system. In addition, encryption is applied to the permuted bits of the fingerprint using the public key of the authority, which is a trusted party. For the secure identification of the colluder(s), the second contribution of the paper is a novel traitor-tracing system that performs **tracing in the encrypted domain**. The proposed traitor-tracing protocol does not require decrypting any single segment of the fingerprint and thus, preserves buyer frameproofness. The security analysis, the simulation results and the performance evaluation show that the proposed system provides a secure, scalable, privacy-preserving, collusion-resistant, anonymous and efficient content distribution mechanism for P2P systems with low computation costs.

Future research should be directed to (1) a real-world implementation of the proposed system for a real P2P application, e.g. as a plug-in that enables the copyright and privacy protection features in a P2P system; and (2) the measurement of some metrics at the application layer, such as bandwidth and latency, with the real-world implementation, in order to evaluate the impact of the proposed content distribution protocol on the user experience.

Acknowledgment

This work was partly funded by the Spanish Government through grants TIN2011-27076-C03-02 “CO-PRIVACY” and TIN2014-57364-C2-2-R “SMARTGLACIS”.

References

- Biehl, I., Meyer, B., 2002. Cryptographic methods for collusion-secure fingerprinting of digital data. *Computers and Electrical Engineering* 28 (1), 59–75.
- Boneh, D., Shaw, J., 1999. Collusion secure fingerprinting for digital data. *IEEE Transactions on Information Theory* 44 (5), 1897–1905.
- Camenisch, J., 2000. Anonymous fingerprinting with group signatures. In: *ASIACRYPT 2000*. Vol. 1976 of *Lecture Notes in Computer Science*. Springer, pp. 415–428.
- Chae, C.-J., Shin, Y., Choi, K., Kim, K.-B., Choi, K.-N., 2016. A privacy data leakage prevention method in p2p networks. *Peer-to-Peer Networking and Applications* 9 (3), 508–519.
- Charpentier, A., Fontaine, C., Furon, T., Cox, I., 2011. An asymmetric fingerprinting scheme based on tardo codes. In: *Proc. Int. Conf. Inf. Hiding. IH'11*. pp. 43–58.
- Chaum, D. L., 1981. Untraceable electronic mail, return addresses, and digital pseudonyms. *Communications of the ACM* 24 (2), 84–90.
- Choi, J. G., Sakurai, K., Park, J. H., 2003. Does it need trusted third party? design of buyer-seller watermarking protocol without trusted third party. In: *Applied Cryptography and Network Security*. Vol. 2846 of *Lecture Notes in Computer Science*. Springer, pp. 265–279.
- Chor, B., Fiat, A., Naor, M., Pinkas, B., 2000. Tracing traitors. *IEEE Transactions on Information Theory* 46 (3), 893–910.
- Cox, I. J., Kilian, J., Leighton, T., Shamoon, T., 1997. Secure spread spectrum watermarking for multimedia. *IEEE Transactions on Image Processing* 6 (12), 1673–1687.
- Deng, M., Preneel, B., 2008. On secure and anonymous buyer-seller watermarking protocol. In: *Third International Conference on Internet and Web Applications and Services, ICIW '08*. IEEE, pp. 524–529.
- Domingo-Ferrer, J., 2011. Rational enforcement of digital oblivion. In: *Fourth International Workshop on Privacy and Anonymity in the Information Society*. ACM, pp. 2:1–2:8.
- Domingo-Ferrer, J., Herrera-Joancomartí, J., 2000. Short collusion-secure fingerprints based on dual binary hamming codes. *Electronics Letters* 36 (20), 1697–1699.
- Domingo-Ferrer, J., Megías, D., 2013. Distributed multicast of fingerprinted content based on a rational peer-to-peer community. *Computer Communications* 36 (5), 542–550.
- DRM, M., 2008. Microsoft drm.
URL <http://www.wmlicense.smdisp.net/wmdrmcompliance/WindowsMediaDRM10fordevices/>
- Fallahpour, M., Megías, D., 2010. DWT-based high capacity audio watermarking. *IEICE Transactions on Fundamentals of Electronics, Communications and Computer Sciences* E93-A (1), 331–335.
- Hu, D., Li, Q., 2010. Bandwidth efficient asymmetric fingerprinting based on one-out-of-two oblivious transfer. *International Journal of Information and Computer Security* 4 (2), 152–163.
- Isdal, T., Piatek, M., Krishnamurthy, A., Anderson, T., 2010. Privacy-preserving p2p data sharing with oneswarm. In: *Proceedings of the ACM SIGCOMM 2010 Conference*. pp. 111–122.
- iTunes, 2001. Apple itunes.
URL <http://www.apple.com/itunes/>
- Kuribayashi, M., Tanaka, H., 2005. Fingerprinting protocol for images based on additive homomorphic property. *IEEE Transactions on Image Processing* 14 (12), 2129–2139.
- Leelavathy, N., Prasad, E. V., Kumar, S. S., Mohan, B. C., 2011. Oblivious image watermarking in discrete multiwavelet domain using QIMM. *Journal of Multimedia* 6 (4), 359–368.

- Li, X., Krishnan, S., Ngok-Wah, M., 2010. A wavelet-pca-based fingerprinting scheme for peer-to-peer video file sharing. *IEEE Trans. Inf. Forensics Security* 5 (3), 365–373.
- Megías, D., 2015. Improved privacy-preserving P2P multimedia distribution based on recombined fingerprints. *IEEE Trans. Dependable and Sec. Comput.* 12 (2), 179–189.
- Megías, D., Domingo-Ferrer, J., 2013. DNA-inspired anonymous fingerprinting for efficient peer-to-peer content distribution. In: *Proceedings of IEEE Congress on Evolutionary Computation. CEC'13*. pp. 2376–2383.
- Megías, D., Domingo-Ferrer, J., 2014. Privacy-aware peer-to-peer content distribution using automatically recombined fingerprints. *Multimedia Systems* 20 (2), 105–125.
- Memon, N. D., Wong, P. W., 2001. A buyer-seller watermarking protocol. *IEEE Transactions on Image Processing* 10 (4), 643–649.
- Nuida, K., Fujitsu, S., Hagiwara, M., Kitagawa, T., Watanabe, H., Ogawa, K., Imai, H., 2007. An improvement of tardos's collusion-secure fingerprinting codes with very short lengths. In: *Proceedings of the 17th International Conference on Applied Algebra, Algebraic Algorithms and Error-correcting Codes. AAEECC'07*. Springer, pp. 80–89.
- Paillier, P., 1999. Public-key cryptosystems based on composite degree residuosity classes. In: *Proceedings of the 17th International Conference on Theory and Application of Cryptographic Techniques. EUROCRYPT'99*. Springer, pp. 223–238.
- Pehlivanoglu, S., 2013. An asymmetric fingerprinting code for collusion-resistant buyer-seller watermarking. In: *Proc. MMsec'13*. pp. 35–44.
- Pfitzmann, B., Sadeghi, A. R., 1999. Coin-based anonymous fingerprinting. In: *Proc. Int. Conf. Theory and Application of Cryptographic Techniques. EUROCRYPT'99*. pp. 150–164.
- Pfitzmann, B., Schunter, M., 1996. Asymmetric fingerprinting. In: *Proc. Int. Conf. Theory and Application of Cryptographic Techniques. EUROCRYPT'96*. pp. 84–95.
- Pfitzmann, B., Waidner, M., 1997. Anonymous fingerprinting. In: *Proc. Int. Conf. Theory and Application of Cryptographic Techniques. EUROCRYPT'97*. pp. 88–102.
- Prins, J. P., Erkin, Z., Lagendijk, R. L., 2007. Anonymous fingerprinting with robust qim watermarking techniques. *EURASIP Journal on Information Security* 2007 (20), 1–7.
- Qian, L., Nahrstedt, K., 1998. Watermarking schemes and protocols for protecting rightful ownership and customers rights. *Journal of Visual Communication and Image Representation* 9 (3), 194–210.
- Qureshi, A., Megías, D., Rifà-Pous, H., 2014. Secure and anonymous multimedia content distribution in peer-to-peer networks. In: *Proceedings of the 6th International Conference on Advances in Multimedia*. pp. 91–96.
- Qureshi, A., Megías, D., Rifà-Pous, H., February 2015. Framework for preserving security and privacy in peer-to-peer content distribution systems. *Expert Systems with Applications* 42 (3), 1391–1408.
- Qureshi, A., Megías, D., Rifà-Pous, H., 2016. PSUM: Peer-to-peer multimedia content distribution using collusion-resistant fingerprinting. *Journal of Network and Computer Applications* 66, 180–197.
- Rial, A., Deng, M., Bianchi, T., Piva, A., Preneel, B., 2010. A provably secure anonymous buyer-seller watermarking protocol. *IEEE Transactions on Information Forensics and Security* 5 (4), 920–931.
- Sebé, F., Domingo-Ferrer, J., 2003. Collusion-secure and cost-effective detection of unlawful multimedia redistribution. *IEEE Trans. Inf. Theory* 33 (3), 382–389.
- Sun, M. K., Iaih, C. S., Yen, H. Y., Kuo, J. R., 2009. A ticket based digital rights management model. In: *Proceedings of 6th IEEE Consumer Communications and Networking Conference*. pp. 1–5.
- Tardos, G., 2003. Optimal probabilistic fingerprint codes. In: *Proceedings of the Thirty-fifth Annual ACM Symposium on Theory of Computing. STOC'03*. ACM, pp. 116–125.
- Tsujiro, N., Okabe, Y., 2015. A traceable and pseudonymous p2p information distribution system. In: *Proceedings of the 39th IEEE Annual International Computers, Software and Applications Conference*. pp. 67–72.
- Wang, J., Wang, Y., Xu, S., 2012. A novel anonymous authentication scheme for ad-hoc networks. *Advanced Engineering Forum* 6-7, 913–918.
- Wang, X., Wang, P., Zhang, P., Xu, S., Yang, H., 2013. A norm-space, adaptive, and blind audio watermarking algorithm by discrete wavelet

transform. *Signal Processing* 93 (4), 913–922.

Win, L. L., Thomas, T., Emmanuel, S., 2011. A privacy-preserving content distribution mechanism for drm without trusted third parties. In: *Proceedings of IEEE International Conference on Multimedia and Expo*. pp. 1–6.

Ye, C., Xiong, Z., Ding, Y., Zhang, X., Wang, G., Xu, F., 2016. Secure multimedia content distribution for m2m communication. *International Journal of Security and Its Applications* 10 (4), 279–288.