

Switched control for quantized feedback systems: invariance and limit cycles analysis

Alessandro Vittorio Papadopoulos, *Member, IEEE*, Federico Terraneo, Alberto Leva, *Member, IEEE*, Maria Prandini, *Senior Member, IEEE*

Abstract—We study feedback control for discrete-time linear time-invariant systems in presence of quantization both in the control action and in the measurement of the controlled variable. While in some application the quantization effects can be neglected, when high-precision control is needed, quantization has to be explicitly accounted for in control design. In this paper we propose a switched control solution for minimizing the effect of quantization of both the control and controlled variables in the case of a simple integrator with unitary delay, a model that is quite common in the computing systems domain. We show that the switched solution outperforms the one without switching, designed by neglecting quantization, and analyze necessary and sufficient conditions for the controlled system to exhibit periodic solutions in presence of an additive constant disturbance affecting the control input. Simulation results provide evidence of the effectiveness of the approach.

Index Terms—quantized feedback control, switched control, practical stability, computing system design, limit cycle.

I. INTRODUCTION

This paper deals with quantized feedback control for discrete-time linear time-invariant control systems. In particular, we consider the effect of quantization of both the measurements and the control actions.

In general, any digital implementation of a control system entails input and output quantization. This is typically the case when the output measurements used for feedback and the control actions applied to the controlled process are transmitted via a digital communication channel. Depending on the specific application, quantization effects can become relevant and significantly affect the controlled system performance. While in some applications the quantization effects can be neglected, when high-precision control is needed, quantization has to be explicitly accounted for in control design.

The emerging area of network based control (see e.g. [1]) has further fostered investigations on quantized feedback control given that information between plant and controller is exchanged through a communication channel with limited bandwidth.

Given a system that is stabilized by a standard linear time-invariant feedback controller when there is no quantization, the problem addressed herein is to find a switched controller

that steers the system towards the smallest possible invariant set that includes the origin when its control input and output are quantized. In [2] global asymptotic stability of the origin is guaranteed for systems with saturating quantized measurements that are stabilizable by linear time-invariant feedback. The proposed hybrid control design methodology relies on the possibility of changing the resolution of the quantizer, zooming in and out depending on the state behavior. A similar approach has been adopted in [3].

Other approaches have been proposed in [4]–[8], even including packet-dropouts effects, [9], [10]. However, in all the cited papers, the only quantized quantity is the controlled variable, and the effect of quantized control actions is neglected. In [5], it is proven that given an unstable discrete time system that is stabilizable, there is no control strategy that makes all closed-loop trajectories asymptotically go to zero, and that if a linear feedback of the quantized state is adopted, then, the closed-loop system behaves chaotically. In this setup, only practical stability can be achieved, which means that the state converges, in some sense, to a certain set that plays the role of an equilibrium. The analysis is carried out in absence of disturbances. In [11], the special case of scalar linear systems with quantized time-invariant static feedback is considered. Most paper on quantized state feedback consider linear systems. The work in [12] extends [13] to a nonlinear setup. In [14], the impact of limited information on nonlinear control design is discussed.

Here, we focus on a discrete time linear system described by an integrator with a one time-unit delay. The system is affected by an additive disturbance on the control input and both control input and controlled output measurements are quantized.

Despite its simplicity, this system structure appears in several problems pertaining to the domain of computing systems. It represents the dynamics from reservation to cumulated CPU time in task scheduling, a typical source of disturbance being the latency of the preemption interrupt [15], [16]. It models the disturbance to error dynamics in clock synchronization for wireless sensor networks, where the most relevant source of disturbance is given by temperature variations in the oscillator crystals [17]. It plays a role in server systems [18], queuing systems [19], and so forth, as can be observed from the variety of problems mentioned in [20]–[23]. Quantizers are present in virtually the totality of these applications, and dealing with their effect is actually important when high-performance is required. In fact, several of the problems just listed require zero error in the presence of constant inputs, hence the relevance

A.V. Papadopoulos is with Mälardalen University, Västerås, Sweden, (e-mail: alessandro.papadopoulos@mdh.se), and F. Terraneo, A. Leva, and M. Prandini are with the Dipartimento di Elettronica, Informazione e Bioingegneria, Politecnico di Milano, Milano, 20133, Italy, e-mail: {federico.terraneo, alberto.leva, maria.prandini}@polimi.it).

This work was done when the first author was a post-doctoral researcher at Politecnico di Milano, and is supported by the European Commission under the project UnCoVerCPS with grant number 643921.

of quantization becomes apparent.

The considered linear system is stabilizable and in absence of quantization one can introduce a standard proportional-integral (PI) controller to bring the state trajectories to zero, in presence of a constant disturbance input. We then propose a switched variant of this PI controller to address quantization and minimize its effect on the feedback control system performance. More specifically, we show that when the disturbance is constant, the switched control solution presents an invariant set for the quantized control input and output variables such that the quantized output is either zero or has a unitary (minimum resolution) amplitude. A reachability analysis study shows that, if the PI controller is suitably tuned, this invariant set is a global attractor. Necessary and sufficient conditions for the existence of a periodic solution in the (not quantized) control input and output variables are given as well.

A. Notation

We now introduce some notation that will be used in the paper developments.

Definition 1 (Sign function). *The sign function of a real number z is defined as:*

$$\text{sign}(z) := \begin{cases} 1, & z > 0 \\ 0, & z = 0 \\ -1, & z < 0 \end{cases}$$

Definition 2 (Integer part of a number). *The integer part of a real number z is defined as:*

$$\text{int}(z) := \begin{cases} \lfloor z \rfloor, & z \geq 0 \\ \lceil z \rceil, & z < 0 \end{cases}$$

Definition 3 (Fractional part of a number). *The fractional part of a real number z is defined as:*

$$\text{frac}(z) := z - \text{int}(z)$$

A quantizer maps a real-valued function into a piecewise constant function taking values in a discrete set, and here it is defined as the rounding operator.

Definition 4 (Rounding operator). *Given a real number z , its rounding $\rho : \mathbb{R} \rightarrow \mathbb{Z}$ is defined as:*

$$\rho(z) := \begin{cases} \text{sign}(z) \cdot |\text{int}(z)|, & 0 \leq \text{frac}(z) < \frac{1}{2} \\ \text{sign}(z) \cdot (|\text{int}(z)| + 1), & \frac{1}{2} \leq \text{frac}(z) < 1 \end{cases}$$

Definition 5 (Rounding error). *Given a real number z , its rounding error is:*

$$\Delta_z := z - \rho(z).$$

Notice that according to the provided definitions, the rounding error of a real number z is always bounded as $|\Delta_z| \leq \frac{1}{2}$.

Finally, note that given two real numbers $a \in \mathbb{R}$, and $b \in \mathbb{R}$, we have that $\rho(\rho(a) + b) = \rho(a) + \rho(b)$.

B. Structure of the paper

The rest of the paper is organized as follows. Section II first describes the control scheme without switching and highlights how quantization deteriorates the performance of the controlled system. The switched solution that allows for minimizing the effect of quantization is then presented in the same section. Section III provides necessary and sufficient conditions for entering the invariant set, and a reachability analysis for identifying the controller parameter tuning that makes such an invariant set a global attractor. Section IV gives necessary and sufficient conditions for the existence of periodic solutions. Finally, Section V provides evidence of the effectiveness of the approach via a simulation study, while Section VI concludes the paper.

II. BASIC CONTROL SCHEME AND ITS SWITCHED VARIANT

We consider a system with control input u and output e , which is governed by the following equation

$$e(k+1) = e(k) + \rho(u(k)) + d(k), \quad (1)$$

where d is some additive disturbance on the quantized control action $\rho(u)$.

The output e represents some error signal and should be driven to zero by compensating the disturbance d through the control input u . To this purpose, quantized measurement of e are available for feedback. Due to the quantization of both u and e , the disturbance might not be exactly compensated and the goal is to design an output feedback compensator so that e is kept below the minimum resolution as defined by the quantizer ($\rho(e) = 0$).

The transfer function between the *residual disturbance* $\rho(u) + d$ and the controlled variable e is given by

$$P(z) = \frac{1}{z-1}, \quad (2)$$

which is a discrete time integrator with a one time unit delay.

Suppose that disturbance d is constant, and neglect the quantization for the time being. Then, a discrete-time Proportional Integral (PI) controller described via the transfer function:

$$R(z) = \frac{1 - \alpha z}{z - 1}, \quad (3)$$

would suffice to drive e to zero with a rate of convergence that can be set via the parameter α . Indeed, if we neglect the quantizers, the effect of the disturbance d on the output e can be described via the (closed-loop) transfer function

$$F(z) = \frac{P(z)}{1 + R(z)P(z)} = \frac{z-1}{z(z+\alpha-2)},$$

which corresponds to an asymptotically stable linear system if $1 < \alpha < 3$. Hence, in the absence of quantization effects, the PI controller guarantees that the error converges to zero in the presence of a constant disturbance, with a rate of convergence that depends on the parameter α . If $\alpha = 2$, output e would be brought to zero in two time units.

Figure 1 shows the resulting control scheme, including the quantizers.

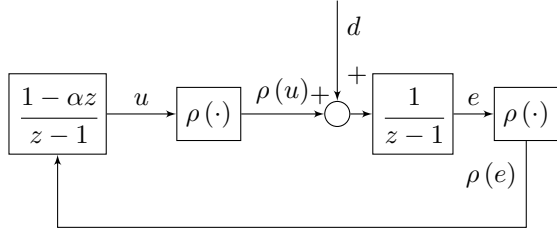

Figure 1: Basic control scheme with quantizers.

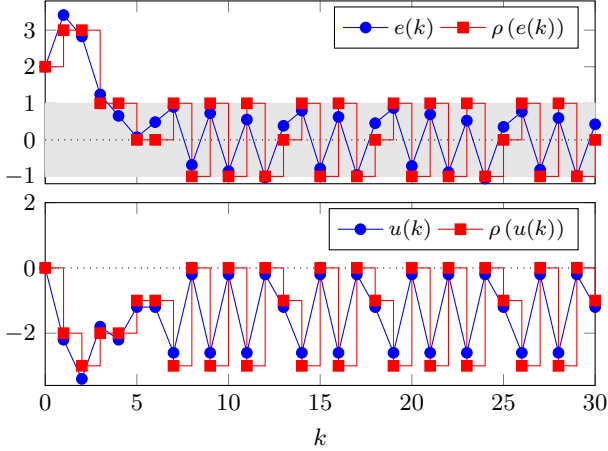

Figure 2: The effect of quantization in the control scheme in Figure 1.

A. The effect of quantization

As anticipated in the introduction, whenever high-precision control is needed, the effect of quantization can significantly deteriorate the performance of the controlled system. Indeed, quantization effects are not negligible in almost all the applications where a digital implementation is in place.

In particular, in the case of the scheme in Figure 1, a constant disturbance may cause the error to end up in a limit cycle. This is due to the fact that the disturbance d is acting directly on $P(z)$, that integrates over time the residual between it and the quantized control input $\rho(u(k))$. The integrated residual disturbance is not detectable on the quantized output $\rho(e)$ as long as it is smaller than $1/2$ in amplitude due to the rounding effect. This causes the controller to react whenever the rounding of the integrated residual disturbance switches to 1 or -1 , steering the controlled system to a limit cycle of amplitude 2 . An example of this effect is shown in Figure 2, with $\alpha = 1.4$, $d(k) = \bar{d} = \sqrt{2}$, and the control system initialized as $e(0) = 2$, $u(0) = 0$.

B. The proposed switched control scheme

In this section, we propose a switched control scheme that reduces the effect of quantization, steering the system to a limit cycle of an amplitude that is half of the one obtained with the control scheme in Figure 1. The proposed solution has the advantage of still sticking to simple controllers that lead to an easily implemented system in an embedded device, with very low overhead.

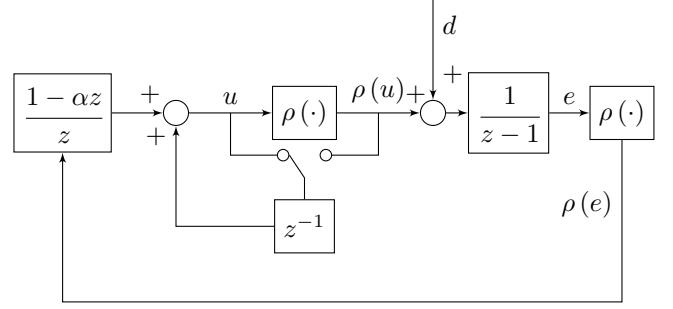

Figure 3: Proposed switched control scheme.

The controller is composed by a linear part with transfer function

$$\tilde{R}(z) = \frac{\alpha z - 1}{z}$$

and a switched part where the control action \tilde{u} computed by $\tilde{R}(z)$ is set as the input to the following modified integrator:

$$\begin{cases} u(k+1) = u(k) + \tilde{u}(k+1), & \text{if } \rho(e(k+1)) \neq 0 \\ u(k+1) = \rho(u(k)) + \tilde{u}(k+1), & \text{if } \rho(e(k+1)) = 0 \end{cases}$$

that finally computes the actual control input u , based on the quantized error measurement $\rho(e)$. Figure 3 shows the resulting switched control scheme.

Note that if $\rho(e(k+1)) \neq 0$, then, the effect of $\rho(e)$ on u is describe by the transfer function $R(z)$ of the PI controller previously presented. Furthermore, in absence of quantization, the two schemes in Figures 3 and 2 coincide.

The switched control system dynamics is characterized by the state variables u and e , and can be expressed as follows:

- if $\rho(e(k+1)) = \rho(e(k) + \rho(u(k)) + d(k)) = 0$, then:

$$\begin{cases} e(k+1) = e(k) + \rho(u(k)) + d(k) \\ u(k+1) = \rho(u(k)) + \rho(e(k)) \end{cases} \quad (4)$$

- if $\rho(e(k+1)) = \rho(e(k) + \rho(u(k)) + d(k)) \neq 0$, then:

$$\begin{cases} e(k+1) = e(k) + \rho(u(k)) + d(k) \\ u(k+1) = u(k) + \rho(e(k)) \\ \quad - \alpha \rho(e(k) + \rho(u(k)) + d(k)) \end{cases} \quad (5)$$

III. INVARIANT SET ANALYSIS

In this section we prove that, for a constant disturbance $d(k) = \bar{d}$, the proposed control scheme admits an invariant set in the quantized state variables $\rho(e)$ and $\rho(u)$, and within that set the amplitude of the quantized error oscillations is 1 .

We characterize the conditions under which the control system enters this invariant set. We then present a numerical reachability analysis providing insight on how to choose the parameter α in order to make the identified invariant set a global attractor.

To this purpose it is convenient to express the control input as the quantized disturbance compensation term $-\rho(\bar{d})$ plus the residual:

$$u(k) = -\rho(\bar{d}) + \bar{u}(k), \quad (6)$$

and let

$$\Delta_d = \bar{d} - \rho(\bar{d}), \quad (7)$$

be the rounding error of the disturbance. We can then rewrite the control system dynamics in the state variables e and \bar{u} as:

- if $\rho(e(k+1)) = \rho(e(k) + \rho(\bar{u}(k)) + \Delta_d) = 0$, then:

$$\begin{cases} e(k+1) = e(k) + \rho(\bar{u}(k)) + \Delta_d \\ \bar{u}(k+1) = \rho(\bar{u}(k)) + \rho(e(k)) \end{cases} \quad (8)$$

- if $\rho(e(k+1)) = \rho(e(k) + \rho(\bar{u}(k)) + \Delta_d) \neq 0$, then:

$$\begin{cases} e(k+1) = e(k) + \rho(\bar{u}(k)) + \Delta_d \\ \bar{u}(k+1) = \bar{u}(k) + \rho(e(k)) \\ \quad - \alpha \rho(e(k) + \rho(\bar{u}(k)) + \Delta_d) \end{cases} \quad (9)$$

which better shows that the rounding error of the disturbance is integrated by the process dynamics.

Theorem III.1. *Let $1 < \alpha < \frac{3}{2}$, and consider the system described by (8) and (9). If, at some time k*

$$-\frac{1}{2} < e(k) < \frac{1}{2} \quad (10a)$$

$$1 \leq \alpha - \bar{u}(k) \text{sign}(\Delta_d) < \frac{3}{2} \quad (10b)$$

$$-\frac{1}{2} < \bar{u}(k) < \frac{1}{2} \quad (10c)$$

then, for all the subsequent time steps $k+h$, $h > 0$:

$$(\rho(e(k+h)), \rho(\bar{u}(k+h))) \in \{(0,0), (\text{sign}(\Delta_d), -\text{sign}(\Delta_d))\}. \quad (11)$$

Moreover, $\{(0,0), (\text{sign}(\Delta_d), -\text{sign}(\Delta_d))\}$ is the smallest invariant set for $\rho(e)$ and $\rho(\bar{u})$, when the system evolves starting from (10).

Proof. Let us first consider the case where $\Delta_d = 0$. Given the error evolution in (8)-(9), we get from (10) that:

$$e(k+1) = e(k) + \rho(\bar{u}(k)) + \Delta_d = e(k).$$

Then $\rho(e(k+1)) = \rho(e(k)) = 0$, and by (10a) the system evolves according to (8):

$$\begin{cases} e(k+1) = e(k) + \rho(\bar{u}(k)) + \Delta_d \\ \bar{u}(k+1) = \rho(\bar{u}(k)) + \rho(e(k)) \end{cases} \Rightarrow \begin{cases} e(k+1) = e(k) \\ \bar{u}(k+1) = 0 \end{cases} \quad (12)$$

The first equation satisfies (10a), and the second equation satisfies both (10b) and (10c), so that the corresponding system keeps evolving according to (12). In addition, $(\rho(e(k+1)), \rho(\bar{u}(k+1)))$ is equal to $(0,0)$, and the system will keep staying in $(0,0)$ for all time $k+h$, with $h > 0$. This concludes the proof for the case when $\Delta_d = 0$.

We now consider the case when $0 < \Delta_d \leq 1/2$. Derivations for the case $-1/2 \leq \Delta_d < 0$ are analogous, and hence omitted. Given (10c), we have:

$$e(k+1) = e(k) + \rho(\bar{u}(k)) + \Delta_d = e(k) + \Delta_d.$$

Since $-1/2 < e(k) < 1/2$ in (10a), and $0 < \Delta_d \leq 1/2$, then

$$-\frac{1}{2} < e(k) + \Delta_d < 1,$$

and

$$\rho(e(k+1)) = \rho(e(k)) = \begin{cases} 0, & |e(k) + \Delta_d| < \frac{1}{2} \\ 1, & \frac{1}{2} \leq e(k) + \Delta_d < 1 \end{cases} \quad (13)$$

We can then distinguish the following two cases:

- 1) $\rho(e(k+1)) = \rho(e(k) + \rho(\bar{u}(k)) + \Delta_d) = 0$
- 2) $\rho(e(k+1)) = \rho(e(k) + \rho(\bar{u}(k)) + \Delta_d) = 1$

Case 1): The system evolves according to (8):

$$\begin{cases} e(k+1) = e(k) + \rho(\bar{u}(k)) + \Delta_d \\ \bar{u}(k+1) = \rho(\bar{u}(k)) + \rho(e(k)) \end{cases} \Rightarrow \begin{cases} e(k+1) = e(k) + \Delta_d \\ \bar{u}(k+1) = 0, \end{cases} \quad (14)$$

so that in one step the quantized state is brought to zero: $(\rho(e(k+1)), \rho(\bar{u}(k+1))) = (0,0)$. Since the first equation in (14) satisfies (10a), and the second satisfies both (10b) and (10c), we are back then to (13).

Case 2): The system evolves according to (9):

$$\begin{cases} e(k+1) = e(k) + \rho(\bar{u}(k)) + \Delta_d \\ \bar{u}(k+1) = \bar{u}(k) + \rho(e(k)) \\ \quad - \alpha \rho(e(k) + \rho(\bar{u}(k)) + \Delta_d) \end{cases} \Rightarrow \begin{cases} e(k+1) = e(k) + \Delta_d \\ \bar{u}(k+1) = \bar{u}(k) - \alpha \end{cases} \quad (15)$$

By (10b), we have:

$$-\frac{3}{2} < \bar{u}(k) - \alpha \leq -1,$$

hence

$$\rho(\bar{u}(k+1)) = \rho(\bar{u}(k) - \alpha) = -1,$$

so that $(\rho(e(k+1)), \rho(\bar{u}(k+1))) = (1, -1)$.

If we next compute:

$$\begin{aligned} e(k+2) &= e(k+1) + \rho(\bar{u}(k+1)) + \Delta_d \\ &= e(k+1) - 1 + \Delta_d, \end{aligned}$$

since $e(k+1) = e(k) + \Delta_d$, and in this case $1/2 \leq e(k) + \Delta_d < 1$:

$$-\frac{1}{2} < e(k+1) - 1 + \Delta_d < \frac{1}{2},$$

we then have

$$\rho(e(k+2)) = 0.$$

The dynamics therefore evolves according to (8), i.e.,

$$\begin{cases} e(k+2) = e(k+1) + \rho(\bar{u}(k+1)) + \Delta_d \\ \bar{u}(k+2) = \rho(\bar{u}(k+1)) + \rho(e(k+1)) \end{cases} \Rightarrow \begin{cases} e(k+2) = e(k+1) - 1 + \Delta_d \\ \bar{u}(k+2) = -1 + 1 = 0 \end{cases} \quad (16)$$

so that $(\rho(e(k+2)), \rho(\bar{u}(k+2))) = (0,0)$. In 2 steps the quantized state is brought to zero. The first equation in (16)

satisfies hypothesis (10a), the second satisfies both (10b) and (10c), hence we are back to (13).

All the above shows that starting from (10), the system ends up evolving in the invariant set $\{(0,0), (1,-1)\}$ for $(\rho(e), \rho(\bar{u}))$. Now we need to prove that this is the smallest invariant set.

Note that we have just shown that from (10) the system either enters the invariant set in $(0,0)$ or in $(1,-1)$, and in this latter case it evolves to $(0,0)$ in one time step. Also, in both cases the system is back to set (10), with $\bar{u} = 0$ (see equations (14) and (16)). We then need to show that the quantized state cannot keep being in $(0,0)$ indefinitely, but it will eventually switch to $(1,-1)$. This is indeed the case because according to equation (14), the system keeps being in (10) with $\bar{u} = 0$ and keeps integrating the rounding error until e (necessarily) exceed $1/2$. Then, we are in case 2 since $\rho(e) = 1$, and the quantized state switches to $(1,-1)$. \square

Proposition III.2. *Let $1 < \alpha < \frac{3}{2}$, and consider the switched control system described by (8) and (9). If, at some time k , the state satisfies (10), then, for all the time steps $k+h$, $h > 1$:*

$$e(k+h) = e(k+h-1) + \rho(\bar{u}(k+h-1)) + \Delta_d \quad (17)$$

$$\bar{u}(k+h) = -\alpha \rho(e(k+h)) \quad (18)$$

Proof. Equation (17) follows immediately from the system dynamics in (8)-(9). Based on the proof of Theorem III.1, (18) is trivially satisfied when $\Delta_d = 0$ since in this case $\rho(e(k)) = 0$, and the system evolves according to (12). Let $\Delta_d \neq 0$. If $\rho(e(k+1)) = 0$, then $\bar{u}(k+1) = 0$ (see equation (14)). If instead, $\rho(e(k+1)) = \text{sign}(\Delta_d)$, then $\bar{u}(k+1) = \bar{u}(k) - \alpha \text{sign}(\Delta_d)$, and in one time step $\bar{u}(k+2) = 0$ (see equations (15) and (16)).

After time $k+2$, \bar{u} keeps its value to 0, when $\rho(e) = 0$. It become $-\alpha \text{sign}(\Delta_d)$ as soon as $\rho(e) = \text{sign}(\Delta_d)$, and then gets back to $\bar{u} = 0$ in one time step. As a consequence, it is possible to express $\bar{u}(k+h)$, with $h > 1$, as:

$$\bar{u}(k+h) = -\alpha \rho(e(k+h)),$$

thus concluding the proof. \square

An example of possible evolution of the system is shown in Figure 4, for $\alpha = 1.1$, $\Delta_d = 0.4$, when the switched control system (8) and (9) is initialized at $e(0) = 0.2$, and $\bar{u}(0) = 0.6$. The green square in the figure indicates the initial condition, while the red area indicates the region (10). The top graph in Figure 4 shows the phase plot of the system. After the state enters the red area, it ends up in the invariant set characterized in Theorem III.1. The central and bottom graphs represent the time evolution of the state variables e and \bar{u} and their quantized version.

Theorem III.1 provides conditions under which the system ends up in an invariant set where the quantized state variables $\rho(e(k))$ and $\rho(\bar{u}(k))$ range between the values 0 and $\text{sign}(\Delta_d)$, and 0 and $-\text{sign}(\Delta_d)$, respectively, with an excursion of amplitude equal to 1. However, depending on the value of α and of Δ_d the system may end up on a different invariant set. Figure 5(a) shows an example of another invariant set, obtained for $\alpha = 1.1$, $\Delta_d = -0.3$, when

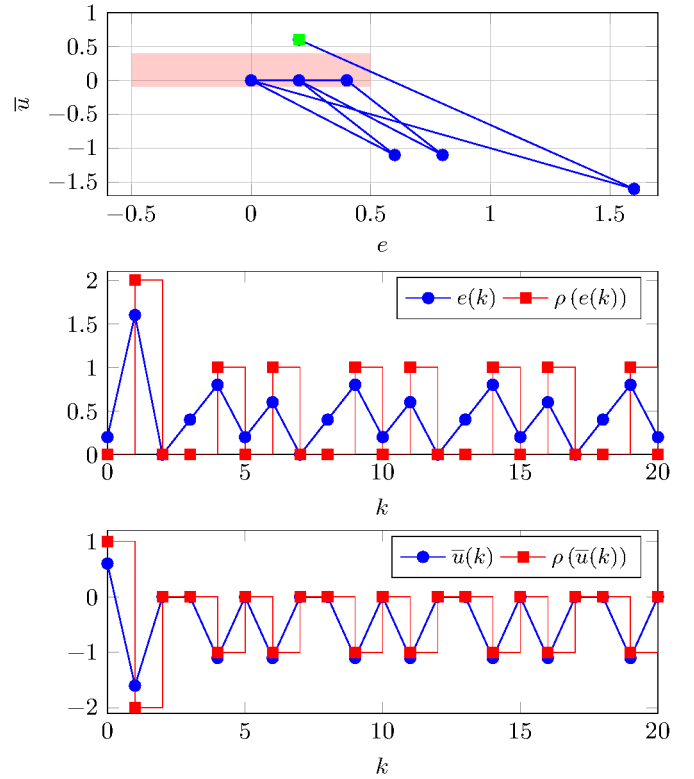

Figure 4: Example of a trajectory entering the invariant set characterized in Theorem III.1. The top graph shows the phase plot in the state variables e and \bar{u} . The lower plots show the time evolution of the state variables and their quantized versions.

the system (8) and (9) is initialized at $e(0) = -0.2$, and $\bar{u}(0) = 0.6$. The red area indicated in the figure is the set (10). Apparently, in this case, the invariant set is:

$$(\rho(e), \rho(\bar{u})) \in \{(0, 1), (1, 0)\},$$

with a quantized state excursion of amplitude 1.

There is, however, also another invariant set where the excursion in amplitude of the quantized error is equal to 2. Figure 5(b), shows the results obtained for $\alpha = 1.1$, $\Delta_d = -0.5$, when the system (8) and (9) is initialized at $e(0) = -0.5$, and $\bar{u}(0) = 1.5$. In this case:

$$(\rho(e), \rho(\bar{u})) \in \{(-1, 2), (1, -1)\}. \quad (19)$$

Similarly, for $\Delta_d = 0.5$ we get:

$$(\rho(e), \rho(\bar{u})) \in \{(-1, 1), (1, -2)\}. \quad (20)$$

Apparently we get this kind of invariant set with an amplitude 2 for the quantized error excursion when $|\Delta_d| = 0.5$, while for $|\Delta_d| \neq 0.5$ only invariant sets where the excursion amplitude is 1 appear. The switched controller then performs better than the linear PI for almost all Δ_d values.

Notice also that when $|\Delta_d| = 0.5$ the invariant set (19) or (20) is reached only from a subset of initial conditions.

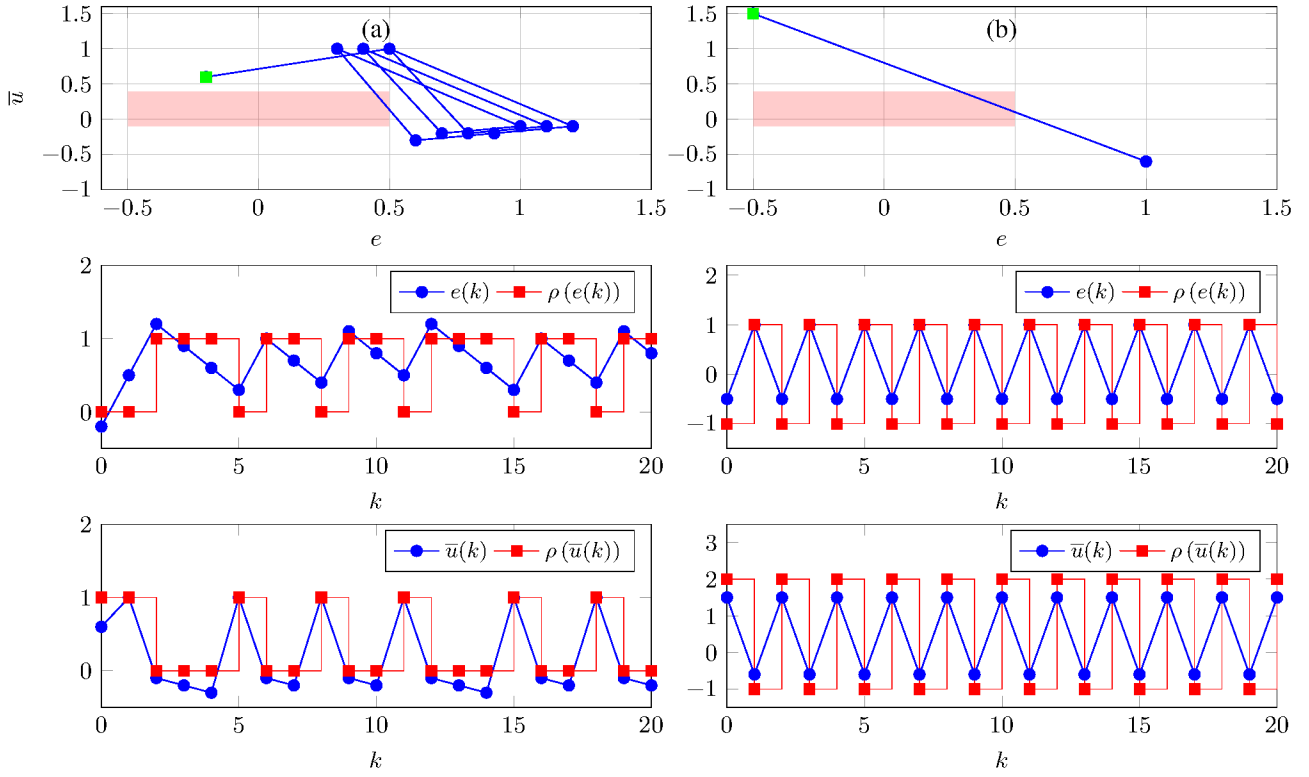

Figure 5: Example of invariant sets that can be obtained with the proposed switched scheme. The left column shows the case where the trajectory ends up in an invariant set with excursion of amplitude 1 for the quantized state e and \bar{u} . Both the phase plot (top graph) and the time evolution of the state variables e and \bar{u} with their quantized versions (lower plots) are reported. The right column shows the case where the trajectory ends up in an invariant set with excursion of amplitude 2. Both the phase plot (top graph) and the time evolution of the state variables e and \bar{u} with their quantizations (lower plots) are reported.

A. Reachability analysis

In order to better characterize when the system reaches the invariant set identified in Theorem III.1, we performed a numerical analysis to study from which initial conditions region (10) is reachable. Providing an analytical reachability analysis for the considered system is quite involved and far from being trivial, due to the quantization effect. In addition, most of the available tools for performing such an analysis (e.g., SpaceEx [24], Flow* [25], KeYmaera [26], or Ariadne [27]) are meant for continuous time dynamical systems [28].

Figure 6 shows the area identified performing such an analysis as a function of $\alpha \in [1.001, 1.499]$ (see Theorem III.1) and $\Delta_d \in [-0.5, 0.5]$ taking 500 and 1000 equally spaced values, respectively. System (8)-(9) was initialized for the analysis with $(e(0), \bar{u}(0)) \in [-10, 10]^2$, taking 1000 equally spaced values per coordinate. Note that $[-10, 10]^2$ can be taken as representative of the whole state space because for larger values of (e, \bar{u}) the quantization errors become negligible. Outside that set one can therefore assume the system to behave linearly, causing any trajectory to end up in the set itself.

In the inner part of the closed curve in Figure 6, for all the considered initial conditions the trajectory ends up in the invariant set identified in Theorem III.1.

Statement 1. *If $5/4 < \alpha < 3/2$ and $|\Delta_d| < 0.5$, the invariant*

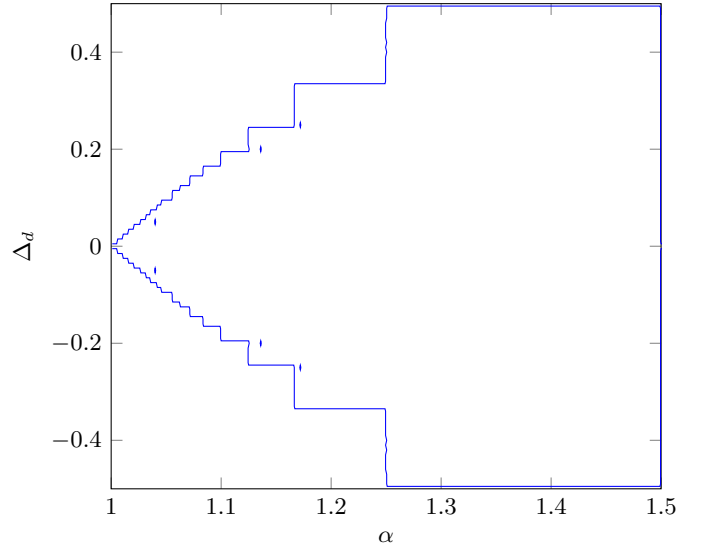

Figure 6: The inner part of the closed curve represent the set of values for α and Δ_d for which the invariant set of Theorem III.1 is a global attractor as a function of α and Δ_d .

set in Theorem III.1 is globally attractive.

As mentioned before, for $|\Delta_d| = 0.5$, the system may end up in an invariant set where the amplitude of the excursion

for the quantized state is 2.

IV. LIMIT CYCLES ANALYSIS

In this section, we analyze the evolution of the switched control system within the invariant set in Theorem III.1, and determine possible periodic solutions for e and \bar{u} jointly with their period p . We start by defining the notion of n -periodic limit cycle of period p .

Definition 6 (n -periodic limit cycle of period p). *An n -periodic limit cycle of period p , with $n, p \in \mathbb{N}$, is a solution of the switched control system (8)-(9) such that*

$$\begin{cases} e(k+p) = e(k) \\ \bar{u}(k+p) = \bar{u}(k) \end{cases}, \quad \forall k \geq \bar{k}$$

for some $\bar{k} \geq 0$, and the quantized state $(\rho(e), \rho(\bar{u}))$ switches n times per period.

Theorem IV.1. *A necessary and sufficient condition for the switched control system to evolve according to a n -periodic limit cycle of period m within the invariant set in Theorem III.1 is that the disturbance rounding error is rational and satisfies*

$$|\Delta_d| = \frac{n}{m}, \quad \text{with } 1 \leq n < m, \text{ and } n, m \in \mathbb{N}.$$

Proof. Note that when the system is within the invariant set of Theorem III.1, the algebraic relation (18) holds. Therefore, we just need to show that the state variable e evolves on the n -periodic limit cycle of period m .

We start by showing that a necessary condition for this to hold is that $|\Delta_d|$ is rational.

Suppose that at a certain time step h the system is within the (minimal) invariant set of Theorem III.1. Assume also, without loss of generality, that $(\rho(e(h)), \rho(\bar{u}(h))) = (0, 0)$. This entails that $|e(h)| < 0.5$ and that the input $\rho(u(h)) + \bar{d}$ to the process is equal to Δ_d since $\rho(u(h)) = -\rho(\bar{d})$ from equation (6). Indeed, the input to the process keeps constant and equal to Δ_d for k time steps, until $|e(h+k)|$ exceeds or gets equal to 0.5 if $\Delta_d > 0$, -0.5 if $\Delta_d < 0$. At time $h+k$, then, $\rho(e(h+k)) \neq 0$ and the pair $(\rho(e(h+k)), \rho(\bar{u}(h+k)))$ switches to $(\text{sign}(\Delta_d), -\text{sign}(\Delta_d))$ in the invariant set. The number of steps k is given by the following formula

$$k = \lambda(\Delta_d, x^{+(0)}) := \left\lceil \frac{0.5 \text{sign}(\Delta_d) - x^{+(0)}}{\Delta_d} \right\rceil, \quad (21)$$

where we set $e(h) = x^{+(0)}$. Observe that $\lambda(\Delta_d, x^{+(0)})$ approaches infinity as Δ_d tends to zero, in accordance with Theorem III.1 where the invariant set is composed only of the value 0 if $\Delta_d = 0$.

The value $x^{+(1)}$ taken by $e(h+k+1)$ can be obtained as

$$x^{+(1)} = x^{+(0)} + \lambda(\Delta_d, x^{+(0)})\Delta_d + \Delta_d - \text{sign}(\Delta_d), \quad (22)$$

since the process integrates an input that is constant and equal to Δ_d for $k = \lambda(\Delta_d, x^{+(0)})$ steps, and then receives as input $\rho(u(h+k)) + \bar{d} = \rho(\bar{u}(h+k)) - \rho(\bar{d}) + \bar{d} = -\text{sign}(\Delta_d) + \Delta_d$ at time $h+k$.

If $x^{+(1)}$ is equal to $x^{+(0)}$, then the evolution of state e of the system is periodic with period $\lambda(\Delta_d, x^{+(0)}) + 1$, and we have

a 1-periodic limit cycle of period $k+1$, because one single switch is needed within the invariant set to reset the state of the process to its original value, and this required $k+1$ steps. If $x^{+(1)} \neq x^{+(0)}$, we can further iterate the same reasoning by considering $i > 1$ switches within the invariant set and computing $x^{+(i)}$, $i > 1$. If there exists some integer $N > 1$ such that $x^{+(N+h)} = x^{+(h)}$, for some $h \geq 0$, then, the state of the process evolves according to an N -periodic limit cycle.

More specifically, we need to compute

$$\begin{aligned} x^{+(N+h)} &= x^{+(h)} + \\ &+ \sum_{i=0}^{N-1} \lambda(\Delta_d, x^{+(i+h)})\Delta_d + N(\Delta_d - \text{sign}(\Delta_d)), \end{aligned}$$

and set $x^{+(N+h)} = x^{+(h)}$, which reduces to solving

$$\left(\sum_{i=0}^{N-1} \lambda(\Delta_d, x^{+(i+h)}) + N \right) |\Delta_d| = N.$$

For this equation to admit a solution we must have

$$|\Delta_d| = \frac{N}{L},$$

where we set $L = \left(\sum_{i=0}^{N-1} \lambda(\Delta_d, x^{+(i+h)}) + N \right)$. Note that since L is an integer larger than N , for a periodic trajectory of the state process e to exist, the absolute value of disturbance quantization error $|\Delta_d|$ must be a rational number of the form $\frac{n}{m}$ with $n < m$. Irrational values for $|\Delta_d|$ are then incompatible with periodic solutions.

We now show that the condition $|\Delta_d| = \frac{n}{m}$ being a rational number is sufficient to have a n -periodic limit cycle of period m .

Observe that by definition of λ as the minimum number of steps needed for $\rho(e(h+k)) \neq 0$ starting from $e(h) = x^{+(0)}$, we have that

$$\begin{aligned} e(h+k) &= x^{+(0)} + \lambda(\Delta_d, x^{+(0)})\Delta_d \\ &\in \begin{cases} [0.5, 0.5 + \Delta_d] & \Delta_d > 0 \\ (-0.5 + \Delta_d, -0.5] & \Delta_d < 0 \end{cases}. \end{aligned}$$

This entails that $x^{+(1)}$ in (22) satisfies

$$x^{+(1)} \in \begin{cases} [-0.5 + \Delta_d, -0.5 + 2\Delta_d] & \Delta_d > 0 \\ (0.5 + 2\Delta_d, 0.5 + \Delta_d] & \Delta_d < 0 \end{cases}$$

irrespectively of $x^{+(0)}$. And this hold true for every $x^{+(i)}$ value of e after i -th switches within the invariant set, with $i \geq 1$.

Let $|\Delta_d| = \frac{n}{m}$, where n and m are coprime integers, $m > n \geq 1$, we next show that, after at least one switch has occurred within the invariant set, then, the switched control system starts evolving according to a n -periodic limit cycle of period m . We refer to the case when $\Delta_d > 0$. The same reasoning applies to $\Delta_d < 0$.

If there were no further switches after time $h+k$ when $e(h+k) = x^{+(1)}$, then, $e(h+k+m)$ would take values in $[x^{+(1)}, x^{+(1)} + m\Delta_d] = [x^{+(1)}, x^{+(1)} + n]$ since the system would integrate a constant input equal to Δ_d for m steps. However, as soon as e becomes larger than or equal to the threshold 0.5, then, its value is decreased by 1, so that if there

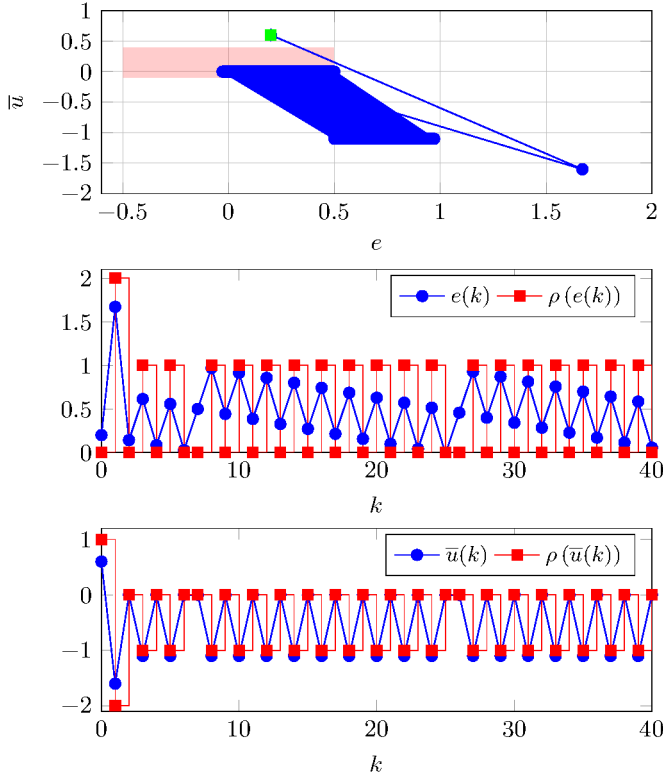

Figure 7: Evolution of the switched control system when $\Delta_d = \sqrt{2}/3$.

were exactly n switches in the time frame $[h+k, h+k+m]$, then, $e(h+k+m) = x^{+(1)} = e(h+k)$ and a periodic solution would be in place. Now, in order to show that there are exactly n switches in the time frame $[h+k, h+k+m]$, one should simply check that $[x^{+(1)}, x^{+(1)} + n]$ contains $\{0.5 + i, i = 0, 1, \dots, n-1\}$ and does not contain $0.5 + n$. Clearly, $0.5 + i$ is contained in $[x^{+(1)}, x^{+(1)} + n]$ for $i = 0$ and $i = n-1$, since $x^{+(1)} > -0.5$. Now we need to show that $x^{+(1)} + n < 0.5 + n$ to conclude that $[x^{+(1)}, x^{+(1)} + n]$ does not contain $0.5 + n$. Indeed, since $x^{+(1)} < -0.5 + 2\Delta_d$, we have that $x^{+(1)} + n < n + 2\Delta_d - 0.5$, which entails $x^{+(1)} + n < n + 0.5$ given that $\Delta_d \leq 0.5$.

This concludes the proof. \square

Figure 7 plots the evolution of the state of the control system for $\Delta_d = \sqrt{2}/3$, $\alpha = 1.1$, $e(0) = 0.2$, and $\bar{u}(0) = 0.6$. Notice that since Δ_d is irrational, the obtained trajectory is not periodic.

Figure 8 shows an example of an 1-periodic limit cycle of period 5 obtained for $\Delta_d = 0.2 = \frac{1}{5}$, starting from the initial condition $e(0) = -0.4$, $\bar{u}(0) = 0.2$. Figure 9 shows a 2-periodic limit cycle of period 5 for $\Delta_d = -0.4 = -\frac{2}{5}$ starting from the same initial condition $e(0) = -0.4$, $\bar{u}(0) = 0.2$.

The following corollary directly follows from Theorem III.1 and Theorem IV.1, and summarizes the results of the limit cycle analysis.

Corollary IV.2. *If $1 < \alpha < \frac{3}{2}$ and $|\Delta_d| = \frac{n}{m}$, where $n, m \in \mathbb{N}$, $1 \leq n < m$, and $|\Delta_d| < \frac{1}{2}$, then the switched control system (8)-(9) admits a limit cycle where the error e is kept*

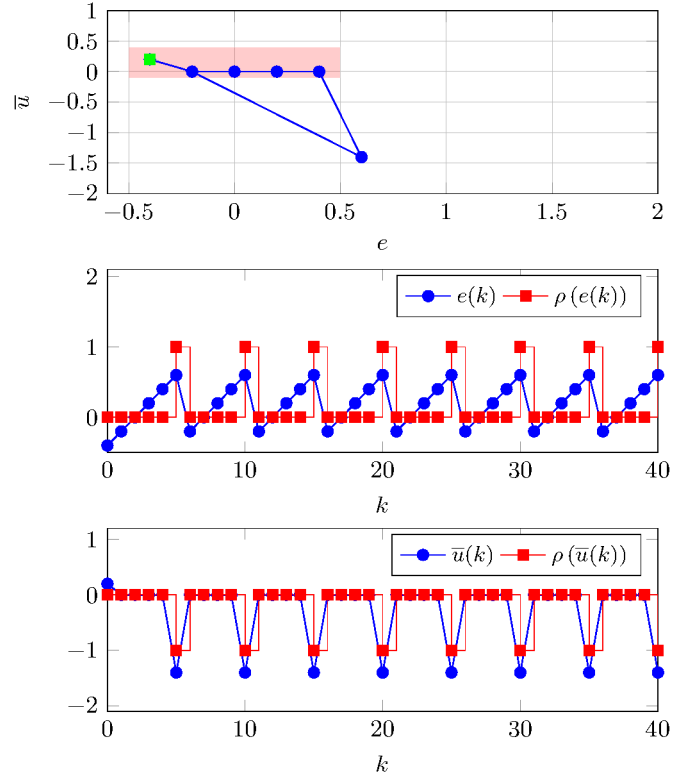

Figure 8: Evolution of the switched control system when $\Delta_d = 1/5$.

within $[-0.5 + \Delta_d, 0.5 + \Delta_d]$ if $\Delta_d > 0$, and within $(-0.5 + \Delta_d, 0.5 + \Delta_d]$ if $\Delta_d < 0$ with a corresponding quantized version excursion of 1.

Proof. We only need to show that e is kept within $[-0.5 + \Delta_d, 0.5 + \Delta_d]$ if $\Delta_d > 0$, and within $(-0.5 + \Delta_d, 0.5 + \Delta_d]$ if $\Delta_d < 0$. Suppose that $\Delta_d > 0$. By Theorem III.1 and Proposition III.2, we have that at some time $k > 1$ after entering the invariant set $\rho(e(k)) = \rho(\bar{u}(k)) = 0$, and $\bar{u}(k) = 0$. Then, the error evolves starting from $|e(k)| < 1/2$, according to (17) which becomes:

$$e(k+h) = e(k+h-1) + \Delta_d \quad (23)$$

(since $\rho(e) = \rho(\bar{u}) = 0$), until $1/2 \leq e(k+h) < 1/2 + \Delta_d$, when $\rho(e(k+h)) = 1$ and hence $\bar{u}(k+h) = -\alpha \rho(e(k+h)) = -\alpha$. At time $k+h+1$, the error is reset to $e(k+h+1) = e(k+h) + \Delta_d - 1$, so that $-1/2 + \Delta_d \leq e(k+h+1) < -1/2 + 2\Delta_d$, and we are back to the integral dynamics (23) because $\rho(e) = \rho(\bar{u}) = 0$. From this analysis it follows that $-1/2 + \Delta_d \leq e < 1/2 + \Delta_d$. Analogous derivations can be carried out for the case $\Delta_d < 0$. \square

Remark 1. *The reachability numerical analysis in Section III-A shows that the limit cycle in Corollary IV.2 is globally attractive.*

V. SIMULATION RESULTS

We first present some simulation results comparing the three cases when no quantization is present in the control scheme,

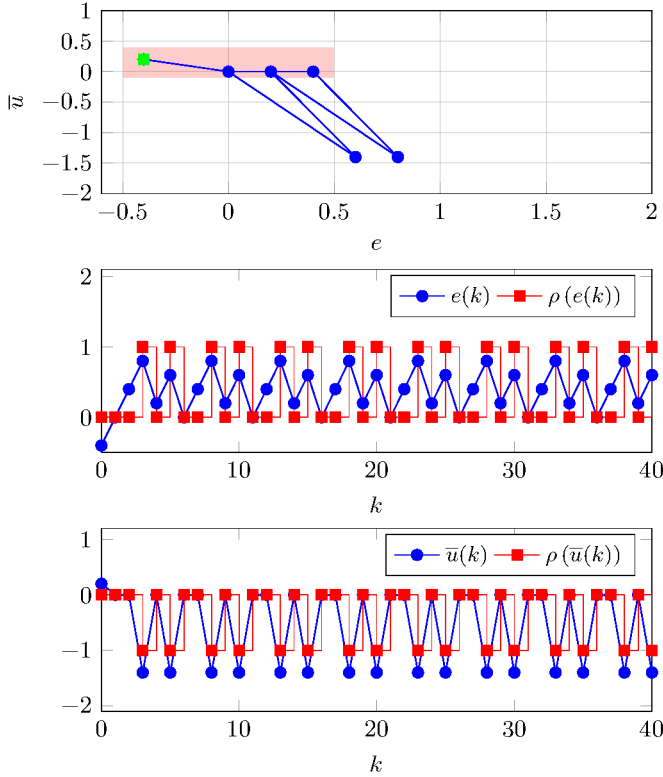

Figure 9: Evolution of the switched control system when $\Delta_d = 2/5$.

and when quantization is present and either the PI or its switched extension is implemented. Notice that in the absence of quantization the PI controller and its switched extension coincide. Figure 10 reports the simulation runs for the three cases for a finite horizon of 30 time units. In all three plots the error is normalized, i.e., a unitary resolution is assumed. The value used for α is $11/8$, and $\Delta_d = \sqrt{2} - 1$, while the system state is initialized at $e(0) = 0$, and $u(0) = 0$.

While in the absence of quantization the error converges to 0 with the designed controller, when quantization is in place it is not possible anymore to guaranteeing convergence to zero. In the case of PI control, the error oscillates in the area $[-1, 1]$, while in the case of its switched extension, it ends up oscillating in the region $[0, 1]$ according to Statement 1 and Theorem III.1. It is worth noticing that for the chosen value of Δ_d the evolution of the control system state cannot be periodic by Theorem IV.1. This is reflected in the evolution of e that oscillates in the gray area, but always assumes different values in the set.

We now consider a time-varying disturbance, which is initially constant and takes the value $d = \bar{d}_1 = 2.6$ ($\Delta_d = -0.4 < 0$), then, starts decreasing linearly at time $k = 50$ till it hits the value $d = \bar{d}_2 = 2.4$ at $k = 250$ ($\Delta_d = 0.4 > 0$), and finally keeps constant.

The results of the simulation with the switched controller are shown in Figure 11, with the error e , the control signal u , and the disturbance d on the left column, and their quantized versions on the right column. The system is initialized with $e(0) = 0$, $u(0) = 0$, and we set $\alpha = 11/8$.

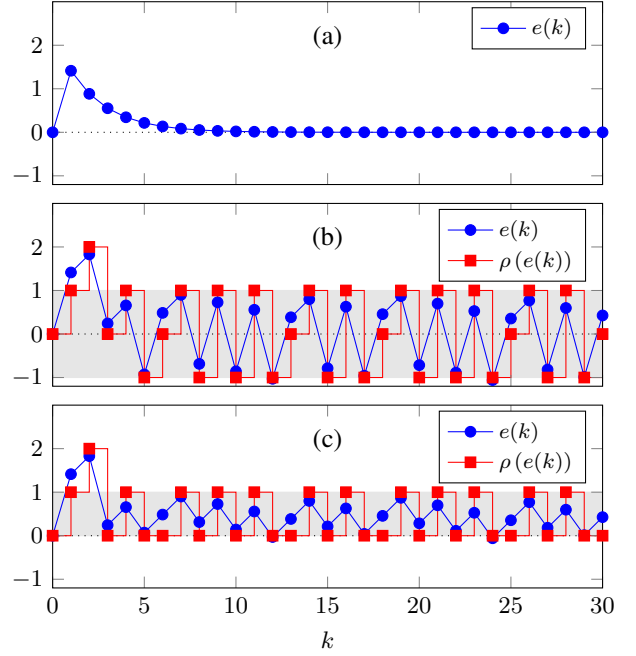

Figure 10: Behavior of quantized (red line with squares) and non quantized (blue line with circles) error in a simulation run: (a) without quantizers, (b) with the standard PI with quantizers, and (c) with the switched PI with quantizers.

Note that the abrupt change of sign of Δ_d when the disturbance crosses the threshold 2.5 at time $k = 150$ causes a transient which can be seen from the error behavior, and it is reflected in the quantized version only later, at time $k = 175$, when the quantized error starts oscillating between $[-1, 1]$ and correspondingly the quantized control input oscillates between $[-4, -1]$. Such oscillations then stop when the (new) invariant set described in Theorem III.1 is reached according to Statement 1. The quantized error then exceeds the minimum resolution only temporarily during the (delayed) transient cause by the threshold crossing. In the case of the standard PI controller, the quantized error and the quantized control input keep oscillating between $[-1, 1]$ and $[-4, -1]$, respectively, for the whole time horizon, irrespectively of the fact that the disturbance crosses the threshold (see Figure 12).

If we change the value \bar{d}_2 and set it equal to $\bar{d}_2 = 2.501$, the threshold 2.5 is not crossed by the disturbance and the system keeps evolving in the same invariant set (see Figure 13).

The results presented next refer to a simulation campaign aimed at investigating the effect of the disturbance magnitude on the control performance, with and without the proposed switched extension.

The campaign was carried out by choosing the values of \bar{d} reported in Table I. For each value of \bar{d} , two models – one with bare PI control and the other with switched PI – were initialized to $e(0) = 0$ and $u(0) = 0$, and then subjected to a constant disturbance of the selected amplitude. Data were collected from the two simulated experiments just described over a finite horizon of $H = 1000$ time units. We assess performance by computing the Root Mean Square (RMS)

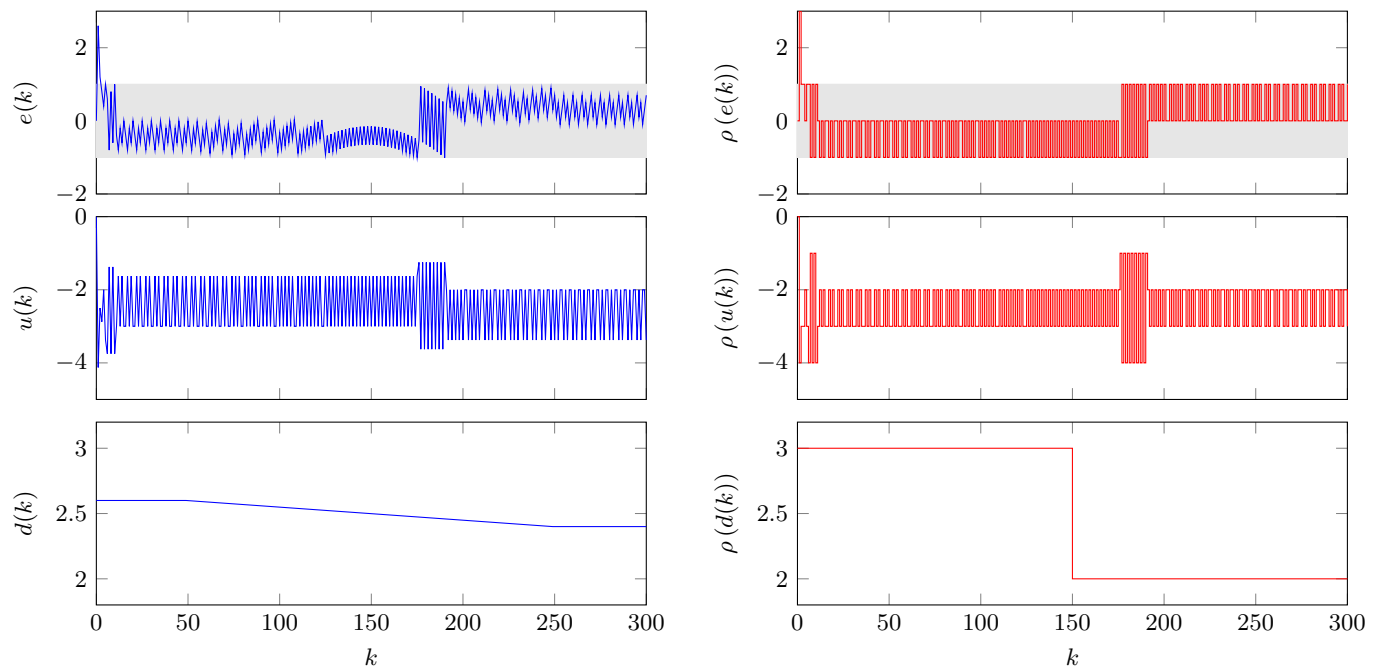

Figure 11: Simulation with a time-varying disturbance and the switched PI controller.

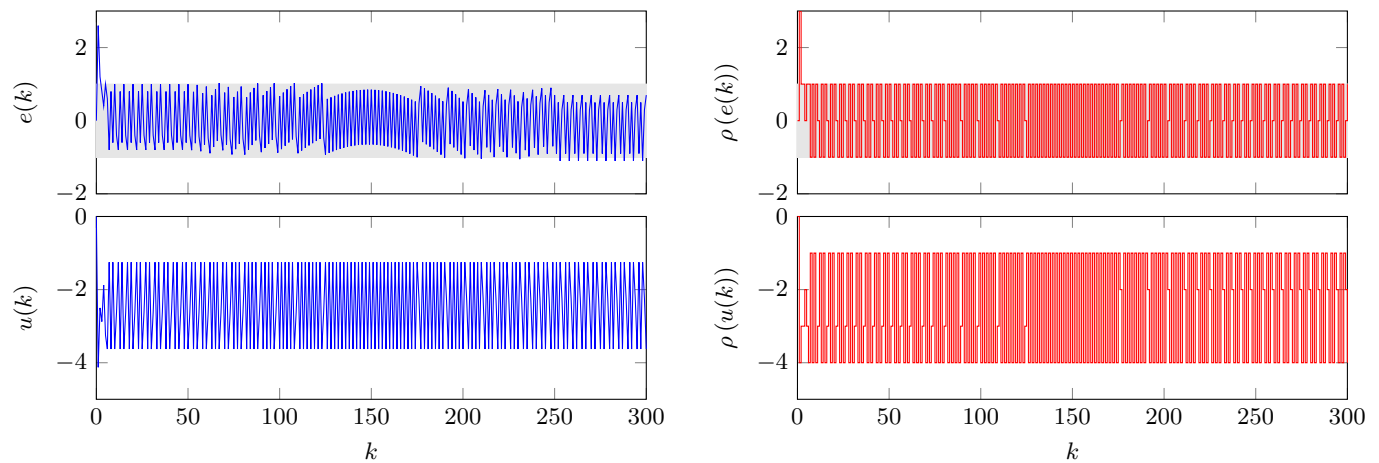

Figure 12: Simulation with the time-varying disturbance in Figure 11 and the standard PI controller.

value of the quantized error, that is defined as:

$$RMS_{\rho(e)} = \sqrt{\frac{1}{H} \sum_{i=0}^{H-1} \rho(e(i))^2}$$

where H is the length of the simulation.

Table I summarizes the results and shows that the proposed switched scheme decreases the $RMS_{\rho(e)}$ by 30%.

VI. CONCLUSIONS AND FUTURE WORK

A switched control scheme was proposed for reducing the degradation effect due to the quantization of both control and controlled variables in a system described as an integrator with unit delay. Set invariance and limit cycles analysis were performed, jointly with a numerical reachability study, to assess the switched control scheme performance and provide

disturbance \bar{d}	RMS performance index	
	standard PI	switched PI
± 0.01	0.138	0.100
± 0.02	0.197	0.141
± 0.04	0.281	0.200
± 0.05	0.314	0.223
± 0.1	0.446	0.316
± 0.2	0.631	0.447
± 0.4	0.893	0.632
$\pm(\sqrt{2}-1)$	0.909	0.643

Table I: RMS performance index of the simulation campaign.

guidelines for control tuning. In particular, necessary and sufficient conditions for the presence of n -periodic limit cycles of period p were discussed. Finally, simulation results back up the proposed solution.

Future work will concern the evaluation of the proposed

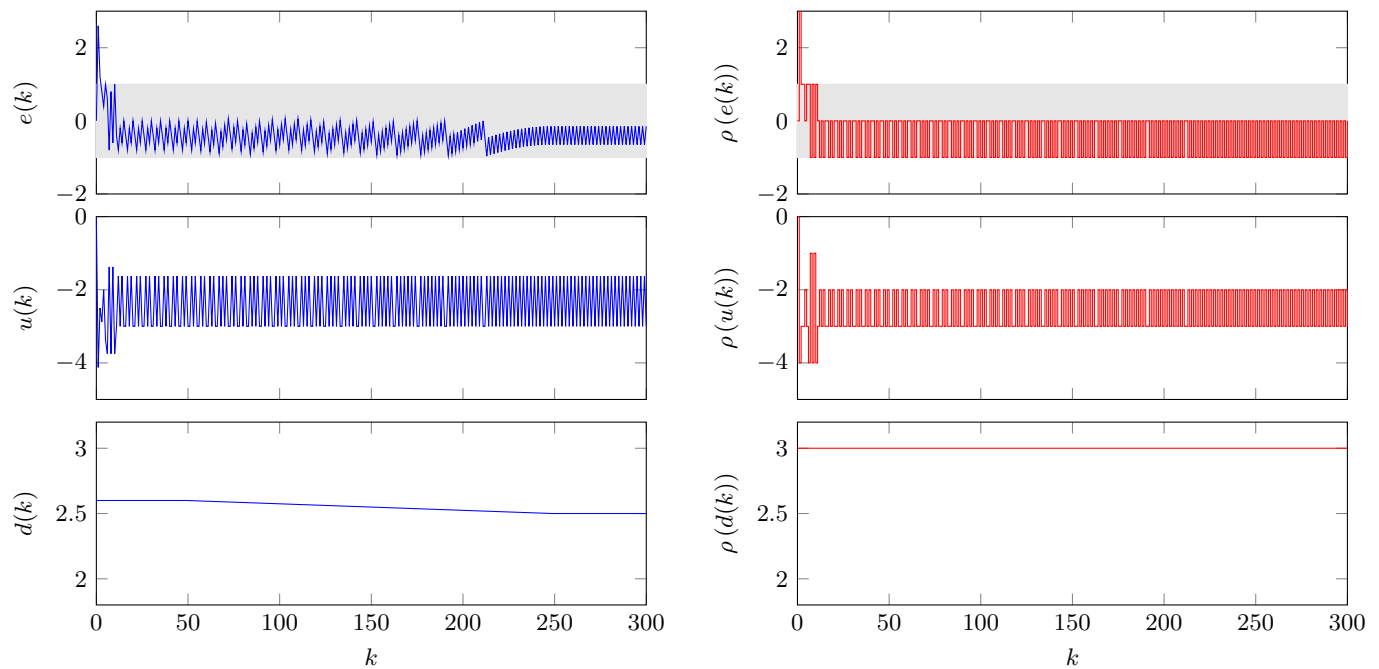

Figure 13: Simulation with a time-varying disturbance that has constant quantized value, using the switched PI controller.

approach in specific types of applications, where the quantization effect is relevant. Results are confined to a specific class of systems. Further investigations are needed to extend the proposed approach to a larger class of problems.

REFERENCES

- [1] P. Antsaklis and J. Baillieul, "Guest editorial special issue on networked control systems," *IEEE Transactions on Automatic Control*, vol. 49, no. 9, pp. 1421–1423, Sept 2004.
- [2] R. W. Brockett and D. Liberzon, "Quantized feedback stabilization of linear systems," *IEEE Transactions on Automatic Control*, vol. 45, no. 7, pp. 1279–1289, Jul 2000.
- [3] T. Kameneva and D. Nedic, "On l_2 stabilization of linear systems with quantized control," *IEEE Transactions on Automatic Control*, vol. 53, no. 1, pp. 399–405, Feb 2008.
- [4] J.-H. Chou, S.-H. Chen, and I.-R. Horng, "Robust stability bound on linear time-varying uncertainties for linear digital control systems under finite wordlength effects," *JSMIE international journal. Ser. C, Dynamics, control, robotics, design and manufacturing*, vol. 39, no. 4, pp. 767–771, dec 1996.
- [5] D. F. Delchamps, "Stabilizing a linear system with quantized state feedback," *IEEE Transactions on Automatic Control*, vol. 35, no. 8, pp. 916–924, Aug 1990.
- [6] X. Feng and K. A. Loparo, "Active probing for information in control systems with quantized state measurements: a minimum entropy approach," *IEEE Transactions on Automatic Control*, vol. 42, no. 2, pp. 216–238, Feb 1997.
- [7] J. Raisch, "Control of continuous plants by symbolic output feedback," in *Hybrid Systems II*. London, UK, UK: Springer-Verlag, 1995, pp. 370–390.
- [8] M. Corradini and G. Orlando, "Robust quantized feedback stabilization of linear systems," *Automatica*, vol. 44, no. 9, pp. 2458 – 2462, 2008. [Online]. Available: <http://www.sciencedirect.com/science/article/pii/S0005109808001210>
- [9] Y. Ishido and K. Takaba, "A new framework for robust stability analysis of quantized feedback systems," in *Proceedings of the 2010 American Control Conference*, June 2010, pp. 3901–3906.
- [10] Y. Ishido, K. Takaba, and D. E. Quevedo, "Stability analysis of networked control systems subject to packet-dropouts and finite-level quantization," *Systems & Control Letters*, vol. 60, no. 5, pp. 325–332, 2011.
- [11] F. Fagnani and S. Zampieri, "Stability analysis and synthesis for scalar linear systems with a quantized feedback," *IEEE Transactions on Automatic Control*, vol. 48, no. 9, pp. 1569–1584, Sept 2003.
- [12] T. Kameneva and D. Nedic, "Robustness of nonlinear control systems with quantized feedback," *Nonlinear Analysis: Hybrid Systems*, vol. 4, no. 2, pp. 306 – 318, 2010.
- [13] D. Liberzon and D. Nedic, "Input-to-state stabilization of linear systems with quantized state measurements," *IEEE Transactions on Automatic Control*, vol. 52, no. 5, pp. 767–781, May 2007.
- [14] D. Liberzon, "Nonlinear control with limited information," *Commun. Inf. Syst.*, vol. 9, no. 1, pp. 41–58, 2009. [Online]. Available: <http://projecteuclid.org/euclid.cis/1242738941>
- [15] A. Leva and M. Maggio, "Feedback process scheduling with simple discrete-time control structures," *IEEE Proceedings – Control Theory and Applications*, vol. 4, no. 11, pp. 2331–2342, 2010.
- [16] A. V. Papadopoulos, M. Maggio, A. Leva, and E. Bini, "Hard real-time guarantees in feedback-based resource reservations," *Real-Time Systems*, vol. 51, no. 3, pp. 221–246, 2015.
- [17] A. Leva, F. Terraneo, L. Rinaldi, A. V. Papadopoulos, and M. Maggio, "High-precision low-power wireless nodes' synchronization via decentralized control," *Control Systems Technology, IEEE Transactions on*, vol. 24, no. 4, pp. 1–15, July 2016.
- [18] M. Kihl, A. Robertsson, M. Andersson, and B. Wittenmark, "Control-theoretic analysis of admission control mechanisms for web server systems," *The World Wide Web Journal, Springer*, vol. 11, no. 1-2008, pp. 93–116, Aug. 2007.
- [19] M. A. Kjør, M. Kihl, and A. Robertsson, "Response-time control of a single server queue," in *Proc. 46th IEEE Conference on Decision and Control*, New Orleans, LA, Dec. 2007.
- [20] Y. Diao, J. Hellerstein, S. Parekh, R. Griffith, G. Kaiser, and D. Phung, "Self-managing systems: A control theory foundation," in *Proc. 12th IEEE Int. Conf. and Workshops on Engineering of Computer-Based Systems*, Phoenix, AZ, USA, 2005, pp. 441–448.
- [21] J. Hellerstein, Y. Diao, S. Parekh, and D. Tilbury, *Feedback Control of Computing Systems*. Hoboken, NJ, USA: John Wiley & Sons, 2004.
- [22] A. V. Papadopoulos, M. Maggio, F. Terraneo, and A. Leva, "A dynamic modelling framework for control-based computing system design," *Mathematical and Computer Modelling of Dynamical Systems*, vol. 21, no. 3, pp. 251–271, 2015.
- [23] K. J. Åström and R. M. Murray, *Feedback systems: an introduction for scientists and engineers*. Princeton university press, 2010.
- [24] G. Frehse, C. Le Guernic, A. Donzé, S. Cotton, R. Ray, O. Lebeltel, R. Ripado, A. Girard, T. Dang, and O. Maler, "Spacex: Scalable verification of hybrid systems," in *Proceedings of the 23rd International*

- Conference on Computer Aided Verification*, ser. CAV'11. Berlin, Heidelberg: Springer-Verlag, 2011, pp. 379–395.
- [25] X. Chen, E. Abrahám, and S. Sankaranarayanan, *Flow*: An Analyzer for Non-linear Hybrid Systems*. Berlin, Heidelberg: Springer Berlin Heidelberg, 2013, pp. 258–263.
- [26] A. Platzer and J.-D. Quesel, *KeYmaera: A Hybrid Theorem Prover for Hybrid Systems (System Description)*. Berlin, Heidelberg: Springer Berlin Heidelberg, 2008, pp. 171–178.
- [27] P. Collins, D. Bresolin, L. Geretti, and T. Villa, “Computing the evolution of hybrid systems using rigorous function calculus,” in *Analysis and Design of Hybrid Systems*, 2012, pp. 284–290.
- [28] X. Chen, S. Schupp, I. B. Makhoulouf, E. Abrahám, G. Frehse, and S. Kowalewski, *A Benchmark Suite for Hybrid Systems Reachability Analysis*. Cham: Springer International Publishing, 2015, pp. 408–414.