

A Resource Management Protocol for Mobile Cloud Using Auto-Scaling

Chathura Sarathchandra Magurawalage*, Kun Yang*, Ritosa Patrik †, Michael Georgiades‡ and Kezhi Wang*

*School of Computer Sciences and Electrical Engineering

University of Essex, CO4 3SQ, Colchester, U.K.

Email: {csarata, kunyang, kezhi.wang}@essex.ac.uk

†Telekom Slovenije, Ljubljana, Slovenia

Email: patrik.ritosa@telekom.si

‡PrimeTel PLC, Pafos, Cyprus

Email: michaelg@prime-tel.com

Abstract—Cloud radio access networks (C-RAN) and Mobile Cloud Computing (MCC) have emerged as promising candidates for the next generation access network techniques. MCC enables resource limited mobile devices to offload computationally intensive tasks to the cloud, while C-RAN offers a technology that addresses the increasing mobile traffic. In this paper, we propose a protocol for task offloading and for managing resources in both C-RAN and mobile cloud together using a centralised controller.

A working procedure of the proposed protocol has been illustrated to show its mobile task offloading and resource allocation functions. The performance analysis of cloud vertical scaling indicates that the scaling time delay trend varies, depending on the scaling resource, i.e., CPU, RAM, Storage, in the mobile cloud. Furthermore, we conclude that using unaided vertical scaling for scaling computing resources in real-time, may not be suitable for delay sensitive applications, due to significant scaling delay.

I. INTRODUCTION

User equipment (UE), e.g., smartphone, tablet, wearable device, and digital camera, is playing an important role in new application scenarios such as virtual reality, augmented reality and surveillance systems. While resource-constrained UE components such as CPU, GPU, memory, storage, and battery lifetime, have driven a dramatic surge in developing new paradigms to handle computation intensive tasks [1]. For example, computationally intensive applications requiring a large amount of computing resources are not suitable to run on mobile or portable devices.

Mobile cloud computing (MCC) [2] provides a solution where the UE offloads computationally intensive tasks to a remote resourceful cloud (e.g. EC2), thereby saving processing power and energy. Furthermore, Kumar *et al.* [1] have discovered a computing-communication trade-off, and concluded that mobile task offloading is beneficial when the computing intensity of the task in question is high, and when the required network resources that are required to transfer the offloading task to the remote mobile cloud is relatively low. Kumar *et al.* have also emphasised the need for high bandwidth wireless networks for task offloading to be efficient.

Subsequently, the offloading algorithm of the offloading framework that resides on the mobile device may make decisions on *what* (which tasks), *when* (when it is beneficial to

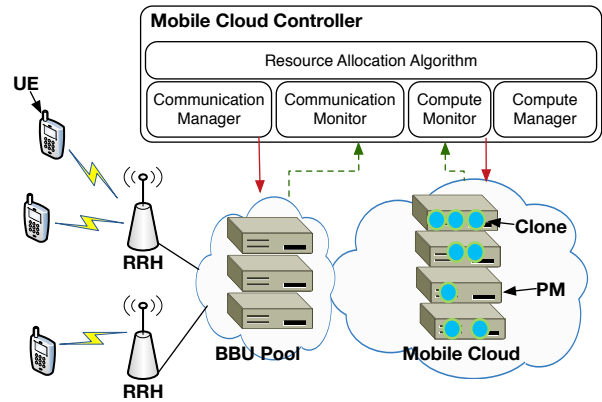

Fig. 1. Overview of the architecture, showing the interaction between, Mobile device and mobile cloud and C-RAN.

offload) and *where* to offload. Various authors have proposed different architectures for offloading frameworks and have provided their implementations. Examples of these include MAUI [3], Thinkair [4], CloneCloud [5], Cuckoo [6]. The architectures of which mostly dependent on the offloading type/level (thread level, method level, code level), and the implementation platform (programming language, used application libraries). However, the partitioning methods of task offloading are out of the scope of this paper.

To ensure highly efficient network operation and flexible service delivery when handling mobile internet traffic surging, Cloud Radio Access Network (C-RAN) [7] brings cloud computing technologies into mobile networks by centralising baseband processing units (BBU) of the radio access network. It moves the BBU from traditional base station to the cloud and leaves the remote radio heads (RRH) distributed geographically. The RRHs are connected to the BBU pool via high bandwidth and low-latency fronthaul. The BBU pool can be realised in data centres, and the centralised baseband processing enables BBU to be dynamically configured and shared on demand [8]. In this case, with the transition from conventional hardware-based environment to a software-based infrastructure, C-RAN can achieve flexible management of

BBU resources.

Figure 1 shows the hybrid deployment of C-RAN with a mobile cloud for computation offloading, as opposed to the traditional mobile cloud hosted on the internet. Connected with geographically distributed RRHs and centralised BBUs, UEs get access to the VMs (i.e., mobile clones) in a mobile cloud for computation offloading. For computation offloading requests, data is first transmitted by the base station (RRH and BBU) via the uplink. Once processed by a clone (Virtual Machine) in the mobile cloud, the results will be returned to UEs via the downlink. However, our work largely focuses on the mobile cloud side.

As shown in Figure 1, a new kind of resource has been introduced to the traditional mobile operator's network. This is not only beneficial to the mobile users (UEs) for offloading computationally intensive tasks to the cloud, but there are a number of aspects that operators can benefit from. Operators are now not only a network pipe provider, but they can also offer computing services to the subscribers. Moreover, the operators may let the subscribers pay more on top of the current price plan for extra computing services that they receive, by introducing new price plans for mobile task offloading. One may introduce new components into existing systems, but such components still have to be managed for utilising the resources efficiently.

Software Defined Networking (SDN) [9] is a centralised architecture that augments a data plane and a control plane from traditional networks. Centralised controller nodes have been introduced into the network for managing resources. Such SDN-based architectures and management controllers have been introduced to wireless networks in multiple accounts [10] [11]. The main focus of above has been on defining SDN modules and interfaces (northbound and southbound) for wireless networks [10], for efficient network service deployments. Moreover, SDN has been proposed for Long Term Evolution (LTE) wireless network control [10]; e.g. interference mitigation, network access selection.

It is inescapable that a centralised controller needs to be introduced for managing both computing and resources in the mobile cloud and communication resources in C-RAN. Such a controller may still be able to control wireless network resources, while also managing computing resources when mobile tasks are offloaded to the cloud. Figure 1 depicts the proposed controller that manages the mobile cloud and baseband resources in C-RAN. The dotted lines illustrate the connectivity to both the BBU pool and the mobile cloud for sending control signals. In this architecture, a signalling protocol needs to be designed for task offloading and managing wireless resources in operator's network (Communication Manager) and computing resources in the mobile cloud (Compute Manager). However, this paper's focus is mainly on mobile task offloading, managing mobile cloud computing resources and on developing a prototype of such a system architecture to show further that the computational resources offloaded to the mobile cloud have to be managed efficiently while at the same time taking delay constraints of compute

(task) offloading into account.

The cloud resources in the mobile cloud have to be managed efficiently while also taking delay constraints of compute (task) offloading into consideration. Auto-scaling [12] enables cloud administrators to dynamically scale computing resources in the cloud for their applications to adapt to workload fluctuations. There are two types of auto-scaling: 1) Horizontal scaling adds and removes virtual machines (VM) from an existing VM pool that serves an application, 2) Vertical scaling adds and removes virtual resources from an existing VM. However, horizontal scaling has been used more often, in comparison to vertical scaling in literature. Moreover, horizontal scaling allows the application to achieve higher throughput levels per each addition, but the deployment cost is greater than vertical scaling [13].

When scaling vertically, the resource provisioning introduces delay, which makes the desired effect arrive late. But not many previous auto-scaling techniques have taken these delays into consideration. [14] stresses the need for future work on auto-scaling, taking auto-scaling time delays into consideration. Auto-scaling may scale either virtual disk, memory or CPU resources (virtual CPU is the most used auto-scaling resource) or a combination of types of resources. Also, one may scale up and scale down VMs depending on the current amount of workload. Moreover, when scaling resources, one may scale "continuously" by adding/removing just one resource from the existing VM or may add or remove more than one resource from the VM "non-continuously". The aforementioned scenarios should be taken into consideration when designing efficient offloading techniques. Therefore, it is important to understand the trends of such resize delays before designing auto-scaling algorithms, especially when auto-scaling for delay sensitive applications.

The remainder of this paper is organised as follows. Section II introduces the proposed task offloading and resource management, (i.e. unified) protocol. Then section III presents the implemented prototype of the system described above and the performance analysis of the computing resource management operations using vertical auto-scaling. The conclusions are shown in section IV followed by the acknowledgement in section V.

II. UNIFIED PROTOCOL

Cloud Radio Access Networks allows cellular networks to process baseband tasks of multiple cells/RRHs as well as to allocate cellular resources to subscribers. In conventional mobile task offloading systems, the offloading framework and the mobile network are not aware of the offloading process. The network treats the offloading data as any other data, and the offloading destination resides outside the network operator's network. The offloading process could have been more efficient if the offloading network resources and cloud resources can be dynamically allocated to fit offloading requirements.

First, we design a protocol for communicating between the controller, BBU and the Mobile Cloud for resource allocation.

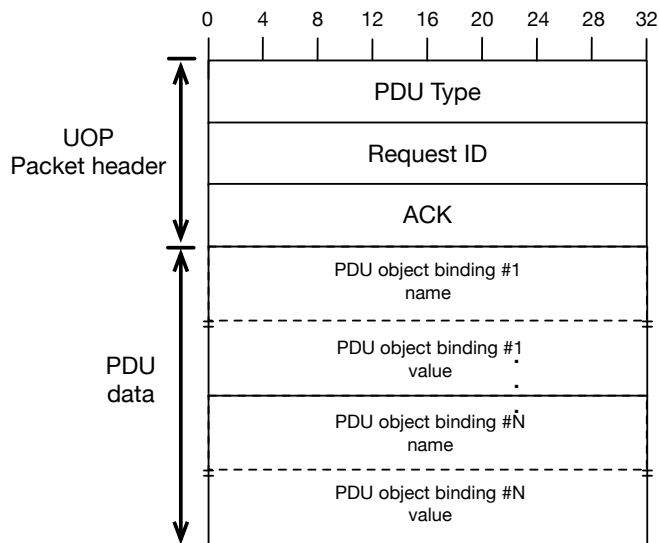

Fig. 2. Unified Offloading Protocol PDU. (The ticks represent number of bits)

TABLE II
PDU TYPES (SOME EXAMPLES)

PDU Type value	PDU type
0000	Offload_Req
0001	Offload_Accept
0002	Offload_Denied
0003	Offload_Start
0004	App_Register
0005	App_Request
0006	App_Data
0007	App_Response
0008	Offload_FIN
0009	Manage_Compute
0010	Manage_BBU

This enables resource allocation when offloading. We assume that the UE has already discovered its BBU and its Clone, and propose a uniform PDU (Protocol Data Unit) format for both resource allocation and task offloading, as the name suggests. The proposed Uniform Offloading Protocol (UOP) operates in the Application Layer of the Internet Protocol Suite (OSI Layer 7). The Mobile Cloud Controller manages and is the main point of contact for both user (service consumer), and the services in the service providers side. We assume that the mobile cloud controllers are discoverable throughout the network for offloading using web service discovery protocols, e.g., Universal Description, Discovery and Integration. Once a mobile device discovers the most suitable mobile cloud to offload, it will then directly connect to the corresponding controller using the offloading protocol.

1) *Protocol Data Unit format*: The PDUs (Protocol Data Unit) format of both offloading and resource allocation protocol is shown in Figure 2. The offloading PDU is then passed down to the TCP layer and may be encapsulated with the TCP packet header. The offloading packet contains application control fields and a payload. The payload may

contain offloading code, user data and application errors if any. Moreover, the definitions of the fields are shown in Table I, the PDU types in Table II and the definitions of object binding name-value pair in Table III

We have avoided basing the offloading protocol on top of other web application protocols such as HTTP and SOAP due to their complexity and large overhead [15]. Henceforth, it operates on raw Transport Layer Sockets. In our case, the offloading protocol is designed on top of TCP. Therefore, depending on the Transport Layer protocol that the offloading protocol (TCP/UDP) implements, the Client Handler in the controller and the offloading framework in the clone will listen on a known port for messages that are sent from the offloading mobile device. Implementing the protocol on top of TCP, automatically inherits TCP reliable delivery, congestion control, error correction and ability to add optional Transport Layer Security (TLS/SSL) layers.

Time-outs takes an important role in the protocol for assuring the timeliness of individual transactions. Such timeouts are conventionally implemented within applications. Instead, the offloading protocol handles timeouts and indicates the applications if the protocol has timed out waiting for service responses.

Each transaction (offloading or resource management procedure) must succeed, but in a case of a failure, the system should roll back to its previous state. The acknowledgement messages assure the completeness of transactions. If a task or a set of tasks fail, then an error message will be sent back instead of acknowledgement. The protocol assumes an offloading task as one transaction. Within this main transaction, there are multiple individual sub-transactions. Namely, they are communication resource allocation task, compute resource allocation task, remote code execution tasks. If any of aforementioned sub-transactions fail, the main transaction is also considered failed. The communication and computing resources that were allocated will be unallocated and put back into the pool of globally available resources. Finally, the code will have to be executed locally by the mobile device, if the delay restrictions do not allow it to resend an offloading request. From start to the end of an offloading transaction, mobile cloud controller keeps track of all protocol and application states.

We have kept the protocol and the packet format as simple as possible for reducing overhead and processing complexity. As depicted in Figure 3 the protocol separates management functions (C-RAN/Mobile Cloud resource allocation) from services (task offloading) for increasing scalability and centralising management of services. It also Integrates application error reporting to the offloading protocol, (e.g. by including the error code in ACK section of the packet when the thinkair offloading framework has thrown an error) The offloading protocol is independent of the mobile operating system and the offloading framework. The payload of the packet can carry more than one offloading task.

2) *Working Procedure*: The Figure 3 shows an instance where the protocol successfully instructs the UE to offload computationally intensive tasks to the mobile cloud. Once the

TABLE I
UOP ATTRIBUTE DEFINITION

Field Name	Value Type	Size (Bytes)	Description
PDU type	Unsigned Integer	4	An integer value that indicates the type of PDU. Refer to Table II for the list of PDU types.
Request ID	Unsigned Integer	4	An identifier to match requests with replies. The mobile device sets the Request ID in the request PDU and then is copied by the controller and the clone in the response PDU when offloading. The controller sets this attribute when sending resource management messages.
ACK	Unsigned Integer	4	0 if response packet, 1 if Acknowledgement packet and, request rejection packet if the value > 1
Object Binding	Object	Variable	A set of name-value pairs identifying application objects to execute, user data and error messages with their corresponding object references. Refer to Table III for object definition.

TABLE III
DEFINITIONS OF OBJECT BINDING NAME-VALUE PAIR

Subfield Name	Value Type	Size (Bytes)	Description
Object_Name	Sequence of Integer	Variable	Object identifier (code, user, data, application error)
Object_Value	Object	Variable	Contains the values of the specified object type.

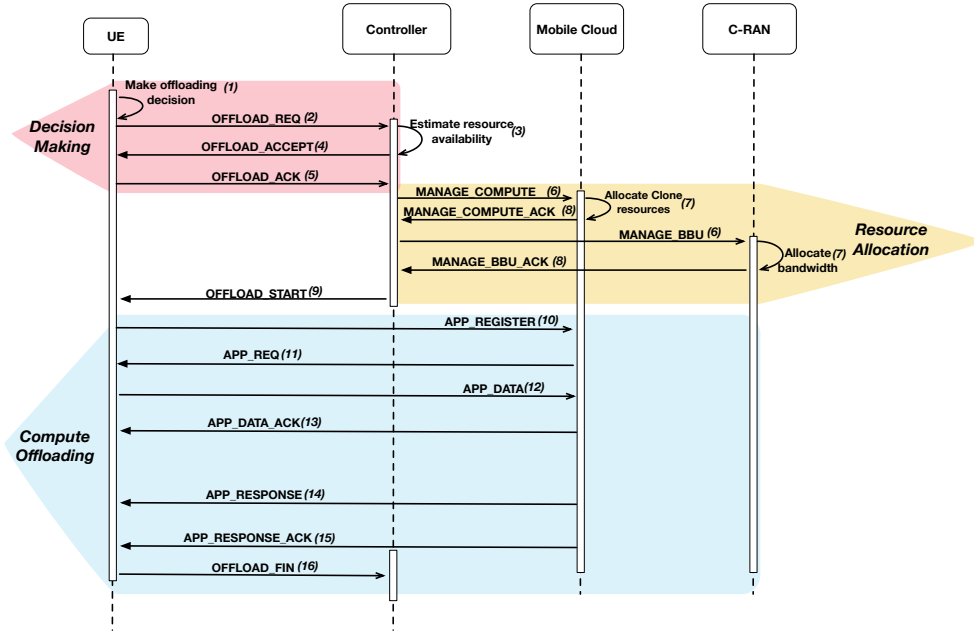

Fig. 3. Unified Offloading Protocol: Procedure when successfully allocates resources

UE receives the *Offload_Start* message with corresponding information about the offloading location (the clone), it successfully carries out offloading tasks. In the above figure, the acknowledgement messages are shown by appending “_ACK” at the end of corresponding originating message name, to indicate the ACK bits has been set to 1 in the packet header. Resource monitoring is out of the scope of this protocol, and it is assumed that the controller uses existing monitoring protocols for monitoring C-RAN and mobile cloud resources. Moreover, C-RAN resource allocation, estimation and prediction algorithms are out of scope of this paper.

III. EVALUATION

A. Testbed Implementation

Figure 4 shows the test environment set up for evaluating the proposed architecture. There are two USRP N210 and one X300 have been set up as RRHs of Amarisoft LTE 100 and OpenAirInterface (OAI) software base stations respectively. All nodes in the network are connected via a Gigabit Ethernet switch. The soft base stations are deployed on a Dell PowerEdge R210 rack server. OpenStack with Kernel Virtual Machine (KVM) as the hypervisor, has been deployed

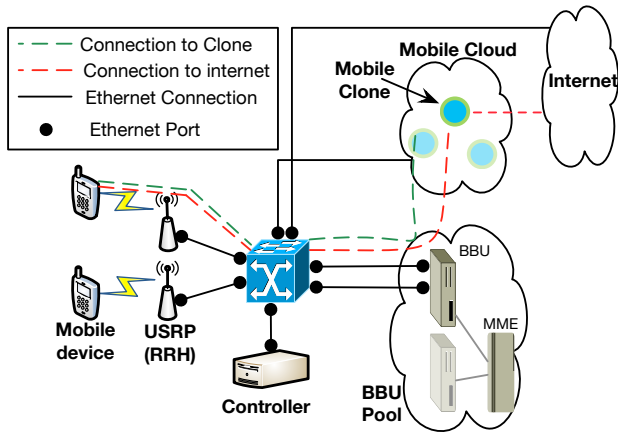

Fig. 4. C-RAN with Mobile Cloud testbed

with no shared storage, for hosting the mobile clones running Android-x86 operating system. Thinkair [4] has been used as the offloading framework, of which the server components have been installed on the clone in mobile cloud, while the client components are installed on the UE running Android 4.4 operating system. The wireless bandwidth of the base stations has been set to 5 MHz. The BBUs are connected to its Mobility Management Entity (MME) via its S1-MME links using S1 Application Protocol (S1AP) that provides signalling between E-UTRAN and the evolved packet core (EPC). Host sFlow and sFlow-RT, monitoring and analytical tools, has been deployed on the controller as a part of the Resource Monitor for monitoring resources in the mobile cloud. We have also developed a monitoring module and a dashboard for monitoring wireless resources in the Mobile Cloud-RAN.

B. Vertical Scaling for Resource Management in Mobile Cloud

Prior to sending resource management instructions to the mobile cloud, using the proposed protocol, the resource management decisions are made in the controller. Auto-scaling in IaaS (Infrastructure as a Service) clouds has been studied extensively in the literature, for allocating computing resource optimally, while assuring Service Level Agreement (SLA) requirements and keeping the overall cost to a minimum. Although there exists an abundance of work on cloud auto-scaling, fundamental aspects of underlying technologies and algorithms that affect the performance of auto-scaling need improvement. Some known aspects of cloud computing that require improvements are [14] [12] [16], real-time hypervisors, real-time operating systems (OS), OS support for Cloudification (e.g. native cloud orchestration support in OSs), improved host resource sharing among guests (e.g. reduced latency), user friendly cost models and auto-scaling techniques for real-time applications. Specifically, when adopting cloud technologies into mobile systems, issues mentioned above are imperative due to high QoS/QoE requirements and dynamic nature of wireless networks and mobile applications [17] [18]. However, addressing aforementioned is out of scope of this paper. Our

focus has been drawn to providing an extensive performance analysis of cloud vertical scaling, for improving auto-scaling algorithms, for real-time delay-sensitive applications (e.g. mobile task offloading) on existing cloud environments.

Cloud auto-scaling techniques are divided into predictive and reactive categories. Throughout literature authors have used various reactive and proactive techniques to do horizontal auto-scaling [19] [20] [21] [22] [23] by adding or removing VMs to/from a cloud application. Similarly vertical scaling [24] [25] [26] [27] is done by adding or removing resources to/from existing VMs. Although throughout literature threshold rules based techniques seem to be most popular among authors, it can be seen that reinforcement learning, queuing theory, control theory, time series analysis have also been widely used. For both horizontal and vertical scaling, resource provisioning introduces a delay. Therefore the desired effect may arrive when it is too late. Current literature stresses the need for future work on auto-scaling focusing on reducing the time required to provision new VMs (or resize VMs when vertically scaling) [14]. Moreover, comparatively horizontal scaling has been used predominantly in literature and by cloud service providers.

Vertical scaling is known to have a lower range when it comes to scaling [13], and for the changed resources to take effect, the VMs have to be restarted [14]. Even if the underlying virtualization technology allows you to scale VMs without restarting (e.g. Xen CPU hot-plug), it may take up to 5-10 minutes for the changes to take effect and to be stabilised [25] [28]. Moreover, this is because most conventional operating systems do not allow real-time dynamic configurations on the VMs without rebooting [14], and [25] reports this can also be partially due to the backlog of requests in prior intervals. However, in literature authors have proposed a number of vertical scaling algorithms, and they assume that vertical scaling actions can be performed timely, or the auto-scaling algorithms use hot-plugging [26] [28] [25] [24]. However, the latter is not possible with most of other popular hypervisors (e.g. Kernel Virtual Machine), cloud platforms (e.g. OpenStack) and cloud service providers (e.g. Amazon EC2 [29]) [14]. Due to above reasons, horizontal scaling has been more attractive to the community and has been adopted by existing cloud service providers instead of vertical scaling [24] [29]. Elastic Application Container (EAP) proposes an alternative provisioning mechanism to heavy VM provisioning [30], but it requires you to alter the underlying infrastructure. Furthermore some authors have proposed horizontal-vertical hybrid scaling systems where both approaches are used simultaneously for increasing performance, by utilising benefits of both methodologies [31] [24] [32] [33] [13].

It is considered wasteful to use a VM as the smallest resource unit when allocating computing resources to a cloud application. The new VMs that are assigned to the applications are not used immediately after, and each VM consumes resources that are not directly utilised by the applications [24]. As the number of VMs increase, the total number of resources that are consumed for just hosting and for keeping

the VMs alive also increase. Furthermore, adding or removing a whole VM to an application is not always required for many real world scenarios [24], but subtle changes such as adding or removing available resources are sufficient. Dutta *et al.* [13] claims further that, while horizontal scaling allows the application to achieve higher throughput levels per each addition, the deployment cost is greater than vertical scaling. Therefore, this lead us to investigate further into performance trends of cloud vertical scaling.

The prototype described above has been left with out-of-the-box configurations for most software components (e.g. OpenStack), for making the evaluation results as generic as possible. The following analysis on VM creation and resizing times has been carried out by repeating each experiment 60 times for reducing noise due to other unavoidable influences within the environment. If the proposed protocol is used for vertical scaling, then the *Manage_Compute* PDU type can be used with the desired vCPU amount set in *Object_Binding* field of the packet (e.g. vcpu=4).

There are two basic functions that one may perform on VMs when scaling either horizontally or vertically. One may instantiate and terminate new VMs behind a load balancer, or one would use a resizing function that is provided by the underlying cloud platform (hypervisor). Moreover, in this case, the Kernel Virtual Machine (KVM) environment allows the user to instantiate and terminate VMs. Figure 5 depicts how the VM instantiation time has been influenced by all other VM created within the same cloud environment. We have applied a moving average function on the data for smoothing out the gathered results to highlight the increasing trend in data. The above graph clarifies the observations made by [34], where auto-scaling actions (horizontal) typically get delays in orders of minutes on public cloud service providers (Amazon EC2, Azure and Rackspace). The above is mainly due to the increased request backlog and due to the time that it takes to assign a physical server to deploy a VM, then to move the VM image to it and get it fully operational. This further shows that instance start-time changes depending on the number of active VMs in the cloud at a given time. Moreover, when predicting the VM start times, knowledge on historical start delay times may help. We further stress that although the trend in data may be similar, the exact numbers at given points may change depending on the cloud environment. Therefore, one may expect future cloud service providers to provide such data to be used by users when auto-scaling.

We categorised auto-scaling into two scenarios. 1) Resizing continuously; the resources are added or removed by one at each iteration, 2) the resources are added or removed by amounts other than 1 (e.g. +1, +2, +3, +4). For the sake of the discussion, we call the latter "non-continuous". The former method may be suitable for algorithms that decide *when* to scale (and later scales by adding/removing only one resource), and the latter method may be appropriate for algorithms that decide the *amount* of resources to be added or removed at a given time. To avoid the after effects that may be caused by the previous iteration of auto-scaling commands, to the

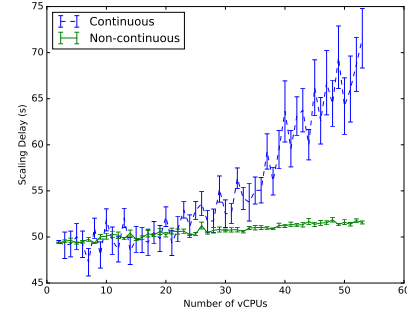

Fig. 6. Mean CPU upscale delay as the size of the base VM increases. The standard error shows variations in results

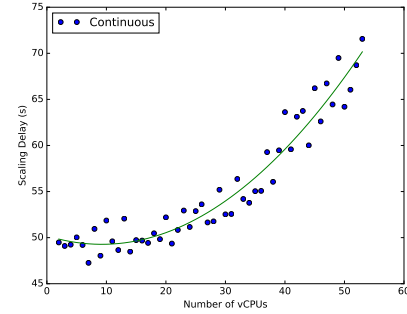

Fig. 7. Second order polynomial function of mean CPU upscale time in continuous scenario

current iteration, we have added a 5-second sleep between each command.

We applied polynomial curve fitting [35] on the empirical data to further demonstrate how up and down scaling delay times vary across different types of resource and when different types of scaling are employed (continuously vs. non-continuously). Specifically, we have used a function of the form in equation 1 for fitting the data, where M denotes the order of the polynomial function, given a training data set comprising N observations of x , where $x \equiv (x_1, \dots, x_N)$ and corresponding observations $t \equiv (t_1, \dots, t_N)$. The vector W contains the polynomial coefficients w_0, \dots, w_M .

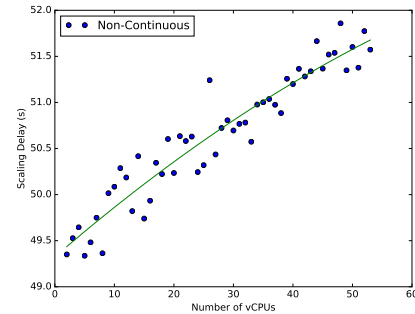

Fig. 8. Second order polynomial function of mean CPU upscale time in non-continuous scenario

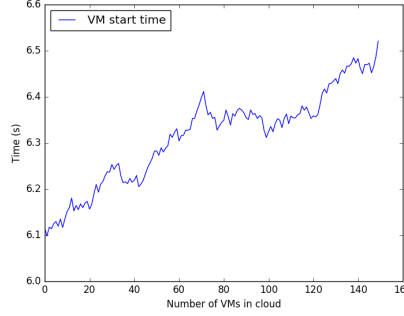

Fig. 5. The VM start time as the number of instances increases in the cloud globally

$$y(x, W) = w_0 + w_1x + w_2x^2 + \dots + w_Mx^M = \sum_{j=0}^M w_jx^j \quad (1)$$

The coefficients are calculated by fitting the polynomial to the provided scaling delay data by minimising the squared error $E(W)$, as shown in equation 2.

$$E(W) = \sum_{n=0}^N |y(x_n, W) - t_n|^2 \quad (2)$$

where t_n denotes the corresponding target values for x_n . It measures the misfit between the function $y(x, W)$, for any given value of W and scaling delay data points. We have calculated the second order polynomial function using least square polynomial fit [35] for the data, only for illustrating trends in data and to show differences in values, as shown in second order polynomial equation 3. Such a model can be adapted to the architecture proposed in this paper where the polynomial function is used for predicting resize delays in the mobile cloud controller (when making auto-scaling decisions), the order of the polynomial function should be chosen to fit the data best. For providing further insight into the analysis, we have provided the polynomial coefficients in Table IV that can be used with the equation 3 for evaluating vertical scaling algorithms in future. In equation 3 the w_2, w_1, w_0 coefficients can be looked up from the Table IV, while x denotes the amount of resources to evaluate on.

$$y(x) = w_2x^2 + w_1x + w_0 \quad (3)$$

CPU resizing has been more often used than resizing other resources. Figure 6 shows that the time varies when adding resources, depending on the vCPU amount it increases from (i.e. the number of vCPUs that the VM has before resizing), in continuous auto-scaling scenario. Another observation that we can gather from the graph is that the VM resizing time increases as the size of the VM increases. One may observe that the change in results in the non-continuous scenario is much smaller as the scale of the VM increases, albeit there is still an increasing trend. The aforementioned statements are further clarified in Figure 7 and Figure 8 respectively. Both

TABLE IV
POLYNOMIAL COEFFICIENTS OF SECOND ORDER POLYNOMIAL FUNCTION FOR THE SCALING SCENARIOS

Scaling Scenario	Coefficients		
	w_2	w_1	w_0
Figure 7	0.0109	0.2013	50.2
Figure 8	-0.0002161	0.05584	49.32
Figure 10	0.01358	0.3637	51.61
Figure 11	0.0003889	0.04552	66.85
Figure 13	-1.159e-05	0.1038	46.92
Figure 14	2.837e-05	0.008834	47.05
Figure 16	-0.002184	0.04266	49.07
Figure 17	0.007889	0.1701	50.31
Figure 19	0.1402	2.375	56.91
Figure 20	0.03394	0.6107	53.26

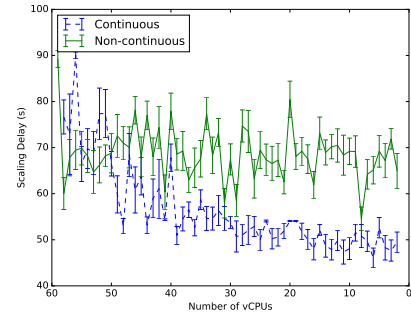

Fig. 9. Mean CPU downscale delay as the size of the base VM increases. The standard error shows variations in results

Figures 7 and 8 show second order regression functions of results for continuous and non-continuous scenarios respectively, depicting that time delay increases as the VM size increases. The graph also shows the standard error of each point to show how results varied in the results.

Similarly to VM CPU upscaling, Figure 9, Figure 10 and Figure 11 shows continuous and non-continuous cloud performances of CPU downscaling. Specifically, the Figure 9 depicts a comparison of delay times when virtual CPUs are scaled down continuously and non-continuously. The error bars denote the standard error at each point to show the variations of gathered results. One may observe that this has an opposite trend (decreasing trend) to VM CPU upscaling delay as shown

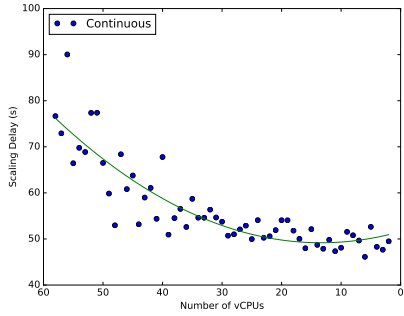

Fig. 10. Second order polynomial function of mean CPU downscale time in continuous scenario

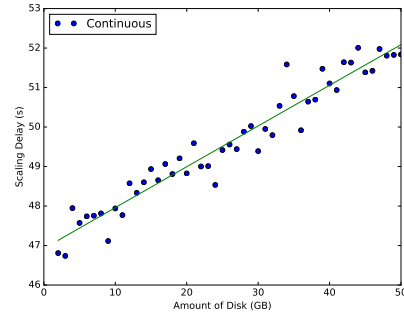

Fig. 13. Second order polynomial function of mean disk upscale time in continuous scenario

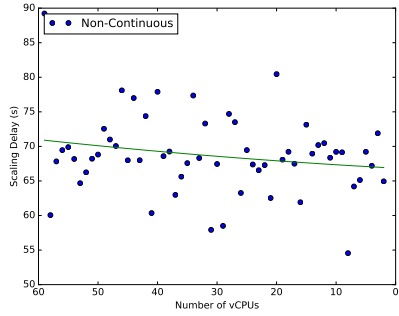

Fig. 11. Second order polynomial function of mean CPU downscale time in non-continuous scenario

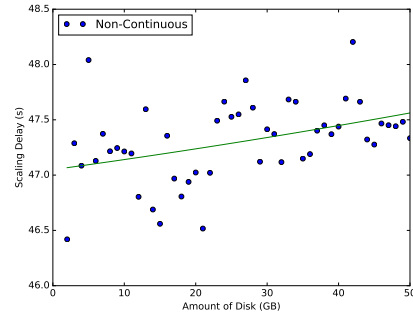

Fig. 14. Second order polynomial function of mean disk upscale time in non-continuous scenario

in Figure 6, where the delay time decreases as more CPUs are removed from the VM. One may conclude from the analysis that the resize time is greatly influenced by the size of the VM when scaling computing resources (i.e. the number of CPUs the VM has before resizing). Moreover, the Figure 10 and the Figure 11 shows second order polynomial function of both continuous and non-continuous mean CPU downscaling delay in cloud respectively. Furthermore, the observations suggest that when designing auto-scaling algorithms that scale CPU resources, the future work should consider the time differences when scaling continuously and scaling non-continuously.

According to our experiments, the second most influential

resource on the resize time delay is the VM disk size. However, in the used test environment, disk downscaling is not supported by the cloud framework (OpenStack with KVM). Therefore only the upscaling results are presented. The Figure 12 shows an opposite trend to the CPU resize time delays in Figure 6. In this experiment, the non-continuous resizing time delays appear to be higher than when resizing continuously. Moreover, the resize time does not show any significant increases or decreases as the amount of disk space increase in the non-continuous scenario. A second order polynomial regression analysis has been carried out in Figure 14 further clarifying the above observation.

It is clear that the resize delay time increases as the VM's disk size increases in the continuous VM scaling scenario as shown in Figure 13. Such an observation is expected, as when resizing, some hypervisors (e.g. KVM) take a snapshot of the running VM, then a new resized VM is created from the snapshot with changed configurations (often on a different compute node). Then the old VM gets deleted. Whereas, when we have conducted the non-continuous auto-scaling experiment, we chose 1GB as the base VM disk size. Therefore, one can expect the effect of the base disk size when resizing at each step to be even. Moreover, the base disk size stays constant when scaled non-continuously, although the VM is resized to a different disk size.

Despite all of the above clear trends in results, when analysing resizing time delays when resizing RAM resource on

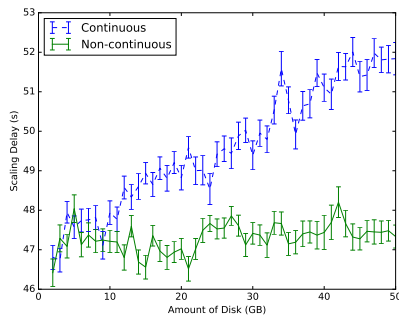

Fig. 12. Mean disk upscale delay as the size of the base VM increases. The standard error shows variations (error) in data

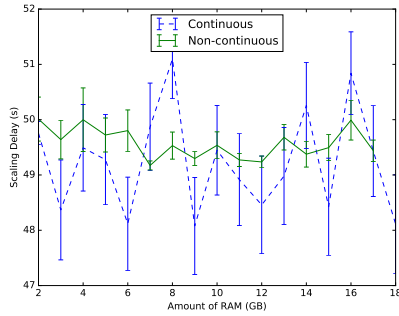

Fig. 15. Mean RAM upscale delay as the size of the base VM increases. The standard error shows variations (error) in data

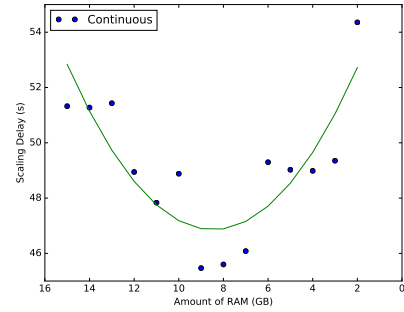

Fig. 19. Second order polynomial function of mean RAM downscale time in continuous scenario

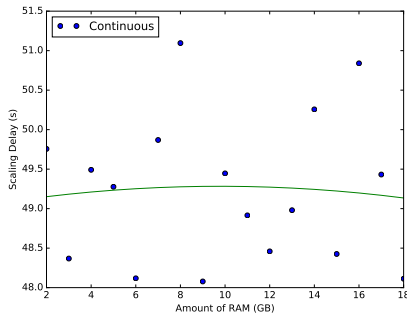

Fig. 16. Second order polynomial function of mean RAM upscale time in continuous scenario

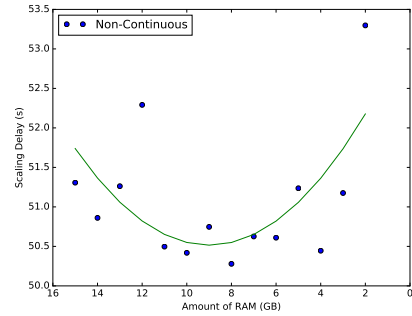

Fig. 20. Second order polynomial function of mean RAM downscale time in non-continuous scenario

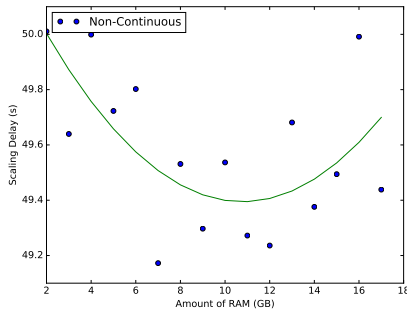

Fig. 17. Second order polynomial function of mean RAM upscale time in non-continuous scenario

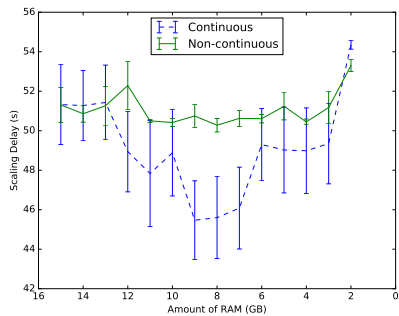

Fig. 18. Mean RAM downscale delay as the size of the base VM increases. The standard error shows variations (error) in data

VMs, no distinctive trends were found in both continuous and non-continuous scenarios, as shown in Figure 15 for upscaling and 18 for RAM downscaling. However, this could be due to the fact that the test-bed's maximum memory resource limit is 18GB, and the sample amount is not large enough to see clear trends. The second order polynomial regression analyses show decreasing trends on both continuous and non-continuous scenarios, in Figure 16 and in 17, in continuous and non-continuous upscaling scenarios respectively. Moreover Figure 19 and Figure 20 shows a second order polynomial regression analysis of both continuous and non-continuous downscaling of RAM resources.

From the lessons learned from above empirical VM resize performance analysis, it is evident that careful attention should be paid to the time delays when resizing CPU and storage resources of VMs, for real-time applications. Due to the significant delay incurred by the cloud framework (e.g. over 50 seconds in Figure 7), it may not be practical to auto-scale in real-time for delay-constrained applications. Instead, the controller may initiate the VM scaling process before the task execution (or by migrating tasks to another VM, during the resize process). The auto-scaling delay trends may vary depending on the underlying technologies (e.g. virtualization and physical resource management) that are deployed. This analysis brings awareness to the community that auto-scaling delays depend not only on the resource type but also on the auto-scaling method, i.e., upscaling, downscaling, continuous

and non-continuous. We would like to stress that, when designing auto-scaling algorithms, CPU and storage resizing delay trends with various conditions of the VMs itself (e.g. VM size) and of the environment (e.g. total VM count in the cloud) that they are hosted in, should be considered. We have discovered that it is important to use both the knowledge of the VM itself and the cloud environment together at the same time, in future vertical scaling algorithms.

IV. CONCLUSION

This paper has introduced a protocol that uses a simple unified packet header for both resource management and task offloading. A new logical controller that receives instantaneous monitoring information from both computing and communication sides and makes efficient resource management decisions on both C-RAN and mobile cloud for mobile task offloading.

We conducted an analysis on scaling up and scaling down performances of MCC resources. The analysis shows that auto-scaling performances of all storage, CPU and RAM resources vary when scaling resources vertically. We can also conclude that auto-scaling in real-time is not practical due to high auto-scaling delay. The results also revealed that scaling time delay depends on the amount of resources that are added or removed from the VM at each step. One may conclude from the auto-scaling delay analysis that it is necessary to analyse auto-scaling performances of each cloud platform due to complex nature of today's cloud systems. Moreover, being aware of the scaling delay time trends may help to make effective auto-scaling decisions.

V. ACKNOWLEDGMENT

This work was supported by UK EPSRC NIRVANA project (EP/L026031/1), EU Horizon 2020 iCIRRUS project (GA-644526).

REFERENCES

- [1] K. Kumar and Y.-H. Lu, "Cloud computing for mobile users: Can offloading computation save energy?," *Computer*, vol. 43, pp. 51–56, April 2010.
- [2] K. Kumar, J. Liu, Y.-H. Lu, and B. Bhargava, "A survey of computation offloading for mobile systems," *Mobile Networks and Applications*, vol. 18, no. 1, pp. 129–140, 2013.
- [3] E. Cuervo, A. Balasubramanian, D.-k. Cho, A. Wolman, S. Saroiu, R. Chandra, and P. Bahl, "Maui: making smartphones last longer with code offload," in *Proceedings of the 8th international conference on Mobile systems, applications, and services*, MobiSys '10, (New York, NY, USA), pp. 49–62, ACM, 2010.
- [4] S. Kosta, A. Aucinas, P. Hui, R. Mortier, and X. Zhang, "Thinkair: Dynamic resource allocation and parallel execution in the cloud for mobile code offloading," in *INFOCOM, 2012 Proceedings IEEE*, pp. 945–953, 2012.
- [5] B.-G. Chun, S. Ihm, P. Maniatis, M. Naik, and A. Patti, "Clonecloud: elastic execution between mobile device and cloud," in *Proceedings of the sixth conference on Computer systems*, EuroSys '11, (New York, NY, USA), pp. 301–314, ACM, 2011.
- [6] R. Kemp, N. Palmer, T. Kielmann, and H. Bal, "Cuckoo: a computation offloading framework for smartphones," in *Mobile Computing, Applications, and Services*, pp. 59–79, Springer, 2012.
- [7] C. Mobile, "C-ran: the road towards green ran," *White Paper, ver.*, vol. 2, 2011.
- [8] J. Tang, W. P. Tay, and T. Q. S. Quek, "Cross-layer resource allocation with elastic service scaling in cloud radio access network," *IEEE Transactions on Wireless Communications*, vol. 14, pp. 5068–5081, Sept 2015.
- [9] W. H. Chin, Z. Fan, and R. Haines, "Emerging technologies and research challenges for 5g wireless networks," *IEEE Wireless Communications*, vol. 21, pp. 106–112, April 2014.
- [10] C. J. Bernardos, A. de la Oliva, P. Serrano, A. Banchs, L. M. Contreras, H. Jin, and J. C. Zuniga, "An architecture for software defined wireless networking," *IEEE Wireless Communications*, vol. 21, pp. 52–61, June 2014.
- [11] H. Ali-Ahmad, C. Cicconetti, A. de la Oliva, V. Mancuso, M. R. Sama, P. Seite, and S. Shanmugalingam, "An sdn-based network architecture for extremely dense wireless networks," in *Future Networks and Services (SDN4FNS), 2013 IEEE SDN for*, pp. 1–7, Nov 2013.
- [12] Z.-H. Zhan, X.-F. Liu, Y.-J. Gong, J. Zhang, H. S.-H. Chung, and Y. Li, "Cloud computing resource scheduling and a survey of its evolutionary approaches," *ACM Comput. Surv.*, vol. 47, pp. 63:1–63:33, July 2015.
- [13] S. Dutta, S. Gera, A. Verma, and B. Viswanathan, "Smartscale: Automatic application scaling in enterprise clouds," in *Proceedings of the 2012 IEEE Fifth International Conference on Cloud Computing, CLOUD '12*, (Washington, DC, USA), pp. 221–228, IEEE Computer Society, 2012.
- [14] T. Lorida-Botran, J. Miguel-Alonso, and J. A. Lozano, "A review of auto-scaling techniques for elastic applications in cloud environments," *J. Grid Comput.*, vol. 12, pp. 559–592, Dec. 2014.
- [15] N. Gray, "Performance of java middleware-java rmi, jaxrpc, and corba," 2005.
- [16] D. Puthal, B. P. S. Sahoo, S. Mishra, and S. Swain, "Cloud computing features, issues, and challenges: A big picture," in *Computational Intelligence and Networks (CINE), 2015 International Conference on*, pp. 116–123, Jan 2015.
- [17] Y. W. Ahn, A. M. K. Cheng, J. Baek, M. Jo, and H. H. Chen, "An auto-scaling mechanism for virtual resources to support mobile, pervasive, real-time healthcare applications in cloud computing," *IEEE Network*, vol. 27, pp. 62–68, September 2013.
- [18] N. Kumar, K. Kaur, A. Jindal, and J. J. Rodrigues, "Providing healthcare services on-the-fly using multi-player cooperation game theory in internet of vehicles (ioV) environment," *Digital Communications and Networks*, vol. 1, no. 3, pp. 191 – 203, 2015.
- [19] P. Bodík, R. Griffith, C. Sutton, A. Fox, M. Jordan, and D. Patterson, "Statistical machine learning makes automatic control practical for internet datacenters," in *Proceedings of the 2009 Conference on Hot Topics in Cloud Computing*, HotCloud'09, (Berkeley, CA, USA), USENIX Association, 2009.
- [20] E. Barrett, E. Howley, and J. Duggan, "Applying reinforcement learning towards automating resource allocation and application scalability in the cloud," *Concurrency and Computation: Practice and Experience*, vol. 25, no. 12, pp. 1656–1674, 2013.
- [21] A. Ali-Eldin, J. Tordsson, and E. Elmroth, "An adaptive hybrid elasticity controller for cloud infrastructures," in *2012 IEEE Network Operations and Management Symposium*, pp. 204–212, April 2012.
- [22] B. Simmons, H. Ghanbari, M. Litoiu, and G. Iszlai, "Managing a saas application in the cloud using paas policy sets and a strategy-tree," in *2011 7th International Conference on Network and Service Management*, pp. 1–5, Oct 2011.
- [23] X. Dutreilh, A. Moreau, J. Malenfant, N. Rivierre, and I. Truck, "From data center resource allocation to control theory and back," in *2010 IEEE 3rd International Conference on Cloud Computing*, pp. 410–417, July 2010.
- [24] R. Han, L. Guo, M. M. Ghanem, and Y. Guo, "Lightweight resource scaling for cloud applications," in *Cluster, Cloud and Grid Computing (CCGrid), 2012 12th IEEE/ACM International Symposium on*, pp. 644–651, May 2012.
- [25] J. Rao, X. Bu, C.-Z. Xu, L. Wang, and G. Yin, "Vconf: A reinforcement learning approach to virtual machines auto-configuration," in *Proceedings of the 6th International Conference on Autonomic Computing, ICAC '09*, (New York, NY, USA), pp. 137–146, ACM, 2009.
- [26] S. M. Park and M. Humphrey, "Self-tuning virtual machines for predictable science," in *Cluster Computing and the Grid, 2009. CCGRID '09. 9th IEEE/ACM International Symposium on*, pp. 356–363, May 2009.
- [27] Z. Shen, S. Subbiah, X. Gu, and J. Wilkes, "Cloudscale: Elastic resource scaling for multi-tenant cloud systems," in *Proceedings of the 2Nd ACM*

Symposium on Cloud Computing, SOCC '11, (New York, NY, USA), pp. 5:1–5:14, ACM, 2011.

- [28] J. Rao, X. Bu, C. Z. Xu, and K. Wang, "A distributed self-learning approach for elastic provisioning of virtualized cloud resources," in *2011 IEEE 19th Annual International Symposium on Modelling, Analysis, and Simulation of Computer and Telecommunication Systems*, pp. 45–54, July 2011.
- [29] W. H. Liao, S. C. Kuai, and Y. R. Leau, "Auto-scaling strategy for amazon web services in cloud computing," in *2015 IEEE International Conference on Smart City/SocialCom/SustainCom (SmartCity)*, pp. 1059–1064, Dec 2015.
- [30] S. He, L. Guo, Y. Guo, C. Wu, M. Ghanem, and R. Han, "Elastic application container: A lightweight approach for cloud resource provisioning," in *2012 IEEE 26th International Conference on Advanced Information Networking and Applications*, pp. 15–22, March 2012.
- [31] F. L. Ferraris, D. Franceschelli, M. P. Gioiosa, D. Lucia, D. Ardagna, E. D. Nitto, and T. Sharif, "Evaluating the auto scaling performance of flexiscale and amazon ec2 clouds," in *Symbolic and Numeric Algorithms for Scientific Computing (SYNASC), 2012 14th International Symposium on*, pp. 423–429, Sept 2012.
- [32] M. Z. Hasan, E. Magana, A. Clemm, L. Tucker, and S. L. D. Gudreddi, "Integrated and autonomic cloud resource scaling," in *2012 IEEE Network Operations and Management Symposium*, pp. 1327–1334, April 2012.
- [33] S. Khatua, A. Ghosh, and N. Mukherjee, "Optimizing the utilization of virtual resources in cloud environment," in *2010 IEEE International Conference on Virtual Environments, Human-Computer Interfaces and Measurement Systems*, pp. 82–87, Sept 2010.
- [34] M. Mao and M. Humphrey, "A performance study on the vm startup time in the cloud," in *Cloud Computing (CLOUD), 2012 IEEE 5th International Conference on*, pp. 423–430, June 2012.
- [35] C. M. Bishop, "Pattern recognition," *Machine Learning*, vol. 128, pp. 1–58, 2006.