LEARNING TO REINFORCEMENT LEARN

**JX Wang¹, Z Kurth-Nelson¹, D Tirumala¹, H Soyer¹, JZ Leibo¹,
R Munos¹, C Blundell¹, D Kumaran^{1,3}, M Botvinick^{1,2}**

¹DeepMind, London, UK

²Gatsby Computational Neuroscience Unit, UCL, London, UK

³Institute of Cognitive Neuroscience, UCL, London, UK

{wangjane, zebk, dhruvat, soyer, jzl, munos, cblundell,
dkumaran, botvinick}@google.com

ABSTRACT

In recent years deep reinforcement learning (RL) systems have attained superhuman performance in a number of challenging task domains. However, a major limitation of such applications is their demand for massive amounts of training data. A critical present objective is thus to develop deep RL methods that can adapt rapidly to new tasks. In the present work we introduce a novel approach to this challenge, which we refer to as deep meta-reinforcement learning. Previous work has shown that recurrent networks can support meta-learning in a fully supervised context. We extend this approach to the RL setting. What emerges is a system that is trained using one RL algorithm, but whose recurrent dynamics implement a second, quite separate RL procedure. This second, learned RL algorithm can differ from the original one in arbitrary ways. Importantly, because it is learned, it is configured to exploit structure in the training domain. We unpack these points in a series of seven proof-of-concept experiments, each of which examines a key aspect of deep meta-RL. We consider prospects for extending and scaling up the approach, and also point out some potentially important implications for neuroscience.

1 INTRODUCTION

Recent advances have allowed long-standing methods for reinforcement learning (RL) to be newly extended to such complex and large-scale task environments as Atari (Mnih et al., 2015) and Go (Silver et al., 2016). The key enabling breakthrough has been the development of techniques allowing the stable integration of RL with non-linear function approximation through deep learning (LeCun et al., 2015; Mnih et al., 2015). The resulting deep RL methods are attaining human- and often superhuman-level performance in an expanding list of domains (Jaderberg et al., 2017; Mnih et al., 2015; Silver et al., 2016). However, there are at least two aspects of human performance that they starkly lack. First, deep RL typically requires a massive volume of training data, whereas human learners can attain reasonable performance on any of a wide range of tasks with comparatively little experience. Second, deep RL systems typically specialize on one restricted task domain, whereas human learners can flexibly adapt to changing task conditions. Recent critiques (e.g., Lake et al., 2016) have invoked these differences as posing a direct challenge to current deep RL research.

In the present work, we outline a framework for meeting these challenges, which we refer to as *deep meta-reinforcement learning*, a label that is intended to both link it with and distinguish it from previous work employing the term “meta-reinforcement learning” (e.g. Schmidhuber et al., 1996; Schweighofer and Doya, 2003, discussed later). The basic idea is to use standard deep RL techniques to train a recurrent neural network, in such a way that the recurrent network comes to implement its own, free-standing RL procedure. As we shall illustrate, under the right circumstances, the secondary learned RL procedure can display an adaptiveness and sample efficiency that the original RL procedure lacks.

The following sections review previous work employing recurrent neural networks in the context of meta-learning and describe the general approach for extending such methods to the RL setting. We

then present seven proof-of-concept experiments, each of which highlights an important ramification of the deep meta-RL setup by characterizing agent performance in light of this framework. We close with a discussion of key challenges for next-step research, as well as some potential implications for neuroscience.

2 METHODS

2.1 BACKGROUND: META-LEARNING IN RECURRENT NEURAL NETWORKS

Flexible, data-efficient learning naturally requires the operation of prior biases. In general terms, such biases can derive from two sources; they can either be engineered into the learning system (as, for example, in convolutional networks), or they can themselves be acquired through learning. The second case has been explored in the machine learning literature under the rubric of *meta-learning* (Schmidhuber et al., 1996; Thrun and Pratt, 1998).

In one standard setup, the learning agent is confronted with a series of tasks that differ from one another but also share some underlying set of regularities. Meta-learning is then defined as an effect whereby the agent improves its performance in each new task more rapidly, on average, than in past tasks (Thrun and Pratt, 1998). At an architectural level, meta-learning has generally been conceptualized as involving two learning systems: one lower-level system that learns relatively quickly, and which is primarily responsible for adapting to each new task; and a slower higher-level system that works across tasks to tune and improve the lower-level system.

A variety of methods have been pursued to implement this basic meta-learning setup, both within the deep learning community and beyond (Thrun and Pratt, 1998). Of particular relevance here is an approach introduced by Hochreiter and colleagues (Hochreiter et al., 2001), in which a recurrent neural network is trained on a series of interrelated tasks using standard backpropagation. A critical aspect of their setup is that the network receives, on each step within a task, an auxiliary input indicating the target output for the preceding step. For example, in a regression task, on each step the network receives as input an x value for which it is desired to output the corresponding y , but the network also receives an input disclosing the target y value for the preceding step (see Hochreiter et al., 2001; Santoro et al., 2016). In this scenario, a different function is used to generate the data in each training episode, but if the functions are all drawn from a single parametric family, then the system gradually tunes into this consistent structure, converging on accurate outputs more and more rapidly across episodes.

One interesting aspect of Hochreiter’s method is that the process that underlies learning within each new task inheres entirely in the dynamics of the recurrent network, rather than in the backpropagation procedure used to tune that network’s weights. Indeed, after an initial training period, the network can improve its performance on new tasks even if the weights are held constant (see also Cotter and Conwell, 1990; Prokhorov et al., 2002; Younger et al., 1999). A second important aspect of the approach is that the learning procedure implemented in the recurrent network is fit to the structure that spans the family of tasks on which the network is trained, embedding biases that allow it to learn efficiently when dealing with tasks from that family.

2.2 DEEP META-RL: DEFINITION AND KEY FEATURES

Importantly, Hochreiter’s original work (Hochreiter et al., 2001), as well as its subsequent extensions (Cotter and Conwell, 1990; Prokhorov et al., 2002; Santoro et al., 2016; Younger et al., 1999) only addressed supervised learning; the auxiliary input provided on each step explicitly indicates the target output on the previous step, and the network is trained using explicit targets. In the present work we consider the implications of applying the same approach in the context of reinforcement learning. Here, the tasks that make up the training series are interrelated RL problems, for example, a series of bandit problems varying only in their parameterization. Rather than presenting target outputs as auxiliary inputs, the agent receives inputs indicating the action output on the previous step and, critically, the quantity of reward resulting from that action. The same reward information is fed in parallel to a deep RL procedure, which tunes the weights of the recurrent network.

It is this setup, as well as its result, that we refer to as deep meta-RL (although from here on, for brevity, we will often simply call it meta-RL, with apologies to authors who have used that term

previously). As in the supervised case, when the approach is successful, the dynamics of the recurrent network come to implement a learning algorithm, entirely separate from the one used to train the network weights. Once again, after sufficient training, learning can occur within each task even if the weights are held constant. However, here the procedure the recurrent network implements is itself a full-fledged reinforcement learning algorithm, which negotiates the exploration-exploitation tradeoff and improves the agent’s policy based on reward outcomes. A key point, which we will emphasize in what follows, is that this learned RL procedure can differ starkly from the algorithm used to train the network’s weights. In particular, its policy update procedure (including features such as the effective learning rate of that procedure), can differ dramatically from those involved in tuning the network weights, and the learned RL procedure can implement its own approach to exploration. Critically, as in the supervised case, the learned RL procedure will be fit to the statistics spanning the multi-task environment, allowing it to adapt rapidly to new task instances.

2.3 FORMALISM

Let us write as \mathcal{D} a distribution (the prior) over Markov Decision Processes (MDPs). We want to demonstrate that meta-RL is able to learn a prior-dependent RL algorithm, in the sense that it will perform well on average on MDPs drawn from \mathcal{D} or slight modifications of \mathcal{D} . An appropriately structured agent, embedding a recurrent neural network, is trained by interacting with a sequence of MDP environments (also called tasks) through episodes. At the start of a new episode, a new MDP task $m \sim \mathcal{D}$ and an initial state for this task are sampled, and the internal state of the agent (i.e., the pattern of activation over its recurrent units) is reset. The agent then executes its action-selection strategy in this environment for a certain number of discrete time-steps. At each step t an action $a_t \in A$ is executed as a function of the whole history $\mathcal{H}_t = \{x_0, a_0, r_0, \dots, x_{t-1}, a_{t-1}, r_{t-1}, x_t\}$ of the agent interacting in the MDP m during the current episode (set of states $\{x_s\}_{0 \leq s \leq t}$, actions $\{a_s\}_{0 \leq s < t}$, and rewards $\{r_s\}_{0 \leq s < t}$ observed since the beginning of the episode, when the recurrent unit was reset). The network weights are trained to maximize the sum of observed rewards over all steps and episodes.

After training, the agent’s policy is fixed (i.e. the weights are frozen, but the activations are changing due to input from the environment and hidden state of the recurrent layer), and is evaluated on a set of MDPs that are drawn either from the same distribution \mathcal{D} or slight modifications of that distribution (to test the generalization capacity of the agent). The internal state is reset at the beginning of the evaluation of any new episode. Since the policy learned by the agent is history-dependent (as it makes uses of a recurrent network), when exposed to any new MDP environment, it is able to adapt and deploy a strategy that optimizes rewards for that task.

3 EXPERIMENTS

In order to evaluate the approach to learning that we have just described, we conducted a series of six proof-of-concept experiments, which we present here along with a seventh experiment originally reported in a related paper (Mirowski et al., 2017). One particular point of interest in these experiments was to see whether meta-RL could be used to learn an adaptive balance between exploration and exploitation, as demanded of any fully-fledged RL procedure. A second and still more important focus was on the question of whether meta-RL can give rise to learning that gains efficiency by capitalizing on task structure.

In order to examine these questions, we performed four experiments focusing on bandit tasks, and two additional experiments focusing on Markov decision problems. All of our experiments (as well as the additional experiment we report) employ a common set of methods, with minor implementational variations. In all experiments, the agent architecture centers on a recurrent neural network (LSTM; Hochreiter and Schmidhuber, 1997) feeding into a soft-max output representing discrete actions. As detailed below, the parameters of this network core, as well as some other architectural details, varied across experiments (see Figure 1). However, it is important to emphasize that comparisons between specific architectures are outside the scope of this paper. Our main aim is to illustrate and validate the meta-RL framework in a more general way. To this end, all experiments used the high-level task setup previously described: Both training and testing were organized into fixed-length episodes, each involving a task randomly sampled from a predetermined task distribution, with LSTM hidden state initialized at the beginning of each episode. Task-specific inputs and action outputs are described

Parameter	Exps. 1 & 2	Exp. 3	Exp. 4	Exp. 5	Exp. 6
No. threads	1	1	1	1	32
No. LSTMs	1	1	1	1	2
No. hidden	48	48	48	48	256/64
Steps unrolled	100	5	150	20	100
β_e	0.05	<i>annealed</i>	<i>annealed</i>	0.05	0.001
β_v	0.05	0.05	0.05	0.05	0.4
Learning rate	<i>tuned</i>	0.001	0.001	<i>tuned</i>	<i>tuned</i>
Discount factor	<i>tuned</i>	0.8	0.8	<i>tuned</i>	<i>tuned</i>
Input	a, r, t	a, r, t	a, r, t	a, r, t, x	a, r, x
Observation	n/a	n/a	n/a	1-hot	RGB (84x84)
No. trials/episode	100	5	150	10	10
Episode length	100	5	150	20	≤ 3600

Table 1: List of hyperparameters. β_e = coefficient of entropy regularization loss; in Exps 3 & 4 is annealed from 1.0 to 0.0 over the course of training. β_v = coefficient of value function loss (Mirowski et al., 2017). r = reward, a = last action, t = current time step, x = current observation. Exp 1: Bandits with independent arms (Section 3.1.1); Exp 2: Bandits with dependent arms I (Section 3.1.2); Exp 3: Bandits with dependent arms II (Section 3.1.3); Exp 4: Restless bandits (Section 3.1.4); Exp 5: The "Two-Step Task" (Section 3.2.1); Exp 6: Learning abstract task structure (Section 3.2.2).

in conjunction with individual experiments. In all experiments except where specified, the input included a scalar indicating the reward received on the preceding time-step as well as a one-hot representation of the action sampled on that time-step.

All reinforcement learning was conducted using the Advantage Actor-Critic algorithm, as detailed in Mnih et al. (2016) and Mirowski et al. (2017) (see also Figure 1). Details of training, including the use of entropy regularization and a combined policy and value estimate loss, closely follow the methods detailed in Mirowski et al. (2017), with the exception that our experiments used a single thread unless otherwise noted. For a full listing of parameters refer to Table 1.

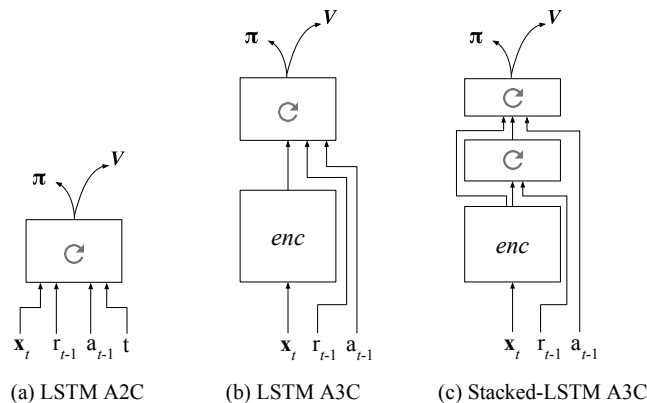

Figure 1: Advantage actor-critic with recurrence. In all architectures, reward and last action are addition inputs to the LSTM. For non-bandit environments, observation is also fed into LSTM either as a one-hot or passed through an encoder model (3-layer encoder: two convolutional layers (first layer: 16 8x8 filters applied with stride 4, second layer: 32 4x4 filters with stride 2) followed by a fully connected layer with 256 units and then a ReLU non-linearity. See for details Mirowski et al. (2017)). For bandit experiments, current time step is also fed in as input. π = policy; v = value function. (a) Architecture used in experiments 1-5 (see Table 1). A3C is the distributed multi-threaded asynchronous version of the advantage actor-critic algorithm (Mnih et al., 2016); A2C is single threaded. (b) Convolutional-LSTM architecture used in experiment 6. (c) Stacked LSTM architecture with convolutional encoder used in experiments 6 and 7.

3.1 BANDIT PROBLEMS

As an initial setting for evaluating meta-RL, we studied a series of bandit problems. Except for a very limited set of bandit environments, such as Bernoulli bandits with independent arms, it is intractable to compute the (prior-dependent) Bayesian-optimal strategy. Here we demonstrate that a recurrent system trained on a set of bandit environments drawn i.i.d. from a given distribution of environments produces a bandit algorithm which performs well on problems drawn from that distribution, and to a certain extent generalizes to related distributions. Thus, meta-RL learns a prior-dependent bandit algorithm.

The specific bandit instantiation of the general meta-RL procedure described in Section 2.3 is defined as follows. Let \mathcal{D} be a *training distribution* over bandit environments. The meta-RL system is trained on a sequence of bandit environments through episodes. At the start of a new episode, its LSTM state is reset and a bandit task $b \sim \mathcal{D}$ is sampled. A bandit task is defined as a set of distributions – one for each arm – from which rewards are sampled. The agent plays in this bandit environment for a certain number of trials and is trained to maximize observed rewards. After training, the agent’s policy is evaluated on a set of bandit tasks that are drawn from a *test distribution* \mathcal{D}' , which can either be the same as \mathcal{D} or a slight modification of it.

We evaluate the resulting performance of the learned bandit algorithm by the cumulative regret, a measure of the loss (in expected rewards) suffered when playing sub-optimal arms. Writing $\mu_a(b)$ the expected reward of arm a in bandit environment b , and $\mu^*(b) = \max_a \mu_a(b) = \mu_{a^*(b)}(b)$ (where $a^*(b)$ is one optimal arm) the optimal expected reward, we define the cumulative regret (in environment b) as $R_T(b) = \sum_{t=1}^T \mu^*(b) - \mu_{a_t}(b)$, where a_t is the arm (action) chosen at time t . We report the performance (average over bandit environments drawn from the test distribution) either in terms of the cumulative regret: $\mathbb{E}_{b \sim \mathcal{D}'} [R_T(b)]$ or in terms of number of sub-optimal pulls: $\mathbb{E}_{b \sim \mathcal{D}'} [\sum_{t=1}^T \mathbb{I}\{a_t \neq a^*(b)\}]$.

3.1.1 BANDITS WITH INDEPENDENT ARMS

We first consider a simple two-armed bandit task to examine the behavior of meta-RL under conditions where theoretical guarantees exist and general purpose algorithms apply. The arm distributions are independent Bernoulli distributions (rewards are 1 with probability p and 0 with probability $1 - p$), where the parameter of each arm (p_1 and p_2) are sampled independently uniformly over $[0, 1]$. We denote by \mathcal{D}_i the corresponding distribution over bandit environments (where the subscript i stands for independent arms).

At the beginning of each episode, a new bandit task is sampled and held constant for 100 trials. Training lasted for 20,000 episodes. The network is given as input the last reward, last action taken, and the trial number t , subsequently producing the action for the next trial $t + 1$ (Figure 1). After training, we evaluated on 300 new episodes with the learning rate set to zero (the learned policy is fixed).

Across model instances, we randomly sampled learning rate, discount, and entropy cost, following Mnih et al. (2016). For all figures, we plotted the average of the top 5 runs of 100 randomly sampled hyperparameter settings, where the top agents were selected from the first half of the 300 evaluation episodes and performance was plotted for the second half. We measured the cumulative expected regret across the episode, comparing with several algorithms tailored for this independent bandit setting: Gittins indices (Gittins, 1979) (which is Bayesian optimal in the finite-horizon case), UCB (Auer et al., 2002) (which comes with theoretical finite-time regret guarantees), and Thompson sampling (Thompson, 1933) (which is asymptotically optimal in this setting: see Kaufmann et al., 2012b). Model simulations were conducted with the PymaBandits toolbox from (Kaufmann et al., 2012a) and custom Matlab scripts.

As shown in Figure 2a (green line; "Independent"), meta-RL outperforms both Thompson sampling (gray dashed line) and UCB (light gray dashed line), although it performs less well compared to Gittins (black dashed line). To verify the critical importance of providing reward information to the LSTM, we removed this input, leaving all other inputs as before. As expected, performance was at chance levels on all bandit tasks.

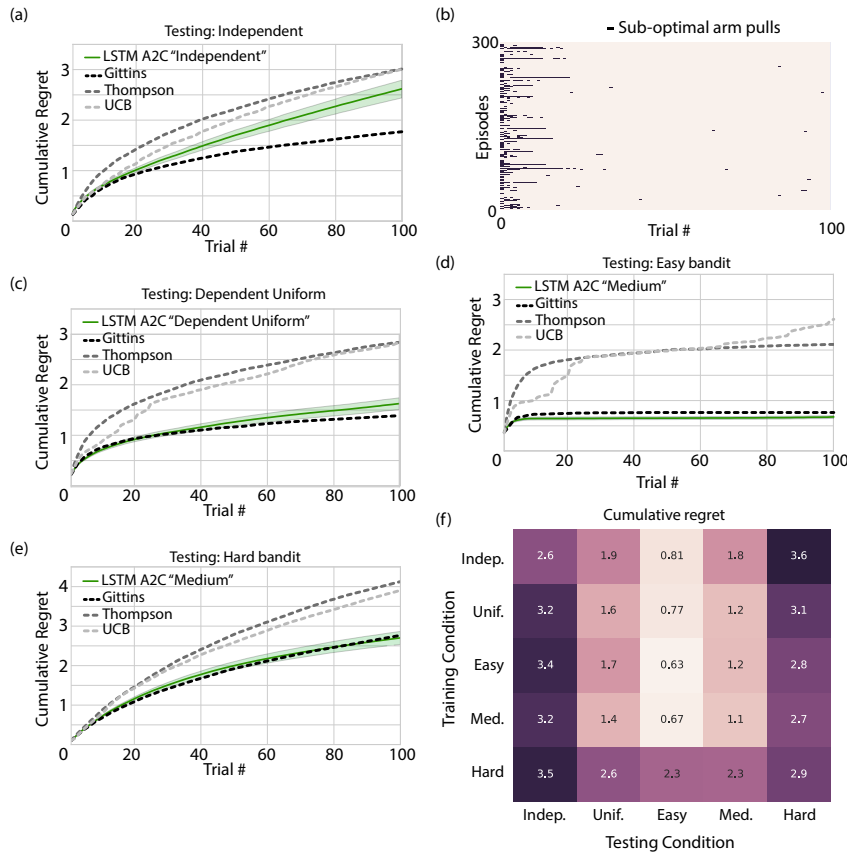

Figure 2: Performance on independent- and correlated-arm bandits. We report performance as the cumulative expected regret R_T for 150 test episodes, averaged over the top 5 hyperparameters for each agent-task configuration, where the top 5 was determined based on performance on a separate set of 150 test episodes. (a) LSTM A2C trained and evaluated on bandits with independent arms (distribution \mathcal{D}_i ; see text), and compared with theoretically optimal models. (b) A single agent playing the medium difficulty task with distribution \mathcal{D}_m . Suboptimal arm pulls over trials are depicted for 300 episodes. (c) LSTM A2C trained and evaluated on bandits with dependent uniform arms (distribution \mathcal{D}_u), (d) trained on medium bandit tasks (\mathcal{D}_m) and tested on easy (\mathcal{D}_e), and (e) trained on medium (\mathcal{D}_m) and tested on hard task (\mathcal{D}_h). (f) Cumulative regret for all possible combinations of training and testing environments ($\mathcal{D}_i, \mathcal{D}_u, \mathcal{D}_e, \mathcal{D}_m, \mathcal{D}_h$).

3.1.2 BANDITS WITH DEPENDENT ARMS (I)

As we have emphasized, a key property of meta-RL is that it gives rise to a learned RL algorithm that exploits consistent structure in the training distribution. In order to garner empirical evidence for this point, we tested the agent from our first experiment in a more structured bandit task. Specifically, we trained the system on two-arm bandits in which arm reward distributions are correlated. In this setting, unlike the one studied in the previous section, experience with either arm provides information about the other. Standard bandit algorithms, including UCB and Thompson sampling, perform suboptimally in this setting, as they are not designed to exploit such correlations. In some cases it is possible to tailor algorithms for specific arm structures (see for example Lattimore and Munos, 2014), but extensive problem-specific analysis is typically required. Our approach aims to learn a structure-dependent bandit algorithm directly from experience with the target bandit domain.

We consider Bernoulli distributions where the parameters (p_1, p_2) of the two arms are correlated in the sense that $p_1 = 1 - p_2$. We consider several training and test distributions. The *uniform* means that $p_1 \sim \mathcal{U}([0, 1])$ (uniform distribution over the unit interval). The *easy* means that $p_1 \sim \mathcal{U}(\{0.1, 0.9\})$ (uniform distribution over those two possible values), and similarly we call *medium* when $p_1 \sim \mathcal{U}(\{0.25, 0.75\})$ and *hard* when $p_1 \sim \mathcal{U}(\{0.4, 0.6\})$. We denote by $\mathcal{D}_u, \mathcal{D}_e, \mathcal{D}_m$, and \mathcal{D}_h the corresponding induced distributions over bandit environments. In addition

we also considered the independent uniform distribution (as in the previous section, \mathcal{D}_i) where $p_1, p_2 \sim \mathcal{U}([0, 1])$ independently. Agents were both trained and tested on those five distributions over bandit environments (among which four correspond to correlated distributions: $\mathcal{D}_u, \mathcal{D}_e, \mathcal{D}_m$ and \mathcal{D}_h ; and one to the independent case: \mathcal{D}_i). As a validation of the names given to the task distributions ($\mathcal{D}_e, \mathcal{D}_m, \mathcal{D}_h$), results show that the easy task is easier to learn than the medium which itself is easier than the hard one (Figure 2f). This is compatible with the general notion that the hardness of a bandit problem is inversely proportional to the difference between the expected reward of the optimal and sub-optimal arms. We again noted that that withholding the reward input to the LSTM resulted in chance performance on even the easiest bandit task, as should be expected.

Figure 2f reports the results of all possible training-testing regimes. From observing the cumulative expected regrets, we make the following observations: i) agents trained in structured environments ($\mathcal{D}_u, \mathcal{D}_e, \mathcal{D}_m$, and \mathcal{D}_h) develop prior knowledge that can be used effectively when tested on structured distributions – performing comparably to Gittins (Figure 2c-f), and superiorly compared to agents trained on independent arms (\mathcal{D}_i) in all structured tasks at test (Figure 2f). This is because an agent trained on independent rewards (\mathcal{D}_i) has not learned to exploit the reward correlations that are useful in those structured tasks. ii) Conversely, previous training on any structured distribution ($\mathcal{D}_u, \mathcal{D}_e, \mathcal{D}_m$, or \mathcal{D}_h) hurts agents when they are tested on an independent distribution (\mathcal{D}_i ; Figure 2f). This makes sense as training on correlated arms may produce a policy that relies on specific reward structure, thereby impacting performance in problems where no such structure exists. iii) Whilst the previous results emphasize the point that meta-RL gives rise to a separate learnt RL algorithm that implements prior-dependent bandit strategies, results also provide evidence that there is some generalization beyond the exact training distribution encountered (Figure 2f). For example, agents trained on the distributions \mathcal{D}_e and \mathcal{D}_m perform well when tested over a much wider structured distribution (i.e. \mathcal{D}_u). Further, our evidence suggests that there is generalization from training on the easier tasks ($\mathcal{D}_e, \mathcal{D}_m$) to testing on the hardest task (\mathcal{D}_h ; Figure 2e), with similar or even marginally superior performance as compared to training on the hard distribution \mathcal{D}_h itself (Figure 2f). In contrast, training on the hard distribution \mathcal{D}_h results in relatively poor generalization to other structured distributions ($\mathcal{D}_u, \mathcal{D}_e, \mathcal{D}_m$), suggesting that training purely on hard instances may result in a learned RL algorithm that is more constrained by prior knowledge, perhaps due to the difficulty of solving the original problem.

3.1.3 BANDITS WITH DEPENDENT ARMS (II)

In the previous experiment, the agent could outperform standard bandit algorithms by making use of learned dependencies between arms. However, it could do this while always choosing what it believes to be the highest-paying arm. We next examine a problem where information can be gained by paying a short-term reward cost. Similar problems have been examined before as providing a challenge to standard bandit algorithms (see e.g. Russo and Van Roy, 2014). In contrast, humans and animals make decisions that sacrifice immediate reward for information gain (e.g. Bromberg-Martin and Hikosaka, 2009).

In this experiment, the agent was trained on 11-armed bandits with strong dependencies between arms. All arms had deterministic payouts. Nine “non-target” arms had reward = 1, and one “target” arm had reward = 5. Meanwhile, arm a_{11} was always “informative”, in that the target arm was indexed by 10 times a_{11} ’s reward (e.g. a reward of 0.2 on a_{11} indicated that a_2 was the target arm). Thus, a_{11} ’s payouts ranged from 0.1 to 1. In each episode, the index of the target arm was randomly assigned. On the first trial of each episode, the agent could not know which arm was the target, so the informative arm returned expected reward 0.55 and every target arm returned expected reward 1.4. Choosing the informative arm thus meant foregoing immediate reward, but with the compensation of valuable information. Episodes were five steps long. Again, the reward on the previous trial was provided as an additional observation to the agent. To facilitate learning, this was encoded in 1-hot format.

Results are shown in Figure 3. The agent learned the optimal long-run strategy of sampling the informative arm once, despite the short-term cost, and then using the resulting information to exploit the high-value target arm. Thompson sampling, if parameterized with the true prior, searched potential target arms and exploited the target if found. UCB performed worse because it sampled every arm once even if the target arm was found early.

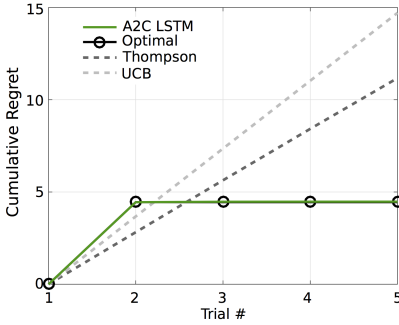

Figure 3: Learned RL procedure pays immediate cost to gain information to improve long-run returns. In this task, one arm is lower-paying but provides perfect information about which of the other ten arms is highest-paying. The remaining nine arms are intermediate in reward. The index of the informative arm is fixed between episodes, but the index of the highest-paying arm is randomized between episodes. On the first trial, the trained agent samples the informative arm. On subsequent trials, the agent uses the information it gained to deterministically exploit the highest-paying arm. Thompson sampling and UCB are not able to take advantage of the dependencies between arms. (Note: Suboptimal Arm means one that is not the highest paying, but Optimal refers to the long-run optimal strategy.)

3.1.4 RESTLESS BANDITS

In previous experiments we considered stationary problems where the agent’s actions yielded information about task parameters that remained fixed throughout each episode. Next, we consider a bandit problem in which reward probabilities drift over the course of an episode. To perform well, the agent must not only track the best arm, but also infer the drift rate or volatility of the episode and adjust its own learning rate accordingly. In such an environment, learning rates should be higher when the environment is changing rapidly, because past information becomes irrelevant more quickly (see Behrens et al., 2007; Sutton and Barto, 1998).

We tested whether meta-RL would learn such a flexible RL policy by introducing a drifting reward probability p_1 to a one-armed Bernoulli bandit task. The value of p_1 followed a reflecting Gaussian random walk, with variance ν fixed within each 150-step episode, but varying between episodes. In each training episode, the value was drawn from a uniform distribution over $[0, \frac{2}{30}] \cup [\frac{4}{30}, \frac{6}{30}]$. Figure 4a shows a sample time-series for p_1 , concatenating several episodes. The reward probabilities of the two possible actions a_1 and a_2 were $[p_1, 1 - p_1]$. Reward magnitude was fixed at 1. Episodes were 150 steps long. UCB and Thompson sampling were again implemented for comparison. The confidence bound term $\sqrt{\frac{\chi \log n}{n_i}}$ in UCB had parameter χ which we set to 1. Empirically, this was near the highest performing value on our data set. Thompson sampling’s posterior update included knowledge of the Gaussian random walk, but with a fixed volatility for all episodes.

As shown in Figure 4, meta-RL learned to dynamically track which action was more likely to yield reward. The actions selected by the agent in test are shown in Figure 4a, and closely shadow the (hidden) generative probability. The agent experienced lower regret on average in test than Thompson sampling, UCB, or the Rescorla-Wagner (R-W) learning rule (Figure 4b; Rescorla et al., 1972). To test whether the agent used different effective learning rates in episodes with different volatilities, we fit a R-W model to the agent’s behavior independently in each episode. We estimated the learning rate and inverse softmax temperature by maximum likelihood. The estimated learning rate was strongly correlated with the true volatility ν of the episode ($R^2 = 0.24$, $p = 10^{-61}$ by linear regression), demonstrating that the agent could adapt its learning rate appropriately (Figure 4c). In testing, ν was drawn from a uniform distribution over $[0, \frac{6}{30}]$. This allowed us to ask whether the agent could generalize to a range of volatilities it had not encountered during training. We observed that the agent did in fact generalize sensibly. The mean learning rate in test episodes with $\nu \in [\frac{2}{30}, \frac{4}{30}]$ was greater than in episodes with $\nu \in [\frac{0}{30}, \frac{2}{30}]$ ($p = 10^{-24}$ by t-test) and less than in episodes with $\nu \in [\frac{4}{30}, \frac{6}{30}]$ ($p = 10^{-12}$ by t-test). Also, the learning rate in out-of-sample test episodes was correlated with the true volatility in these episodes ($R^2 = 0.05$, $p = 10^{-4}$ by linear regression).

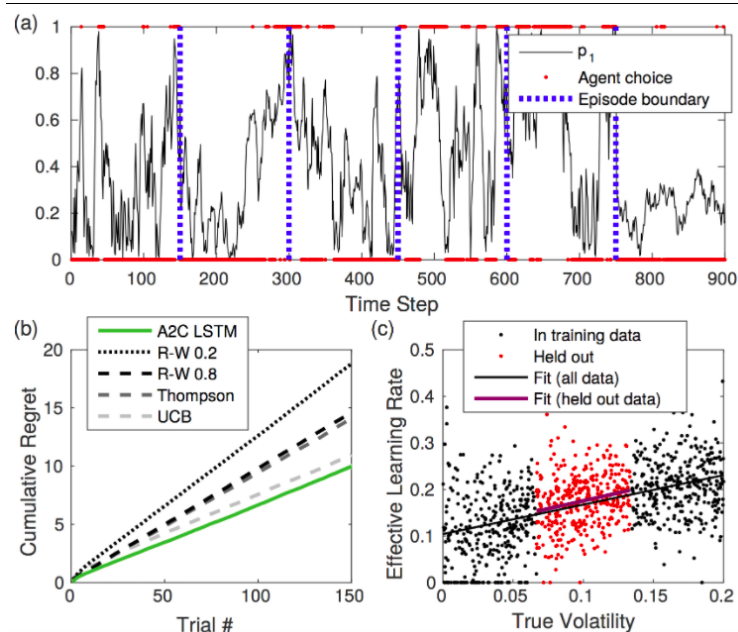

Figure 4: Learned RL procedure adapts its own learning rate to the statistics of the environment. (a) Agents were trained on one-armed bandit problems. Actions a_1 and a_2 were rewarded with probabilities p_1 and $1-p_1$. p_1 drifted within an episode. The drift rate (or volatility) was fixed within an episode but drawn *iid* for each episode. The drifting values of p_1 are shown concatenated for six episodes, as a black line. The agent’s actions in these example episodes are shown as red dots. (b) The trained LSTM agent outperformed UCB, Thompson sampling, and a Rescorla-Wagner (R-W) learner with fixed learning rate $\alpha=0.2$ or $\alpha=0.8$. The y-axis shows cumulative regret: the expected reward of the best action minus the actual reward obtained. Standard error of the mean is not clearly visible because it is approximately the line thickness. (c) We estimated the learning rate used by the trained agent independently within each episode by maximum likelihood fitting of a R-W model to the agent’s choices. The agent’s estimated learning rate was higher in more volatile episodes, and this relationship also held for episodes with volatilities that had not been experienced during training (red dots).

3.2 MARKOV DECISION PROBLEMS

The foregoing experiments focused on bandit tasks in which actions do not affect the task’s underlying state. We turn now to MDPs where actions do influence state. We begin with a task derived from the neuroscience literature and then turn to a task, originally studied in the context of animal learning, which requires learning of abstract task structure. As in the previous experiments, our focus is on examining how meta-RL adapts to invariances in task structure. We wrap up by reviewing an experiment recently reported in a related paper (Mirowski et al., 2017), which demonstrates how meta-RL can scale to large-scale navigation tasks with rich visual inputs.

3.2.1 THE ‘TWO-STEP TASK’

Here we examine meta-RL in a setting that has been widely used in the neuroscience literature to distinguish the contribution of different systems viewed to support decision making (Daw et al., 2005). Specifically, this paradigm – known as the “two-step task” (Daw et al., 2011) – was developed to dissociate a model-free system that caches values of actions in states (e.g. TD(1) Q-learning; see Sutton and Barto, 1998), from a model-based system which learns an internal model of the environment and evaluates the value of actions at the time of decision-making through look-ahead planning (Daw et al., 2005). Our interest was in whether meta-RL would give rise to behavior emulating a model-based strategy, despite the use of a model-free algorithm (in this case A2C) to train the system weights.

We used a modified version of the two-step task, designed to bolster the utility of model-based over model-free control (see Kool et al., 2016). The task’s structure is diagrammed in Figure 5a. From the first-stage state S_1 , action a_1 leads to second-stage states S_2 and S_3 with probability 0.75 and 0.25,

respectively, while action a_2 leads to S_2 and S_3 with probabilities 0.25 and 0.75. One second-stage state yielded a reward of 1.0 with probability 0.9 (and otherwise zero); the other yielded the same reward with probability 0.1. The identity of the higher-valued state was assigned randomly for each episode. Thus, the expected values for the two first-stage actions were either $r_a = 0.9$ and $r_b = 0.1$, or $r_a = 0.1$ and $r_b = 0.9$. All three states were represented by one-hot vectors, with the transition model held constant across episodes: i.e. only the expected value of the second stage states changed from episode to episode.

We applied the conventional analysis used in the neuroscience literature to dissociate model-free from model-based control (Daw et al., 2011). This focuses on the ‘stay probability,’ that is, the probability with which a first-stage action is selected at trial $t + 1$ following a second-stage reward at trial t , as a function of whether trial t involved a common transition (e.g. action a_1 at state S_1 led to S_2) or rare transition (action a_2 at state S_1 led to S_3). Under the standard interpretation (see Daw et al., 2011), model-free control – ala TD(1) – predicts that there should be a main effect of reward: First-stage actions will tend to be repeated if followed by reward, regardless of transition type, and such actions will tend not to be repeated (choice switch) if followed by non-reward (Figure 5b). In contrast, model-based control predicts an interaction between the reward and transition type, reflecting a more goal-directed strategy, which takes the transition structure into account. Intuitively, if you receive a second-stage reward (e.g. at S_2) following a rare transition (i.e. having taken action a_2 at state S_1), to maximize your chances of getting to this reward on the next trial based on your knowledge of the transition structure, the optimal first stage action is a_1 (i.e. switch).

The results of the stay-probability analysis performed on the agent’s choices show a pattern conventionally interpreted as implying the operation of model-based control (Figure 5c). As in previous experiments, when reward information was withheld at the level of network input, performance was at chance levels.

If interpreted following standard practice in neuroscience, the behavior of the model in this experiment reflects a surprising effect: training with model-free RL gives rise to behavior reflecting model-based control. We hasten to note that different interpretations of the observed pattern of behavior are available (Akam et al., 2015), a point to which we will return below. However, notwithstanding this caveat, the results of the present experiment provide a further illustration of the point that the learning procedure that emerges from meta-RL can differ starkly from the original RL algorithm used to train the network weights, and takes a form that exploits consistent task structure.

3.2.2 LEARNING ABSTRACT TASK STRUCTURE

In the final experiment we conducted, we took a step towards examining the scalability of meta-RL, by studying a task that involves rich visual inputs, longer time horizons and sparse rewards. Additionally, in this experiment we studied a meta-learning task that requires the system to tune into an abstract task structure, in which a series of objects play defined roles which the system must infer.

The task was adapted from a classic study of animal behavior, conducted by Harlow (1949). On each trial in the original task, Harlow presented a monkey with two visually contrasting objects. One of these covered a small well containing a morsel of food; the other covered an empty well. The animal chose freely between the two objects and could retrieve the food reward if present. The stage was then hidden and the left-right positions of the objects were randomly reset. A new trial then began, with the animal again choosing freely. This process continued for a set number of trials using the same two objects. At completion of this set of trials, two entirely new and unfamiliar objects were substituted for the original two, and the process began again. Importantly, within each block of trials, one object was chosen to be consistently rewarded (regardless of its left-right position), with the other being consistently unrewarded. What Harlow (Harlow, 1949) observed was that, after substantial practice, monkeys displayed behavior that reflected an understanding of the task’s rules. When two new objects were presented, the monkey’s first choice between them was necessarily arbitrary. But after observing the outcome of this first choice, the monkey was at ceiling thereafter, always choosing the rewarded object.

We anticipated that meta-RL should give rise to the same pattern of abstract one-shot learning. In order to test this, we adapted Harlow’s paradigm into a visual fixation task, as follows. A 84x84 pixel input represented a simulated computer screen (see Figure 6a-c). At the beginning of each trial, this display was blank except for a small central fixation cross (red crosshairs). The agent selected discrete

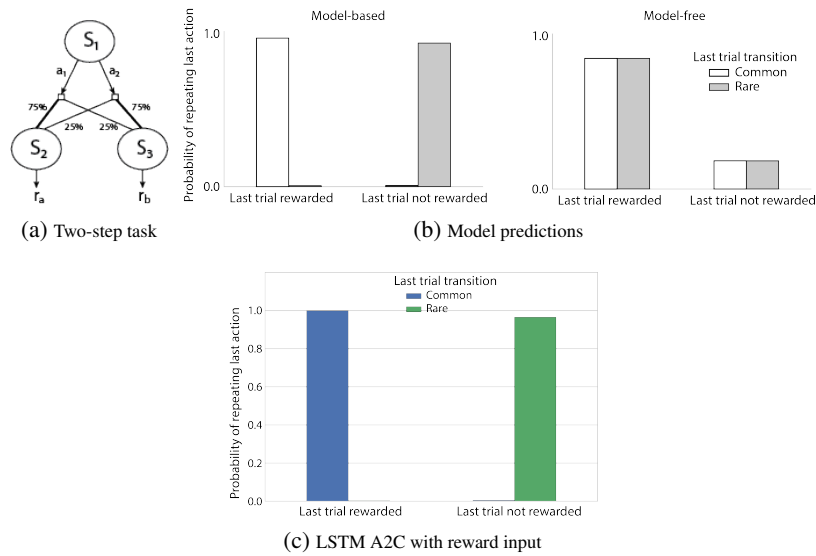

Figure 5: Three-state MDP modeled after the "two-step task" from Daw et al. (2011). (a) MDP with 3 states and 2 actions. All trials start in state S_1 , with transition probabilities after taking actions a_1 or a_2 depicted in the graph. S_2 and S_3 result in expected rewards r_a and r_b (see text). (b) Predictions of choice probabilities given either a model-based strategy or a model-free strategy (Daw et al., 2011). Specifically, model-based strategies take into account transition probabilities and would predict an interaction between the amount of reward received on the last trial and the transition (common or uncommon) observed. (c) Agent displays a perfectly model-based profile when given the reward as input.

left-right actions which shifted its view approximately 4.4 degrees in the corresponding direction, with a small momentum effect (alternatively a no-op action could be selected). The completion of a trial required performing two tasks: saccading to the central fixation cross followed by saccading to the correct image. If the agent held the fixation cross in the center of the field of view (within a tolerance of 3.5 degrees visual angle) for a minimum of four time steps, it received a reward of 0.2. The fixation cross then disappeared and two images – drawn randomly from the ImageNet dataset (Deng et al., 2009) and resized to 34x34 – appeared on the left and right side of the display (Figure 6b). The agent’s task was then to ‘select’ one of the images by rotating until the center of the image aligned with the center of the visual field of view (within a tolerance of 7 degrees visual angle). Once one of the images was selected, both images disappeared and, after an intertrial interval of 10 time-steps, the fixation cross reappeared, initiating the next trial. Each episode contained a maximum of 10 trials or 3600 steps. Following Mirowski et al. (2017), we implemented an action repeat of 4, meaning that selecting an image took a minimum of three independent decisions (twelve primitive actions) after having completed the fixation. It should be noted, however, that the rotational position of the agent was not limited; that is, 360 degree rotations could occur, while the simulated computer screen only subtended 65 degrees.

Although new ImageNet images were chosen at the beginning of each episode (sampled with replacement from a set of 1000 images), the same images were re-used across all trials within a block, though in randomly varying left-right order, like the objects in Harlow’s experiment. And as in that experiment, one image was arbitrarily chosen to be the ‘rewarded’ image throughout the episode. Selection of this image yielded a reward of 1.0, while the other image yielded a reward of -1.0. During test, the A3C learning rate was set to zero and ImageNet images were drawn from a separate held-out set of 1000, never presented during training.

A grid search was conducted for optimal hyperparameters. At perfect performance, agents can complete one trial per 20-30 steps and achieve a maximum expected reward of 9 per 10 trials. Given the nature of the task – which requires one-shot image-reward memory together with maintenance of this information over a relatively long timescale (i.e. over fixation-cross selections and across trials) – we assessed the performance of not only a convolutional-LSTM architecture which receives reward

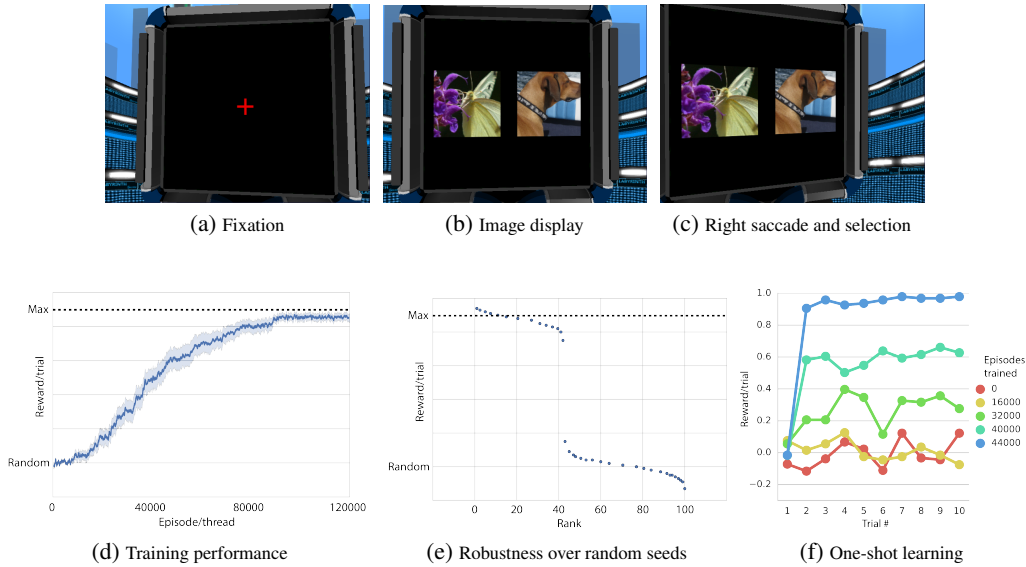

Figure 6: Learning abstract task structure in visually rich 3D environment. a-c) Example of a single trial, beginning with a central fixation, followed by two images with random left-right placement. d) Average performance (measured in average reward per trial) of top 40 out of 100 seeds during training. Maximum expected performance is indicated with black dashed line. e) Performance at episode 100,000 for 100 random seeds, in decreasing order of performance. f) Probability of selecting the rewarded image, as a function of trial number for a single A3C stacked LSTM agent for a range of training durations (episodes per thread, 32 threads).

and action as additional input (see Figure 1b and Table 1), but also a convolutional-stacked LSTM architecture used in a navigation task discussed below (see Figure 1c).

Agent performance is illustrated in Figure 6d-f. Whilst the single LSTM agent was relatively successful at solving the task, the stacked-LSTM variant exhibited much better robustness (i.e. 43% of random seeds of the best hyperparameter set performed at ceiling, compared to 26% of the single LSTM; Figure 6e)).

Like the monkeys in Harlow’s experiment (Harlow, 1949), the networks converge on an optimal policy: Not only does the agent successfully fixate to begin each trial, but starting on the second trial of each episode it invariably selects the rewarded image, regardless of which image it selected on the first trial (Figure 6f). This reflects an impressive form of one-shot learning, which reflects an implicit understanding of the task structure: After observing one trial outcome, the agent binds a complex, unfamiliar image to a specific task role.

Further experiments, reported elsewhere (Wang et al., Submitted), confirmed that the same recurrent A3C system is also able to solve a substantially more difficult version of the task. In this task, only one image – which was randomly designated to be either the rewarding item to be selected, or the unrewarding item to be avoided – was presented on every trial during an episode, with the other image presented being novel on every trial.

3.2.3 ONE-SHOT NAVIGATION

The experiments using the Harlow task demonstrate the capacity of meta-RL to operate effectively within a visually rich environment, with relatively long time horizons. Here we consider related experiments recently reported within the navigation domain (Mirowski et al., 2017) (see also Jaderberg et al., 2017), and discuss how these can be recast as examples of meta-RL – attesting to the scalability of this principle to more typical MDP settings that pose challenging RL problems due to dynamically changing sparse rewards.

Specifically, we consider a setting where the environment layout is fixed but the goal changes location randomly each episode (Figure 7; Mirowski et al., 2017). Although the layout is relatively simple,

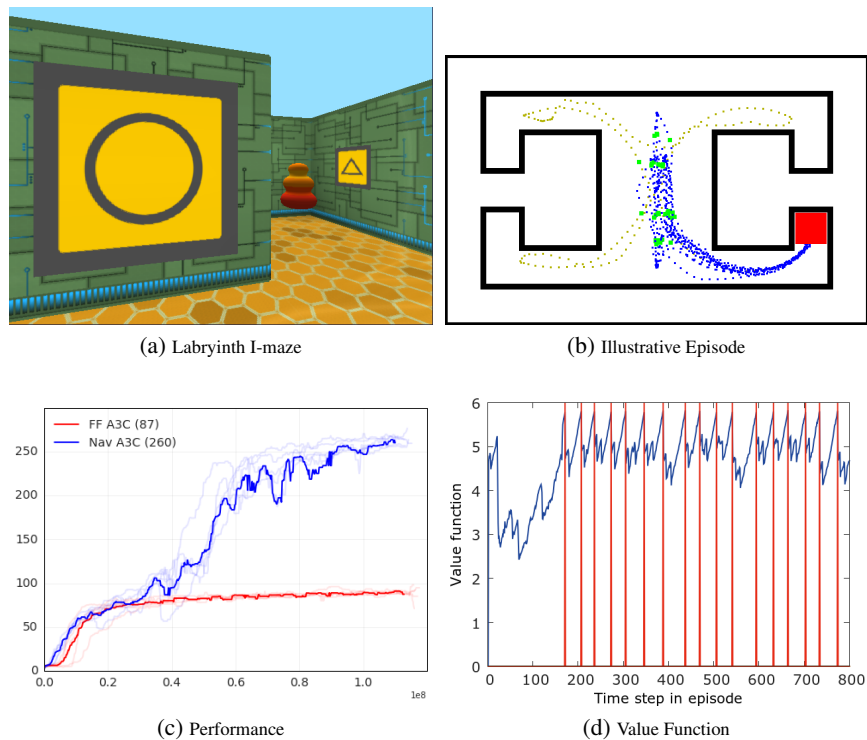

Figure 7: a) view of I-maze showing goal object in one of the 4 alcoves b) following initial exploration (light trajectories), agent repeatedly goes to goal (blue trajectories) c) Performance of stacked LSTM (termed "Nav A3C") and feedforward ("FF A3C") architectures, per episode (goal = 10 points) averaged across top 5 hyperparameters. e) following initial goal discovery (goal hits marked in red), value function occurs well in advance of the agent seeing the goal which is hidden in an alcove. Figure used with permission from Mirowski et al.

the Labryinth environment (see for details Mirowski et al., 2017) is richer and more finely discretized (cf VizDoom), resulting in long time horizons; a trained agent takes approximately 100 steps (10 seconds) to reach the goal for the first time in a given episode. Results show that a stacked LSTM architecture (Figure 1c), that receives reward and action as additional inputs equivalent to that used in our Harlow experiment achieves near-optimal behavior – showing one-shot memory for the goal location after an initial exploratory period, followed by repeated exploitation (see Figure 7c). This is evidenced by a substantial decrease in latency to reach the goal for the first time (~ 100 timesteps) compared to subsequent visits (~ 30 timesteps). Notably, a feedforward network (see Figure 7c), that receives only a single image as observation, is unable to solve the task (i.e. no decrease in latency between successive goal rewards). Whilst not interpreted as such in Mirowski et al. (2017), this provides a clear demonstration of the effectiveness of meta-RL: a separate RL algorithm with the capability of one-shot learning emerges through training with a fixed and more incremental RL algorithm (i.e. policy gradient). Meta-RL can be viewed as allowing the agent to infer the optimal value function following initial exploration (see Figure 7d) – with the additional LSTM providing information about the currently relevant goal location to the LSTM that outputs the policy over the extended timeframe of the episode. Taken together, meta-RL allows a base model-free RL algorithm to solve a challenging RL problem that might otherwise require fundamentally different approaches (e.g. based on successor representations or fully model-based RL).

4 RELATED WORK

We have already touched on the relationship between deep meta-RL and pioneering work by Hochreiter et al. (2001) using recurrent networks to perform meta-learning in the setting of full supervision (see also Cotter and Conwell, 1990; Prokhorov et al., 2002; Younger et al., 1999). That approach was recently extended in Santoro et al. (2016), which demonstrated the utility of leveraging an external

memory structure. The idea of crossing meta-learning with reinforcement learning has been previously discussed by Schmidhuber et al. (1996). That work, which appears to have introduced the term “meta-RL,” differs from ours in that it did not involve a neural network implementation. More recently, however, there has been a surge of interest in using neural networks to learn optimization procedures, using a range of innovative meta-learning techniques (Andrychowicz et al., 2016; Chen et al., 2016; Li and Malik, 2016; Zoph and Le, 2016). Recent work by Chen et al. (2016) is particularly close in spirit to the work we have presented here, and can be viewed as treating the case of ‘infinite bandits’ using a meta-learning strategy broadly analogous to the one we have pursued.

The present research also bears a close relationship with a different body of recent work that has not been framed in terms of meta-learning. A number of studies have used deep RL to train recurrent neural networks on navigation tasks, where the structure of the task (e.g., goal location or maze configuration) varies across episodes (Jaderberg et al., 2017; Mirowski et al., 2017). The final experiment that we presented above, drawn from (Mirowski et al., 2017), is one example. To the extent that such experiments involve the key ingredients of deep meta-RL – a neural network with memory, trained through RL on a series of interrelated tasks – they are almost certain to involve the kind of meta-learning we have described in the present work. This related work provides an indication that meta-RL can be fruitfully applied to larger scale problems than the ones we have studied in our own experiments. Importantly, it indicates that a key ingredient in scaling the approach may be to incorporate memory mechanisms beyond those inherent in unstructured recurrent neural networks (see Graves et al., 2016; Mirowski et al., 2017; Santoro et al., 2016; Weston et al., 2014). Our work, for its part, suggests that there is untapped potential in deep recurrent RL agents to meta-learn quite abstract aspects of task structure, and to discover strategies that exploit such structure toward rapid, flexible adaptation.

During completion of the present research, closely related work was reported by Duan et al. (2017). Like us, Duan and colleagues use deep RL to train a recurrent network on a series of interrelated tasks, with the result that the network dynamics learn a second RL procedure which operates on a faster time-scale than the original algorithm. Duan and colleagues compare the performance of these learned procedures against conventional RL algorithms in a number of domains, including bandits and navigation. An important difference between this parallel work and our own is the former’s primary focus on relatively unstructured task distributions (e.g., uniformly distributed bandit problems and random MDPs); our main interest, in contrast, has been in structured task distributions (e.g., dependent bandits and the task introduced by Harlow, 1949), because it is in this setting where the system can learn a biased – and therefore efficient – RL procedure that exploits regular task structure. The two perspectives are, in this regard, nicely complementary.

5 CONCLUSION

A current challenge in artificial intelligence is to design agents that can adapt rapidly to new tasks by leveraging knowledge acquired through previous experience with related activities. In the present work we have reported initial explorations of what we believe is one promising avenue toward this goal. Deep meta-RL involves a combination of three ingredients: (1) Use of a deep RL algorithm to train a recurrent neural network, (2) a training set that includes a series of interrelated tasks, (3) network input that includes the action selected and reward received in the previous time interval. The key result, which emerges naturally from the setup rather than being specially engineered, is that the recurrent network dynamics learn to implement a second RL procedure, independent from and potentially very different from the algorithm used to train the network weights. Critically, this learned RL algorithm is tuned to the shared structure of the training tasks. In this sense, the learned algorithm builds in domain-appropriate biases, which can allow it to operate with greater efficiency than a general-purpose algorithm. This bias effect was particularly evident in the results of our experiments involving dependent bandits (sections 3.1.2 and 3.1.3), where the system learned to take advantage of the task’s covariance structure; and in our study of Harlow’s animal learning task (section 3.2.2), where the recurrent network learned to exploit the task’s structure in order to display one-shot learning with complex novel stimuli.

One of our experiments (section 3.2.1) illustrated the point that a system trained using a model-free RL algorithm can develop behavior that emulates model-based control. A few further comments on this result are warranted. As noted in our presentation of the simulation results, the pattern of choice

behavior displayed by the network has been considered in the cognitive and neuroscience literatures as reflecting model-based control or tree search. However, as has been remarked in very recent work, the same pattern can arise from a model-free system with an appropriate state representation (Akam et al., 2015). Indeed, we suspect this may be how our network in fact operates. However, other findings suggest that a more explicitly model-based control mechanism can emerge when a similar system is trained on a more diverse set of tasks. In particular, Ilin et al. (2007) showed that recurrent networks trained on random mazes can approximate dynamic programming procedures (see also Silver et al., 2017; Tamar et al., 2016). At the same time, as we have stressed, we consider it an important aspect of deep meta-RL that it yields a learned RL algorithm that capitalizes on invariances in task structure. As a result, when faced with widely varying but still structured environments, deep meta-RL seems likely to generate RL procedures that occupy a grey area between model-free and model-based RL.

The two-step decision problem studied in Section 3.2.1 was derived from neuroscience, and we believe deep meta-RL may have important implications in that arena (Wang et al., Submitted). The notion of meta-RL has been discussed previously in neuroscience but only in a narrow sense, according to which meta-learning adjusts scalar hyperparameters such as the learning rate or softmax inverse temperature (Khamassi et al., 2011; 2013; Kobayashi et al., 2009; Lee and Wang, 2009; Schweighofer and Doya, 2003; Soltani et al., 2006). In recent work (Wang et al., Submitted) we have shown that deep meta-RL can account for a wider range of experimental observations, providing an integrative framework for understanding the respective roles of dopamine and the prefrontal cortex in biological reinforcement learning.

ACKNOWLEDGEMENTS

We would like to thank the following colleagues for useful discussion and feedback: Nando de Freitas, David Silver, Koray Kavukcuoglu, Daan Wierstra, Demis Hassabis, Matt Hoffman, Andrea Banino, Sam Ritter, Neil Rabinowitz, Peter Dayan, Peter Battaglia, Alex Lerchner, Tim Lillicrap and Greg Wayne.

REFERENCES

- Thomas Akam, Rui Costa, and Peter Dayan. Simple plans or sophisticated habits? state, transition and learning interactions in the two-step task. *PLoS Comput Biol.* 11(12):e1004648, 2015.
- Marcin Andrychowicz, Misha Denil, Sergio Gomez, Matthew W Hoffman, David Pfau, Tom Schaul, and Nando de Freitas. Learning to learn by gradient descent by gradient descent. *arXiv preprint arXiv:1606.04474*, 2016.
- Peter Auer, Nicolo Cesa-Bianchi, and Paul Fischer. Finite-time analysis of the multiarmed bandit problem. *Machine learning*, 47(2-3):235–256, 2002.
- Timothy EJ Behrens, Mark W Woolrich, Mark E Walton, and Matthew FS Rushworth. Learning the value of information in an uncertain world. *Nature neuroscience*, 10(9):1214–1221, 2007.
- Ethan S Bromberg-Martin and Okihide Hikosaka. Midbrain dopamine neurons signal preference for advance information about upcoming rewards. *Neuron*, 63(1):119–126, 2009.
- Yutian Chen, Matthew W Hoffman, Sergio Gomez, Misha Denil, Timothy P Lillicrap, and Nando de Freitas. Learning to learn for global optimization of black box functions. *arXiv preprint arXiv:1611.03824*, 2016.
- NE Cotter and PR Conwell. Fixed-weight networks can learn. In *1990 IJCNN International Joint Conference on Neural Networks*, pages 553–559, 1990.
- Nathaniel D Daw, Yael Niv, and Peter Dayan. Uncertainty-based competition between prefrontal and dorsolateral striatal systems for behavioral control. *Nature neuroscience*, 8(12):1704–1711, 2005.
- Nathaniel D Daw, Samuel J Gershman, Ben Seymour, Peter Dayan, and Raymond J Dolan. Model-based influences on humans’ choices and striatal prediction errors. *Neuron*, 69(6):1204–1215, 2011.
- Jia Deng, Wei Dong, Richard Socher, Li-Jia Li, Kai Li, and Li Fei-Fei. Imagenet: A large-scale hierarchical image database. In *Computer Vision and Pattern Recognition, 2009. CVPR 2009. IEEE Conference on*, pages 248–255. IEEE, 2009.
- Yan Duan, John Schulman, Xi Chen, Peter L. Bartlett, Ilya Sutskever, and Pieter Abbeel. RL2: Fast reinforcement learning via slow reinforcement learning. *Submitted to Int’l Conference on Learning Representations, ICLR*, 2017.

-
- John C Gittins. Bandit processes and dynamic allocation indices. *Journal of the Royal Statistical Society. Series B (Methodological)*, pages 148–177, 1979.
- Alex Graves, Greg Wayne, Malcolm Reynolds, Tim Harley, Ivo Danihelka, Agnieszka Grabska-Barwińska, Sergio Gómez Colmenarejo, Edward Grefenstette, Tiago Ramalho, John Agapiou, et al. Hybrid computing using a neural network with dynamic external memory. *Nature*, 2016.
- Harry F Harlow. The formation of learning sets. *Psychological review*, 56(1):51, 1949.
- Sepp Hochreiter and Jürgen Schmidhuber. Long short-term memory. *Neural computation*, 9(8):1735–1780, 1997.
- Sepp Hochreiter, A Steven Younger, and Peter R Conwell. Learning to learn using gradient descent. In *International Conference on Artificial Neural Networks*, pages 87–94. Springer, 2001.
- Roman Ilin, Robert Kozma, and Paul J Werbos. Efficient learning in cellular simultaneous recurrent neural networks-the case of maze navigation problem. In *2007 IEEE International Symposium on Approximate Dynamic Programming and Reinforcement Learning*, pages 324–329. IEEE, 2007.
- Max Jaderberg, Volodymyr Mnih, Wojciech Czarnecki, Tom Schaul, Joel Z. Leibo, David Silver, and Koray Kavukcuoglu. Reinforcement learning with unsupervised auxiliary tasks. *Submitted to Int’l Conference on Learning Representations, ICLR*, 2017.
- Emilie Kaufmann, Olivier Cappé, and Aurélien Garivier. On bayesian upper confidence bounds for bandit problems. In *Proc. of Int’l Conf. on Artificial Intelligence and Statistics, AISTATS*, 2012a.
- Emilie Kaufmann, Nathaniel Korda, and Rémi Munos. Thompson sampling: An asymptotically optimal finite-time analysis. In *Algorithmic Learning Theory - 23rd International Conference*, pages 199–213, 2012b.
- Mehdi Khamassi, Stéphane Lallée, Pierre Enel, Emmanuel Procyk, and Peter F Dominey. Robot cognitive control with a neurophysiologically inspired reinforcement learning model. *Frontiers in neurorobotics*, 5:1, 2011.
- Mehdi Khamassi, Pierre Enel, Peter Ford Dominey, and Emmanuel Procyk. Medial prefrontal cortex and the adaptive regulation of reinforcement learning parameters. *Prog Brain Res*, 202:441–464, 2013.
- Kunikazu Kobayashi, Hiroyuki Mizoue, Takashi Kuremoto, and Masanao Obayashi. A meta-learning method based on temporal difference error. In *International Conference on Neural Information Processing*, pages 530–537. Springer, 2009.
- Wouter Kool, Fiery A Cushman, and Samuel J Gershman. When does model-based control pay off? *PLoS Comput Biol*, 12(8):e1005090, 2016.
- Brenden M Lake, Tomer D Ullman, Joshua B Tenenbaum, and Samuel J Gershman. Building machines that learn and think like people. *arXiv preprint arXiv:1604.00289*, 2016.
- Tor Lattimore and Rémi Munos. Bounded regret for finite-armed structured bandits. In *Advances in Neural Information Processing Systems 27*, pages 550–558, 2014.
- Yann LeCun, Yoshua Bengio, and Geoffrey Hinton. Deep learning. *Nature*, 521(7553):436–444, 2015.
- Daeyeol Lee and Xiao-Jing Wang. Mechanisms for stochastic decision making in the primate frontal cortex: Single-neuron recording and circuit modeling. *Neuroeconomics: Decision making and the brain*, pages 481–501, 2009.
- Ke Li and Jitendra Malik. Learning to optimize. *arXiv preprint arXiv:1606.01885*, 2016.
- Piotr Mirowski, Razvan Pascanu, Fabio Viola, Hubert Soyer, Andy Ballard, Andrea Banino, Misha Denil, Ross Goroshin, Laurent Sifre, Koray Kavukcuoglu, Dharmashan Kumaran, and Raia Hadsell. Learning to navigate in complex environments. *Submitted to Int’l Conference on Learning Representations, ICLR*, 2017. URL <http://arxiv.org/abs/1611.03673>.
- Volodymyr Mnih, Koray Kavukcuoglu, David Silver, Andrei A. Rusu, Joel Veness, et al. Human-level control through deep reinforcement learning. *Nature*, 518:529–533, 2015.
- Volodymyr Mnih, Adrià Puigdomènech Badia, Mehdi Mirza, Alex Graves, Timothy P. Lillicrap, Tim Harley, David Silver, and Koray Kavukcuoglu. Asynchronous methods for deep reinforcement learning. In *Proc. of Int’l Conf. on Machine Learning, ICML*, 2016.
- Danil V Prokhorov, Lee A Feldkamp, and Ivan Yu Tyukin. Adaptive behavior with fixed weights in rnn: an overview. In *Proceedings of the IEEE International Joint Conference on Neural Networks (IJCNN)*, pages 2018–2023, 2002.
- Robert A Rescorla, Allan R Wagner, et al. A theory of pavlovian conditioning: Variations in the effectiveness of reinforcement and nonreinforcement. *Classical conditioning II: Current research and theory*, 2:64–99, 1972.

-
- Dan Russo and Benjamin Van Roy. Learning to optimize via information-directed sampling. In *Advances in Neural Information Processing Systems 27*, pages 1583–1591, 2014.
- Adam Santoro, Sergey Bartunov, Matthew Botvinick, Daan Wierstra, and Timothy Lillicrap. Meta-learning with memory-augmented neural networks. In *Proceedings of The 33rd International Conference on Machine Learning*, pages 1842–1850, 2016.
- Jurgen Schmidhuber, Jieyu Zhao, and Marco Wiering. Simple principles of metalearning. Technical report, SEE, 1996.
- Nicolas Schweighofer and Kenji Doya. Meta-learning in reinforcement learning. *Neural Networks*, 16(1):5–9, 2003.
- David Silver, Aja Huang, Chris J Maddison, Arthur Guez, Laurent Sifre, George Van Den Driessche, Julian Schrittwieser, et al. Mastering the game of go with deep neural networks and tree search. *Nature*, 529(7587): 484–489, 2016.
- David Silver, Hado van Hasselt, Matteo Hessel, Tom Schaul, Arthur Guez, Tim Harley, Gabriel Dulac-Arnold, David Reichert, Neil Rabinowitz, Andre Barreto, and Thomas Degris. The predictron: End-to-end learning and planning. *Submitted to Int'l Conference on Learning Representations, ICLR*, 2017.
- Alireza Soltani, Daeyeol Lee, and Xiao-Jing Wang. Neural mechanism for stochastic behaviour during a competitive game. *Neural Networks*, 19(8):1075–1090, 2006.
- Richard S Sutton and Andrew G Barto. *Reinforcement learning: An introduction*, volume 1. MIT press Cambridge, 1998.
- Aviv Tamar, Yi Wu, Garrett Thomas, Sergey Levine, and Pieter Abbeel. Value iteration networks. *arXiv preprint arXiv:1602.02867v2*, 2016.
- William R Thompson. On the likelihood that one unknown probability exceeds another in view of the evidence of two samples. *Biometrika*, 25:285–294, 1933.
- Sebastian Thrun and Lorien Pratt. Learning to learn: Introduction and overview. In *Learning to learn*, pages 3–17. Springer, 1998.
- Jane X Wang, Zeb Kurth-Nelson, Dhharshan Kumaran, and Matthew Botvinick. Meta-reinforcement learning: a bridge between prefrontal and dopaminergic function. *Submitted*.
- Jason Weston, Sumit Chopra, and Antoine Bordes. Memory networks. *arXiv preprint arXiv:1410.3916*, 2014.
- A Steven Younger, Peter R Conwell, and Neil E Cotter. Fixed-weight on-line learning. *IEEE Transactions on Neural Networks*, 10(2):272–283, 1999.
- Barret Zoph and Quoc V Le. Neural architecture search with reinforcement learning. *arXiv preprint arXiv:1611.01578*, 2016.