

MINOR COMPLEXITIES OF FINITE OPERATIONS

SLAVCHO SHTRAKOV

ABSTRACT. In this paper we present a new class of complexity measures, induced by a new data structure for representing k -valued functions (operations), called minor decision diagram. The results are presented in terms of Multi-Valued Logic circuits (MVL-circuits), ordered decision diagrams, formulas and minor decomposition trees. When assigning values to some variables in a function f the resulting function is a subfunction of f , and when identifying some variables the resulting function is a minor of f . A set M of essential variables in f is separable if there is a subfunction of f , whose set of essential variables is M . The essential arity gap $gap(f)$ of the function f is the minimum number of essential variables in f which become fictive when identifying distinct essential variables in f . We prove that, if a function f has non-trivial arity gap ($gap(f) \geq 2$), then all sets of essential variables in f are separable. We define equivalence relations which classify the functions of k -valued logic into classes with the same minor complexities. These relations induce transformation groups which are compared with the subgroups of the restricted affine group (RAG) and the groups determined by the equivalence relations with respect to the subfunctions, implementations and separable sets in functions. These methods provide a detailed classification of n -ary k -valued functions for small values of n and k .

1. INTRODUCTION

The complexity of finite operations is still one of the fundamental tasks in the theory of computation and besides classical methods like substitution or degree arguments a bunch of combinatorial, and algebraic techniques have been introduced to tackle this extremely difficult problem.

A *logic gate* is a physical device that realizes a Boolean function. A *logic circuit* is a directed acyclic graph in which all vertices except input vertices carry the labels of gates. When realizing functions are taken from the k -valued logic the circuit is called the (k, n) -circuit or *Multi-Valued Logic circuit (MVL-circuit)*.

To move from logical circuits to MVL-circuits, researchers attempt to adapt CMOS (complementary metal oxide semiconductor), I²L (integrated injection logic) and ECL (emitter-coupled logic) technologies to implement the many-valued and fuzzy logics gates. The MVL-circuits offer more potential opportunities for the improvement of present VLSI circuit designs. For instance, MVL-circuits are well-applied in memory technology as flash memory, dynamic RAM, and in algebraic circuits [8].

Computational complexity is examined in concrete and abstract terms. The concrete analysis is based on models that capture the exchange of space for time. It is also performed via the knowledge about circuit complexity of functions. The

2010 *Mathematics Subject Classification.* Primary: 94C10; Secondary: 06E30, 68Q25, 68Q15.
Key words and phrases. identification minor, minor decision diagram, minor complexity.

abstract analysis is done via complexity classes, the classification of data structures, functions etc. by the time and/or space they need.

There are two key methods for reduction (computing) of the finite functions which are realized by assigning constants or variables to their inputs. Then the resulting objects are: subfunctions or minors, respectively. These reductions are also naturally suited to complexity measures, which illustrate "difficulty" of computing as the number of subfunctions, implementations, and minors of the functions.

Another topic in Complexity Theory is to classify finite functions by their complexity such that the functions are grouped into equivalence classes with same evaluations of the corresponding complexities. Each equivalence relation in the algebra P_k^n of k -valued functions determines a transformation group whose orbits are the equivalence classes. Using the lattice of Restricted Affine Groups (RAG) in [15] we have obtained upper bounds of different combinatorial parameters of several natural equivalences in P_k^n for small values of k and n . In the present paper we follow this line to study assigning (not necessarily unique) variable names to some of the input variables in a function f . This method of computing consists of equalizing the values of several inputs of f .

Section 2 introduces the basic definitions and notation of separable sets, subfunctions, minors, arity gap, etc. An important result, namely if a function has non-trivial arity gap then all its sets of essential variables are separable, complements this section. Section 3 examines the minor decomposition trees (MDTs), minor decision diagrams (MDDs), and minor complexities of discrete functions. Equivalence relations and transformation groups concerning the number of minors in functions is the topic of Section 4. Classification of Boolean (switching) functions of a "small" number of their essential variables is presented in Section 5. The Appendix examines an algorithm for counting the minor complexities of functions and provides a full classification of all ternary Boolean functions by these complexities.

2. SUBFUNCTIONS AND MINORS OF FUNCTIONS

A *discrete function* f is defined as a mapping: $f : A \rightarrow B$ where the domain $A = \times_{i=1}^n A_i$ and the range B are non-empty finite or countable sets. Let $X = \{x_1, x_2, \dots\}$ be a countable set of variables and let $X_n = \{x_1, x_2, \dots, x_n\}$ denote the set of the first n variables in X . Let k be a natural number with $k \geq 2$. Let Z_k denote the set $Z_k = \{0, 1, \dots, k-1\}$. The operations addition " \oplus " and product " \cdot " modulo k constitute Z_k as a ring. An n -ary k -valued function (operation) on Z_k is a mapping $f : Z_k^n \rightarrow Z_k$ for some natural number n , called the *arity* of f . P_k^n denotes the set of all n -ary k -valued functions and $P_k = \bigcup_{n=1}^{\infty} P_k^n$ is called the *algebra of k -valued logic*. It is well-known fact that there are k^{k^n} functions in P_k^n . For simplicity, let us assume that throughout the paper we shall consider k -valued functions, only.

For a given variable x and $\alpha \in Z_k$, x^α is defined as follows:

$$x^\alpha = \begin{cases} 1 & \text{if } x = \alpha \\ 0 & \text{if } x \neq \alpha. \end{cases}$$

The ring-sum expansion (RSE) of a function f is the sum modulo k of a constant and products of variables x_i or x_i^α , (for $\alpha, \alpha \in Z_k$) of f . For example, $1 \oplus x_1 x_2^2$ is a RSE of the function f in the algebra P_3^2 , with $f(1, 2) = 2$, $f(2, 2) = 0$ and $f = 1$, otherwise. Any k instances of the same product in the RSE can be eliminated since

they sum to 0. Throughout the present paper, we shall use RSE-representation of functions.

Let $f \in P_k^n$ and let $\text{var}(f) = \{x_1, \dots, x_n\}$ be the set of all variables, which occur in f . We say that the i -th variable $x_i \in \text{var}(f)$ is *essential* in f , or f *essentially depends* on x_i , if there exist values $a_1, \dots, a_n, b \in Z_k$, such that

$$f(a_1, \dots, a_{i-1}, a_i, a_{i+1}, \dots, a_n) \neq f(a_1, \dots, a_{i-1}, b, a_{i+1}, \dots, a_n).$$

The set of all essential variables in the function f is denoted $\text{Ess}(f)$ and $\text{ess}(f) = |\text{Ess}(f)|$. The variables from $\text{var}(f)$ which are not essential in $f \in P_k^n$ are called *inessential* or *fictive*.

Let x_i be an essential variable in f and let c be a constant from Z_k . The function $g = f(x_i = c)$ obtained from $f \in P_k^n$ by assigning the constant c to the variable x_i is called a *simple subfunction* of f (sometimes termed a *cofactor* or a *restriction*). When g is a simple subfunction of f we write $f \succ g$. The transitive closure of \succ is denoted \succeq . $\text{Sub}(f) = \{g \mid f \succeq g\}$ is the set of all subfunctions of f and $\text{sub}(f) = |\text{Sub}(f)|$.

We say that each subfunction g of f is a reduction to f via the *subfunction relationship*.

A non-empty set M of essential variables in the function f is called *separable* in f if there exists a subfunction g , $f \succeq g$ such that $M = \text{Ess}(g)$. $\text{Sep}(f)$ denotes the set of all the separable sets in f and $\text{sep}(f) = |\text{Sep}(f)|$.

An essential variable x_i in a function $f \in P_k^n$ is called a *strongly essential variable* in f if there is a constant c_i such that $\text{Ess}(f(x_i = c_i)) = \text{Ess}(f) \setminus \{x_i\}$. The set of all strongly essential variables in f is denoted $\text{SEss}(f)$.

The following lemma is independently proved by K. Chimev [3] and A. Salomaa [12] in different variations.

Lemma 2.1. [3] *Let f be a function. If $\text{ess}(f) \geq 2$ then f has at least two strongly essential variables, i.e. $|\text{SEss}(f)| \geq 2$.*

Let x_i and x_j be two distinct essential variables in f . The function h is obtained from $f \in P_k^n$ by *identifying (collapsing) the variables x_i and x_j* , if

$$h(a_1, \dots, a_{i-1}, a_i, a_{i+1}, \dots, a_n) = f(a_1, \dots, a_{i-1}, a_j, a_{i+1}, \dots, a_n),$$

for all $(a_1, \dots, a_n) \in Z_k^n$.

Briefly, when h is obtained from f , by identifying the variable x_i with x_j , we write $h = f_{i \leftarrow j}$ and h is called a *simple identification minor* of f [4]. Clearly, $\text{ess}(f_{i \leftarrow j}) < \text{ess}(f)$, because $x_i \notin \text{Ess}(f_{i \leftarrow j})$, but it has to be essential in f . When h is a simple identification minor of f we write $f \triangleright h$. The transitive closure of \triangleright is denoted \trianglerighteq . $\text{Mnr}(f) = \{h \mid f \trianglerighteq h\}$ is the set of all distinct minors of f and $\text{mnr}(f) = |\text{Mnr}(f)|$. Let h , $f \trianglerighteq h$ be an identification minor of f . The natural number $r = \text{ess}(f) - \text{ess}(h)$, $r \geq 1$ is called the *order* of the minor h of f .

We say that each minor h of f is a reduction to f via the *minor relationship*.

Let $\text{Mnr}_m(f)$ denote the set $\text{Mnr}_m(f) = \{g \mid g \in \text{Mnr}(f) \ \& \ \text{ess}(g) = m\}$ and let $\text{mnr}_m(f) = |\text{Mnr}_m(f)|$, for all m , $m \leq n - 1$.

Let $f \in P_k^n$ be an n -ary k -valued function. The *essential arity gap* (shortly *arity gap* or *gap*) of f is defined as follows

$$\text{gap}(f) = \text{ess}(f) - \max_{h \in \text{Mnr}(f)} \text{ess}(h).$$

Let $2 \leq p \leq m$. We let $G_{p,k}^m$ denote the set of all k -valued functions which essentially depend on m variables whose arity gap is equal to p , i.e.

$$G_{p,k}^m = \{f \in P_k^n \mid \text{ess}(f) = m \ \& \ \text{gap}(f) = p\}.$$

We say that the arity gap of f is *non-trivial* if $\text{gap}(f) \geq 2$. It is natural to expect that the functions with "huge" gap, have to be more simple for realization by MVL-circuits and functional schemas when computing by identifying variables. For more results about the arity gap we refer [3, 4, 12, 14, 16, 17, 20].

Definition 2.2. Two functions g and h are called *equivalent (non-distinct as mappings)* (written $g \equiv h$) if g can be obtained from h by permutation of variables, introduction or deletion of inessential variables.

As mentioned earlier, there are two general ways for reduction of functions - by subfunctions or by minors. The complexities of these processes we call the *subfunction or minor complexities*, respectively.

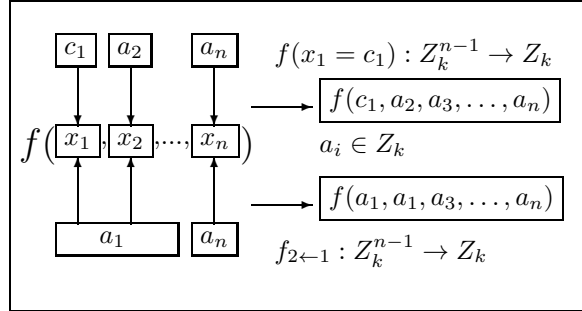

FIGURE 1. Simple subfunction and simple minor of functions

Figure 1 illustrates the difference between these two models of computing. The reduction to simple subfunction $f(x_1 = c_1)$ is presented in the top of the figure, and computing the identification minor $f_{2 \leftarrow 1}$ is shown in the bottom of the figure. The resulting functions of the both computations have the same domain - Z_k^{n-1} and the same range - Z_k (see the right side of Figure 1). In practice, both resulting functions can be seen as partial mappings of Z_k^n into Z_k . The subfunction $f(x_1 = c_1)$ is obtained by fixing the first input (x_1), whereas the minor $f_{2 \leftarrow 1}$ has two identical inputs (the left-lower corner of the figure). Another obvious difference between these concepts is the following: Each identification minor can be decomposed into subfunctions, but there are subfunctions which can not be decomposed into minors. For example, let $f = x_1 \oplus x_2 \oplus x_3$ be a Boolean function. It is easy to see that the subfunction $f(x_1 = 1) = x_2 \oplus x_3 \oplus 1$ can not be decomposed into any minors of f .

Many computations, constructions, processes, translations, mappings and so on, can be modeled as stepwise transformations of objects known as reduction systems. *Abstract Reduction Systems (ARS)* play an important role in various areas such as abstract data type specification, functional programming, automated deductions, etc. [10, 18] The concepts and properties of ARS also apply to other rewrite systems such as string rewrite systems (Thue systems), tree rewrite systems, graph grammars, etc. For more detailed facts about ARS we refer to J. W. Klop and Roel de Vrijer [10]. An ARS in P_k^n is a structure $W = \langle P_k^n, \{\rightarrow_i\}_{i \in I} \rangle$, where $\{\rightarrow_i\}_{i \in I}$

is a family of binary relations on P_k^n , called *reductions or rewrite relations*. For a reduction \rightarrow_i the transitive and reflexive closure is denoted \rightarrow_i^* . A function $g \in P_k^n$ is a *normal form* if there is no $h \in P_k^n$ such that $g \rightarrow_i h$. In all different branches of rewriting two basic concepts occur, known as termination (guaranteeing the existence of normal forms) and confluence (securing the uniqueness of normal forms).

A reduction \rightarrow_i has the *unique normal form property* (UN) if whenever $t, r \in P_k^n$ are normal forms obtained by applying the reductions \rightarrow_i on a function $f \in P_k^n$ then t and r are equivalent (non-distinct as mappings).

The computations on functions proposed in the present paper can be regarded as an ARS, namely: $W = \langle P_k^n, \{\succ, \triangleright\} \rangle$. Next, we show that \triangleright completes the reduction process with unique normal form, whereas \succ has not unique normal form property.

A reduction \rightarrow is *terminating* (or *strongly normalizing* SN) if every reduction sequence $f \rightarrow f_1 \rightarrow f_2 \dots$ eventually must terminate. A reduction \rightarrow is *weakly confluent* (or *has weakly Church-Rosser property* WCR) if $f \rightarrow r$ and $f \rightarrow v$ imply that there is $w \in P_k^n$ such that $r \rightarrow w$ and $v \rightarrow w$.

Theorem 2.3.

- (i) *The reduction \triangleright is UN;*
- (ii) *The reduction \succ is not WCR, but it is SN.*

Proof. (i) (SN) Clearly, if $f \triangleright g$ then $ess(f) > ess(g)$. Since the number of essential variables $ess(f_i)$ of the functions f_i in any reduction sequence $f \triangleright f_1 \triangleright \dots \triangleright f_i \triangleright \dots$ strongly decrease, it follows that the sequence eventually must terminate, i.e. the reduction is terminating.

(WCR) Let f be a function and $f \triangleright g$, and $f \triangleright h$. Let t and r be normal forms such that $g \triangleright t$ and $h \triangleright r$. Note that each normal form is a resulting minor obtained by collapsing all the essential variables in f . Hence, $ess(t) \leq 1$ and $ess(r) \leq 1$. Then we have $t = f(x_j, \dots, x_j)$, for some $x_j \in Ess(f)$ and $r = f(x_i, \dots, x_i)$, for some $x_i \in Ess(f)$, and hence,

$$t = f(x_j, \dots, x_j) \equiv f(x_i, \dots, x_i) = r.$$

Now, (i) follows from Newman's Lemma (Theorem 1.2.1. [10]), which states that WCR & SN \Rightarrow UN. □

(ii) is clear. □

Below, we also establish a key theorem which states that the functions with simplest minor complexity (with non-trivial arity gap) have extremely complex representations with respect to the number of their subfunctions, and separable sets.

Lemma 2.4. *Let $N \in Sep(f)$. If there exist m constants $c_1, \dots, c_m \in Z_k$ such that $N \cap Ess(g_i) = \emptyset$ where $g_i = f(x_i = c_i)$ for $1 \leq i \leq m$ then $M \cup N \in Sep(f)$ for all $M \neq \emptyset$, $M \subseteq \{x_1, \dots, x_m\}$.*

Proof. It suffices to look only at the set $M = \{x_1, \dots, x_m\}$. First, assume that $M \cap N = \emptyset$ and without loss of generality let us assume $N = \{x_{m+1}, \dots, x_s\}$, $m < s \leq n$. Since $N \in Sep(f)$, there exists a vector of constants, say $\phi d = (d_{s+1}, \dots, d_n) \in Z_k^{n-s}$ such that $N \subseteq Ess(g)$, where

$$g = f(x_{s+1} = d_{s+1}, \dots, x_n = d_n).$$

Let us fix an arbitrary variable from N , say the variable $x_s \in N$. Then there exist $s - m - 1$ constants $d_{m+1}, \dots, d_{s-1} \in Z_k$ such that $x_s \in \text{Ess}(h)$ where

$$h = g(x_{m+1} = d_{m+1}, \dots, x_{s-1} = d_{s-1}).$$

We have to prove that $M \subseteq \text{Ess}(h)$. Let us suppose the opposite, i.e. there is a variable, say $x_1 \in M$ which is inessential in h . Since $x_1 \in \{x_1, \dots, x_m\}$, there is a value $c_1 \in Z_k$ such that $N \cap \text{Ess}(t) = \emptyset$ where $t = f(x_1 = c_1)$. Our supposition shows that $h = h(x_1 = c_1)$ and hence, $N \cap \text{Ess}(h) = \emptyset$, i.e. $x_s \notin \text{Ess}(h)$, which is a contradiction. Consequently, $M = \text{Ess}(h)$. Then $g \succeq h$ implies $M \subseteq \text{Ess}(g)$ and hence, $M \cup N = \text{Ess}(g)$ which establishes that $M \cup N \in \text{Sep}(f)$.

Second, let $M \cap N \neq \emptyset$. Then we can pick $P = M \setminus N$ and hence, $P \subseteq \{x_1, \dots, x_m\}$, $P \cap N = \emptyset$, and $N \in \text{Sep}(f)$. As shown, above $P \cup N \in \text{Sep}(f)$ and $M \cup N \in \text{Sep}(f)$, as desired. \square \square

Corollary 2.5. *Let x_i and x_j be two distinct essential variables in f . If there is a constant c , $c \in Z_k$ such that $f(x_i = c)$ does not essentially depend on x_j then $\{x_i, x_j\} \in \text{Sep}(f)$.*

Next, we turn our attention to relationship between essential arity gap and separable sets in functions.

Theorem 2.6. *Let $f \in P_k^n$. If $\text{gap}(f) \geq 2$ then all non-empty sets of essential variables are separable in f .*

Proof. Without loss of generality, let us assume that $\text{Ess}(f) = \{x_1, \dots, x_n\}$. Let M be an arbitrary non-empty set of essential variables in f . We shall prove that $M \in \text{Sep}(f)$ by considering cases. The theorem is given to be true if $n \leq 2$. Next, we assume $n > 2$.

Case 1: $\text{gap}(f) = 2$, $n \geq 3$ and $k = 2$.

If $n \leq 4$ then we are done because of Theorem 3.2 and Theorem 3.3 in [14].

Let $n \geq 5$. From Theorem 3.4 in [14] it follows that

$$f = \bigoplus_{\alpha_1 \oplus \dots \oplus \alpha_n = 1} x_1^{\alpha_1} \dots x_n^{\alpha_n} \quad \text{or} \quad f = \bigoplus_{\alpha_1 \oplus \dots \oplus \alpha_n = 0} x_1^{\alpha_1} \dots x_n^{\alpha_n}.$$

Clearly, $\text{Ess}(f) = X_n$. Suppose, with no loss of generality that $M = \{x_1, \dots, x_m\}$, $m < n$ and

$$f = \bigoplus_{\alpha_1 \oplus \dots \oplus \alpha_n = 1} x_1^{\alpha_1} \dots x_n^{\alpha_n}.$$

Let $c_1, \dots, c_n \in Z_k$ and $c_1 \oplus \dots \oplus c_n = 1$. We can pick $t = f(x_{m+1} = c_{m+1}, \dots, x_n = c_n)$ and $r = c_{m+1} \oplus \dots \oplus c_n$. Assume, without loss of generality, that $r = 1$. Then we have

$$t = \bigoplus_{\alpha_1 \oplus \dots \oplus \alpha_m = 0} x_1^{\alpha_1} \dots x_m^{\alpha_m}.$$

It must be shown that $M = \text{Ess}(t)$. By symmetry, it suffices to show that $x_1 \in \text{Ess}(t)$. Let $c_2, \dots, c_m \in Z_k$ be $m - 1$ values, such that $c_2 \oplus \dots \oplus c_m = 0$. Then we have

$$t(0, c_2, \dots, c_m) = 1 \quad \text{and} \quad t(1, c_2, \dots, c_m) = 0,$$

which establishes that $x_1 \in \text{Ess}(t)$.

Case 2: $\text{gap}(f) = 2$, $2 < k < n$.

Theorem 2.1 from [20] implies that $Ess(f) = X_n$ and f is a symmetric function. According to Theorem 4.1 [17], it follows that all the non-empty subsets of X_n are separable in f .

Case 3: $gap(f) = 2$, $n = 3$ and $k \geq 3$.

Using Theorem 5.1 and Proposition 5.1 in [16], one can show that $Ess(f) = X_n$ and $M \subseteq X_n \Rightarrow M \in Sep(f)$, analogous to Case 1.

Case 4: $gap(f) = 2$, $4 \leq n \leq k$.

If f is a symmetric function then we are done because of Theorem 4.1 in [17] and if f is not a symmetric function then the proof is done as a part of *Case 6*, given below.

Case 5: $gap(f) = n$, $3 \leq n \leq k$.

From Theorem 3.1 [16] it follows that f is represented in the following form:

$$(1) \quad f = a_0 \left[\bigoplus_{\alpha \in Eq_k^n} \mathbf{x}^\alpha \right] \oplus \left[\bigoplus_{\beta \in Dis_k^n} a_r \mathbf{x}^\beta \right],$$

where

$$Eq_k^s = \{\gamma \in Z_k^s \mid \exists i, j, 1 \leq i < j \leq s, \gamma_i = \gamma_j\},$$

$\gamma = \gamma_1 \dots \gamma_s$, $\mathbf{x}^\gamma = x_1^{\gamma_1} x_2^{\gamma_2} \dots x_s^{\gamma_s}$ and $Dis_k^s = Z_k^s \setminus Eq_k^s$, for $s, s \geq 2$. Moreover, there exist at least two distinct coefficients among $a_r \in Z_k$ for $r \in \{0, 1, \dots, k^n - 1\}$.

It is easy to see that $Ess(f) = X_n$. Let M be an arbitrary non-empty set of essential variables in f . We have to show that $M \in Sep(f)$. Without loss of generality let us assume that $M = \{x_1, \dots, x_m\}$, $1 \leq m \leq n$. If $m = n$ or $m = 1$, we are clearly done. Let $1 < m < n$ and let $\beta_{m+1}, \dots, \beta_n \in Z_k$ be $n - m$ constants such that the subfunction $f_1 = f(x_{m+1} = \beta_{m+1}, \dots, x_n = \beta_n)$ is not a constant function.

By symmetry, it suffices to show that $x_1 \in Ess(f_1)$. Without loss of generality let us assume that $a_0 \neq b_1$, where $b_1 = f_1(\gamma_1, \gamma_2, \dots, \gamma_m)$ for some $\gamma_1, \dots, \gamma_m \in Z_k$. Then, (1) implies

$$b_1 = f_1(\gamma_1, \gamma_2, \dots, \gamma_m) \neq a_0 = f_1(\gamma_2, \gamma_2, \dots, \gamma_m),$$

which shows that $x_1 \in Ess(f_1)$ and $Ess(f_1) = M$, and hence, $M \in Sep(f)$.

Case 6: $gap(f) = p$, $2 \leq p < n$, and $4 \leq n \leq k$.

If $p > 2$ then according to Theorem 3.4 in [16], there exist two functions h and g , such that $f = h \oplus g$, where $g \in G_{n,k}^n$ and $ess(h) = n - p$. Moreover, $g_{i \leftarrow j} = 0$ for all i and j , $1 \leq j < i \leq n$. The same representation of f is established when $p = 2$, in Theorem 4.2 [16]. Without loss of generality, let us assume that $Ess(h) = \{x_1, \dots, x_{n-p}\}$.

Clearly, $Ess(f) = X_n$ and according to (1) we can pick $g = u \oplus v$, where

$$(2) \quad u = \left[\bigoplus_{\beta \in Dis_k^n} a_r \mathbf{x}^\beta \right] \quad \text{and} \quad v = a_0 \left[\bigoplus_{\alpha \in Eq_k^n} \mathbf{x}^\alpha \right].$$

Let $x_i, x_j \in X_n$, $i > j$, be two arbitrary essential variables in g . For simplicity, say $i = n$ and $j = n - 1$. Then we have

$$(3) \quad g_{i \leftarrow j} = u_{i \leftarrow j} \oplus v_{i \leftarrow j} = 0 \oplus a_0 \left[\bigoplus_{\delta \in Z_k^{n-2}} \hat{\mathbf{x}}^\delta \right] = a_0.$$

Since $g_{i \leftarrow j} = 0$ for all i and j , $1 \leq j < i \leq n$, it follows $v_{i \leftarrow j} = a_0 = 0$. Consequently, $v = 0$ and $g = u$. Let M be a non-empty set of essential variables in f . M has to

be separable set in g , according to *Case 5* and if $M \cap \text{Ess}(h) = \emptyset$ then it is also separable in f .

We have to prove that $M \in \text{Sep}(f)$ in all other cases. We argue by induction on n - the number of essential variables in f and g .

Let $n = 4$. This is our basis for induction.

First, let $|M| = 2$ and $p = 2$. Clearly, if $M \subseteq \text{Ess}(h)$ then (2) and (3) show that $M \in \text{Sep}(f)$. Next, let us assume that $M = \{x_1, x_3\}$ and $\text{Ess}(h) = \{x_1, x_2\}$. Let $c_2, c_4 \in Z_k$ be two constants, such that $\text{Ess}(t_1) = \{x_1, x_3\}$, where $t_1 = g(x_2 = c_2, x_4 = c_4)$. Clearly, $x_3 \in \text{Ess}(f_1)$, where $f_1 = f(x_2 = c_2, x_4 = c_4)$. Let $h_1 = h(x_2 = c_2)$. If $x_1 \notin \text{Ess}(h_1)$ then $x_1 \in \text{Ess}(f_1)$ and obviously, $M \in \text{Sep}(f)$. If $x_1 \in \text{Ess}(h_1)$ then $f_1 = h_1(x_1) \oplus t_1(x_1, x_3)$. According to (2) and (3) there is a constant $c_3 \in Z_k$, such that $\text{Ess}(t_1(x_3 = c_3)) = \emptyset$. Hence, $x_1 \in \text{Ess}(f_1(x_3 = c_3))$ and $M \in \text{Sep}(f)$, again.

Second, let $|M| = 3$ and $p = 2$, and $\text{Ess}(h) = \{x_1, x_2\}$.

Let $x_1 \notin M$. Then there is a constant $c_1 \in Z_k$, such that $x_2 \in \text{Ess}(h_2)$, where $h_2 = h(x_1 = c_1)$. Thus, (2) implies that $\{x_2, x_3, x_4\} = \text{Ess}(f_2)$, where $f_2 = f(x_1 = c_1)$ and $M \in \text{Sep}(f)$, again.

Let $x_4 \notin M$. Then there is a constant $d_4 \in Z_k$, such that $x_3 \in \text{Ess}(t_2)$, where $t_2 = g(x_4 = d_4)$. Clearly, $x_3 \in \text{Ess}(f_3)$, where $f_3 = f(x_4 = d_4)$. According to (2) and (3), we have $f_3(x_3 = d_4) = h(x_1, x_2) \oplus a_0$, which shows that $\{x_1, x_2, x_3\} = \text{Ess}(f_3)$, and hence $M \in \text{Sep}(f)$.

One can similarly argue if $p = 3$ and $n = 4$.

Let us assume that for some natural number l , $l \geq 4$, if $n < l$, $2 \leq p$, $l < k$ and $f \in G_{p,k}^n$, then all non-empty sets of essential variables in f are separable.

Let us pick $n = l$. According to Lemma 2.1, there is a strongly essential variable x_i , $1 \leq i \leq l$ in g , and let $c_i \in Z_k$ be a constant, such that $X_l \setminus \{x_i\} = \text{Ess}(g(x_i = c_i))$. Without loss of generality, let us assume that $i = l$ and $c_i = k - 1$. Using (2), it is easy to see that

$$(4) \quad t_3 = g(x_l = k - 1) = \left[\bigoplus_{\beta \in \text{Dis}_{k-1}^{l-1}} b_r \tilde{x}^\beta \right],$$

and the coefficients b_r linearly depend on a_0, \dots, a_{k-1} , and $\tilde{x}^\beta = x_1^{\beta_1} \dots x_{l-1}^{\beta_{l-1}}$. By $p \geq 2$ we may reorder the variables in h such that $\text{Ess}(h) = \{x_1, \dots, x_{l-p}\}$ with $l - p < l - 1$.

Then we can pick $f_4 = f(x_l = k - 1) = h \oplus t_3$. It must be shown that $\text{Ess}(f_4) = X_{l-1}$. Since $p \geq 2$, it follows that $N = \text{Ess}(f_4) \setminus \text{Ess}(h) \neq \emptyset$. Next, using (2), one can show that $N \in \text{Sep}(t_3)$ and $N \in \text{Sep}(f_4)$. According to (3) we have

$$N \cap \text{Ess}(f_4(x_i = k - 1)) = \emptyset,$$

for all $i = 1, \dots, l - p$. Now, Lemma 2.4 implies $N \cup \{x_1, \dots, x_{l-p}\} \in \text{Sep}(f_4)$. Hence, $\text{Ess}(f_4) = X_{l-1}$. According to (4) it follows that $f_4 \in G_{p,k-1}^{l-1}$.

Therefore the inductive assumption may be applied to f_4 , yielding $M \in \text{Sep}(f_4)$, and hence, $M \in \text{Sep}(f)$. \square

3. MINOR DECISION DIAGRAMS OF FUNCTIONS

Intuitively, it seems that a function f has high complexity if all its sets of essential variables are separable, because the variables from separable sets remain essential after assigning constants to other variables (see [15]). For example, when

assigning Boolean constants to some variables of a Boolean function, then a natural complexity measure is the size of its Binary Decision Diagrams (BDDs), which also depend on the variable ordering (see [1, 2]). Each path from the root (function node) to a terminal node (leaf) of BDD is called an *implementation* of f . In [15] we count the subfunction complexities $imp(f)$, $sub(f)$ and $sep(f)$ of all implementations obtained under all $n!$ variable orderings, subfunctions, and separable sets of n -ary Boolean functions for $n, n \leq 5$.

Example 3.1. Let $f = x_1 \oplus x_2 \oplus x_3 \pmod 2$ and $g = x_1^0x_2 \oplus x_1x_3 \pmod 2$ be two Boolean functions. Figure 2 presents their BDDs. All sets of essential variables in f are separable, whereas the set $\{x_2, x_3\}$ is inseparable in g . Obviously, the BDD of the function f is extremely complex with respect to the numbers of its subfunctions and implementations (see [15]), whereas the BDD of g is very simple. Thus we have $imp(f) = 48$, $sub(f) = 15$, $sep(f) = 7$ and $imp(g) = 28$, $sub(g) = 11$, and $sep(g) = 6$.

This example shows that the functions having non-empty inseparable sets of essential variables must be quite simple with respect to the subfunction complexities, whereas Theorem 2.6 shows that the functions without inseparable sets of variables have trivial arity gap, which means that they must be with high minor complexity.

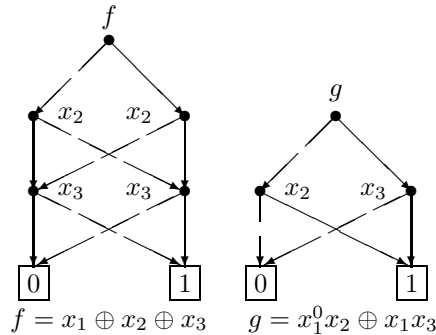

FIGURE 2. BDD for f and g under the natural ordering of variables.

Roughly spoken, the complexity of functions, is a mapping (evaluation) $Val : P_k^n \rightarrow \mathbb{N}$ with $Val(x) = c$ for all $x \in X$ and for some natural number $c \in \mathbb{N}$, called the *initial value* of the complexity, and $Val(f) \geq c$ for all $f \in P_k^n$.

The concept of complexity of functions is based on the "difficulties" when computing several resulting objects as subfunctions, implementations, separable sets, values, superpositions, etc.

As mentioned, we have used the computational complexities $sub(f)$, $imp(f)$ and $sep(f)$ in [15] to classify the functions from the algebra P_k^n . These complexities are invariants under the action of the groups SB_k^n , IM_k^n and SP_k^n .

Figure 3 shows the minor decomposition tree, constructed for the function $f = x_1^0x_2^1 \oplus x_2^0x_3^1x_4^2 \pmod 3$, which essentially depends on all of its four variables x_1, x_2, x_3 and x_4 . The node at the left, labelled f - is the *function* node. The nodes represented as ovals and labelled with minor names are the *internal (non-terminal)* nodes, and the rectangular nodes (leaves of the tree) are the *terminal* nodes. The terminal nodes are labelled with the same name of a function (atomic

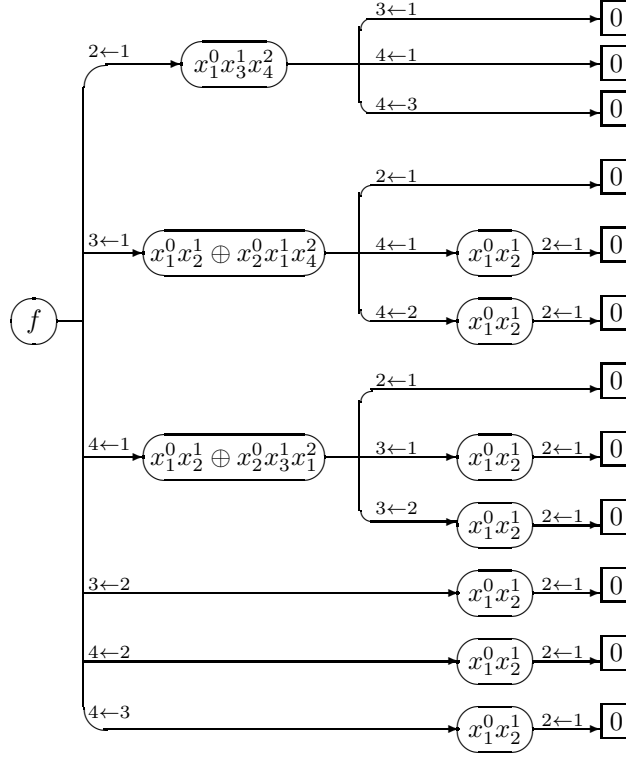

FIGURE 3. Minor decomposition tree of $f = x_1^0 x_2^1 \oplus x_2^0 x_3^1 x_4^2 \pmod{3}$.

minor) from P_k^1 (according to Theorem 2.3). The terminal and non-terminal nodes in the MDT for a function f , essentially depending on n variables, are disposed into maximum $n - 1$ layers of the tree. The i -th layer consists of names of all the distinct minors of order i , for $i = 1, \dots, n - 1$.

We introduce the *minor decision diagrams* (MDDs) for k -valued functions constructed by reducing their *minor decomposition trees* (MDTs). Let f be a k -valued function. The *minor decision diagram* (MDD) of f is obtained from the corresponding MDT by *reductions* of its nodes and edges applying of the following rules, starting from the MDT and continuing until neither rule can be applied:

Reduction rules

- If two edges have equivalent (as mappings) labels of their nodes they are merged.
- If two nodes have equivalent labels, they are merged.

Each edge $e = (v_1, v_2)$ in the diagram is supplied with a label $l(v_1, v_2)$, (written as bold in Figure 4 A), which presents the number of the merged edges of the MDT, connecting the nodes v_1 and v_2 in MDT. If two nodes in MDT are connected with unique edge then this edge is presented in MDD without label, for brevity. For example, such pairs in Figure 3 are $(f, f_{2\leftarrow 1})$, $(f, f_{3\leftarrow 1})$, $(f, f_{4\leftarrow 1})$, $(f_{3\leftarrow 1}, 0)$, $(f_{3\leftarrow 2}, 0)$ and $(f_{4\leftarrow 1}, 0)$.

So, the MDD of f is an acyclic directed graph, with unique function node and according to Theorem 2.3, with unique terminal node. Clearly, the MDD and MDT are uniquely determined by the function f .

Example 3.2. Let us build the MDDs of the following two functions $f = x_1^0 x_2^1 \oplus x_2^0 x_3^1 x_4^2 \pmod{3}$ and $g = x_1^0 x_2^1 \oplus x_2^0 x_3^1 x_4^1 \pmod{3}$, using the reduction rules.

Figure 4 A) shows the MDD of the function f , obtained from its MDT, given in Figure 3, after applying the reduction rules. Figure 4 B) presents the MDD of g . The identification minors of f and g are:

$$\begin{aligned} f_{2\leftarrow 1} &= x_1^0 x_3^1 x_4^2 \pmod{3}, & f_{3\leftarrow 1} &= x_1^0 x_2^1 \oplus x_2^0 x_1^1 x_4^2 \pmod{3}, \\ f_{4\leftarrow 1} &= x_1^0 x_2^1 \oplus x_2^0 x_3^1 x_1^2 \pmod{3}, & f_{3\leftarrow 2} &= x_1^0 x_2^1 \pmod{3}, \end{aligned}$$

$$\begin{aligned} g_{2\leftarrow 1} &= x_1^0 x_3^1 x_4^1 \pmod{3}, & g_{3\leftarrow 1} &= x_1^0 x_2^1 \oplus x_2^0 x_1^1 x_4^1 \pmod{3}, \\ g_{4\leftarrow 1} &= x_1^0 x_2^1 \oplus x_2^0 x_3^1 x_1^1 \pmod{3}, & g_{4\leftarrow 3} &= x_1^0 x_2^1 \oplus x_2^0 x_3^1 \pmod{3}, \\ [g_{2\leftarrow 1}]_{4\leftarrow 3} &= x_1^0 x_3^1 \pmod{3}, & [g_{3\leftarrow 1}]_{4\leftarrow 1} &= x_1^0 x_2^1 \oplus x_2^0 x_1^1 \pmod{3}, \\ g_{3\leftarrow 2} &= x_1^0 x_2^1 \pmod{3}. \end{aligned}$$

Clearly, $f_{3\leftarrow 2} = f_{4\leftarrow 2} = f_{4\leftarrow 3} = [f_{4\leftarrow 1}]_{3\leftarrow 1} = [f_{4\leftarrow 1}]_{3\leftarrow 2} = [f_{3\leftarrow 1}]_{4\leftarrow 1} = [f_{3\leftarrow 1}]_{4\leftarrow 2} = x_1^0 x_2^1 \pmod{3}$. The minors $f_{i\leftarrow 1}$ for $i = 2, 3, 4$ are of order 1, and the last minor $f_{3\leftarrow 2}$ is of order 2.

The label of the edge $(f, f_{3\leftarrow 2})$ is **3** because there are three identification minors, namely $f_{3\leftarrow 2}$, $f_{4\leftarrow 2}$ and $f_{4\leftarrow 3}$ of f which are equivalent to $f_{3\leftarrow 2}$ (see the last three branches of the MDT in Figure 3). In a similar way we count the labels of the edges in Figure 4 B). Note that $g_{3\leftarrow 1} \equiv g_{4\leftarrow 1}$ and $[g_{2\leftarrow 1}]_{4\leftarrow 3} \equiv g_{3\leftarrow 2}$, which implies that the nodes labelled with these minors must be merged in the MDD of g . The functions f and g are very close (the difference is that x_4^2 in f is changed to x_4^1 in g) in their formula representations, but the diagram of g is more complex as we see in Figure 4 B).

The size of the MDD and the minor complexities are determined by the function, being represented. The "scalability" of the diagram is an important measure of the computational complexity of the function. We are going to formalize this problem and establish a method for classification of functions by the minor complexities.

First, the number $mnr(f)$ of all the minors of a function f is a complexity measure, which can be used to evaluate the MDD of f . Namely, it counts the size (number of terminal and non-terminal nodes) of the MDD. M. Couceiro, E. Lehtonen and T. Waldhauser have studied similar evaluation, named "parametrized arity gap" in [5, 6], which characterizes the sequential identification minors of a function.

We define two new complexity measures which count the number of minors and the number of ways to obtain these minors. Our goal is to classify functions in finite algebras by these complexities.

Definition 3.3. Let $f \in P_k^n$ be a k -valued function. Its *cmr-complexity* $cmr(f)$ is defined as follows:

- (i) $cmr(f) = 1$ if $ess(f) \leq 1$;
- (ii) $cmr(f) = 2$ if $ess(f) = 2$;
- (iii) $cmr(f) = \sum_{j < i, x_i, x_j \in Ess(f)} cmr(f_{i\leftarrow j})$ if $ess(f) \geq 3$.

The minors $f_{i\leftarrow j}$ with $i < j$ are excluded because $f_{i\leftarrow j} \equiv f_{j\leftarrow i}$. The minor complexity cmr can be inductively calculated using the MDDs of the functions

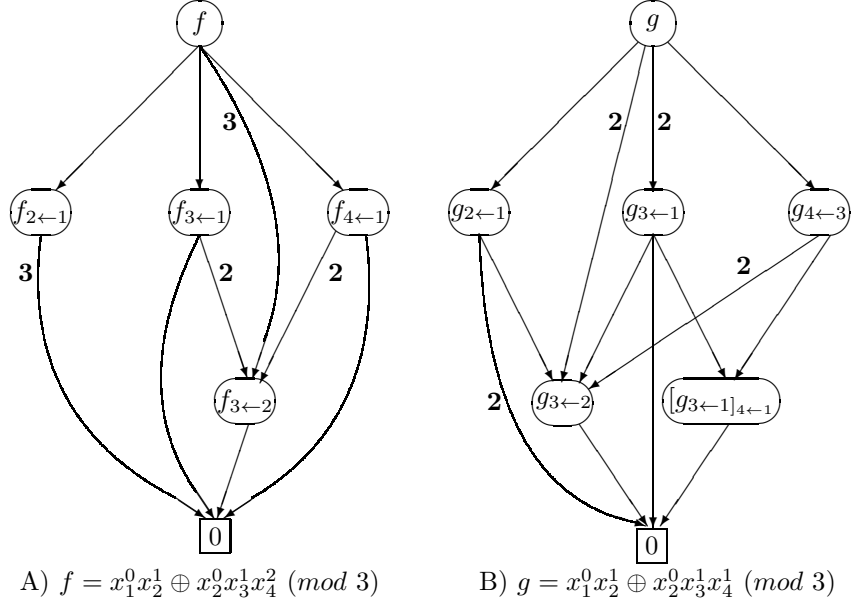

FIGURE 4. Minor decision diagrams

as it is shown in Algorithm 1, below. We start to assign *cmr*-complexity equals to 1 for the terminal node, according to (i) of Definition 3.3. Next, we calculate the *cmr*-complexity of the minors of f with lower order, applying (ii) and (iii) of Definition 3.3.

Example 3.4. We now count the *cmr*-complexity of the functions f and g from Example 3.2, using their MDDs given in Figure 4 A) and B), respectively. There is one minor ($f_{3\leftarrow 2}$) of order 2 and three minors of order 1. Thus we have $cmr(f_{3\leftarrow 2}) = 2$, $cmr(f_{2\leftarrow 1}) = 1.3 = 3$, $cmr(f_{3\leftarrow 1}) = 1.1 + 2.2 = 5$, and $cmr(f_{4\leftarrow 1}) = 1.1 + 2.2 = 5$. Again, using (ii) and (iii) of Definition 3.3 we obtain $cmr(f) = 3 + 5 + 5 + 3.2 = 19$.

The MDD of g in Figure 4 B) shows that:

$$\begin{aligned} cmr(g_{3\leftarrow 2}) &= cmr([g_{3\leftarrow 1}]_{4\leftarrow 1}) = 2, & cmr(g_{2\leftarrow 1}) &= 2.1 + 1.2 = 4, \\ cmr(g_{3\leftarrow 1}) &= 1.2 + 1.1 + 1.2 = 5, & cmr(g_{4\leftarrow 3}) &= 2.2 + 1.2 = 6, \\ \text{and } cmr(g) &= 1.4 + 2.2 + 2.5 + 1.6 = 24. \end{aligned}$$

We clearly have: $mnr(f) = 5$ and $mnr(g) = 6$.

It is clear that the set $M = \{x_1, x_3, x_4\}$ is inseparable in both f and g .

Theorem 3.5. Let $f \in P_k^n$ with $2 \leq \text{ess}(f) = n \leq k$. Then

$$(i) \quad \frac{n(n-1)}{2} \leq cmr(f) \leq \frac{n!(n-1)!}{2^{n-2}};$$

$$(ii) \quad 1 \leq mnr(f) \leq \frac{n!(n-1)!}{2^{n-2}}.$$

Proof. The maximum number of minors of order 1 for a function f is equal to $\binom{n}{2}$. Using this as an inductive basis one can show that the maximum number of minors of order m , $1 \leq m \leq n - 1$ is equal to $\binom{n}{2} \binom{n-1}{2} \dots \binom{n-m+1}{2}$. Pick

$$f = x_1(x_2 \oplus 1) \dots (x_n \oplus (n-1)) \pmod{k}$$

with $n \leq k$. One can inductively prove that all the minors of f are pairwise distinct, which shows that f reaches the upper bound of (i) and (ii), and establishes the right inequalities in (i) and (ii).

The lower bound in (ii) is clear. If $n \leq k$ then the minimum number of minors in a function depending essentially on n variables is reached to the functions f from $G_{n,k}^n$ with $gap(f) = n$. It follows that f is represented as in (1), which shows that $cmr(f) = \binom{n}{2} = \frac{n(n-1)}{2}$. \square

Remark 3.6. Note that the upper bound of cmr and mnr is independent on k and hence, it is satisfied in all the possible cases for $2 \leq n \leq k$.

Later, we shall discuss lower and upper bounds of cmr and mnr when $k < n$, and for Boolean functions. A hypothesis, here is that the upper bound for (ii) is unreachable for k and n if $k < n$.

4. EQUIVALENCE RELATIONS WITH RESPECT TO MINOR COMPLEXITIES

Many of the problems in the applications of the k -valued logic are compounded because of the large number of the functions, namely k^{k^n} . Techniques which involve enumeration of functions can only be used if k and n are trivially small. A common way for extending the scope of such enumerative methods is to classify the functions into equivalence classes by some natural equivalence relation.

Let S_A denote the symmetric group of all permutations of the non-empty set A , and let S_m denote the group $S_{\{1, \dots, m\}}$ for a natural number m , $m \geq 1$.

A transformation $\psi : P_k^n \rightarrow P_k^n$ is an n -tuple of k -valued functions $\psi = (g_1, \dots, g_n)$, $g_i \in P_k^n$, $i = 1, \dots, n$ acting on any function $f = f(x_1, \dots, x_n) \in P_k^n$ as follows $\psi(f) = f(g_1, \dots, g_n)$. Then the composition of two transformations ψ and $\phi = (h_1, \dots, h_n)$ is defined as follows

$$\psi\phi = (h_1(g_1, \dots, g_n), \dots, h_n(g_1, \dots, g_n)).$$

The set of all transformations of P_k^n is the *universal monoid* Ω_k^n with unity - the identical transformation $\epsilon = (x_1, \dots, x_n)$. When taking only invertible transformations we obtain the *universal group* C_k^n isomorphic to the symmetric group $S_{Z_k^n}$. The groups consisting of invertible transformations of P_k^n are called *transformation groups* (sometimes termed *permutation groups*).

Let $\simeq, \simeq_{\subseteq} P_k^n \times P_k^n$ be an equivalence relation on the algebra P_k^n . Since P_k^n is a finite algebra of k -valued functions, the equivalence relation \simeq makes a partition of the algebra in a finite number equivalence classes P_1, \dots, P_r .

A mapping $\varphi : P_k^n \rightarrow P_k^n$ is called a *transformation preserving* \simeq if $f \simeq \varphi(f)$ for all $f \in P_k^n$. Taking only invertible transformations which preserve \simeq , we get the group G_{\simeq} of all transformations preserving \simeq . The *orbits* (also called *G_{\simeq} -types*) of this group are exactly the classes P_1, \dots, P_r . The number r of orbits of a group G_{\simeq} of transformations is denoted $t(G_{\simeq})$. Since we want to classify functions from P_k^n into equivalence classes by \simeq , three natural problems occur, namely:

- (i) Calculate the number $t(G_{\simeq})$ of G_{\simeq} -types;
- (ii) Count the number of functions in different equivalence classes, i.e. compute the cardinalities of the sets P_1, \dots, P_r ;
- (iii) Make a catalogue (list) of functions belonging to different G_{\simeq} -types.

Let $f \in P_k^n$ and let $\text{nof}(f)$ denote the normal form obtained by applying the reduction \triangleright on f . According to Theorem 2.3, the normal form $\text{nof}(f)$ is unique and $\text{nof}(f) \in P_k^1$. Thus, our first natural equivalence is defined as follows:

Definition 4.1. Let f and g be two functions from P_k^n . We say that f and g are *nof-equivalent* (written $f \simeq_{\text{nof}} g$) if $\text{nof}(f) = \text{nof}(g)$.

The transformation group induced by *nof*-equivalence is denoted NF_k^n . The transformations in NF_k^n preserves \simeq_{nof} , i.e. $\text{nof}(g) = \text{nof}(\psi(g))$ for all $g \in P_k^n$ and $\psi \in NF_k^n$. Since the atomic minors (labels of terminal nodes in MDD) depend on at most one essential variable, it follows that $t(NF_k^n) = |P_k^1| = k^k$. These transformations involve permuting variables, only (see Theorem 4.6, below). The *nof*-equivalence is independent on the *cmr*-complexity of functions, defined by reduction via minors. For example, the functions $f = 0$ and $g = x_1^0 x_2 \oplus x_1 x_2 x_3^0 \pmod{2}$ are *nof*-equivalent, but $\text{cmr}(f) = 1$ and $\text{cmr}(g) = 6$.

By analogy with the ordered decision diagrams [2, 15], we define several equivalence relations in P_k^n , which allow us to classify the functions by the complexity of their MDDs.

Definition 4.2. Let f and g be two functions from P_k^n . We say that f and g are *cmr-equivalent* (written $f \simeq_{\text{cmr}} g$) iff:

- (i) $\text{ess}(f) \leq 1 \implies \text{ess}(f) = \text{ess}(g)$;
- (ii) $\text{ess}(f) \geq 2 \implies \text{ess}(f) = \text{ess}(g)$ and there exists a permutation σ of the set $\{1, \dots, n\}$ such that $f_{i \leftarrow j} \simeq_{\text{cmr}} g_{\sigma(i) \leftarrow \sigma(j)}$ for all j, i , with $x_i, x_j \in \text{Ess}(f)$, $j < i$.

Let CM_k^n denote the transformation group preserving the equivalence \simeq_{cmr} . Note that if $\text{ess}(f) \leq 1$ then $Mnr(f) = \emptyset$. Hence, if $\text{ess}(f) = \text{ess}(g) \leq 1$ then $f \simeq_{\text{mnr}} g$. MN_k^n denotes the transformation group which preserves the equivalence \simeq_{mnr} .

Next we define another equivalence based on the number of minors (size of MDD) in a function.

Definition 4.3. Let f and g be two functions from P_k^n . We say that f and g are *mnr-equivalent* (written $f \simeq_{\text{mnr}} g$) if $\text{mnr}_m(f) = \text{mnr}_m(g)$ for all m , $0 \leq m \leq \text{ess}(f) - 1$.

Note that $f \simeq_{\text{mnr}} g$ or $f \simeq_{\text{nof}} g$ do not imply $\text{ess}(f) = \text{ess}(g)$, which can be seen by the following functions: $f = x_1^0 x_2^1 \pmod{3}$ and $g = x_1^0 x_2^1 x_3^2 \pmod{3}$. Clearly, $f \simeq_{\text{mnr}} g$ and $f \simeq_{\text{nof}} g$, but $\text{ess}(f) = 2$, and $\text{ess}(g) = 3$.

Theorem 4.4.

- (i) $f \simeq_{\text{cmr}} g \implies \text{cmr}(f) = \text{cmr}(g)$;
- (ii) $f \simeq_{\text{cmr}} g \implies f \simeq_{\text{mnr}} g$.

Proof. We argue by induction on the number $n = \text{ess}(f)$.

If $\text{ess}(f) \leq 2$ (basis for induction) then we are clearly done. Assume that (i) and (ii) are satisfied when $n < s$ for some natural number s , $s > 2$. Let $n = s$ and $f \simeq_{\text{cmr}} g$. Then our inductive assumption implies

$$\text{cmr}(f) = \sum_{j < i, x_i, x_j \in \text{Ess}(f)} \text{cmr}(f_{i \leftarrow j}) =$$

$$\sum_{u < v, x_u, x_v \in \text{Ess}(g)} \text{cmr}(g_{u \leftarrow v}) = \text{cmr}(g),$$

and $\text{mnr}_m(f_{i \leftarrow j}) = \text{mnr}_m(g_{u \leftarrow v})$, where $u = \pi(i)$ and $v = \pi(j)$ for some $\pi \in S_n$ and $m = 0, \dots, n-1$. \square

Thus, the complexity $\text{cmr}(f)$ is an invariant of the group CM_k^n , so that if $f \simeq_{\text{cmr}} g$ then $\text{cmr}(f) = \text{cmr}(g)$, and the complexity $\text{mnr}(f)$ is an invariant of the group MN_k^n , so that if $f \simeq_{\text{mnr}} g$ then $\text{mnr}(f) = \text{mnr}(g)$.

It is naturally to ask which groups among "traditional" transformation groups are subgroups of the groups NF_k^n or CM_k^n and which of these groups include NF_k^n , MN_k^n or CM_k^n as their subgroups.

Let $\sigma : Z_k \rightarrow Z_k$ be a mapping and $\psi_\sigma : P_k^n \rightarrow P_k^n$ be a transformation of P_k^n generated by σ as follows $\psi_\sigma(f)(\emptyset a) = \sigma(f(\emptyset a))$ for all $\emptyset a \in Z_k^n$.

Theorem 4.5. *The transformation ψ_σ preserves \simeq_{cmr} if and only if σ is a permutation of Z_k , $k > 2$.*

Proof. First, let $\sigma \in S_{Z_k}$ be a permutation of Z_k . Let $f \in P_k^n$ be an arbitrary function. If $\text{ess}(f) \leq 1$ then $\text{ess}(\psi_\sigma(f)) = \text{ess}(f)$ and we are clearly done. Let $\text{ess}(f) = \text{ess}(g) = n \geq 2$ and let i and j , $1 \leq j < i \leq n$ be two arbitrary natural numbers. Then we have

$$[\psi_\sigma(f)]_{i \leftarrow j}(x_1, \dots, x_n) = \sigma(f_{i \leftarrow j}(x_1, \dots, x_n)).$$

Since σ is a permutation, it follows that $f_{i \leftarrow j} \simeq_{\text{cmr}} [\psi_\sigma(f)]_{i \leftarrow j}$ which shows that $f \simeq_{\text{cmr}} \psi_\sigma(f)$.

Second, let σ be not a permutation of Z_k . Hence, there exist two constants a_1 and a_2 from Z_k such that $a_1 \neq a_2$ and $\sigma(a_1) = \sigma(a_2)$. Let $\emptyset b = (b_1, \dots, b_n) \in Z_k^n$, $n \geq 2$ be a vector of constants from Z_k . Then we define the following function from P_k^n :

$$f(x_1, \dots, x_n) = \begin{cases} a_1 & \text{if } x_i = b_i \text{ for } i = 1, \dots, n \\ a_2 & \text{otherwise.} \end{cases}$$

Clearly, $\text{Ess}(f) = X_n$ and the range of f consists of two numbers, i.e. $A = \{a_1, a_2\}$. Then $\sigma(A) = \{\sigma(a_1)\}$, implies that $\psi_\sigma(f)(c_1, \dots, c_n) = \sigma(a_1)$ for all $(c_1, \dots, c_n) \in Z_k^n$. Hence, $\text{Ess}(\psi_\sigma(f)) = \emptyset$, which shows that $f \not\simeq_{\text{cmr}} \psi_\sigma(f)$ and $\psi_\sigma \notin CM_k^n$. \square

Let $\pi \in S_n$ and $\phi_\pi : P_k^n \rightarrow P_k^n$ be a transformation of P_k^n defined as follows $\phi_\pi(f)(a_1, \dots, a_n) = f(a_{\pi(1)}, \dots, a_{\pi(n)})$ for all $(a_1, \dots, a_n) \in Z_k^n$.

Theorem 4.6. *The transformation ϕ_π preserves the equivalence relations \simeq_{cmr} , \simeq_{mnr} and \simeq_{nof} for all $\pi \in S_n$.*

Proof. It suffices to show that ϕ_π preserves \simeq_{cmr} and \simeq_{nof} .

Let $f \in P_k^n$ be a function and let us assume $\text{Ess}(f) = X_n$, $n \geq 2$. It must be shown that $f \simeq_{\text{cmr}} g$ and $f \simeq_{\text{nof}} g$, where $g(a_1, \dots, a_n) = f(\pi(a_1), \dots, \pi(a_n))$ for all $(a_1, \dots, a_n) \in Z_k^n$. Since π is a permutation, we have

$$f(a_1, \dots, a_n) = g(\pi^{-1}(a_1), \dots, \pi^{-1}(a_n)),$$

for all $(a_1, \dots, a_n) \in Z_k^n$ and one can easily show that $f \simeq_{\text{cmr}} g$ and hence, $f \simeq_{\text{cmr}} \phi_\pi(f)$. Since $\text{nof}(f) = f(x_i, \dots, x_i)$ and $\text{nof}(f) = f(x_{\pi(i)}, \dots, x_{\pi(i)})$, it follows $\text{nof}(g) \equiv \text{nof}(f)$ and $f \simeq_{\text{nof}} g$. \square

We deal with "natural" equivalence relations which involve variables of functions. Such relations induce permutations of the domain Z_k^n of the functions. These mappings form a transformation group whose number of equivalence classes can be determined. The restricted affine group (RAG) is defined as a subgroup of the symmetric group on the direct sum of the module Z_k^n of arguments of functions and the ring Z_k of their outputs. The group RAG permutes the direct sum $Z_k^n + Z_k$ under restrictions which preserve single-valuedness of all functions from P_k^n [9, 11, 19].

In the model of RAG an affine transformation ψ operates on the domain or space of inputs $\mathbf{x} = (x_1, \dots, x_n)$ to produce the output $\mathbf{y} = \mathbf{x}\mathbf{A} \oplus \mathbf{c}$, which might be used as an input in the function f . Its output $f(\mathbf{y})$ together with the function variables x_1, \dots, x_n are linearly combined by a range transformation which defines the image $g = \psi(f)$ of f as follows:

$$(5) \quad \begin{aligned} g(\mathbf{x}) = \psi(f)(\mathbf{x}) = f(\mathbf{y}) \oplus a_1x_1 \oplus \dots \oplus a_nx_n \oplus d = \\ f(\mathbf{x}\mathbf{A} \oplus \mathbf{c}) \oplus \mathbf{a}^t\mathbf{x} \oplus d, \end{aligned}$$

where d and a_i for $i = 1, \dots, n$ are constants from Z_k . Such a transformation belongs to RAG if \mathbf{A} is a non-singular matrix.

We want to extract basic facts for several subgroups of RAG which are "neighbourhoods" or "relatives" of our transformation groups NF_k^n , CM_k^n and MN_k^n . It is also interesting to compare these groups with the groups IM_k^n , SB_k^n and SP_k^n , studied in [15].

First, a classification occurs when permuting arguments of functions. If $\pi \in S_n$ then π acts on variables by: $\pi(x_1, \dots, x_n) = (x_{\pi(1)}, \dots, x_{\pi(n)})$. Each permutation generates a map on the domain Z_k^n .

For example, the permutation $\pi = (1, 3, 2)$ generates a permutation of the domain $\{0, 1, 2\}^3$ of the functions from P_3^3 . Then we have $\pi : 001 \rightarrow 010 \rightarrow 100$ and in cyclic decimal notation this permutation can be written as $(1, 3, 9)$. The remaining elements of Z_3^3 are mapped according to the following cycles of π in decimal notation - $(2, 6, 18)(4, 12, 10)(5, 15, 19)(7, 21, 11)(8, 24, 20)(14, 16, 22)(17, 25, 23)$. Note that each permutation from S_n keeps fixed all k constant tuples from Z_k^n . In case of Z_3^3 , these tuples $(0, 0, 0)$, $(1, 1, 1)$ and $(2, 2, 2)$ are presented by the decimal numbers 0, 13 and 26.

S_k^n denotes the transformation group induced by permuting of variables.

Boolean functions of two variables are classified into twelve S_2^2 -classes [9], as it is shown in Table 1.

TABLE 1. The twelve classes in P_2^2 under the permutation of arguments.

$[0]$,	$[x_1^0x_2^0]$,	$[x_1^0x_2, x_1x_2^0]$,	$[x_1, x_2]$,
$[x_1 \oplus x_2]$,	$[x_1 \oplus x_2^0]$,	$[x_1^0 \oplus x_1x_2, x_2^0 \oplus x_1x_2]$,	$[x_1 \oplus x_1^0x_2]$,
$[x_1^0 \oplus x_1x_2^0]$,	$[x_1x_2]$,	$[x_1^0, x_2^0]$,	$[1]$.

M. Harrison has determined the cycle index of the group S_2^n and using Polya's counting theorem he has counted the number of equivalence classes under permuting arguments (see [9] and Table 4, below).

The following proposition is obvious.

Proposition 4.7. *The transformation group S_k^n is induced by the equivalence relation \equiv (see Definition 2.2).*

The subgroups of RAG, defined according to (5) are determined by equivalence relations as it is shown in Table 2, where \mathbf{P} denotes a permutation matrix, \mathbf{I} is the identity matrix, \mathbf{b} and \mathbf{c} are n -dimensional vectors over Z_k^n and $d \in Z_k$.

TABLE 2. The subgroups of RAG

Groups	Equivalence relations	Determination
RAG	Affine transformation	\mathbf{A} -non-singular
GE_k^n	Genus	$\mathbf{A} = \mathbf{P}$, $\mathbf{a} = \mathbf{0}$
CF_k^n	Complement outputs	$\mathbf{A} = \mathbf{I}$, $\mathbf{a} = \mathbf{0}$, $\mathbf{c} = \mathbf{0}$
G_k^n	Symmetry types	$\mathbf{A} = \mathbf{P}$, $\mathbf{a} = \mathbf{0}$, $d = 0$
LF_k^n	Add linear function	$\mathbf{A} = \mathbf{I}$, $\mathbf{c} = \mathbf{0}$, $d = 0$
CA_k^n	Complement arguments	$\mathbf{A} = \mathbf{I}$, $\mathbf{a} = \mathbf{0}$, $d = 0$
LG_k^n	Linear transformation	$\mathbf{c} = \mathbf{0}$, $\mathbf{a} = \mathbf{0}$, $d = 0$
S_k^n	Permute variables	$\mathbf{A} = \mathbf{P}$, $\mathbf{c} = \mathbf{0}$, $\mathbf{a} = \mathbf{0}$, $d = 0$

It is naturally to ask which subgroups of RAG are subgroups of the group NF_k^n , CM_k^n and MN_k^n . Theorem 4.5 and Theorem 4.6 show that CF_k^n and S_k^n are subgroups of CM_k^n . Theorem 4.4 shows that they must also be subgroups of MN_k^n . Clearly, $S_k^n \leq NF_k^n$.

Example 4.8. Let $f = x_1 \oplus x_2 \oplus x_3 \pmod{3}$ and $g = x_1x_2 \oplus x_1x_3 \oplus x_2x_3 \pmod{3}$. Then we have $f_{i \leftarrow j} = 2x_j \oplus x_m \pmod{3}$ and $g_{i \leftarrow j} = 2x_jx_m \oplus x_jx_j \pmod{3}$ where $\{i, j, m\} = \{1, 2, 3\}$. Clearly, $f_{i \leftarrow j, j \leftarrow m} = g_{i \leftarrow j, j \leftarrow m} = 0$, and hence $f \simeq_{cmr} g$ and $f \simeq_{nof} g$. One can show that there is no transformation $\psi \in RAG$, defined as in (5), for which $g = \psi(f)$. Consequently, $CM_k^n \not\leq RAG$, $NF_k^n \not\leq RAG$ and $MN_k^n \not\leq RAG$.

Example 4.9. Let $f = x_1^0x_2^1 \oplus x_2^0x_3^1x_4^2 \pmod{3}$ and $g = x_1^0x_2^1 \oplus x_2^0x_3^1x_4^1 \pmod{3}$ be the functions from Example 3.4 whose MDDs are given in Figure 4. Let

$$\mathbf{A} = \begin{pmatrix} 1 & 0 & 0 & 0 \\ 0 & 1 & 0 & 0 \\ 0 & 0 & 1 & 0 \\ 0 & 0 & 0 & 2 \end{pmatrix}$$

Then clearly, $f(\mathbf{x}) = g(\mathbf{Ax})$ and hence, f and g belong to the same equivalence class under the transformation groups LG_3^4 . Let $\mathbf{c} = (0, 0, 0, 1)$. Then we have $f(\mathbf{x}) = g(\mathbf{x} \cdot \mathbf{I} \oplus \mathbf{c})$, which shows that f and g belong to the same equivalence class under the transformation group CA_3^4 . One can show that $f \simeq_{nof} g$. Example 3.4 shows that $f \not\leq_{mnr} g$. Consequently, $NF_k^n \not\leq MN_k^n$, $LG_k^n \not\leq MN_k^n$ and $CA_k^n \not\leq MN_k^n$. Theorem 4.4 shows that $NF_k^n \not\leq CM_k^n$, $LG_k^n \not\leq CM_k^n$ and $CA_k^n \not\leq CM_k^n$.

Example 4.10. Let $f = x_1^0x_2 \oplus x_1^1x_3 \oplus x_1^2x_2^1x_3^0 \pmod{3}$ and $g = x_1^0x_2 \oplus x_1^1x_3 \pmod{3}$ be two functions. It is easy to see that $f_{i \leftarrow j} = g_{i \leftarrow j}$ for all i, j with $1 \leq j < i \leq 3$. Hence, $f \simeq_{cmr} g$ and $f \simeq_{nof} g$. Now, it is clear that each set of essential variables in f is separable in f , but $\{x_2, x_3\} \notin Sep(g)$ which shows that $f \not\leq_{sep} g$, i.e. $CM_k^n \not\leq SP_k^n$ and $NF_k^n \not\leq SP_k^n$.

So, the next theorem summarizes results which determine the positions of the groups NF_k^n , CM_k^n and MN_k^n , with respect to the subgroups of RAG and the groups induced by subfunction complexities [15].

Theorem 4.11.

- (i) $CF_k^n \leq CM_k^n$; (ii) $S_k^n \leq CM_k^n$; (iii) $S_k^n \leq NF_k^n$;
 (iv) $NF_k^n \not\leq RAG$; (v) $CM_k^n \not\leq RAG$; (vi) $LG_k^n \not\leq MN_k^n$;
 (vii) $CA_k^n \not\leq MN_k^n$; (viii) $CA_k^n \not\leq NF_k^n$; (ix) $LG_k^n \not\leq NF_k^n$;
 (x) $CM_k^n \not\leq SP_k^n$; (xi) $CM_k^n \not\leq SP_k^n$; (xii) $CM_k^n \not\leq NF_k^n$;
 (xiii) $NF_k^n \not\leq MN_k^n$.

Proof. (i) follows from Theorem 4.5, (ii) and (iii)- from Theorem 4.6, (iv) and (v) - from Example 4.8, (vi), (vii), (viii), (ix) and (xiii) - from Example 4.9, (x) and (xi)- from Example 4.10.

To show (xii) let us pick $f = x_1^0 x_2^0 \pmod{2}$ and $g = x_1 x_2 \pmod{2}$. Clearly, $f \simeq_{cmr} g$, but $nof(f) = x_1^0 \neq x_1 = nof(g)$. \square \square

Theorem 4.11 is well-illustrated by Figure 5, in the case of Boolean functions.

5. CLASSIFICATION OF BOOLEAN FUNCTIONS BY MINOR COMPLEXITIES

Table 3 shows the four classes in P_2^2 under the equivalence \simeq_{cmr} . The \simeq_{cmr} -classes are represented as union of several classes under the permuting arguments, according to Theorem 4.11 (ii) (see Tables 1 and Table 3).

TABLE 3. The four classes in P_2^2 under the cmr -complexity.

$[0, 1],$	$[x_1^0 x_2, x_1 x_2^0, x_1 \oplus x_2, x_1 \oplus x_2^0, x_1^0 \oplus x_1 x_2, x_2^0 \oplus x_1 x_2],$
$[x_1, x_2, x_1^0, x_2^0],$	$[x_1 x_2, x_1 \oplus x_1^0 x_2, x_1^0 \oplus x_1 x_2^0, x_1^0 x_2^0].$

The number of types $t(S_2^n)$ under permuting arguments, is an upper bound of the number of equivalence classes induced by the relations \simeq_{nof} , \simeq_{cmr} and \simeq_{mnr} for $n \leq 6$ (see Table 4). Theorem 4.11 shows that the transformation groups NF_k^n , CM_k^n and MN_k^n are not comparable with the groups IM_k^n , SB_k^n and SP_k^n , determined by subfunction complexities.

TABLE 4. Number of equivalence classes in P_2^n under transformation groups.

n	S_2^n	CM_2^n	MN_2^n	IM_2^n	SB_2^n	SP_2^n
1	4	2	2	2	2	2
2	12	4	3	4	4	3
3	80	11	5	13	11	5
4	3984	*	*	104	74	11
5	37 333 248	*	*	*	*	38
6	25 626 412 338 274 304	*	*	*	*	*

Figure 5 presents the subgroups of RAG and transformation groups whose invariants are subfunction and minor complexities of Boolean functions of n -variables. According to Theorem 4.11 the group CM_2^n has three subgroups from RAG, namely: S_2^n - the group of permuting arguments, trivial group, consisting of the identity map,

only and CF_2^n - the group of complementing outputs. The groups NF_2^n and MN_2^n are not subgroups of any subgroup of RAG and also, they are not subgroups of any group among IM_2^n , SP_2^n and SB_2^n .

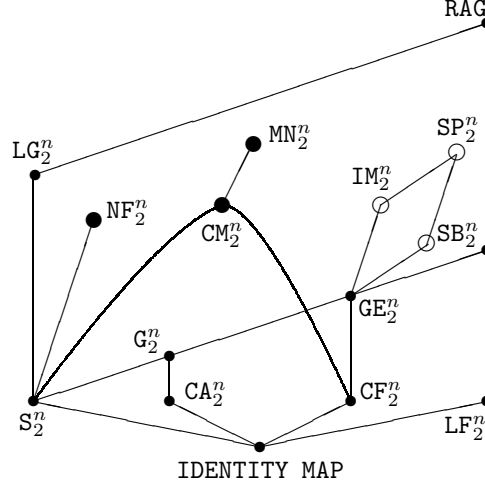

FIGURE 5. Transformation groups in P_2^n .

Table 5 presents a full classification of the Boolean functions of tree variables by the minor complexities cmr and mnr . If we agree to regard each 2^3 -tuple as a binary number then the last column presents the vectors of values of all ternary Boolean functions in their table representation with the natural numbers from the set $\{0, \dots, 127\}$. According to Theorem 4.5, if a natural number z presents a function f which belongs to a cmr -class then the function \hat{f} presented by $255 - z$ belongs to the same class. Thus the catalogue (see the last column) contains the numbers ≤ 127 , only. They represent the functions which preserve zero, i.e. the functions f for which $f(0, 0, 0) = 0$. This classification shows that there are eleven equivalence classes under \simeq_{cmr} and five classes under \simeq_{mnr} . Theorem 4.4 shows that each mnr -class is a disjoint union of several cmr -classes. Thus the first mnr -class consists of all the functions which belong to the first and the second cmr -class (see fifth column in Table 5). The second mnr -class is equal to the third cmr -class. The fourth and the fifth mnr -classes are unions of three cmr -class, namely: sixth, seventh and eight, and ninth, tenth and eleventh, respectively.

6. APPENDIX

Table 5 presents classification of ternary Boolean functions under the equivalences \simeq_{cmr} and \simeq_{mnr} , including the catalogue of the equivalence classes (last column).

Example 6.1. Let us choose a natural number belonging to the seventh column of Table 5, say 24. It belongs to the row numbered 6. The binary representation of 24 is 00011000, because $24 = 1 \cdot 2^4 + 1 \cdot 2^3$. Hence, the function f corresponding to 24 is evaluated by 1 on the fourth and fifth miniterms, namely $x_1^0 x_2 x_3$ and $x_1 x_2^0 x_3^0$. Consequently, $f = x_1^0 x_2 x_3 \oplus x_1 x_2^0 x_3^0 \pmod{2}$. Then we have $f_{2 \leftarrow 1} = f_{3 \leftarrow 1} = 0$ and $f_{3 \leftarrow 2} = x_1^0 x_2 \oplus x_1 x_2^0 \pmod{2}$. Clearly, $cmr(f) = 4$, which is written in the third cell

of the sixth row. The MDD of f is shown in the second cell. The *cmr*-equivalence class containing f consists of 18 functions, according to the fourth cell of the sixth row and the *mnr*-equivalence class of f contains 108 functions (see whole fifth column of the table). The function $x_1x_2x_3^0(\text{mod } 2)$ is representative for this class (sixth cell). The numerical list of the function from this equivalence class is given in the last seventh cell of Table 5.

We also provide an algorithm to find the complexity $cmr(f)$ of an arbitrary k -valued function f . Similar algorithms for manipulation of Boolean functions are presented in [2, 13]. We shall express our algorithm in a pseudo-Pascal notation. The main data structure describes the nodes in the MDD of f . Each node is represented by a record declared as follows:

```

type minor=record
  ess: 1..n;
  val: 0..kkn - 1;
end;









```

The first field named `ess` presents the number of essential variables in f and the second field `val` is a natural number whose k -ary representation is the last column \mathbf{b} of the truth table (of size k^n) of f . For example, the function f from Example 6.1 is presented as `f.ess=3` and `f.val=24`, where $k = 2$ and $\mathbf{b} = 00011000$.

The algorithm that computes `GETMINOR(g,i,j)` uses well-known manipulations on the rows and columns of the truth table, which realise collapsing the i -th and j -th column and removing m -th row if $a_{mi} \neq a_{mj}$ for all $m = 1, \dots, k^n$. This algorithm has to use a procedure, which excludes all inessential variables in the resulting minor.

The function `GETMINOR(g,i,j)` realizes one step of the reduction \triangleright . It is also useful when constructing the MDD of a function. Then the basic algorithm in addition, has to calculate the labels of the edges in MDD and to test whether two minors are equivalent (in terms of Definition 2.2).

TABLE 5. Minor classification of ternary Boolean functions.

cmr-class		cmr	Functions		mnr	Repres. function	Catalogue
	MDD		per class				
1	const	1	2			0	0
2	var	1	6	8	0	x_1	15,51,85
3		2	18	18	1	$x_1x_2^0$	10,12,34,48,60,68, 80,90,102
4		2	12			x_1x_2	3,5,17, 63,95,119
5		3	8	20	1	$x_1 \oplus x_2$ $\oplus x_3$	43,77, 105,113
6		4	18			$x_1x_2x_3^0$	2,4,8, 16,24,32, 36,64,66
7		5	36			$x_1x_2^0x_3$ $\oplus x_1x_2x_3^0$	6,18,20,26,28,38, 40,44,52,56,70,72, 74,82,88,96, 98,100
8		6	54	108	2	$x_1x_2^0$ $\oplus x_1x_2x_3^0$	14,22,30,42,46,50, 54,58,62,76,78,84, 86,92,94,104,106, 108,110,112,114,116, 118,120,122,124,126
9		4	50			x_1x_2 $\oplus x_1x_2^0x_3$	7,11,13,19,21,23, 31,35,41,47,49,55, 59,69,73,79,81,87, 93,97,107,109,115, 117,121
10		5	36			$x_1x_2x_3$ $\oplus x_1x_2^0x_3^0$	9,27,29,33,39,45, 53,57,65,71,75,83, 89,99,101, 111,123,125
11		6	16	102	3	$x_1x_2x_3$	1,25,37, 61,67,91, 103,127

Algorithm 1 Counting $\text{cmr}(f)$

```

1: type minor=record
    ess: 1..n;
    val: 0.. $k^{k^n} - 1$ ;
end;
2: var f:minor;
3: cmr:integer;
4: function GETMINOR(g:minor; i,j:integer): minor;           ▷ Getting minor
5:   var A,H: array[1.. $k^N$ , 1..N] of integer (mod k);
      B,L; array[1.. $k^N$ ] of integer (mod k);
      h: minor;
6:   n := g.ess;
7:   Create truth table  $A_{k^n \times n} B$  of g;
8:   Create truth table  $H_{k^{n-1} \times n} L$  of  $h := g_{i \leftarrow j}$ ;   ▷ Use truth table of g
9:   Calculate - h.ess and h.val from table HL;
10:  GetMinor := h;
11: end function;
12: function COMPLEXITY(g:minor):integer;                   ▷ Counting complexity
13:   n := g.ess;
14:   if n > 2 then
15:     for j,  $1 \leq j \leq n - 1$  do
16:       for i,  $j + 1 \leq i \leq n$  do
17:         h := GetMinor(g, i, j);
18:         Complexity := Complexity + Complexity(h);
19:       end for
20:     end for
21:   else           ▷ Basis of recursion
22:     if n = 2 then
23:       Complexity := 2
24:     else
25:       Complexity := 1
26:     end if
27:   end if
28: end function
29: Input k; f.ess; f.val;
30: cmr:=Complexity(f).;
31: Print cmr.

```

7. CONCLUSION

The traditional complexity measures of functions are based on the reductions down to subfunctions or values of functions. They are numerical parameters of the decision diagrams built under different variable orderings.

The minor complexities present another concept of computing finite functions, namely when identifying variables.

The relationship between subfunction and minor complexities in functions seems to be "strange". First of all, the functions with simplest minor representations (with non-trivial arity gap) has extremely complex representations with respect to their

subfunctions (Theorem 2.6). So, all functions with at least one inseparable set have trivial arity gap.

The transformation groups whose invariants are the minor complexities have only three subgroups among the groups in RAG, namely trivial group (identity map), S_k^n and CF_k^n , whereas the groups whose invariants are the subfunction complexities have three subgroups more, namely the groups listed above, and CA_k^n , G_k^n , and GE_k^n (see Figure 5 and Table 2).

One of motivations to study the group NF_k^n is that the reductions are inexpensive (see Algorithm 1, below) and the number of classes is much smaller than with (say) GE_k^n , because the order of NF_k^n is so large. The order of GE_k^n is $n!k^n$ (see [11]). As mentioned, the number of equivalence classes under NF_k^n equals to k^k . Hence, the order of NF_k^n is equal to $k^{k^n}/k^k = k^{k^n-1}$.

The most complex functions with respect to separable sets [15] are grouped in the largest equivalence class. J. Denev and I. Gyudzhenov in [7] proved that for almost all k -valued functions all sets of essential variables are separable. Similar results can not be proved for the minor complexities. For example, in P_2^3 the most complex functions belong to the class numbered as 11 (see Table 5), which consists of 16 function. This class is not so large. It presents 1/16 of the all 256 ternary Boolean functions.

REFERENCES

- [1] H. Andersen. An introduction to binary decision diagrams, 1997. Lecture notes for 49285 Adv. Algorithms.
- [2] R. E. Bryant. Graph-based algorithms for boolean function manipulation. *IEEE Transactions on Computers*, C-35(8):677–691, 1986.
- [3] K. Chimev. Separable sets of arguments of functions. *MTA SzTAKI Tanulmányok*, 80:1–173, 1986.
- [4] M. Couceiro and E. Lehtonen. Generalizations of Swierczkowski’s lemma and the arity gap of finite functions. *Discrete Mathematics*, 309:5905–5912, 2009.
- [5] M. Couceiro, E. Lehtonen, and T. Waldhauser. GAP vs. PAG. *Multiple-Valued Logic*, 42:268–273, 2012.
- [6] M. Couceiro, E. Lehtonen, and T. Waldhauser. Parametrized arity gap. *Order*, 30:557–572, 2013.
- [7] J. Denev and I. Gyudzhenov. On separable subsets of arguments of functions from p_k . *MTA SzTAKI Tanulmányok*, 26(147):47–50, 1984.
- [8] E. Dubrova. Multiple-valued logic in VLSI: challenges and opportunities. In *Proceedings of NORCHIP’99*, pages 340–350, Oslo, Norway, 1999.
- [9] M. Harrison. Counting theorems and their applications to classification of switching functions. In A. Mikhopadhyay, editor, *Recent Developments in Switching Theory*, pages 85–120. NY, Academic Press, 1971.
- [10] J. Klop and R. de Vrijer. *Term rewriting systems*. Cambridge University Press, 2003.
- [11] R. J. Lechner. Harmonic analysis of switching functions. In A. Mikhopadhyay, editor, *Recent Developments in Switching Theory*, pages 121–228. NY, Academic Press, 1971.
- [12] A. Salomaa. On essential variables of functions, especially in the algebra of logic. *Annales Academiae Scientiarum Fennicae*, Ser. A(333):1–11, 1963.
- [13] J. E. Savage. *Models of computation, Exploring the Power of Computing*. Brown University, <http://cs.brown.edu/people/jes/book/>, 2008.
- [14] Sl. Shtrakov. Essential arity gap of boolean functions. *Serdica, Journal of Computing*, 2(3):249–266, 2008.
- [15] Sl. Shtrakov and I. Damyanov. On the computational complexity of finite operations. *International Journal of Foundations of Computer Science*, 27(01):15–38, 2016.
- [16] Sl. Shtrakov and J. Koppitz. On finite functions with non-trivial arity gap. *J. Discussiones Mathematicae - General Algebra and Applications*, 30:217–245, 2010.

- [17] Sl. Shtrakov and J. Koppitz. Finite symmetric functions with non-trivial arity gap. *Serdica, Journal of Computing*, 6(4):419–436, 2012.
- [18] Sl. Shtrakov and J. Koppitz. Stable varieties of semigroups and groupoids. *Algebra Universalis*, 75(1):85–106, 2016.
- [19] I. Strazdins. On fundamental transformation groups in the algebra of logic. In B. Csákány and I. Rosenberg, editors, *Finite algebra and multiple-valued logic*, volume 28, pages 669–691, Szeged, 1979. Colloquia Mathematica Societatis János Bolyai.
- [20] R. Willard. Essential arities of term operations in finite algebras. *Discrete Mathematics*, 149:239–259, 1996.

E-mail address: `shtrakov@swu.bg`

URL: `http://shtrakov.swu.bg/`

DEPARTMENT OF COMPUTER SCIENCE, SOUTH-WEST UNIVERSITY, BLAGOEVGRAD