

FINITENESS FOR MAPPING CLASS GROUP REPRESENTATIONS FROM TWISTED DIJKGRAAF-WITTEN THEORY

PAUL GUSTAFSON

ABSTRACT. Any twisted Dijkgraaf-Witten representation of a mapping class group of an orientable, compact surface with boundary has finite image.

1. INTRODUCTION

Given a spherical category \mathcal{A} over a field k and an oriented compact surface M , possibly with boundary, the Turaev-Viro-Barrett-Westbury (TVBW) construction gives a projective representation of the mapping class group $\text{MCG}(M)$ [1, 2]. A natural question is to determine the image of these representations. In particular, when does such a representation have finite image?

It is conjectured that these representations have finite image if and only if \mathcal{A} is weakly integral. This conjecture is a modification of the Property F conjecture [3, 4], which states that braid group representations coming from a braided monoidal category \mathcal{C} should have finite image if and only if \mathcal{C} is weakly integral. Instead of only considering braid group representations, one can consider mapping class groups of arbitrary orientable surfaces. In this case, the input categories to construct the representations must be more specialized than just braided monoidal. One can either apply the Reshitikhin-Turaev construction to a modular tensor category, or apply the TVBW construction to a spherical category. The former is more general than the latter since the Reshitikhin-Turaev construction for the Drinfeld center $Z(\mathcal{A})$ of a spherical category \mathcal{A} yields the same representation as the TVBW construction for \mathcal{A} . However, for the case considered in this paper, the simpler TVBW construction suffices.

In this paper, our input category is $\mathcal{A} = \text{Vec}_G^\omega$, the spherical category of G -graded vector spaces with associativity modified by a cocycle $\omega \in Z^3(G, k^\times)$. In this case, the TVBW construction corresponds to the twisted Dijkgraaf-Witten theory of [5]. The category Vec_G^ω is integral, so one expects its associated mapping class group representations to have finite image. The main contribution of this paper is to verify this for arbitrary G and ω .

Acknowledgments. This paper would not have been written without the guidance of my advisor, Eric Rowell. I am also grateful to Zhengang Wang and my father Robert Gustafson for their advice.

2. RELATED WORK

The closest related work is a result of Fjelstad and Fuchs [6] showing that, given a surface with at most one boundary component, the mapping class group representations corresponding to the untwisted (i.e. $\omega = 1$) Dijkgraaf-Witten theory have finite image. Their paper uses an algebraic method of Lyubashenko [7] that gives a projective mapping class group representation to any factorizable ribbon Hopf algebra, in their case, the double $D(G)$. In our case, we instead consider the mapping class group action on a vector space of Vec_G^ω -colored embedded graphs defined by Kirillov [8], yielding a simpler, more geometric proof.

In [9], Bantay defined representations of mapping class groups on the Hilbert space of an orbifold model associated to $D^\omega(G)$. These representations appear to coincide with the twisted Dijkgraaf-Witten representations. However, the precise details of the connection are not clear to me.

More is known when we fix a particular surface M . In the case where M is a torus, Ng and Schauenburg showed that any Reshitikhin-Turaev representation of the mapping class group of the torus is finite [10]. In the case where M is an n -punctured disk, the mapping class group of M relative to the boundary of the disk is the braid group B_n . In this case, Etingof, Rowell, and Witherspoon proved that the representations associated to $\text{Mod}(D^\omega(G))$ are finite [4].

3. DEFINITIONS

Let G be a finite group, and let Vec_G^ω denote the skeletal spherical category of G -graded vector spaces with associativity defined by the 3-cocycle $\omega \in Z^3(G, k^\times)$. We will follow [11] in the choice of structural morphisms. The

associator $\alpha_{g,h,k} : (g \otimes h) \otimes k \rightarrow g \otimes (h \otimes k)$ is defined to be

$$\alpha_{g,h,k} = \omega(g, h, k) \text{id}_{ghk}.$$

The evaluator $\text{ev}_g : g^* \otimes g \rightarrow 1$ is

$$\text{ev}_g = \omega(g^{-1}, g, g^{-1}) \text{id}_1.$$

The coevaluator $\text{coev}_g : 1 \rightarrow g \otimes g^*$ is

$$\text{coev}_g = \text{id}_1.$$

The pivotal structure $j_g : g^{**} \rightarrow g$ is

$$j_g = \omega(g^{-1}, g, g^{-1}) \text{id}_g.$$

The following definitions and theorem are from Kirillov's paper [8]. For any spherical category \mathcal{A} and surface M , he gives the following presentation of the Levin-Wen model as a vector space of colored graphs modulo local relations. He also proves that this space is canonically isomorphic to the TVBW vector space associated to M . It is straightforward to check that this isomorphism, which amounts to replacing a triangulation with its dual graph, commutes with the mapping class group action.

We will consider finite graphs embedded in an oriented surface Σ (which may have boundary); for such a graph Γ , let $E(\Gamma)$ be the set of edges. Note that edges are not oriented. Let E^{or} be the set of oriented edges, i.e. pairs $\mathbf{e} = (e, \text{orientation of } e)$; for such an oriented edge \mathbf{e} , we denote by $\bar{\mathbf{e}}$ the edge with opposite orientation.

If Σ has a boundary, the graph is allowed to have uncolored one-valent vertices on $\partial\Sigma$ but no other common points with $\partial\Sigma$; all other vertices will be called interior. We will call the edges of Γ terminating at these one-valent vertices *legs*.

Definition 3.1. Let Σ an oriented surface (possibly with boundary) and $\Gamma \subset \Sigma$ — an embedded graph as defined above. A coloring of Γ is the following data:

- Choice of an object $V(\mathbf{e}) \in \text{Obj } \mathcal{A}$ for every oriented edge $\mathbf{e} \in E^{or}(\Gamma)$ so that $V(\bar{\mathbf{e}}) = V(\mathbf{e})^*$.
- Choice of a vector $\varphi(v) \in \text{Hom}(1, V(\mathbf{e}_1) \otimes \cdots \otimes V(\mathbf{e}_n))$ for every interior vertex v , where $\mathbf{e}_1, \dots, \mathbf{e}_n$ are edges incident to v , taken in counterclockwise order and with outward orientation.

The following theorem is a variation of result of Reshetikhin and Turaev.

Theorem 3.2. There is a unique way to assign to every colored planar graph Γ in a disk $D \subset \mathbb{R}^2$ a vector

$$(1) \quad \langle \Gamma \rangle_D \in \text{Hom}(1, V(\mathbf{e}_1) \otimes \cdots \otimes V(\mathbf{e}_n))$$

where $\mathbf{e}_1, \dots, \mathbf{e}_n$ are the edges of Γ meeting the boundary of D (legs), taken in counterclockwise order and with outgoing orientation, so that that following conditions are satisfied:

- (1) $\langle \Gamma \rangle$ only depends on the isotopy class of Γ .
- (2) If Γ is a single vertex colored by $\varphi \in \text{Hom}(1, V(\mathbf{e}_1) \otimes \cdots \otimes V(\mathbf{e}_n))$, then $\langle \Gamma \rangle = \varphi$.
- (3) Local relations shown in Figure 1 hold.

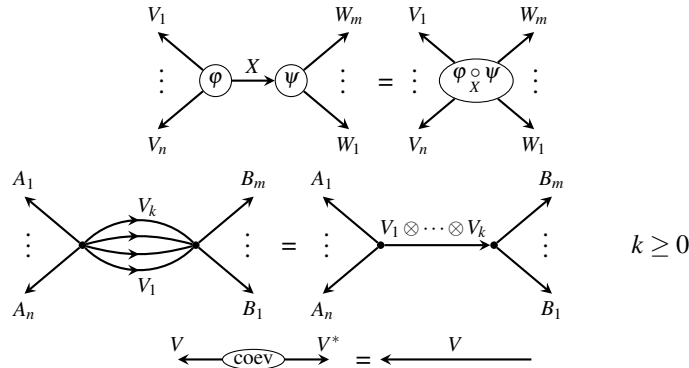

FIGURE 1. Local relations for colored graphs. Here $\varphi \circ_X \psi = (\varphi \otimes \psi) \circ \text{ev}_X$.

Local relations should be understood as follows: for any pair Γ, Γ' of colored graphs which are identical outside a subdisk $D' \subset D$, and in this disk are homeomorphic to the graphs shown in Figure 1, we must have $\langle \Gamma \rangle = \langle \Gamma' \rangle$.

Moreover, so defined $\langle \Gamma \rangle$ satisfies the following properties:

- (1) $\langle \Gamma \rangle$ is linear in color of each vertex v (for fixed colors of edges and other vertices).
- (2) $\langle \Gamma \rangle$ is additive in colors of edges as shown in Figure 2.

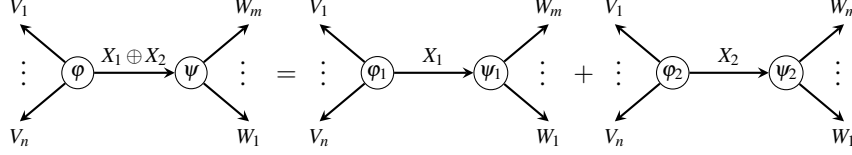

FIGURE 2. Linearity of $\langle \Gamma \rangle$. Here φ_1, φ_2 are compositions of φ with projector $X_1 \oplus X_2 \rightarrow X_1$ (respectively, $X_1 \oplus X_2 \rightarrow X_2$), and similarly for ψ_1, ψ_2 .

- (3) *Composition property:* if $D' \subset D$ is a subdisk such that $\partial D'$ does not contain vertices of Γ and meets edges of Γ transversally, then $\langle \Gamma \rangle_D$ will not change if we replace subgraph $\Gamma \cap D'$ by a single vertex colored by $\langle \Gamma \cap D' \rangle_D$.

The vector $\langle \Gamma \rangle$ is called the evaluation of Γ .

To define local relations between graphs, Kirillov defines the space of null graphs as follows. Let $D \subset M$ be an embedded disk, and let $\Gamma = c_1 \Gamma_1 + \dots + c_n \Gamma_n$ be a formal linear combination of colored graphs in M such that

- (1) Γ is transversal to ∂D (i.e., no vertices of Γ_i are on the boundary of D and edges of each Γ_i meet ∂D transversally).
- (2) All Γ_i coincide outside of D .
- (3) $\langle \Gamma \rangle_D = \sum c_i \langle \Gamma_i \cap D \rangle_D = 0$.

In this case Γ is called a null graph.

Definition 3.3. The representation space associated to a closed, oriented surface M by a spherical category \mathcal{A} is the vector space of formal linear combinations of \mathcal{A} -colored graph embeddings modulo the subspace spanned by the null graphs.

4. NO BOUNDARY CASE

Theorem 4.1. The image of any twisted Dijkgraaf-Witten representation of a mapping class group of an orientable, closed surface M is finite.

Proof. Let Γ be a Vec_G^0 -colored graph embedding, and let $g \geq 1$ be the genus of M (if $g = 0$, the mapping class group is trivial). Thinking of M as a quotient of its fundamental $4g$ -gon, by isotopy we may assume that the vertices of Γ lie in the interior of the polygon, none of the edges of Γ intersect the corners of the polygon, and that the edges of Γ only meet the sides of the polygon transversally. Evaluating on the interior of the polygon shows that Γ is equivalent to a graph with a single vertex whose edges are simple closed curves, each of which intersect the boundary of the polygon precisely once. By using the local relations, we can replace all the edges intersecting a side with a single edge labeled by the tensor product of their labels. If there are no edges intersecting a side, we can insert a single edge labeled by the group identity into Γ that intersects only that side. Thus, Γ is equivalent to a colored graph with one vertex v and edges e_1, \dots, e_{2g} corresponding to the standard generators of $\pi_1(M, v)$ as shown in Figure 3.

By the definition of the evaluation of a string-net and the definition of the quotient map identifying the sides of the fundamental polygon, the vertex v is colored by an element $\phi(v) \in \text{Hom}(1, \bigotimes_{i=1}^n V(e_{2i-1}) \otimes V(e_{2i}) \otimes V(e_{2i-1}^*) \otimes V(e_{2i}^*))$, where $V(e_i) \in \text{Obj}(\text{Vec}_G^0)$ is the coloring of the edge e_i . Since string-net evaluation is additive in the direct sum and linear in the vertex color, it follows that the representation space H is spanned by the set of colored graphs

$$S := \{\Gamma \in H : V(e_i) \in \text{Irr}(\text{Vec}_G^0), \phi(v) = 1\},$$

where $\text{Irr}(\text{Vec}_G^0)$ is the set of simple objects of Vec_G^0 , which correspond to the elements of G .

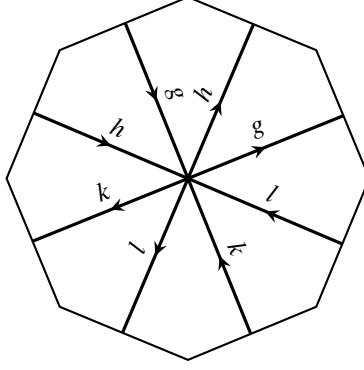

FIGURE 3. Element of the spanning set S for a genus 2 surface

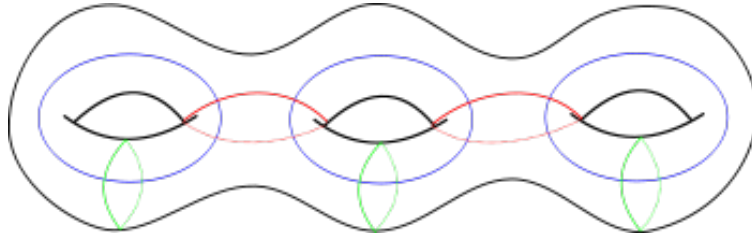

FIGURE 4. Lickorish generating set (Image source: https://en.wikipedia.org/wiki/Dehn_twist)

The mapping class group of M is generated by the Lickorish generating set consisting of Dehn twists around $3g - 1$ simple closed curves. These can be divided into two types of twists: the ones around a single hole (the blue and green curves in Figure 4), and the ones connecting two holes (the red curves).

Using the local moves as in Tables 1 and 2, one sees that the result of each of these Dehn twists lies in $\text{Im}(\omega)S$ since the structural morphisms of Vec_G^ω have coefficients in $\text{Im}(\omega)$. It is a basic result in group cohomology that, by replacing ω with a cohomologous cocycle if necessary, the image of ω lies in $\mu_{|G|}$, the set of $|G|$ -th roots of unity. Since cohomologous cocycles give rise to equivalent spherical categories Vec_G^ω , this replacement does not incur any loss in generality.

Thus, the image of any such mapping class group representation is a quotient of the group of permutations of the finite set $\mu_{|G|}S$, hence finite. \square

5. BOUNDARY CASE

When M has boundary, we define the mapping class group $\text{MCG}(M)$ to be the group of isotopy classes of homeomorphisms fixing the boundary of M setwise. There are mapping class group representations for every labelling of the boundary components $\pi_0(\partial M) \rightarrow \text{Obj}(Z(\text{Vec}_G^\omega))$. Given such a labelling, the representation space is spanned by colored graphs for which the coloring of a leg ending in a boundary component coincides with the image of the forgetful functor $F : Z(\text{Vec}_G^\omega) \rightarrow \text{Vec}_G^\omega$ on the labelling of that boundary component. The same local relations are valid in this representation space [8].

By a similar argument as in the proof of the Theorem 4.1, any such representation space has a spanning set S of colored graphs with a single vertex, loops for each of the usual generators of the fundamental group of M , and a leg from the vertex to each of the boundary components. Each of the edges is labeled by a simple object, i.e. an element of the group G .

Let N denote the closed surface obtained by filling in all the boundary components of M with disks. The mapping class group $\text{MCG}(M)$ is generated by the same Dehn twists as $\text{MCG}(N)$, as well as braids interchanging boundary components and mapping classes corresponding to dragging a boundary component along a representative of a standard generator of $\pi_1(N)$ [12]. It is straightforward to check that applying any of these generators of $\text{MCG}(M)$ to a

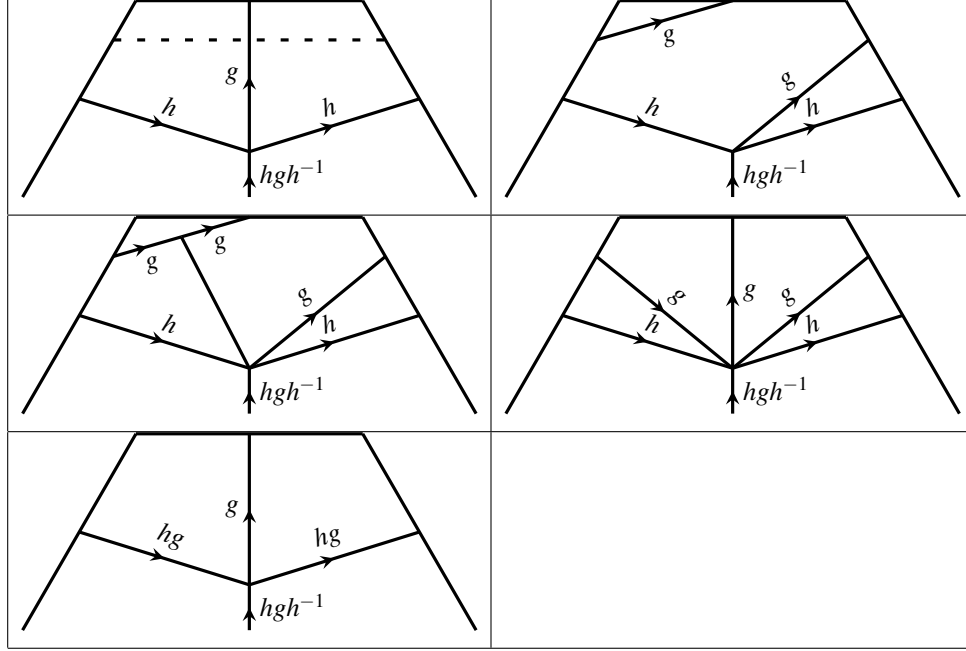

TABLE 1. First type of Dehn twist. Unlabeled interior edges are colored by the group identity element.

colored graph in S yields an element in $\text{Im}(\omega)S$ (see Tables 3 and 4). Since the braid group is also generated by such braids, we have the following theorem.

Theorem 5.1. *The image of any twisted Dijkgraaf-Witten representation of a mapping class group of an orientable, compact surface M is finite. In addition, any such braid group representation is also finite.*

6. FURTHER DIRECTIONS

We have proved that every twisted Dijkgraaf-Witten representation of a mapping class group of a compact, orientable surface has finite image. This is a generalization of the results of [4] and [6], as well as another step towards the (modified) Property F conjecture. A potential next step would be to consider more complicated spherical categories than Vec_ω^G . One candidate is the class of Tambara-Yamagami categories [13]. The main additional complication here is the appearance of multifusion channels, i.e. the tensor product of two simple objects can be a direct sum of multiple simple objects.

REFERENCES

- [1] V.G. Turaev and O.Y. Viro. State sum invariants of 3-manifolds and quantum 6j-symbols. *Topology*, 31(4):865 – 902, 1992.
- [2] John W. Barrett and Bruce W. Westbury. Invariants of piecewise-linear 3-manifolds. 1993.
- [3] Deepak Naidu and Eric C. Rowell. A finiteness property for braided fusion categories. 2009.
- [4] Pavel Etingof, Eric C. Rowell, and Sarah Witherspoon. Braid group representations from twisted quantum doubles of finite groups. *Pacific J. Math.* 234 no. 1 (2008) 33-42, 2007.
- [5] Robbert Dijkgraaf and Edward Witten. Topological gauge theories and group cohomology. *Comm. Math. Phys.*, 129(2):393–429, 1990.
- [6] Jens Fjelstad and Jürgen Fuchs. Mapping class group representations from Drinfeld doubles of finite groups, 2015.
- [7] V. Lyubashenko. Ribbon abelian categories as modular categories. *J. Knot Theory Ramifications*, 05(03):311–403, Jun 1996.
- [8] Alexander Kirillov. String-net model of Turaev-Viro invariants. 2011.
- [9] Peter Bantay. Algebraic aspects of orbifold models. 1993.
- [10] Siu-Hung Ng and Peter Schauenburg. Congruence subgroups and generalized Frobenius-Schur indicators. 2008.
- [11] Siu-Hung Ng and Peter Schauenburg. Frobenius-Schur indicators and exponents of spherical categories. *Adv. Math.* 211 (2007) no. 1, 34–71, 2005.
- [12] Joan S. Birman. Mapping class groups and their relationship to braid groups. *Communications on Pure and Applied Mathematics*, 22(2):213–238, 1969.
- [13] Daisuke Tambara and Shigeru Yamagami. Tensor categories with fusion rules of self-duality for finite abelian groups. *Journal of Algebra*, 209(2):692 – 707, 1998.

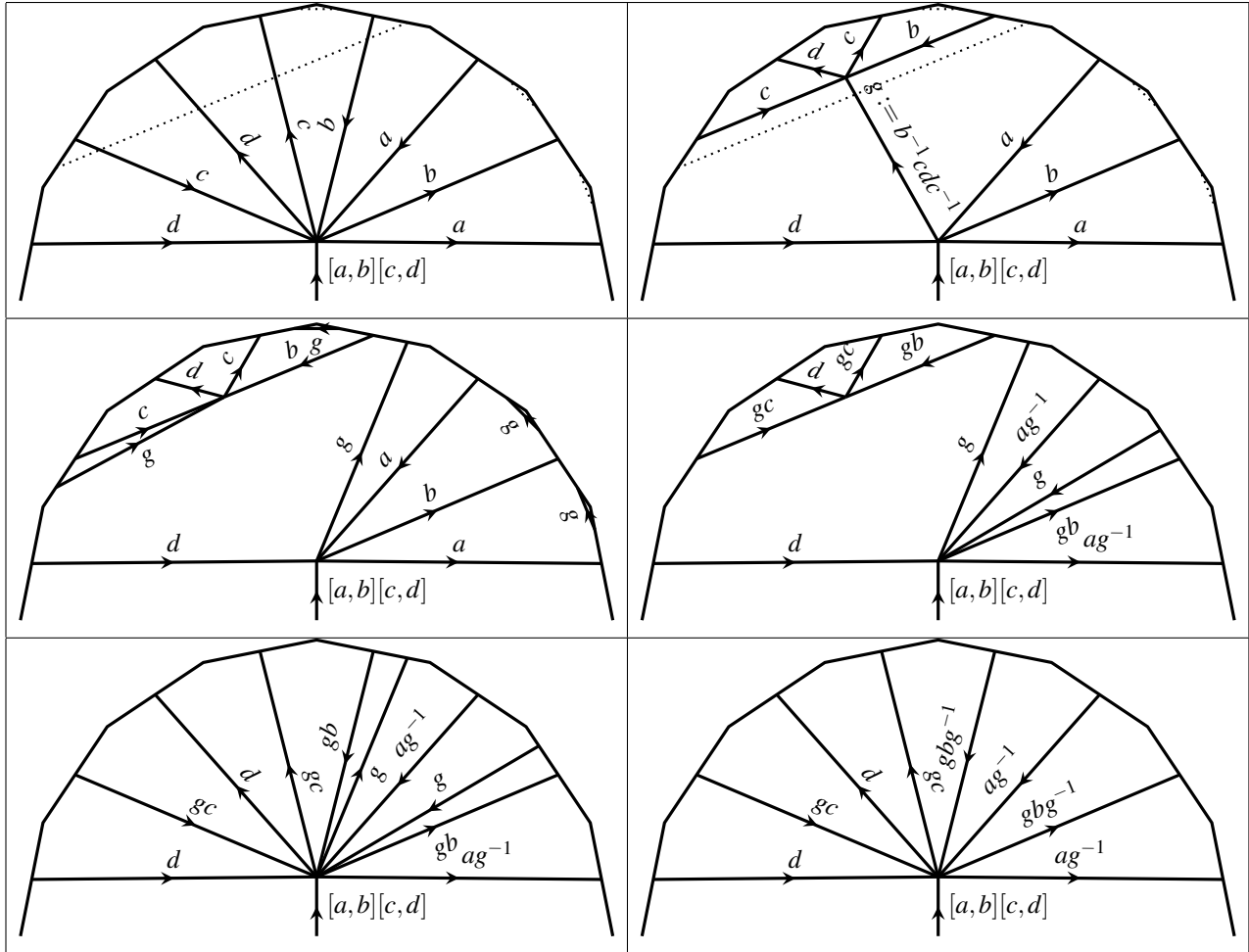

TABLE 2. Second type of Dehn twist.

E-mail address: pgustafs@math.tamu.edu

DEPARTMENT OF MATHEMATICS, TEXAS A&M UNIVERSITY, COLLEGE STATION, TX U.S.A.

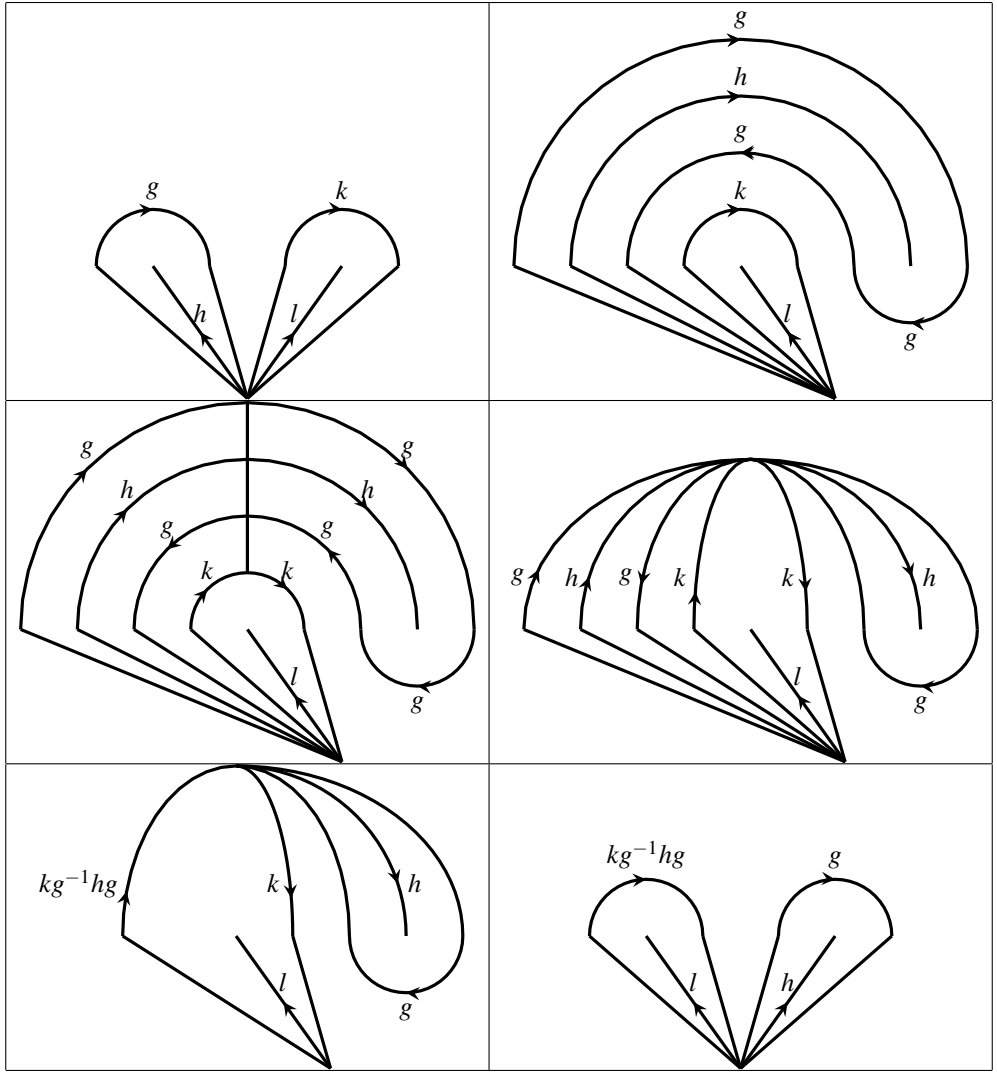

TABLE 3. A braid generator. Unlabeled interior edges are colored by the group identity element.

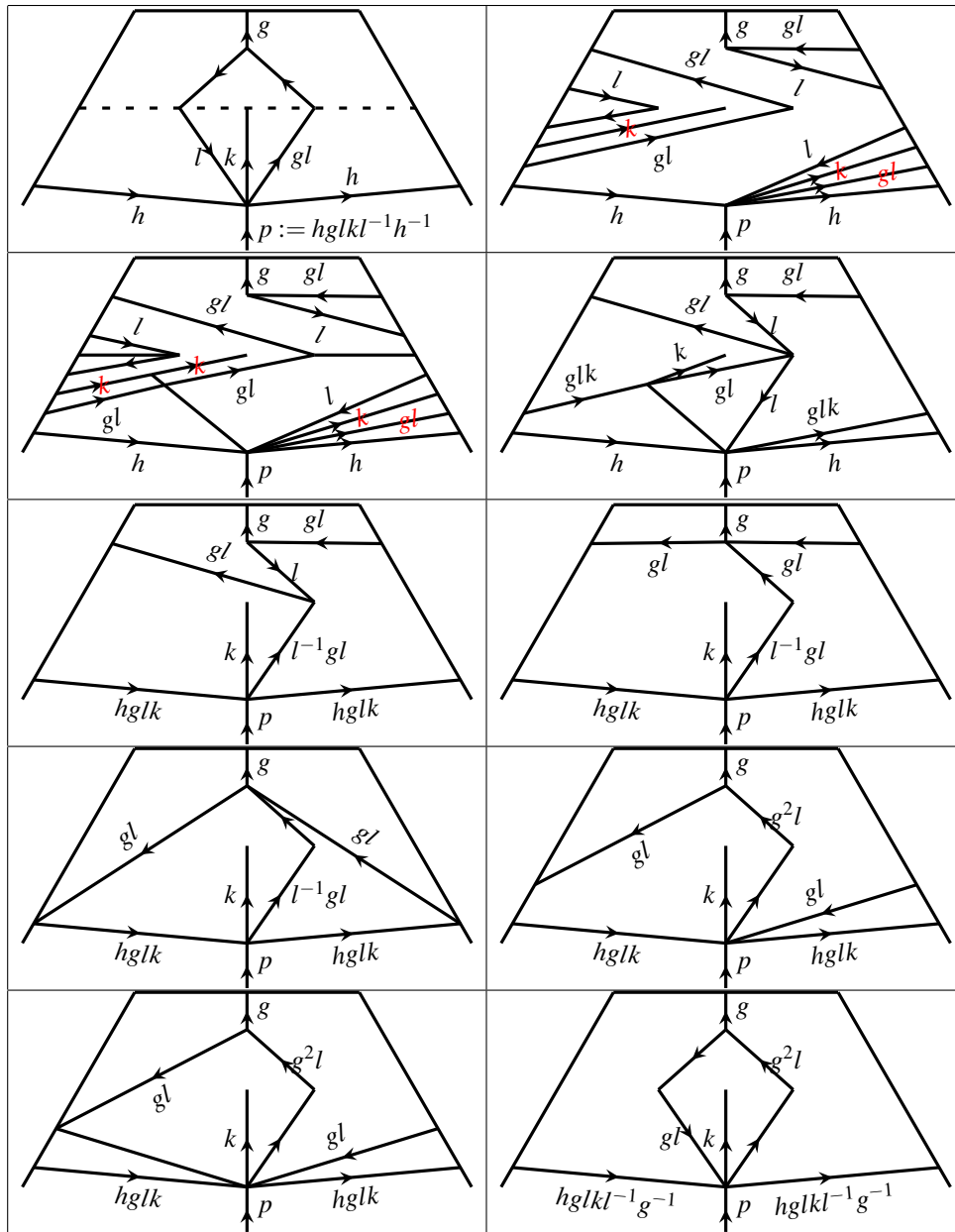

TABLE 4. Pulling a boundary component along a generator for the fundamental group of the corresponding closed surface. Unlabeled interior edges are colored by the group identity element.