

The Algebra of Open and Interconnected Systems



Brendan Fong
Hertford College
University of Oxford

A thesis submitted for the degree of
Doctor of Philosophy in Computer Science

Trinity 2016

For all those who have prepared food so I could eat and created homes so I could live over the past four years. You too have laboured to produce this; I hope I have done your labours justice.

Abstract

Herein we develop category-theoretic tools for understanding network-style diagrammatic languages. The archetypal network-style diagrammatic language is that of electric circuits; other examples include signal flow graphs, Markov processes, automata, Petri nets, chemical reaction networks, and so on. The key feature is that the language is comprised of a number of *components* with multiple (input/output) terminals, each possibly labelled with some type, that may then be connected together along these terminals to form a larger *network*. The components form hyperedges between labelled vertices, and so a diagram in this language forms a hypergraph. We formalise the compositional structure by introducing the notion of a hypergraph category. Network-style diagrammatic languages and their semantics thus form hypergraph categories, and semantic interpretation gives a hypergraph functor.

The first part of this thesis develops the theory of hypergraph categories. In particular, we introduce the tools of decorated cospans and corelations. Decorated cospans allow straightforward construction of hypergraph categories from diagrammatic languages: the inputs, outputs, and their composition are modelled by the cospans, while the ‘decorations’ specify the components themselves. Not all hypergraph categories can be constructed, however, through decorated cospans. Decorated corelations are a more powerful version that permits construction of all hypergraph categories and hypergraph functors. These are often useful for constructing the semantic categories of diagrammatic languages and functors from diagrams to the semantics. To illustrate these principles, the second part of this thesis details applications to linear time-invariant dynamical systems and passive linear networks.

Contents

Preface	v
I Mathematical Foundations	1
1 Hypergraph categories: the algebra of interconnection	2
1.1 The algebra of interconnection	2
1.2 Symmetric monoidal categories	5
1.2.1 Monoidal categories	6
1.2.2 String diagrams	7
1.2.3 Symmetry	9
1.3 Hypergraph categories	10
1.3.1 Frobenius monoids	10
1.3.2 Hypergraph categories	12
1.3.3 Hypergraph categories are self-dual compact closed	13
1.3.4 Coherence	15
1.4 Example: cospan categories	17
2 Decorated cospans: from closed systems to open	22
2.1 From closed systems to open	22
2.2 Decorated cospan categories	25
2.2.1 Composing decorated cospans	26
2.2.2 The hypergraph structure	30
2.2.3 A bicategory of decorated cospans	35
2.3 Functors between decorated cospan categories	35
2.4 Decorations in Set are general	40
2.5 Examples	43
2.5.1 Labelled graphs	43
2.5.2 Linear relations	44

2.5.3	Electrical circuits	45
3	Corelations: a tool for black boxing	48
3.1	The idea of black boxing	48
3.2	Corelations	52
3.2.1	Factorisation systems	53
3.2.2	Corelations	56
3.2.3	Categories of corelations	58
3.3	Functors between corelation categories	62
3.4	Examples	66
3.4.1	Equivalence relations as corelations in Set	67
3.4.2	Linear relations as corelations in Vect	68
4	Decorated corelations: black-boxed open systems	71
4.1	Black-boxed open systems	71
4.2	Decorated corelations	74
4.2.1	Adjoining right adjoints	75
4.2.2	Decorated corelations	76
4.2.3	Categories of decorated corelations	78
4.3	Functors between decorated corelation categories	80
4.4	All hypergraph categories are decorated corelation categories	84
4.4.1	Representing a morphism with its name	85
4.4.2	A categorical equivalence	89
4.4.3	Factorisations as decorations	91
4.5	Examples	95
4.5.1	Matrices	95
4.5.2	Two constructions for linear relations	97
II	Applications	99
5	Signal flow diagrams	100
5.1	Behavioural control theory	100
5.2	Linear time-invariant dynamical systems	106
5.3	Presentation of LTI	110
5.3.1	Syntax	110
5.3.2	Presentations of $\text{Mat } k[s, s^{-1}]$ and $\text{Cospan Mat } k[s, s^{-1}]$	111
5.3.3	Corelations in $\text{Mat } k[s, s^{-1}]$	114

5.3.4	Presentation of Corel Mat $k[s, s^{-1}]$	116
5.4	Operational semantics	119
5.5	Controllability	121
5.5.1	A categorical characterisation	122
5.5.2	Control and interconnection	124
5.5.3	Comparison to matrix methods	125
6	Passive linear networks	128
6.1	Introduction	129
6.2	Circuits of linear resistors	136
6.2.1	Circuits as labelled graphs	137
6.2.2	Ohm's law, Kirchhoff's laws, and the principle of minimum power	139
6.2.3	A Dirichlet problem	142
6.2.4	Equivalent circuits	145
6.2.5	Dirichlet forms	148
6.3	Inductors and capacitors	150
6.3.1	The frequency domain and Ohm's law revisited	151
6.3.2	The mechanical analogy	154
6.3.3	Generalized Dirichlet forms	155
6.3.4	A generalized minimizability result	157
6.4	A compositional perspective	160
6.4.1	The category of open circuits	161
6.4.2	An obstruction to black boxing	163
6.4.3	The category of Dirichlet cospans	165
6.4.4	A category of behaviours	168
6.5	Networks as Lagrangian relations	170
6.5.1	Symplectic vector spaces	170
6.5.2	Lagrangian subspaces from quadratic forms	173
6.5.3	Lagrangian relations	175
6.5.4	The symmetric monoidal category of Lagrangian relations	177
6.6	Ideal wires and corelations	178
6.6.1	Ideal wires as corelations	179
6.6.2	Potentials on corelations	180
6.6.3	Currents on corelations	182
6.6.4	The symplectification functor	183
6.6.5	Lagrangian relations as decorated corelations	186

6.7	The black box functor	189
6.7.1	Definition	189
6.7.2	Minimization via composition of relations	191
6.7.3	Proof of functoriality	192
7	Further directions	195
7.1	Bound colimits	195
7.2	Open circuits and other systems	198
	Bibliography	200

Preface

This is a thesis in the mathematical sciences, with emphasis on the mathematics. But before we get to the category theory, I want to say a few words about the scientific tradition in which this thesis is situated.

Mathematics is the language of science. Twinned so intimately with physics, over the past centuries mathematics has become a superb—indeed, unreasonably effective—language for understanding planets moving in space, particles in a vacuum, the structure of spacetime, and so on. Yet, while Wigner speaks of the unreasonable effectiveness of mathematics in the natural sciences [Wig60], equally eminent mathematicians, not least Gelfand, speak of the unreasonable *ineffectiveness* of mathematics in biology [Mon07] and related fields. Why such a difference?

A contrast between physics and biology is that while physical systems can often be studied in isolation—the proverbial particle in a vacuum—, biological systems are necessarily situated in their environment. A heart belongs in a body, an ant in a colony. One of the first to draw attention to this contrast was Ludwig von Bertalanffy, biologist and founder of general systems theory, who articulated the difference as one between closed and open systems:

Conventional physics deals only with closed systems, i.e. systems which are considered to be isolated from their environment. . . . However, we find systems which by their very nature and definition are not closed systems. Every living organism is essentially an open system. It maintains itself in a continuous inflow and outflow, a building up and breaking down of components, never being, so long as it is alive, in a state of chemical and thermodynamic equilibrium but maintained in a so-called steady state which is distinct from the latter [Ber68].

While the ambitious generality of general systems theory has proved difficult, von Bertalanffy's philosophy has had great impact in his home field of biology, leading to the modern field of systems biology. Half a century later, Dennis Noble, another

great pioneer of systems biology and the originator of the first mathematical model of a working heart, describes the shift as one from reduction to integration.

Systems biology... is about putting together rather than taking apart, integration rather than reduction. It requires that we develop ways of thinking about integration that are as rigorous as our reductionist programmes, but different [Nob06].

In this thesis we develop rigorous ways of thinking about integration or, as we refer to it, interconnection.

Interconnection and openness are tightly related. Indeed, openness implies that a system may be interconnected with its environment. But what is an environment but comprised of other systems? Thus the study of open systems becomes the study of how a system changes under interconnection with other systems.

To model this, we must begin by creating language to describe the interconnection of systems. While reductionism hopes that phenomena can be explained by reducing them to “elementary units investigable independently of each other” [Ber68], this philosophy of integration introduces as an additional and equal priority the investigation of the way these units are interconnected. As such, this thesis is predicated on the hope that the meaning of an expression in our new language is determined by the meanings of its constituent expressions together with the syntactic rules combining them. This is known as the principle of compositionality.

Also commonly known as Frege’s principle, the principle of compositionality both dates back to Ancient Greek and Vedic philosophy, and is still the subject of active research today [Jan86, Sza13]. More recently, through the work of Montague [Mon70] in natural language semantics and Strachey and Scott [SS71] in programming language semantics, the principle of compositionality has found formal expression as the dictum that the interpretation of a language should be given by a homomorphism between an algebra of syntactic representations and an algebra of semantic objects. We too shall follow this route.

The question then arises: what do we mean by algebra? This mathematical question leads us back to our scientific objectives: what do we mean by system? Here we must narrow, or at least define, our scope. We give some examples. The investigations of this thesis began with electrical circuits and their diagrams, and we will devote significant time to exploring their compositional formulation. We discussed biological systems above, and our notion of system includes these, modelled say in the form of chemical reaction networks or Markov processes, or the compartmental

models of epidemiology, population biology, and ecology. From computer science, we consider Petri nets, automata, logic circuits, and similar. More abstractly, our notion of system encompasses matrices and systems of differential equations.

Drawing together these notions of system are well-developed diagrammatic representations based on network diagrams—that is, topological graphs. We call these network-style diagrammatic languages. In the abstract, by system we shall simply mean that which can be represented by a box with a collection of terminals, perhaps of different types, through which it interfaces with the surroundings. Concretely, one might envision a circuit diagram with terminals, such as

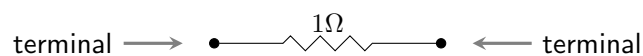

or

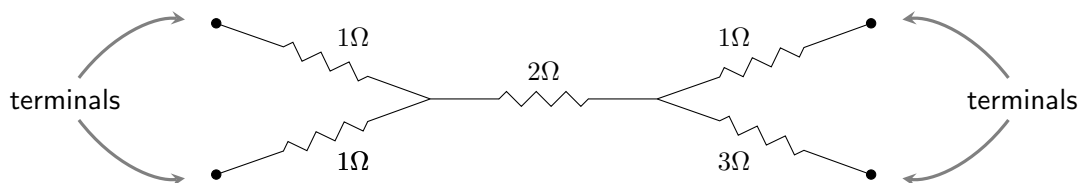

The algebraic structure of interconnection is then simply the structure that results from the ability to connect terminals of one system with terminals of another. This graphical approach motivates our language of interconnection: indeed, these diagrams will be the expressions of our language.

We claim that the existence of a network-style diagrammatic language to represent a system implies that interconnection is inherently important in understanding the system. Yet, while each of these example notions of system are well-studied in and of themselves, their compositional, or algebraic, structure has received scant attention. In this thesis, we study an algebraic structure called a hypergraph category, and argue that this is the relevant algebraic structure for modelling interconnection of open systems.

Given these pre-existing diagrammatic formalisms and our visual intuition, constructing algebras of syntactic representations is thus rather straightforward. The semantics and their algebraic structure are more subtle.

In some sense our semantics is already given to us too: in studying these systems as closed systems, scientists have already formalised the meaning of these diagrams. But we have shifted from a closed perspective to an open one, and we need our semantics to also account for points of interconnection.

Taking inspiration from Willems’ behavioural approach [Wil07] and Deutsch’s constructor theory [Deu13], in this thesis I advocate the following position. First, at each terminal of an open system we may make measurements appropriate to the type of terminal. Given a collection of terminals, the *universum* is then the set of all possible measurement outcomes. Each open system has a collection of terminals, and hence a universum. The semantics of an open system is the subset of measurement outcomes on the terminals that are permitted by the system. This is known as the *behaviour* of the system.

For example, consider a resistor of resistance r . This has two terminals—the two ends of the resistor—and at each terminal, we may measure the potential and the current. Thus the universum of this system is the set $\mathbb{R} \oplus \mathbb{R} \oplus \mathbb{R} \oplus \mathbb{R}$, where the summands represent respectively the potentials and currents at each of the two terminals. The resistor is governed by Kirchhoff’s current law, or conservation of charge, and Ohm’s law. Conservation of charge states that the current flowing into one terminal must equal the current flowing out of the other terminal, while Ohm’s law states that this current will be proportional to the potential difference, with constant of proportionality $1/r$. Thus the behaviour of the resistor is the set

$$\left\{ (\phi_1, \phi_2, -\frac{1}{r}(\phi_2 - \phi_1), \frac{1}{r}(\phi_2 - \phi_1)) \mid \phi_1, \phi_2 \in \mathbb{R} \right\}.$$

Note that in this perspective a law such as Ohm’s law is a mechanism for partitioning *behaviours* into possible and impossible behaviours.¹

Interconnection of terminals then asserts the identification of the variables at the identified terminals. Fixing some notion of open system and subsequently an algebra of syntactic representations for these systems, our approach, based on the principle of compositionality, requires this to define an algebra of semantic objects and a homomorphism from syntax to semantics. The first part of this thesis develops the mathematical tools necessary to pursue this vision for modelling open systems and their interconnection.

The next goal is to demonstrate the efficacy of this philosophy in applications. At core, this work is done in the faith that the right language allows deeper insight into the underlying structure. Indeed, after setting up such a language for open systems there are many questions to be asked: Can we find a sound and complete logic for determining when two syntactic expressions have the same semantics? Suppose we

¹That is, given a universum \mathcal{U} of trajectories, a behaviour of a system is an element of the power set $\mathcal{P}(\mathcal{U})$ representing all possible measurements of this system, and a law or principle is an element of $\mathcal{P}(\mathcal{P}(\mathcal{U}))$ representing all possible behaviours of a class of systems.

have systems that have some property, for example controllability. In what ways can we interconnect controllable systems so that the combined system is also controllable? Can we compute the semantics of a large system quicker by computing the semantics of subsystems and then composing them? If I want a given system to achieve a specified trajectory, can we interconnect another system to make it do so? How do two different notions of system, such as circuit diagrams and signal flow graphs, relate to each other? Can we find homomorphisms between their syntactic and semantic algebras? In the second part of this thesis we explore some applications in depth, providing answers to questions of the above sort.

Outline of this thesis

This thesis is divided into two parts. Part I, comprising Chapters 1 to 4, focusses on mathematical foundations. In it we develop the theory of hypergraph categories and a powerful tool for constructing and manipulating them: decorated corelations. Part II, comprising Chapters 5 to 7, then discusses applications of this theory to examples of open systems.

The central refrain of this thesis is that the syntax and semantics of network-style diagrammatic languages can be modelled by hypergraph categories. These are introduced in Chapter 1. Hypergraph categories are symmetric monoidal categories in which every object is equipped with the structure of a special commutative Frobenius monoid in a way compatible with the monoidal product. As we will rely heavily on properties of monoidal categories, their functors, and their graphical calculus, we begin with a whirlwind review of these ideas. We then provide a definition of hypergraph categories and their functors, a strictification theorem, and an important example: the category of cospans in a category with finite colimits.

Cospans are pairs of morphisms $X \rightarrow N \leftarrow Y$ with a common codomain. In Chapter 2 we introduce the idea of a decorated cospan, which equips the apex N with extra structure. Our motivating example is cospans of finite sets decorated by graphs, as in the picture

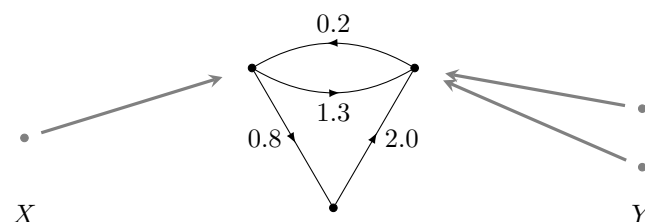

Here graphs are a proxy for expressions in a network-style diagrammatic language. To give a bit more formal detail, let \mathcal{C} be a category with finite colimits, writing its coproduct $+$, and let (\mathcal{D}, \otimes) be a braided monoidal category. Decorated cospans provide a method of producing a hypergraph category from a lax braided monoidal functor $F: (\mathcal{C}, +) \rightarrow (\mathcal{D}, \otimes)$. The objects of these categories are simply the objects of \mathcal{C} , while the morphisms are pairs comprising a cospan $X \rightarrow N \leftarrow Y$ in \mathcal{C} together with an element $I \rightarrow FN$ in \mathcal{D} —the so-called decoration. We will also describe how to construct hypergraph functors between decorated cospan categories. In particular, this provides a useful tool for constructing a hypergraph category that captures the syntax of a network-style diagrammatic language.

Having developed a method to construct a category where the morphisms are expressions in a diagrammatic language, we turn our attention to categories of semantics. This leads us to the notion of a corelation, to which we devote Chapter 3. Given a factorisation system $(\mathcal{E}, \mathcal{M})$ on a category \mathcal{C} , we define a corelation to be a cospan $X \rightarrow N \leftarrow Y$ such that the copairing of the two maps, a map $X + Y \rightarrow N$, is a morphism in \mathcal{E} . Factorising maps $X + Y \rightarrow N$ using the factorisation system leads to a notion of equivalence on cospans, and this helps us describe when two diagrams are equivalent. Like cospans, corelations form hypergraph categories.

In Chapter 4 we decorate corelations. Like decorated cospans, decorated corelations are corelations together with some additional structure on the apex. We again use a lax braided monoidal functor to specify the sorts of extra structure allowed. Moreover, decorated corelations too form the morphisms of a hypergraph category. The culmination of our theoretical work is to show that every hypergraph category and every hypergraph functor can be constructed using decorated corelations. This implies that we can use decorated corelations to construct a semantic hypergraph category for any network-style diagrammatic language, as well as a hypergraph functor from its syntactic category that interprets each diagram. We also discuss how the intuitions behind decorated corelations guide construction of these categories and functors.

Having developed these theoretical tools, in the second part we turn to demonstrating that they have useful application. Chapter 5 uses corelations to formalise signal flow diagrams representing linear time-invariant discrete dynamical systems as morphisms in a category. Our main result gives an intuitive sound and fully complete equational theory for reasoning about these linear time-invariant systems. Using this framework, we derive a novel structural characterisation of controllability, and

consequently provide a methodology for analysing controllability of networked and interconnected systems.

Chapter 6 studies passive linear networks. Passive linear networks are used in a wide variety of engineering applications, but the best studied are electrical circuits made of resistors, inductors and capacitors. The goal is to construct what we call the black box functor, a hypergraph functor from a category of open circuit diagrams to a category of behaviours of circuits. We construct the former as a decorated cospan category, with each morphism a cospan of finite sets decorated by a circuit diagram on the apex. In this category, composition describes the process of attaching the outputs of one circuit to the inputs of another. The behaviour of a circuit is the relation it imposes between currents and potentials at their terminals. The space of these currents and potentials naturally has the structure of a symplectic vector space, and the relation imposed by a circuit is a Lagrangian linear relation. Thus, the black box functor goes from our category of circuits to the category of symplectic vector spaces and Lagrangian linear relations. Decorated corelations provide a critical tool for constructing these hypergraph categories and the black box functor.

Finally, in Chapter 7 we mention two further research directions. The first is the idea of a bound colimit, which aims to describe why epi-mono factorisation systems are useful for constructing corelation categories of semantics for open systems. The second research direction pertains to applications of the black box functor for passive linear networks, discussing the work of Jekel on the inverse problem for electric circuits [Jek] and the work of Baez, Fong, and Pollard on open Markov processes [BFP16, Pol16].

Related work

The work here is underpinned not just by philosophical precedent, but by a rich tradition in mathematics, physics, and computer science. Here we make some remarks on work on our broad theme of categorical network theory; more specific references are included in each chapter.

With its emphasis on composition, category theory is an attractive framework for modelling open systems, and the present work is not the first attempt at develop this idea. Notably from as early as the 1960s Goguen and Rosen both led efforts, Goguen from a computer science perspective [Gog75], Rosen from biology [Ros12]. Goguen in particular promoted the idea, which we take up, that composition of systems should be modelled by colimits [Gog91]. This manifests in our emphasis on cospans.

Indeed, cospans are well known as a formalism for making entities with an arbitrarily designated ‘input end’ and ‘output end’ into the morphisms of a category. This

has roots in topological quantum field theory, where a particular type of cospan known as a ‘cobordism’ is used to describe pieces of spacetime [BL11, BS11]. The general idea of using functors to associate algebraic semantics to topological diagrams has also long been a technique associated with topological quantum field theory, dating back to [Ati88].

Developed around the same time, the work of Joyal and Street showing the tight connection between string diagrams and monoidal categories [JS91, JS93] is also a critical aspect of the work here. This rigorous link inspires our use of hypergraph categories—a type of monoidal category—in modelling network-style diagrammatic languages.

The work of Walters, Sabadini, and collaborators also makes use of cospans to model interconnection of systems, including electric circuits, as well as automata, Petri nets, transition systems, and Markov processes [KSW97, KSW00, RSW05, RSW08, ASW11]. Indeed, the definition of a hypergraph category is due to Walters and Carboni [Car91]. A difference and original contribution is our present use of decorations. One paper deserving of particular mention is that of Rosebrugh, Sabadini, and Walters on calculating colimits compositionally [RSW08], which develops the beginnings of some of the present ideas on corelations. Their discussion of automata and the proof of Kleene’s theorem is reminiscent of our proof of the functoriality of the black box functor, and the precise relationship deserves to be pinned down.

This link between automata and control systems, however, is not novel: Arbib was the first to lay out this vision [Arb65]. In fact, the categorical approach to this task has been central from the beginning. Following Goguen [Gog72], Arbib and Manes unified state-space based control theory and automata theory in their study of machines in a category, showing that examples including sequential machines, linear machines, stochastic automata, and tree automata and their theories of reachability, observability, and realisation all fall under the same general categorical framework [AM74a, AM74b, AM80].

For the most part, however, the above work starts with categories in which the systems are objects, whereas here our systems are morphisms. The idea that systems or processes should be modelled by morphisms in a category, with the objects becoming interface specifications and composition interaction of processes, has roots in Abramsky’s work on interaction categories [Abr93, Abr94, AGN95]. Like those here, interaction categories are symmetric monoidal categories, with the diagrams

providing an intuitive language for composition of systems. The tight link between this work and spans has also been evident from the beginning [CS94].

More broadly, the work of this thesis, talking as it does of semantics for diagrams of interacting systems, and particularly semantics in terms of relations, is couched in the language of concurrency theory and process algebra [Bae05]. This stems from the 1980s, with Milner’s calculus of communicating systems [Mil80] and Hoare’s communicating sequential processes [Hoa78].

At the present time, the work of Bonchi, Sobocínski, and Zanasi on signal flow diagrams and graphical linear algebra [BSZ14, BSZ16, BSZ15, Zan15] has heavily influenced the work here. Indeed, Chapter 5 is built upon the foundation they created.

Spivak and collaborators use operads to study networked systems diagrammatically. Although a more general framework, capable of studying diagrammatic languages with more flexible syntax than that of hypergraph categories, Spivak studies an operad of so-called wiring diagrams built from cospans of labelled finite sets in a number of papers, including [VSL15, Spi, SSR].

Finally, this thesis fits into the categorical network theory programme led by Baez, together with Erbele, Pollard, Courser and others. In particular, the papers [BE15, Erb16, BFP16, Pol16, Cou] on signal flow diagrams, open Markov processes, and decorated cospans have been developed alongside and influenced the work here.

Statement of work

The Examination Schools make the following request:

Where some part of the thesis is not solely the work of the candidate or has been carried out in collaboration with one or more persons, the candidate shall submit a clear statement of the extent of his or her own contribution.

I address this now.

The first four chapters, on hypergraph categories and decorated corelations, are my own work. (Chapter 2 has been previously published as [Fon15].) The applications chapters were developed with collaborators.

Chapter 5 arises from a weekly seminar with Paolo Rapisarda and Paweł Sobocínski at Southampton in the Spring of 2015. The text is a minor adaptation of that in the paper [FRS16]. For that paper I developed the corelation formalism, providing a first draft. Paweł provided much expertise in signal flow graphs, significantly revising the text and contributing the section on operational semantics. Paolo contributed

comparisons to classical methods in control theory. A number of anonymous referees contributed helpful and detailed comments.

Chapter 6 is joint work with John Baez; the majority of the text is taken from our paper [BF]. For that paper John supplied writing on Dirichlet forms and the principle of minimum power that became the second section of Chapter 6, as well as parts of the next two sections. I produced a first draft of the rest of the paper. We collaboratively revised the text for publication.

Acknowledgements

This work could not have been completed alone, and I am grateful for the assistance of so many people, indeed far more than I list here. Foremost deserving of mention are my supervisors John Baez, Bob Coecke, and Rob Ghrist. John’s influence on this work cannot be understated; he has been tireless in patiently explaining new mathematics to me, in sharing his vision for this great project, and in supporting, reading, promoting, and encouraging my work. Bob is the reason I started this work in the first place, and with Rob they have both provided fantastic research environments, a generous amount of freedom to pursue my passions and, most importantly, encouragement and faith.

Jamie Vicary, too, has always been available for advice and encouragement. My coauthors, including John, but also Brandon Coya, Hugo Nava-Kopp, Blake Pollard, Paolo Rapisarda, Paweł Sobociński, have been teachers in the process. And valuable comments and conversations on the present work have come, not only from all of the above, but also from Samson Abramsky, Marcelo Fiore, Sam Staton, Bernhard Reinke, Dan Marsden, Rashmi Kumar, Aleks Kissinger, Stefano Gogioso, Jason Erbele, Omar Camarena, and a number of anonymous referees.

I am grateful for the generous support of a number of institutions. This work was supported by the Clarendon Fund, Hertford College, and the Queen Elizabeth Scholarships, Oxford, and completed at the University of Oxford, the Centre for Quantum Technologies, Singapore, and the University of Pennsylvania.

Finally, I thank my partner, Stephanie, and my family—Mum, Dad, Justin, Calvin, Tania—for their love and patience.

Part I

Mathematical Foundations

Chapter 1

Hypergraph categories: the algebra of interconnection

In this chapter we introduce hypergraph categories, giving a definition, coherence theorem, graphical language, and examples.

The first section, §1.1, motivates hypergraph categories as a structure that captures interconnection in network-style diagrammatic languages. In §1.2, we then provide a rapid introduction to symmetric monoidal categories, with emphasis on their graphical calculus and how this can be used to model diagrams in a network-style diagrammatic language. This leads to the introduction of hypergraph categories in §1.3, where we also prove that every hypergraph category is equivalent, as a hypergraph category, to a strict hypergraph category. We then conclude this chapter with an exploration of a fundamental example of hypergraph categories: categories of cospans (§1.4).

We assume basic familiarity with category theory and symmetric monoidal categories; although we give a sparse overview of the latter for reference. A proper introduction to both can be found in Mac Lane [Mac98].

1.1 The algebra of interconnection

Our aim is to algebraicise network diagrams. A network diagram is built from pieces like so:

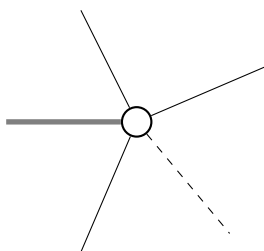

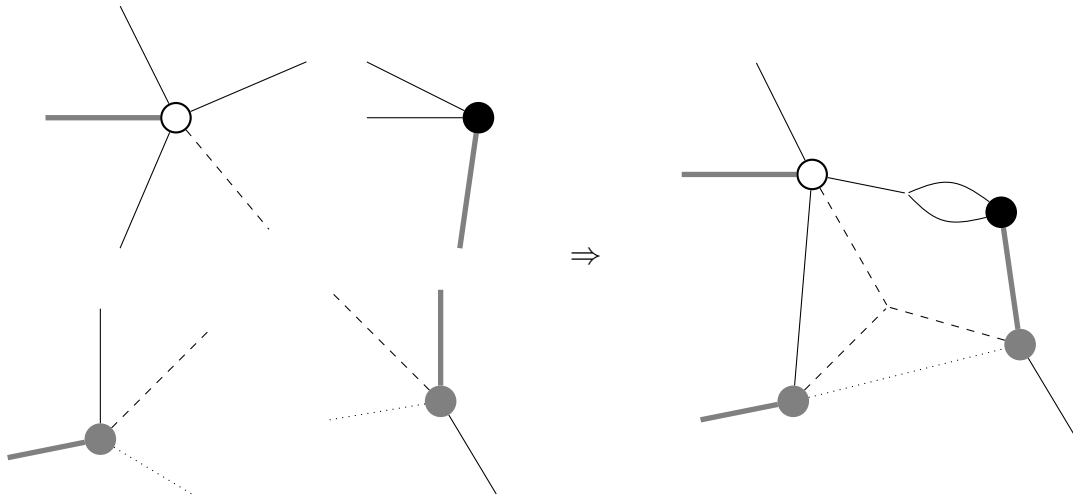

Figure 1.1: Interconnection of network diagrams. Note that we only connect terminals of the same type, but we can connect as many as we like.

These represent open systems, concrete or abstract; for example a resistor, a chemical reaction, or a linear transformation. The essential feature, for openness and for networking, is that the system may have terminals, perhaps of different types, each one depicted by a line radiating from the central body. In the case of a resistor each terminal might represent a wire, for chemical reactions a chemical species, for linear transformations a variable in the domain or codomain. Network diagrams are formed by connecting terminals of systems to build larger systems.

A network-style diagrammatic language is a collection of network diagrams together with the stipulation that if we take some of these network diagrams, and connect terminals of the same type in any way we like, then we form another diagram in the collection. The point of this chapter is that hypergraph categories provide a precise formalisation of network-style diagrammatic languages.

In jargon, a hypergraph category is a symmetric monoidal category in which every object is equipped with a special commutative Frobenius monoid in a way compatible with the monoidal product. We will walk through these terms in detail, illustrating them with examples and a few theorems.

The key data comprising a hypergraph category are its objects, morphisms, composition rule, monoidal product, and Frobenius maps. Each of these model a feature of network diagrams and their interconnection. The objects model the terminal types, while the morphisms model the network diagrams themselves. The composition, monoidal product, and Frobenius maps model different aspects of intercon-

Networks	Hypergraph categories
list of terminal types	object
network diagram	morphism
series connection	composition
juxtaposition	monoidal product
branching	Frobenius maps

Figure 1.2: Corresponding features of networks and hypergraph categories.

nection: composition models the interconnection of two terminals of the same type, the monoidal product models the network formed by taking two networks without interconnecting any terminals, while the Frobenius maps model multi-terminal interconnection.

These Frobenius maps are the distinguishing feature of hypergraph categories as compared to other structured monoidal categories, and are crucial for formalising the intuitive concept of network languages detailed above. In the case of electric circuits the Frobenius maps model the ‘branching’ of wires; in the case when diagrams simply model an abstract system of equations and terminals variables in these equations, the Frobenius maps allow variables to be shared between many systems of equations.

Examining these correspondences, it is worthwhile to ask whether hypergraph categories permit too much structure to be specified, given that interconnection is now divided into three different aspects—composition, monoidal product, and Frobenius maps—, and features such as domains and codomains of network diagrams, rather than just a collection of terminals, exist. The answer is given by examining the additional coherence laws that these data must obey. For example, in the case of the domain and codomain, we shall see that hypergraph categories are all compact closed categories, and so there is ultimately only a formal distinction between domain and codomain objects. One way to think of these data is as scaffolding. We could compare it to the use of matrices and bases to provide language for talking about linear transformations and vector spaces. They are not part of the target structure, but nonetheless useful paraphenalia for constructing it.

Network languages are not only syntactic entities: as befitting the descriptor ‘language’, they typically have some associated semantics. Circuit diagrams, for instance, not only depict wire circuits that may be constructed, they also represent the electrical

behaviour of that circuit. Such semantics considers the circuits

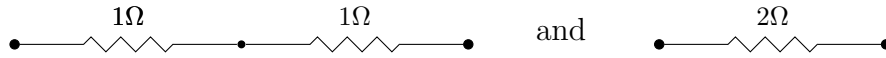

the same, even though as ‘syntactic’ diagrams they are distinct. A cornerstone of the utility of the hypergraph formalism is the ability to also realise the semantics of these diagrams as morphisms of another hypergraph category. This ‘semantic’ hypergraph category, as a hypergraph category, still permits the rich ‘networking’ interconnection structure, and a so-called hypergraph functor implies that the syntactic category provides a sound framework for depicting these morphisms. Network languages syntactically are often ‘free’ hypergraph categories, and much of the interesting structure lies in their functors to their semantic hypergraph categories.

1.2 Symmetric monoidal categories

Suppose we have some tiles with inputs and outputs of various types like so:

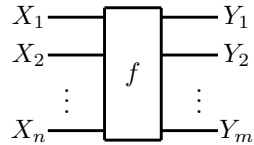

These tiles may vary in height and width. We can place these tiles above and below each other, and to the left and right, so long as the inputs on the right tile match the outputs on the left. Suppose also that some arrangements of tiles are equal to other arrangements of tiles. How do we formalise this structure algebraically? The theory of monoidal categories provides an answer.

This is of relevance to us as hypergraph categories are first monoidal categories, indeed symmetric monoidal categories. Monoidal categories are categories with two notions of composition: ordinary categorical composition and monoidal composition, with the monoidal composition only associative and unital up to natural isomorphism. They are the algebra of processes that may occur simultaneously as well as sequentially. First defined by Bénabou and Mac Lane in the 1960s [Ben63, Mac63b], their theory and their links with graphical representation are well explored [JS91, Sel11]. We bootstrap on this, using monoidal categories to define hypergraph categories, and so immediately arriving at an understanding of how hypergraph categories formalise our network languages.

Moreover, symmetric monoidal functors play a key role in our framework for defining and working with hypergraph categories: decorated cospans and corelations.

We thus use the next section to provide, for quick reference, a definition of symmetric monoidal categories.

1.2.1 Monoidal categories

A **monoidal category** (\mathcal{C}, \otimes) consists of a category \mathcal{C} , a functor $\otimes : \mathcal{C} \times \mathcal{C} \rightarrow \mathcal{C}$, a distinguished object I , and natural isomorphisms $\alpha_{A,B,C} : (A \otimes B) \otimes C \rightarrow A \otimes (B \otimes C)$, $\rho_A : A \otimes I \rightarrow A$, and $\lambda_A : I \otimes A \rightarrow A$ such that for all A, B, C, D in \mathcal{C} the following two diagrams commute:

$$\begin{array}{ccc} ((A \otimes B) \otimes C) \otimes D & \xrightarrow{\alpha_{(A \otimes B), C, D}} & (A \otimes B) \otimes (C \otimes D) \\ \alpha_{A, B, C} \otimes \text{id}_D \downarrow & & \downarrow \alpha_{A, B, (C \otimes D)} \\ (A \otimes (B \otimes C)) \otimes D & \xrightarrow{\alpha_{A, (B \otimes C), D}} A \otimes ((B \otimes C) \otimes D) \xrightarrow{\text{id}_A \otimes \alpha_{B, C, D}} & A \otimes (B \otimes (C \otimes D)) \end{array}$$

$$\begin{array}{ccc} (A \otimes I) \otimes B & \xrightarrow{\alpha_{A, I, B}} & A \otimes (I \otimes B) \\ \rho_A \otimes \text{id}_B \searrow & & \swarrow \text{id}_A \otimes \lambda_B \\ & A \otimes B & \end{array}$$

We call \otimes the **monoidal product**, I the **monoidal unit**, α the **associator**, ρ and λ the **right** and **left unitor** respectively. The associator and unitors are known collectively as the **coherence maps**.

By Mac Lane's coherence theorem, these two axioms are equivalent to requiring that 'all formal diagrams'—that is, all diagrams in which the morphism are built from identity morphisms and the coherence maps using composition and the monoidal product—commute. Consequently, between any two products of the same ordered list of objects up to instances of the monoidal unit, such as $((A \otimes I) \otimes B) \otimes C$ and $A \otimes ((B \otimes C) \otimes (I \otimes I))$, there is a unique so-called **canonical** map. See Mac Lane [Mac98, Corollary of Theorem VII.2.1] for a precise statement and proof.

A **lax monoidal functor** $(F, \varphi) : (\mathcal{C}, \otimes) \rightarrow (\mathcal{C}', \boxtimes)$ between monoidal categories consists of a functor $F : \mathcal{C} \rightarrow \mathcal{C}'$, and natural transformations $\varphi_{A,B} : FA \boxtimes FB \rightarrow F(A \otimes B)$ and $\varphi_I : I' \rightarrow FI$, such that for all $A, B, C \in \mathcal{C}$ the three diagrams

$$\begin{array}{ccc} (FA \otimes FB) \otimes FC & \xrightarrow{\varphi_{A, B} \otimes \text{id}_{FC}} F(A \otimes B) \otimes FC & \xrightarrow{\varphi_{A \otimes B, C}} F((A \otimes B) \otimes C) \\ \alpha_{FA, FB, FC} \downarrow & & \downarrow F\alpha_{A, B, C} \\ FA \otimes (FB \otimes FC) & \xrightarrow{\text{id}_{FA} \otimes \varphi_{B, C}} FA \otimes F(B \otimes C) & \xrightarrow{\varphi_{A, B \otimes C}} F(A \otimes (B \otimes C)) \end{array}$$

$$\begin{array}{ccc}
F(A) \otimes I' & \xrightarrow{\rho} & F(A) \\
\text{id} \otimes \varphi_I \downarrow & & \uparrow F\rho \\
F(A) \otimes F(I) & \xrightarrow{\varphi_{A,I}} & F(A \otimes I)
\end{array}
\qquad
\begin{array}{ccc}
I' \otimes F(A) & \xrightarrow{\lambda} & F(A) \\
\varphi_I \otimes \text{id} \downarrow & & \uparrow F\lambda \\
F(I) \otimes F(A) & \xrightarrow{\varphi_{I,A}} & F(I \otimes A)
\end{array}$$

commute. We further say a monoidal functor is a **strong monoidal functor** if the φ are isomorphisms, and a **strict monoidal functor** if the φ are identities.

A **monoidal natural transformation** $\theta : (F, \varphi) \Rightarrow (G, \gamma)$ between two monoidal functors F and G is a natural transformation $\theta : F \Rightarrow G$ such that

$$\begin{array}{ccc}
FI & \xrightarrow{\theta_I} & GI \\
\varphi_I \swarrow & & \searrow \gamma_I \\
& I' &
\end{array}
\quad \text{and} \quad
\begin{array}{ccc}
FA \boxtimes FB & \xrightarrow{\theta_A \otimes \theta_B} & GA \boxtimes GB \\
\varphi_{A,B} \downarrow & & \downarrow \gamma_{A,B} \\
F(A \otimes B) & \xrightarrow{\theta_{A \otimes B}} & G(A \otimes B)
\end{array}$$

commute for all objects A, B .

Two monoidal categories \mathcal{C}, \mathcal{D} are **monoidally equivalent** if there exist strong monoidal functors $F: \mathcal{C} \rightarrow \mathcal{D}$ and $G: \mathcal{D} \rightarrow \mathcal{C}$ such that the composites FG and GF are monoidally naturally isomorphic to the identity functors. (Note that identity functors are immediately strict monoidal functors.)

1.2.2 String diagrams

A **strict monoidal category** category is a monoidal category in which the associators and unitors are all identity maps. In this case then any two objects that can be related by associators and unitors are equal, and so we may write objects without parentheses and units without ambiguity. An equivalent statement of Mac Lane's coherence theorem is that every monoidal category is monoidally equivalent to strict monoidal category.

Yet another equivalent statement of the coherence theorem is the existence of a graphical calculus for monoidal categories. As discussed above, monoidal categories figure strongly in our current investigations precisely because of this. We leave the details to discussions elsewhere, such as Selinger's survey [Sel11] or the original work of Joyal and Street [JS91, Theorem 1.2]. The main point is that we shall be free to assume our monoidal categories are strict, writing $X_1 \otimes X_2 \otimes \cdots \otimes X_n$ for objects in (\mathcal{C}, \otimes) without a care for parentheses. We then depict a morphism $f: X_1 \otimes X_2 \otimes \cdots \otimes$

$X_n \rightarrow Y_1 \otimes Y_2 \otimes \cdots \otimes Y_n$ with the diagram:

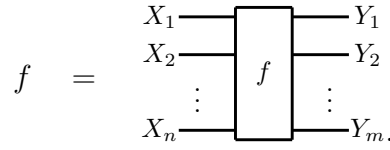

Identity morphisms are depicted by so-called strings or wires:

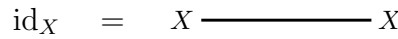

and the monoidal unit is not depicted at all:



Composition of morphisms is depicted by connecting the relevant wires:

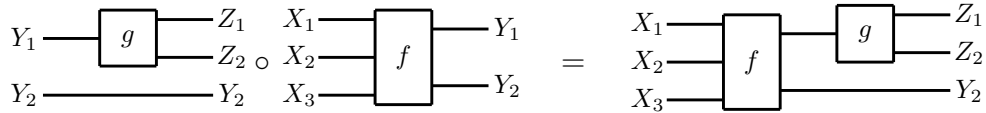

while monoidal composition is just juxtaposition:

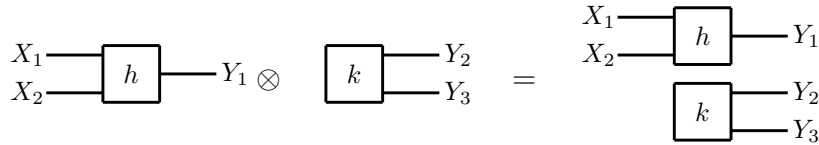

Only the ‘topology’ of the diagrams matters: if two diagrams with the same domain and codomain are equivalent up to isotopy, they represent the same morphism. On the other hand, two algebraic expressions might have the same diagrammatic representation. For example, the equivalent diagrams

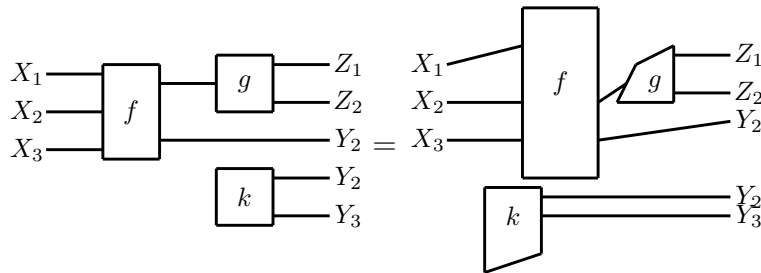

read as all of the equivalent algebraic expressions

$$((g \otimes \text{id}_{Y_2}) \otimes k) \circ f = (g \otimes ((\text{id}_{Y_2} \otimes k))) \circ \rho \circ (f \otimes \text{id}_I) = (g \otimes \text{id}_{Y_2}) \circ f \circ (\text{id}_{X_1 \otimes (X_2 \otimes X_3)} \otimes k)$$

and so on. The coherence theorem says that this does not matter: if two algebraic expressions have the same diagrammatic representation, then the algebraic expressions

are equal. In more formal language, the graphical calculus is sound and complete for the axioms of monoidal categories. Again, see Joyal–Street for details [JS91].

The coherence theorem thus implies that the graphical calculi goes beyond visualisations of morphisms: it can provide provide bona-fide proofs of equalities of morphisms. As a general principle, string diagrams are often more intuitive than the conventional algebraic language for understanding monoidal categories.

1.2.3 Symmetry

A symmetric braiding in a monoidal category provides the ability to permute objects or, equivalently, cross wires. We define symmetric monoidal categories making use of the graphical notation outlined above, but introducing a new, special symbol \bowtie .

A **symmetric monoidal category** is a monoidal category (\mathcal{C}, \otimes) together with natural isomorphisms

$$\begin{array}{c} A \text{---} \text{---} B \\ B \text{---} \text{---} A \end{array} \quad \sigma_{A,B} : A \otimes B \rightarrow B \otimes A$$

such that

$$\begin{array}{c} A \text{---} \text{---} A \\ B \text{---} \text{---} B \end{array} = \begin{array}{c} A \text{---} \text{---} A \\ B \text{---} \text{---} B \end{array}$$

and

$$\begin{array}{c} A \text{---} \text{---} B \\ B \text{---} \text{---} C \\ C \text{---} \text{---} A \end{array} = \begin{array}{c} A \text{---} \text{---} B \otimes C \\ B \otimes C \text{---} \text{---} A \end{array}$$

for all A, B, C in \mathcal{C} . We call σ the **braiding**. We will also talk, somewhat incidentally, of braided monoidal categories in the next chapter; a **braided monoidal category** is a monoidal category with a braiding that only obeys the latter axiom.

A (**lax/strong/strict**) **symmetric monoidal functor** is a (lax/strong/strict) monoidal functor that further obeys

$$\begin{array}{ccc} FA \otimes FB & \xrightarrow{\varphi_{A,B}} & F(A \otimes B) \\ \sigma'_{FA,FB} \downarrow & & \downarrow F\sigma_{A,B} \\ FB \otimes FA & \xrightarrow{\varphi_{B,A}} & F(B \otimes A) \end{array}$$

Morphisms between symmetric monoidal functors are simply monoidal natural transformations. Thus two symmetric monoidal categories are **symmetric monoidally equivalent** if they are monoidally equivalent by strong *symmetric* monoidal functors.

If our categories are merely braided, we refer to these functors as **braided monoidal functors**.

Roughly speaking, the coherence theorem for symmetric monoidal categories, with respect to string diagrams, states that two morphisms in a symmetric monoidal category are equal according to the axioms of symmetric monoidal categories if and only if their diagrams are equal up to isotopy and applications of the defining graphical identities above. See Joyal–Street [JS91, Theorem 2.3] for more precision and details.

1.3 Hypergraph categories

Just as symmetric monoidal categories equip monoidal categories with precisely enough extra structure to model crossing of strings in the graphical calculus, hypergraph categories equip symmetric monoidal categories with precisely enough extra structure to model multi-input multi-output interconnections of strings of the same type. For this, we require each object to be equipped with a so-called special commutative Frobenius monoid, which provides chosen maps to model this interaction. These have a coherence result, known as the ‘spider theorem’, that says exactly how we use these chosen maps to describe the connection of strings does not matter: all that matters is that the strings are connected.

1.3.1 Frobenius monoids

A Frobenius monoid comprises a monoid and comonoid on the same object that interact according to the so-called Frobenius law.

Definition 1.1. A **special commutative Frobenius monoid** $(X, \mu, \eta, \delta, \epsilon)$ in a symmetric monoidal category (\mathcal{C}, \otimes) is an object X of \mathcal{C} together with maps

$$\begin{array}{cccc} \begin{array}{c} \text{---} \\ \text{---} \end{array} \curvearrowright \bullet & \bullet \text{---} & \bullet \curvearrowleft \begin{array}{c} \text{---} \\ \text{---} \end{array} & \text{---} \bullet \\ \mu: X \otimes X \rightarrow X & \eta: I \rightarrow X & \delta: X \rightarrow X \otimes X & \epsilon: X \rightarrow I \end{array}$$

obeying the commutative monoid axioms

$$\begin{array}{ccc} \begin{array}{c} \text{---} \\ \text{---} \end{array} \curvearrowright \bullet \curvearrowright \text{---} = \begin{array}{c} \text{---} \\ \text{---} \end{array} \curvearrowright \bullet \\ \text{(associativity)} & \bullet \curvearrowright \text{---} = \text{---} & \begin{array}{c} \text{---} \\ \text{---} \end{array} \curvearrowleft \bullet \curvearrowleft \text{---} = \begin{array}{c} \text{---} \\ \text{---} \end{array} \curvearrowleft \bullet \\ \text{(unitality)} & & \text{(commutativity)} \end{array}$$

the cocommutative comonoid axioms

$$\begin{array}{ccc} \begin{array}{c} \text{---} \\ \text{---} \end{array} \curvearrowright \bullet \curvearrowright \text{---} = \begin{array}{c} \text{---} \\ \text{---} \end{array} \curvearrowright \bullet \\ \text{(coassociativity)} & \bullet \curvearrowright \text{---} = \text{---} & \begin{array}{c} \text{---} \\ \text{---} \end{array} \curvearrowleft \bullet \curvearrowleft \text{---} = \begin{array}{c} \text{---} \\ \text{---} \end{array} \curvearrowleft \bullet \\ \text{(counitality)} & & \text{(cocommutativity)} \end{array}$$

and the Frobenius and special axioms

$$\begin{array}{ccc}
 \begin{array}{c} \text{---} \\ \bullet \\ \text{---} \end{array} \begin{array}{c} \text{---} \\ \bullet \\ \text{---} \end{array} = \begin{array}{c} \text{---} \\ \bullet \\ \text{---} \end{array} \begin{array}{c} \text{---} \\ \bullet \\ \text{---} \end{array} = \begin{array}{c} \text{---} \\ \bullet \\ \text{---} \end{array} \begin{array}{c} \text{---} \\ \bullet \\ \text{---} \end{array} & \begin{array}{c} \text{---} \\ \bullet \\ \text{---} \end{array} \begin{array}{c} \text{---} \\ \bullet \\ \text{---} \end{array} = \text{---} \\
 \text{(Frobenius)} & \text{(special)}
 \end{array}$$

We call μ the **multiplication**, η the **unit**, δ the **comultiplication**, and ϵ the **counit**.

Arising from work in representation theory [BN37], special commutative Frobenius monoids were first formulated in this categorical form by Carboni and Walters, under the name commutative separable algebras [CW87]. The Frobenius law and the special law were termed the $S=X$ law and the diamond=1 law respectively [CW87, RSW05].

Alternate axiomatisations are possible. In addition to the ‘upper’ unitality law above, the mirror image ‘lower’ unitality law also holds, due to commutativity and the naturality of the braiding. While we write two equations for the Frobenius law, this is redundant: given the other axioms, the equality of any two of the diagrams implies the equality of all three. Further, note that a monoid and comonoid obeying the Frobenius law is commutative if and only if it is cocommutative. Thus while a commutative and cocommutative Frobenius monoid might more properly be called a bicommutative Frobenius monoid, there is no ambiguity if we only say commutative.

The common feature to these equations is that each side describes a different way of using the generators to connect some chosen set of inputs to some chosen set of outputs. This observation provides a coherence type result for special commutative Frobenius monoids, known as the spider theorem.

Theorem 1.2. *Let $(X, \mu, \eta, \delta, \epsilon)$ be a special commutative Frobenius monoid, and let $f, g: X^{\otimes n} \rightarrow X^{\otimes m}$ be maps constructed, using composition and the monoidal product, from $\mu, \eta, \delta, \epsilon$, the coherence maps and braiding, and the identity map on X . Then f and g are equal if and only if given their string diagrams in the above notation, there exists a bijection between the connected components of the two diagrams such that corresponding connected components connect the exact same sets of inputs and outputs.*

A corollary of Lack’s work on distributive laws for props [Lac04], this theorem was first explicitly formulated in the context of categorical quantum mechanics. See the textbook of Coecke and Kissinger [CK16] or paper by Coecke, Paquette, and Pavlovic [CPP09] for further details.

1.3.2 Hypergraph categories

Definition 1.3. A **hypergraph category** is a symmetric monoidal category (\mathcal{H}, \otimes) in which each object X is equipped with a special commutative Frobenius structure $(X, \mu_X, \delta_X, \eta_X, \epsilon_X)$ such that

$$\begin{array}{l}
 X \otimes Y \\
 X \otimes Y
 \end{array}
 \begin{array}{c}
 \curvearrowright \\
 \bullet \\
 \curvearrowleft
 \end{array}
 X \otimes Y =
 \begin{array}{c}
 X \\
 \curvearrowright \\
 Y \\
 \curvearrowleft \\
 X \\
 \curvearrowright \\
 Y
 \end{array}
 \quad
 \bullet \text{---} X \otimes Y =
 \begin{array}{c}
 \bullet \text{---} X \\
 \bullet \text{---} Y
 \end{array}$$

$$\begin{array}{c}
 X \otimes Y \\
 X \otimes Y
 \end{array}
 \begin{array}{c}
 \curvearrowleft \\
 \bullet \\
 \curvearrowright
 \end{array}
 X \otimes Y =
 \begin{array}{c}
 X \\
 \curvearrowleft \\
 Y \\
 \curvearrowright \\
 X \\
 \curvearrowleft \\
 Y
 \end{array}
 \quad
 X \otimes Y \text{---} \bullet =
 \begin{array}{c}
 X \text{---} \bullet \\
 Y \text{---} \bullet
 \end{array}$$

Note that we do *not* require these Frobenius morphisms to be natural in X . While morphisms in a hypergraph category need not interact with the Frobenius structure in any particular way, we do require functors between hypergraph categories to preserve it.

Definition 1.4. A functor (F, φ) of hypergraph categories, or **hypergraph functor**, is a strong symmetric monoidal functor $(F, \varphi): (\mathcal{H}, \otimes) \rightarrow (\mathcal{H}', \boxtimes)$ such that for each object X the following diagrams commute:

$$\begin{array}{ccc}
 FX \boxtimes FX & \xrightarrow{\mu_{FX}} & FX \\
 & \searrow \varphi & \nearrow F\mu_X \\
 & F(X \otimes X) &
 \end{array}
 \quad
 \begin{array}{ccc}
 I' & \xrightarrow{\eta_{FX}} & FX \\
 & \searrow \varphi_I & \nearrow F\eta_X \\
 & FI &
 \end{array}$$

$$\begin{array}{ccc}
 FX & \xrightarrow{\delta_{FX}} & FX \boxtimes FX \\
 & \searrow F\delta_X & \nearrow \varphi^{-1} \\
 & F(X \otimes X) &
 \end{array}
 \quad
 \begin{array}{ccc}
 FX & \xrightarrow{\epsilon_{FX}} & I' \\
 & \searrow F\epsilon_X & \nearrow \varphi^{-1} \\
 & FI &
 \end{array}$$

Equivalently, a strong symmetric monoidal functor F is a hypergraph functor if for every X the special commutative Frobenius structure on FX is

$$(FX, F\mu_X \circ \varphi_{X,X}, \varphi_{X,X}^{-1} \circ F\delta_X, F\eta_X \circ \varphi_I, \varphi_I^{-1} \circ F\epsilon_X).$$

Just as monoidal natural transformations themselves are enough as morphisms between symmetric monoidal functors, so too they suffice as morphisms between hypergraph functors. Two hypergraph categories are **hypergraph equivalent** if

there exist hypergraph functors with monoidal natural transformations to the identity functors.

The term hypergraph category was introduced recently [Fon15, Kis], in reference to the fact that these special commutative Frobenius monoids provide precisely the structure required for their string diagrams to be directed graphs with ‘hyperedges’: edges connecting any number of inputs to any number of outputs. More precisely, write $\mathcal{P}(N)$ for the finite power set of N . Then a directed hypergraph (N, H, s, t) comprises a set N of vertices, a set H of hyperedges, and source and target functions $s, t: H \rightarrow \mathcal{P}(N)$. We then think of morphisms in a hypergraph category as hyperedges; for example, the morphism

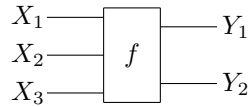

is a hyperedge from the set $\{X_1, X_2, X_3\}$ to the set $\{Y_1, Y_2\}$. Roughly speaking, two morphisms of a hypergraph category are equal by the axioms of a hypergraph category if their string diagrams reduce, using the graphical manipulations given by the symmetric monoidal category and Frobenius axioms, to the same hypergraph. Details can be found in the work of Bonchi, Gadduci, Kissinger, Sobociński, and Zanasi [BGKSZ].

Like special commutative Frobenius monoids, hypergraph categories were first defined by Walters and Carboni, under the name *well-supported compact closed category* (the first appearance in print is [Car91]; see [RSW05] for a history). In recent years they have been rediscovered a number of times, also appearing under the names *dgs-monoidal category* [GH98] and *dungeon category* [Mor14].

1.3.3 Hypergraph categories are self-dual compact closed

Note that if an object X is equipped with a Frobenius monoid structure then the maps

$$\begin{array}{ccc} \begin{array}{c} \text{---} \\ \text{---} \\ \text{---} \end{array} \begin{array}{c} \text{---} \\ \text{---} \\ \text{---} \end{array} & \text{and} & \begin{array}{c} \text{---} \\ \text{---} \\ \text{---} \end{array} \begin{array}{c} \text{---} \\ \text{---} \\ \text{---} \end{array} \\ \epsilon \circ \mu: X \otimes X \rightarrow I & & \delta \circ \eta: I \rightarrow X \otimes X \end{array}$$

obey both

and the reflected equations. Thus if an object carries a Frobenius monoid it is also self-dual, and any hypergraph category is a fortiori self-dual compact closed.

We introduce the notation

$$\begin{array}{c} \text{Cup} \\ \text{---} \\ \text{---} \end{array} := \begin{array}{c} \bullet \\ \bullet \\ \text{---} \end{array} \quad \begin{array}{c} \text{Cap} \\ \text{---} \\ \text{---} \end{array} := \begin{array}{c} \text{---} \\ \text{---} \\ \bullet \\ \bullet \end{array}$$

As in any self-dual compact closed category, mapping each morphism $X \xrightarrow{f} Y$ to its dual morphism

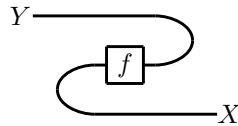

further equips each hypergraph category with a so-called dagger functor—an involutive contravariant endofunctor that is the identity on objects—such that the category is a dagger compact category. Dagger compact categories were first introduced in the context of categorical quantum mechanics [AC04], under the name strongly compact closed category, and have been demonstrated to be a key structure in diagrammatic reasoning and the logic of quantum mechanics.

Compactness introduces a tight relationship between composition and the monoidal product of morphisms. Firstly, there is a one-to-one correspondence between morphisms $X \rightarrow Y$ and morphisms $I \rightarrow X \otimes Y$ given by taking $X \xrightarrow{f} Y$ to its so-called **name**

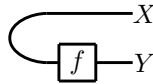

By compactness, we have the equation

$$\begin{array}{c} \text{---} \\ \text{---} \\ \text{---} \\ \text{---} \end{array} \begin{array}{c} X \\ \\ \\ Z \end{array} = \begin{array}{c} \text{---} \\ \text{---} \\ \text{---} \end{array} \begin{array}{c} X \\ \\ Z \end{array}$$

Here the right hand side is the name of the composite $f \circ g$, while the left hand side is the monoidal product post-composed with the map

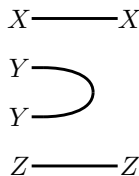

Thus this morphism, the product of a cap and two identity maps, enacts the categorical composition on monoidal products of names. We will make liberal use of this fact.

1.3.4 Coherence

The lack of naturality of the Frobenius maps in hypergraph categories affects some common, often desirable, properties of structured categories. For example, it is not always possible to construct a skeletal hypergraph category hypergraph equivalent to a given hypergraph category: isomorphic objects may be equipped with distinct Frobenius structures. Similarly, a fully faithful, essentially surjective hypergraph functor does not necessarily define a hypergraph equivalence of categories.

Nonetheless, in this section we prove that every hypergraph category is hypergraph equivalent to a strict hypergraph category. This coherence result will be important in proving that every hypergraph category can be constructed using decorated corelations.

Theorem 1.5. *Every hypergraph category is hypergraph equivalent to a strict hypergraph category. Moreover, the objects of this strict hypergraph category form a free monoid.*

Proof. Let (\mathcal{H}, \otimes) be a hypergraph category. Write I for the monoidal unit in \mathcal{H} . As \mathcal{H} is a fortiori a symmetric monoidal category, a standard construction (see Mac Lane [Mac98, Theorem XI.3.1]) gives an equivalent strict symmetric monoidal category $(\mathcal{H}_{\text{str}}, \cdot)$ with finite lists $[x_1 : \dots : x_n]$ of objects of \mathcal{H} as objects and as morphisms $[x_1 : \dots : x_n] \rightarrow [y_1 : \dots : y_m]$ those morphisms from $((x_1 \otimes x_2) \otimes \dots) \otimes x_n \otimes I \rightarrow ((y_1 \otimes y_2) \otimes \dots) \otimes y_m \otimes I$ in \mathcal{H} . Composition is given by composition in \mathcal{H} .

The monoidal structure on \mathcal{H}_{str} is given as follows. The monoidal product of objects in \mathcal{H}_{str} is given by concatenation \cdot of lists; the monoidal unit is the empty list. Given a list $X = [x_1 : \dots : x_n]$ of objects in \mathcal{H} , write $PX = (((x_1 \otimes x_2) \otimes \dots) \otimes x_n) \otimes I$ for the ‘pre-parenthesised product of X ’ in \mathcal{H} with all open parenthesis at the front. Note that the empty list maps to the monoidal unit I . The monoidal product of two morphisms is given by their monoidal product in \mathcal{H} pre- and post-composed with the necessary canonical maps: given $f: X \rightarrow Y$ and $g: Z \rightarrow W$, their product $f \cdot g: X \cdot Y \rightarrow Z \cdot W$ is

$$P(X \cdot Y) \xrightarrow{\sim} PX \otimes PY \xrightarrow{f \otimes g} PZ \otimes PW \xrightarrow{\sim} P(Z \cdot W).$$

By design, the associators and unitors of \mathcal{H}_{str} are simply identity maps. The braiding $X \cdot Y \rightarrow Y \cdot X$ is given by the braiding $PX \otimes PY \rightarrow PY \otimes PX$ in \mathcal{H} , similarly pre- and post-composed with the necessary canonical maps. This defines a strict symmetric monoidal category [Mac98].

To make \mathcal{H}_{str} into a hypergraph category, we make each object $[x_1 : \dots : x_n]$ into a special commutative Frobenius monoid in a similar way, pre- and post-composing lists of Frobenius maps with the necessary canonical maps. For example, the multiplication on $[x_1 : \dots : x_n]$ is given by

$$\begin{array}{c}
P([x_1 : \dots : x_n] \cdot [x_1 : \dots : x_n]) \\
\parallel \\
(((((((x_1 \otimes x_2) \otimes \dots) \otimes x_n) \otimes x_1) \otimes x_2) \otimes \dots) \otimes x_n) \otimes I \\
\downarrow \sim \\
((((((x_1 \otimes x_1) \otimes (x_2 \otimes x_2)) \otimes \dots) \otimes (x_n \otimes x_n)) \otimes I \\
\downarrow ((\mu_{x_1} \otimes \mu_{x_2}) \otimes \dots) \otimes \mu_{x_n} \otimes 1_I \\
(((x_1 \otimes x_2) \otimes \dots) \otimes x_n) \otimes I \\
\parallel \\
P([x_1 : \dots : x_n])
\end{array}$$

where the map labelled \sim is the canonical map such that each pair of x_i 's remains in the same order. As the coherence maps are natural, each special commutative Frobenius monoid axiom for this data on $[x_1 : \dots : x_n]$ reduces to a list of the corresponding axioms for the objects x_i in \mathcal{H} . Similarly, the coherence axioms and naturality of the coherence maps imply the Frobenius structure on the monoidal product of objects is given by the Frobenius structures on the factors in the required way. This defines a hypergraph category.

The strict hypergraph category $(\mathcal{H}_{\text{str}}, \cdot)$	
objects	finite lists $[x_1 : \dots : x_n]$ of objects of \mathcal{H}
morphisms	$\text{hom}_{\mathcal{H}_{\text{str}}}([x_1 : \dots : x_n], [y_1 : \dots : y_m])$ $= \text{hom}_{\mathcal{H}}(((x_1 \otimes \dots) \otimes x_n) \otimes I, ((y_1 \otimes \dots) \otimes y_m) \otimes I)$
composition	composition of corresponding maps in \mathcal{H}
monoidal product	concatenation of lists
coherence maps	associators and unitors are strict; braiding is inherited from \mathcal{H}
hypergraph maps	lists of hypergraph maps in \mathcal{H}

Mac Lane's standard construction further gives a strong symmetric monoidal functors $P: \mathcal{H}_{\text{str}} \rightarrow \mathcal{H}$ extending the map P above, and $S: \mathcal{H} \rightarrow \mathcal{H}_{\text{str}}$ sending $x \in \mathcal{H}$ to the string $[x]$ of length 1 in \mathcal{H}_{str} . These extend to hypergraph functors.

In detail, the functor P is given on morphisms by taking a map in $\text{hom}_{\mathcal{H}_{\text{str}}}(X, Y)$ to the same map considered now as a map in $\text{hom}_{\mathcal{H}}(PX, PY)$; its coherence maps are given by the canonical maps $PX \otimes PY \rightarrow P(X \cdot Y)$. The functor S is also easy to define: tensoring with the identity on I gives a one-to-one correspondence between morphisms $x \rightarrow y$ in \mathcal{H} and morphisms $[x] \rightarrow [y]$ in \mathcal{H}_{str} , so S is a monoidal embedding of \mathcal{H} into \mathcal{H}_{str} . By Mac Lane's proof of the coherence theorem for monoidal categories these are both strong monoidal functors.

By inspection these functors also preserve hypergraph structure: note in particular that the axioms interrelating the Frobenius structure and monoidal structure in \mathcal{H} are crucial for the hypergraph-preserving nature of P . Hence P and S are hypergraph functors. As they already witness an equivalence of symmetric monoidal categories, thus \mathcal{H} and \mathcal{H}_{str} are equivalent as hypergraph categories. \square

1.4 Example: cospan categories

A central example of a hypergraph category is the category $\text{Cospan}(\mathcal{C})$ of cospans in a category \mathcal{C} with finite colimits. We call such categories cospan categories. In the coming chapters we will successively generalise this structure, first to decorated cospans, then corelations, then decorated corelations. Each time, the new categories we construct will inherit hypergraph structure from their relationship with cospan categories.

We first recall the basic definitions. Let \mathcal{C} be a category with finite colimits, writing the coproduct $+$. A **cospan**

$$\begin{array}{ccc} & N & \\ i \nearrow & & \nwarrow o \\ X & & Y \end{array}$$

from X to Y in \mathcal{C} is a pair of morphisms with common codomain. We refer to X and Y as the **feet**, and N as the **apex**. Given two cospans $X \xrightarrow{i} N \xleftarrow{o} Y$ and $X \xrightarrow{i'} N' \xleftarrow{o'} Y$ with the same feet, a **map of cospans** is a morphism $n: N \rightarrow N'$ in \mathcal{C} between the apices such that

$$\begin{array}{ccc} & N & \\ i \nearrow & \downarrow n & \nwarrow o \\ X & & Y \\ i' \searrow & & \swarrow o' \\ & N' & \end{array}$$

commutes.

Cospans may be composed using the pushout from the common foot: given cospans $X \xrightarrow{i_X} N \xleftarrow{o_Y} Y$ and $Y \xrightarrow{i_Y} M \xleftarrow{o_Z} Z$, their composite cospan is $X \xrightarrow{j_N \circ i_X} N +_Y M \xleftarrow{j_M \circ i_Z} Z$, where the maps j are given by the pushout square in the diagram

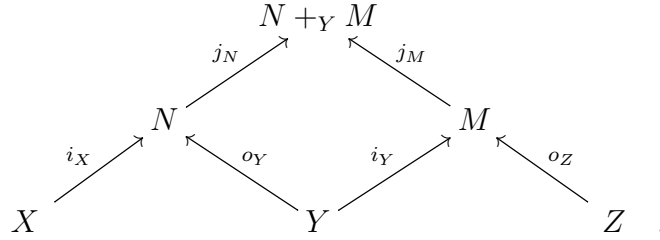

This composition rule is associative up to isomorphism, and so we may define a category, in fact a symmetric monoidal category, $\text{Cospan}(\mathcal{C})$ with objects the objects of \mathcal{C} and morphisms isomorphism classes of cospans.

The symmetric monoidal structure is ‘inherited’ from \mathcal{C} . Indeed, we shall consider any category \mathcal{C} with finite colimits a symmetric monoidal category as follows. Given maps $f: A \rightarrow C, g: B \rightarrow C$ with common codomain, the universal property of the coproduct gives a unique map $A + B \rightarrow C$. We call this the **copairing** of f and g , and write it $[f, g]$. The monoidal product on \mathcal{C} is then given by the coproduct $+$, with monoidal unit the initial object \emptyset and coherence maps given by copairing the appropriate identity, inclusion, and initial object maps. For example, the braiding is given by $[\iota_X, \iota_Y]: X + Y \rightarrow Y + X$ where $\iota_X: X \rightarrow Y + X$ and $\iota_Y: Y \rightarrow Y + X$ are the inclusion maps into the coproduct $Y + X$.

The category $\text{Cospan}(\mathcal{C})$ inherits this symmetric monoidal structure from \mathcal{C} as follows. Call a subcategory \mathcal{C} of a category \mathcal{D} **wide** if \mathcal{C} contains all objects of \mathcal{D} , and call a functor that is faithful and bijective-on-objects a **wide embedding**. Note then that we have a wide embedding

$$\mathcal{C} \hookrightarrow \text{Cospan}(\mathcal{C})$$

that takes each object of \mathcal{C} to itself as an object of $\text{Cospan}(\mathcal{C})$, and each morphism $f: X \rightarrow Y$ in \mathcal{C} to the cospan

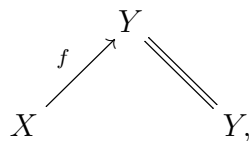

where the extended ‘equals’ sign denotes an identity morphism. Now since the monoidal product $+: \mathcal{C} \times \mathcal{C} \rightarrow \mathcal{C}$ is left adjoint to the diagonal functor, it preserves

colimits, and so extends to a functor $+: \text{Cospan}(\mathcal{C}) \times \text{Cospan}(\mathcal{C}) \rightarrow \text{Cospan}(\mathcal{C})$. The coherence maps are just the images of the coherence maps in \mathcal{C} under this wide embedding; checking naturality is routine, and clearly they still obey the required axioms.

Remark 1.6. Recall that all finite colimits in a category \mathcal{C} can be assembled from an initial object and the use of pushouts [Mac98]. The monoidal category $(\text{Cospan}(\mathcal{C}), +)$ thus provides an excellent setting for describing finite colimits in \mathcal{C} : the initial object is the monoidal unit, and pushouts are given by composition of cospans. Rosebrugh, Sabadini, and Walters begin an exploration of the consequences of this idea in [RSW08].

Recall also that coproduct in the category Set of sets and functions is the disjoint union of sets. Colimits often have this sort of intuitive interpretation of combining systems, and so are frequently useful for discussing interconnection of systems. This intuition is a cornerstone of the present work.

The theory of symmetric monoidal categories of cospans is all well known, following from theory originally developed for the dual concept: spans. First discussed by Yoneda [Yon54], spans are pairs of morphisms $X \leftarrow N \rightarrow Y$ with a common domain. Bénabou introduced the bicategory of objects, spans, and maps of spans in a category with finite limits as an example of a symmetric monoidal bicategory [Ben67]. The symmetric monoidal category $\text{Cospan}(\mathcal{C})$ is a decategorified version of the symmetric monoidal bicategory of cospans.

More recently, Lack proved that cospans and Frobenius monoids are intimately related. Write FinSet for the category of finite sets and functions. This category is a monoidal category with the coproduct $+$ as monoidal product. Moreover, as a symmetric monoidal category $(\text{FinSet}, +)$ has a strict skeleton. In the following proposition FinSet denotes this strict skeleton.

Proposition 1.7. *Special commutative Frobenius monoids in a strict symmetric monoidal category \mathcal{C} are in one-to-one correspondence with strict symmetric monoidal functors $\text{Cospan}(\text{FinSet}) \rightarrow \mathcal{C}$.*

Proof. The special commutative Frobenius monoid is given by the image of the one element set. See Lack [Lac04]. \square

Over the next few chapters we will further explore this deep link between cospans and special commutative Frobenius monoids and hypergraph categories. To begin, we detail a hypergraph structure on each cospan category $\text{Cospan}(\mathcal{C})$.

Like the braiding, this hypergraph structure also comes from copairings of identity morphisms. Call cospans

$$\begin{array}{c} & N & \\ i \nearrow & & \nwarrow o \\ X & & Y \end{array} \quad \text{and} \quad \begin{array}{c} & N & \\ o \nearrow & & \nwarrow i \\ Y & & X \end{array}$$

that are reflections of each other **opposite** cospans. Given any object X in \mathcal{C} , the copairing $[1_X, 1_X]: X + X \rightarrow X$ of two identity maps on X , together with the unique map $!: \emptyset \rightarrow X$ from the initial object to X , define a monoid structure on X . Considering these maps as morphisms in $\text{Cospan}(\mathcal{C})$, we may take them together with their opposites to give a special commutative Frobenius structure on X . Using the universal property of the coproduct, and noting that the Frobenius maps and the braiding are both given by copairings of identity morphisms, it is easily verified that this gives a hypergraph category.

Given $f: X \rightarrow Y$ in \mathcal{C} , abuse notation by writing $f \in \text{Cospan}(\mathcal{C})$ for the cospan $X \xrightarrow{f} Y \xleftarrow{1_Y} Y$, and f^{op} for the cospan $Y \xrightarrow{1_Y} Y \xleftarrow{f} X$. To summarise:

Proposition 1.8 (Rosebrugh–Sabadini–Walters [RSW08]). *Given a category \mathcal{C} with finite colimits, we may define a hypergraph category $\text{Cospan}(\mathcal{C})$ as follows:*

<i>The hypergraph category $(\text{Cospan}(\mathcal{C}), +)$</i>	
objects	<i>the objects of \mathcal{C}</i>
morphisms	<i>isomorphism classes of cospans in \mathcal{C}</i>
composition	<i>given by pushout</i>
monoidal product	<i>the coproduct in \mathcal{C}</i>
coherence maps	<i>inherited from $(\mathcal{C}, +)$</i>
hypergraph maps	$\mu = [1, 1], \eta = !, \delta = [1, 1]^{\text{op}}, \epsilon = !^{\text{op}}$.

We will often abuse our terminology and refer to cospans themselves as morphisms in some cospan category $\text{Cospan}(\mathcal{C})$; we of course refer instead to the isomorphism class of the said cospan.

It is not difficult to show that we in fact have a functor from the category having categories with finite colimits as objects and colimit preserving functors as morphisms to the category of hypergraph categories and hypergraph functors.¹ In the next

¹Categories with finite colimits are known as *finitely cocomplete*, or (rarely) *rex* or *right exact*, while functors that preserve finite colimits are known as *finitely cocontinuous* or *right exact*. This extra layer of terminology is not necessary here, and so we favour the more friendly, if occasionally a touch cumbersome, terms above.

chapter we show that this extends to a functor from a category of so-called symmetric lax monoidal presheaves over categories with finite colimits. This is known as the decorated cospan construction, and will be instrumental in constructing hypergraph categories with network diagrams as morphisms.

Chapter 2

Decorated cospans: from closed systems to open

In the previous chapter we discussed hypergraph categories as a model for network languages, and showed that cospans provide a method of constructing such categories. In many situations, however, we wish to model our systems not just with cospans, but ‘decorated’ cospans, where the apex of each cospan is equipped with some extra structure. In this chapter we detail a method for composing such decorated cospans.

The next section provides an introductory overview. Following this, we give a formal definition of decorated cospan categories and show they are well defined in §2.2, and do the same for functors between decorated cospan categories in §2.3. While we first define decorated cospans on any lax symmetric monoidal functor $F: (\mathcal{C}, +) \rightarrow (\mathcal{D}, \otimes)$, where \mathcal{C} has finite colimits and $+$ is the coproduct, in §2.4 we show that it is enough to consider the case when (\mathcal{D}, \otimes) is the category (Set, \times) of sets and functions with monoidal structure given by the cartesian product. We then conclude the chapter with some examples.

2.1 From closed systems to open

The key idea in this chapter is that we may take our network diagrams, mark points of interconnection, or terminals, using cospans, and connect these terminals with others using pushouts. This marking of terminals defines a boundary of the system, turning it from a closed system to an open system. This process freely constructs a hypergraph category from a library of network pieces.

It has been recognised for some time that spans and cospans provide an intuitive framework for composing network diagrams [KSW97], and the material we develop here is a variant on this theme. Rather than use cospans in a category of network

diagrams, however, we define a category which models just the interconnection structure, and then decorate cospans in this category with additional structure. In the case of finite graphs, the intuition reflected is this: given two graphs, we may construct a third by gluing chosen vertices of the first with chosen vertices of the second. Our goal in this chapter is to view this process as composition of morphisms in a category, in a way that also facilitates the construction of a composition rule for any semantics associated to the diagrams, and the construction of a functor between these two resulting categories.

To see how this works, let us start with the following graph:

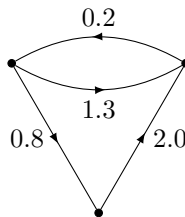

We shall work with labelled, directed graphs, as the additional data help highlight the relationships between diagrams. Now, for this graph to be a morphism, we must equip it with some notion of ‘input’ and ‘output’. We do this by marking vertices using functions from finite sets:

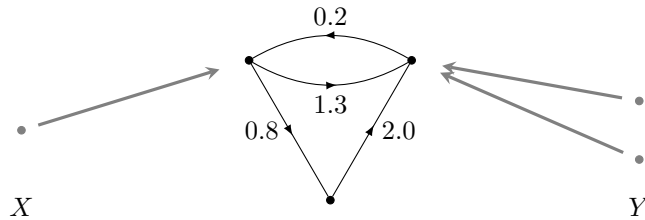

Let N be the set of vertices of the graph. Here the finite sets X , Y , and N comprise one, two, and three elements respectively, drawn as points, and the values of the functions $X \rightarrow N$ and $Y \rightarrow N$ are indicated by the grey arrows. This forms a cospan in the category of finite sets, one with the set at the apex decorated by our given graph.

Given another such decorated cospan with input set equal to the output of the above cospan

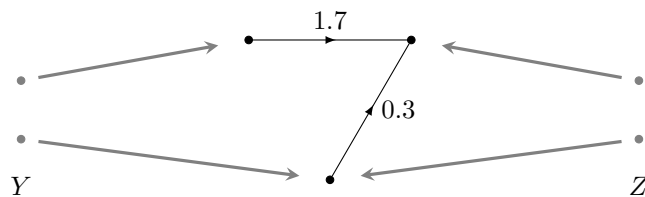

composition involves gluing the graphs along the identifications

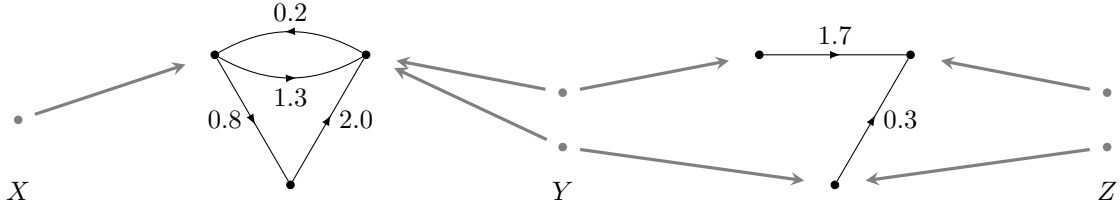

specified by the shared foot of the two cospans. This results in the decorated cospan

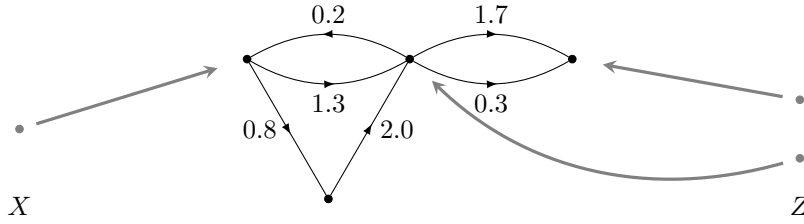

The decorated cospan framework generalises this intuitive construction.

More precisely: fix a set L . Then given a finite set N , we may talk of the collection of finite L -labelled directed multigraphs, to us just L -graphs or simply graphs, that have N as their set of vertices. Write such a graph (N, E, s, t, r) , where E is a finite set of edges, $s: E \rightarrow N$ and $t: E \rightarrow N$ are functions giving the source and target of each edge respectively, and $r: E \rightarrow L$ equips each edge with a label from the set L . Next, given a function $f: N \rightarrow M$, we may define a function from graphs on N to graphs on M mapping (N, E, s, t, r) to $(M, E, f \circ s, f \circ t, r)$. After dealing appropriately with size issues, this gives a lax monoidal functor from $(\text{FinSet}, +)$ to (Set, \times) .¹

Now, taking any lax monoidal functor $(F, \varphi): (\mathcal{C}, +) \rightarrow (\mathcal{D}, \otimes)$ with \mathcal{C} having finite colimits and coproduct written $+$, the decorated cospan category associated to F has as objects the objects of \mathcal{C} , and as morphisms pairs comprising a cospan in \mathcal{C} together with some morphism $I \rightarrow FN$, where I is the unit in (\mathcal{D}, \otimes) and N is the apex of the cospan. In the case of our graph functor, this additional data is equivalent to equipping the apex N of the cospan with a graph. We thus think of our morphisms as having two distinct parts: an instance of our chosen structure on the apex, and a cospan describing interfaces to this structure. Our first theorem (Theorem 2.4)

¹Here $(\text{FinSet}, +)$ is the monoidal category of finite sets and functions with disjoint union as monoidal product, and (Set, \times) is the category of sets and functions with cartesian product as monoidal product. One might ensure the collection of graphs forms a set in a number of ways. One such method is as follows: the categories of finite sets and finite graphs are essentially small; replace them with equivalent small categories. We then constrain the graphs (N, E, s, t, r) to be drawn only from the objects of our small category of finite graphs.

says that when (\mathcal{D}, \otimes) is braided monoidal and (F, φ) lax braided monoidal, we may further give this data a composition rule and monoidal product such that the resulting decorated cospan category is hypergraph.

Suppose now we have two such lax monoidal functors; we then have two such decorated cospan categories. Our second theorem (Theorem 2.8) is that, given also a monoidal natural transformation between these functors, we may construct a strict hypergraph functor between their corresponding decorated cospan categories. These natural transformations can often be specified by some semantics associated to some type of topological diagram. A trivial case of such is assigning to a finite graph its number of vertices, but richer examples abound, including assigning to a directed graph with edges labelled by rates its depicted Markov process, or assigning to an electrical circuit diagram the current–voltage relationship such a circuit would impose.

2.2 Decorated cospan categories

Our task in this section is to define decorated cospans and prove that they can be used to construct hypergraph categories. Motivated by our discussion in the previous section, we thus begin with the following definition.

Definition 2.1. Let \mathcal{C} be a category with finite colimits, and

$$(F, \varphi): (\mathcal{C}, +) \longrightarrow (\mathcal{D}, \otimes)$$

be a lax monoidal functor. We define a **decorated cospan**, or more precisely an F -decorated cospan, to be a pair

$$\left(\begin{array}{ccc} & N & \\ i \nearrow & & \nwarrow o \\ X & & Y \end{array}, \begin{array}{c} FN \\ \uparrow s \\ I \end{array} \right)$$

comprising a cospan $X \xrightarrow{i} N \xleftarrow{o} Y$ in \mathcal{C} together with an element $I \xrightarrow{s} FN$ of the F -image FN of the apex of the cospan. We shall call the element $I \xrightarrow{s} FN$ the **decoration** of the decorated cospan. A **morphism of decorated cospans**

$$n: (X \xrightarrow{i_X} N \xleftarrow{o_Y} Y, I \xrightarrow{s} FN) \longrightarrow (X \xrightarrow{i'_X} N' \xleftarrow{o'_Y} Y, I \xrightarrow{s'} FN')$$

is a morphism $n: N \rightarrow N'$ of cospans such that $Fn \circ s = s'$.

Observe that we may define a category with decorated cospans as objects and morphisms of decorated cospans as morphisms.

2.2.1 Composing decorated cospans

Our first concern is to show that isomorphism classes of decorated cospans form the *morphisms* of a category. The objects in this category will be the objects of \mathcal{C} .

Proposition 2.2. *There is a category $FCospan$ of F -decorated cospans, with objects the objects of \mathcal{C} , and morphisms isomorphism classes of F -decorated cospans. On representatives of the isomorphism classes, composition in this category is given by pushout of cospans in \mathcal{C}*

$$\begin{array}{ccccc}
 & & N +_Y M & & \\
 & & \nearrow j_N & & \nwarrow j_M \\
 & X & \xrightarrow{i_X} N & & M \xrightarrow{o_Z} Z \\
 & & \nwarrow o_Y & & \nearrow i_Y \\
 & & Y & &
 \end{array}$$

paired with the composite

$$I \xrightarrow{\lambda^{-1}} I \otimes I \xrightarrow{s \otimes t} FN \otimes FM \xrightarrow{\varphi_{N,M}} F(N + M) \xrightarrow{F[j_N, j_M]} F(N +_Y M)$$

of the tensor product of the decorations with the F -image of the copairing of the pushout maps.

Proof. The identity morphism on an object X in a decorated cospan category is simply the identity cospan decorated as follows:

$$\left(\begin{array}{c} X \\ \parallel \quad \parallel \\ X \quad X \end{array}, \begin{array}{c} FX \\ \uparrow F! \\ F\emptyset \\ \uparrow \varphi_I \\ I \end{array} \right).$$

We must check that the composition defined is well defined on isomorphism classes, is associative, and, with the above identity maps, obeys the unitality axiom. These are straightforward, but lengthy, exercises in using the available colimits and monoidal structure to show that the relevant diagrams of decorations commute. We do this now.

Representation independence for composition of isomorphism classes of decorated cospans. Let

$$n: (X \xrightarrow{i_X} N \xleftarrow{o_Y} Y, I \xrightarrow{s} FN) \longrightarrow (X \xrightarrow{i'_X} N' \xleftarrow{o'_Y} Y, I \xrightarrow{s'} FN')$$

and

$$m: (Y \xrightarrow{i_Y} M \xleftarrow{o_Z} Z, I \xrightarrow{t} FM) \longrightarrow (Y \xrightarrow{i'_Y} M' \xleftarrow{o'_Z} Z, I \xrightarrow{t'} FM')$$

be isomorphisms of decorated cospans. We wish to show that the composite of the decorated cospans on the left is isomorphic to the composite of the decorated cospans on the right. As discussed in §1.4, it is well known that the composite cospans are isomorphic. It remains for us to check the decorations agree too. Let $p: N +_Y M \rightarrow N' +_Y M'$ be the isomorphism given by the universal property of the pushout and the isomorphisms $n: N \rightarrow N'$ and $m: M \rightarrow M'$. Then the two decorations in question are given by the top and bottom rows of the following diagram.

$$\begin{array}{ccccccc}
 I \xrightarrow{\lambda^{-1}} I \otimes I & & & & FN \otimes FM & \xrightarrow{\varphi_{N,M}} & F(N+M) & \xrightarrow{F[j_N, j_M]} & F(N+_Y M) \\
 & \nearrow^{s \otimes t} & & & \downarrow \sim & & \downarrow \sim & & \downarrow \sim \\
 & & (I) & & Fn \otimes Fm & \xrightarrow{(F)} & F(n+m) & \xrightarrow{(C)} & Fp \\
 & \searrow_{s' \otimes t'} & & & & & & & \\
 & & & & FN' \otimes FM' & \xrightarrow{\varphi_{N',M'}} & F(N'+M') & \xrightarrow{F[j_{N'}, j_{M'}]} & F(N'+_Y M')
 \end{array}$$

The triangle (I) commutes as n and m are morphisms of decorated cospans and $- \otimes -$ is functorial, (F) commutes by the monoidality of F , and (C) commutes by properties of colimits in \mathcal{C} and the functoriality of F . This proves the claim.

Associativity. Suppose we have morphisms

$$(X \xrightarrow{i_X} N \xleftarrow{o_Y} Y, I \xrightarrow{s} FN),$$

$$(Y \xrightarrow{i_Y} M \xleftarrow{o_Z} Z, I \xrightarrow{t} FM),$$

$$(Z \xrightarrow{i_Z} P \xleftarrow{o_W} W, I \xrightarrow{u} FP).$$

It is well known that composition of isomorphism classes of cospans via pushout of representatives is associative; this follows from the universal properties of the relevant colimit. We must check that the pushforward of the decorations is also an associative process. Write

$$\tilde{a}: (N +_Y M) +_Z P \longrightarrow N +_Y (M +_Z P)$$

for the unique isomorphism between the two pairwise pushouts constructions from the above three cospans. Consider then the following diagram, with leftmost column the decoration obtained by taking the composite of the first two morphisms first, and

the rightmost column the decoration obtained by taking the composite of the last two morphisms first.

$$\begin{array}{c}
 \begin{array}{ccc}
 F((N+Y M)+Z P) & \xrightarrow{F\tilde{a}} & F(N+Y(M+Z P)) \\
 \uparrow F[j_{N+Y M}, j_P] & & \uparrow F[j_N, j_{M+Z P}] \\
 F((N+Y M)+P) & & F(N+(M+Z P)) \\
 \uparrow \varphi_{N+Y M, P} & \xleftarrow{F([j_N, j_M]+1_P)} & \uparrow \varphi_{N, M+Z P} \\
 F((N+M)+P) & \xrightarrow{F a} & F(N+(M+P)) \\
 \uparrow \varphi_{N+M, P} & & \uparrow \varphi_{N, M+P} \\
 F(N+Y M) \otimes F P & & F N \otimes F(M+Z P) \\
 \uparrow F[j_N, j_M] \otimes 1_{F P} & \xleftarrow{F([j_N, j_M]+1_{F P})} & \uparrow 1_{F N} \otimes F[j_M, j_P] \\
 F(N+M) \otimes F P & & F N \otimes F(M+P) \\
 \uparrow \varphi_{N, M} \otimes 1_{F P} & \xleftarrow{a} & \uparrow 1_{F N} \otimes \varphi_{M, P} \\
 (F N \otimes F M) \otimes F P & \xrightarrow{a} & F N \otimes (F M \otimes F P) \\
 \uparrow (s \otimes t) \otimes u & & \uparrow s \otimes (t \otimes u) \\
 (I \otimes I) \otimes I & \xrightarrow{a} & I \otimes (I \otimes I) \\
 \uparrow \rho^{-1} \otimes 1 & & \uparrow 1 \otimes \lambda^{-1} \\
 I \otimes I & & \\
 \uparrow \lambda^{-1} & & \\
 I & &
 \end{array}
 \end{array}$$

This diagram commutes as (D1) is the triangle coherence equation for the monoidal category (\mathcal{D}, \otimes) , (D2) is naturality for the associator a , (F1) is the associativity condition for the monoidal functor F , (F2) and (F3) commute by the naturality of φ , and (C) commutes as it is the F -image of a hexagon describing the associativity of the pushout. This shows that the two decorations obtained by the two different orders of composition of our three morphisms are equal up to the unique isomorphism \tilde{a} between the two different pushouts that may be obtained. Our composition rule is hence associative.

Identity morphisms. We shall show that the claimed identity morphism on Y , the decorated cospan

$$(Y \xrightarrow{1_Y} Y \xleftarrow{1_Y} Y, I \xrightarrow{F! \circ \varphi_I} FY),$$

is an identity for composition on the right; the case for composition on the left is similar. The cospan in this pair is known to be the identity cospan in $\text{Cospan}(\mathcal{C})$. We thus need to check that, given a morphism

$$(X \xrightarrow{i} N \xleftarrow{o} Y, I \xrightarrow{s} FN),$$

the composite of the product $s \otimes (F! \circ \varphi_I)$ with the F -image of the copairing $[1_N, o]: N + Y \rightarrow N$ of the pushout maps is again the same element s ; this composite being, by definition, the decoration of the composite of the given morphism and the claimed identity map. This is shown by the commutativity of the diagram below, with the path along the lower edge equal to the aforementioned pushforward.

$$\begin{array}{c}
\begin{array}{c}
I \xrightarrow{\quad s \quad} FN \\
\lambda_I^{-1} \searrow \quad \nearrow \rho_{FN} \\
I \otimes I \xrightarrow{s \otimes 1} FN \otimes I \xrightarrow{1_{FN} \otimes \varphi_I} FN \otimes F\emptyset \xrightarrow{\varphi_{N, \emptyset}} F(N + \emptyset) \\
\downarrow s \otimes (F! \circ \varphi_I) \quad \downarrow 1_{FN} \otimes F! \quad \downarrow \varphi_{N, \emptyset} \quad \downarrow F(1_N + !) \\
FN \otimes FY \xrightarrow{\varphi_{N, M}} F(N + Y)
\end{array} \\
\text{(D1)} \quad \text{(D2)} \quad \text{(F1)} \quad \text{(F2)} \quad \text{(C)}
\end{array}$$

This diagram commutes as each subdiagram commutes: (D1) commutes by the naturality of ρ , (D2) by the functoriality of the monoidal product in \mathcal{D} , (F1) by the unit axiom for the monoidal functor F , (F2) by the naturality of φ , and (C) due to the properties of colimits in \mathcal{C} and the functoriality of F .

We thus have a category. □

Remark 2.3. While at first glance it might seem surprising that we can construct a composition rule for decorations $s: I \rightarrow FN$ and $t: I \rightarrow FM$ just from monoidal structure, the copair $[j_N, j_M]: N + M \rightarrow N +_Y M$ of the pushout maps contains the data necessary to compose them. Indeed, this is the key insight of the decorated cospan construction. To wit, the coherence maps for the lax monoidal functor allow us to construct an element of $F(N + M)$ from the monoidal product $s \otimes t$ of the

decorations, and we may then post-compose with $F[j_N, j_M]$ to arrive at an element of $F(N +_Y M)$. The map $[j_N, j_M]$ encodes the identification of the image of Y in N with the image of the same in M , and so describes merging the ‘overlap’ of the two decorations.

2.2.2 The hypergraph structure

The main theorem of this chapter is that when *braided* monoidal structure is present, the category of decorated cospans is a hypergraph category, and moreover one into which the category of ‘undecorated’ cospans widely embeds. Indeed, this embedding motivates the monoidal and hypergraph structures we put on $FCospan$. This section is devoted to stating and proving this theorem.

Theorem 2.4. *Let \mathcal{C} be a category with finite colimits, (\mathcal{D}, \otimes) a braided monoidal category, and $(F, \varphi): (\mathcal{C}, +) \rightarrow (\mathcal{D}, \otimes)$ be a lax braided monoidal functor. Then we may give $FCospan$ a symmetric monoidal and hypergraph structure such that there is a wide embedding of hypergraph categories*

$$Cospan(\mathcal{C}) \hookrightarrow FCospan.$$

We first prove a lemma. Recall that the identity decorated cospan has apex decorated by $I \xrightarrow{\varphi_I} F\emptyset \xrightarrow{F!} FX$. Given any cospan $X \rightarrow N \leftarrow Y$, we call the decoration $I \xrightarrow{\varphi_I} F\emptyset \xrightarrow{F!} FN$ the **empty decoration** on N . For example, in the case of cospans of finite sets decorated by graphs, the empty decoration is simply the graph with no edges. Our lemma shows that empty decorations indeed are empty of content: when composed with other decorations, they have no impact.

Lemma 2.5. *Let*

$$(X \xrightarrow{i_X} N \xleftarrow{o_Y} Y, I \xrightarrow{s} FN),$$

be a decorated cospan, and suppose we have an empty-decorated cospan

$$(Y \xrightarrow{i_Y} M \xleftarrow{o_Z} Z, I \xrightarrow{\varphi \circ F!} FM).$$

Then the composite of these decorated cospans is

$$(X \xrightarrow{j_N \circ i_X} N +_Y M \xleftarrow{j_M \circ o_Z} Z, I \xrightarrow{F j_N \circ s} F(N +_Y M)).$$

In particular, the decoration on the composite is the decoration s pushed forward along the F -image of the map $j_N: N \rightarrow N +_Y M$ to become an F -decoration on $N +_Y M$. The analogous statement also holds for composition with an empty-decorated cospan on the left.

Proof. As is now familiar, a statement of this sort is proved by a large commutative diagram:

$$\begin{array}{ccccc}
 I & \xrightarrow{s} & FN & \xrightarrow{Fj_N} & F(N +_Y M) \\
 \rho_I^{-1} \searrow & & \nearrow \rho_{FN} & & \nearrow F\rho_N = F[1_N, !] \\
 & \text{(D1)} & & \text{(F1)} & \text{(C1)} \\
 & & & & F[j_N, !] \\
 I \otimes I & \xrightarrow{s \otimes 1} & FN \otimes I & \xrightarrow{1_{FN} \otimes \varphi_I} & FN \otimes F\emptyset & \xrightarrow{\varphi_{N, \emptyset}} & F(N + \emptyset) & \xrightarrow{F[j_N, !]} & F(N +_Y M) \\
 & & & & \text{(D2)} & \text{(F2)} & \text{(C2)} & & \\
 & & & & 1_{FN} \otimes F! & & F(1_N + !) & & \\
 & & & & \downarrow & & \downarrow & & \\
 & & & & FN \otimes FM & \xrightarrow{\varphi_{N, M}} & F(N + M) & & \\
 & & & & \text{(D2)} & & & & \\
 & & & & s \otimes (F! \circ \varphi_I) & & & & \\
 & & & & \downarrow & & & & \\
 & & & & FN \otimes FM & \xrightarrow{\varphi_{N, M}} & F(N + M) & & \\
 & & & & & & & &
 \end{array}$$

Note that identity decorated cospans are empty decorated. The subdiagrams in this diagram commute for the same reasons as their corresponding regions in the diagram for identity morphisms (see proof of Proposition 2.2). \square

Proof of Theorem 2.4. We first prove that we have a wide embedding of categories, and then use this to transfer monoidal and hypergraph structure onto $FCospan$.

Embedding. Define a functor

$$\text{Cospan}(\mathcal{C}) \hookrightarrow FCospan.$$

mapping each object of $\text{Cospan}(\mathcal{C})$ to itself as an object of $FCospan$, and each cospan in \mathcal{C} to the same cospan decorated with the empty decoration on its apex.

To check this is functorial, it suffices to check that the composite of two empty-decorated cospans is again empty-decorated. This is an immediate consequence of Lemma 2.5. Glancing at the definition, it is also clear that this functor is faithful and bijective-on-objects. We thus have a wide embedding $\text{Cospan}(\mathcal{C}) \hookrightarrow FCospan$.

Monoidal structure. We define the monoidal product of objects X and Y of $FCospan$ to be their coproduct $X + Y$ in \mathcal{C} , and define the monoidal product of decorated cospans

$$(X \xrightarrow{i_X} N \xleftarrow{o_Y} Y, I \xrightarrow{s} FN) \quad \text{and} \quad (X' \xrightarrow{i_{X'}} N' \xleftarrow{o_{Y'}} Y', I \xrightarrow{t} FN')$$

to be

$$\left(\begin{array}{ccc} & & F(N + N') \\ & \nearrow & \uparrow \varphi_{N,N'} \\ & N + N' & \uparrow s \otimes t \\ & \nwarrow & FN \otimes FN' \\ X + X' & & I \otimes I \\ & \searrow & \uparrow \lambda^{-1} \\ & & I \end{array} \right),$$

Using the braiding in \mathcal{D} , we can show that this proposed monoidal product is functorial.

Indeed, suppose we have decorated cospans

$$\begin{aligned} (X \xrightarrow{i_X} N \xleftarrow{o_Y} Y, I \xrightarrow{s} FN), & \quad (Y \xrightarrow{i_Y} M \xleftarrow{o_Z} Z, I \xrightarrow{t} FM), \\ (U \xrightarrow{i_U} P \xleftarrow{o_V} V, I \xrightarrow{u} FP), & \quad (V \xrightarrow{i_V} Q \xleftarrow{o_W} W, I \xrightarrow{v} FQ). \end{aligned}$$

We must check the so-called interchange law: that the composite of the column-wise monoidal products is equal to the monoidal product of the row-wise composites.

Again, for the cospans we take this equality as familiar fact. Write

$$b: (N + P) +_{(Y+V)} (M + Q) \xrightarrow{\sim} (N +_Y M) + (P +_V Q).$$

for the isomorphism between the two resulting representatives of the isomorphism class of cospans. The two resulting decorations are then given by the leftmost and rightmost columns respectively of the diagram below.

$$\begin{array}{ccc} F((N+P)+_{(Y+V)}(M+Q)) & \xrightarrow{Fb} & F((N+_Y M)+(P+_V Q)) \\ \uparrow & \text{(C)} & \uparrow \varphi_{N+_Y M, P+_V Q} \\ F((N+P)+(M+Q)) & & F(N+_Y M) \otimes F(P+_V Q) \\ \uparrow \varphi_{N+P, M+Q} & \text{(F2)} & \uparrow F[j_N, j_M] \otimes F[j_P, j_Q] \\ F(N+P) \otimes F(M+Q) & & F(N+M) \otimes F(P+Q) \\ \uparrow \varphi_{N,P} \otimes \varphi_{M,Q} & \text{(F1)} & \uparrow \varphi_{N,M} \otimes \varphi_{P,Q} \\ (FN \otimes FP) \otimes (FM \otimes FQ) & \xrightarrow{\quad} & (FN \otimes FM) \otimes (FP \otimes FQ) \\ \uparrow (s \otimes u) \otimes (t \otimes v) & \text{(D)} & \uparrow (s \otimes t) \otimes (u \otimes v) \\ (I \otimes I) \otimes (I \otimes I) & & \\ \uparrow (\lambda^{-1} \otimes \lambda^{-1}) \circ \lambda^{-1} & & \\ I & & \end{array}$$

These two decorations are related by the isomorphism b as the diagram commutes. We argue this more briefly than before, as the basic structure of these arguments is now familiar to us. Briefly then, there exist dotted arrows of the above types such that the subdiagram (D) commutes by the naturality of the associators and braiding in \mathcal{D} , (F1) commutes by the coherence diagrams for the braided monoidal functor F , (F2) commutes by the naturality of the coherence map φ for F , and (C) commutes by the properties of colimits in \mathcal{C} and the functoriality of F .

Using now routine methods, it also is straightforward to show that the monoidal product of identity decorated cospans on objects X and Y is the identity decorated cospan on $X + Y$; for the decorations this amounts to the observation that the monoidal product of empty decorations is again an empty decoration.

Choosing associator, unitors, and braiding in $F\text{Cospans}$ to be the images of those in $\text{Cospans}(\mathcal{C})$, we have a symmetric monoidal category. These transformations remain natural transformations when viewed in the category of F -decorated cospans as they have empty decorations.

We consider the case of the left unitor in detail; the naturality of the right unitor, associator, and braiding follows similarly, using the relevant axiom where here we use the left unitality axiom.

Given a decorated cospan $(X \xrightarrow{i} N \xleftarrow{o} Y, I \xrightarrow{s} FN)$, we must show that the square of decorated cospans

$$\begin{array}{ccc} X + \emptyset & \xrightarrow{i+1} & N + \emptyset \xleftarrow{i+1} Y + \emptyset \\ \lambda_{\mathcal{C}} \downarrow & & \downarrow \lambda_{\mathcal{C}} \\ X & \xrightarrow{i} & N \xleftarrow{o} Y \end{array}$$

commutes, where the $\lambda_{\mathcal{C}}$ are the maps of the left unitor in \mathcal{C} considered as empty-decorated cospans, the top cospan has decoration

$$I \xrightarrow{\lambda_{\mathcal{D}}^{-1}} I \otimes I \xrightarrow{s \otimes \varphi_I} FN \otimes F\emptyset \xrightarrow{\varphi_{N, \emptyset}} F(N + \emptyset),$$

and the lower cospan has decoration $I \xrightarrow{s} FN$.

Now as the λ are isomorphisms in \mathcal{C} and have empty decorations, the composite through the upper right corner is the decorated cospan

$$(X + \emptyset \xrightarrow{i+1} N + \emptyset \xleftarrow{(o+1) \circ \lambda_{\mathcal{C}}^{-1}} Y, I \xrightarrow{\varphi_{N, \emptyset} \circ (s \otimes \varphi_1) \circ \lambda_{\mathcal{D}}^{-1}} F(N + \emptyset)).$$

The composite through the lower left corner is the decorated cospan

$$(X + \emptyset \xrightarrow{[i, !]} N \xleftarrow{o} Y, 1 \xrightarrow{s} FN).$$

Then $\lambda_{\mathcal{C}}: N + \emptyset \rightarrow N$ gives an isomorphism between these two cospans, and the naturality of the left unitor and the left unitality axiom in \mathcal{D} imply that $\lambda_{\mathcal{C}}$ is in fact an isomorphism of decorated cospans:

$$\begin{array}{ccc}
 I & \xrightarrow{s} & FN \\
 \lambda_{\mathcal{D}}^{-1} \downarrow & \nearrow \lambda_{\mathcal{D}} & \uparrow F\lambda_{\mathcal{C}} \\
 I \otimes I & \xrightarrow{s \otimes 1} FN \otimes I \xrightarrow{1 \otimes \varphi_I} FN \otimes F\emptyset \xrightarrow{\varphi_{N, \emptyset}} & F(N + \emptyset).
 \end{array}$$

Thus λ is indeed a natural transformation; again the naturality of the remaining coherence maps can be proved similarly. Moreover, the coherence maps obey the required coherence laws as they are images of maps that obey these laws in $\text{Cospan}(\mathcal{C})$.

Hypergraph structure. Similarly, to arrive at the hypergraph structure on $FCospan$, we simply equip each object X with the image of the special commutative Frobenius monoid specified by the hypergraph structure of $\text{Cospan}(\mathcal{C})$. The axioms of hypergraph structure follow from the functoriality of our embedding. Moreover, it is evident that this choice of structures implies the above wide embedding is a hypergraph functor. \square

In summary, the hypergraph category $FCospan$ comprises:

The hypergraph category $(FCospan, +)$	
objects	the objects of \mathcal{C}
morphisms	isomorphism classes of F -decorated cospans in \mathcal{C}
composition	given by pushout
monoidal product	the coproduct in \mathcal{C}
coherence maps	maps from $\text{Cospan}(\mathcal{C})$ with empty decoration
hypergraph maps	maps from $\text{Cospan}(\mathcal{C})$ with empty decoration

Note that if the monoidal unit in (\mathcal{D}, \otimes) is the initial object, then each object only has one possible decoration: the empty decoration. This immediately implies the following corollary.

Corollary 2.6. *Let $1_{\mathcal{C}}: (\mathcal{C}, +) \rightarrow (\mathcal{C}, +)$ be the identity functor on a category \mathcal{C} with finite colimits. Then $\text{Cospan}(\mathcal{C})$ and $1_{\mathcal{C}}\text{Cospan}$ are isomorphic as hypergraph categories.*

Thus we see that there is always a hypergraph functor between decorated cospan categories $1_{\mathcal{C}}\text{Cospan} \rightarrow F\text{Cospan}$. This provides an example of a more general way to construct hypergraph functors between decorated cospan categories. We detail this in the next section. First though, we conclude this section by remarking on the bicategory of decorated cospans.

2.2.3 A bicategory of decorated cospans

As shown by Bénabou [Ben67], cospans are most naturally thought of as 1-morphisms in a bicategory. To obtain the category we are calling $\text{Cospan}(\mathcal{C})$, we ‘deategorify’ this bicategory by discarding 2-morphisms and identifying isomorphic 1-morphisms. This suggests that decorated cospans might also be most naturally thought of as 1-morphisms in a bicategory. Indeed this is the case.

Recall that a morphism of F -decorated cospans is a morphism n in \mathcal{C} such that the diagrams

$$\begin{array}{ccc}
 & N & \\
 i \nearrow & & \nwarrow o \\
 X & & Y \\
 i' \searrow & & \nearrow o' \\
 & N' &
 \end{array}
 \quad \text{and} \quad
 \begin{array}{ccc}
 & FN & \\
 s \nearrow & & \nwarrow \\
 1 & & FN' \\
 s' \searrow & & \nearrow \\
 & FN' &
 \end{array}$$

commute. Then Courser has proved the following proposition.

Proposition 2.7. *There exists a symmetric monoidal bicategory with:*

<i>The symmetric monoidal bicategory $(F\text{Cospan}, +)$</i>	
objects	<i>the objects of \mathcal{C}</i>
morphisms	<i>F-decorated cospans in \mathcal{C}</i>
2-morphisms	<i>morphisms of F-decorated cospans in \mathcal{C}</i>

Further details can be found in Courser’s paper [Cou]. These 2-morphisms could be employed to model transformations, coarse grainings, rewrite rules, and so on of open systems and their representations.

2.3 Functors between decorated cospan categories

Decorated cospans provide a setting for formulating various operations that we might wish to enact on the decorations, including the composition of these decorations, both sequential and monoidal, as well as dagger, dualising, and other operations afforded by

the hypergraph structure. In this section we observe that these operations are formulated in a systematic way, so that transformations of the decorating structure—that is, monoidal transformations between the lax monoidal functors defining decorated cospan categories—respect these operations.

Theorem 2.8. *Let $\mathcal{C}, \mathcal{C}'$ be categories with finite colimits, abusing notation to write the coproduct in each category $+$, and $(\mathcal{D}, \otimes), (\mathcal{D}', \boxtimes)$ be braided monoidal categories. Further let*

$$(F, \varphi): (\mathcal{C}, +) \longrightarrow (\mathcal{D}, \otimes) \quad \text{and} \quad (G, \gamma): (\mathcal{C}', +) \longrightarrow (\mathcal{D}', \boxtimes)$$

be lax braided monoidal functors. This gives rise to decorated cospan categories $FCospan$ and $GCospan$.

Suppose then that we have a finite colimit-preserving functor $A: \mathcal{C} \rightarrow \mathcal{C}'$ with accompanying natural isomorphism $\alpha: A(-) + A(-) \Rightarrow A(- + -)$, a lax monoidal functor $(B, \beta): (\mathcal{D}, \otimes) \rightarrow (\mathcal{D}', \boxtimes)$, and a monoidal natural transformation $\theta: (B \circ F, B\varphi \circ \beta) \Rightarrow (G \circ A, G\alpha \circ \gamma)$. This may be depicted by the diagram:

$$\begin{array}{ccc} (\mathcal{C}, +) & \xrightarrow{(F, \varphi)} & (\mathcal{D}, \otimes) \\ (A, \alpha) \downarrow & \not\cong_{\theta} & \downarrow (B, \beta) \\ (\mathcal{C}', +) & \xrightarrow{(G, \gamma)} & (\mathcal{D}', \boxtimes). \end{array}$$

Then we may construct a hypergraph functor

$$(T, \tau): FCospan \longrightarrow GCospan$$

mapping objects $X \in FCospan$ to $AX \in GCospan$, and morphisms

$$\left(\begin{array}{c} \begin{array}{ccc} & N & \\ i \nearrow & & \nwarrow o \\ X & & Y \end{array}, \quad \begin{array}{c} FN \\ \uparrow s \\ I_{\mathcal{D}} \end{array} \end{array} \right) \quad \text{to} \quad \left(\begin{array}{c} \begin{array}{ccc} & AN & \\ Ai \nearrow & & \nwarrow Ao \\ AX & & AY \end{array}, \quad \begin{array}{c} GAN \\ \uparrow \theta_N \\ BFN \\ \uparrow B_s \\ BI_{\mathcal{D}} \\ \uparrow \beta_I \\ I_{\mathcal{D}'} \end{array} \end{array} \right).$$

Moreover, (T, τ) is a strict monoidal functor if and only if (A, α) is.

Proof. We must prove that (T, τ) is a functor, is strong symmetric monoidal, and that it preserves the special commutative Frobenius structure on each object.

Functoriality. Checking the functoriality of T is again an exercise in applying the properties of structure available—in this case the colimit-preserving nature of A and the monoidality of (\mathcal{D}, \boxtimes) , (B, β) , and θ —to show that the relevant diagrams of decorations commute.

In detail, let

$$(X \xrightarrow{i_X} N \xleftarrow{o_Y} Y, I \xrightarrow{s} FN) \quad \text{and} \quad (Y \xrightarrow{i_Y} M \xleftarrow{o_Z} Z, I \xrightarrow{t} FM),$$

be morphisms in $FCospan$. As the composition of the cospan part is by pushout in \mathcal{C} in both cases, and as T acts as the colimit preserving functor A on these cospans, it is clear that T preserves composition of isomorphism classes of cospans. Write

$$c: AX +_{AY} AZ \xrightarrow{\sim} A(X +_Y Z)$$

for the isomorphism from the cospan obtained by composing the A -images of the above two decorated cospans to the cospan obtained by taking the A -image of their composite. To see that this extends to an isomorphism of decorated cospans, observe that the decorations of these two cospans are given by the rightmost and leftmost columns respectively in the following diagram:

$$\begin{array}{ccccc}
GA(N +_Y M) & \xleftarrow{\quad \overset{Gc}{\sim} \quad} & & & G(AN +_{AY} AM) \\
\uparrow \theta_{N+YM} & \swarrow GA[j_N, j_M] & & & \uparrow G[j_{AN}, j_{AM}] \\
BF(N +_Y M) & \xleftarrow{\quad \overset{(A)}{\sim} \quad} & GA(N + M) & \xleftarrow{\quad \overset{G\alpha}{\sim} \quad} & G(AN + AM) \\
\uparrow BF[j_N, j_M] & \nearrow \theta_{N, M} & & & \uparrow \gamma_{AN, AM} \\
BF(N + M) & & & & GAN \boxtimes GAM \\
\uparrow B\varphi_{N, M} & & & & \uparrow \theta_N \boxtimes \theta_M \\
B(FN \otimes FM) & \xleftarrow{\quad \beta_{FN, FM} \quad} & & & BFN \boxtimes BFM \\
\uparrow B(s \otimes t) & & & & \uparrow Bs \boxtimes Bt \\
B(I_{\mathcal{D}} \otimes I_{\mathcal{D}}) & \xleftarrow{\quad \beta_{I, I} \quad} & & & BI_{\mathcal{D}} \boxtimes BI_{\mathcal{D}} \\
\uparrow \beta \lambda_I^{-1} & \nearrow \beta_I \boxtimes 1 & & & \uparrow \beta_I \boxtimes \beta_I \\
BI_{\mathcal{D}} & \xrightarrow{\quad \lambda_{BI}^{-1} \quad} & I_{\mathcal{D}'} \boxtimes BI_{\mathcal{D}} & \xleftarrow{\quad 1 \boxtimes \beta_I \quad} & I_{\mathcal{D}'} \boxtimes I_{\mathcal{D}'} \\
\uparrow \beta & \nearrow \lambda_I^{-1} & & & \uparrow \lambda_I^{-1} \\
I_{\mathcal{D}'} & & & &
\end{array}$$

(D1)

Moreover, as A is coproduct-preserving and the Frobenius structures on $FCospan$ and $GCospan$ are built using various copairings of the identity map, (T, τ) preserves the hypergraph structure.

Finally, it is straightforward to observe that the maps τ are identity maps if and only if the maps α are, so (T, τ) is a strict monoidal functor if and only if (A, α) is. \square

When the decorating structure comprises some notion of topological diagram, such as a graph, these natural transformations θ might describe some semantic interpretation of the decorating structure. In this setting the above theorem might be used to construct semantic functors for the decorated cospan category of diagrams. It has the limitation, however, of only being able to construct semantic functors to other decorated cospan categories. Note that this idea of semantic functor is loosely inspired by, but not strictly the same as, Lawvere's functorial semantics [Law63].

2.4 Decorations in Set are general

So far we have let decorations lie in any braided monoidal category. While this gives us greater choice in the functors we may use for decorated cospan categories, if we are interested in constructing a particular hypergraph category as a decorated cospan category, it is more general than we need. In this section, we prove an observation of Sam Staton that it is general enough to let decorations lie in the symmetric monoidal category (Set, \times) of sets, functions, and the cartesian product.

The key observation is that decorated cospans only make use of the sets of monoidal elements $x: I \rightarrow X$ in the decorating category \mathcal{D} . To extract this information, use the covariant hom functor $\mathcal{D}(I, -): (\mathcal{D}, \otimes) \rightarrow (\text{Set}, \times)$. This takes each object X in \mathcal{D} to the homset $\mathcal{D}(I, X)$, and each morphism $f: X \rightarrow Y$ to the function

$$\begin{aligned} \mathcal{D}(I, f): \mathcal{D}(I, X) &\longrightarrow \mathcal{D}(I, Y); \\ x &\longmapsto f \circ x. \end{aligned}$$

Write $1 = \{\bullet\}$ for the monoidal unit of (Set, \times) .

Proposition 2.9. *Let (\mathcal{D}, \otimes) be a braided monoidal category. Define maps*

$$\begin{aligned} d_1: 1 &\longrightarrow \mathcal{D}(I, I); \\ \bullet &\longmapsto \text{id}_I \end{aligned}$$

and

$$\begin{aligned} d_{X,Y}: \mathcal{D}(I, X) \times \mathcal{D}(I, Y) &\longrightarrow \mathcal{D}(I, X \otimes Y); \\ (x, y) &\longmapsto (I \xrightarrow{\rho^{-1}} I \otimes I \xrightarrow{x \otimes y} X \otimes Y). \end{aligned}$$

These are natural in X and Y .

Furthermore, with these as coherence maps, the covariant hom functor on I , $\mathcal{D}(I, -): (\mathcal{D}, \otimes) \rightarrow (\text{Set}, \times)$, is a lax braided monoidal functor.

Proof. The naturality of the maps $d_{X,Y}$ follows from the naturality of ρ . The coherence axioms immediately follow from the coherence of the braided monoidal category \mathcal{D} . \square

Composing a decorating functor F with this hom functor produces an isomorphic decorated cospan category. Note that we write $\mathcal{D}(I, F-) = \mathcal{D}(I, -) \circ F$.

Proposition 2.10. *Let $F: (\mathcal{C}, +) \rightarrow (\mathcal{D}, \otimes)$ be a braided lax monoidal functor. Then $FCospan$ and $\mathcal{D}(I, F-)Cospan$ are isomorphic as hypergraph categories.*

Proof. We have the commutative-by-definition triangle of braided lax monoidal functors

$$\begin{array}{ccc} & & (\mathcal{D}, \otimes) \\ & \nearrow F & \downarrow \mathcal{D}(I, -) \\ (\mathcal{C}, +) & & (\text{Set}, \times) \\ & \searrow \mathcal{D}(I, F-) & \end{array}$$

By Theorem 2.8, this gives a strict hypergraph functor $FCospan \rightarrow \mathcal{D}(I, F-)Cospan$. It is easily observed that this functor is bijective on objects and on morphisms. \square

Similarly, taking Set to be our decorating category does not impinge upon the functors that can be constructed using decorated cospans.

Proposition 2.11. *Let $T: FCospan \rightarrow GCospan$ be a decorated cospans functor. Then there is a decorated cospans functor U such that the square of hypergraph functors*

$$\begin{array}{ccc} FCospan & \xrightarrow{T} & GCospan \\ \sim \downarrow & & \downarrow \sim \\ \mathcal{D}(I, F-)Cospan & \xrightarrow{U} & \mathcal{D}'(I, G-)Cospan \end{array}$$

commutes, where the vertical maps are the isomorphisms given by the previous proposition.

Proof. Write

$$\begin{array}{ccc} (\mathcal{C}, +) & \xrightarrow{(F, \varphi)} & (\mathcal{D}, \otimes) \\ (A, \alpha) \downarrow & \not\cong_{\theta} & \downarrow (B, \beta) \\ (\mathcal{C}', +) & \xrightarrow{(G, \gamma)} & (\mathcal{D}', \boxtimes). \end{array}$$

for the monoidal natural transformation yielding T , and write

$$\begin{aligned} \bar{\beta}_X: \mathcal{D}(I, X) &\longrightarrow \mathcal{D}'(I, BX); \\ (I_{\mathcal{D}} \xrightarrow{x} X) &\longmapsto (I_{\mathcal{D}'} \xrightarrow{\beta_I} BI_{\mathcal{D}} \xrightarrow{Bx} BX) \end{aligned}$$

for all $X \in \mathcal{D}$. This defines a monoidal natural transformation $\bar{\beta}: \mathcal{D}(I, -) \Rightarrow \mathcal{D}'(I, B-)$, with the monoidality following from the monoidality of the functor (B, β) .

Next, define U as the functor resulting from the decorated cospan construction applied to the horizontal composition of monoidal natural transformations

$$\begin{array}{ccccc} (\mathcal{C}, +) & \xrightarrow{(F, \varphi)} & (\mathcal{D}, \otimes) & \xrightarrow{\mathcal{D}(I, -)} & (\text{Set}, \times) \\ (A, \alpha) \downarrow & \not\cong_{\theta} & \downarrow (B, \beta) & \not\cong_{\bar{\beta}} & \parallel \\ (\mathcal{C}', +) & \xrightarrow{(G, \gamma)} & (\mathcal{D}', \boxtimes) & \xrightarrow{\mathcal{D}'(I, -)} & (\text{Set}, \times). \end{array}$$

To see that the required square of hypergraph functors commutes, observe that both functors $FCospan \rightarrow \mathcal{D}'(I, G-)\text{Cospan}$ take objects X to AX and morphisms

$$(X \xrightarrow{i} N \xleftarrow{o} Y, I \xrightarrow{s} FN)$$

to

$$(AX \xrightarrow{Ai} AN \xleftarrow{Ao} AY, \theta_N \circ Bs \circ \beta_I \in \mathcal{D}'(I, GAN)). \quad \square$$

Remark 2.12. Note that the braided monoidal categories $(\mathcal{C}, +)$ and (Set, \times) are both symmetric monoidal categories. As symmetric monoidal functors are just braided monoidal functors between symmetric monoidal categories, when working with the decorating category Set we may refer to the decorating functors F as symmetric lax monoidal, rather than merely braided lax monoidal.

Remark 2.13. When \mathcal{C} has finite colimits, call a lax symmetric monoidal functor $(\mathcal{C}, +) \rightarrow (\text{Set}, \times)$ a lax symmetric monoidal copresheaf on \mathcal{C} . A morphism between lax symmetric monoidal copresheaves F and G on categories \mathcal{C} and \mathcal{C}' with finite colimits is a colimit preserving functor $A: F \rightarrow G$ together with a monoidal natural transformation $\theta: F \Rightarrow G \circ A$. This forms a category.

The work in this chapter implies there exists a full and faithful functor from this category to the category of hypergraph categories, taking a lax symmetric monoidal copresheaf on a category with finite colimits to its decorated cospans category.

2.5 Examples

In this final section we outline two constructions of decorated cospan categories, based on labelled graphs and linear subspaces respectively, and a functor between these two categories interpreting each graph as an electrical circuit. We shall see that the decorated cospan framework allows us to take a notion of closed system and construct a corresponding notion of open or composable system, together with semantics for these systems.

This electrical circuits example is the motivating application for the decorated cospan construction, and its shortcomings motivate the further theoretical development of decorated cospans in the next chapter. Armed with these additional tools, we will return to the application for a full discussion in Chapter 6.

2.5.1 Labelled graphs

Recall that a $[0, \infty)$ -**graph** (N, E, s, t, r) comprises a finite set N of vertices (or nodes), a finite set E of edges, functions $s, t: E \rightarrow N$ describing the source and target of each edge, and a function $r: E \rightarrow [0, \infty)$ labelling each edge. The decorated cospan framework allows us to construct a category with, roughly speaking, these graphs as morphisms. More precisely, our morphisms will consist of these graphs, together with subsets of the nodes marked, with multiplicity, as ‘input’ and ‘output’ connection points.

Pick small categories equivalent to the category of $[0, \infty)$ -graphs such that we may talk about the set of all $[0, \infty)$ -graphs on each finite set N . Then we may consider the functor

$$\text{Graph}: (\text{FinSet}, +) \longrightarrow (\text{Set}, \times)$$

taking a finite set N to the set $\text{Graph}(N)$ of $[0, \infty)$ -graphs (N, E, s, t, r) with set of nodes N . On morphisms let it take a function $f: N \rightarrow M$ to the function that pushes labelled graph structures on a set N forward onto the set M :

$$\begin{aligned} \text{Graph}(f): \text{Graph}(N) &\longrightarrow \text{Graph}(M); \\ (N, E, s, t, r) &\longmapsto (M, E, f \circ s, f \circ t, r). \end{aligned}$$

As this map simply acts by post-composition, our map Graph is indeed functorial.

We then arrive at a lax braided monoidal functor (Graph, ζ) by equipping this functor with the natural transformation

$$\begin{aligned} \zeta_{N,M}: \text{Graph}(N) \times \text{Graph}(M) &\longrightarrow \text{Graph}(N + M); \\ ((N, E, s, t, r), (M, F, s', t', r')) &\longmapsto (N + M, E + F, s + s', t + t', [r, r']), \end{aligned}$$

together with the unit map

$$\begin{aligned} \zeta_1: 1 = \{\bullet\} &\longrightarrow \text{Graph}(\emptyset); \\ \bullet &\longmapsto (\emptyset, \emptyset, !, !, !), \end{aligned}$$

where we remind ourselves that we write $[r, r']$ for the copairing of the functions r and r' . The naturality of this collection of morphisms, as well as the coherence laws for lax braided monoidal functors, follow from the universal property of the coproduct.

Theorem 2.4 thus allows us to construct a hypergraph category GraphCospan . For an intuitive visual understanding of the morphisms of this category and its composition rule, see §2.1. The main idea is that composition glues together any pair of terminal that have the same preimage under the cospan maps. An identity morphism is the empty decorated identity cospan or, equivalently, a graph with no edges in which every vertex is both an input and an output:

$$\begin{array}{ccc} \bullet & \longrightarrow & \bullet & \longleftarrow & \bullet \\ & & & & \\ \bullet & \longrightarrow & \bullet & \longleftarrow & \bullet \\ X & & & & X \end{array}$$

The Frobenius maps are also empty decorated, with each node in the apex marked as input or output perhaps multiple or no times, as appropriate. For example, the Frobenius multiplication on a one element set Y is given by the decorated cospan:

$$\begin{array}{ccc} \bullet & & \bullet \\ & \searrow & \longleftarrow \\ \bullet & \longrightarrow & \bullet \\ & \nearrow & \\ \bullet & & \\ Y + Y & & Y \end{array}$$

2.5.2 Linear relations

Another example of a decorated cospan category arising from a functor $(\text{FinSet}, +) \rightarrow (\text{Set}, \times)$ is closely related to the category of linear relations. Here we decorate each

cospan in Set with a linear subspace of $\mathbb{R}^N \oplus (\mathbb{R}^N)^*$, the sum of the vector space generated by the apex N over \mathbb{R} and its vector space dual.

First let us recall some facts about relations. Let $R \subseteq X \times Y$ be a relation; we write this also as $R: X \rightarrow Y$. The opposite relation $R^{\text{op}}: Y \rightarrow X$, is the subset $R^{\text{op}} \subseteq Y \times X$ such that $(y, x) \in R^{\text{op}}$ if and only if $(x, y) \in R$. We say that the image of a subset $S \subseteq X$ under a relation $R: X \rightarrow Y$ is the subset of all elements of the codomain Y related by R to an element of S . Note that if X and Y are vector spaces and S and R are both linear subspaces, then the image $R(S)$ of S under R is again a linear subspace.

Now any function $f: N \rightarrow M$ induces a linear map $f^*: \mathbb{R}^M \rightarrow \mathbb{R}^N$ by precomposition. This linear map f^* itself induces a dual map $f_*: (\mathbb{R}^N)^* \rightarrow (\mathbb{R}^M)^*$ by precomposition. Furthermore f^* has, as a linear relation $f^* \subseteq \mathbb{R}^M \oplus \mathbb{R}^N$, an opposite linear relation $(f^*)^{\text{op}}: \mathbb{R}^N \rightarrow \mathbb{R}^M$. Define the functor

$$\text{LinSub}: (\text{FinSet}, +) \longrightarrow (\text{Set}, \times)$$

taking a finite set N to set of linear subspaces of the vector space $\mathbb{R}^N \oplus (\mathbb{R}^N)^*$, and taking a function $f: N \rightarrow M$ to the function $\text{LinSub}(N) \rightarrow \text{LinSub}(M)$ induced by the sum of these two relations:

$$\begin{aligned} \text{LinSub}(f): \text{LinSub}(N) &\longrightarrow \text{LinSub}(M); \\ L &\longmapsto ((f^*)^{\text{op}} \oplus f_*)(L). \end{aligned}$$

The above operations on f used in the construction of this map are functorial, and so it is readily observed that LinSub is indeed a functor.

It is moreover lax braided monoidal as the sum of a linear subspace of $\mathbb{R}^N \oplus (\mathbb{R}^N)^*$ and a linear subspace of $\mathbb{R}^M \oplus (\mathbb{R}^M)^*$ may be viewed as a subspace of $\mathbb{R}^N \oplus (\mathbb{R}^N)^* \oplus \mathbb{R}^M \oplus (\mathbb{R}^M)^* \cong \mathbb{R}^{N+M} \oplus (\mathbb{R}^{N+M})^* \cong \mathbb{R}^{M+N} \oplus (\mathbb{R}^{M+N})^*$, and the empty subspace is a linear subspace of each $\mathbb{R}^N \oplus (\mathbb{R}^N)^*$.

We thus have a hypergraph category LinSubCospan .

2.5.3 Electrical circuits

Electrical circuits and their diagrams are the motivating application for the decorated cospan construction. Specialising to the case of networks of linear resistors, we detail here how we may use the category LinSubCospan to provide semantics for the morphisms of GraphCospan as diagrams of networks of linear resistors.

Intuitively, after choosing a unit of resistance, say ohms (Ω), each $[0, \infty)$ -graph can be viewed as a network of linear resistors, with the $[0, \infty)$ -graph of §2.1 now more commonly depicted as

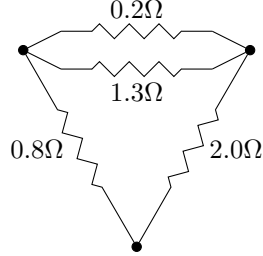

GraphCospan may then be viewed as a category with morphisms circuits of linear resistors equipped with chosen input and output terminals.

The suitability of this language is seen in the way the different categorical structures of GraphCospan capture different operations that can be performed with circuits. To wit, the sequential composition expresses the fact that we can connect the outputs of one circuit to the inputs of the next, while the monoidal composition models the placement of circuits side-by-side. Furthermore, the symmetric monoidal structure allows us reorder input and output wires, the compactness captures the interchangeability between input and output terminals of circuits—that is, the fact that we can choose any input terminal to our circuit and consider it instead as an output terminal, and vice versa—and the Frobenius structure expresses the fact that we may wire any node of the circuit to as many additional components as we like.

Moreover, Theorem 2.8 provides semantics. Each node in a network of resistors can be assigned an electric potential and a net current outflow at that node, and so the set N of vertices of a $[0, \infty)$ -graph can be seen as generating a space $\mathbb{R}^N \oplus (\mathbb{R}^N)^*$ of electrical states of the network. We define a natural transformation

$$\text{Res}: \text{Graph} \Longrightarrow \text{LinSub}$$

mapping each $[0, \infty)$ -graph on N , viewed as a network of resistors, to the linear subspace of $\mathbb{R}^N \oplus (\mathbb{R}^N)^*$ of electrical states permitted by Ohm's law.² In detail, let $\psi \in \mathbb{R}^N$. We define the power $Q: \mathbb{R}^N \rightarrow \mathbb{R}$ corresponding to a $[0, \infty)$ -graph (N, E, s, t, r) to be the function

$$Q(\psi) = \sum_{e \in E} \frac{1}{r(e)} \left(\psi(t(e)) - \psi(s(e)) \right)^2.$$

²Note that these states need not obey Kirchhoff's current law.

Then the states of a network of resistors are given by a potential ϕ on the nodes and the gradient of the power at this potential:

$$\begin{aligned} \text{Res}_N: \text{Graph}(N) &\longrightarrow \text{LinSub}(N) \\ (N, E, s, t, r) &\longmapsto \{(\phi, \nabla Q_\phi) \mid \phi \in \mathbb{R}^N\}. \end{aligned}$$

This defines a monoidal natural transformation. Hence, by Theorem 2.8, we obtain a hypergraph functor $\text{GraphCospan} \rightarrow \text{LinSubCospan}$.

The semantics provided by this functor match the standard interpretation of networks of linear resistors. The maps of the Frobenius monoid take on the interpretation of perfectly conductive wires, forcing the potentials at all nodes they connect to be equal, and the sum of incoming currents to equal the sum of outgoing currents—precisely the behaviour implied by Kirchhoff’s laws. More generally, let $(X \xrightarrow{i} N \xleftarrow{o} Y, (N, E, s, t, r))$ be a morphism of GraphCospan , with Q the power function corresponding to the graph $\Gamma = (N, E, s, t, r)$. The image of this decorated cospan in LinSubCospan is the decorated cospan $(X \xrightarrow{i} N \xleftarrow{o} Y, \{(\phi, \nabla Q_\phi) \mid \phi \in \mathbb{R}^N\})$. Then it is straightforward to check that the subspace

$$\text{LinSub}[i, o](\text{Res}_N(\Gamma)) \subseteq \mathbb{R}^{X+Y} \oplus (\mathbb{R}^{X+Y})^*$$

is the subspace of electrical states on the terminals $X + Y$ such that currents and potentials can be chosen across the network of resistors (N, E, s, t, r) that obey Ohm’s and, on its interior, Kirchhoff’s laws. In particular, after passing to a subspace of the terminals in this way, composition in LinSubCospan corresponds to enforcing Kirchhoff’s laws on the shared terminals of the two networks.

This behaviour at the terminals $X + Y$ is often all we are interested in: for example, in a large electrical network, substituting a subcircuit for a different subcircuit with the same terminal behaviour will not affect the rest of the network. Yet this terminal behaviour is not yet encoded directly in the categorical structure. The images of circuits in GraphCospan in LinSubCospan are cospans decorated by a subspace of $\mathbb{R}^N \oplus (\mathbb{R}^N)^*$, keeping track of *all* the internal behaviour as well. This can be undesirable, for reasons of information compression as well as reasoning about equivalence. The next chapter addresses this issue by introducing corelations.

Chapter 3

Corelations: a tool for black boxing

As we have seen, cospans are a useful tool for describing finite colimits, and so for describing the interconnection of systems. In the previous chapter we defined decorated cospans to take advantage of this fact and provide a tool for composing structures that had no inherent composition law, like graphs and subspaces. In many situations, however, the colimit contains more information than we care about. Rather than concerning ourselves with all the internal structure of a system, we only find a certain aspect of it relevant—roughly, the part that affects what happens at the boundary. This is better modelled by corelations. In this chapter we develop the theory of corelations.

As usual, we begin by giving an intuitive overview of the aims of this chapter in §3.1. We then give the formal details of corelation categories (§3.2) and their functors (§3.3), before concluding in §3.4 with two important examples: equivalence relations as epi-mono corelations in $(\text{Set}, +)$, and linear relations as epi-mono corelations in (Vect, \oplus) . This sets us up for a decorated version of this theory in Chapter 4.

3.1 The idea of black boxing

Thus far we have argued that network languages should be modelled using hypergraph categories, and shown that cospans provide a good language for talking about interconnection. We then developed the theory of decorated cospans, which allows us to take diagrams, mark ‘inputs’ and ‘outputs’ using cospans, and then compose these diagrams using pushouts. This turns a notion of closed system into a notion of open one.

A serious limitation of using cospans alone, however, is that cospans indiscriminately accumulate information. For example, suppose we consider the morphisms of

GraphCospan as open electrical circuits as in §2.5.3. Pursuing this, let us depict a graph decorated cospan from $(X \xrightarrow{i} N \xleftarrow{o} Y, (N, E, s, t, r))$ by

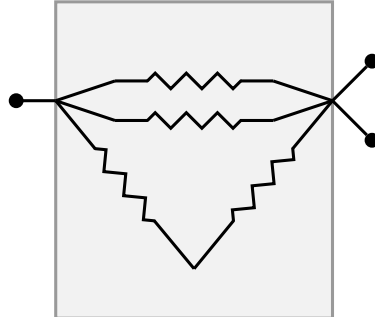

where the bullets \bullet on the left represent the elements of the set X , those on the right represent the elements of Y , and we draw a line from $x \in X$ or $y \in Y$ to a node n in the graph when $i(x) = n$ or $o(y) = n$. We omit the labels (resistances) on the edges as these are not essential to the main point here.

We also depict an example of composition of these open circuits using decorated cospans:

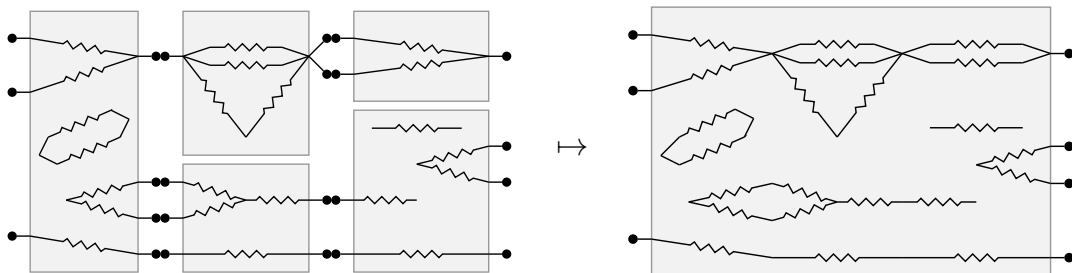

Note in particular that the composite of these open circuits contains a unique resistor for every resistor in the factors. If we are interested in describing the syntax of a diagrammatic language, then this is useful: composition builds given expressions into a larger one. If we are only interested in the semantics, however, this is often unnecessary and thus often wildly inefficient.

Indeed, suppose our semantics for open circuits is given by the information that can be gleaned by connecting other open circuits, such as measurement devices, to the terminals. In these semantics we consider two open circuits equivalent if, should

they be encased, but for their terminals, in a black box



we would be unable to distinguish them through our electrical investigations. In this case, at the very least, the previous circuit is equivalent to the circuit

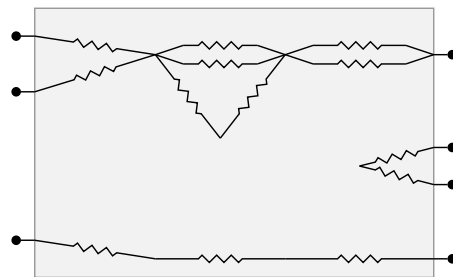

where we have removed circuitry not connected to the terminals. Moreover, this second circuit is a much more efficient representation, as it does not model inaccessible, internal structure. If we wish to construct a hypergraph category modelling the semantics of open circuits, we require circuit representations and a composition rule that only retain the information relevant to the black boxed circuit.

Dealing with this problem fully requires further discussion of the semantics of circuit diagrams, and the introduction of structures more flexible than graphs, such as linear relations. We deal with this in depth in Chapter 6. In this chapter, however, we are able to contribute an important piece of the puzzle: corelations.

Corelations allow us to pursue a notion of composition that discards extraneous information as we compose our systems. Consider, for example, the category $\text{Cospan}(\text{FinSet})$ of cospans in the category of finite sets and functions. A morphism is then a finite set N together with functions $X \rightarrow N$ and $Y \rightarrow N$. We depict these like so:

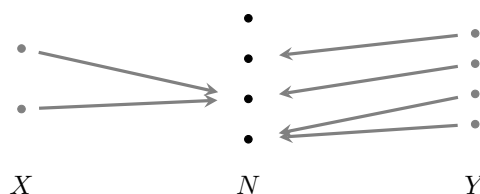

Here X is a two element set, while N and Y are four element sets.

Suppose we have a pair of cospans $X \rightarrow N \leftarrow Y$, $Y \rightarrow M \leftarrow Z$. By definition, their composite has apex the pushout $N +_Y M$ which, roughly speaking, is the union of N and M with two points identified if they are both images of the same element of Y . For example, the following pair of cospans:

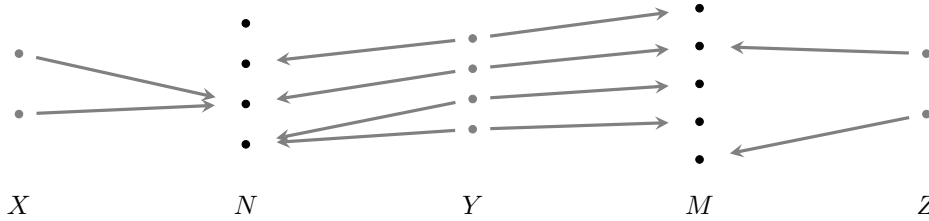

becomes

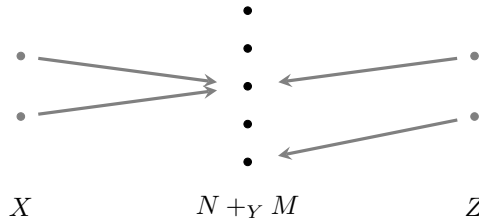

Here we see essentially the same phenomenon as we described for circuits above: the apex of the cospan is much larger than the image of the maps from the feet.

Corelations address this with what is known as a $(\mathcal{E}, \mathcal{M})$ -factorisation system. A factorisation system comprises subcategories \mathcal{E} and \mathcal{M} of \mathcal{C} such that every morphism in \mathcal{C} factors, in a coherent way, as the composite of a morphism in \mathcal{E} followed by a morphism in \mathcal{M} . An example, known as the epi-mono factorisation system on Set , is yielded by the observation that every function can be written as a surjection followed by an injection.

Corelations, or more precisely $(\mathcal{E}, \mathcal{M})$ -corelations, are cospans $X \rightarrow N \leftarrow Y$ such that the copairing $X + Y \rightarrow N$ of the two maps is an element of the first factor \mathcal{E} of the factorisation system. Composition of corelations proceeds first as composition of cospans, but then takes only the so-called \mathcal{E} -part of the composite cospan, to ensure the composite is again a corelation. If we take the \mathcal{E} -part of a cospan $X \rightarrow N \leftarrow Y$, we write the new apex \overline{N} , and so the resulting corelation $X \rightarrow \overline{N} \leftarrow Y$.

Mapping the above two cospans to epi-mono corelations in FinSet they become

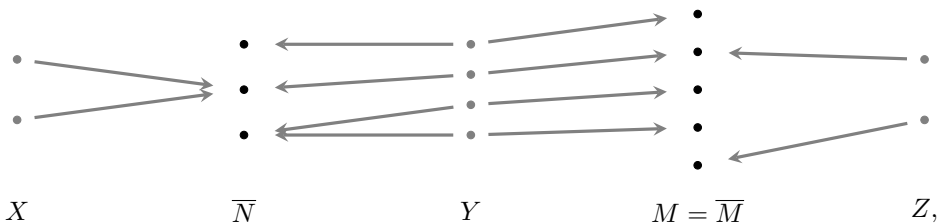

with composite

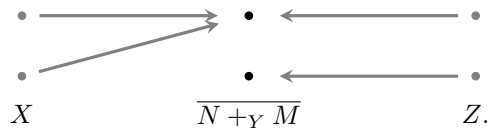

Note that the apex of the composite corelation is the subset of the apex of the composite cospan comprising those elements that are in the image of the maps from the feet. The intuition, again, is that composition of corelations discards irrelevant information—of course, exactly what it discards depends on our choice of factorisation system.

In this chapter we show that given a category \mathcal{C} with finite colimits and a factorisation system $(\mathcal{E}, \mathcal{M})$, if \mathcal{M} obeys a condition known as ‘stability under pushout’, then corelations in \mathcal{C} form a hypergraph category. We also show that given a colimit-preserving functor A between such categories $\mathcal{C}, \mathcal{C}'$ with factorisation systems $(\mathcal{E}, \mathcal{M}), (\mathcal{E}', \mathcal{M}')$, A induces a hypergraph functor between their corelation categories if the image of \mathcal{M} lies in \mathcal{M}' .

3.2 Corelations

Given sets X, Y , a relation $X \rightarrow Y$ is a subset of the product $X \times Y$. Note that by the universal property of the product, spans $X \leftarrow N \rightarrow Y$ are in one-to-one correspondence with functions $N \rightarrow X \times Y$. When this map is monic, we say that the span is *jointly monic*. More abstractly then, we might say a relation is an isomorphism class of jointly monic spans in the category of sets. Here we generalise the dual concept: these are our so-called corelations.

Relations and, equivalently, multi-valued functions have long been a structure of mathematical interest, with their formalisation going back to De Morgan [DeM60] and Pierce [Pie70] in the nineteenth century. One hundred years later, their category theoretic generalisation as subobjects of pairwise products was introduced by Puppe [Pup62] and Mac Lane [Mac63a] in the setting of abelian categories, and Barr [Bar70] for regular categories. Subsequently, Klein [Kle70] provided conditions under which these relations can be given an associative composition rule—albeit conditions slightly more restrictive than that which we use here—and by now the categorical theory of relations is well studied [FS90, Mil00, JW00]. The key insight is the definition of a factorisation system. We begin this section by introducing this idea, before developing the theory of not just categories of relations, but monoidal categories of (co)relations.

3.2.1 Factorisation systems

The relevant properties of jointly monic spans come from the fact that monomorphisms form one half of a factorisation system. A factorisation system allows any morphism in a category to be factored into the composite of two morphisms in a coherent way. This subsection introduces factorisation systems and monoidal factorisation systems.

Definition 3.1. A **factorisation system** $(\mathcal{E}, \mathcal{M})$ in a category \mathcal{C} comprises subcategories \mathcal{E}, \mathcal{M} of \mathcal{C} such that

- (i) \mathcal{E} and \mathcal{M} contain all isomorphisms of \mathcal{C} .
- (ii) every morphism $f \in \mathcal{C}$ admits a factorisation $f = m \circ e$, $e \in \mathcal{E}$, $m \in \mathcal{M}$.
- (iii) given morphisms f, f' , with factorisations $f = m \circ e$, $f' = m' \circ e'$ of the above sort, for every u, v such that the square

$$\begin{array}{ccc} & \xrightarrow{f} & \\ u \downarrow & & \downarrow v \\ & \xrightarrow{f'} & \end{array}$$

commutes, there exists a unique morphism s such that

$$\begin{array}{ccc} & \xrightarrow{e} & \xrightarrow{m} & \\ u \downarrow & & \exists! s & \downarrow v \\ & \xrightarrow{e'} & \xrightarrow{m'} & \end{array}$$

commutes.

Examples 3.2.

- Write $\mathcal{I}_{\mathcal{C}}$ for the wide subcategory of \mathcal{C} containing exactly the isomorphisms of \mathcal{C} . Then $(\mathcal{I}_{\mathcal{C}}, \mathcal{C})$ and $(\mathcal{C}, \mathcal{I}_{\mathcal{C}})$ are both factorisation systems in \mathcal{C} . While these may seem too trivial to mention, we will see they are of central importance in what follows.
- The prototypical example of a factorisation system is the epi-mono factorisation system (Sur, Inj) in Set . Here we write Sur for the subcategory of surjections in Set , and Inj for the subcategory of injections.

Recall that a split monomorphism is a map $m: X \rightarrow Y$ such that there exists a one-sided inverse, i.e. a map $m': Y \rightarrow X$ such that $m'm = \text{id}_X$. Observe that, assuming the axiom of choice, all monos in Set split. One way of proving that the above is a factorisation system on Set is via the more general fact, true in any category: if every arrow can be factorised as an epi followed by a split mono, then epimorphisms and split monomorphisms form the factors of a factorisation system. The only non-trivial part to check is the uniqueness condition: given epis e_1, e_2 , split monos m_1, m_2 , and commutative diagram

$$\begin{array}{ccc}
 & \xrightarrow{e_1} & \xrightarrow{m_1} \\
 u \downarrow & & \exists! t \\
 & \xrightarrow{e_2} & \xrightarrow{m_2} \\
 & & v \downarrow
 \end{array}$$

we must show that there is a unique t that makes the diagram commute. Indeed let $t = m'_2 v m_1$ where m'_2 satisfies $m'_2 m_2 = \text{id}$. To see that the right square commutes, observe

$$m_2 t e_1 = m_2 m'_2 v m_1 e_1 = m_2 m'_2 m_2 e_2 u = m_2 e_2 u = v m_1 e_1$$

and since e_1 is epi we have $m_2 t = v m_1$. For the left square,

$$t e_1 = m'_2 v m_1 e_1 = m'_2 m_2 e_2 u = e_2 u.$$

Uniqueness is immediate, since, e_1 is epi and m_2 is mono.

- Recall that a regular epimorphism is an epimorphism that is the coequaliser for some pair of parallel morphisms. (Dually, a regular monomorphism is an equaliser for some pair of parallel morphisms.) In any so-called regular category the regular epimorphisms and monomorphisms form a factorisation system. Examples of regular categories include Set , toposes, and abelian categories. Regular categories were introduced by Barr and Grillet; for more details see [Bar71, Gri71].

More details and further examples can be found in [AHS04, §14].

As we are concerned with building monoidal categories of corelations, it will be important that our factorisation systems are monoidal factorisation systems.

Definition 3.3. Call a factorisation system $(\mathcal{E}, \mathcal{M})$ in a monoidal category (\mathcal{C}, \otimes) a **monoidal factorisation system** if (\mathcal{E}, \otimes) is a monoidal category.

One might wonder why \mathcal{M} does not appear in the above definition. To give a touch more intuition for this definition, we quote a theorem of Ambler. Recall a symmetric monoidal closed category is one in which each functor $- \otimes X$ has a specified right adjoint $[X, -]$.

Proposition 3.4. *Let $(\mathcal{E}, \mathcal{M})$ be a factorisation system in a symmetric monoidal closed category (\mathcal{C}, \otimes) . Then the following are equivalent:*

- (i) $(\mathcal{E}, \mathcal{M})$ is a monoidal factorisation system.
- (ii) \mathcal{E} is closed under $- \otimes X$ for all $X \in \mathcal{C}$.
- (iii) \mathcal{M} is closed under $[X, -]$ for all $X \in \mathcal{C}$.

Proof. See Ambler for proof and further details [Amb91, Lemma 5.2.2]. \square

We need not worry too much, however, about the distinction between factorisation systems and monoidal factorisation systems. The reason is that for our purposes—where the underlying category \mathcal{C} has finite colimits and the monoidal product is the coproduct—all factorisation systems are monoidal factorisation systems. This is implied by the following lemma.

Lemma 3.5. *Let \mathcal{C} be a category with finite coproducts, and let $(\mathcal{E}, \mathcal{M})$ be a factorisation system on \mathcal{C} . Then $(\mathcal{E}, +)$ is a symmetric monoidal category.*

Proof. The only thing to check is that \mathcal{E} is closed under $+$. That is, given $f: A \rightarrow B$ and $g: C \rightarrow D$ in \mathcal{E} , we wish to show that $f + g: A + C \rightarrow B + D$, defined in \mathcal{C} , is also a morphism in \mathcal{E} .

Let $f + g$ have factorisation $A + C \xrightarrow{e} \overline{B + D} \xrightarrow{m} B + D$, where $e \in \mathcal{E}$ and $m \in \mathcal{M}$. We will prove that m is an isomorphism. To construct an inverse, recall that by definition, as f and g lie in \mathcal{E} , there exist morphisms $x: B \rightarrow \overline{B + D}$ and $y: D \rightarrow \overline{B + D}$ such that

$$\begin{array}{ccc} A & \xrightarrow{f} & B \xlongequal{\quad} B \\ \downarrow & & \vdots \scriptstyle{x} \\ A + C & \xrightarrow{e} & \overline{B + D} \xrightarrow{m} B + D \end{array} \quad \text{and} \quad \begin{array}{ccc} C & \xrightarrow{g} & D \xlongequal{\quad} D \\ \downarrow & & \vdots \scriptstyle{y} \\ A + C & \xrightarrow{e} & \overline{B + D} \xrightarrow{m} B + D \end{array} \quad (1)$$

The copairing $[x, y]$ is an inverse to m .

Indeed, taking the coproduct of the top rows of the two diagrams above and the copairings of the vertical maps gives the commutative diagram

$$\begin{array}{ccc} A + C & \xrightarrow{f+g} & B + D \quad \text{---} \quad B + D \\ \parallel & & \downarrow [x,y] \\ A + C & \xrightarrow{e} & \overline{B + D} \xrightarrow{m} B + D \end{array}$$

Reading the right-hand square immediately gives $m \circ [x, y] = 1$.

Conversely, to see that $[x, y] \circ m = 1$, remember that by definition $f + g = m \circ e$. So the left-hand square above implies that

$$\begin{array}{ccc} A + C & \xrightarrow{e} & \overline{B + D} \\ \parallel & & \downarrow [x,y] \circ m \\ A + C & \xrightarrow{e} & \overline{B + D} \end{array}$$

commutes. But by the universal property of factorisation systems, there is a unique map $\overline{B + D} \rightarrow \overline{B + D}$ such that this diagram commutes, and clearly the identity map also suffices. Thus $[x, y] \circ m = 1$. \square

3.2.2 Corelations

Now that we have introduced factorisation systems, observe that relations are just spans $X \leftarrow N \rightarrow Y$ in Set such that $N \rightarrow X \times Y$ is an element of Inj , the right factor in the factorisation system (Sur, Inj) . Relations may thus be generalised as spans such that the span maps jointly belong to some class \mathcal{M} of an $(\mathcal{E}, \mathcal{M})$ -factorisation system. We define corelations in the dual manner.

Definition 3.6. Let \mathcal{C} be a category with finite colimits, and let $(\mathcal{E}, \mathcal{M})$ be a factorisation system on \mathcal{C} . An $(\mathcal{E}, \mathcal{M})$ -**corelation** $X \rightarrow Y$ is a cospan $X \xrightarrow{i} N \xleftarrow{o} Y$ in \mathcal{C} such that the copairing $[i, o]: X + Y \rightarrow N$ lies in \mathcal{E} .

When the factorisation system is clear from context, we simply call $(\mathcal{E}, \mathcal{M})$ -corelations ‘corelations’.

We also say that a cospan $X \xrightarrow{i} N \xleftarrow{o} Y$ with the property that the copairing $[i, o]: X + Y \rightarrow N$ lies in \mathcal{E} is **jointly \mathcal{E} -like**. Note that if a cospan is jointly \mathcal{E} -like then so are all isomorphic cospans. Thus the property of being a corelation is closed under isomorphism of cospans, and we again are often lazy with our language, referring to both jointly \mathcal{E} -like cospans and their isomorphism classes as corelations.

If $f: A \rightarrow N$ is a morphism with factorisation $f = m \circ e$, write \overline{N} for the object such that $e: A \rightarrow \overline{N}$ and $m: \overline{N} \rightarrow N$. Now, given a cospan $X \xrightarrow{i_X} N \xleftarrow{o_Y} Y$, we may use the factorisation system to write the copairing $[i_X, o_Y]: X + Y \rightarrow N$ as

$$X + Y \xrightarrow{e} \overline{N} \xrightarrow{m} N.$$

From the universal property of the coproduct, we also have maps $\iota_X: X \rightarrow X + Y$ and $\iota_Y: Y \rightarrow X + Y$. We then call the corelation

$$X \xrightarrow{e \circ \iota_X} \overline{N} \xleftarrow{e \circ \iota_Y} Y$$

the **\mathcal{E} -part** of the above cospan. On occasion we will also write $e: X + Y \rightarrow \overline{N}$ for the same corelation.

Examples 3.7. Many examples of corelations are already familiar.

- For the morphism-isomorphism factorisation system $(\mathcal{C}, \mathcal{I}_{\mathcal{C}})$, corelations are just cospans.
- For the isomorphism-morphism factorisation $(\mathcal{I}_{\mathcal{C}}, \mathcal{C})$, jointly $\mathcal{I}_{\mathcal{C}}$ -like cospans $X \rightarrow Y$ are simply isomorphisms $X + Y \xrightarrow{\sim} N$. Thus there is a unique isomorphism class of corelations between any two objects.
- Note that the category \mathbf{Set} has finite colimits and an epi-mono factorisation system $(\mathbf{Sur}, \mathbf{Inj})$. Epi-mono corelations from $X \rightarrow Y$ in \mathbf{Set} are surjective functions $X + Y \rightarrow N$; thus their isomorphism classes are partitions, or equivalence relations on $X + Y$.

While this compositional structure on equivalence relations has not the prominence of that on relations, these corelations have been recognised as an important structure. Ellerman gives a detailed treatment from a logic viewpoint in [Ell14], while basic category theoretic aspects can be found in Lawvere and Rosebrugh [LR03]. Note that in these and in other sources, including [CF, BF], the term corelation is used to solely refer to these $(\mathbf{Sur}, \mathbf{Inj})$ -corelations in \mathbf{Set} , while here we use the term corelation primarily in the generalised sense.

Our next task is to define a composition rule on corelations.

3.2.3 Categories of corelations

We begin this subsection by defining a composition rule on isomorphism classes of corelations. The end goal, however, is to define a hypergraph category in which the morphisms are corelations. Here we will explain how to define such a category, introducing and exploring the important condition that \mathcal{M} is stable under pushout. We leave the proof that we have truly defined a hypergraph category for the next subsection.

We compose corelations by taking the \mathcal{E} -part of their composite cospan. That is, given corelations $X \xrightarrow{i_X} N \xleftarrow{o_Y} Y$ and $Y \xrightarrow{i_Y} M \xleftarrow{o_Z} Z$, their composite is given by the cospan $X \xrightarrow{e \circ i_X} \overline{N +_Y M} \xleftarrow{e \circ i_Z} Z$ in the commutative diagram

$$\begin{array}{ccccc}
 & & N +_Y M & & \\
 & & \uparrow & & \\
 & & \overline{N +_Y M} & & \\
 & & \uparrow & & \\
 & & X + Z & & \\
 & & \uparrow & & \\
 & & N & & M \\
 & \nearrow & \leftarrow & \rightarrow & \searrow \\
 X & & & & Y & & Z \\
 & \nwarrow & \leftarrow & \rightarrow & \swarrow & & \\
 & & X & & Y & & Z
 \end{array}$$

i_X (X to N), ι_X (X to X+Z), o_Y (Y to X+Z), i_Y (Y to M), ι_Z (Z to X+Z), o_Z (Z to M), j_N (N to N+Y M), j_M (M to N+Y M), e (X+Z to $\overline{N+Y M}$), m ($\overline{N+Y M}$ to N+Y M)

where $m \circ e$ is the $(\mathcal{E}, \mathcal{M})$ -factorisation of $[j_N \circ i_X, j_M \circ o_Z]: X + Z \rightarrow N +_Y M$.

It is well known that this composite is unique up to isomorphism, and that when \mathcal{M} is well behaved it defines a category with isomorphism classes of corelations as morphisms. For instance, a bicategorical version of the dual theorem, for spans and relations, can be found in [JW00]. Nonetheless, for the sake of completeness we will explain all the details and sketch our own argument here. The first fact to show is that, as we have just stated, the composite of corelations is unique up to isomorphism.

Proposition 3.8. *Let \mathcal{C} be a category with finite colimits and with a factorisation system $(\mathcal{E}, \mathcal{M})$. Then the above is a well-defined composition rule on isomorphism classes of corelations.*

Proof. Let $(X \xrightarrow{i_X} N \xleftarrow{o_Y} Y, X \xrightarrow{i'_X} N' \xleftarrow{o'_Y} Y)$ and $(Y \xrightarrow{i_Y} M \xleftarrow{o_Z} Z, Y \xrightarrow{i'_Y} M' \xleftarrow{o'_Z} Z)$ be pairs of isomorphic jointly \mathcal{E} -like cospans. By Proposition 2.2 their composites as *cospans* are isomorphic via an isomorphism $p: N +_Y M \rightarrow N' +_Y M'$.

The factorisation system then gives an isomorphism s such that the diagram

$$\begin{array}{ccccc}
 X + Z & \xrightarrow{e} & \overline{N +_Y M} & \xrightarrow{m} & N +_Y M \\
 \parallel & & \downarrow \sim s & & \downarrow \sim p \\
 X + Z & \xrightarrow{e'} & \overline{N' +_Y M'} & \xrightarrow{m'} & N' +_Y M'
 \end{array}$$

commutes. Thus s is an isomorphism of the composite corelations. \square

As we have said, this composition rule only gives a category when \mathcal{M} is well behaved. The reason is that composition of corelations is *not* associative in general. It is, however, associative when \mathcal{M} is stable under pushout. We now define this, provide some examples, and prove a crucial lemma.

Definition 3.9. Given a category \mathcal{C} , we say that a subcategory \mathcal{M} is **stable under pushout** if for every pushout square

$$\begin{array}{ccc}
 & \xrightarrow{j} & \\
 \uparrow & & \uparrow \\
 & \xrightarrow{m} &
 \end{array}$$

such that $m \in \mathcal{M}$, we also have that $j \in \mathcal{M}$.

Examples 3.10. There are many examples of $(\mathcal{E}, \mathcal{M})$ -factorisation systems with \mathcal{M} stable under pushout, including the factorisation systems $(\mathcal{I}_{\mathcal{C}}, \mathcal{C})$ and $(\mathcal{C}, \mathcal{I}_{\mathcal{C}})$ in \mathcal{C} , and (Sur, Inj) in Set .

This last example generalises to any topos. Indeed, Lack and Sobociński showed that monomorphisms are stable under pushout in any adhesive category [LS04]. Since any topos is both a regular category and an adhesive category [LS06, Lac11], the regular epimorphism-monomorphism factorisation system in any topos is an $(\mathcal{E}, \mathcal{M})$ -factorisation system with \mathcal{M} stable under pushout.

Another example is the dual of any regular category. Such a category is known as a coregular category, and is by definition a category that has finite colimits and an epimorphism-regular monomorphism factorisation system with regular monomorphisms stable under pushout. Examples of these include the category of topological spaces and continuous maps, as well as Set^{op} , any cotopos, and so on.

Stability under pushout is a powerful property. A key corollary, both for associativity and in general, is that it implies \mathcal{M} is also closed under $+$.

Lemma 3.11. *Let \mathcal{C} be a category with finite colimits, and let \mathcal{M} be a subcategory of \mathcal{C} stable under pushouts and containing all isomorphisms. Then $(\mathcal{M}, +)$ is a symmetric monoidal category.*

Proof. It is enough to show that for all morphisms $m, m' \in \mathcal{M}$ we have $m + m'$ in \mathcal{M} . Since \mathcal{M} contains all isomorphisms, the coherence maps are inherited from \mathcal{C} . The required axioms—the functoriality of the tensor product, the naturality of the coherence maps, and the coherence laws—are also inherited as they hold in \mathcal{C} .

To see $m + m'$ is in \mathcal{M} , simply observe that we have the pushout square

$$\begin{array}{ccc} A + C & \xrightarrow{m+1} & B + C \\ \uparrow \iota & & \uparrow \iota \\ A & \xrightarrow{m} & B \end{array}$$

in \mathcal{C} . As \mathcal{M} is stable under pushout, $m + 1 \in \mathcal{M}$. Similarly, $1 + m' \in \mathcal{M}$. Thus their composite $m + m'$ lies in \mathcal{M} , as required. \square

An analogous argument shows that pushouts of maps $m +_Y m'$ also lie in \mathcal{M} . Using this lemma it is not difficult to show associativity—the key point is that factorisation ‘commutes’ with pushouts, and that we have a category $\text{Corel}_{(\mathcal{E}, \mathcal{M})}(\mathcal{C})$. Again, this is all well known, and can be found in [JW00]. We will incidentally reprove these facts in the following, while pursuing richer structure.

Indeed, for modelling networks, we require not just a category, but a hypergraph category. Correlation categories come equipped with this extra structure. Recall that we gave decorated cospan categories a hypergraph structure by defining a wide embedding $\text{Cospan}(\mathcal{C}) \hookrightarrow F\text{Cospan}$, via which $F\text{Cospan}$ inherited the coherence and Frobenius maps (Theorem 2.4). We will argue similarly here, after showing that the map

$$\text{Cospan}(\mathcal{C}) \longrightarrow \text{Corel}(\mathcal{C})$$

taking each cospan to its jointly \mathcal{E} -like part is functorial. Indeed, we define the coherence and Frobenius maps of $\text{Corel}(\mathcal{C})$ to be their image under this map. For the monoidal product we again use the coproduct in \mathcal{C} ; the monoidal product of two corelations is their monoidal product as cospans.

Theorem 3.12. *Let \mathcal{C} be a category with finite colimits, and let $(\mathcal{E}, \mathcal{M})$ be a factorisation system on \mathcal{C} such that \mathcal{M} is stable under pushout. Then there exists a hypergraph category $\text{Corel}_{(\mathcal{E}, \mathcal{M})}(\mathcal{C})$ with*

<i>The hypergraph category $(\text{Corel}_{(\mathcal{E}, \mathcal{M})}(\mathcal{C}), +)$</i>	
<i>objects</i>	<i>the objects of \mathcal{C}</i>
<i>morphisms</i>	<i>isomorphism classes of $(\mathcal{E}, \mathcal{M})$-corelations in \mathcal{C}</i>
<i>composition</i>	<i>given by the \mathcal{E}-part of pushout</i>
<i>monoidal product</i>	<i>the coproduct in \mathcal{C}</i>
<i>coherence maps</i>	<i>inherited from $\text{Cospan}(\mathcal{C})$</i>
<i>hypergraph maps</i>	<i>inherited from $\text{Cospan}(\mathcal{C})$</i>

Again, we will drop explicit reference to the factorisation system when context allows, simply writing $\text{Corel}(\mathcal{C})$.

Examples 3.13. In each factorisation system of Examples 3.7 the right factor \mathcal{M} is stable under pushout. The hypergraph category $\text{Corel}_{(\mathcal{C}, \mathcal{I}_{\mathcal{C}})}(\mathcal{C})$ is just the hypergraph category of cospans in \mathcal{C} . In the hypergraph category $\text{Corel}_{(\mathcal{I}_{\mathcal{C}}, \mathcal{C})}(\mathcal{C})$, the only morphism between any two objects X and Y is the isomorphism class of the corelation $X \xrightarrow{!_X} X + Y \xleftarrow{!_Y} Y$ corresponding to the identity map $X + Y \rightarrow X + Y$ in $\mathcal{I}_{\mathcal{C}}$. Thus $\text{Corel}_{(\mathcal{I}_{\mathcal{C}}, \mathcal{C})}(\mathcal{C})$ is the indiscrete category on the objects of \mathcal{C} .

We discussed epi-mono corelations in FinSet informally in our motivation section §3.1. These are equivalence relations between finite sets. This example is perhaps the most instructive for black-boxing open systems, and we will return to it in §3.4.1.

Proposition 3.8 shows that our composition rule is a well-defined function; Lemma 3.5 shows likewise for the monoidal product $+: \text{Corel}(\mathcal{C}) \times \text{Corel}(\mathcal{C}) \rightarrow \text{Corel}(\mathcal{C})$. Thus we have the required data for a hypergraph category. It remains to check a number of axioms: associativity and unitality of the categorical composition, functoriality of the monoidal product, naturality of the coherence maps, the coherence axioms for symmetric monoidal categories, the Frobenius laws.

Our strategy for this will be to show that the surjective function from cospans to corelations defined by taking a cospan to its jointly \mathcal{E} -part preserves both composition and the monoidal product. This then implies that to evaluate an expression in the monoidal category of corelations, we may simply evaluate it in the monoidal category of cospans, and then take the \mathcal{E} -part. Thus if an equation is true for cospans, it is true for corelations.

Instead of proving just this, however, we will prove a generalisation regarding an analogous map between any two corelation categories. Such a map exists whenever we have two corelation categories $\text{Corel}_{(\mathcal{E}, \mathcal{M})}(\mathcal{C})$ and $\text{Corel}_{(\mathcal{E}', \mathcal{M}')}(\mathcal{C}')$ and a colimit

preserving functor $A: \mathcal{C} \rightarrow \mathcal{C}'$ such that the image of \mathcal{M} lies in \mathcal{M}' . As $(\mathcal{C}, \mathcal{I}_{\mathcal{C}})$ -corelations are just cospans, this reduces to the desired special case by taking the domain to be the category of $(\mathcal{C}, \mathcal{I}_{\mathcal{C}})$ -corelations, \mathcal{C}' to be equal to \mathcal{C} , and A to be the identity functor. But the generality is not spurious: it has the advantage of proving the existence of a class of hypergraph functors between corelation categories in the same fell swoop.

Although a touch convoluted, this strategy is worth the pause for thought. We will use it once again for *decorated* corelations, to great economy.

3.3 Functors between corelation categories

We have seen that to construct a functor between cospan categories one may start with a colimit-preserving functor between the underlying categories. Corelations are cospans where we forget the \mathcal{M} -part of each cospan. Hence for functors between corelation categories, we require not just a colimit-preserving functor but, loosely speaking, also that we don't forget too much in the domain category compared to the codomain category.

We devote the next few pages to proving the following proposition. Along the way we prove, as promised, that corelation categories are well-defined hypergraph categories.

Proposition 3.14. *Let $\mathcal{C}, \mathcal{C}'$ have finite colimits and respective factorisation systems $(\mathcal{E}, \mathcal{M}), (\mathcal{E}', \mathcal{M}')$, such that \mathcal{M} and \mathcal{M}' are stable under pushout. Further let $A: \mathcal{C} \rightarrow \mathcal{C}'$ be a functor that preserves finite colimits and such that the image of \mathcal{M} lies in \mathcal{M}' .*

Then we may define a hypergraph functor $\square: \text{Corel}(\mathcal{C}) \rightarrow \text{Corel}(\mathcal{C}')$ sending each object X in $\text{Corel}(\mathcal{C})$ to AX in $\text{Corel}(\mathcal{C}')$ and each corelation

$$X \xrightarrow{i_X} N \xleftarrow{o_Y} Y$$

to the \mathcal{E}' -part

$$AX \xrightarrow{e' \circ i_{AX}} \overline{AN} \xleftarrow{e' \circ i_{AY}} AY.$$

of the image cospan. The coherence maps are the \mathcal{E}' -part $\overline{\kappa_{X,Y}}$ of the isomorphisms $\kappa_{X,Y}: AX + AY \rightarrow A(X + Y)$ given as A preserves colimits.

As discussed, we still have to prove that $\text{Corel}(\mathcal{C})$ is a hypergraph category. We address this first with two lemmas regarding these proposed functors.

Lemma 3.15. *The above function $\square: \text{Corel}(\mathcal{C}) \rightarrow \text{Corel}(\mathcal{C}')$ preserves composition.*

Proof. Let $f = (X \longrightarrow N \longleftarrow Y)$ and $g = (Y \longrightarrow M \longleftarrow Z)$ be corelations in \mathcal{C} . By definition, the corelations $\square(g) \circ \square(f)$ and $\square(g \circ f)$ are given by the first arrows in the top and bottom row respectively of the diagram:

$$\begin{array}{ccccccc}
 AX+AZ & \xrightarrow{\mathcal{E}'} & \overline{AN+AYAM} & \xrightarrow{\mathcal{M}'} & \overline{AN+AYAM} & \xrightarrow{m'_{AN}+AYm'_{AM}} & AN+AYAM \\
 \parallel & & \uparrow \scriptstyle n & & & & \downarrow \scriptstyle \sim \\
 AX+AZ & \xrightarrow{\mathcal{E}'} & \overline{A(N+YM)} & \xrightarrow{\mathcal{M}'} & A(N+YM) & \xrightarrow{Am_{N+YM}} & A(N+YM)
 \end{array} \quad (*)$$

The morphisms labelled \mathcal{E}' lie in \mathcal{E}' , and similarly for \mathcal{M}' ; these are given by the factorisation system on \mathcal{C}' . The maps Am_{N+YM} and $m'_{AN} + AY m'_{AM}$ lie in \mathcal{M}' too: Am_{N+YM} as it is in the image of \mathcal{M} , and $m'_{AN} + AY m'_{AM}$ as \mathcal{M}' is stable under pushout.

Moreover, the diagram commutes as both maps $AX+AZ \rightarrow AN+AYAM$ compose to that given by the pushout of the images of f and g over AY . Thus the diagram represents two $(\mathcal{E}', \mathcal{M}')$ factorisations of the same morphism, and there exists an isomorphism n between the corelations $\square(g) \circ \square(f)$ and $\square(g \circ f)$. This proves that \square preserves composition. \square

This first lemma allows us to verify the associativity and unit laws for $\text{Corel}(\mathcal{C})$.

Corollary 3.16. *Corel(\mathcal{C}) is well defined as a category.*

Proof. Consider the case of Proposition 3.14 with $\mathcal{C} = \mathcal{C}'$, $(\mathcal{E}, \mathcal{M}) = (\mathcal{C}, \mathcal{I}_{\mathcal{C}})$, and $A = 1_{\mathcal{C}}$. Then the domain of \square is $\text{Cospan}(\mathcal{C})$ by definition. In this case, the function $\square: \text{Cospan}(\mathcal{C}) \rightarrow \text{Corel}(\mathcal{C})$ is bijective-on-objects and surjective-on-morphisms. Thus to compute the composite of any two corelations, we may consider them as cospans, compute their composite *as cospans*, and then take the \mathcal{E} -part of the result. Since composition of cospans is associative and unital, so is composition of corelations, with the identity corelation just the image of the identity cospan. \square

Note that the identity in $\text{Corel}(\mathcal{C})$ may not be the identity cospan itself. For example, with the factorisation system $(\mathcal{I}_{\mathcal{C}}, \mathcal{C})$ the $\mathcal{I}_{\mathcal{C}}$ -part of the identity cospan is simply $X \xrightarrow{\iota_{X_1}} X + X \xleftarrow{\iota_{X_2}} X$, where ι_{X_i} is the inclusion of X into the X_i factor of the coproduct $X + X$.

This first lemma is also useful in proving the second important lemma: the naturality of $\bar{\kappa}$.

Lemma 3.17. *The maps $\overline{\kappa_{X,Y}}$, as defined in Proposition 3.14, are natural.*

Proof. Let $f = (X \longrightarrow N \longleftarrow Y)$, $g = (Z \longrightarrow M \longleftarrow W)$ be corelations in \mathcal{C} . We wish to show that

$$\begin{array}{ccc} AX + AY & \xrightarrow{\square(f) + \square(g)} & AZ + AW \\ \bar{\kappa}_{X,Y} \downarrow & & \downarrow \bar{\kappa}_{Z,W} \\ A(X + Y) & \xrightarrow{\square(f+g)} & A(Z + W) \end{array}$$

commutes in $\text{Corel}(\mathcal{C}')$.

Consider the following commutative diagram in \mathcal{C}' , with the outside square equivalent to the naturality square for the coherence maps of the monoidal functor $\text{Cospan}(\mathcal{C}) \rightarrow \text{Cospan}(\mathcal{C}')$:

$$\begin{array}{ccccc} (AX + AY) + (AZ + AW) & \xrightarrow{\mathcal{E}' + \mathcal{E}'} & \overline{AN} + \overline{AM} & \xrightarrow{\mathcal{M}' + \mathcal{M}'} & AN + AM \\ \bar{\kappa}_{X,Y} + \bar{\kappa}_{Z,W} \downarrow & & \downarrow p & & \downarrow \bar{\kappa}_{N,M} \\ A(X + Y) + A(Z + W) & \xrightarrow{\mathcal{E}'} & \overline{A(N + M)} & \xrightarrow{\mathcal{M}'} & A(N + M) \end{array} \quad (\#)$$

We have factored the top edge as the coproduct of the respective factorisations of f and g , and the bottom edge simply as the factorisation of the coproduct $f + g$.

Note that by Lemma 3.5 the coproduct of two maps in \mathcal{E}' is again in \mathcal{E}' , while Lemma 3.11 implies the same for \mathcal{M}' . Thus the top edge is an $(\mathcal{E}', \mathcal{M}')$ -factorisation, and the uniqueness of factorisations gives the isomorphism n . Given that the map reducing cospans to corelations is functorial, the commutative square

$$\begin{array}{ccc} (AX + AY) + A(Z + W) & \xrightarrow{1 + \bar{\kappa}_{Z,W}^{-1}} & (AX + AY) + (AZ + AW) \xrightarrow{\mathcal{E}' + \mathcal{E}'} \overline{AN} + \overline{AM} \\ \parallel & & \downarrow n \\ (AX + AY) + A(Z + W) & \xrightarrow{\bar{\kappa}_{X,Y} + 1} & A(X + Y) + A(Z + W) \xrightarrow{\mathcal{E}'} \overline{A(N + M)} \end{array}$$

then implies the naturality of the maps $\bar{\kappa}$. \square

These lemmas now imply that $\text{Corel}(\mathcal{C})$ is a well-defined hypergraph category.

Proof of Theorem 3.12. To complete the proof then, again consider the case of Proposition 3.14 with $\mathcal{C} = \mathcal{C}'$, $(\mathcal{E}, \mathcal{M}) = (\mathcal{C}, \mathcal{I}_{\mathcal{C}})$, and $A = 1_{\mathcal{C}}$. Note that by definition this function maps the coherence and hypergraph maps of $\text{Cospan}(\mathcal{C})$ onto the corresponding maps of $\text{Corel}(\mathcal{C})$. As $\text{Cospan}(\mathcal{C})$ is a hypergraph, and \square preserves composition and respects the monoidal and hypergraph structure, $\text{Corel}(\mathcal{C})$ is also a hypergraph category.

For instance, suppose we want to check the functoriality of the monoidal product $+$. We then wish to show $(g \circ f) + (k \circ h) = (g + k) \circ (f + h)$ for corelations of the appropriate types. But \square preserves composition, and the naturality of κ , here the identity map, implies that for any two cospans the \mathcal{E} -part of their coproduct is equal to the coproduct of their \mathcal{E} -parts. Thus we may compute these two expressions by viewing f , g , h , and k as cospans, evaluating them in the category of cospans, and then taking their \mathcal{E} -parts. Since the equality holds in the category of cospans, it holds in the category of corelations. \square

Corollary 3.18. *There is a strict hypergraph functor*

$$\square: \text{Cospan}(\mathcal{C}) \longrightarrow \text{Corel}(\mathcal{C})$$

that takes each object of $\text{Cospan}(\mathcal{C})$ to itself as an object of $\text{Corel}(\mathcal{C})$ and each cospan to its \mathcal{E} -part.

Finally, we complete the proof that \square is always a hypergraph functor.

Proof of Proposition 3.14. We show \square is a functor, a symmetric monoidal functor, and then finally a hypergraph functor.

Functoriality. First, recall that \square preserves composition (Lemma 3.15). Thus to prove \square is a functor it remains to show identities are mapped to identities. The general idea for this and for similar axioms is to recall that the special maps are given by reduced versions of particular colimits, and that $(\mathcal{E}', \mathcal{M}')$ reduces maps more than $(\mathcal{E}, \mathcal{M})$.

In this case, recall the identity corelation is given by the \mathcal{E} -part $X + X \rightarrow \overline{X}$ of $[1, 1]: X + X \rightarrow X$. Thus the image of the identity on X and the identity on AX are given by the top and bottom rows of the commuting square

$$\begin{array}{ccccccc} A(X + X) & \xrightarrow{\mathcal{E}'} & \overline{AX} & \xrightarrow{\mathcal{M}'} & AX & \xrightarrow{A\mathcal{M}} & AX \\ \sim \downarrow \kappa^{-1} & & \downarrow n & & & & \parallel \\ AX + AX & \xrightarrow{\mathcal{E}'} & \overline{AX} & \xrightarrow{\mathcal{M}'} & AX & & AX \end{array}$$

The outside square commutes as we know A maps the identity cospan of \mathcal{C} to the identity cospan of \mathcal{C}' . The top row is the image under A of the identity cospan in \mathcal{C} , factored first in \mathcal{C} , and then in \mathcal{C}' . The bottom row is just the factored identity cospan on AX in \mathcal{C}' . As A maps \mathcal{M} into \mathcal{M}' , the map marked $A\mathcal{M}$ lies in \mathcal{M}' . Thus both rows are $(\mathcal{E}', \mathcal{M}')$ -factorisations, and so we have the isomorphism n . Thus \square preserves identities.

Strong monoidality. We proved in Lemma 3.17 that our proposed coherence maps are natural. The rest of the properties follow from the composition preserving map $\text{Cospan}(\mathcal{C}') \rightarrow \text{Corel}(\mathcal{C}')$. Since the κ obey all the required axioms as cospans, they obey them as corelations too.

Hypergraph structure. The proof of preservation of the hypergraph structure follows the same pattern as the identity maps. \square

Example 3.19. In the notation of Proposition 3.14, note that if both $(\mathcal{E}, \mathcal{M})$ and $(\mathcal{E}', \mathcal{M}')$ are epi-split mono factorisations, then we always have that $A(\mathcal{M}) \subseteq \mathcal{M}'$. Indeed, if an (one-sided) inverse exists in the domain category, it exists in the codomain category. Thus colimit-preserving functors between categories with finite colimits and epi-split mono factorisation systems also induce a functor between the epi-split mono corelation categories. We will use this in Chapter 5.

Remark 3.20. On any category \mathcal{C} with finite colimits, reverse inclusions of the right factor \mathcal{M} defines a partial order on the set of factorisation systems $(\mathcal{E}, \mathcal{M})$ with \mathcal{M} stable under pushout. That is, we write $(\mathcal{E}, \mathcal{M}) \geq (\mathcal{E}, \mathcal{M}')$ whenever $\mathcal{M} \subseteq \mathcal{M}'$. The trivial factorisation systems $(\mathcal{C}, \mathcal{I}_{\mathcal{C}})$ and $(\mathcal{I}_{\mathcal{C}}, \mathcal{C})$ are the top and bottom elements of this poset respectively.

Corelation categories realise this poset as a subcategory of the category of hypergraph categories. One way to understand this is that corelations are cospans with the \mathcal{M} -part ‘forgotten’. Using a morphism-isomorphism factorisation system nothing is forgotten, so these corelations are just cospans. Using the isomorphism-morphism factorisation system everything is forgotten, so there is a unique corelation between any two objects.

We can construct a hypergraph functor between two corelation categories if the codomain forgets more than the domain: i.e. if the codomain is less than the domain in the poset. In particular, this implies there is always a hypergraph functor from the cospan category $\text{Corel}_{(\mathcal{C}, \mathcal{I}_{\mathcal{C}})}(\mathcal{C}) = \text{Cospan}(\mathcal{C})$ to any other corelation category $\text{Corel}_{(\mathcal{E}, \mathcal{M})}(\mathcal{C})$, and from $\text{Corel}_{(\mathcal{E}, \mathcal{M})}(\mathcal{C})$ any corelation category to the indiscrete category $\text{Corel}_{(\mathcal{I}_{\mathcal{C}}, \mathcal{C})}(\mathcal{C})$ on the objects of \mathcal{C} .

3.4 Examples

We conclude this chapter with two examples of corelation categories. These both play a central role in the applications of Part II: the first as an algebra of ideal wires, and the second as semantics for signal flow graphs.

3.4.1 Equivalence relations as corelations in Set

As we saw in Examples 3.13, an epi-mono corelation $X \rightarrow Y$ in Set is an equivalence relation on $X + Y$. We might depict these as follows

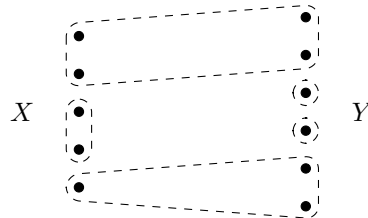

Here we have a corelation from a set X of five elements to a set Y of six elements. Elements belonging to the same equivalence class of $X + Y$ are grouped (‘connected’) by a dashed line.

Composition of corelations first takes the transitive closure of the two partitions (the pushout in Set), before restricting the partition to the new domain and codomain (restricting to the jointly epic part). For example, suppose in addition to the corelation $\alpha: X \rightarrow Y$ above we have another corelation $\beta: Y \rightarrow Z$

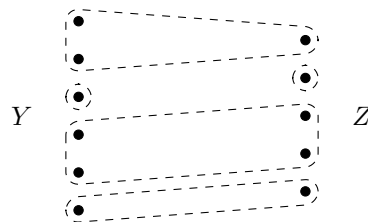

Then the composite $\beta \circ \alpha$ of our two corelations is given by

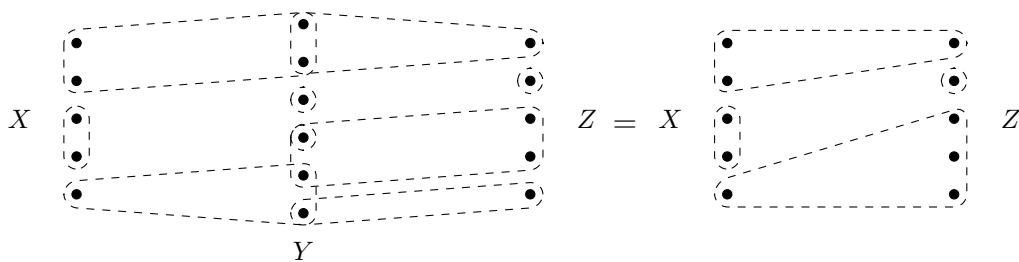

Informally, this captures the idea that two elements of $X + Z$ are ‘connected’ if we may travel from one to the other staying within connected components of α and β .

For a greater resemblance of the diagrams in the motivating comments of §3.1, epi-mono corelations in Set can also be visualised as terminals connected by junctions of ideal wires. We draw these by marking each equivalence class with a point (the ‘junction’), and then connecting each element of the domain and codomain to their

equivalence class with a ‘wire’. The junction serves as the apex of the corelation, the terminals as the feet, and the wires depict a function from the feet to the apex. Composition then involves collapsing connected junctions down to a point.

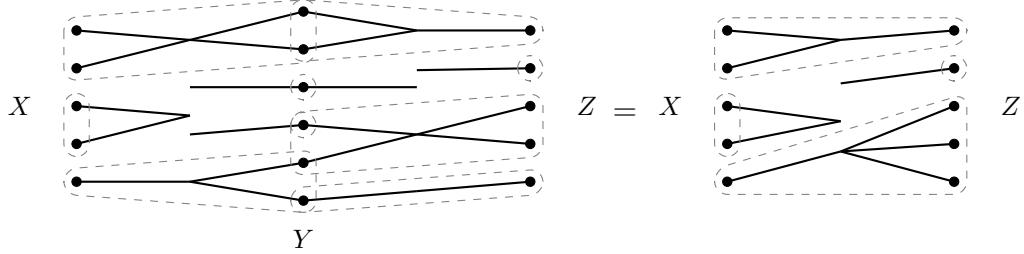

The composition law captures the idea that connectivity is all that matters: as long as the wires are ‘ideal’, the exact path does not matter.

In Coya–Fong [CF] we formalise this idea by saying that corelations are the prop for extraspecial commutative Frobenius monoids. An **extraspecial commutative Frobenius monoid** $(X, \mu, \eta, \delta, \epsilon)$ in a monoidal category (\mathcal{C}, \otimes) is a special commutative Frobenius monoid that further obeys the extra law

$$\bullet \text{---} \bullet =$$

Two morphisms built from the generators of an extraspecial commutative Frobenius monoid are equal and if and only if their diagrams impose the same connectivity relations on the disjoint union of the domain and codomain. This is an extension of the spider theorem for special commutative Frobenius monoids.

3.4.2 Linear relations as corelations in Vect

Recall that a linear relation $L: U \rightsquigarrow V$ is a subspace $L \subseteq U \oplus V$. We compose linear relations as we do relations, and vector spaces and linear relations form a category LinRel . It is straightforward to show that this category can be constructed as the category of relations in the category Vect of vector spaces and linear maps with respect to epi-mono factorisations: monos in Vect are simply injective linear maps, and hence subspace inclusions. We show that they may also be constructed as corelations in Vect with respect to epi-mono factorisations.

If we restrict to the full subcategory FinVect of finite dimensional vector spaces duality makes this easy to see: after picking a basis for each vector space the transpose yields an equivalence of FinVect with its opposite category, so the category of $(\mathcal{E}, \mathcal{M})$ -corelations (jointly epic cospans) is isomorphic to the category of $(\mathcal{E}, \mathcal{M})$ -relations

(jointly monic spans) in FinVect . This fact has been fundamental in work on finite dimensional linear systems and signal flow diagrams [BE15, BSZ14, FRS16].

We prove the general case in detail. To begin, note Vect has an epi-mono factorisation system with monos stable under pushouts. This factorisation system is inherited from Set : the epimorphisms in Vect are precisely the surjective linear maps, the monomorphisms are the injective linear maps, and the image of a linear map is always a subspace of the codomain, and so itself a vector space. Monos are stable under pushout as the pushout of a diagram $V \xleftarrow{f} U \xrightarrow{m} W$ is $V \oplus W / \text{Im}[f - m]$. The map $m': V \rightarrow V \oplus W / \text{Im}[f - m]$ into the pushout has kernel $f(\ker m)$. Thus when m is a monomorphism, m' is too.

Thus we have a category of corelations $\text{Corel}(\text{Vect})$. We show that the map $\text{Corel}(\text{Vect}) \rightarrow \text{LinRel}$ sending each vector space to itself and each corelation

$$U \xrightarrow{f} A \xleftarrow{g} V$$

to the linear subspace $\ker[f - g]$ is a full, faithful, and bijective-on-objects functor.

Indeed, corelations $U \xrightarrow{f} A \xleftarrow{g} V$ are in one-to-one correspondence with surjective linear maps $U \oplus V \rightarrow A$, which are in turn, by the isomorphism theorem, in one-to-one correspondence with subspaces of $U \oplus V$. These correspondences are described by the kernel construction above. Thus our map is evidently full, faithful, and bijective-on-objects. It also maps identities to identities. It remains to check that it preserves composition.

Suppose we have corelations $U \xrightarrow{f} A \xleftarrow{g} V$ and $V \xrightarrow{h} B \xleftarrow{k} W$. Then their pushout is given by $P = A \oplus B / \text{Im}[g - h]$, and we may draw the pushout diagram

$$\begin{array}{ccccc}
 U & & V & & W \\
 \searrow f & & \swarrow g & \searrow h & \swarrow k \\
 & A & & B & \\
 & \swarrow \iota_A & \hat{} & \swarrow \iota_B & \\
 & & P & &
 \end{array}$$

We wish to show the equality of relations

$$\ker[f - g]; \ker[h - k] = \ker[\iota_A f - \iota_B g].$$

Now $(\mathbf{u}, \mathbf{w}) \in U \oplus W$ lies in the composite relation $\ker[f - g]; \ker[h - k]$ iff there exists $\mathbf{v} \in V$ such that $f\mathbf{u} = g\mathbf{v}$ and $h\mathbf{v} = k\mathbf{w}$. But as P is the pushout, this is true iff

$$\iota_A f\mathbf{u} = \iota_A g\mathbf{v} = \iota_B h\mathbf{v} = \iota_B k\mathbf{w}.$$

This in turn is true iff $(\mathbf{u}, \mathbf{w}) \in \ker[\iota_A f - \iota_B k]$, as required.

This correlations perspective is important as it fits the relational picture into our philosophy of black boxing. In Chapter 5 we will see it is the correlation construction of LinRel that correctly generalises to the case of non-controllable systems.

In the next chapter we discuss decorations on correlations.

Chapter 4

Decorated corelations: black-boxed open systems

When enough structure is available to us, we may decorate corelations too. Furthermore, and key to the idea of ‘black-boxing’, we get a hypergraph functor from decorated cospans to decorated corelations. This assists with constructing hypergraph categories of semantics for network-style diagrammatic languages. Indeed, we will prove that every hypergraph category can be constructed using decorated corelations, and so can every hypergraph functor.

In the next section we motivate this chapter by discussing how to construct the category of matrices using decorations, illustrating the shortcomings of decorated cospans and how they are overcome by decorated corelations. As usual, we then use the subsequent two sections to get into the technical details, defining decorated corelations (§4.2) and their functors (§4.3). This sets us up to state and prove the climactic theorem of Part I: roughly, decorated corelations are powerful enough to construct all hypergraph categories and functors. We do this in §4.4. Finally, in §4.5, we give some examples.

4.1 Black-boxed open systems

Suppose we have devices built from paths that take the signal at some input, amplify it, and deliver it to some output. For simplicity let these signals be real numbers, and amplification be linear: we just multiply by some fixed scalar. We depict an example

device like so:

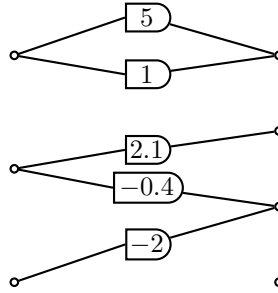

Here there are three inputs, four outputs, and five paths. Formally, we might model these devices as finite sets of inputs X , outputs Y , and paths N , together with functions $i: N \rightarrow X$ and $o: N \rightarrow Y$ describing the start and end of each path, and a function $s: N \rightarrow \mathbb{R}$ describing the amplification along it. In other words, these are cospans $X \rightarrow N \leftarrow Y$ in $\text{FinSet}^{\text{op}}$ decorated by ‘scalar assignment’ functions $N \rightarrow \mathbb{R}$. This suggests a decorated cospans construction.

Such a construction can be obtained from the lax symmetric monoidal functor $\mathbb{R}^{(-)}: \text{FinSet}^{\text{op}} \rightarrow \text{Set}$ taking a finite set N to the set \mathbb{R}^N of functions $s: N \rightarrow \mathbb{R}$, and opposite functions $f^{\text{op}}: N \rightarrow M$ to the map taking $s: N \rightarrow \mathbb{R}$ to $s \circ f: M \rightarrow \mathbb{R}$. Note that the coproduct in $\text{FinSet}^{\text{op}}$ is the cartesian product of sets. The coherence maps of the functor which, recall, are critical for the composition of the decorations, are given by $\varphi_{N,M}: \mathbb{R}^N \times \mathbb{R}^M \rightarrow \mathbb{R}^{N \times M}$, taking $(s, t) \in \mathbb{R}^N \times \mathbb{R}^M$ to the function $s \cdot t: N \times M \rightarrow \mathbb{R}$ defined by pointwise multiplication in \mathbb{R} .

Composition in this decorated cospan category is thus given by the multiplication in \mathbb{R} . In detail, given decorated cospans $(X \xrightarrow{i_X^{\text{op}}} N \xleftarrow{o_Y^{\text{op}}} Y, N \xrightarrow{s} \mathbb{R})$ and $(Y \xrightarrow{i_Y^{\text{op}}} M \xleftarrow{o_Z^{\text{op}}} Z, M \xrightarrow{t} \mathbb{R})$, the composite has a path from $x \in X$ to $z \in Z$ for every triple (y, n, m) where $y \in Y$, $n \in N$, and $m \in M$, such that n is a path from x to y and m is a path from y to z . The scalar assigned to this path is the product of those assigned to n and m . For example, we have the following composite

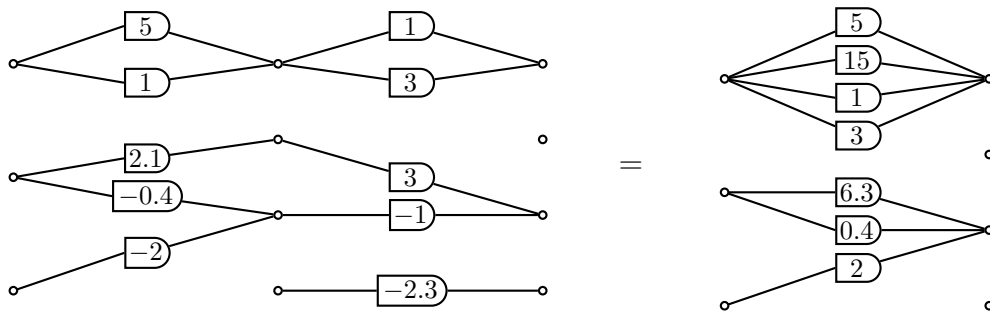

There are four paths between the top-most element x_1 of the domain and the top-most element z_1 of the codomain: we may first take the path that amplifies by $5 \times$

and then the path that amplifies by $1\times$ for a total amplification of $5\times$, or $5\times$ and $3\times$ for $15\times$, and so on. This means we end up with four elements relating x_1 and z_1 in the composite. The apex of the composite is in fact given by the pullback $N \times_Y M$ of the cospan $N \xrightarrow{oy} Y \xleftarrow{iy} M$ in FinSet .

Here we again see the problem of decorated cospans: the composite of the above puts decorations on $N \times_Y M$, which can be of much larger cardinality than N and M . We wish to avoid the size of our decorated cospan from growing so fast. Moreover, from our open systems perspective, we care not about the path but by the total amplification of the signal from some chosen input to some chosen output. The intuition is that if we black box the system, then we cannot tell what paths the signal took through the system, only the total amplification from input to output.

We thus want to restrict our apex to contain at most one point for each input–output pair (x, y) . We do this by pushing the decoration along the surjection e in the epi-mono factorisation of the function $N \times_Y M \xrightarrow{e} \overline{N \times_Y M} \xrightarrow{m} X \times Z$. Put another way, we want the category of decorated corelations, not decorated cospans.

Represented as decorated corelations, the above composite becomes

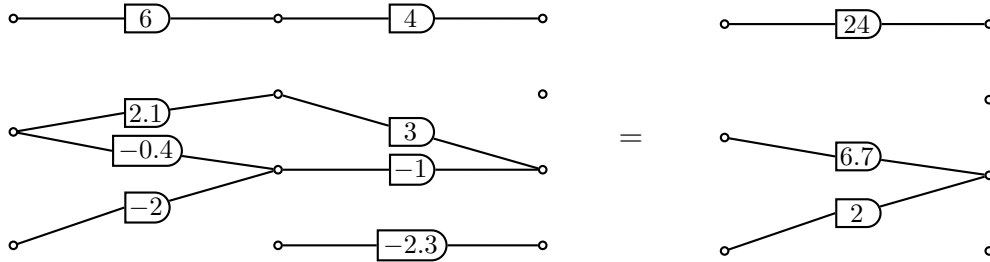

Note that composite is not simply the composite as decorated cospans, but the composite decorated cospan reduced to a decorated corelation. In §4.5.1, we will show that this decorated corelations category is equivalent to the category of real vector spaces and linear maps, with monoidal product the tensor product.

It is not a trivial fact that the above composition rule for decorated corelations defines a category. Indeed, the reason that it is possible to push the decoration along the surjection e is that the lax symmetric monoidal functor $\mathbb{R}^{(-)}: \text{FinSet}^{\text{op}} \rightarrow \text{Set}$ extends to a lax symmetric monoidal functor $(\text{FinSet}^{\text{op}}; \text{Sur}^{\text{op}}) \rightarrow \text{Set}$. Here $\text{FinSet}^{\text{op}}; \text{Sur}^{\text{op}}$ is the subcategory of $\text{Cospan}(\text{FinSet}^{\text{op}})$ comprising cospans of the form $f^{\text{op}} \rightarrow \leftarrow e^{\text{op}}$, where f is any function but e must be a surjection.

More generally, given a category \mathcal{C} with finite colimits and a subcategory \mathcal{M} stable under pushouts, we may construct a symmetric monoidal category $\mathcal{C}; \mathcal{M}^{\text{op}}$ with isomorphisms classes of cospans of the form $f \rightarrow \leftarrow m$, where $f \in \mathcal{C}$, $m \in \mathcal{M}$, as morphisms. The monoidal product is again derived from the coproduct in \mathcal{C} .

We prove two key theorems in this section. The first, Theorem 4.8, is that these decorated corelations form a hypergraph category. That is, given a category \mathcal{C} with finite colimits, factorisation system $(\mathcal{E}, \mathcal{M})$ such that \mathcal{M} is stable under pushouts, and a lax symmetric monoidal functor

$$F: \mathcal{C}; \mathcal{M}^{\text{op}} \longrightarrow \text{Set},$$

define a decorated corelation to be, as might be expected, an $(\mathcal{E}, \mathcal{M})$ -corelation $X \rightarrow N \leftarrow Y$ in \mathcal{C} together with an element of FN . Then there is a hypergraph category $F\text{Corel}$ with the objects of \mathcal{C} as objects and isomorphism classes of decorated corelations as morphisms. As usual, functors between these so-called decorated corelations categories can be defined from natural transformations between the decorating functors.

The second key theorem is that every hypergraph category and hypergraph functor can be constructed in this way, yielding an equivalence of categories (Theorem 4.15). This shows our decorated corelations construction is as general as we need for the study of hypergraph categories, and hence network-style diagrammatic languages.

4.2 Decorated corelations

Decorating cospans requires more than just choosing a set of decorations for each apex: for composition, we need to describe how these decorations transfer along the copairing of pushout maps $[j_N, j_M]: N + M \rightarrow N +_Y M$. Thus to construct a decorated cospan category we need, as we have seen, not merely a function from the objects of \mathcal{C} to Set , but a lax symmetric monoidal functor $(\mathcal{C}, +) \rightarrow (\text{Set}, \times)$.

Similarly, decorating $(\mathcal{E}, \mathcal{M})$ -corelations requires still more information: we now further need to know how to transfer decorations backwards along the morphisms $N +_Y M \xleftarrow{m} \overline{N +_Y M}$. We thus introduce the symmetric monoidal category $\mathcal{C}; \mathcal{M}^{\text{op}}$ with morphisms isomorphism classes of cospans of the form $\xrightarrow{f} \xleftarrow{m}$, where $f \in \mathcal{C}$ and $m \in \mathcal{M}$. For constructing categories of decorated $(\mathcal{E}, \mathcal{M})$ -corelations, we then require a lax symmetric monoidal functor F from $\mathcal{C}; \mathcal{M}^{\text{op}}$ to Set .

This section is structured in the same way as §3.2. First, in §4.2.1, we introduce the categories $\mathcal{C}; \mathcal{M}^{\text{op}}$, a prerequisite for the definition of decorated corelations. Next, in §4.2.2, we define decorated corelations, and then, in §4.2.3 the hypergraph category of decorated corelations. As in the previous chapter, we defer the proof that our hypergraph category is a well-defined category until our discussion of functors in the following section, §4.3.

4.2.1 Adjoining right adjoints

Suppose we have a cospan $X + Y \rightarrow N$ with a decoration on N . Reducing this to a corelation requires us to factor this to $X + Y \xrightarrow{c} \overline{N} \xrightarrow{m} N$. To define a category of decorated corelations, then, we must specify how to take decoration on N and ‘pull it back’ along m to a decoration on \overline{N} .

For decorated cospans, it is enough to have a functor F from a category \mathcal{C} with finite colimits; the image Ff of morphisms f in \mathcal{C} describes how to move decorations forward along f . In this subsection we explain how to expand \mathcal{C} to include morphisms m^{op} for each $m \in \mathcal{C}$, so that the image Fm^{op} of m^{op} describes how to move morphisms backwards along m . The construction of this expanded category $\mathcal{C}; \mathcal{M}^{\text{op}}$ is a simple consequence of the stability of \mathcal{M} under pushouts.

Proposition 4.1. *Let \mathcal{C} be a category with finite colimits, and let \mathcal{M} be a subcategory of \mathcal{C} stable under pushouts. Then we define the category $\mathcal{C}; \mathcal{M}^{\text{op}}$ as follows*

<i>The symmetric monoidal category $(\mathcal{C}; \mathcal{M}^{\text{op}}, +)$</i>	
<i>objects</i>	<i>the objects of \mathcal{C}</i>
<i>morphisms</i>	<i>isomorphism classes of cospans of the form $\xrightarrow{c} \xleftarrow{m}$, where c lies in \mathcal{C} and m in \mathcal{M}</i>
<i>composition</i>	<i>given by pushout</i>
<i>monoidal product</i>	<i>the coproduct in \mathcal{C}</i>
<i>coherence maps</i>	<i>the coherence maps in \mathcal{C}</i>

Proof. Our data is well defined: composition because \mathcal{M} is stable under pushouts, and monoidal composition by Lemma 3.11. The coherence laws follow as this is a symmetric monoidal subcategory of $\text{Cospan}(\mathcal{C})$. \square

Remark 4.2. As we state in the proof, the category $\mathcal{C}; \mathcal{M}^{\text{op}}$ is a subcategory of $\text{Cospan}(\mathcal{C})$. We can in fact view it as a sub-bicategory of the bicategory of cospans in \mathcal{C} , where the 2-morphisms given by maps of cospans. In this bicategory every morphism of \mathcal{M} has a right adjoint.

Examples 4.3. The factorisation systems introduced in Examples 3.2 and considered again in Examples 3.13 all have \mathcal{M} stable under pushout. This yields the following examples.

- $\mathcal{C}; \mathcal{C}^{\text{op}}$ is by definition equal to $\text{Cospan}(\mathcal{C})$.
- $\mathcal{C}; \mathcal{I}_{\mathcal{C}}^{\text{op}}$ is isomorphic to \mathcal{C} .

- $\text{Set}; \text{Inj}^{\text{op}}$ is the category with sets as objects and partial functions as morphisms.

The following lemma details how to construct functors between this type of category.

Lemma 4.4. *Let $\mathcal{C}, \mathcal{C}'$ be categories with finite colimits, and let $\mathcal{M}, \mathcal{M}'$ be subcategories of $\mathcal{C}, \mathcal{C}'$ respectively each stable under pushouts. Let $A: \mathcal{C} \rightarrow \mathcal{C}'$ be functor that preserves colimits and such that the image of \mathcal{M} lies in \mathcal{M}' . Then A extends to a symmetric strong monoidal functor*

$$A: \mathcal{C}; \mathcal{M}^{\text{op}} \longrightarrow \mathcal{C}'; \mathcal{M}'^{\text{op}}.$$

mapping X to AX and $\xrightarrow{c} \xleftarrow{m}$ to $\xrightarrow{Ac} \xleftarrow{Am}$.

Proof. Note $A(\mathcal{M}) \subseteq \mathcal{M}'$, so $\xrightarrow{Ac} \xleftarrow{Am}$ is indeed a morphism in $\mathcal{C}'; \mathcal{M}'^{\text{op}}$. This is then a restriction and corestriction of the usual functor $\text{Cospan}(\mathcal{C}) \rightarrow \text{Cospan}(\mathcal{C}')$ to the above domain and codomain. \square

Note that a similar construction giving subcategories of cospan categories could be defined more generally using any two isomorphism-containing wide subcategories stable under pushout. The above, however, suffices for decorated corelations.

4.2.2 Decorated corelations

As we have said, decorated corelations are constructed from a lax symmetric monoidal functor from $\mathcal{C}; \mathcal{M}^{\text{op}}$ to Set . In this subsection we define decorated corelations and give a composition rule for them, showing that this composition rule is well defined up to isomorphism.

Definition 4.5. Let \mathcal{C} be a category with finite colimits, $(\mathcal{E}, \mathcal{M})$ be a factorisation system on \mathcal{C} with \mathcal{M} stable under pushout, and

$$F: (\mathcal{C}; \mathcal{M}^{\text{op}}, +) \longrightarrow (\text{Set}, \times)$$

be a lax symmetric monoidal functor. We define an **F -decorated corelation** to a pair

$$\left(\begin{array}{ccc} & N & \\ i \nearrow & & \nwarrow o \\ X & & Y \end{array}, \begin{array}{c} FN \\ \uparrow s \\ 1 \end{array} \right)$$

where the cospan is jointly \mathcal{E} -like. A morphism of decorated corelations is a morphism of decorated cospans between two decorated corelations. As usual, we will be lazy about the distinction between a decorated corelation and its isomorphism class.

Suppose we have decorated corelations

$$\left(\begin{array}{c} N \\ \nearrow^{i_X} \quad \nwarrow_{o_Y} \\ X \quad \quad Y \end{array}, \quad \begin{array}{c} FN \\ \uparrow s \\ 1 \end{array} \right) \quad \text{and} \quad \left(\begin{array}{c} M \\ \nearrow^{i_Y} \quad \nwarrow_{o_Z} \\ Y \quad \quad Z \end{array}, \quad \begin{array}{c} FM \\ \uparrow t \\ 1 \end{array} \right).$$

Then, recalling the notation introduced in §3.2.3, their composite is given by the composite corelation

$$\begin{array}{c} \overline{N +_Y M} \\ \nearrow^{e \circ i_X} \quad \nwarrow_{e \circ i_Z} \\ X \quad \quad Z \end{array}$$

paired with the decoration

$$1 \xrightarrow{\varphi_{N,M} \circ \langle s,t \rangle} F(N + M) \xrightarrow{F[j_N, j_M]} F(N +_Y M) \xrightarrow{F(m^{\text{op}})} F(\overline{N +_Y M}).$$

As composition of corelations and decorated cospans are both well defined up to isomorphism, this too is well defined up to isomorphism.

Proposition 4.6. *Let \mathcal{C} be a category with finite colimits and a factorisation system $(\mathcal{E}, \mathcal{M})$ with \mathcal{M} stable under pushout. Then the above is a well-defined composition rule on isomorphism classes of decorated corelations.*

Proof. Let

$$(X \xrightarrow{i_X} N \xleftarrow{o_Y} Y, 1 \xrightarrow{s} FN) \xrightarrow{\sim} (X \xrightarrow{i'_X} N' \xleftarrow{o'_Y} Y, 1 \xrightarrow{s'} FN')$$

and

$$(Y \xrightarrow{i_Y} M \xleftarrow{o_Z} Z, 1 \xrightarrow{t} FM) \xrightarrow{\sim} (Y \xrightarrow{i'_Y} M' \xleftarrow{o'_Z} Z, 1 \xrightarrow{t'} FM')$$

be isomorphisms of decorated corelations. We wish to show that the composite of the decorated corelations on the left is isomorphic to the composite of the decorated corelations on the right.

As discussed in Proposition 4.6, the composites of the underlying corelations are isomorphic, via an isomorphism s which exists by the factorisation system. We need to show this s is an isomorphism of decorations. This is a matter of showing the diagram

$$\begin{array}{ccccc} & & F(N +_Y M) & \xrightarrow{Fm^{\text{op}}} & F(\overline{N +_Y M}) \\ & \nearrow^{F[j_N, j_M] \circ \varphi_{N,M} \circ \langle s,t \rangle} & \downarrow \sim \text{Fp} & & \downarrow \sim \text{Fs} \\ 1 & & & & \\ & \searrow_{F[j_{N'}, j_{M'}] \circ \varphi_{N', M'} \circ \langle s', t' \rangle} & F(N' +_Y M') & \xrightarrow{Fm'^{\text{op}}} & F(\overline{N' +_Y M'}) \end{array}$$

The triangle commutes as composition of decorated cospans is well defined (Proposition 2.2), while the square commutes as composition of corelations is well defined (Proposition 4.6). \square

Remark 4.7. Note that we have chosen to define decorated corelations only for lax symmetric monoidal functors

$$(\mathcal{C}; \mathcal{M}^{\text{op}}, +) \longrightarrow (\text{Set}, \times),$$

and not more generally for lax braided monoidal functors

$$(\mathcal{C}; \mathcal{M}^{\text{op}}, +) \longrightarrow (\mathcal{D}, \otimes)$$

for braided monoidal categories \mathcal{D} . While we could use the latter type of functor for our constructions, a similar arguments to those in Section 2.4 show we gain no extra generality. On the other hand, keeping track of this possibly varying category \mathcal{D} in the following distracts from the main insights. We thus merely remark that it is possible to make the more general definition, and leave it at that.

4.2.3 Categories of decorated corelations

In this subsection we define the hypergraph category $FCorel$ of decorated corelations. Having defined decorated corelations and their composition in the previous subsection, the key question to address is the provenance of the monoidal and hypergraph structure.

Recall, from §3.2.3, that to define the monoidal and hypergraph structure on categories of corelations, we used functors $\text{Cospan}(\mathcal{C}) \rightarrow \text{Corel}(\mathcal{C})$, leveraging the monoidal and hypergraph structure on cospan categories. In analogy, here we leverage the same fact for decorated cospans, this time using a structure preserving map

$$\square: FCospan \longrightarrow FCorel.$$

Here $FCospan$ denotes the decorated cospan category constructed from the restriction of the functor $F: \mathcal{C}; \mathcal{M}^{\text{op}} \rightarrow \text{Set}$ to the domain \mathcal{C} .

The monoidal product of two decorated corelations is their monoidal product as decorated cospans. To define the coherence maps for this monoidal product, as well as the coherence maps, we introduce the notion of a restricted decoration.

Given a cospan $X \rightarrow N \leftarrow Y$, write $m: \overline{N} \rightarrow N$ for the \mathcal{M} factor of the copairing $X + Y \rightarrow N$. The map \square takes a decorated cospan

$$(X \xrightarrow{i} N \xleftarrow{o} Y, 1 \xrightarrow{s} FN)$$

to the decorated corelation

$$(X \xrightarrow{\bar{i}} \bar{N} \xleftarrow{\bar{o}} Y, 1 \xrightarrow{Fm^{\text{op}} \circ s} F\bar{N}),$$

where the corelation is given by the jointly \mathcal{E} -part of the cospan, and the decoration is given by composing s with the F -image $Fm^{\text{op}}: FN \rightarrow F\bar{N}$ of the map $N \xrightarrow{1_N} N \xleftarrow{m} \bar{N}$ in $\mathcal{C}; \mathcal{M}^{\text{op}}$. This is well-defined up to isomorphism of decorated corelations. We call $Fm^{\text{op}} \circ s$ the **restricted decoration** of the decoration on the cospan $(X \rightarrow N \leftarrow Y, 1 \xrightarrow{s} FN)$.

We then make the following definition.

Theorem 4.8. *Let \mathcal{C} be a category with finite colimits and factorisation system $(\mathcal{E}, \mathcal{M})$ with \mathcal{M} stable under pushout, and let*

$$F: (\mathcal{C}; \mathcal{M}^{\text{op}}, +) \longrightarrow (\text{Set}, \times)$$

be a lax symmetric monoidal functor. Then we may define

<i>The hypergraph category $(F\text{Corel}, +)$</i>	
<i>objects</i>	<i>the objects of \mathcal{C}</i>
<i>morphisms</i>	<i>isomorphism classes of F-decorated corelations in \mathcal{C}</i>
<i>composition</i>	<i>given by \mathcal{E}-part of pushout with restricted decoration</i>
<i>monoidal product</i>	<i>the coproduct in \mathcal{C}</i>
<i>coherence maps</i>	<i>maps from $\text{Cospan}(\mathcal{C})$ with restricted empty decoration</i>
<i>hypergraph maps</i>	<i>maps from $\text{Cospan}(\mathcal{C})$ with restricted empty decoration</i>

Similar to Theorem 3.12 defining the hypergraph category $\text{Corel}(\mathcal{C})$, we have now specified well-defined data and just need to check a collection of coherence axioms. As before, we prove this in the next section, alongside a theorem regarding functors between decorated corelation categories.

Examples 4.9. Recall that corelations with respect to the trivial morphism–isomorphism factorisation system $(\mathcal{C}, \mathcal{I}_{\mathcal{C}})$ are simply cospans. Using this factorisation system, we see that decorated cospans are a special case of decorated corelations.

Example 4.10. ‘Undecorated’ corelations are also a special case of decorated corelations: they are corelations decorated by the functor

$$1: \mathcal{C}; \mathcal{M}^{\text{op}} \rightarrow \text{Set}$$

that maps each object to the one element set 1, and each morphism to the identity function on 1. This is a symmetric monoidal functor with the coherence maps all also the identity function on 1.

4.3 Functors between decorated corelation categories

In this section we show how to construct hypergraph functors between decorated corelation categories. The construction of these functors holds no surprises: their requirements combine the requirements of corelations and decorated cospans. In the process of proving that our construction gives well-defined hypergraph functors, we complete the necessary prerequisite proof that decorated corelation categories are well-defined hypergraph categories.

Recall that Lemma 4.4 says that, when the image of \mathcal{M} lies in \mathcal{M}' , we can extend a colimit-preserving functor $\mathcal{C} \rightarrow \mathcal{C}'$ to a symmetric monoidal functor $\mathcal{C}; \mathcal{M}^{\text{op}} \rightarrow \mathcal{C}'; \mathcal{M}'^{\text{op}}$.

Proposition 4.11. *Let $\mathcal{C}, \mathcal{C}'$ have finite colimits and respective factorisation systems $(\mathcal{E}, \mathcal{M}), (\mathcal{E}', \mathcal{M}')$, such that \mathcal{M} and \mathcal{M}' are stable under pushout, and suppose that we have lax symmetric monoidal functors*

$$F : (\mathcal{C}; \mathcal{M}^{\text{op}}, +) \longrightarrow (\text{Set}, \times)$$

and

$$G : (\mathcal{C}'; \mathcal{M}'^{\text{op}}, +) \longrightarrow (\text{Set}, \times).$$

Further let $A: \mathcal{C} \rightarrow \mathcal{C}'$ be a functor that preserves finite colimits and such that the image of \mathcal{M} lies in \mathcal{M}' . This functor A extends to a symmetric monoidal functor $\mathcal{C}; \mathcal{M}^{\text{op}} \rightarrow \mathcal{C}'; \mathcal{M}'^{\text{op}}$.

Suppose we have a monoidal natural transformation θ :

$$\begin{array}{ccc} \mathcal{C}; \mathcal{M}^{\text{op}} & & \\ \downarrow A & \searrow F & \\ \mathcal{C}'; \mathcal{M}'^{\text{op}} & \xrightarrow{G} & \text{Set} \end{array} \quad \Downarrow \theta$$

Then we may define a hypergraph functor $T: F\text{Corel} \rightarrow G\text{Corel}$ sending each object $X \in F\text{Corel}$ to $AX \in G\text{Corel}$ and each decorated corelation

$$\left(\begin{array}{ccc} & N & \\ i \nearrow & & \nwarrow o \\ X & & Y \end{array} , \quad \begin{array}{c} FN \\ \uparrow s \\ 1 \end{array} \right)$$

to

$$\left(\begin{array}{ccc} & \overline{AN} & \\ e' \circ \iota_{AX} \nearrow & & \nwarrow e' \circ \iota_{AY} \\ AX & & AY \end{array} , \begin{array}{c} \overline{GAN} \\ \uparrow Gm_{AN}^{\text{op}} \\ \overline{GAN} \\ \uparrow \theta_N \\ FN \\ \uparrow s \\ 1 \end{array} \right)$$

The coherence maps $\overline{\kappa}_{X,Y}$ are given by the coherence maps of A with the restricted empty decoration.

Proof of Theorem 4.8 and Proposition 4.11. In the proof of Theorem 3.12 and Proposition 3.14 we proved that the map

$$\square: \text{Corel}(\mathcal{C}) \longrightarrow \text{Corel}(\mathcal{C}')$$

preserved composition and had natural coherence maps. Specialising to the case when $\text{Corel}(\mathcal{C}) = \text{Cospan}(\mathcal{C}')$, we saw that this bijective-on-objects, surjective-on-morphisms, composition and monoidal product preserving map proved $\text{Corel}(\mathcal{C}')$ is a hypergraph category, and it immediately followed that \square is a hypergraph functor.

The analogous argument holds here: we simply need to prove

$$\square: F \text{Corel} \longrightarrow G \text{Corel}$$

preserves composition and has natural coherence maps. Theorem 4.8 then follows from examining the map $F \text{Cospan} \rightarrow F \text{Corel}$ obtained by choosing $\mathcal{C} = \mathcal{C}'$, $(\mathcal{E}, \mathcal{M}) = (\mathcal{C}', \mathcal{I}_{\mathcal{C}'})$, F the restriction of G to \mathcal{C}' , A the identity functor on \mathcal{C}' , and θ the identity natural transformation. Subsequently Proposition 4.11 follows from noting that all the axioms hold for the corresponding maps in $G \text{Cospan}$.

\square **preserves composition.** Suppose we have decorated corelations

$$f = (X \xrightarrow{i_X} N \xleftarrow{o_Y} Y, 1 \xrightarrow{s} FN) \quad \text{and} \quad g = (Y \xrightarrow{i_Y} M \xleftarrow{o_Z} Z, 1 \xrightarrow{t} FM)$$

We know the functor \square preserves composition on the cospan part; this is precisely the content of Proposition 3.14. It remains to check that $\square(g \circ f)$ and $\square g \circ \square f$ have isomorphic decorations. This is expressed by the commutativity of the following

diagram:

$$\begin{array}{c}
\begin{array}{ccc}
GA(\overline{N+YM}) & \xrightarrow{Gn} & G(\overline{AN+AYAM}) \\
\uparrow Gm_{A(\overline{N+YM})}^{\text{op}} & & \uparrow Gm_{\overline{AN+AYAM}}^{\text{op}} \\
GA(\overline{N+YM}) & \xrightarrow{G\sim} & G(\overline{AN+AYAM}) \\
\uparrow \theta_{\overline{N+YM}} & \swarrow GAm_{\overline{N+YM}}^{\text{op}} & \nearrow G(m_{\overline{AN}+AY}^{\text{op}} m_{\overline{AM}}^{\text{op}}) \\
F(\overline{N+YM}) & \xleftarrow{G\sim} & G(\overline{AN+AYAM}) \\
\uparrow Fm_{\overline{N+YM}}^{\text{op}} & \swarrow GA[j_N:j_M] & \nearrow G(m_{\overline{AN}+m_{\overline{AM}}}^{\text{op}}) \\
F(\overline{N+YM}) & \xleftarrow{G\alpha_{N,M}} & G(\overline{AN+AM}) \\
\uparrow F[j_N:j_M] & \swarrow \theta_{N+M} & \nearrow \gamma_{\overline{AN},\overline{AM}} \\
F(N+M) & \xrightarrow{\theta_{N+M}} & GA(N+M) \xleftarrow{G\alpha_{N,M}} G(AN+AM) \xrightarrow{\gamma_{AN,AM}} \overline{GAN} \times \overline{GAM} \\
& \searrow \varphi_{N,M} & \nearrow \theta_N \times \theta_M \\
& FN \times FM & \\
& \uparrow \rho_1 \circ (s \times t) \\
& 1 &
\end{array}
\end{array}$$

This diagram does indeed commute. To check this, first observe that (TM) commutes by the monoidality of θ , (GM) commutes by the monoidality of G , and (TN) commutes by the naturality of θ . The remaining three diagrams commute as they are G -images of diagrams that commute in \mathcal{C}' ; \mathcal{M}'^{op} . Indeed, (A) commutes since A preserves colimits and G is functorial, (C) commutes as it is the G -image of a pushout square in \mathcal{C}' , so

$$\overleftarrow{m_{AN+m_{AM}}} \overrightarrow{[j_{\overline{AN}}, j_{\overline{AM}}]} \quad \text{and} \quad \overrightarrow{[j_{AN}, j_{AM}]} \overleftarrow{m_{AN+AYm_{AM}}}$$

are equal as morphisms of \mathcal{C}' ; \mathcal{M}'^{op} , and (**) commutes as it is the G -image of the right-hand subdiagram of (*) used to define n in the proof of Lemma 3.15.

Coherence maps are natural. Let $f = (X \rightarrow N \leftarrow Y, 1 \rightarrow FN)$, $g = (Z \rightarrow M \leftarrow W, 1 \rightarrow FM)$ be F -decorated corelations in \mathcal{C} . We wish to show that

$$\begin{array}{ccc}
AX + AY & \xrightarrow{\square f + \square g} & AZ + AW \\
\downarrow \overline{\kappa_{X,Y}} & & \downarrow \overline{\kappa_{Z,W}} \\
A(X + Y) & \xrightarrow{\square(f+g)} & A(Z + W)
\end{array}$$

commutes in $G\text{Corel}$, where the coherence maps are given by

$$\overline{\kappa_{X,Y}} = \left(\begin{array}{ccc} & \overline{A(X+Y)} & \\ & \nearrow & \nwarrow \\ AX + AY & & A(X+Y) \end{array} , \begin{array}{c} G(\overline{A(X+Y)}) \\ \uparrow Gm_{AX+AY}^{\text{op}} \\ GA(X+Y) \\ \uparrow G! \\ G\emptyset \\ \uparrow \gamma_1 \\ 1 \end{array} \right).$$

Lemma 3.17 shows that the composites of corelations agree. It remains to check that the decorations also agree.

Here Lemma 2.5 is helpful. Since \square is composition preserving, we can replace the $\overline{\kappa}$ with the empty decorated coherence maps κ of $G\text{Cospan}$, and compute these composites in $G\text{Cospan}$, before restricting to the \mathcal{E}' -parts. Lemma 2.5 then implies that the restricted empty decorations on the isomorphisms $\overline{\kappa}$ play no role in determining the composite decorations. It is thus enough to prove that the decorations of $\square f + \square g$ and $\square(f+g)$ are the same up to the isomorphism $p: G(\overline{AN} + \overline{AM}) \rightarrow \overline{GA(N+M)}$ between their apices, as defined in the diagram (#) in the proof of Lemma 3.17.

This comes down to proving the following diagram commutes:

$$\begin{array}{ccccc} & & GAN \times GAM & \xrightarrow{Gm \times Gm} & \overline{GAN} \times \overline{GAM} & \xrightarrow{\gamma} & G(\overline{AN} + \overline{AM}) \\ & \nearrow \theta & & \searrow \gamma & & & \nearrow G(m+m) \\ 1 & \xrightarrow{\langle s,t \rangle} & FN \times FM & & G(AN + AM) & & \downarrow \sim Gp \\ & \searrow \varphi & & & \downarrow G\kappa & & \downarrow \sim Gp \\ & & F(N+M) & \xrightarrow{\theta} & GA(N+M) & \xrightarrow{Gm} & \overline{GA(N+M)} \\ & & & & & \text{(\#\#)} & \end{array}$$

This is straightforward to check: (T) commutes by the monoidality of θ , (G) by the monoidality of G , and ($\#\#$) as it is the G -image of the rightmost square in (#). \square

In particular, we get a hypergraph functor from the category of F -decorated cospans to the category of F -decorated corelations. In our applications, this is often the key aspect of constructing ‘black box’ or semantic functors.

Corollary 4.12. *Let \mathcal{C} be a category with finite colimits, and let $(\mathcal{E}, \mathcal{M})$ be a factorisation system on \mathcal{C} . Suppose that we also have a lax monoidal functor*

$$F : (\mathcal{C}; \mathcal{M}^{\text{op}}, +) \longrightarrow (\text{Set}, \times).$$

Then we may define a category $F\text{Corel}$ with objects the objects of \mathcal{C} and morphisms isomorphism classes of F -decorated corelations.

Write also F for the restriction of F to the wide subcategory \mathcal{C} of $\mathcal{C}; \mathcal{M}^{\text{op}}$. We can thus also obtain the category $FCospan$ of F -decorated cospans. We moreover have a functor

$$FCospan \rightarrow FCorel$$

which takes each object of $FCospan$ to itself as an object of $FCorel$, and each decorated cospan

$$\left(\begin{array}{ccc} & N & \\ i \nearrow & & \nwarrow o \\ X & & Y \end{array}, \quad \begin{array}{c} FN \\ \uparrow s \\ 1 \end{array} \right)$$

to its jointly \mathcal{E} -part

$$\begin{array}{ccc} & \overline{N} & \\ eol_X \nearrow & & \nwarrow eol_Y \\ X & & Y \end{array}$$

decorated by the composite

$$1 \xrightarrow{s} FN \xrightarrow{Fm_N^{\text{op}}} F\overline{N}.$$

4.4 All hypergraph categories are decorated correlation categories

Not all hypergraph categories are decorated *cospan* categories. To see this, we can count so-called scalars: morphisms from the monoidal unit \emptyset to itself. In a decorated cospan category, the set of morphisms from X to Y always comprises all decorated cospans $(X \rightarrow N \leftarrow Y, 1 \rightarrow FN)$. Now for any object N in the underlying category \mathcal{C} , there is a unique morphism $\emptyset \rightarrow N$. This means that the morphisms $\emptyset \rightarrow \emptyset$ are indexed by (isomorphism classes of) elements of FN , ranging over N .

Suppose we have a decorated cospan category with a unique morphism $\emptyset \rightarrow \emptyset$. By the previous paragraph, and replacing \mathcal{C} with an equivalent skeletal category, this implies there is only one object N such that FN is nonempty. But FN must always contain at least one element, the empty decoration $1 \xrightarrow{\varphi_I} F\emptyset \xrightarrow{F!} FN$. This implies there is only one object N in \mathcal{C} : the object \emptyset . Thus \mathcal{C} must be the one object discrete category, and $F: \mathcal{C} \rightarrow \text{Set}$ is the functor that sends the object of \mathcal{C} to the one element set 1.

Hence any decorated cospan category with a unique morphism $\emptyset \rightarrow \emptyset$ is the one object discrete category. But the hypergraph category of finite sets and equivalence relations, discussed in Subsection 3.4.1, is a nontrivial category with a unique morphism $\emptyset \rightarrow \emptyset$. Thus it cannot be constructed as a decorated cospan category.

Decorated corelation categories, however, are more powerful. In this section we show that all hypergraph categories are decorated corelation categories, and provide some examples for intuition.

4.4.1 Representing a morphism with its name

Suppose we are given a hypergraph category \mathcal{H} and wish to construct a hypergraph equivalent decorated corelation category. The main idea is to take advantage of the compact closed structure: recall from §1.3.3 that morphisms $X \rightarrow Y$ in a hypergraph category are in one-to-one correspondence with their so-called names $I \rightarrow X \otimes Y$. We shall also witness the great utility of the seemingly trivial isomorphism-morphism factorisation system.

We start with the wide subcategory of \mathcal{H} comprising, roughly speaking, just the coherence and hypergraph maps. Then, choosing the isomorphism-morphism factorisation system on this subcategory, we use the restriction of hom functor $\mathcal{H}(I, -)$ to this subcategory to decorate each corelation $X \rightarrow X \otimes Y \leftarrow Y$ with the monoidal elements of $X \otimes Y$. The morphisms in the resulting category are cospans $X \xrightarrow{1_X \otimes \eta_Y} X \otimes Y \xleftarrow{\eta_X \otimes 1_Y} Y$ decorated by a map $I \rightarrow X \otimes Y$. This recovers the original hypergraph category.

Theorem 4.13. *Every hypergraph category is hypergraph equivalent to a decorated corelation category. That is, given a hypergraph category (\mathcal{H}, \otimes) , there exists a lax symmetric monoidal functor F such that (\mathcal{H}, \otimes) is hypergraph equivalent to $F\text{Corel}$.*

Proof. Let (\mathcal{H}, \otimes) be a hypergraph category. By Theorem 1.5, we have a hypergraph equivalent strict hypergraph category $(\mathcal{H}_{\text{str}}, \cdot)$ with objects finite lists of objects in \mathcal{H} . We will build \mathcal{H}_{str} as a decorated corelation category.

Write \mathcal{O} for the collection of objects in \mathcal{H} . Recall that we may write FinSet for the skeletal strict symmetric monoidal category of finite sets and functions, and here let us further denote the objects of FinSet as $n = \{0, 1, \dots, n-1\}$ for $n \in \mathbb{N}$, where 0 is the empty set. We then write $\text{FinSet}_{\mathcal{O}}$ for the category of \mathcal{O} -labelled finite sets (i.e. an object is a finite set n with each element in n labelled by some object in \mathcal{H} , and a morphism is a function that preserves labels). Note that, due to the chosen ordering on elements of each finite set n , the objects of $\text{FinSet}_{\mathcal{O}}$ are in one-to-one correspondence with finite lists of objects of \mathcal{H} , and hence can be considered the same as the objects of \mathcal{H}_{str} .

Next, observe that the category $\text{FinSet}_{\mathcal{O}}$ has finite colimits: the colimit is just the colimit set in FinSet with each element labelled by the label of any element that

maps to it in the colimit diagram. This labelling exists and is unique by the universal property of the colimit. Thus we view $\text{FinSet}_{\mathcal{O}}$ as a symmetric monoidal category with the coproduct, written $+$ as per usual, as its monoidal product.

We define a strict hypergraph functor that is a wide embedding of categories

$$H: (\text{Cospan}(\text{FinSet}_{\mathcal{O}}), +) \longrightarrow (\mathcal{H}_{\text{str}}, \cdot),$$

whose image is the hypergraph structure of \mathcal{H}_{str} . More precisely, H sends each object of $\text{Cospan}(\text{FinSet}_{\mathcal{O}})$ to the same as an object of \mathcal{H}_{str} . As the morphisms of FinSet —that is, all functions between finite sets—can be generated via composition and coproduct from the unique functions $\mu: 2 \rightarrow 1$, $\eta: 0 \rightarrow 1$, and the braiding $2 \rightarrow 2$ in FinSet , the morphisms of $\text{FinSet}_{\mathcal{O}}$ are generated as a symmetric monoidal category by the unique morphisms $\mu_x: [x : x] \rightarrow [x]$ and $\eta_x: \emptyset \rightarrow [x]$, where x ranges over objects of \mathcal{H} . This then implies the morphisms of $\text{Cospan}(\text{FinSet}_{\mathcal{O}})$ are generated as a symmetric monoidal category by the cospans $\mu_x, \eta_x, \delta_x = \mu_x^{\text{op}}$, and $\epsilon_x = \eta_x^{\text{op}}$. The functor H maps these generators to the corresponding Frobenius maps on $[x]$ in \mathcal{H}_{str} . Since $\text{Cospan}(\text{FinSet})$ is the ‘generic special commutative monoid’ (see Proposition 1.7), it is straightforward to check this defines a hypergraph functor.

Next, recall that the hom functor $\mathcal{H}_{\text{str}}(I, -): (\mathcal{H}_{\text{str}}, \cdot) \rightarrow (\text{Set}, \times)$ is a lax symmetric monoidal functor taking each object X of \mathcal{H}_{str} to the homset $\mathcal{H}_{\text{str}}(I, X)$ (Proposition 2.9). Write F for the composite of these two functors:

$$F: (\text{Cospan}(\text{FinSet}_{\mathcal{O}}), +) \xrightarrow{H} (\mathcal{H}_{\text{str}}, \cdot) \xrightarrow{\mathcal{H}_{\text{str}}(I, -)} (\text{Set}, \times).$$

This is lax symmetric monoidal functor mapping a finite list X of objects in \mathcal{H} to the homset $\mathcal{H}_{\text{str}}(I, X)$, and a cospan between lists of objects in \mathcal{H} to the corresponding Frobenius map.

Now consider $\text{FinSet}_{\mathcal{O}}$ with an isomorphism-morphism factorisation system. This implies F defines a decorated corelation category $F\text{Corel}$ with the objects of \mathcal{H}_{str} as objects, and the unique isomorphism-morphism corelation $X \xrightarrow{\iota_X} X + Y \xleftarrow{\iota_Y} Y$ from $X \rightarrow Y$ decorated by some morphism $s \in \mathcal{H}_{\text{str}}(I, X \cdot Y)$ as morphisms $X \rightarrow Y$. We complete this proof by showing $(F\text{Corel}, +)$ and $(\mathcal{H}_{\text{str}}, \cdot)$ are isomorphic as hypergraph categories.

First, let us examine composition in $F\text{Corel}$. As morphisms $X \rightarrow Y$ are completely specified by their decoration $s \in \mathcal{H}_{\text{str}}(I, X \cdot Y)$, we will abuse terminology and refer to the decorations themselves as the morphisms. Given morphisms $s \in \mathcal{H}_{\text{str}}(I, X \cdot Y)$ and $t \in \mathcal{H}_{\text{str}}(I, Y \cdot Z)$ in $F\text{Corel}$, composition is given by the map

$$H_{\text{str}}(I, X \cdot Y \cdot Y \cdot Z) \rightarrow H_{\text{str}}(I, X \cdot Z)$$

arising as the F -image of the cospan $X+Y+Y+Z \xrightarrow{[j_{X+Y}, j_{Y+Z}]} X+Y+Z \xleftarrow{[\iota_X, \iota_Z]} X+Z$, where these maps come from the pushout square

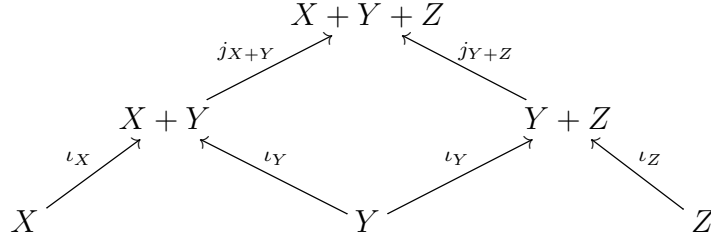

and the trivial isomorphism-morphism factorisation $X+Z = X+Z \xrightarrow{[\iota_X, \iota_Z]} X+Y+Z$ in $\text{FinSet}_{\mathcal{O}}$.

In terms of string diagrams in \mathcal{H}_{str} , this means composing the maps



with the Frobenius map

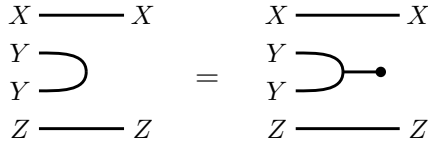

to get

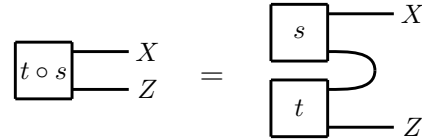

in $\mathcal{H}_{\text{str}}(I, X \cdot Z)$.

The monoidal product is given by

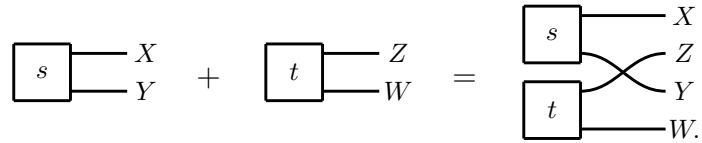

Taking a hint from the compact closed structure, the isomorphism between $FCorel$ and \mathcal{H}_{str} is then clear: the functors act as the identity on objects, and on morphisms take $f : X \rightarrow Y$ in \mathcal{H}_{str} to its name $\hat{f} : I \rightarrow X \cdot Y$ as a morphism of $FCorel$, and vice versa.

It is straightforward to check that these are strict hypergraph functors. To demonstrate the most subtle aspect, the Frobenius structure, we consider the multiplication on an object X of $FCorel$. To obtain this, we start with the multiplication in

Proof. On objects, define the functor $A: \text{Cospan}(\text{FinSet}_{\mathcal{O}}) \rightarrow \text{Cospan}(\text{FinSet}_{\mathcal{O}'})$ to take each \mathcal{O} -labelled set $X = [x_1 : \dots : x_n]$, written here as a string of elements of \mathcal{O} , to the \mathcal{O}' -labelled set $TX = [Tx_1 : \dots : Tx_n]$ comprising the same set but changing each label x_i to Tx_i . On morphisms, let it take a function between \mathcal{O} -labelled sets to the same function between the underlying sets, noting that the function now preserves the \mathcal{O}' -labels. This functor A clearly preserves colimits: again, colimits in $\text{FinSet}_{\mathcal{O}}$ are just colimits in FinSet with the labels inherited as described above.

Let $X = [x_1 : \dots : x_n]$ be an \mathcal{O} -labelled set, and recall that we write $PX = (((x_1 \otimes x_2) \otimes \dots) \otimes x_n) \otimes I$ for the monoidal product of this string in \mathcal{H} with all open parentheses at the front. We define

$$\theta_X: \mathcal{H}_{\text{str}}(I, X) = \mathcal{H}(I, PX) \longrightarrow \mathcal{H}'_{\text{str}}(I', TX) = \mathcal{H}'(I', PTX);$$

$$\left(I \xrightarrow{s} PX \right) \longmapsto \left(I' \xrightarrow{\tau_I} TI \xrightarrow{Ts} TPX \xrightarrow{\tau_*} PTX \right),$$

where τ_* is the appropriate composite of coherence isomorphisms of T . This collection of maps θ is natural because (i) functions in $\text{FinSet}_{\mathcal{O}}$ act as the Frobenius maps on the homsets $\mathcal{H}(I, X)$ and $\mathcal{H}'(I', TX)$, and (ii) the functor T is hypergraph and thus sends, loosely speaking, Frobenius maps to Frobenius maps. Moreover θ is monoidal as T is monoidal. Thus θ defines a monoidal natural transformation.

The hypergraph functor $F\text{Corel} \rightarrow F'\text{Corel}$ induced by θ is by definition the map taking the decoration $s \in \mathcal{H}(I, P(X \cdot Y))$ to the decoration $\tau_* \circ Ts \circ \tau_I \in \mathcal{H}'(I', PT(X \cdot Y))$. It is immediate that the above square commutes. We thus say that T can be constructed as a decorated corelation functor. \square

4.4.2 A categorical equivalence

Choose Grothendieck universes so that we may talk about the category Set now only of all so-called small sets, and the category Cat of all small categories. If we restrict our attention to small hypergraph categories, we may summarise these results as a categorical equivalence.

Indeed, given some fixed object set \mathcal{O} , we have a category of lax symmetric monoidal functors and monoidal natural transformations

$$\text{LaxSymMon}(\text{Cospan}(\text{FinSet}_{\mathcal{O}}), \text{Set}).$$

This is equivalent to some subcategory of the category HypCat of hypergraph categories. To get a category equivalent to HypCat , we must patch together these functor

categories by varying the object set and specifying morphisms from objects in one category to objects in another. For this we use the Grothendieck construction.

Given a (contravariant) functor $S: \mathcal{B} \rightarrow \text{Cat}$ from some category \mathcal{B} to Cat , we define the **(contravariant) Grothendieck construction** $\mathcal{B} \int S$ to be the category with pairs (\mathcal{O}, F) where \mathcal{O} is an object of \mathcal{B} and F is an object of $S\mathcal{O}$ as objects, and pairs

$$(f, \theta): (\mathcal{O}, F) \longrightarrow (\mathcal{O}', F')$$

where $f: \mathcal{O} \rightarrow \mathcal{O}'$ is a morphism in \mathcal{B} and $\theta: F \rightarrow Sf(F')$ is a morphism in $S\mathcal{O}$ as morphisms. Given another morphism $(g, \zeta): (\mathcal{O}', F') \rightarrow (\mathcal{O}'', F'')$, the composite morphism in the pair $(g \circ f, Sf\zeta \circ \theta)$.

Now, define the functor

$$\text{LaxSymMon}(\text{Cospan}(\text{FinSet}_-), \text{Set}): \text{Set} \longrightarrow \text{Cat}$$

as follows. On objects let it map a set \mathcal{O} to the lax symmetric monoidal functor category $\text{LaxSymMon}(\text{Cospan}(\text{FinSet}_{\mathcal{O}}), \text{Set})$. For morphisms, we noted at the beginning of the proof of Theorem 4.14 that a function $r: \mathcal{O} \rightarrow \mathcal{O}'$ from one set of labels to another induces a functor $R: \text{Cospan}(\text{FinSet}_{\mathcal{O}}) \rightarrow \text{Cospan}(\text{FinSet}_{\mathcal{O}'})$ taking each \mathcal{O} -labelled set $N \xrightarrow{l} \mathcal{O}$ to the \mathcal{O}' -labelled set $N \xrightarrow{rol} \mathcal{O}'$. This in turn defines a functor

$$\begin{aligned} \text{LaxSymMon}(\text{Cospan}(\text{FinSet}_{\mathcal{O}'}) , \text{Set}) &\longrightarrow \text{LaxSymMon}(\text{Cospan}(\text{FinSet}_{\mathcal{O}}), \text{Set}); \\ (F': \text{Cospan}(\text{FinSet}_{\mathcal{O}'}) \rightarrow \text{Set}) &\longmapsto (R \circ F': \text{Cospan}(\text{FinSet}_{\mathcal{O}}) \rightarrow \text{Set}). \end{aligned}$$

by post-composition with R . Note that $\text{LaxSymMon}(\text{Cospan}(\text{FinSet}_-), \text{Set})$ is a well-defined functor: in particular, it preserves composition on the nose.

The Grothendieck construction

$$\text{Set} \int \text{LaxSymMon}(\text{Cospan}(\text{FinSet}_-), \text{Set})$$

thus gives a category where the objects are some label set \mathcal{O} together with an object in $\text{LaxSymMon}(\text{Cospan}(\text{FinSet}_{\mathcal{O}}), \text{Set})$ —that is, with a lax symmetric monoidal functor $F: (\text{Cospan}(\text{FinSet}_{\mathcal{O}}), +) \rightarrow (\text{Set}, \times)$. The morphisms $(\mathcal{O}, F) \rightarrow (\mathcal{O}, F')$ are functions of label sets $r: \mathcal{O} \rightarrow \mathcal{O}'$ together with a natural transformation $\theta: R \circ F' \Rightarrow F$.

In the case of small categories, it is not difficult to show that Theorems 4.13 and 4.14 imply:

Theorem 4.15. *There is an equivalence of categories*

$$\text{HypCat} \cong \text{Set} \int \text{LaxSymMon}(\text{Cospan}(\text{FinSet}_-), \text{Set}).$$

The 2-categorical version of the above equivalence is also the subject of a forthcoming paper by Vagner, Spivak, and Schultz, from their operadic perspective [VSS].

Remark 4.16. It is prudent, to wonder, in the definition of hypergraph category, why it is useful to define a structure—the Frobenius maps—on a category that does not interact with the morphisms of the category. This affects, for example, invariance under equivalence of symmetric monoidal categories: given two equivalent symmetric monoidal categories, the hypergraph structures on these categories need not be in one-to-one correspondence. The Frobenius maps, however, are seen by the monoidal product and by hypergraph functors. Theorem 4.15 provides a more invariant definition of the category of hypergraph categories.

4.4.3 Factorisations as decorations

We have seen that every hypergraph category can be constructed as a decorated correlations category. More precisely, we have seen that every hypergraph category can be constructed as a decorated correlation category with the factorisation system the trivial isomorphism-morphism factorisation system. But we can also use other factorisation systems to construct decorated correlation categories, and these are also hypergraph categories. This implies that we might have multiple decorated correlation constructions for the same hypergraph category. How do these constructions relate to each other?

Recall from Remark 3.20 that for any category \mathcal{C} with finite colimits there exists a poset of factorisation systems $(\mathcal{E}, \mathcal{M})$ with \mathcal{M} stable under pushout, where the order is given by reverse inclusion on \mathcal{M} . Suppose we choose a factorisation system $(\mathcal{E}, \mathcal{M})$ and have a lax symmetric monoidal functor

$$F: \mathcal{C}; \mathcal{M}^{\text{op}} \longrightarrow \text{Set}.$$

This defines a decorated correlation category. Although we will not prove it here, it is in fact possible to construct a hypergraph equivalent decorated correlation category using any factorisation system $(\mathcal{E}', \mathcal{M}')$ less than $(\mathcal{E}, \mathcal{M})$. Roughly, the idea is that although moving to a smaller factorisation system results in fewer correlations, we may store any lost information in the decorations by altering the functor F in the right way. The proof of Theorem 4.13 shows how to do this for the factorisation system at the bottom of this poset, the isomorphism-morphism factorisation system $(\mathcal{I}_{\mathcal{C}}, \mathcal{M})$.

For illustration, we example this interaction for the simplest hypergraph category: $\text{Cospan}(\text{FinSet})$, the free hypergraph category on a single object.

Example 4.17. As per Example 4.10, $\text{Cospan}(\text{FinSet})$ is the hypergraph category of undecorated morphism-isomorphism corelations in FinSet . Theorem 4.13 shows it is also the hypergraph category of function-decorated isomorphism-morphism corelations in FinSet .

The construction in Theorem 4.13 proceeds as follows. First, we construct a lax symmetric monoidal functor $F: \text{Cospan}(\text{FinSet}) \rightarrow \text{Set}$. On objects F takes each finite set X to the set of isomorphism classes of cospans $\emptyset \rightarrow D \leftarrow X$ from the monoidal unit \emptyset to X or, equivalently, the set FX of functions $s: X \rightarrow D$, where a unique codomain D is chosen for each finite cardinality. On morphisms, F takes a cospan $X \xrightarrow{f} N \xleftarrow{g} Y$ to the function $FX \rightarrow FY$ that maps $s: X \rightarrow D$ in FX to the function $Y \rightarrow N +_X D$ in FY given by

$$\begin{array}{ccc} X & \xrightarrow{s} & D \\ f \downarrow & & \downarrow \\ Y & \xrightarrow{g} & N \longrightarrow N +_X D \end{array}$$

where the square is a pushout square. For coherence maps, the map $\varphi_1: 1 \rightarrow F\emptyset$ takes the unique element of 1 to the unique function $!: \emptyset \rightarrow \emptyset$, while $\varphi_{X,Y}$ takes a pair of functions $a: X \rightarrow D$, $b: Y \rightarrow E$ to $a + b: X + Y \rightarrow D + E$. This defines a lax symmetric monoidal functor (F, φ) .

A decorated *cospan* in FinSet with respect to (F, φ) is then a cospan of finite sets $X \rightarrow N \leftarrow Y$ together with a function of finite sets $N \rightarrow D$. Using the isomorphism-morphism factorisation, a decorated *corelation* is thus a cospan $X \xrightarrow{\iota_X} X + Y \xleftarrow{\iota_Y} Y$ together with a function $X + Y \rightarrow D$. As there is a unique isomorphism class of $\mathcal{I}_{\text{FinSet}}$ -like cospans $X \xrightarrow{\iota_X} X + Y \xleftarrow{\iota_Y} Y$, a decorated corelation is thus specified by its decoration $X + Y \rightarrow D$ alone. Note that maps $X + Y \rightarrow D$ are in one-to-one correspondence with cospans $X \rightarrow D \leftarrow Y$ in FinSet via the coproduct inclusion maps.

As observed in the proof of Theorem 4.13, the hypergraph structure on $F\text{Corel}$ agrees with that on $\text{Cospan}(\text{FinSet})$ via this correspondence; the multiplication $\mu_X: X + X \rightarrow X$ in $F\text{Corel}$ is simply given by the decoration $(X + X) + X \rightarrow X$, and so on. The intuition is that F takes the ‘factored out part’ of the corelation and puts it into the decoration.

This correspondence between maps $X + Y \rightarrow D$ and cospans $X \rightarrow D \leftarrow Y$ suggests an isomorphism. Indeed, the equivalence given by Theorem 4.13 is precisely this. We can construct one direction, the one from the smaller to larger \mathcal{M} —that is, from $\mathcal{M} = \mathcal{I}_{\text{FinSet}}$ to $\mathcal{M} = \text{FinSet}$ —as a decorated corelations functor. Note that

the identity on FinSet maps the subcategory $\mathcal{I}_{\text{FinSet}}$ into FinSet , and so extends to a morphism $\text{FinSet} \rightarrow \text{Cospan}(\text{FinSet})$. Also recall (from say Example 4.10) that the ‘undecorated’ cospan category $\text{Cospan}(\text{FinSet})$ is equal to the decorated cospan category given by the functor $1: \text{FinSet} \rightarrow \text{Set}$ mapping each finite set to some chosen one element set 1 , and each morphism to the identity morphism on 1 . Define monoidal natural transformation

$$\begin{array}{ccc} \text{FinSet} = \text{FinSet}; \mathcal{I}_{\text{FinSet}}^{\text{op}} & \xrightarrow{1} & \text{Set} \\ \downarrow \iota & \searrow G & \Downarrow \theta \\ \text{Cospan}(\text{FinSet}) = \text{FinSet}; \text{FinSet}^{\text{op}} & & \end{array}$$

with each $\theta_X: 1 \rightarrow GX$ mapping the unique element to the identity function $1_X: X \rightarrow X$. This gives the hypergraph functor we expect, mapping the undecorated cospan $X \rightarrow N \leftarrow Y$ to the trivial cospan $X \rightarrow X + Y \leftarrow Y$ decorated by $X + Y \rightarrow N$. It is now routine to verify this is an isomorphism.

The previous example extends to any category \mathcal{C} with finite colimits: the hypergraph category $\text{Cospan}(\mathcal{C})$ can always be constructed as (i) trivially decorated $(\mathcal{C}, \mathcal{I}_{\mathcal{C}})$ -corelations, or (ii) $(\mathcal{I}_{\mathcal{C}}, \mathcal{C})$ -corelations decorated by equivalence classes of morphisms with domain the apex of the corelation. Moreover, the isomorphism of these hypergraph categories is given by the analogous monoidal natural transformation between the decorating functors.

More general still, a category of trivially decorated $(\mathcal{E}, \mathcal{M})$ -corelations in \mathcal{C} can always be constructed also as $(\mathcal{I}_{\mathcal{C}}, \mathcal{C})$ -corelations decorated by equivalence classes of morphisms in \mathcal{E} with domain the apex of the corelation, and the isomorphism of these hypergraph categories a decorated corelations functor.

Most generally, we can still perform this construction on decorated corelation categories: Theorem 4.13 implies any category of $(\mathcal{E}, \mathcal{M})$ -decorated corelations can be constructed also as $(\mathcal{I}_{\mathcal{C}}, \mathcal{C})$ -corelations decorated by codomain decorated morphisms in \mathcal{E} . Given some lax symmetric monoidal functor

$$F: \mathcal{C}; \mathcal{M}^{\text{op}} \longrightarrow \text{Set},$$

the decorated $(\mathcal{I}_{\mathcal{C}}, \mathcal{C})$ -corelations are specified by the functor

$$F': \text{Cospan}(\mathcal{C}) \longrightarrow \text{Set}$$

taking any object $Z \in \text{Cospan}(\mathcal{C})$ to the pair $(Z \xrightarrow{e} N, 1 \xrightarrow{s} FN)$, where e is a morphism in \mathcal{E} .

What is the utility of this variety of constructions? Different constructions suit different purposes. At the top of the poset, consider the morphism-isomorphism factorisation system: these give decorated cospan categories. Decorated cospan categories provide, as we saw for open electric circuits, an intuitive way to construct a ‘syntactic’ hypergraph category from some notion of network-style diagrammatic language. Moreover, they are decorated corelation categories with $\mathcal{M} = \mathcal{I}_{\mathcal{C}}$ as small as possible. This makes it easy to use decorated corelations to construct hypergraph functors—such as those describing the semantics of diagrams—from a decorated cospan category to another category.

To do this, however, we need to construct hypergraph categories of semantics. Here epi-mono corelations are a useful tool. Indeed, some hypergraph categories are very naturally constructed as corelation (or, dually, relation) categories, such as the categories of equivalence relations, relations, or linear relations. Here the factorisation system has an intuitive interpretation, such as the epimorphisms retaining only the structure in the apex that is ‘accessible’ or ‘mapped onto’ by the feet/boundary. Decorating these corelations retains the same sort of intuition.

Finally, at the bottom of the poset, we have the isomorphism-morphism factorisation system. These give rise to the decorated corelation categories constructed in Theorem 4.13, in which the factorisation system is the trivial isomorphism-morphism one and all interesting structure is carried by the apex of the decorated corelation. Note that these have $\mathcal{M} = \mathcal{C}$ as large as possible, and also large sets of decorations. This makes it easy to construct functors into a given hypergraph category. Thus we might first define a semantic category as an epi-mono corelation category to match our intuitions, and then later use an equivalent definition as a isomorphism-morphism corelation category to facilitate construction of semantic functors.

Indeed, the ability to construct functors from one hypergraph category to another is essential for the understanding of hypergraph categories as network-type diagrammatic languages, with functors not just giving rise to notions of semantics, but hence also notions of equivalence of diagrams, and reasoning tools.

We will illustrate these principles in greater depth in Part II, which delves into applications of this philosophy and framework. We conclude this section and Part I with two examples of a more abstract nature.

4.5 Examples

We give two extended examples. Our first example is to revisit the matrix example from the introduction, having now developed the necessary material. Our second example is to revisit the category of linear relations once more, showing that we can also construct it as a decorated corelation category.

4.5.1 Matrices

Let R be a commutative rig.¹ In this subsection we will construct matrices over R as decorated corelations over $\text{FinSet}^{\text{op}}$.

In $\text{FinSet}^{\text{op}}$ the coproduct is the Cartesian product \times of sets, the initial object is the one element set 1 , and cospans are spans in FinSet . The notation will thus be less confusing if we talk of decorated spans on (FinSet, \times) given by the contravariant lax monoidal functor

$$\begin{aligned} R^{(-)} : (\text{FinSet}, \times) &\longrightarrow (\text{Set}, \times); \\ N &\longmapsto R^N \\ (f : N \rightarrow M) &\longmapsto (R^f : R^M \rightarrow R^N; v \mapsto v \circ f). \end{aligned}$$

The coherence maps $\varphi_{N,M} : R^N \times R^M \rightarrow R^{N \times M}$ take a pair (s, t) of maps $s : N \rightarrow R$, $t : M \rightarrow R$ to the pointwise product $s \cdot t : N \times M \rightarrow R$; $(n, m) \mapsto s(n) \cdot t(m)$. The unit coherence map $\varphi_1 : 1 \rightarrow R^1$ sounds almost tautological: it takes the unique element of the one element set 1 to the function $1 \rightarrow R$ that maps the unique element of the one element set to the multiplicative identity 1_R of the rig R . As described in Section 4.1, $R^{(-)}\text{Cospan}$ can be considered as the category of ‘multivalued matrices’ over R , and $R^{(-)}\text{Corel}$ the category of matrices over R .

Just as the coherence map φ_1 gives the unit for the multiplication, it is the coherence maps $\varphi_{N,M}$ that enact multiplication of scalars: the composite of decorated spans $(X \xleftarrow{i_X} N \xrightarrow{o_Y} Y, N \xrightarrow{s} R)$ and $(Y \xleftarrow{i_Y} M \xrightarrow{o_Z} Z, M \xrightarrow{t} R)$ is the span $X \leftarrow N \times_Y M \rightarrow Z$ decorated by the map

$$N \times_Y M \hookrightarrow N \times M \xrightarrow{\varphi_{N,M}(s,t)=s \cdot t} R,$$

where the inclusion from $N \times_Y M$ into $N \times M$ is that given by the categorical product. We discussed the intuition for this composition rule, in terms of paths between elements of X and those of Z , in Section 4.1.

¹Also known as a semiring, a rig is a ring without negatives.

As φ_1 selects the multiplicative unit 1_R of R , the empty decoration on any set N is the function that sends every element of N to 1_R . This implies the identity decorated span on $X = \{x_1, \dots, x_n\}$ is that represented by the diagram

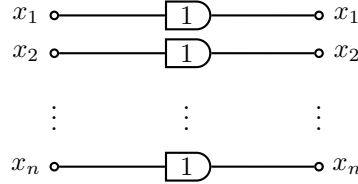

while the Frobenius multiplication and unit are

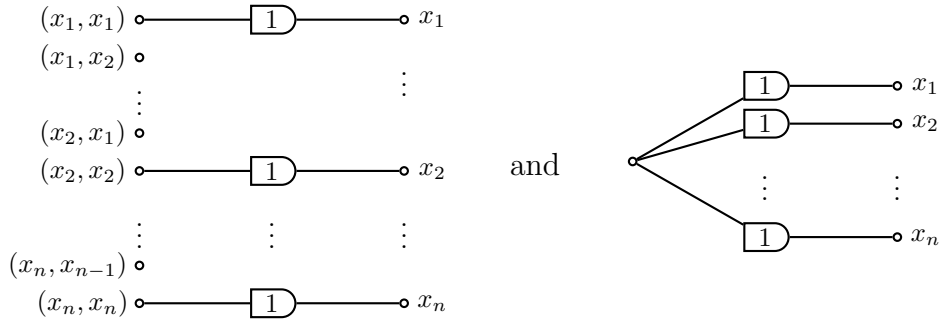

respectively, with the comultiplication and counit the mirror images.

These morphisms are multivalued matrices in the following sense: the cardinalities of the domain X and the codomain Y give the dimensions of the matrix, and the apex N indexes its entries. If $n \in N$ maps to $x \in X$ and $y \in Y$, we say there is an entry of value $s(n) \in \mathbb{R}$ in the x th row and y th column of the matrix. It is multivalued in the sense that there may be multiple entries in any position (x, y) of the matrix.

To construct matrices proper, and not just multivalued matrices, as decorated relations, we extend $R^{(-)}$ to the contravariant functor

$$R^{(-)} : (\text{Span}(\text{FinSet}), \times) \longrightarrow (\text{Set}, \times)$$

mapping now a span $N \xleftarrow{f} A \xrightarrow{g} M$ to the function

$$R^{f \circ p; g} : R^M \longrightarrow R^N;$$

$$v \longmapsto \left(n \mapsto \sum_{a \in f^{-1}(n)} v \circ g(a) \right).$$

It is simply a matter of computation to check this is functorial.

Decorated corelations in this category then comprise trivial spans $X \xleftarrow{\pi_X} X \times Y \xrightarrow{\pi_Y} Y$, where π is the projection given by the categorical product, together with a decoration $X \times Y \rightarrow R$. Such morphisms give a value of R for each pair $(x, y) \in X \times Y$, and thus are trivially in one-to-one correspondence with $|X| \times |Y|$ -matrices.

The map $R^{(-)}\text{Cospan} \rightarrow R^{(-)}\text{Corel}$ transports the decoration $N \times_Y M \rightarrow R$ along the function $N \times_Y M \rightarrow N \times M$ that identifies elements over the same pair (x, y) . In terms of the multivalued matrices, this sums over (the potentially empty) set of entries over (x, y) to create a single entry. It is thus easily observed that composition in this category is matrix multiplication. Moreover, it is not difficult to check that the monoidal product is the Kroenecker product of matrices, and thus that $R^{(-)}\text{Corel}$ is monoidally equivalent to the monoidal category of $(\text{FinVect}, \otimes)$ of finite dimensional vector spaces, linear maps, and the tensor product.

Note that R^X is always an R -module, and R^f a homomorphism of R -modules. Thus we could take decorations here in the category $R\text{Mod}$ of R -modules, rather than the category Set . While Proposition 2.10 shows that the resulting decorated cospan category would be isomorphic, this may hint at an enriched version of the theory.

4.5.2 Two constructions for linear relations

We saw in §3.4.2 that linear relations are epi-mono corelations in Vect . As linear relations thus form a hypergraph category LinRel , we can also give a decorated corelations construction.

Indeed, Theorem 4.13 shows that from the hom functor $\text{LinRel}(0, -)$ on the monoidal unit of the hypergraph category LinRel , we can build the functor

$$\text{Lin}: \text{Cospan}(\text{FinSet}) \longrightarrow \text{Set}$$

taking a finite set N to the set $\text{Lin}(N)$ of linear subspaces of the vector space k^N . Moreover, the image $\text{Lin}(f)$ of a function $f: N \rightarrow M$ maps a subspace $L \subseteq k^N$ to $\{v \mid v \circ f \in L\} \subseteq k^M$, while the image $\text{Lin}(f^{\text{op}})$ of an opposite function $g^{\text{op}}: N \rightarrow M$ maps a subspace $L \subseteq k^N$ to $\{v = u \circ g \mid u \in L\} \subseteq k^M$.

Given this functor, it can be shown that LinCospan is the category of cospans decorated by subspaces, while LinCorel is the category of linear relations.

This pair of constructions is important for circuits work [BF, BSZ14]. Recall the functor $\text{LinSub}: \text{FinSet} \rightarrow \text{Set}$ of Section 2.5, which takes a finite set X to the set of subspaces of $\mathbb{R}^X \oplus (\mathbb{R}^X)^*$. This may be extended to a functor $\text{Cospan}(\text{FinSet}) \rightarrow \text{Set}$, giving a decorated corelations category of linear relations where the objects are the direct sum of a vector space and its dual. Recall also that in Section 2.5 we discussed a functor

$$\text{GraphCospan} \rightarrow \text{LinSubCospan}$$

interpreting labelled graphs as linear subspaces. Composing this with the quotient functor $\text{LinSubCospan} \rightarrow \text{LinSubCorel}$, this gives a compositional linear relations

semantics for circuit diagrams. This hints at the material we explore in depth in Chapter 6.

Part II

Applications

Chapter 5

Signal flow diagrams

In this chapter we use corelations to guide the development of a graphical language for reasoning about linear time-invariant systems.

We begin in the next section with motivation and an overview of this chapter. In §5.2 we then develop a categorical account of complete LTI discrete dynamical systems. This serves as a denotational semantics for the graphical language, introduced in §5.3, where we also derive the equational characterisation. In §5.4 we relate this to an operational semantics, in terms of biinfinite streams of elements of k . We conclude in §5.5 with a structural account of controllability.

5.1 Behavioural control theory

Control theory begins with the following picture:

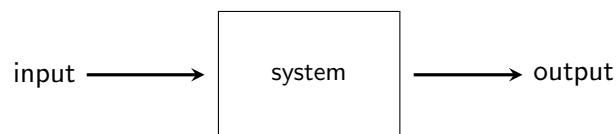

In this picture we have an object under study, referred to as a *system*, which when fed certain inputs produces certain outputs. These outputs need not be uniquely determined by the inputs; in general the relationship may be stochastic or non-deterministic, or depend also on internal states of the system. Although we take it as given that the system is an *open* system—so it interacts with its environment, and so we can observe its inputs and outputs—we assume no access to the details of these internal states or the inner workings of the system, and this can add considerable complexity to our models. The end goal of control theory is then to control the system: to understand how to influence its behaviour in order to achieve some desired goal. Two key questions arise:

- **Analysis:** Given a system, what is the relationship it induces between input and output?
- **Synthesis:** Given a target relationship between input and output, how do we build a system that produces this relationship?

The first, the question of system analysis, provides the basic understanding required to find the inputs that lead to the desired outputs. The second question, the question of synthesis, is the central question of feedback control theory, which aims to design controllers to regulate other systems. We give a brief overview of the field, illustrated with some questions of these kinds.

Control has a long history. Indeed, many systems found in the biology and chemistry of living organisms have interesting interpretations from a control theoretic viewpoint, such as those that are responsible for body temperature regulation or bipedal balance [Son04]. Human understanding of control developed alongside engineering, and so dates back at least as far as antiquity, with for example the ancient Romans devising elaborate systems to maintain desired water levels in aqueducts [Son98]. The origin of formal mathematical control theory, however, is more recent, and in general taken to be James Clerk Maxwell's seminal analysis of centrifugal governors, presented to the Royal Society of London in 1868 [Max68].

The techniques used and developed from Maxwell's paper, in particular by Rayleigh and Heaviside, are in general known as *transfer function* techniques. A transfer function is a linear map from the set of inputs to the set of outputs of a linear time-invariant system with zero initial conditions. Transfer functions are commonly used in the analysis of single-input single-output linear systems, but become unwieldy or inapplicable for more general systems.

In the 1960s, led by Wiener and Kalman, so-called *state space* techniques were developed to address multiple-input multiple-output, time-varying, nonlinear systems [Fri86]. These methods are characterised by defining a system as a collection of input, output, and internal state variables, with the state changing as a function of the input and state variables over time, and the output a function of the input and state. These functions are often implicitly specified by differential equations.

In general, however, classical control theory remains grounded in a paradigm that defines and analyses systems in terms of inputs and outputs or, from another perspective, causes and effects. In recent years Willems, among others, has argued that this input-output perspective is limiting, as in the case of many systems studied through control theory there is no clear distinction between input and output variables

[Wil07]. For example, given a circuit component for which the relevant variables are the voltages and currents, different contexts may call for the voltage to be viewed as the input and current output, or vice versa. It is useful to have a single framework capable of discussing the behaviour of the component without making this choice.

Moreover, in the drive to understand larger and more complex systems, increasing emphasis has been put on understanding the way systems can be broken down into composite subsystems, and conversely how systems link together to form larger systems [Wil89, KT84]. Indeed, interconnection or composition of systems has always played a central role in systems engineering, and the difficulty of discussing how systems compose within an input-output framework lends support to Willems' call for a more nuanced definition of control system. To illustrate these difficulties, consider the simple example, due to Willems, of two water tanks each with two access pipes:

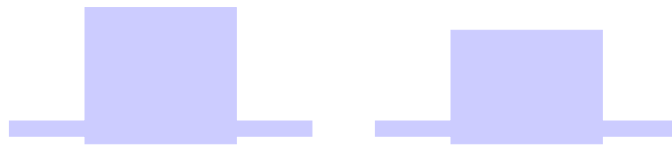

For each tank, the relevant variables are the pressure p and the flow f . A typical control theoretic analysis might view the water pressure as inducing flow through the tank, and hence take pressure as the input variable, flow as the output variable, and describe each tank as a transfer function $H_{\bullet} : P_{\bullet} \rightarrow F_{\bullet}$ between the sets P_{\bullet} and F_{\bullet} these vary over.

Ideally then, the composite system below, connecting pipe 2 of Tank A to pipe 1 of Tank B , would be described by the composite of the transfer functions H_A and H_B of these tanks.

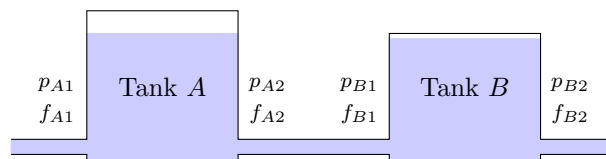

This is rarely the case, and indeed makes little sense: the output of transfer function H_A describes the flow through Tank A , while the domain of the transfer function H_B describes pressures through Tank B , so taking the output of H_A as the input of H_B runs into type issues. Instead, here the relationship between the transfer functions H_A and H_B , and the transfer function H_{AB} of the composite system can be understood through the fact that connection requires that the pressure at pipe 1 of Tank A must

be equal to the pressure at pipe 2 of Tank B , and that the flow out of the former pipe must equal the flow into the latter—that is, by imposing the relations

$$\begin{aligned} p_{A2} &= p_{B1} \\ f_{A2} &= -f_{B1} \end{aligned}$$

on the variables. Indeed in many contexts, hydraulics and electronics among them, connections between systems are characterised not by the ‘output’ of one system forming the ‘input’ of the next, but by *variable sharing* between the systems. Such relations are often difficult to describe using the language of transfer functions and state space methods.

The themes of this thesis fit tightly into this programme of modelling control theoretic systems with an emphasis on interconnection—Willems’ so-called behavioural approach. Willems first demonstrated this approach in the setting of linear time-invariant discrete-time (LTI) dynamical systems [Wil86]. A limitation of the approach has been lack of formal language for representing and reasoning about the interconnection of systems. In this chapter we address this by developing a graphical language for LTI systems.

The expressions of this graphical language, closely resembling the signal flow graphs of Shannon [Sha42], will form the morphisms of a category of corelations, and its derivation as such will be crucial in developing a sound and complete equational theory of LTI systems.

To acquaint ourselves with signal flow graphs, we begin with the example below, rendered in traditional, directed notation.

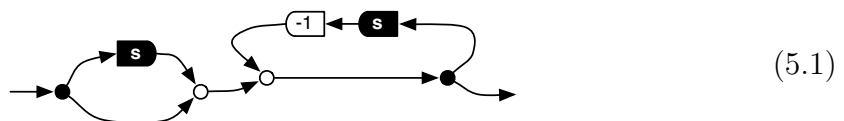

This system takes, as input on the left, a stream of values from a field k , e.g. the rational numbers, and on the right outputs a processed stream of values. The white circles are adders, the black circles are duplicators, the s gates are 1-step delays and the -1 gate is an instance of an amplifier that outputs -1 times its input. Processing is done synchronously according to a global clock.

For instance, assume that at time 0 the left s gate ‘stores’ the value 1 and the right s gate stores 2. Given an input of -1 , the flow graph first adds the left stored value 1, and then adds -1×2 , for an output of -2 . Immediately after this time step the s gates, acting as delays, now store -1 and -2 respectively, and we repeat the

process with the next input. Thus from this time 0 an input stream of $-1, 1, -1, 1 \dots$ results in an output stream of $-2, 2, -2, 2, \dots$

We can express (5.1) as a string diagram by forgetting the directionality of wires and composing the following basic building blocks using the operations of monoidal categories:

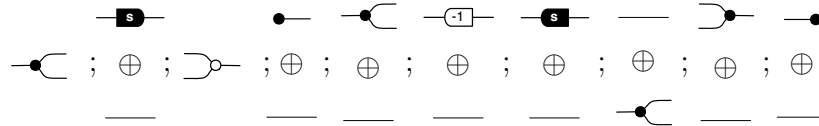

The building blocks come from the signature of an algebraic theory—a *symmetric monoidal theory* to be exact. The terms of this theory comprise the morphisms of a *prop*, a symmetric monoidal category in which the objects are the natural numbers. With an operational semantics suggested by the above example, the terms can also be considered as a process algebra for signal flow graphs. The idea of understanding complex systems by “tearing” them into more basic components, “zooming” to understand their individual behaviour and “linking” to obtain a composite system is at the core of the behavioural approach in control. The algebra of symmetric monoidal categories thus seems a good fit for a formal account of these compositional principles.

This work is the first to make this link between monoidal categories and the behavioural approach to control explicit. Moreover, it is the first to endow signal flow graphs with their standard systems theoretic semantics in which the registers—the ‘s’ gates—are permitted to hold *arbitrary* values at the beginning of a computation. This extended notion of behaviour is not merely a theoretical curiosity: it gives the class of *complete LTI discrete dynamical systems*. The interest of systems theorists is due to practical considerations: physical systems seldom evolve from zero initial conditions.

Although previous work [BSZ16, BSZ15, Zan15] made the connection between signal flow graphs and string diagrams, their operational semantics is more restrictive than that considered here, considering only trajectories with finite past and demanding that, initially, all the registers contain the value 0. Indeed, with this restriction, it is not difficult to see that the trajectories of (5.1) are those where the output is *the same* as the input. The input/output behaviour is thus that of a stateless wire. The equational presentation in this case is the theory $\mathbb{HH}_{k[s]}$ of interacting Hopf algebras

[Zan15], and indeed, in $\mathbb{H}_{k[s]}$:

$$\text{Diagram} = \text{Diagram} = \text{Diagram} \quad (5.2)$$

Note that (5.2) is *not sound* for circuits with our more liberal, operational semantics. Indeed, recall that when the registers of (5.1) initially hold values 1 and 2, the input $-1, 1, -1, 1, \dots$ results in the output $-2, 2, -2, 2, \dots$. This trajectory is not permitted by a stateless wire, so $\mathbb{H}_{k[s]}$ is not sound for reasoning about LTI systems in general. We have provided a sound and complete theory to do just that.

In terms of the algebraic semantics, the difference from previous work is that where there streams were handled with Laurent (formal power) series, here we use biinfinite streams. These are sequences of elements of k that are infinite in the past *as well* as in the future—that is, elements of $k^{\mathbb{Z}}$. Starting with the operational description, one obtains a biinfinite trajectory by executing circuits forwards and backwards in time, for some initialisation of the registers. The dynamical system defined by a signal flow diagram is the set of trajectories obtained by considering all possible executions from all possible initialisations. Indeed, this is the very extension that allows us to discuss non-controllable behaviours; in [BSZ14, BSZ15, Zan15, BE15] all definable behaviours were controllable.

An equational theory also requires equations between the terms. We obtain the equations in two steps. First, we show there is a full, but not faithful, morphism from the prop $\text{Cospan Mat } k[s, s^{-1}]$ of cospans of matrices over the ring $k[s, s^{-1}]$ to the prop LTI of complete LTI discrete dynamical systems. Using the presentation of $\text{Cospan Mat } k[s, s^{-1}]$ in [BSZ16, Zan15], the result is a sound, but not complete, proof system. The second ingredient is restricting our attention from cospans to corelations. This gives a faithful morphism, allowing us to present the prop of corelations as a symmetric monoidal theory, and hence giving a sound and complete proof system for reasoning about LTIs (Theorem 5.15).

The advantages of the string diagram calculus over the traditional matrix calculus are manifold. The operational semantics make the notation intuitive, as does the compositional aspect: it is cumbersome to describe connection of systems using matrices, whereas with string diagrams you just connect the right terminals. Moreover, the calculus unifies the variety of distinct methods for representing LTI systems with matrix equations—built from kernel and image representations [Wil07, Wil86]—into a single framework, heading off possibilities for ambiguity and confusion.

We hope, however, the greatest advantage will be the way these properties can be leveraged in analysis of controllability. In Theorem 5.24, we show that in our setting controllability has an elegant structural characterisation. Compositionality pays off here, with our proof system giving a new technique for reasoning about control of compound systems (Proposition 5.28). From the systems theoretic point of view, these results are promising since the compositional, diagrammatic techniques we bring to the subject seem well-suited to problems such as controllability of interconnections, of primary interest for multiagent and spatially interconnected systems [OFM07].

5.2 Linear time-invariant dynamical systems

Following Willems [Wil86], a **dynamical system** (T, W, \mathcal{B}) is: a **time axis** T , a **signal space** W , and a **behaviour** $\mathcal{B} \subseteq W^T$. We refer to $w \in \mathcal{B}$ as **trajectories**.

Here we are interested in discrete trajectories that are **biinfinite**: infinite in past and future. Our time axis is thus the integers \mathbb{Z} . Let k be a field: for concreteness one may take this to be the rationals \mathbb{Q} , the reals \mathbb{R} or the booleans \mathbb{Z}_2 . The signal space is k^d , where d is the number of **terminals** of a system. These, in engineering terms, are the interconnection variables that enable interaction with an environment.

The dynamical systems of concern to us are thus specified by some natural number d and a subset \mathcal{B} of $(k^d)^{\mathbb{Z}}$. The sets $(k^d)^{\mathbb{Z}}$ are k -vector spaces, with pointwise addition and scalar multiplication. We restrict attention to *linear* systems, meaning that \mathcal{B} is required to be a *k -linear subspace*—i.e. closed under addition and multiplication by k -scalars—of $(k^d)^{\mathbb{Z}}$.

We partition terminals into a *domain* and *codomain* of m and n terminals respectively, writing $\mathcal{B} \subseteq (k^m)^{\mathbb{Z}} \oplus (k^n)^{\mathbb{Z}} \cong (k^d)^{\mathbb{Z}}$. This may seem artificial, in the sense that the assignment is arbitrary. In particular, it is crucial not to confuse the domains (codomains) with inputs (outputs). In spite of the apparent contrivedness of choosing such a partition, Willems and others have argued that it is vital for a sound theory of system *decomposition*; indeed, it enables the “tearing” of Willems’ tearing, zooming and linking [Wil07].

Once the domains and codomains have been chosen, systems are linked by connecting terminals. In models of physical systems this means variable coupling or sharing; in our discrete setting where behaviours are subsets of a cartesian product—i.e. relations—it amounts to relational composition. Since behaviours are both relations and linear subspaces, a central underlying mathematical notion is a linear relation.

A behaviour is **time-invariant** when for every trajectory $w \in \mathcal{B}$ and any fixed $i \in \mathbb{Z}$, the trajectory whose value at every time $t \in \mathbb{Z}$ is $w(t+i)$ is also in \mathcal{B} . Time-invariance brings with it a connection with the algebra of polynomials. Following the standard approach in control theory, going back to Rosenbrock [Ros70], we work with polynomials over an indeterminate s as well as its formal inverse s^{-1} —i.e. the elements of the ring $k[s, s^{-1}]$.

The indeterminate s acts on a given biinfinite stream $w \in k^{\mathbb{Z}}$ as a one-step delay, and s^{-1} as its inverse, a one step anticipation:

$$(s \cdot w)(t) \stackrel{\text{def}}{=} w(t-1), \quad (s^{-1} \cdot w)(t) \stackrel{\text{def}}{=} w(t+1).$$

We can extend this, in the obvious linear, pointwise manner, to an action of any polynomial $p \in k[s, s^{-1}]$ on w . Since $k^{\mathbb{Z}}$ is a k -vector space, any such p defines a k -linear map $k^{\mathbb{Z}} \rightarrow k^{\mathbb{Z}}$ ($w \mapsto p \cdot w$).

Given this, we can view $n \times m$ matrices over $k[s, s^{-1}]$ as k -linear maps from $(k^m)^{\mathbb{Z}}$ to $(k^n)^{\mathbb{Z}}$. This viewpoint can be explained succinctly as a functor from the prop $\text{Mat } k[s, s^{-1}]$, defined below, to the category of k -vector spaces and linear transformations Vect_k .

Recall that a **prop** is a strict symmetric monoidal category where the set of objects is the natural numbers \mathbb{N} , and monoidal product (\oplus) on objects is addition. Homomorphism of props are identity-on-objects strict symmetric monoidal functors.

Definition 5.1. The prop $\text{Mat } k[s, s^{-1}]$ has as arrows $m \rightarrow n$ the $n \times m$ -matrices over $k[s, s^{-1}]$. Composition is matrix multiplication, and the monoidal product of A and B is $\begin{bmatrix} A & 0 \\ 0 & B \end{bmatrix}$. The symmetries are permutation matrices.

The functor of interest

$$\theta: \text{Mat } k[s, s^{-1}] \longrightarrow \text{Vect}_k$$

takes a natural number n to $(k^n)^{\mathbb{Z}}$, and an $n \times m$ matrix to the induced linear transformation $(k^m)^{\mathbb{Z}} \rightarrow (k^n)^{\mathbb{Z}}$. Note that θ is faithful.

The final restriction on the set of behaviours is called *completeness*, and is a touch more involved. For $t_0, t_1 \in \mathbb{Z}$, $t_0 \leq t_1$, write $w|_{[t_0, t_1]}$ for the restriction of $w: \mathbb{Z} \rightarrow k^n$ to the set $[t_0, t_1] = \{t_0, t_0+1, \dots, t_1\}$. Write $\mathcal{B}|_{[t_0, t_1]}$ for the set of the restrictions of all trajectories $w \in \mathcal{B}$ to $[t_0, t_1]$. Then \mathcal{B} is **complete** when $w|_{[t_0, t_1]} \in \mathcal{B}|_{[t_0, t_1]}$ for all $t_0, t_1 \in \mathbb{Z}$ implies $w \in \mathcal{B}$. This topological condition is important as it characterises the linear time-invariant behaviours that are kernels of the action of $\text{Mat } k[s, s^{-1}]$; see Theorem 5.4.

Definition 5.2. A **linear time-invariant (LTI) behaviour** comprises a domain $(k^m)^\mathbb{Z}$, a codomain $(k^n)^\mathbb{Z}$, and a subset $\mathcal{B} \subseteq (k^m)^\mathbb{Z} \oplus (k^n)^\mathbb{Z}$ such that $(\mathbb{Z}, k^m \oplus k^n, \mathcal{B})$ is a complete, linear, time-invariant dynamical system.

The algebra of LTI behaviours is captured concisely as a prop.

Proposition 5.3. *There exists a prop LTI with morphisms $m \rightarrow n$ the LTI behaviours with domain $(k^m)^\mathbb{Z}$ and codomain $(k^n)^\mathbb{Z}$. Composition is relational. The monoidal product is direct sum.*

The proof of Proposition 5.3 relies on *kernel representations* of LTI systems. The following result lets us pass between behaviours and polynomial matrix algebra.

Theorem 5.4 (Willems [Wil86, Theorem 5]). *Let \mathcal{B} be a subset of $(k^n)^\mathbb{Z}$ for some $n \in \mathbb{N}$. Then \mathcal{B} is an LTI behaviour iff there exists $M \in \text{Mat } k[s, s^{-1}]$ such that $\mathcal{B} = \ker(\theta M)$.*

The prop $\text{Mat } k[s, s^{-1}]$ is equivalent to the category $\text{FMod } k[s, s^{-1}]$ of finite dimensional free $k[s, s^{-1}]$ -modules. Since $\text{FMod } R$ over a principal ideal domain (PID) R has finite colimits [BSZ16], and $k[s, s^{-1}]$ is a PID, $\text{Mat } k[s, s^{-1}]$ has finite colimits, and thus it has pushouts.

We can therefore define the prop $\text{Cospan Mat } k[s, s^{-1}]$ where arrows are (isomorphism classes of) cospans of matrices: arrows $m \rightarrow n$ comprise a natural number d together with a $d \times m$ matrix A and a $d \times n$ matrix B ; we write this $m \xrightarrow{A} d \xleftarrow{B} n$.

We can then extend θ to the functor

$$\Theta: \text{Cospan Mat } k[s, s^{-1}] \longrightarrow \text{LinRel}_k$$

where on objects $\Theta(n) = \theta(n) = (k^n)^\mathbb{Z}$, and on arrows

$$m \xrightarrow{A} d \xleftarrow{B} n$$

maps to

$$\{(\mathbf{x}, \mathbf{y}) \mid (\theta A)\mathbf{x} = (\theta B)\mathbf{y}\} \subseteq (k^m)^\mathbb{Z} \oplus (k^n)^\mathbb{Z}. \quad (5.3)$$

It is straightforward to prove that this is well defined.

Proposition 5.5. *Θ is a functor.*

Proof. Identities are clearly preserved; it suffices to show that composition is too. Consider the diagram below, where the pushout is calculated in $\text{Mat } k[s, s^{-1}]$.

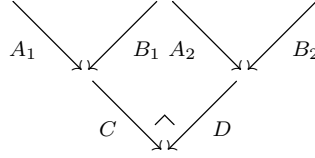

To show that Θ preserves composition we must verify that

$$\{(\mathbf{x}, \mathbf{y}) \mid \theta C A_1 \mathbf{x} = \theta D B_2 \mathbf{y}\} = \{(\mathbf{x}, \mathbf{z}) \mid \theta A_1 \mathbf{x} = \theta B_1 \mathbf{z}\}; \{(\mathbf{z}, \mathbf{y}) \mid \theta A_2 \mathbf{z} = \theta B_2 \mathbf{y}\}.$$

The inclusion \subseteq follows from properties of pushouts in $\text{Mat } k[s, s^{-1}]$ (see [BSZ16, Proposition 5.7]). To see \supseteq , we need to show that if there exists \mathbf{z} such that $\theta A_1 \mathbf{x} = \theta B_1 \mathbf{z}$ and $\theta A_2 \mathbf{z} = \theta B_2 \mathbf{y}$, then $\theta C A_1 \mathbf{x} = \theta D B_2 \mathbf{y}$. But $\theta C A_1 \mathbf{x} = \theta C B_1 \mathbf{z} = \theta D A_2 \mathbf{z} = \theta D B_2 \mathbf{y}$. \square

Rephrasing the definition of Θ on morphisms (5.3), the behaviour consists of those (\mathbf{x}, \mathbf{y}) that satisfy

$$\theta \begin{bmatrix} A & -B \end{bmatrix} \begin{bmatrix} \mathbf{x} \\ \mathbf{y} \end{bmatrix} = \mathbf{0},$$

so one may say—ignoring for a moment the terminal domain/codomain assignment—that

$$\Theta(\overset{A}{\rightarrow} \overset{B}{\leftarrow}) = \ker \theta \begin{bmatrix} A & -B \end{bmatrix}.$$

With this observation, as a consequence of Theorem 5.4, Θ has as its image (essentially) the prop LTI. This proves Proposition 5.3. We may thus consider Θ a functor onto the codomain LTI; denote this corestriction $\bar{\Theta}$. We thus have a full functor:

$$\bar{\Theta}: \text{Cospan Mat } k[s, s^{-1}] \longrightarrow \text{LTI}.$$

Remark 5.6. It is important for the sequel to note that $\bar{\Theta}$ is *not* faithful. For instance, $\bar{\Theta}(1 \xrightarrow{[1]} 1 \xleftarrow{[1]} 1) = \bar{\Theta}(1 \xrightarrow{\begin{bmatrix} 1 \\ 0 \end{bmatrix}} 2 \xleftarrow{\begin{bmatrix} 1 \\ 0 \end{bmatrix}} 1)$, yet the cospans are not isomorphic. The task of the next section is to develop a setting where these cospans are nonetheless *equivalent*.

5.3 Presentation of LTI

Recall that a **symmetric monoidal theory** (SMT) is a presentation of a prop: a pair (Σ, E) where Σ is a set of **generators** $\sigma: m \rightarrow n$, where m is the **arity** and n the **coarity**. A Σ -term is a obtained from Σ , identity $\text{id}: 1 \rightarrow 1$ and symmetry $\text{tw}: 2 \rightarrow 2$ by composition and monoidal product, according to the grammar

$$\tau ::= \sigma \mid \text{id} \mid \text{tw} \mid \tau ; \tau \mid \tau \oplus \tau$$

where $;$ and \oplus satisfy the standard typing discipline that keeps track of the domains (arities) and codomains (coarities)

$$\frac{\tau : m \rightarrow d \quad \tau' : d \rightarrow n}{\tau ; \tau' : m \rightarrow n} \quad \frac{\tau : m \rightarrow n \quad \tau' : m' \rightarrow n'}{\tau \oplus \tau' : m + m' \rightarrow n + n'}$$

The second component E of an SMT is a set of **equations**, where an equation is a pair (τ, μ) of Σ -terms with compatible types, i.e. $\tau, \mu: m \rightarrow n$ for some $m, n \in \mathbb{N}$.

Given an SMT (Σ, E) , the prop $\mathbf{S}_{(\Sigma, E)}$ has as arrows the Σ -terms quotiented by the smallest congruence that includes the laws of symmetric monoidal categories and equations E . We sometimes abuse notation by referring to $\mathbf{S}_{(\Sigma, E)}$ as an SMT. Given an arbitrary prop \mathbb{X} , a **presentation** of \mathbb{X} is an SMT (Σ, E) s.t. $\mathbb{X} \cong \mathbf{S}_{(\Sigma, E)}$.

In this section we give a presentation of LTI as an SMT. This means that (i) we obtain a syntax—conveniently expressed using string diagrams—for specifying every LTI behaviour, and (ii) a sound and complete equational theory for reasoning about them.

5.3.1 Syntax

We start by describing the graphical syntax of dynamical systems, the arrows of the category $\mathbb{S} = \mathbf{S}_{(\Sigma, \emptyset)}$, where Σ is the set of generators:

$$\left\{ \begin{array}{c} \text{---} \circlearrowleft \text{---}, \quad \text{---} \circ \text{---}, \quad \text{---} \bullet \text{---}, \quad \text{---} \bullet \text{---}, \quad \text{---} \text{---} \text{---} \text{---}, \quad \text{---} \circlearrowright \text{---}, \quad \text{---} \circ \text{---}, \quad \text{---} \bullet \text{---}, \quad \text{---} \bullet \text{---}, \quad \text{---} \text{---} \text{---} \text{---} \end{array} \right\} \\ \cup \left\{ \text{---} \text{---} \text{---} \text{---} \mid a \in k \right\} \cup \left\{ \text{---} \text{---} \text{---} \text{---} \mid a \in k \right\} \quad (5.4)$$

For each generator, we give its denotational semantics, an LTI behaviour, thereby defining a prop morphism $\llbracket - \rrbracket : \mathbb{S} \rightarrow \text{LTI}$.

$$\text{---} \circlearrowleft \text{---} \mapsto \left\{ \left(\begin{pmatrix} \tau \\ v \end{pmatrix}, \tau + v \right) \mid \tau, v \in k^{\mathbb{Z}} \right\} : 2 \rightarrow 1$$

$$\text{---} \circ \text{---} \mapsto \left\{ \left((), 0 \right) \right\} \subseteq k^{\mathbb{Z}} : 0 \rightarrow 1$$

$$\begin{aligned}
\text{---}\bullet\text{---} &\mapsto \{(\tau, \binom{\tau}{\tau}) \mid \tau \in k^{\mathbb{Z}}\}: 1 \rightarrow 2 \\
\text{---}\bullet &\mapsto \{(\tau, ()) \mid \tau \in k^{\mathbb{Z}}\}: 1 \rightarrow 0 \\
\text{---}\boxed{a}\text{---} &\mapsto \{(\tau, a \cdot \tau) \mid \tau \in k^{\mathbb{Z}}\}: 1 \rightarrow 1 \quad (a \in k) \\
\text{---}\boxed{s}\text{---} &\mapsto \{(\tau, s \cdot \tau) \mid \tau \in k^{\mathbb{Z}}\}: 1 \rightarrow 1
\end{aligned}$$

The denotations of the mirror image generators are the opposite relations. Parenthetically, we note that a finite set of generators is possible over a finite field, or the field \mathbb{Q} of rationals, *cf.* §5.3.2.

The following result guarantees that the syntax is fit for purpose: every behaviour in LTI has a syntactic representation in \mathbb{S} .

Proposition 5.7. $\llbracket - \rrbracket : \mathbb{S} \rightarrow \text{LTI}$ is full.

Proof. The fact that $\llbracket - \rrbracket$ is a prop morphism is immediate since \mathbb{S} is free on the SMT (Σ, \emptyset) with no equations. Fullness follows from the fact that $\llbracket - \rrbracket$ factors as the composite of two full functors:

$$\begin{array}{ccc}
\mathbb{S} & & \\
\downarrow & \searrow \llbracket - \rrbracket & \\
\text{Cospan Mat } k[s, s^{-1}] & \xrightarrow{\bar{\Theta}} & \text{LTI}
\end{array}$$

The functor $\bar{\Theta}$ is full by definition. The existence and fullness of the functor $\mathbb{S} \rightarrow \text{Cospan } k[s, s^{-1}]$ follows from [Zan15, Theorem 3.41]. We give details in the next two subsections. \square

Having defined the syntactic prop \mathbb{S} capable of representing every behaviour in LTI, our task for this section is to identify an equational theory that *characterises* equivalent representations in LTI: i.e. one that is sound and complete. The first step is to use the existence of $\bar{\Theta}$: with the results of [BSZ16, Zan15] we can obtain a presentation for $\text{Cospan Mat } k[s, s^{-1}]$. This is explained in the next subsection, where we present $\text{Mat } k[s, s^{-1}]$ and $\text{Cospan Mat } k[s, s^{-1}]$.

5.3.2 Presentations of $\text{Mat } k[s, s^{-1}]$ and $\text{Cospan Mat } k[s, s^{-1}]$

To obtain a presentation of $\text{Mat } k[s, s^{-1}]$ as an SMT we only require some of the generators:

$$\{ \text{---}\circ\text{---}, \text{---}\circ\text{---}, \text{---}\bullet\text{---}, \text{---}\bullet, \text{---}\boxed{s}\text{---}, \text{---}\boxed{s}\text{---} \} \cup \{ \text{---}\boxed{a}\text{---} \mid a \in k \}$$

and the following equations. First, the white and the black structure forms a (bicommutative) bimonoid:

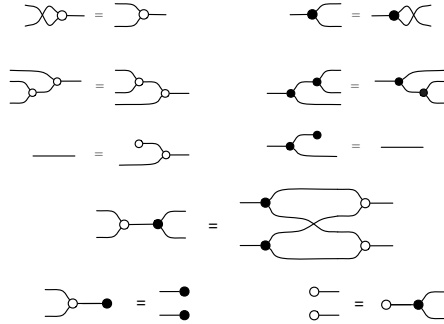

Next, the formal indeterminate s is compatible with the bimonoid structure and has its mirror image as a formal inverse.

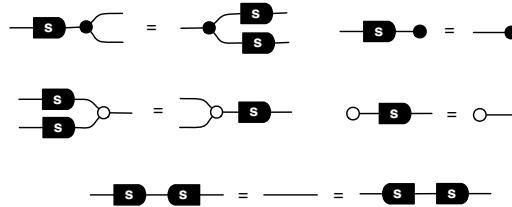

Finally, we insist that the algebra of k be compatible with the bimonoid structure and commute with s .

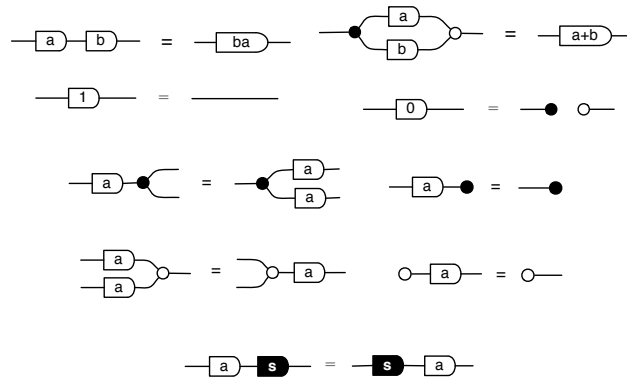

The three sets of equations above form the theory of Hopf algebras. Write $\mathbb{H}\mathbb{A}_{k[s, s^{-1}]}$ for the prop induced by the SMT consisting of the equations above. The following follows from [Zan15, Proposition 3.9].

Proposition 5.8. $\text{Mat } k[s, s^{-1}] \cong \mathbb{H}\mathbb{A}_{k[s, s^{-1}]}$.

Arrows of $\text{Mat } k[s, s^{-1}]$ are matrices with polynomial entries, but it may not be obvious to the reader how polynomials arise with the string diagrammatic syntax. We illustrate this below.

Example 5.9. Any polynomial $p = \sum_{i=u}^v a_i s^i$, where $u \leq v \in \mathbb{Z}$ and with coefficients $a_i \in k$, can be written graphically using the building blocks of $\mathbb{H}\mathbb{A}_{k[s, s^{-1}]}$. Rather than giving a tedious formal construction, we illustrate this with an example for $k = \mathbb{R}$. A term for $3s^{-3} - \pi s^{-1} + s^2$ is:

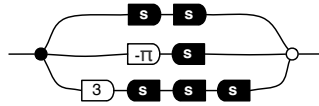

As an arrow $1 \rightarrow 1$ in $\text{Mat } \mathbb{R}[s, s^{-1}]$, the above term represents a 1×1 -matrix over $\mathbb{R}[s, s^{-1}]$. To demonstrate how higher-dimensional matrices can be written, we also give a term for the 2×2 -matrix $\begin{bmatrix} 2 & 3s \\ s^{-1} & s + 1 \end{bmatrix}$:

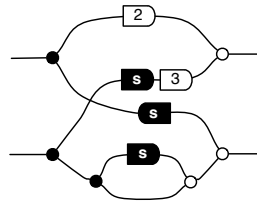

The above examples are intended to be suggestive of a normal form for terms in $\mathbb{H}\mathbb{A}_{k[s, s^{-1}]}$; for further details see [Zan15].

To obtain the equational theory of $\text{Cospan Mat } k[s, s^{-1}]$ we need the full set of generators (5.4), along with the equations of $\mathbb{H}\mathbb{A}_{k[s, s^{-1}]}$, their mirror images, and the following

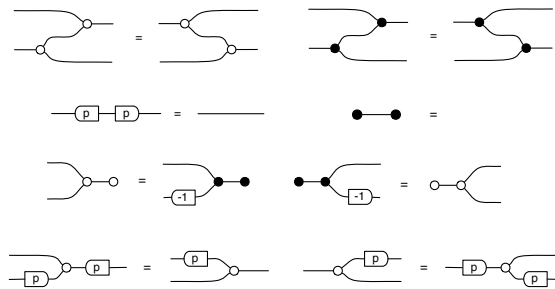

where p ranges over the nonzero elements of $k[s, s^{-1}]$ (see Example 5.9). Note that in the second equation on the right-hand side, we use the so-called ‘empty diagram’, or blank space, to represent the identity map on the monoidal unit, 0.

The equations of $\mathbb{H}\mathbb{A}_{k[s, s^{-1}]}$ ensure the generators of $\mathbb{H}\mathbb{A}_{k[s, s^{-1}]}$ behave as morphisms in $\text{Mat } k[s, s^{-1}]$, while their mirror images ensure the remaining generators behave as morphisms in the opposite category $\text{Mat } k[s, s^{-1}]^{\text{op}}$. The additional equations above

govern the interaction between these two sets of generators, axiomatising pushouts in $\text{Mat } k[s, s^{-1}]$. Let $\mathbb{III}^{\text{Csp}}$ denote the resulting SMT. The procedure for obtaining the equations from a distributive law of props is explained in [Zan15, §3.3].

Proposition 5.10 (Zanasi [Zan15, Theorem 3.41]).

$$\text{Cospan Mat } k[s, s^{-1}] \cong \mathbb{III}^{\text{Csp}}.$$

Using Proposition 5.10 and the existence of $\bar{\Theta}$, the equational theory of $\mathbb{III}^{\text{Csp}}$ is a sound proof system for reasoning about LTI. Due to the fact that $\bar{\Theta}$ is not faithful (see Remark 5.6), however, the system is not complete. Achieving completeness is our task for the remainder of this section.

5.3.3 Corelations in $\text{Mat } k[s, s^{-1}]$

In this subsection we identify a factorisation system in $\text{Mat } k[s, s^{-1}]$, and show that the induced prop $\text{Corel Mat } k[s, s^{-1}]$ of corelations is isomorphic to LTI. We then give a presentation of $\text{Corel Mat } k[s, s^{-1}]$ and arrive at a sound and complete equational theory for LTI.

Recall that split mono is a morphism $m: X \rightarrow Y$ such that there exists $m': Y \rightarrow X$ with $m'm = \text{id}_X$. Every morphism in $\text{Mat } k[s, s^{-1}]$ admits a factorisation into an epi followed by a split mono.

Proposition 5.11. *Every morphism $R \in \text{Mat } k[s, s^{-1}]$ can be factored as $R = BA$, where A is an epi and B is a split mono.*

Proof. Given any matrix R , the Smith normal form [Kai80, Section 6.3] gives us $R = VDU$, where U and V are invertible, and D is diagonal. In graphical notation we can write it thus:

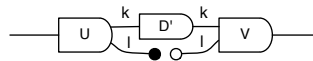

This implies we may write it as $R = U'; D'; V'$, where U' is a split epimorphism, D' diagonal of full rank, and V' a split monomorphism. Explicitly, the construction is given by

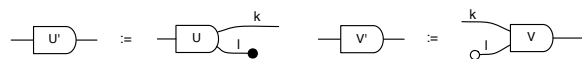

Recall that $k[s, s^{-1}]$ is a PID, so the full rank diagonal matrix D' is epi. It can be checked that $R = V'(D'U')$ is an epi-split mono factorisation. \square

Recalling the argument in Example 3.2, Proposition 5.11 yields:

Corollary 5.12. *Let \mathcal{E} be the subcategory of epis and \mathcal{M} the subcategory of split monos. The pair $(\mathcal{E}, \mathcal{M})$ is a factorisation system on $\text{Mat } k[s, s^{-1}]$, with \mathcal{M} stable under pushout.*

Definition 5.13. The prop $\text{Corel Mat } k[s, s^{-1}]$ has as morphisms equivalence classes of jointly epic cospans in $\text{Mat } k[s, s^{-1}]$.

We have a full morphism

$$F: \text{Cospan Mat } k[s, s^{-1}] \longrightarrow \text{Corel Mat } k[s, s^{-1}]$$

mapping a cospan to its jointly epic counterpart given by the factorisation system. Then $\bar{\Theta}$ factors through F as follows:

$$\begin{array}{ccc} \text{Cospan Mat } k[s, s^{-1}] & & \\ \downarrow F & \searrow \bar{\Theta} & \\ \text{Corel Mat } k[s, s^{-1}] & \xrightarrow{\Phi} & \text{LTI} \end{array}$$

The morphism Φ along the base of this triangle is an isomorphism of props, and this is our main technical result, Theorem 5.15. The proof relies on the following beautiful result of systems theory.

Proposition 5.14 (Willems [Wil86, p.565]). *Let M, N be matrices over $k[s, s^{-1}]$. Then $\ker \theta M \subseteq \ker \theta N$ iff \exists a matrix X s.t. $XM = N$.*

Further details and a brief history of the above proposition can be found in Schumacher [Sch88, pp.7–9].

Theorem 5.15. *There is an isomorphism of props*

$$\Phi: \text{Corel Mat } k[s, s^{-1}] \longrightarrow \text{LTI}$$

taking a corelation $\overset{A}{\rightarrow} \overset{B}{\leftarrow}$ to $\bar{\Theta}(\overset{A}{\rightarrow} \overset{B}{\leftarrow}) = \ker \theta[A \quad - B]$.

Proof. For functoriality, start from $\theta: \text{Mat } k[s, s^{-1}] \rightarrow \text{Vect}$. Now (i) Vect has an epi-mono factorisation system, (ii) θ maps epis to epis and (iii) split monos to monos, so θ preserves factorisations. Since it is a corollary of Proposition 5.5 that θ preserves colimits, it follows that θ extends to $\Psi: \text{Corel Mat } k[s, s^{-1}] \rightarrow \text{Corel Vect}$. But Corel Vect is isomorphic to LinRel (see §3.4.2). By Theorem 5.4, the image of Ψ is

LTI, and taking the corestriction to LTI gives us precisely Φ , which is therefore a full morphism of props.

As corelations $n \rightarrow m$ are in one-to-one correspondence with epis out of $n + m$, to prove faithfulness it suffices to prove that if two epis R and S with the same domain have the same kernel, then there exists an invertible matrix U such that $UR = S$. This is immediate from Proposition 5.14: if $\ker R = \ker S$, then we can find U, V such that $UR = S$ and $VS = R$. Since R is an epimorphism, and since $VUR = VS = R$, we have that $VU = 1$ and similarly $UV = 1$. This proves that any two corelations with the same image are isomorphic, and so Φ is full and faithful. \square

5.3.4 Presentation of $\text{Corel Mat } k[s, s^{-1}]$

Thanks to Theorem 5.15, the task of obtaining a presentation of LTI is that of obtaining one for $\text{Corel Mat } k[s, s^{-1}]$. To do this, we start with the presentation $\mathbb{III}^{\text{Csp}}$ for $\text{Cospan Mat } k[s, s^{-1}]$ of §5.3.2; the task of this section is to identify the additional equations that equate exactly those cospans that map via F to the same corelation.

In fact, only one new equation is required, the ‘white bone’ or ‘extra’ law:

$$\circ \text{---} \circ = \quad (5.5)$$

where we have carefully drawn the empty diagram to the right of the equality symbol. Expressed in terms of cospans, equation (5.5) asserts that $0 \rightarrow 1 \leftarrow 0$ and $0 \rightarrow 0 \leftarrow 0$ are identified: indeed, the two clearly yield the same corelation. The intuition here is that cospans $X \xrightarrow{i} S \xleftarrow{j} Y$ map to the same corelation if their respective copairings $[i, j]: X + Y \rightarrow S$ have the same jointly epic parts. More colloquially, this allows us to ‘discard’ any part of the cospan that is not connected to the terminals. This is precisely what equation (5.5) represents. Further details on this viewpoint can be found in [CF].

Let $\mathbb{III}^{\text{Cor}}$ be the SMT obtained from the equations of $\mathbb{III}^{\text{Csp}}$ together with equation (5.5).

Theorem 5.16. $\text{Corel Mat } k[s, s^{-1}] \cong \mathbb{III}^{\text{Cor}}$.

Proof. Since equation (5.5) holds in $\text{Corel Mat } k[s, s^{-1}]$, we have a full morphism $\mathbb{III}^{\text{Cor}} \rightarrow \text{Corel Mat } k[s, s^{-1}]$; it remains to show that it is faithful. It clearly suffices to show that in the equational theory $\mathbb{III}^{\text{Cor}}$ one can prove that every cospan is equal to its corelation. Suppose then that $m \xrightarrow{A} k \xleftarrow{B} n$ is a cospan and $m \xrightarrow{A'} k' \xleftarrow{B'} n$ its corelation. Then, by definition, there exists a split mono $M: k' \rightarrow k$ such that $MA' = A$ and $MB' = B$. Moreover, by the construction of the epi-split mono factorisation

in $\text{Mat } k[s, s^{-1}]$, M is of the form $\begin{array}{c} k' \\ \circlearrowleft \\ k-k' \end{array} \begin{array}{c} M' \\ \circlearrowright \\ k \end{array} \begin{array}{c} k \\ \circlearrowright \\ k-k' \end{array}$ where $M': k \rightarrow k$ is invertible. We can now give the derivation in III^{Cor} :

$$\begin{array}{ccc}
 \begin{array}{c} m \\ \text{---} \end{array} \begin{array}{c} \text{A} \\ \text{---} \end{array} \begin{array}{c} k \\ \text{---} \end{array} \begin{array}{c} \text{B} \\ \text{---} \end{array} \begin{array}{c} n \\ \text{---} \end{array} & \stackrel{\text{III}^{\text{Csp}}}{=} & \begin{array}{c} m \\ \text{---} \end{array} \begin{array}{c} \text{A}' \\ \text{---} \end{array} \begin{array}{c} k' \\ \circlearrowleft \\ k-k' \end{array} \begin{array}{c} M' \\ \circlearrowright \\ k \end{array} \begin{array}{c} M' \\ \circlearrowright \\ k \end{array} \begin{array}{c} k' \\ \circlearrowright \\ k-k' \end{array} \begin{array}{c} \text{B}' \\ \text{---} \end{array} \begin{array}{c} n \\ \text{---} \end{array} \\
 & \stackrel{\text{III}^{\text{Csp}}}{=} & \begin{array}{c} m \\ \text{---} \end{array} \begin{array}{c} \text{A}' \\ \text{---} \end{array} \begin{array}{c} k' \\ \circlearrowleft \\ k-k' \end{array} \begin{array}{c} \text{B}' \\ \text{---} \end{array} \begin{array}{c} n \\ \text{---} \end{array} \\
 & \stackrel{(5.5)}{=} & \begin{array}{c} m \\ \text{---} \end{array} \begin{array}{c} \text{A}' \\ \text{---} \end{array} \begin{array}{c} k' \\ \text{---} \end{array} \begin{array}{c} \text{B}' \\ \text{---} \end{array} \begin{array}{c} n \\ \text{---} \end{array}
 \end{array}$$

□

We therefore have a sound and complete equational theory capable of representing all LTI systems, and also a normal form for each LTI system: every such system can be written, in an essentially unique way, as a jointly epic cospan of terms in $\text{IIIA}_{k[s, s^{-1}]}$ in normal form. We summarise the axioms in Figure 5.1.

Remark 5.17. III^{Cor} can also be described as having the equations of $\text{III}_{k[s, s^{-1}]}$ (see [BSZ16, Zan15]), but *without* $\begin{array}{c} \text{---} \\ \text{---} \end{array} \begin{array}{c} \text{---} \\ \text{---} \end{array} = \text{---}$, $\begin{array}{c} \text{---} \\ \text{---} \end{array} \begin{array}{c} \text{---} \\ \text{---} \end{array} \begin{array}{c} \text{---} \\ \text{---} \end{array} = \begin{array}{c} \text{---} \\ \text{---} \end{array} \begin{array}{c} \text{---} \\ \text{---} \end{array}$, and $\begin{array}{c} \text{---} \\ \text{---} \end{array} \begin{array}{c} \text{---} \\ \text{---} \end{array} = \begin{array}{c} \text{---} \\ \text{---} \end{array} \begin{array}{c} \text{---} \\ \text{---} \end{array}$. Our results generalise; given any PID R we have (informally speaking):

$$\begin{array}{c}
 \text{III}_R^{\text{Cor}} = \text{III}_R - \left\{ \begin{array}{l} \begin{array}{c} \text{---} \\ \text{---} \end{array} \begin{array}{c} \text{---} \\ \text{---} \end{array} = \text{---} , \\ \begin{array}{c} \text{---} \\ \text{---} \end{array} \begin{array}{c} \text{---} \\ \text{---} \end{array} = \begin{array}{c} \text{---} \\ \text{---} \end{array} \begin{array}{c} \text{---} \\ \text{---} \end{array} , \\ \begin{array}{c} \text{---} \\ \text{---} \end{array} \begin{array}{c} \text{---} \\ \text{---} \end{array} = \begin{array}{c} \text{---} \\ \text{---} \end{array} \begin{array}{c} \text{---} \\ \text{---} \end{array} \end{array} \left| r \neq 0 \in R \right. \\
 \cong \text{Corel Mat } R
 \end{array}$$

and, because of the transpose duality of matrices:

$$\begin{array}{c}
 \text{III}_R^{\text{Rel}} = \text{III}_R - \left\{ \begin{array}{l} \begin{array}{c} \text{---} \\ \text{---} \end{array} \begin{array}{c} \text{---} \\ \text{---} \end{array} = \text{---} , \\ \begin{array}{c} \text{---} \\ \text{---} \end{array} \begin{array}{c} \text{---} \\ \text{---} \end{array} = \begin{array}{c} \text{---} \\ \text{---} \end{array} \begin{array}{c} \text{---} \\ \text{---} \end{array} , \\ \begin{array}{c} \text{---} \\ \text{---} \end{array} \begin{array}{c} \text{---} \\ \text{---} \end{array} = \begin{array}{c} \text{---} \\ \text{---} \end{array} \begin{array}{c} \text{---} \\ \text{---} \end{array} \end{array} \left| r \neq 0 \in R \right. \\
 \cong \text{Rel Mat } R.
 \end{array}$$

Remark 5.18. The omitted equations each associate a cospan with a span that, in terms of behaviour, has the effect of passing to a sub-behaviour¹. Often this is a strict sub-behaviour, hence the failure of soundness of III identified in the introduction.

For example, consider the system \mathcal{B} represented by the cospan

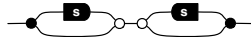

¹In fact the ‘largest controllable sub-behaviour’ of the system. We explore controllability in Section 5.5.

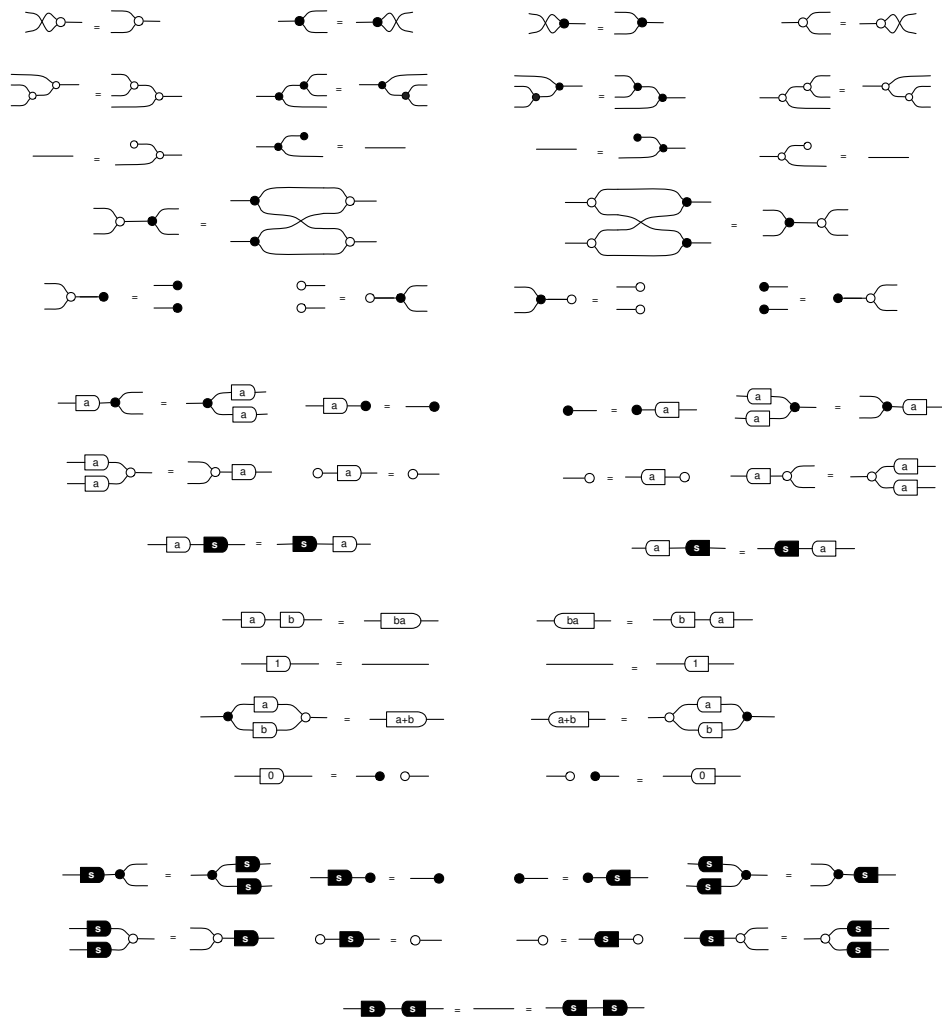

$\mathbb{H}\mathbb{A}_{k[s,s^{-1}]} + \mathbb{H}\mathbb{A}_{k[s,s^{-1}]}^{op}$

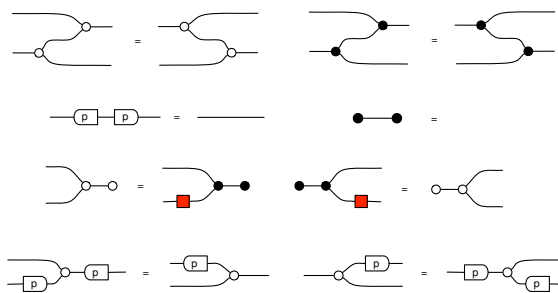

$\mathbb{H}\mathbb{H}^{Csp}$



$\mathbb{H}\mathbb{H}^{Cor}$

Figure 5.1: The axioms of $\mathbb{H}\mathbb{H}^{Cor}$.

We met this system in the introduction; indeed the following derivation can be performed in $\mathbb{III}^{\text{Cor}}$:

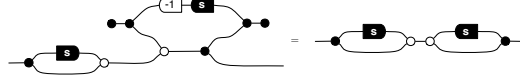

The trajectories are $w = (w_1, w_2) \in k^{\mathbb{Z}} \oplus k^{\mathbb{Z}}$ where $(s + 1) \cdot w_1 = (s + 1) \cdot w_2$; that is, they satisfy the difference equation

$$w_1(t - 1) + w_1(t) - w_2(t - 1) - w_2(t) = 0.$$

As we saw in the introduction, however, an equation of $\mathbb{III}_{k[s]}$ omitted from $\mathbb{III}_{k[s, s^{-1}]}^{\text{Cor}}$ equates this to the identity system --- , with the identity behaviour those sequences of the form $w = (w_1, w_1) \in k^{\mathbb{Z}} \oplus k^{\mathbb{Z}}$. The identity behaviour is strictly smaller than \mathcal{B} ; e.g., \mathcal{B} contains (w_1, w_2) with $w_1(t) = (-1)^t$ and $w_2(t) = 0$.

The similarity between our equational presentations of $\mathbb{III}_{k[s, s^{-1}]}^{\text{Cor}}$ and that of $\mathbb{III}_{k[s]}$ given in [BSZ14, BSZ15] is remarkable, considering the differences between the intended semantics of signal flow graphs that string diagrams in those theories represent, as well as the underlying mathematics of streams, which for us are elements of the k vector space $k^{\mathbb{Z}}$ and in [BSZ14, BSZ15] are Laurent series. We contend that this is evidence of the *robustness* of the algebraic approach: the equational account of how various components of signal flow graphs interact is, in a sense, a higher-level specification than the technical details of the underlying mathematical formalisations.

5.4 Operational semantics

In this section we relate the denotational account given in previous sections with an operational view.

Operational semantics is given to Σ^* -terms—that is, to arrows of the prop $\mathbb{S}^* = \mathbf{S}_{(\Sigma^*, \emptyset)}$ —where Σ^* is obtained from set of generators in (5.4) by replacing the formal variables s and s^{-1} with a family of registers, indexed by the scalars of k :

$$\begin{aligned} \text{---} \boxed{s} \text{---} &\rightsquigarrow \{ \text{---} \boxed{s}^k \text{---} \mid k \in k \} \\ \text{---} \boxed{s} \text{---} &\rightsquigarrow \{ \text{---} \boxed{s}^k \text{---} \mid k \in k \} \end{aligned}$$

The idea is that at any time during a computation the register holds the signal it has received on the previous ‘clock-tick’. There are no equations, apart from the laws of symmetric monoidal categories.

Next we introduce the structural rules: the transition relations that occur at each clock-tick, turning one Σ^* -term into another. Each transition is given two labels, written above and below the arrow. The upper refers to the signals observed at the ‘dangling wires’ on the left-hand side of the term, and the lower to those observed on the right hand side. Indeed, transitions out of a term of type $m \rightarrow n$ have upper labels in k^m and lower ones in k^n .

Because—for the purposes of the operational account—we consider these terms to be syntactic, we must also account for the twist \bowtie and identity --- . A summary of the structural rules is given below; the rules for the mirror image generators are symmetric, in the sense that upper and lower labels are swapped.

$$\begin{array}{c}
\begin{array}{ccc}
\begin{array}{c} \bullet \\ \text{---} \\ \bullet \end{array} \xrightarrow[k k']{k} \begin{array}{c} \bullet \\ \text{---} \\ \bullet \end{array} & \begin{array}{c} \bullet \\ \text{---} \\ \bullet \end{array} \xrightarrow{k} \begin{array}{c} \bullet \\ \text{---} \\ \bullet \end{array} \\
\begin{array}{c} \circ \\ \text{---} \\ \circ \end{array} \xrightarrow[k+l]{k \ l} \begin{array}{c} \circ \\ \text{---} \\ \circ \end{array} & \begin{array}{c} \circ \\ \text{---} \\ \circ \end{array} \xrightarrow{0} \begin{array}{c} \circ \\ \text{---} \\ \circ \end{array} \\
\begin{array}{c} \boxed{a} \\ \text{---} \\ \boxed{a} \end{array} \xrightarrow[al]{l} \begin{array}{c} \boxed{a} \\ \text{---} \\ \boxed{a} \end{array} & \begin{array}{c} \blacksquare \\ \text{---} \\ \blacksquare \end{array} \xrightarrow[l]{k} \begin{array}{c} \blacksquare \\ \text{---} \\ \blacksquare \end{array} \\
\text{---} \xrightarrow[k]{k} \text{---} & \begin{array}{c} \bowtie \\ \text{---} \\ \bowtie \end{array} \xrightarrow[l k]{k \ l} \begin{array}{c} \bowtie \\ \text{---} \\ \bowtie \end{array} \\
\frac{s \xrightarrow[u]{u} s' \quad t \xrightarrow[v]{v} t'}{s ; t \xrightarrow[w]{w} s' ; t'} & \frac{s \xrightarrow[u_1]{u_1} s' \quad t \xrightarrow[v_2]{v_2} t'}{s \oplus t \xrightarrow[v_1 v_2]{u_1 u_2} s' \oplus t'}
\end{array}
\end{array}$$

Here $k, l, a \in k$, s, t are Σ^* -terms, and $\mathbf{u}, \mathbf{v}, \mathbf{w}, \mathbf{u}_1, \mathbf{u}_2, \mathbf{v}_1, \mathbf{v}_2$ are vectors in k of the appropriate length. Note that the only generators that change as a result of computation are the registers; it follows this is the only source of state in any computation.

Let $\tau: m \rightarrow n \in \mathbb{S}$ be a Σ -term. Fixing an ordering of the delays \blacksquare in τ allows us to identify the set of delays with a finite ordinal $[d]$. A **register assignment** is then simply a function $\sigma: [d] \rightarrow k$. We may instantiate the Σ -term τ with the register assignment σ to obtain the Σ^* -term $\tau_\sigma \in \mathbb{S}^*$ of the same type: for all $i \in [d]$ simply replace the i th delay with a register in state $\sigma(i)$.

A computation on τ initialised at σ is an infinite sequence of register assignments and transitions:

$$\tau_\sigma \xrightarrow[v_1]{u_1} \tau_{\sigma_1} \xrightarrow[v_2]{u_2} \tau_{\sigma_2} \xrightarrow[v_3]{u_3} \dots$$

The **trace** induced by this computation is the sequence

$$(\mathbf{u}_1, \mathbf{v}_1), (\mathbf{u}_2, \mathbf{v}_2), \dots$$

of elements of $k^m \oplus k^n$.

To relate the operational and denotational semantics, we introduce the notion of biinfinite trace: a trace with an infinite past as well as future. To define these, we

use the notion of a *reverse* computation: a computation using the operational rules above, but with the rules for delay having their left and right hand sides swapped:

$$\text{---} \mathbf{s} \xrightarrow[k]{t} \text{---} \mathbf{s} \text{---} .$$

Definition 5.19. Given $\tau: m \rightarrow n \in \mathbb{S}$, a **biinfinite trace on τ** is a sequence $w \in (k^m)^\mathbb{Z} \oplus (k^n)^\mathbb{Z}$ such that there exists

- (i) a register assignment σ ;
- (ii) an infinite *forward trace* ϕ_σ of a computation on τ initialised at σ ; and,
- (iii) an infinite *backward trace* ψ_σ of a reverse computation on τ initialised at σ ,

obeying

$$w(t) = \begin{cases} \phi(t) & t \geq 0; \\ \psi(-(t+1)) & t < 0. \end{cases}$$

We write $\text{bit}(\tau)$ for the set of all biinfinite traces on τ .

The following result gives a tight correspondence between the operational and denotational semantics, and follows via a straightforward structural induction on τ .

Lemma 5.20. *For any $\tau: m \rightarrow n \in \mathbb{S}$, we have*

$$\llbracket \tau \rrbracket = \text{bit}(\tau)$$

as subsets of $(k^m)^\mathbb{Z} \times (k^n)^\mathbb{Z}$.

5.5 Controllability

Suppose we are given a current and a target trajectory for a system. Is it always possible, in finite time, to steer the system onto the target trajectory? If so, the system is deemed controllable, and the problem of controllability of systems is at the core of control theory. The following definition is due to Willems [Wil89].

Definition 5.21. A system (T, W, \mathcal{B}) (or simply the behaviour \mathcal{B}) is **controllable** if for all $w, w' \in \mathcal{B}$ and all times $t_0 \in \mathbb{Z}$, there exists $w'' \in \mathcal{B}$ and $t'_0 \in \mathbb{Z}$ such that $t'_0 > t_0$ and w'' obeys

$$w''(t) = \begin{cases} w(t) & t \leq t_0 \\ w'(t - t'_0) & t \geq t'_0. \end{cases}$$

As mentioned previously, a novel feature of our graphical calculus is that it allows us to consider non-controllable behaviours.

Example 5.22. Consider the system in the introduction, further elaborated in Remark 5.18. As noted previously, the trajectories of this system are precisely those sequences $w = (w_1, w_2) \in k^{\mathbb{Z}} \oplus k^{\mathbb{Z}}$ that satisfy the difference equation

$$w_1(t-1) + w_1(t) - w_2(t-1) - w_2(t) = 0.$$

To see that the system is non-controllable, note that

$$w_1(t-1) - w_2(t-1) = -(w_1(t) - w_2(t)),$$

so $(w_1 - w_2)(t) = (-1)^t c_w$ for some $c_w \in k$. This c_w is a time-invariant property of any trajectory. Thus if w and w' are trajectories such that $c_w \neq c_{w'}$, then it is not possible to transition from the past of w to the future of w' along some trajectory in \mathcal{B} .

Explicitly, taking $w(t) = ((-1)^t, 0)$ and $w'(t) = ((-1)^t 2, 0)$ suffices to show \mathcal{B} is not controllable.

5.5.1 A categorical characterisation

We now show that controllable systems are precisely those representable as *spans* of matrices. This novel characterisation leads to new ways of reasoning about controllability of composite systems.

Among the various equivalent conditions for controllability, the existence of *image representations* is most useful for our purposes.

Proposition 5.23 (Willems [Wil07, p.86]). *An LTI behaviour \mathcal{B} is controllable iff there exists $M \in \text{Mat } k[s, s^{-1}]$ such that $\mathcal{B} = \text{Im } \theta M$.*

Restated in our language, Proposition 5.23 states that controllable systems are precisely those representable as *spans* of matrices.

Theorem 5.24. *Let $m \xrightarrow{A} d \xleftarrow{B} n$ be a corelation in $\text{Corel Mat } k[s, s^{-1}]$. Then the LTI behaviour $\Phi(\xrightarrow{A} \xleftarrow{B})$ is controllable iff there exists $R : e \rightarrow m$, $S : e \rightarrow n$ such that*

$$m \xleftarrow{R} e \xrightarrow{S} n = m \xrightarrow{A} d \xleftarrow{B} n$$

as morphisms in $\text{Corel Mat } k[s, s^{-1}]$.

Proof. To begin, note that the behaviour of a span is its joint image. That is, $\Phi(\leftarrow^R \rightarrow^S)$ is the composite of linear relations $\ker \theta[\text{id}_m - R]$ and $\ker \theta[S - \text{id}_n]$, which comprises all $(\mathbf{x}, \mathbf{y}) \in (k^m)^\mathbb{Z} \oplus (k^n)^\mathbb{Z}$ s.t. $\exists \mathbf{z} \in (k^e)^\mathbb{Z}$ with $\mathbf{x} = \theta R\mathbf{z}$ and $\mathbf{y} = \theta S\mathbf{z}$. Thus

$$\Phi(\leftarrow^R \rightarrow^S) = \text{Im } \theta \begin{bmatrix} R \\ S \end{bmatrix}.$$

The result then follows immediately from Proposition 5.23. \square

In terms of the graphical theory, this means that a term in the form $\mathbb{H}\mathbb{A}_{k[s, s^{-1}]}; \mathbb{H}\mathbb{A}_{k[s, s^{-1}]}^{op}$ ('cospan form') is controllable iff we can find a derivation, using the rules of $\mathbb{H}\mathbb{H}^{\text{Cor}}$, that puts it in the form $\mathbb{H}\mathbb{A}_{k[s, s^{-1}]}^{op}; \mathbb{H}\mathbb{A}_{k[s, s^{-1}]}$ ('span form'). This provides a general, easily recognisable representation for controllable systems.

Span representations also lead to a test for controllability: take the pullback of the cospan and check whether the system described by it coincides with the original one. Indeed, note that as $k[s, s^{-1}]$ is a PID, the category $\text{Mat } k[s, s^{-1}]$ has pullbacks. A further consequence of Theorem 5.24, together with Proposition 5.14, is the following.

Proposition 5.25. *Let $m \xrightarrow{A} d \xleftarrow{B} n$ be a cospan in $\text{Mat } k[s, s^{-1}]$, and write the pullback of this cospan $m \xleftarrow{R} e \xrightarrow{S} n$. Then the behaviour of the pullback span $\Phi(\leftarrow^R \rightarrow^S)$ is the maximal controllable sub-behaviour of $\Phi(\xrightarrow{A} \xleftarrow{B})$.*

Proof. Suppose we have another controllable behaviour \mathcal{C} contained in $\ker \theta[A - B]$. Then this behaviour is the Φ -image of some span $m \xleftarrow{R'} e' \xrightarrow{S'} n$. As $\text{Im } \theta \begin{bmatrix} R' \\ S' \end{bmatrix}$ lies in $\ker \theta[A - B]$, the universal property of the pullback gives a map $e' \rightarrow e$ such that the relevant diagram commutes. This implies that the controllable behaviour $\mathcal{C} = \text{Im } \theta \begin{bmatrix} R' \\ S' \end{bmatrix}$ is contained in $\text{Im } \theta \begin{bmatrix} R \\ S \end{bmatrix}$, as required. \square

Corollary 5.26. *Suppose that an LTI behaviour \mathcal{B} has cospan representation*

$$m \xrightarrow{A} d \xleftarrow{B} n.$$

Then \mathcal{B} is controllable iff the Φ -image of the pullback of this cospan in $\text{Mat } k[s, s^{-1}]$ is equal to \mathcal{B} .

Moreover, taking the pushout of this pullback span gives another cospan. The morphism from the pushout to the original cospan, given by the universal property of the pushout, describes the way in which the system fails to be controllable.

To continue Remark 5.17, the theory of interacting Hopf algebras $\mathbb{H}\mathbb{H}_{k[s,s^{-1}]}$ [BSZ16, Zan15] may be viewed as our theory $\mathbb{H}\mathbb{H}^{\text{Cor}}$ of LTI systems together with the axioms given by the pullback in $\text{Mat } k[s, s^{-1}]$. Thus, graphically, the pullback may be computed by using the axioms of $\mathbb{H}\mathbb{H}_{k[s,s^{-1}]}$. For example, the pullback span of the system of Example 5.22 is simply the identity span, as derived in equation (5.2) of the previous section. In the traditional matrix calculus for control theory, one derives this by noting the system has kernel representation $\ker \theta \begin{bmatrix} s + 1 & -(s + 1) \end{bmatrix}$, and eliminating the common factor $s + 1$ between the entries. Either way, we conclude that the maximally controllable subsystem of $1 \xrightarrow{[s+1]} 1 \xleftarrow{[s+1]} 1$ is simply the identity system $1 \xrightarrow{[1]} 1 \xleftarrow{[1]} 1$.

5.5.2 Control and interconnection

From this vantage point we can make useful observations about controllable systems and their composites: we simply need to ask whether we can rewrite them as spans.

Example 5.27. Suppose that \mathcal{B} has cospan representation $m \xrightarrow{A} d \xleftarrow{B} n$. Then \mathcal{B} is easily seen to be controllable when A or B is invertible. Indeed, if A is invertible, then $m \xleftarrow{A^{-1}B} n \xrightarrow{\text{id}_n} n$ is an equivalent span; if B is invertible, then $m \xleftarrow{\text{id}_m} m \xrightarrow{B^{-1}A} n$.

More significantly, the compositionality of our framework aids understanding of how controllability behaves under the interconnection of systems—an active field of investigation in current control theory. We give an example application of our result.

First, consider the following proposition.

Proposition 5.28. *Let \mathcal{B}, \mathcal{C} be controllable systems, given by the respective Φ -images of the spans $m \xleftarrow{B_1} d \xrightarrow{B_2} n$ and $n \xleftarrow{C_1} e \xrightarrow{C_2} l$. Then the composite $\mathcal{C} \circ \mathcal{B} : m \rightarrow l$ is controllable if $\Phi(\xrightarrow{B_2} \xleftarrow{C_1})$ is controllable.*

Proof. Replacing $\xrightarrow{B_2} \xleftarrow{C_1}$ with an equivalent span gives a span representation for $\mathcal{C} \circ \mathcal{B}$. □

Example 5.29. Consider LTI systems

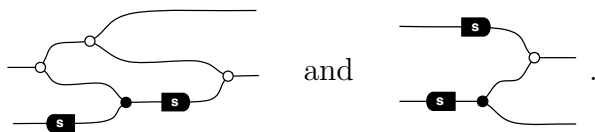

These systems are controllable because each is represented by a span in $\text{Mat } k[s, s^{-1}]$. Indeed, recall that each generator of $\text{LTI} = \text{Corel } \text{Mat } k[s, s^{-1}]$ arises as the image of

a generator in $\text{Mat } k[s, s^{-1}]$ or $\text{Mat } k[s, s^{-1}]^{\text{op}}$; for example, the white monoid map $\text{---} \circ \text{---}$ represents a morphism in $\text{Mat } k[s, s^{-1}]$, while the black monoid map $\text{---} \bullet \text{---}$ represents a morphism in $\text{Mat } k[s, s^{-1}]^{\text{op}}$. The above diagrams are spans as we may partition the diagrams above so that each generator in $\text{Mat } k[s, s^{-1}]^{\text{op}}$ lies to the left of each generator in $\text{Mat } k[s, s^{-1}]$.

To determine controllability of the interconnected system

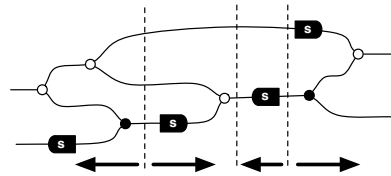

Proposition 5.28 states that it is enough to consider the controllability of the subsystem

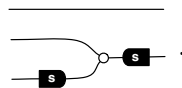

The above diagram gives a representation of the subsystem as a cospan in $\text{Mat } k[s, s^{-1}]$. We can prove it is controllable by rewriting it as a span using an equation of LTI:

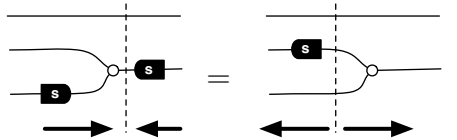

Thus the composite system is controllable.

Remark 5.30. Note the converse of Proposition 5.28 fails. For a simple example, consider the system

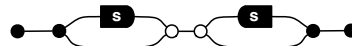

This is equivalent to the empty system, and so trivially controllable. The central span, however, is not controllable (Example 5.22).

5.5.3 Comparison to matrix methods

The facility with which the graphical calculus formalises and solves such controllability issues is especially appealing in view of potential applications in the analysis of controllability of *systems over networks* (see [OFM07]). To make the reader fully appreciate such potential, we sketch how complicated such analysis is using standard algebraic methods and dynamical system theory even for the highly restrictive case

of two systems that compose to make a single-input, single-output system. See also pages 513 to 516 of Fuhrmann and Helmke's recent book [FH15], where a generalization of the result of Proposition 5.28 is given in a polynomial- and operator-theoretic setting.

In the following we abuse notation by writing a matrix for its image under the functor θ . The following is a useful result for analysing the controllability of kernel representations applying only to the single-input single-output case.

Proposition 5.31 (Willems [Wil07, p.75]). *Let $\mathcal{B} \subseteq (k^2)^{\mathbb{Z}}$ be a behaviour given by the kernel of the matrix $\theta \begin{bmatrix} A & B \end{bmatrix}$, where A and B are column vectors with entries in $k[s, s^{-1}]$. Then \mathcal{B} is controllable if and only if the greatest common divisor $\gcd(A, B)$ of A and B is 1.*

Using the notation of Proposition 5.28, the trajectories of \mathcal{B} and \mathcal{C} respectively are those $(w_1, w_2) \in (k^n)^{\mathbb{Z}} \oplus (k^m)^{\mathbb{Z}}$ and $(w'_2, w_3) \in (k^m)^{\mathbb{Z}} \oplus (k^p)^{\mathbb{Z}}$ such that

$$\begin{bmatrix} w_1 \\ w_2 \end{bmatrix} = \begin{bmatrix} B_1 \\ B_2 \end{bmatrix} \ell_1 \quad \text{and} \quad \begin{bmatrix} w'_2 \\ w_3 \end{bmatrix} = \begin{bmatrix} C_1 \\ C_2 \end{bmatrix} \ell_2 \quad (5.6)$$

for some $\ell_1 \in (k^b)^{\mathbb{Z}}$, $\ell_2 \in (k^c)^{\mathbb{Z}}$. These are the explicit image representations of the two systems. We assume without loss of generality that the representations (5.6) are *observable* (see [Wil07]); this is equivalent to $\gcd(B_1, B_2) = \gcd(C_1, C_2) = 1$. Augmenting (5.6) with the interconnection constraint $w_2 = B_2 \ell_1 = C_1 \ell_2 = w'_2$ we obtain the representation of the interconnection:

$$\begin{bmatrix} w_1 \\ w_2 \\ w'_2 \\ w_3 \\ 0 \end{bmatrix} = \begin{bmatrix} B_1 & 0 \\ B_2 & 0 \\ 0 & C_1 \\ 0 & C_2 \\ B_2 & -C_1 \end{bmatrix} \begin{bmatrix} \ell_1 \\ \ell_2 \end{bmatrix}. \quad (5.7)$$

Proposition 5.28 concerns the controllability of the set $\mathcal{C} \circ \mathcal{B}$ of trajectories (w_1, w_3) for which there exist trajectories $w_2, w'_2, \ell_1, \ell_2$ such that (5.7) holds.

To obtain a representation of such behaviour the variables ℓ_1, ℓ_2, w_2 and w'_2 must be eliminated from (5.7) via algebraic manipulations (see the discussion on p. 237 of [Wil89]). Denote $G = \gcd(B_1, C_2)$, and write $C_2 = GC'_2$ and $B_1 = GB'_1$, where $\gcd(B'_1, C'_2) = 1$. Without entering in the algebraic details, it can be shown that a kernel representation of the projection of the behaviour of (5.7) on the variables w_1 and w_3 is

$$\begin{bmatrix} C'_2 B_2 & -B'_1 C_2 \end{bmatrix} \begin{bmatrix} w_1 \\ w_3 \end{bmatrix} = 0. \quad (5.8)$$

We now restrict to the single-input single-output case. Recalling Proposition 5.31, the behaviour represented by (5.8) is controllable if and only if $\gcd(C'_2 B_2, B'_1 C_1) = 1$.

Finally then, to complete our alternate proof of the single-input single-output case of Proposition 5.28, note that $\overline{\Theta}(\begin{smallmatrix} B_2 & \rightarrow & C_1 \\ & \leftarrow & \end{smallmatrix})$ is controllable if $\gcd(B_2, C_1) = 1$. Given the observability assumption, this implies $\gcd(C'_2 B_2, B'_1 C_1) = 1$, and so the interconnected behaviour $\mathcal{C} \circ \mathcal{B}$ represented by (5.8) is controllable.

In the multi-input, multi-output case stating explicit conditions on the controllability of the interconnection given properties of the representations of the individual systems and their interconnection is rather complicated. This makes the simplicity of Proposition 5.28 and the straightforward nature of its proof all the more appealing.

Chapter 6

Passive linear networks

This chapter is about using decorated corelations to build semantic functors.

A thorough introduction to this chapter can be found in the next section. Here we give a quick overview of the structure of this chapter. The first focus is the traditional, closed semantics of circuit diagrams. We begin in §6.2 with a discussion of circuits of linear resistors, developing the intuition for the governing laws of passive linear circuits—Ohm’s law, Kirchhoff’s voltage law, and Kirchhoff’s current law—in a time-independent setting, and showing that Dirichlet forms represent circuit behaviours. In §6.3, the Laplace transform then allows us to recapitulate these ideas after introducing inductors and capacitors, speaking of impedance where we formerly spoke of resistance, and generalizing Dirichlet forms from the field \mathbb{R} to the field $\mathbb{R}(s)$ of real rational functions.

The goal of this applications chapter is to show how decorated corelations can make these semantics compositional. As a network-style diagrammatic language, it should thus be no surprise that we begin by using decorated cospans to construct a hypergraph category of circuits (§6.4). At the end of this section, however, we show that Dirichlet forms do not provide the flexibility to construct a semantic category for circuits. This motivates the development of more powerful machinery.

In §6.5 we review the basic theory of linear Lagrangian relations, giving details to the correspondence we have defined between Dirichlet forms, and hence passive linear circuits, and Lagrangian relations. Subsection 6.6 then takes immediate advantage of the added flexibility of Lagrangian relations, discussing the ‘trivial’ circuits comprising only perfectly conductive wires, which mediate the notion of composition of circuits.

With these application-specific tools, we can use decorated corelations to prove the functoriality of black-boxing circuits in §6.7.

6.1 Introduction

In late 1940s, just as Feynman was developing his diagrams for processes in particle physics, Eilenberg and Mac Lane initiated their work on category theory. Over the subsequent decades, and especially in the aforementioned work of Joyal and Street [JS91, JS93], it became clear that these developments were profoundly linked: as we have seen, monoidal categories have a precise graphical representation in terms of string diagrams, and conversely monoidal categories provide an algebraic foundation for the intuitions behind Feynman diagrams [BS11]. The key insight is the use of categories where morphisms describe physical processes, rather than structure-preserving maps between mathematical objects [CP11].

But even before physicists began using Feynman diagrams, various branches of engineering were using diagrams that in retrospect are closely related. In the last chapter we investigated signal flow diagrams. But even before these, and even more well known, are the ubiquitous electrical circuit diagrams. These are broad in their application, and similar diagrams are used to describe networks consisting of mechanical, hydraulic, thermodynamic and chemical systems. Further work, pioneered in particular by Forrester [For61] and Odum [Odu84], even applies similar diagrammatic methods to biology, ecology, and economics.

As discussed in detail by Olsen [Ols43], Paynter [Pay61] and others, there are mathematically precise analogies between these different systems. We give a few examples in Table 6.1. In each case, the system’s state is described by variables that come in pairs, with one variable in each pair playing the role of ‘displacement’ and the other playing the role of ‘momentum’. In engineering, the time derivatives of these variables are sometimes called ‘flow’ and ‘effort’. In classical mechanics, this pairing of variables is well understood using symplectic geometry. Thus, any mathematical formulation of the diagrams used to describe networks in engineering needs to take symplectic geometry as well as category theory into account.

Table 6.1: Analogies between variables in various physical settings

	displacement q	flow \dot{q}	momentum p	effort \dot{p}
Electronics	charge	current	flux linkage	voltage
Mechanics (translation)	position	velocity	momentum	force
Mechanics (rotation)	angle	angular velocity	angular momentum	torque
Hydraulics	volume	flow	pressure momentum	pressure
Thermodynamics	entropy	entropy flow	temperature momentum	temperature
Chemistry	moles	molar flow	chemical momentum	chemical potential

Although we shall keep the broad applicability of network diagrams in the back of our minds, we couch our discussion in terms of electrical circuits, for the sake of familiarity. In this section our goal is somewhat limited. We only study circuits built from ‘passive’ components: that is, those that do not produce energy. Thus, we exclude batteries and current sources. We only consider components that respond linearly to an applied voltage. Thus, we exclude components such as nonlinear resistors or diodes. Finally, we only consider components with one input and one output, so that a circuit can be described as a graph with edges labeled by components. Thus, we also exclude transformers. The most familiar components our framework covers are linear resistors, capacitors and inductors.

While we hope to expand our scope in future work, the class of circuits made from these components has appealing mathematical properties, and is worthy of deep study. Indeed, this class has been studied intensively for many decades by electrical engineers [AV73, Bud74, Sle68]. Even circuits made exclusively of resistors have inspired work by mathematicians of the caliber of Weyl [Wey23] and Smale [Sma72].

The present work relies on this research. All we add here is an emphasis on symplectic geometry and an explicitly ‘compositional’ framework, which clarifies the way a larger circuit can be built from smaller pieces. This is where monoidal categories become important: the main operations for building circuits from pieces are composition and tensoring.

Our strategy is most easily illustrated for circuits made of linear resistors. Such a resistor dissipates power, turning useful energy into heat at a rate determined by the voltage across the resistor. However, a remarkable fact is that a circuit made of these resistors always acts to *minimize* the power dissipated this way. This ‘principle of minimum power’ can be seen as the reason symplectic geometry becomes important in understanding circuits made of resistors, just as the principle of least action leads to the role of symplectic geometry in classical mechanics.

Here is a circuit made of linear resistors:

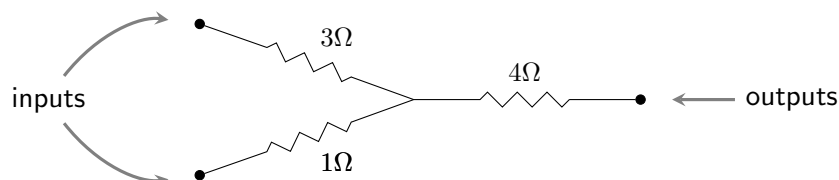

The wiggly lines are resistors, and their resistances are written beside them: for example, 3Ω means 3 ohms, an ‘ohm’ being a unit of resistance. To formalize this, define a circuit of linear resistors to consist of:

- a set N of nodes,
- a set E of edges,
- maps $s, t: E \rightarrow N$ sending each edge to its source and target node,
- a map $r: E \rightarrow (0, \infty)$ specifying the resistance of the resistor labelling each edge,
- maps $i: X \rightarrow N, o: Y \rightarrow N$ specifying the inputs and outputs of the circuit.

When we run electric current through such a circuit, each node $n \in N$ gets a ‘potential’ $\phi(n)$. The ‘voltage’ across an edge $e \in E$ is defined as the change in potential as we move from the source of e to its target, $\phi(t(e)) - \phi(s(e))$, and the power dissipated by the resistor on this edge equals

$$\frac{1}{r(e)} (\phi(t(e)) - \phi(s(e)))^2.$$

The total power dissipated by the circuit is therefore twice

$$P(\phi) = \frac{1}{2} \sum_{e \in E} \frac{1}{r(e)} (\phi(t(e)) - \phi(s(e)))^2.$$

The factor of $\frac{1}{2}$ is convenient in some later calculations. Note that P is a nonnegative quadratic form on the vector space \mathbb{R}^N . However, not every nonnegative definite quadratic form on \mathbb{R}^N arises in this way from some circuit of linear resistors with N as its set of nodes. The quadratic forms that do arise are called ‘Dirichlet forms’. They have been extensively investigated [Fuk80, MR91, Sab97, Sab04], and they play a major role in our work.

We write $\partial N = i(X) \cup o(Y)$ for the set of ‘terminals’: that is, nodes corresponding to inputs and outputs. The principle of minimum power says that if we fix the potential at the terminals, the circuit will choose the potential at other nodes to minimize the total power dissipated. An element ψ of the vector space $\mathbb{R}^{\partial N}$ assigns a potential to each terminal. Thus, if we fix ψ , the total power dissipated will be twice

$$Q(\psi) = \min_{\substack{\phi \in \mathbb{R}^N \\ \phi|_{\partial N} = \psi}} P(\phi)$$

The function $Q: \mathbb{R}^{\partial N} \rightarrow \mathbb{R}$ is again a Dirichlet form. We call it the ‘power functional’ of the circuit.

Now, suppose we are unable to see the internal workings of a circuit, and can only observe its ‘external behaviour’: that is, the potentials at its terminals and

the currents flowing into or out of these terminals. Remarkably, this behaviour is completely determined by the power functional Q . The reason is that the current at any terminal can be obtained by differentiating Q with respect to the potential at this terminal, and relations of this form are *all* the relations that hold between potentials and currents at the terminals.

The Laplace transform allows us to generalize this immediately to circuits that can also contain linear inductors and capacitors, simply by changing the field we work over, replacing \mathbb{R} by the field $\mathbb{R}(s)$ of rational functions of a single real variable, and talking of ‘impedance’ where we previously talked of resistance. We obtain a category Circ where, roughly speaking, an object is a finite set, a morphism $X \rightarrow Y$ is a circuit with input set X and output set Y , and composition is given by identifying the outputs of one circuit with the inputs of the next, and taking the resulting union of labelled graphs. Each such circuit gives rise to a Dirichlet form, now defined over $\mathbb{R}(s)$, and this Dirichlet form completely describes the externally observable behaviour of the circuit.

We can take equivalence classes of circuits, where two circuits count as the same if they have the same Dirichlet form. We wish for these equivalence classes of circuits to form a category. Although there is a notion of composition for Dirichlet forms, we find that it lacks identity morphisms or, equivalently, it lacks morphisms representing ideal wires of zero impedance. To address this we turn to Lagrangian subspaces of symplectic vector spaces. These generalize quadratic forms via the map

$$\left(Q: \mathbb{F}^{\partial N} \rightarrow \mathbb{F}\right) \longmapsto \left(\text{Graph}(dQ) = \{(\psi, dQ_\psi) \mid \psi \in \mathbb{F}^{\partial N}\} \subseteq \mathbb{F}^{\partial N} \oplus (\mathbb{F}^{\partial N})^*\right)$$

taking a quadratic form Q on the vector space $\mathbb{F}^{\partial N}$ over a field \mathbb{F} to the graph of its differential dQ . Here we think of the symplectic vector space $\mathbb{F}^{\partial N} \oplus (\mathbb{F}^{\partial N})^*$ as the state space of the circuit, and the subspace $\text{Graph}(dQ)$ as the subspace of attainable states, with $\psi \in \mathbb{F}^{\partial N}$ describing the potentials at the terminals, and $dQ_\psi \in (\mathbb{F}^{\partial N})^*$ the currents.

This construction is well known in classical mechanics [Wei81], where the principle of least action plays a role analogous to that of the principle of minimum power here. The set of Lagrangian subspaces is actually an algebraic variety, the ‘Lagrangian Grassmannian’, which serves as a compactification of the space of quadratic forms. The Lagrangian Grassmannian has already played a role in Sabot’s work on circuits made of resistors [Sab97, Sab04]. For us, its importance is that we can find identity morphisms for the composition of Dirichlet forms by taking circuits made of parallel resistors and letting their resistances tend to zero: the limit is not a Dirichlet form,

but it exists in the Lagrangian Grassmannian. Indeed, there exists a category LagrRel with finite dimensional symplectic vector spaces as objects and ‘Lagrangian relations’ as morphisms: that is, linear relations from V to W that are given by Lagrangian subspaces of $\bar{V} \oplus W$, where \bar{V} is the symplectic vector space conjugate to V .

To move from the Lagrangian subspace defined by the graph of the differential of the power functional to a morphism in the category LagrRel —that is, to a Lagrangian relation—we must treat seriously the input and output functions of the circuit. These express the circuit as built upon a cospan

$$\begin{array}{ccc} & N & \\ i \nearrow & & \nwarrow o \\ X & & Y. \end{array}$$

Applicable far more broadly than this present formalization of circuits, cospans model systems with two ‘ends’, an input and output end, albeit without any connotation of directionality: we might just as well exchange the role of the inputs and outputs by taking the mirror image of the above diagram. The role of the input and output functions, as we have discussed, is to mark the terminals we may glue onto the terminals of another circuit, and the pushout of cospans gives formal precision to this gluing construction.

One upshot of this cospan framework is that we may consider circuits with elements of N that are both inputs and outputs, such as this one:

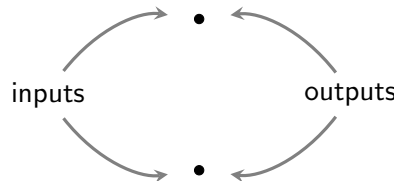

This corresponds to the identity morphism on the finite set with two elements. Another is that some points may be considered an input or output multiple times; we draw this:

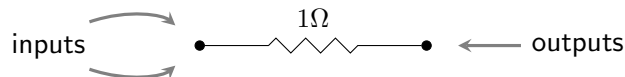

This allows us to connect two distinct outputs to the above double input.

Given a set X of inputs or outputs, we understand the electrical behaviour on this set by considering the symplectic vector space $\mathbb{F}^X \oplus (\mathbb{F}^X)^*$, the direct sum of the space \mathbb{F}^X of potentials and the space $(\mathbb{F}^X)^*$ of currents at these points. A Lagrangian relation specifies which states of the output space $\mathbb{F}^Y \oplus (\mathbb{F}^Y)^*$ are allowed for each

state of the input space $\mathbb{F}^X \oplus (\mathbb{F}^X)^*$. Turning the Lagrangian subspace $\text{Graph}(dQ)$ of a circuit into this information requires that we understand the ‘symplectification’

$$Sf: \mathbb{F}^B \oplus (\mathbb{F}^B)^* \rightarrow \mathbb{F}^A \oplus (\mathbb{F}^A)^*$$

and ‘twisted symplectification’

$$S^t f: \mathbb{F}^B \oplus (\mathbb{F}^B)^* \rightarrow \overline{\mathbb{F}^A \oplus (\mathbb{F}^A)^*}$$

of a function $f: A \rightarrow B$ between finite sets. In particular we need to understand how these apply to the input and output functions with codomain restricted to ∂N ; abusing notation, we also write these $i: X \rightarrow \partial N$ and $o: Y \rightarrow \partial N$.

The symplectification is a Lagrangian relation, and the catch phrase is that it ‘copies voltages’ and ‘splits currents’. More precisely, for any given potential-current pair (ψ, ι) in $\mathbb{F}^B \oplus (\mathbb{F}^B)^*$, its image under Sf comprises all elements of $(\psi', \iota') \in \mathbb{F}^A \oplus (\mathbb{F}^A)^*$ such that the potential at $a \in A$ is equal to the potential at $f(a) \in B$, and such that, for each fixed $b \in B$, collectively the currents at the $a \in f^{-1}(b)$ sum to the current at b . We use the symplectification So of the output function to relate the state on ∂N to that on the outputs Y . As our current framework is set up to report the current *out* of each node, to describe input currents we define the twisted symplectification $S^t f: \mathbb{F}^B \oplus (\mathbb{F}^B)^* \rightarrow \overline{\mathbb{F}^A \oplus (\mathbb{F}^A)^*}$ almost identically to the above, except that we flip the sign of the currents $\iota' \in (\mathbb{F}^A)^*$. We use the twisted symplectification $S^t i$ of the input function to relate the state on ∂N to that on the inputs.

The Lagrangian relation corresponding to a circuit is then the set of all potential-current pairs that are possible at the inputs and outputs of that circuit. For instance, consider a resistor of resistance r , with one end considered as an input and the other as an output:

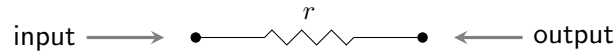

To obtain the corresponding Lagrangian relation, we must first specify domain and codomain symplectic vector spaces. In this case, as the input and output sets each consist of a single point, these vector spaces are both $\mathbb{F} \oplus \mathbb{F}^*$, where the first summand is understood as the space of potentials, and the second the space of currents.

Now, the resistor has power functional $Q: \mathbb{F}^2 \rightarrow \mathbb{F}$ given by

$$Q(\psi_1, \psi_2) = \frac{1}{2r}(\psi_2 - \psi_1)^2,$$

and the graph of the differential of Q is

$$\text{Graph}(dQ) = \left\{ (\psi_1, \psi_2, \frac{1}{r}(\psi_1 - \psi_2), \frac{1}{r}(\psi_2 - \psi_1)) \mid \psi_1, \psi_2 \in \mathbb{F} \right\} \subseteq \mathbb{F}^2 \oplus (\mathbb{F}^2)^*.$$

In this example the input and output functions i, o are simply the identity functions on a one element set, so the symplectification of the output function is simply the identity linear transformation, and the twisted symplectification of the input function is the isomorphism between conjugate symplectic vector spaces $\mathbb{F} \oplus \mathbb{F}^* \rightarrow \overline{\mathbb{F} \oplus \mathbb{F}^*}$ mapping (ϕ, i) to $(\phi, -i)$. This implies that the behaviour associated to this circuit is the Lagrangian relation

$$\left\{ (\psi_1, i, \psi_2, i) \mid \psi_1, \psi_2 \in \mathbb{F}, i = \frac{1}{r}(\psi_2 - \psi_1) \right\} \subseteq \overline{\mathbb{F} \oplus \mathbb{F}^*} \oplus \mathbb{F} \oplus \mathbb{F}^*.$$

This is precisely the set of potential-current pairs that are allowed at the input and output of a resistor of resistance r . In particular, the relation $i = \frac{1}{r}(\psi_2 - \psi_1)$ is well known in electrical engineering: it is ‘Ohm’s law’.

A crucial fact is that the process of mapping a circuit to its corresponding Lagrangian relation identifies distinct circuits. For example, a single 2-ohm resistor:

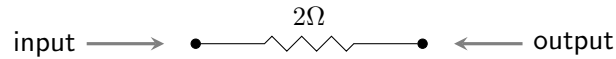

has the same Lagrangian relation as two 1-ohm resistors in series:

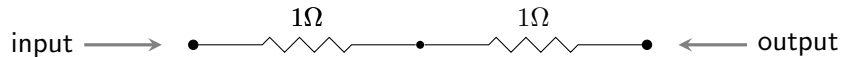

The Lagrangian relation does not shed any light on the internal workings of a circuit. Thus, we call the process of computing this relation ‘black boxing’: it is like encasing the circuit in an opaque box, leaving only its terminals accessible. Fortunately, the Lagrangian relation of a circuit is enough to completely characterize its external behaviour, including how it interacts when connected with other circuits.

Put more precisely, the black boxing process is *functorial*: we can compute the black boxed version of a circuit made of parts by computing the black boxed versions of the parts and then composing them. In fact we shall prove that Circ and LagrRel are dagger compact categories, and the black box functor preserves all this structure:

Theorem 6.1. *There exists a hypergraph functor, the **black box functor***

$$\blacksquare: \text{Circ} \rightarrow \text{LagrRel},$$

mapping a finite set X to the symplectic vector space $\mathbb{F}^X \oplus (\mathbb{F}^X)^*$ it generates, and a circuit $((N, E, s, t, r), i, o)$ to the Lagrangian relation

$$\bigcup_{v \in \text{Graph}(dQ)} S^t i(v) \times S_o(v) \subseteq \overline{\mathbb{F}^X \oplus (\mathbb{F}^X)^*} \oplus \mathbb{F}^Y \oplus (\mathbb{F}^Y)^*,$$

where Q is the circuit's power functional.

The goal of this chapter is to prove and explain this result, demonstrating how the mathematical machinery of Part I provides clarity. With these tools in hand, the black box functor turns out to rely on a tight relationship between Kirchhoff's laws, the minimization of Dirichlet forms, and the 'symplectification' of corelations. It is well known that away from the terminals, a circuit must obey two rules known as Kirchhoff's laws. We have already noted that the principle of minimum power states that a circuit will 'choose' potentials on its interior that minimize the power functional. We clarify the relation between these points in Theorems 6.21 and 6.22, which together show that minimizing a Dirichlet form over some subset amounts to assuming that the corresponding circuit obeys Kirchhoff's laws on that subset.

We have also mentioned the symplectification of functions above. Extending this to allow symplectification of epi-mono corelations in FinSet , this process gives a map sending corelations to Lagrangian relations that describe the behaviour of ideal perfectly conductive wires. We prove that these symplectified corelations simultaneously impose Kirchhoff's laws (Proposition 6.46 and Example 6.47) and accomplish the minimization of Dirichlet forms (Theorem 6.51).

Together, our results show that these three concepts—Kirchhoff's laws from circuit theory, the analytic idea of minimizing power dissipation, and the algebraic idea of symplectification of corelations—are merely different faces of one law: the law of composition of circuits.

6.2 Circuits of linear resistors

Our first concern is for semantics: "What do circuit diagrams mean?"

To elaborate, while circuit diagrams model electric circuits according to their physical form, another, often more relevant, way to understand a circuit is by its external behaviour. This means the following. To an electric circuit we associate two quantities to each edge: voltage and current. We are not free, however, to choose these quantities as we like; circuits are subject to governing laws that imply voltages and currents must obey certain relationships. From the perspective of control theory

we are particularly interested in the values these quantities take at the so-called terminals, and how altering one value will affect the other values. We call two circuits equivalent when they determine the same relationship. Our main task in this first part is to explore when two circuits are equivalent.

In order to let physical intuition lead the way, we begin by specialising to the case of linear resistors. In this section we describe how to find the function of a circuit from its form, advocating in particular the perspective of the principle of minimum power. This allows us to identify the external behaviour of a circuit with a so-called Dirichlet form representing the dependence of its power consumption on potentials at its terminals.

6.2.1 Circuits as labelled graphs

The concept of an abstract open electrical circuit made of linear resistors is well known in electrical engineering, but we shall need to formalize it with more precision than usual. The basic idea is that a circuit of linear resistors is a graph whose edges are labelled by positive real numbers called ‘resistances’, and whose sets of vertices is equipped with two subsets: the ‘inputs’ and ‘outputs’. This unfolds as follows.

A (closed) circuit of resistors looks like this:

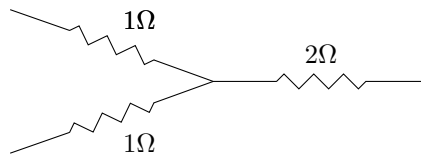

We can consider this a labelled graph, with each resistor an edge of the graph, its resistance its label, and the vertices of the graph the points at which resistors are connected.

A circuit is ‘open’ if it can be connected to other circuits. To do this we first mark points at which connections can be made by denoting some vertices as input and output terminals:

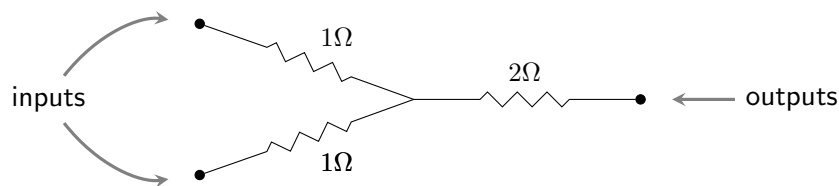

Then, given a second circuit, we may choose a relation between the output set of the first and the input set of this second circuit, such as the simple relation of the single

output vertex of the circuit above with the single input vertex of the circuit below.

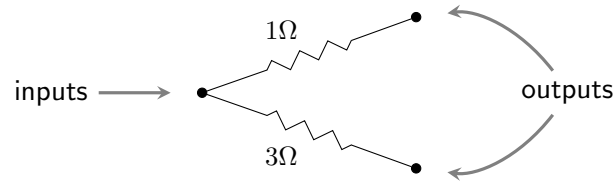

We connect the two circuits by identifying output and input vertices according to this relation, giving in this case the composite circuit:

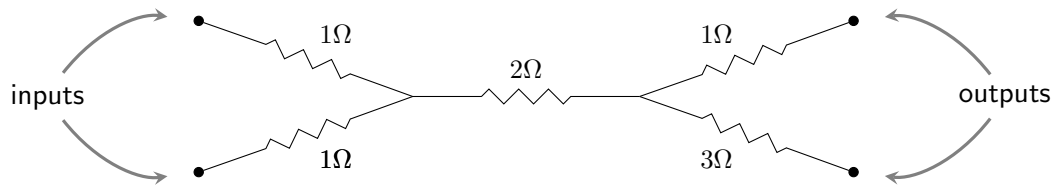

More formally, we define a **graph** to be a pair of functions $s, t: E \rightarrow N$ where E and N are finite sets. We call elements of E **edges** and elements of N **vertices** or **nodes**. We say that the edge $e \in E$ has **source** $s(e)$ and **target** $t(e)$, and also say that e is an edge **from** $s(e)$ **to** $t(e)$.

To study circuits we need graphs with labelled edges:

Definition 6.2. Given a set L of **labels**, an **L -graph** is a graph equipped with a function $r: E \rightarrow L$:

$$L \xleftarrow{r} E \xrightleftharpoons[t]{s} N.$$

For circuits made of resistors we take $L = (0, \infty)$, but later we shall take L to be a set of positive elements in some more general field. In either case, a circuit will be an L -graph with some extra structure:

Definition 6.3. Given a set L , a **circuit over L** is an L -graph $L \xleftarrow{r} E \xrightleftharpoons[t]{s} N$ together with finite sets X, Y , and functions $i: X \rightarrow N$ and $o: Y \rightarrow N$. We call the sets $i(X)$, $o(Y)$, and $\partial N = i(X) \cup o(Y)$ the **inputs**, **outputs**, and **terminals** or **boundary** of the circuit, respectively.

We will later make use of the notion of connectedness in graphs. Recall that given two vertices $v, w \in N$ of a graph, a **path from v to w** is a finite sequence of vertices $v = v_0, v_1, \dots, v_n = w$ and edges e_1, \dots, e_n such that for each $1 \leq i \leq n$, either e_i is an edge from v_i to v_{i+1} , or an edge from v_{i+1} to v_i . A subset S of the vertices of a graph is **connected** if, for each pair of vertices in S , there is a path from one to the

other. A **connected component** of a graph is a maximal connected subset of its vertices.¹

In the rest of this section we take $L = (0, \infty) \subseteq \mathbb{R}$ and fix a circuit over $(0, \infty)$. The edges of this circuit should be thought of as ‘wires’. The label $r_e \in (0, \infty)$ stands for the **resistance** of the resistor on the wire e . There will also be a voltage and current on each wire. In this section, these will be specified by functions $V \in \mathbb{R}^E$ and $I \in \mathbb{R}^E$. Here, as customary in engineering, we use I for ‘intensity of current’, following Ampère.

6.2.2 Ohm’s law, Kirchhoff’s laws, and the principle of minimum power

In 1827, Georg Ohm published a book which included a relation between the voltage and current for circuits made of resistors [Ohm27]. At the time, the critical reception was harsh: one contemporary called Ohm’s work “a web of naked fancies, which can never find the semblance of support from even the most superficial of observations”, and the German Minister of Education said that a professor who preached such heresies was unworthy to teach science [Dav80, Har23]. However, a simplified version of his relation is now widely used under the name of ‘Ohm’s law’. We say that **Ohm’s law** holds if for all edges $e \in E$ the voltage and current functions of a circuit obey:

$$V(e) = r(e)I(e).$$

Kirchhoff’s laws date to Gustav Kirchhoff in 1845, generalising Ohm’s work. They were in turn generalized into Maxwell’s equations a few decades later. We say **Kirchhoff’s voltage law** holds if there exists $\phi \in \mathbb{R}^N$ such that

$$V(e) = \phi(t(e)) - \phi(s(e)).$$

We call the function ϕ a **potential**, and think of it as assigning an electrical potential to each node in the circuit. The voltage then arises as the differences in potentials between adjacent nodes. If Kirchhoff’s voltage law holds for some voltage V , the potential ϕ is unique only in the trivial case of the empty circuit: when the set of nodes N is empty. Indeed, two potentials define the same voltage function if and only if their difference is constant on each connected component of the graph.

¹In the theory of directed graphs the qualifier ‘weakly’ is commonly used before the word ‘connected’ in these two definitions, in distinction from a stronger notion of connectedness requiring paths to respect edge directions. As we never consider any other sort of connectedness, we omit this qualifier.

We say **Kirchhoff's current law** holds if for all nonterminal nodes $n \in N \setminus \partial N$ we have

$$\sum_{s(e)=n} I(e) = \sum_{t(e)=n} I(e).$$

This is an expression of conservation of charge within the circuit; it says that the total current flowing in or out of any nonterminal node is zero. Even when Kirchhoff's current law is obeyed, terminals need not be sites of zero net current; we call the function $\iota \in \mathbb{R}^{\partial N}$ that takes a terminal to the difference between the outward and inward flowing currents,

$$\begin{aligned} \iota : \partial N &\longrightarrow \mathbb{R} \\ n &\longmapsto \sum_{t(e)=n} I(e) - \sum_{s(e)=n} I(e), \end{aligned}$$

the **boundary current** for I .

A **boundary potential** is also a function in $\mathbb{R}^{\partial N}$, but instead thought of as specifying potentials on the terminals of a circuit. As we think of our circuits as open circuits, with the terminals points of interaction with the external world, we shall think of these potentials as variables that are free for us to choose. Using the above three principles—Ohm's law, Kirchhoff's voltage law, and Kirchhoff's current law—it is possible to show that choosing a boundary potential determines unique voltage and current functions on that circuit.

The so-called 'principle of minimum power' gives some insight into how this occurs, by describing a way potentials on the terminals might determine potentials at all nodes. From this, Kirchhoff's voltage law then gives rise to a voltage function on the edges, and Ohm's law gives us a current function too. We shall show, in fact, that a potential satisfies the principle of minimum power for a given boundary potential if and only if this current obeys Kirchhoff's current law.

A circuit with current I and voltage V dissipates energy at a rate equal to

$$\sum_{e \in E} I(e)V(e).$$

Ohm's law allows us to rewrite I as V/r , while Kirchhoff's voltage law gives us a potential ϕ such that $V(e)$ can be written as $\phi(t(e)) - \phi(s(e))$, so for a circuit obeying these two laws the power can also be expressed in terms of this potential. We thus arrive at a functional mapping potentials ϕ to the power dissipated by the circuit when Ohm's law and Kirchhoff's voltage law are obeyed for ϕ .

Definition 6.4. The **extended power functional** $P: \mathbb{R}^N \rightarrow \mathbb{R}$ of a circuit is defined by

$$P(\phi) = \frac{1}{2} \sum_{e \in E} \frac{1}{r(e)} (\phi(t(e)) - \phi(s(e)))^2.$$

The factor of $\frac{1}{2}$ is inserted to cancel the factor of 2 that appears when we differentiate this expression. We call P the *extended* power functional as we shall see that it is defined even on potentials that are not compatible with the three governing laws of electric circuits. We shall later restrict the domain of this functional so that it is defined precisely on those potentials that *are* compatible with the governing laws. Note that this functional does not depend on the directions chosen for the edges of the circuit.

This expression lets us formulate the ‘principle of minimum power’, which gives us information about the potential ϕ given its restriction to the boundary of Γ . Call a potential $\phi \in \mathbb{R}^N$ an **extension** of a boundary potential $\psi \in \mathbb{R}^{\partial N}$ if ϕ is equal to ψ when restricted to $\mathbb{R}^{\partial N}$ —that is, if $\phi|_{\partial N} = \psi$.

Definition 6.5. We say a potential $\phi \in \mathbb{R}^N$ **obeys the principle of minimum power** for a boundary potential $\psi \in \mathbb{R}^{\partial N}$ if ϕ minimizes the extended power functional P subject to the constraint that ϕ is an extension of ψ .

It is well known that, as we have stated above, in the presence of Ohm’s law and Kirchhoff’s voltage law, the principle of minimum power is equivalent to Kirchhoff’s current law.

Proposition 6.6. *Let ϕ be a potential extending some boundary potential ψ . Then ϕ obeys the principle of minimum power for ψ if and only if the current*

$$I(e) = \frac{1}{r(e)} (\phi(t(e)) - \phi(s(e)))$$

obeys Kirchhoff’s current law.

Proof. Fixing the potentials at the terminals to be those given by the boundary potential ψ , the power is a nonnegative quadratic function of the potentials at the nonterminals. This implies that an extension ϕ of ψ minimizes P precisely when

$$\left. \frac{\partial P(\varphi)}{\partial \varphi(n)} \right|_{\varphi=\phi} = 0$$

for all nonterminals $n \in N \setminus \partial N$. Note that the partial derivative of the power with respect to the potential at n is given by

$$\begin{aligned} \left. \frac{\partial P}{\partial \varphi(n)} \right|_{\varphi=\phi} &= \sum_{t(e)=n} \frac{1}{r(e)} (\phi(t(e)) - \phi(s(e))) - \sum_{s(e)=n} \frac{1}{r(e)} (\phi(t(e)) - \phi(s(e))) \\ &= \sum_{t(e)=n} I(e) - \sum_{s(e)=n} I(e). \end{aligned}$$

Thus ϕ obeys the principle of minimum power for ψ if and only if

$$\sum_{s(e)=n} I(e) = \sum_{t(e)=n} I(e)$$

for all $n \in N \setminus \partial N$, and so if and only if Kirchhoff's current law holds. \square

6.2.3 A Dirichlet problem

We remind ourselves that we are in the midst of understanding circuits as objects that define relationships between boundary potentials and boundary currents. This relationship is defined by the stipulation that voltage–current pairs on a circuit must obey Ohm's law and Kirchhoff's laws—or equivalently, Ohm's law, Kirchhoff's voltage law, and the principle of minimum power. In this subsection we show these conditions imply that for each boundary potential ψ on the circuit there exists a potential ϕ on the circuit extending ψ , unique up to what may be interpreted as a choice of reference potential on each connected component of the circuit. From this potential ϕ we can then compute the unique voltage, current, and boundary current functions compatible with the given boundary potential.

Fix again a circuit with extended power functional $P: \mathbb{R}^N \rightarrow \mathbb{R}$. Let $\nabla: \mathbb{R}^N \rightarrow \mathbb{R}^N$ be the operator that maps a potential $\phi \in \mathbb{R}^N$ to the function from N to \mathbb{R} given by

$$n \mapsto \left. \frac{\partial P}{\partial \varphi(n)} \right|_{\varphi=\phi}.$$

As we have seen, this function takes potentials to twice the pointwise currents that they induce. We have also seen that a potential ϕ is compatible with the governing laws of circuits if and only if

$$\nabla \phi|_{\mathbb{R}\partial N} = 0. \tag{6.1}$$

The operator ∇ acts as a discrete analogue of the Laplacian for the graph Γ , so we call this operator the **Laplacian** of Γ , and say that equation (6.1) is a version of Laplace's equation. We then say that the problem of finding an extension ϕ of some

fixed boundary potential ψ that solves this Laplace's equation—or, equivalently, the problem of finding a ϕ that obeys the principle of minimum power for ψ —is a discrete version of the **Dirichlet problem**.

As we shall see, this version of the Dirichlet problem always has a solution. However, the solution is not necessarily unique. If we take a solution ϕ and some $\alpha \in \mathbb{R}^N$ that is constant on each connected component and vanishes on the boundary of Γ , it is clear that $\phi + \alpha$ is still an extension of ψ and that

$$\left. \frac{\partial P(\varphi)}{\partial \varphi(n)} \right|_{\varphi=\phi} = \left. \frac{\partial P(\varphi)}{\partial \varphi(n)} \right|_{\varphi=\phi+\alpha},$$

so $\phi + \alpha$ is another solution. We say that a connected component of a circuit **touches the boundary** if it contains a vertex in ∂N . Note that such an α must vanish on all connected components touching the boundary.

With these preliminaries in hand, standard techniques can be used to solve the Dirichlet problem [Fuk80]:

Proposition 6.7. *For any boundary potential $\psi \in \mathbb{R}^{\partial N}$ there exists a potential ϕ obeying the principle of minimum power for ψ . If we also demand that ϕ vanish on every connected component of Γ not touching the boundary, then ϕ is unique.*

Proof. For existence, observe that the power is a nonnegative quadratic form, the extensions of ψ form an affine subspace of \mathbb{R}^N , and a nonnegative quadratic form restricted to an affine subspace of a real vector space must reach a minimum somewhere on this subspace.

For uniqueness, suppose that both ϕ and ϕ' obey the principle of minimum power for ψ . Let

$$\alpha = \phi' - \phi.$$

Then

$$\alpha|_{\partial N} = \phi'|_{\partial N} - \phi|_{\partial N} = \psi - \psi = 0,$$

so $\phi + \lambda\alpha$ is an extension of ψ for all $\lambda \in \mathbb{R}$. This implies that

$$f(\lambda) := P(\phi + \lambda\alpha)$$

is a smooth function attaining its minimum value at both $\lambda = 0$ and $\lambda = 1$. In particular, this implies that $f'(0) = 0$. But this means that when writing f as a

quadratic, the coefficient of λ must be 0, so we can write

$$\begin{aligned}
2f(\lambda) &= \sum_{e \in E} \frac{1}{r(e)} \left((\phi + \lambda\alpha)(t(e)) - (\phi + \lambda\alpha)(s(e)) \right)^2 \\
&= \sum_{e \in E} \frac{1}{r(e)} \left((\phi(t(e)) - \phi(s(e))) + \lambda(\alpha(t(e)) - \alpha(s(e))) \right)^2 \\
&= \sum_{e \in E} \frac{1}{r(e)} (\phi(t(e)) - \phi(s(e)))^2 + \lambda\text{-term} + \lambda^2 \sum_{e \in E} \frac{1}{r(e)} (\alpha(t(e)) - \alpha(s(e)))^2 \\
&= \sum_{e \in E} \frac{1}{r(e)} (\phi(t(e)) - \phi(s(e)))^2 + \lambda^2 \sum_{e \in E} \frac{1}{r(e)} (\alpha(t(e)) - \alpha(s(e)))^2.
\end{aligned}$$

Then

$$f(1) - f(0) = \frac{1}{2} \sum_{e \in E} \frac{1}{r(e)} (\alpha(t(e)) - \alpha(s(e)))^2 = 0,$$

so $\alpha(t(e)) = \alpha(s(e))$ for every edge $e \in E$. This implies that α is constant on each connected component of the graph Γ of our circuit.

Note that as $\alpha|_{\partial N} = 0$, α vanishes on every connected component of Γ touching the boundary. Note also that there always exists a solution ϕ that vanishes on any connected component of Γ not touching the boundary: indeed, the total power dissipated is simply the sum of the power dissipated on each connected component, and any such vanishing potential dissipates zero power away from the boundary. Restricting our attention to solutions ϕ and ϕ' with this property, we see that $\alpha = \phi' - \phi$ vanishes on all connected components of Γ , and hence is identically zero. Thus $\phi' = \phi$, and this extra condition ensures a unique solution to the Dirichlet problem. \square

We have also shown the following:

Proposition 6.8. *Suppose $\psi \in \mathbb{R}^{\partial N}$ and ϕ is a potential obeying the principle of minimum power for ψ . Then ϕ' obeys the principle of minimum power for ψ if and only if the difference $\phi' - \phi$ is constant on every connected component of Γ and vanishes on every connected component touching the boundary of Γ .*

Furthermore, ϕ depends linearly on ψ :

Proposition 6.9. *Fix $\psi \in \mathbb{R}^{\partial N}$, and suppose $\phi \in \mathbb{R}^N$ is the unique potential obeying the principle of minimum power for ψ that vanishes on all connected components of Γ not touching the boundary. Then ϕ depends linearly on ψ .*

Proof. Fix $\psi, \psi' \in \mathbb{R}^{\partial N}$, and suppose $\phi, \phi' \in \mathbb{R}^N$ obey the principle of minimum power for ψ, ψ' respectively, and that both ϕ and ϕ' vanish on all connected components of Γ not touching the boundary.

Then, for all $\lambda \in \mathbb{R}$,

$$(\phi + \lambda\phi')|_{\mathbb{R}\partial N} = \phi|_{\mathbb{R}\partial N} + \lambda\phi'|_{\mathbb{R}\partial N} = \psi + \lambda\psi'$$

and

$$(\nabla(\phi + \lambda\phi'))|_{\mathbb{R}\partial N} = (\nabla\phi)|_{\mathbb{R}\partial N} + \lambda(\nabla\phi')|_{\mathbb{R}\partial N} = 0.$$

Thus $\phi + \lambda\phi'$ solves the Dirichlet problem for $\psi + \lambda\psi'$, and thus ϕ depends linearly on ψ . \square

Bamberg and Sternberg [BS82] describe another way to solve the Dirichlet problem, going back to Weyl [Wey23].

6.2.4 Equivalent circuits

We have seen that boundary potentials determine, essentially uniquely, the value of all the electric properties across the entire circuit. But from the perspective of control theory, this internal structure is irrelevant: we can only access the circuit at its terminals, and hence only need concern ourselves with the relationship between boundary potentials and boundary currents. In this section we streamline our investigations above to state the precise way in which boundary currents depend on boundary potentials. In particular, we shall see that the relationship is completely captured by the functional taking boundary potentials to the minimum power used by any extension of that boundary potential. Furthermore, each such power functional determines a different boundary potential–boundary current relationship, and so we can conclude that two circuits are equivalent if and only if they have the same power functional.

An ‘external behaviour’, or **behaviour** for short, is an equivalence class of circuits, where two are considered equivalent when the boundary current is the same function of the boundary potential. The idea is that the boundary current and boundary potential are all that can be observed ‘from outside’, i.e. by making measurements at the terminals. Restricting our attention to what can be observed by making measurements at the terminals amounts to treating a circuit as a ‘black box’: that is, treating its interior as hidden from view. So, two circuits give the same behaviour when they behave the same as ‘black boxes’.

First let us check that the boundary current is a function of the boundary potential. For this we introduce an important quadratic form on the space of boundary potentials:

Definition 6.10. The **power functional** $Q: \mathbb{R}^{\partial N} \rightarrow \mathbb{R}$ of a circuit with extended power functional P is given by

$$Q(\psi) = \min_{\phi|_{\mathbb{R}^{\partial N}=\psi}} P(\phi).$$

Proposition 6.7 shows the minimum above exists, so the power functional is well defined. Thanks to the principle of minimum power, $Q(\psi)$ equals $\frac{1}{2}$ times the power dissipated by the circuit when the boundary voltage is ψ . We will later see that in fact $Q(\psi)$ is a nonnegative quadratic form on $\mathbb{R}^{\partial N}$.

Since Q is a smooth real-valued function on $\mathbb{R}^{\partial N}$, its differential dQ at any given point $\psi \in \mathbb{R}^{\partial N}$ defines an element of the dual space $(\mathbb{R}^{\partial N})^*$, which we denote by dQ_ψ . In fact, this element is equal to the boundary current ι corresponding to the boundary voltage ψ :

Proposition 6.11. *Suppose $\psi \in \mathbb{R}^{\partial N}$. Suppose ϕ is any extension of ψ minimizing the power. Then $dQ_\psi \in (\mathbb{R}^{\partial N})^* \cong \mathbb{R}^{\partial N}$ gives the boundary current of the current induced by the potential ϕ .*

Proof. Note first that while there may be several choices of ϕ minimizing the power subject to the constraint that $\phi|_{\mathbb{R}^{\partial N}} = \psi$, Proposition 6.8 says that the difference between any two choices vanishes on all components touching the boundary of Γ . Thus, these two choices give the same value for the boundary current $\iota: \partial N \rightarrow \mathbb{R}$. So, with no loss of generality we may assume ϕ is the unique choice that vanishes on all components not touching the boundary. Write $\bar{\iota}: N \rightarrow \mathbb{R}$ for the extension of $\iota: \partial N \rightarrow \mathbb{R}$ to N taking value 0 on $N \setminus \partial N$.

By Proposition 6.9, there is a linear operator

$$f: \mathbb{R}^{\partial N} \longrightarrow \mathbb{R}^N$$

sending $\psi \in \mathbb{R}^{\partial N}$ to this choice of ϕ , and then

$$Q(\psi) = P(f\psi).$$

Given any $\psi' \in \mathbb{R}^{\partial N}$, we thus have

$$\begin{aligned}
dQ_\psi(\psi') &= \left. \frac{d}{d\lambda} Q(\phi + \lambda\psi') \right|_{\lambda=0} \\
&= \left. \frac{d}{d\lambda} P(f(\psi + \lambda\psi')) \right|_{\lambda=0} \\
&= \left. \frac{1}{2} \frac{d}{d\lambda} \sum_{e \in E} \frac{1}{r(e)} \left(f(\psi + \lambda\psi')(t(e)) - f(\psi + \lambda\psi')(s(e)) \right)^2 \right|_{\lambda=0} \\
&= \left. \frac{1}{2} \frac{d}{d\lambda} \sum_{e \in E} \frac{1}{r(e)} \left((f\psi(t(e)) - f\psi(s(e))) + \lambda(f\psi'(t(e)) - f\psi'(s(e))) \right)^2 \right|_{\lambda=0} \\
&= \sum_{e \in E} \frac{1}{r(e)} (f\psi(t(e)) - f\psi(s(e))) (f\psi'(t(e)) - f\psi'(s(e))) \\
&= \sum_{e \in E} I(e) (f\psi'(t(e)) - f\psi'(s(e))) \\
&= \sum_{n \in N} \left(\sum_{t(e)=n} I(e) - \sum_{s(e)=n} I(e) \right) f\psi'(n) \\
&= \sum_{n \in N} \bar{\iota}(n) f\psi'(n) \\
&= \sum_{n \in \partial N} \iota(n) \psi'(n).
\end{aligned}$$

This shows that $dQ_\psi^* = \iota$, as claimed. Note that this calculation explains why we inserted a factor of $\frac{1}{2}$ in the definition of P : it cancels the factor of 2 obtained from differentiating a square. \square

Note this only depends on Q , which makes no mention of the potentials at nonterminals. This is amazing: the way power depends on boundary potentials completely characterizes the way boundary currents depend on boundary potentials. In particular, in §6.4 we shall see that this allows us to define a composition rule for behaviours of circuits.

To demonstrate these notions, we give a basic example of equivalent circuits.

Example 6.12 (Resistors in series). Resistors are said to be placed in **series** if they are placed end to end or, more precisely, if they form a path with no self-intersections. It is well known that resistors in series are equivalent to a single resistor with resistance equal to the sum of their resistances. To prove this, consider the following circuit comprising two resistors in series, with input A and output C :

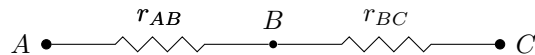

Now, the extended power functional $P: \mathbb{R}^{\{A,B,C\}} \rightarrow \mathbb{R}$ for this circuit is

$$P(\phi) = \frac{1}{2} \left(\frac{1}{r_{AB}} (\phi(A) - \phi(B))^2 + \frac{1}{r_{BC}} (\phi(B) - \phi(C))^2 \right),$$

while the power functional $Q: \mathbb{R}^{\{A,C\}} \rightarrow \mathbb{R}$ is given by minimization over values of $\phi(B) = x$:

$$Q(\psi) = \min_{x \in \mathbb{R}} \frac{1}{2} \left(\frac{1}{r_{AB}} (\psi(A) - x)^2 + \frac{1}{r_{BC}} (x - \psi(C))^2 \right).$$

Differentiating with respect to x , we see that this minimum occurs when

$$\frac{1}{r_{AB}} (x - \psi(A)) + \frac{1}{r_{BC}} (x - \psi(C)) = 0,$$

and hence when x is the r -weighted average of $\psi(A)$ and $\psi(C)$:

$$x = \frac{r_{BC}\psi(A) + r_{AB}\psi(C)}{r_{BC} + r_{AB}}.$$

Substituting this value for x into the expression for Q above and simplifying gives

$$Q(\psi) = \frac{1}{2} \cdot \frac{1}{r_{AB} + r_{BC}} (\psi(A) - \psi(C))^2.$$

This is also the power functional of the circuit

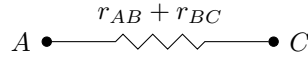

and so the circuits are equivalent.

6.2.5 Dirichlet forms

In the previous subsection we claimed that power functionals are quadratic forms on the boundary of the circuit whose behaviour they represent. They comprise, in fact, precisely those quadratic forms known as Dirichlet forms.

Definition 6.13. Given a finite set S , a **Dirichlet form** on S is a quadratic form $Q: \mathbb{R}^S \rightarrow \mathbb{R}$ given by the formula

$$Q(\psi) = \sum_{i,j \in S} c_{ij} (\psi_i - \psi_j)^2$$

for some nonnegative real numbers c_{ij} , and where we have written $\psi_i = \psi(i) \in \mathbb{R}$.

Note that we may assume without loss of generality that $c_{ii} = 0$ and $c_{ij} = c_{ji}$; we do this henceforth. Any Dirichlet form is nonnegative: $Q(\psi) \geq 0$ for all $\psi \in \mathbb{R}^S$. However, not all nonnegative quadratic forms are Dirichlet forms. For example, if $S = \{1, 2\}$, the nonnegative quadratic form $Q(\psi) = (\psi_1 + \psi_2)^2$ is not a Dirichlet form. That said, the concept of Dirichlet form is vastly more general than the above definition: such quadratic forms are studied not just on finite-dimensional vector spaces \mathbb{R}^S but on L^2 of any measure space. When this measure space is just a finite set, the concept of Dirichlet form reduces to the definition above. For a thorough introduction to Dirichlet forms, see the text by Fukushima [Fuk80]. For a fun tour of the underlying ideas, see the paper by Doyle and Snell [DS84].

The following characterizations of Dirichlet forms help illuminate the concept:

Proposition 6.14. *Given a finite set S and a quadratic form $Q: \mathbb{R}^S \rightarrow \mathbb{R}$, the following are equivalent:*

- (i) Q is a Dirichlet form.
- (ii) $Q(\phi) \leq Q(\psi)$ whenever $|\phi_i - \phi_j| \leq |\psi_i - \psi_j|$ for all i, j .
- (iii) $Q(\phi) = 0$ whenever ϕ_i is independent of i , and Q obeys the **Markov property**:
 $Q(\phi) \leq Q(\psi)$ when $\phi_i = \min(\psi_i, 1)$.

Proof. See Fukushima [Fuk80]. □

While the extended power functionals of circuits are evidently Dirichlet forms, it is not immediate that all power functionals are. For this it is crucial that the property of being a Dirichlet form is preserved under minimising over linear subspaces of the domain that are generated by subsets of the given finite set.

Proposition 6.15. *If $Q: \mathbb{R}^{S+T} \rightarrow \mathbb{R}$ is a Dirichlet form, then*

$$\min_{\nu \in \mathbb{R}^T} Q(-, \nu): \mathbb{R}^S \rightarrow \mathbb{R}$$

is Dirichlet.

Proof. We first note that $\min_{\nu \in \mathbb{R}^T} Q(-, \nu)$ is a quadratic form. Again, $\min_{\nu \in \mathbb{R}^T} Q(-, \nu)$ is well defined as a nonnegative quadratic form also attains its minimum on an affine subspace of its domain. Furthermore $\min_{\nu \in \mathbb{R}^T} Q(-, \nu)$ is itself a quadratic form, as the partial derivatives of Q are linear, and hence the points at which these minima are attained depend linearly on the argument of $\min_{\nu \in \mathbb{R}^T} Q(-, \nu)$.

Now by Proposition 6.14, $Q(\phi) \leq Q(\phi')$ whenever $|\phi_i - \phi_j| \leq |\phi'_i - \phi'_j|$ for all $i, j \in S + T$. In particular, this implies $\min_{\nu \in \mathbb{R}^T} Q(\psi, \nu) \leq \min_{\nu \in \mathbb{R}^T} Q(\psi', \nu)$ whenever $|\psi_i - \psi_j| \leq |\psi'_i - \psi'_j|$ for all $i, j \in S$. Using Proposition 6.14 again then implies that $\min_{\nu \in \mathbb{R}^T} Q(-, \nu)$ is a Dirichlet form. \square

Corollary 6.16. *Let $Q: \mathbb{R}^{\partial N} \rightarrow \mathbb{R}$ be the power functional for some circuit. Then Q is a Dirichlet form.*

Proof. The extended power functional P is a Dirichlet form, and writing $\mathbb{R}^N = \mathbb{R}^{\partial N} \oplus \mathbb{R}^{N \setminus \partial N}$ allows us to write

$$Q(-) = \min_{\phi \in \mathbb{R}^{N \setminus \partial N}} P(-, \phi). \quad \square$$

The converse is also true: simply construct the circuit with set of vertices ∂N and an edge of resistance $\frac{1}{2c_{ij}}$ between any $i, j \in \partial N$ such that the term $c_{ij}(\psi_i - \psi_j)$ appears in the Dirichlet form. This gives:

Proposition 6.17. *A function is the power functional for some circuit if and only if it is a Dirichlet form.*

This is an expression of the ‘star-mesh transform’, a well-known fact of electrical engineering stating that every circuit of linear resistors is equivalent to some complete graph of resistors between its terminals. For more details see [LO73]. We may interpret the proof of Proposition 6.15 as showing that intermediate potentials at minima depend linearly on boundary potentials, in fact a weighted average, and that substituting these into a quadratic form still gives a quadratic form.

In summary, in this section we have shown the existence of a surjective function

$$\left\{ \begin{array}{l} \text{circuits of linear resistors} \\ \text{with boundary } \partial N \end{array} \right\} \longrightarrow \left\{ \text{Dirichlet forms on } \partial N \right\}$$

mapping two circuits to the same Dirichlet form if and only if they have the same external behaviour. In the next section we extend this result to encompass inductors and capacitors too.

6.3 Inductors and capacitors

The intuition gleaned from the study of resistors carries over to inductors and capacitors too, to provide a framework for studying what are known as passive linear

networks. To understand inductors and capacitors in this way, however, we must introduce a notion of time dependency and subsequently the Laplace transform, which allows us to work in the so-called frequency domain. Here, like resistors, inductors and capacitors simply impose a relationship of proportionality between the voltages and currents that run across them. The constant of proportionality is known as the impedance of the component.

As for resistors, the interconnection of such components may be understood, at least formally, as a minimization of some quantity, and we may represent the behaviours of this class of circuits with a more general idea of Dirichlet form.

6.3.1 The frequency domain and Ohm's law revisited

In broadening the class of electrical circuit components under examination, we find ourselves dealing with components whose behaviours depend on the rates of change of current and voltage with respect to time. We thus now consider time-varying voltages $v: [0, \infty) \rightarrow \mathbb{R}$ and currents $i: [0, \infty) \rightarrow \mathbb{R}$, where $t \in [0, \infty)$ is a real variable representing time. For mathematical reasons, we restrict these voltages and currents to only those with (i) zero initial conditions (that is, $f(0) = 0$) and (ii) Laplace transform lying in the field

$$\mathbb{R}(s) = \left\{ Z(s) = \frac{P(s)}{Q(s)} \mid P, Q \text{ polynomials over } \mathbb{R} \text{ in } s, Q \neq 0 \right\}$$

of real rational functions of one variable. While it is possible that physical voltages and currents might vary with time in a more general way, we restrict to these cases as the rational functions are, crucially, well behaved enough to form a field, and yet still general enough to provide arbitrarily close approximations to currents and voltages found in standard applications.

An **inductor** is a two-terminal circuit component across which the voltage is proportional to the rate of change of the current. By convention we draw this as follows, with the inductance L the constant of proportionality:²

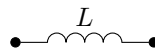

Writing $v_L(t)$ and $i_L(t)$ for the voltage and current over time t across this component respectively, and using a dot to denote the derivative with respect to time t , we thus have the relationship

$$v_L(t) = L \dot{i}_L(t).$$

²We follow the standard convention of denoting inductance by the letter L , after the work of Heinrich Lenz and to avoid confusion with the I used for current.

Permuting the roles of current and voltage, a **capacitor** is a two-terminal circuit component across which the current is proportional to the rate of change of the voltage. We draw this as follows, with the capacitance C the constant of proportionality:

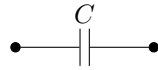

Writing $v_C(t)$, $i_C(t)$ for the voltage and current across the capacitor, this gives the equation

$$i_C(t) = C \dot{v}_C(t).$$

We assume here that inductances L and capacitances C are positive real numbers.

Although inductors and capacitors impose a linear relationship if we involve the derivatives of current and voltage, to mimic the above work on resistors we wish to have a constant of proportionality between functions representing the current and voltage themselves. Various integral transforms perform just this role; electrical engineers typically use the Laplace transform. This lets us write a function of time t instead as a function of frequencies s , and in doing so turns differentiation with respect to t into multiplication by s , and integration with respect to t into division by s .

In detail, given a function $f(t): [0, \infty) \rightarrow \mathbb{R}$, we define the **Laplace transform** of f

$$\mathfrak{L}\{f\}(s) = \int_0^{\infty} f(t)e^{-st} dt.$$

We also use the notation $\mathfrak{L}\{f\}(s) = F(s)$, denoting the Laplace transform of a function in upper case, and refer to the Laplace transforms as lying in the **frequency domain** or **s -domain**. For us, the three crucial properties of the Laplace transform are then:

- (i) linearity: $\mathfrak{L}\{af + bg\}(s) = aF(s) + bG(s)$ for $a, b \in \mathbb{R}$;
- (ii) differentiation: $\mathfrak{L}\{\dot{f}\}(s) = sF(s) - f(0)$;
- (iii) integration: if $g(t) = \int_0^t f(\tau)d\tau$ then $G(s) = \frac{1}{s}F(s)$.

Writing $V(s)$ and $I(s)$ for the Laplace transform of the voltage $v(t)$ and current $i(t)$ across a component respectively, and recalling that by assumption $v(t) = i(t) = 0$ for $t \leq 0$, the s -domain behaviours of components become, for a resistor of resistance R :

$$V(s) = RI(s),$$

for an inductor of inductance L :

$$V(s) = sLI(s),$$

and for a capacitor of capacitance C :

$$V(s) = \frac{1}{sC}I(s).$$

Note that for each component the voltage equals the current times a rational function of the real variable s , called the **impedance** and in general denoted by Z . Note also that the impedance is a **positive real function**, meaning that it lies in the set

$$\{Z \in \mathbb{R}(s) : \forall s \in \mathbb{C} \operatorname{Re}(s) > 0 \implies \operatorname{Re}(Z(s)) > 0\}.$$

While Z is a quotient of polynomials with real coefficients, in this definition we are applying it to complex values of s , and demanding that its real part be positive in the open left half-plane. Positive real functions were introduced by Otto Brune in 1931, and they play a basic role in circuit theory [Bru31].

Indeed, Brune convincingly argued that for any conceivable passive linear component with two terminals we have this generalization of Ohm's law:

$$V(s) = Z(s)I(s)$$

where $I \in \mathbb{R}(s)$ is the **current**, $V \in \mathbb{R}(s)$ is the **voltage** and the positive real function Z is the **impedance** of the component. As we shall see, generalizing from circuits of linear resistors to arbitrary passive linear circuits is just a matter of formally replacing resistances by impedances.

As we consider passive linear circuits with more than two terminals, however, the coefficients of our power functionals lie not just in the set of positive real functions, but in its closure $\mathbb{R}(s)^+$ under addition, multiplication, and division. Note that this closure is strictly smaller than $\mathbb{R}(s)$, as each positive real function is takes strictly positive real values on the positive real axis, so no matter how we take sums, products, and quotients of positive real functions it never results in the zero function $0 \in \mathbb{R}(s)$. To generalise from linear resistors to passive linear circuits, we then replace the field \mathbb{R} by the larger field $\mathbb{R}(s)$, and replace the set of positive reals, $\mathbb{R}^+ = (0, \infty)$, by the set $\mathbb{R}(s)^+$. From a mathematical perspective we might as well work with any field with a notion of 'positive element'.

Definition 6.18. Given a field \mathbb{F} , we define a **set of positive elements** for \mathbb{F} to be any subset $\mathbb{F}^+ \subset \mathbb{F}$ not containing 0 and closed under addition, multiplication, and division.

Our first motivating example arises from circuits made of resistors. Here $\mathbb{F} = \mathbb{R}$ is the field of real numbers and we take $\mathbb{F}^+ = (0, \infty)$. Our second motivating example arises from general passive linear circuits. Here $\mathbb{F} = \mathbb{R}(s)$ is the field of rational functions in one real variable, and we take $\mathbb{F}^+ = \mathbb{R}(s)^+$ to be the closure of the positive real functions, as defined above.

In all that follows, we fix a field \mathbb{F} of characteristic zero equipped with a set of positive elements \mathbb{F}^+ . By a ‘circuit’, we shall henceforth mean a circuit over \mathbb{F}^+ , as explained in Definition 6.3. To fix the notation:

Definition 6.19. A (**passive linear**) **circuit** is a graph $s, t: E \rightarrow N$ with E as its set of **edges** and N as its set of **nodes**, equipped with function $Z: E \rightarrow \mathbb{F}^+$ assigning each edge an **impedance**, together with finite sets X, Y , and functions $i: X \rightarrow N$ and $o: Y \rightarrow N$. We call the sets $i(X)$, $o(Y)$, and $\partial N = i(X) \cup o(Y)$ the **inputs**, **outputs**, and **terminals** or **boundary** of the circuit, respectively.

We next remark on the analogy between electronics and mechanics in light of these new components.

6.3.2 The mechanical analogy

Now that we have introduced inductors and capacitors, it is worth taking another glance at the analogy chart in Section 6.1. What are the analogues of resistance, inductance and capacitance in mechanics? If we restrict attention to systems with translational degrees of freedom, the answer is given in the following chart.

Electronics	Mechanics (translation)
charge Q	position q
current $i = \dot{Q}$	velocity $v = \dot{q}$
flux linkage λ	momentum p
voltage $v = \dot{\lambda}$	force $F = \dot{p}$
resistance R	damping coefficient c
inductance L	mass m
inverse capacitance C^{-1}	spring constant k

A famous example concerns an electric circuit with a resistor of resistance R , an inductor of inductance L , and a capacitor of capacitance C , all in series:

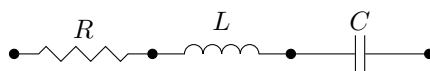

We saw in Example 6.12 that for resistors in series, the resistances add. The same fact holds more generally for passive linear circuits, so the impedance of this circuit is the sum

$$Z = sL + R + (sC)^{-1}.$$

Thus, the voltage across this circuit is related to the current through the circuit by

$$V(s) = (sL + R + (sC)^{-1})I(s)$$

If $v(t)$ and $i(t)$ are the voltage and current as functions of time, we conclude that

$$v(t) = L \frac{d}{dt} i(t) + Ri(t) + C^{-1} \int_0^t i(s) ds$$

It follows that

$$L\ddot{Q} + R\dot{Q} + C^{-1}Q = v$$

where $Q(t) = \int_0^t i(s) ds$ has units of charge. As the chart above suggests, this equation is analogous to that of a damped harmonic oscillator:

$$m\ddot{q} + c\dot{q} + kq = F$$

where m is the mass of the oscillator, c is the damping coefficient, k is the spring constant and F is a time-dependent external force.

For details, and many more analogies of this sort, see the book by Karnopp, Margolis and Rosenberg [KMR90] or Brown's enormous text [Bro07]. While it would be a distraction to discuss them further here, these analogies mean that our work applies to a wide class of networked systems, not just electrical circuits.

6.3.3 Generalized Dirichlet forms

To understand the behaviour of passive linear circuits we need to understand how the behaviours of individual components, governed by Ohm's law, fit together to give the behaviour of an entire network. Kirchhoff's laws still hold, and so does a version of the principle of minimum power.

As before, to each passive linear circuit we associate a generalised Dirichlet form.

Definition 6.20. Given a field \mathbb{F} and a finite set S , a **Dirichlet form over \mathbb{F}** on S is a quadratic form $Q: \mathbb{F}^S \rightarrow \mathbb{F}$ given by the formula

$$Q(\psi) = \sum_{i,j \in S} c_{ij} (\psi_i - \psi_j)^2,$$

where $c_{ij} \in \mathbb{F}^+$.

Generalizing from circuits of resistors, we define the **extended power functional** $P: \mathbb{F}^N \rightarrow \mathbb{F}$ of any circuit by

$$P(\varphi) = \frac{1}{2} \sum_{e \in E} \frac{1}{Z(e)} (\varphi(t(e)) - \varphi(s(e)))^2.$$

and we call $\varphi \in \mathbb{F}^N$ a **potential**. Note we have assumed that \mathbb{F} has characteristic zero, so dividing by 2 is allowed. Note also that the extended power functional is a Dirichlet form on N .

Although it is not clear what it means to minimize over the field \mathbb{F} , we can use formal derivatives to formulate an analogue of the principle of minimum power. This will actually be a ‘variational principle’, saying the derivative of the power functional vanishes with respect to certain variations in the potential. As before we shall see that given Ohm’s law, this principle is equivalent to Kirchhoff’s current law.

Indeed, the extended power functional $P(\varphi)$ can be considered an element of the polynomial ring $\mathbb{F}[\{\varphi(n)\}_{n \in N}]$ generated by formal variables $\varphi(n)$ corresponding to potentials at the nodes $n \in N$. We may thus take formal derivatives of the extended power functional with respect to the $\varphi(n)$. We then call $\phi \in \mathbb{F}^N$ a **realizable potential** for the given circuit if for each nonterminal node, $n \in N \setminus \partial N$, the formal partial derivative of the extended power functional with respect to $\varphi(n)$ equals zero when evaluated at ϕ :

$$\left. \frac{\partial P}{\partial \varphi(n)} \right|_{\varphi=\phi} = 0$$

This terminology arises from the following fact, a generalization of Proposition 6.6:

Theorem 6.21. *The potential $\phi \in \mathbb{F}^N$ is a realizable potential for a given circuit if and only if the induced current*

$$I(e) = \frac{1}{Z(e)} (\phi(t(e)) - \phi(s(e)))$$

obeys Kirchhoff’s current law:

$$\sum_{s(e)=n} I(e) = \sum_{t(e)=n} I(e)$$

for all $n \in N \setminus \partial N$.

Proof. The proof of this statement is exactly that for Proposition 6.6. □

A corollary of Theorem 6.21 is that the set of states—that is, potential–current pairs—that are compatible with the governing laws of a circuit is given by the set of realizable potentials together with their induced currents.

6.3.4 A generalized minimizability result

We begin to move from a discussion of the intrinsic behaviours of circuits to a discussion of their behaviours under composition. The key fact for composition of generalized Dirichlet forms is that, in analogy with Proposition 6.15, we may speak of a formal version of minimization of Dirichlet forms. We detail this here. In what follows let P be a Dirichlet form over \mathbb{F} on some finite set S .

Recall that given $R \subseteq S$, we call $\tilde{\psi} \in \mathbb{F}^S$ an **extension** of $\psi \in \mathbb{F}^R$ if $\tilde{\psi}$ restricted to R equals ψ . We call such an extension **realizable** if

$$\left. \frac{\partial P}{\partial \varphi(s)} \right|_{\varphi=\tilde{\psi}} = 0$$

for all $s \in S \setminus R$. Note that over the real numbers \mathbb{R} this means that among all the extensions of ψ , $\tilde{\psi}$ minimizes the function P .

Theorem 6.22. *Let P be a Dirichlet form over \mathbb{F} on S , and let $R \subseteq S$ be an inclusion of finite sets. Then we may uniquely define a Dirichlet form*

$$\min_{S \setminus R} P : \mathbb{F}^R \rightarrow \mathbb{F}$$

on R by sending each $\psi \in \mathbb{F}^R$ to the value $P(\tilde{\psi})$ of any realizable extension $\tilde{\psi}$ of ψ .

To prove this theorem, we must first show that $\min_{S \setminus R} P$ is well defined as a function.

Lemma 6.23. *Let P be a Dirichlet form over \mathbb{F} on S , let $R \subseteq S$ be an inclusion of finite sets, and let $\psi \in \mathbb{F}^R$. Then for all realizable extensions $\tilde{\psi}, \tilde{\psi}' \in \mathbb{F}^S$ of ψ we have $P(\tilde{\psi}) = P(\tilde{\psi}')$.*

Proof. This follows from the formal version of the multivariable Taylor theorem for polynomial rings over a field of characteristic zero (see [Bou90, §IV.4.5]). Let $\tilde{\psi}, \tilde{\psi}' \in \mathbb{F}^S$ be realizable extensions of ψ , and note that $dP_{\tilde{\psi}}(\tilde{\psi} - \tilde{\psi}') = 0$, since for all $s \in R$ we have $\tilde{\psi}(s) - \tilde{\psi}'(s) = 0$, and for all $s \in S \setminus R$ we have

$$\left. \frac{\partial P}{\partial \varphi(s)} \right|_{\varphi=\tilde{\psi}} = 0.$$

We may take the Taylor expansion of P around $\tilde{\psi}$ and evaluate at $\tilde{\psi}'$. As P is a quadratic form, this gives

$$\begin{aligned} P(\tilde{\psi}') &= P(\tilde{\psi}) + dP_{\tilde{\psi}}(\tilde{\psi}' - \tilde{\psi}) + P(\tilde{\psi}' - \tilde{\psi}) \\ &= P(\tilde{\psi}) + P(\tilde{\psi}' - \tilde{\psi}). \end{aligned}$$

Similarly, we arrive at

$$P(\tilde{\psi}) = P(\tilde{\psi}') + P(\tilde{\psi} - \tilde{\psi}').$$

But again as P is a quadratic form, we then see that

$$P(\tilde{\psi}') - P(\tilde{\psi}) = P(\tilde{\psi}' - \tilde{\psi}) = P(\tilde{\psi} - \tilde{\psi}') = P(\tilde{\psi}) - P(\tilde{\psi}').$$

This implies that $P(\tilde{\psi}') - P(\tilde{\psi}) = 0$, as required. \square

It remains to show that $\min P$ remains a Dirichlet form. We do this inductively.

Lemma 6.24. *Let P be a Dirichlet form over \mathbb{F} on S , and let $s \in S$ be an element of S . Then the map $\min_{\{s\}} P : \mathbb{F}^{S \setminus \{s\}} \rightarrow \mathbb{F}$ sending ψ to $P(\tilde{\psi})$ is a Dirichlet form on $S \setminus \{s\}$.*

Proof. Write $P(\phi) = \sum_{i,j} c_{ij}(\phi_i - \phi_j)^2$, assuming without loss of generality that $c_{sk} = 0$ for all k . We then have

$$\left. \frac{\partial P}{\partial \varphi(s)} \right|_{\varphi=\phi} = \sum_k 2c_{ks}(\phi_s - \phi_k),$$

and this is equal to zero when

$$\phi_s = \frac{\sum_k c_{ks} \phi_k}{\sum_k c_{ks}}.$$

Note that the c_{ij} lie in \mathbb{F}^+ , and \mathbb{F}^+ is closed under addition, so $\sum_k c_{ks} \neq 0$. Thus $\min_{\{s\}} P$ may be given explicitly by the expression

$$\min_{\{s\}} P(\psi) = \sum_{i,j \in S \setminus \{s\}} c_{ij}(\psi_i - \psi_j)^2 + \sum_{\ell \in S \setminus \{s\}} c_{\ell s} \left(\psi_\ell - \frac{\sum_k c_{ks} \psi_k}{\sum_k c_{ks}} \right)^2.$$

We must show this is a Dirichlet form on $S \setminus \{s\}$.

As the sum of Dirichlet forms is evidently Dirichlet, it suffices to check that the expression

$$\sum_{\ell} c_{\ell s} \left(\psi_\ell - \frac{\sum_k c_{ks} \psi_k}{\sum_k c_{ks}} \right)^2$$

is Dirichlet on $S \setminus \{s\}$. Multiplying through by the constant $(\sum_k c_{ks})^2 \in \mathbb{F}^+$, it further

suffices to check

$$\begin{aligned}
& \sum_{\ell} c_{\ell s} \left(\sum_k c_{ks} \psi_{\ell} - \sum_k c_{ks} \psi_k \right)^2 \\
&= \sum_{\ell} c_{\ell s} \left(\sum_k c_{ks} (\psi_{\ell} - \psi_k) \right)^2 \\
&= \sum_{\ell} c_{\ell s} \left(2 \sum_{\substack{k,m \\ k \neq m}} c_{ks} c_{ms} (\psi_{\ell} - \psi_k) (\psi_{\ell} - \psi_m) + \sum_k c_{ks}^2 (\psi_{\ell} - \psi_k)^2 \right) \\
&= 2 \sum_{\substack{k,\ell,m \\ k \neq m}} c_{\ell s} c_{ks} c_{ms} (\psi_{\ell} - \psi_k) (\psi_{\ell} - \psi_m) + \sum_{k,\ell} c_{\ell s} c_{ks}^2 (\psi_{\ell} - \psi_k)^2
\end{aligned}$$

is Dirichlet. But

$$\begin{aligned}
& (\psi_k - \psi_{\ell})(\psi_k - \psi_m) + (\psi_{\ell} - \psi_k)(\psi_{\ell} - \psi_m) + (\psi_m - \psi_k)(\psi_m - \psi_{\ell}) \\
&= \psi_k^2 + \psi_{\ell}^2 + \psi_m^2 - \psi_k \psi_{\ell} - \psi_k \psi_m - \psi_{\ell} \psi_m \\
&= \frac{1}{2} \left((\psi_k - \psi_{\ell})^2 + (\psi_k - \psi_m)^2 + (\psi_{\ell} - \psi_m)^2 \right),
\end{aligned}$$

so this expression is indeed Dirichlet. Indeed, pasting these computations together shows that

$$\min_{\{s\}} P(\psi) = \sum_{i,j} \left(c_{ij} + \frac{c_{is} c_{js}}{\sum_k c_{ks}} \right) (\psi_i - \psi_j)^2. \quad \square$$

With these two lemmas, the proof of Theorem 6.22 becomes straightforward.

Proof of Theorem 6.22. Lemma 6.23 shows that $\min_{S \setminus R} P$ is a well-defined function. As R is a finite set, we may write it $R = \{s_1, \dots, s_n\}$ for some natural number n . Then we may define a sequence of functions $P_i = \min_{\{s_1, \dots, s_i\}} P_{i-1}$, $1 \leq i \leq n$. Define also $P_0 = P$, and note that $P_n = \min_{S \setminus R} P$. Then, by Lemma 6.24, each P_i is Dirichlet as P_{i-1} is. This proves the proposition. \square

We can thus define the power functional of a circuit by analogy with circuits made of resistors:

Definition 6.25. The **power functional** $Q: \mathbb{R}^{\partial N} \rightarrow \mathbb{R}$ of a circuit with extended power functional P is given by

$$Q = \min_{N \setminus \partial N} P.$$

As before, we call two circuits equivalent if they have the same power functional, and define the **behaviour** of a circuit to be its equivalence class.

We now have a complete description of the semantics of diagrams of passive linear networks. The purpose of this chapter is to show how to use decorated corelations to make this semantics compositional. We make a start on this in the next section.

6.4 A compositional perspective

Thus far our focus has been on the semantics of circuit diagrams, explaining how labelled graphs represent Dirichlet forms. We now wish to work towards a *compositional* semantics.

A prerequisite for this is compositional structure on our circuit diagrams and Dirichlet forms. We desire a compositional structure that captures the syntax of circuit diagrams, addressing the question: “How do we interact with circuit diagrams?” Informally, the answer is that we interact with them by connecting them to each other, perhaps after moving them into the right form by rotating or reflecting them, or by crossing, bending, splitting, and combining some of the wires. In line with the overarching philosophy of this thesis, it should come as no surprise that we hence model circuits as morphisms in a hypergraph category.

We begin this section by defining a hypergraph category of circuits. We then want to define a hypergraph category of behaviours. We have three desiderata for such a category. First, the category of behaviours should have a unique morphism for each distinct circuit behaviour. Second, the map taking a circuit to its behaviour should be structure preserving: that is, it should be a hypergraph functor to a hypergraph category. The third desideratum is one of aesthetics: the category of behaviours and its composition rule should be easy to define and work with.

It turns out, as we shall see, that Dirichlet forms are not quite general enough to accommodate our needs. In Subsection 6.4.2 we discuss an attempt to construct a ‘natural’ category of Dirichlet forms, with composition of Dirichlet forms given by taking their sum and minimising over the ‘interior’ terminals, but find that this operation does not have an identity. Despite this, we give an ad hoc construction of a category of Dirichlet corelations that at least fulfils the two technical desiderata above.

6.4.1 The category of open circuits

In Definition 6.19, we defined a circuit of linear resistors to be a labelled graph with marked input and output terminals, as in the example:

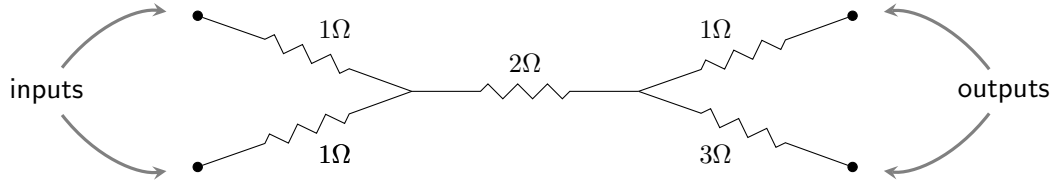

We then defined general passive linear circuits by replacing resistances with impedances chosen from a set of positive elements \mathbb{F}^+ in any field \mathbb{F} . These circuits are examples of decorated cospans. We now use decorated cospans to construct a hypergraph category Circ whose morphisms are circuits, such that the hypergraph structure expresses the syntactic operations on circuits discussed above.

Indeed, observe that a circuit is just an \mathbb{F}^+ -graph, as defined in the introduction to Chapter 2. Recall from Subsection 2.5.1 the lax symmetric monoidal functor

$$\text{Graph}: (\text{FinSet}, +) \longrightarrow (\text{Set}, \times)$$

mapping each finite set N to the set $\text{Graph}(N)$ of $[0, \infty)$ -graphs (N, E, s, t, r) with N as their set of nodes. Define the lax symmetric monoidal functor Circuit , generalising Graph , so that the set N is mapped to the set of \mathbb{F}^+ -graphs.

Definition 6.26. We define the hypergraph category

$$\text{Circ} = \text{CircuitCospan}.$$

Aside 6.27. As discussed in Subsection 2.2.3, by the work of Courser [Cou] we in fact have a symmetric monoidal bicategory 2-Circ of circuits with

objects	finite sets
morphisms	cospans of finite sets decorated by \mathbb{F}^+ -graphs
2-morphisms	maps of decorated cospans

Moreover, the work of Stay [Sta16] can be used to show this bicategory is compact closed. Decategorifying 2-Circ gives a category equivalent to our previously defined category Circ .

The hypergraph structure, including the compactness and dagger, captures the aforementioned syntactic operations that can be performed on circuits. The composition expresses the fact that we can connect the outputs of one circuit to the inputs of the next, like so:

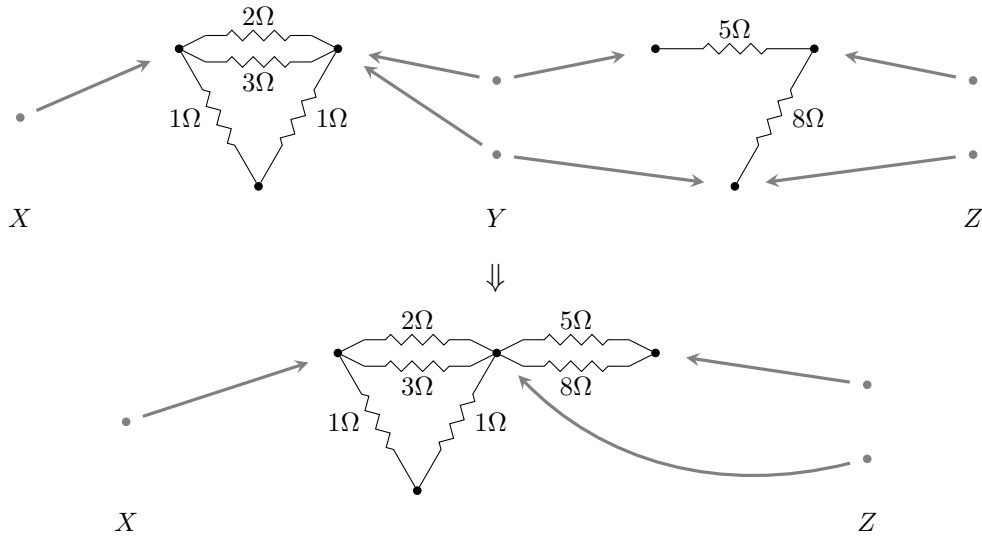

The monoidal composition models the placement of circuits side-by-side:

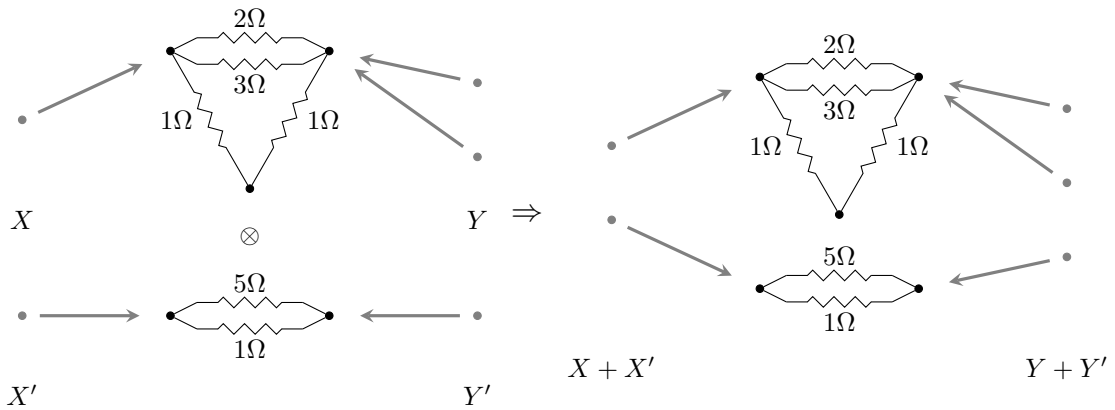

Identities and Frobenius maps result from identifying points. For example, the identity on a single point is the (empty) decorated cospan



while the multiplication on a point is the empty decorated cospan

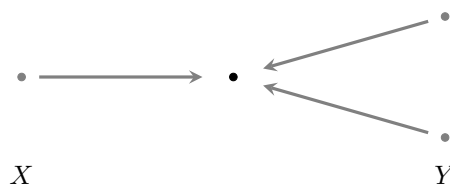

These identifications represent interconnection via ideal, perfectly conductive wires: if two terminals are connected by such wires, then the electrical behaviour at both terminals must be identical. The Frobenius maps allow us to split, combine, and discard wires. The symmetric monoidal structure allows us to reorder input and output wires. Derived from these, the compactness captures the interchangeability between input and outputs of circuits—that is, the fact that we can choose any input to our circuit and consider it instead as an output, and vice versa—while the dagger structure expresses the fact that we may reflect a whole circuit, switching all inputs with all outputs.

Recall that we consider two circuit diagrams equivalent if they have the same behaviour, or power functional. Now that we have constructed a hypergraph category where our morphisms are circuit diagrams—our ‘syntactic’ category for our diagrammatic language—we would also like to construct a hypergraph category with morphisms behaviours of circuits, and show that the map from a circuit to its behaviour defines a hypergraph functor.

6.4.2 An obstruction to black boxing

It would be nice to have a category in which Dirichlet forms are morphisms, such that the map sending a circuit to its behaviour is a functor. Here we present a naïve attempt to construct the category with Dirichlet forms as morphisms, using the principle of minimum power to compose these morphisms. Unfortunately the proposed category does not include identity morphisms. However, it points in the right direction, and underlines the importance of the cospan formalism we then turn to develop.

We can define a composition rule for Dirichlet forms that reflects composition of circuits. Given finite sets X and Y , let $X + Y$ denote their disjoint union. Let $D(X, Y)$ be the set of Dirichlet forms on $X + Y$. There is a way to compose these Dirichlet forms

$$\circ: D(Y, Z) \times D(X, Y) \rightarrow D(X, Z)$$

defined as follows. Given $P \in D(Y, Z)$ and $Q \in D(X, Y)$, let

$$(P \circ Q)(\alpha, \gamma) = \min_{\beta \in \mathbb{F}^Y} Q(\alpha, \beta) + P(\beta, \gamma),$$

where $\alpha \in \mathbb{F}^X$, $\gamma \in \mathbb{F}^Z$. This operation has a clear interpretation in terms of electrical circuits: the power used by the entire circuit is just the sum of the power used by its parts.

It is immediate from Theorem 6.22 that this composition rule is well defined: the composite of two Dirichlet forms is again a Dirichlet form. Moreover, this composition is associative. However, it fails to provide the structure of a category, as there is typically no Dirichlet form $1_X \in D(X, X)$ playing the role of the identity for this composition. For an indication of why this is so, let $\{\bullet\}$ be a set with one element, and suppose that some Dirichlet form $I(\beta, \gamma) = k(\beta - \gamma)^2 \in D(\{\bullet\}, \{\bullet\})$ acts as an identity on the right for this composition. Then for all $Q(\alpha, \beta) = c(\alpha - \beta)^2 \in D(\{\bullet\}, \{\bullet\})$, we must have

$$\begin{aligned} c\alpha^2 &= Q(\alpha, 0) \\ &= (I \circ Q)(\alpha, 0) \\ &= \min_{\beta \in \mathbb{F}} Q(\alpha, \beta) + I(\beta, 0) \\ &= \min_{\beta \in \mathbb{F}} k(\alpha - \beta)^2 + c\beta^2 \\ &= \frac{kc}{k+c}\alpha^2, \end{aligned}$$

where we have noted that $\frac{kc}{k+c}\alpha^2$ minimizes $k(\alpha - \beta)^2 + c\beta^2$ with respect to β . But for any choice of $k \in \mathbb{F}$ this equality only holds when $c = 0$, so no such Dirichlet form exists. Note, however, that for $k \gg c$ we have $c\alpha^2 \approx \frac{kc}{k+c}\alpha^2$, so Dirichlet forms with large values of k —corresponding to resistors with resistance close to zero—act as ‘approximate identities’.

In this way we might interpret the identities we wish to introduce into this category as the behaviours of idealized components with zero resistance: perfectly conductive wires. Unfortunately, the power functional of a purely conductive wire is undefined: the formula for it involves division by zero. In real life, coming close to this situation leads to the disaster that electricians call a ‘short circuit’: a huge amount of power dissipated for even a small voltage. This is why we have fuses and circuit breakers.

Nonetheless, we have most of the structure required for a category. A ‘category without identity morphisms’ is called a **semicategory**, so we see

Proposition 6.28. *There is a semicategory where:*

- *the objects are finite sets,*
- *a morphism from X to Y is a Dirichlet form $Q \in D(X, Y)$.*
- *composition of morphisms is given by*

$$(P \circ Q)(\gamma, \alpha) = \min_Y Q(\gamma, \beta) + P(\beta, \alpha).$$

We would like to make this into a category. One easy way to do this is to formally adjoin identity morphisms; this trick works for any semicategory. However, we obtain a better category if we include *more* morphisms: more behaviours corresponding to circuits made of perfectly conductive wires. The expression for the extended power functional includes the reciprocals of impedances, such circuits cannot be expressed within the framework we have developed thus far. Similarly, the Frobenius maps also have semantics as ideal wires, and cannot be represented using Dirichlet forms. Indeed, for these idealized circuits there is no function taking boundary potentials to boundary currents: the vanishing impedance would imply that any difference in potentials at the boundary induces ‘infinite’ currents. One way of dealing with this is to use decorated cospans.

6.4.3 The category of Dirichlet cospans

Although we cannot have Dirichlet forms be the morphisms of a category themselves, we have a standard trick for turning data into the morphisms of a category: we decorate cospans with them. The cospans then handle the composition for us. In this section we construct a category of cospans and a category of corelations decorated by Dirichlet forms. We shall think of the former as having extended power functionals as morphisms, and the latter as power functionals.

Consider a cospan of finite sets $X \rightarrow N \leftarrow Y$ together with a Dirichlet form Q_N on the apex N . We call this a **Dirichlet cospan**. To compose such cospans, say when given another cospan $Y \rightarrow M \leftarrow Z$ decorated by Dirichlet form Q_M , we decorated the composite cospan $X \rightarrow N +_Y M \leftarrow Z$ with the Dirichlet form

$$\begin{aligned} (j_{N*}Q_N + j_{M*}Q_M) : \mathbb{F}^{N+Y M} &\longrightarrow \mathbb{F}; \\ \phi &\longmapsto Q_N(\phi \circ j_N) + Q_M(\phi \circ j_M), \end{aligned}$$

where the j are the maps that include N and M into the pushout as usual. Interpreted in terms of extended power functionals, this simply says that the power consumed by the interconnected circuit is just the power consumed by each part. These form the morphisms of a decorated cospan category.

Proposition 6.29. *The following defines a lax symmetric monoidal functor (Dirich, δ) : let*

$$\text{Dirich} : (\text{FinSet}, +) \longrightarrow (\text{Set}, \times)$$

map a finite set X to the set $\text{Dirich}(X)$ of Dirichlet forms $Q: \mathbb{F}^X \rightarrow \mathbb{F}$ on X , and map a function $f: X \rightarrow Y$ between finite sets to the pushforward function

$$\begin{aligned} \text{Dirich}(f): \text{Dirich}(X) &\longrightarrow \text{Dirich}(Y); \\ Q &\longmapsto (f_*Q: \phi \mapsto Q(\phi \circ f)). \end{aligned}$$

For coherence maps, equip Dirich with the natural family of maps

$$\begin{aligned} \delta_{N,M}: \text{Dirich}(N) \times \text{Dirich}(M) &\longrightarrow \text{Dirich}(N + M) \\ (Q_N, Q_M) &\longmapsto \iota_{N*}Q_N + \iota_{M*}Q_M \end{aligned}$$

and also with the unit

$$\begin{aligned} \delta_1: 1 &\longrightarrow \text{Dirich}(\emptyset); \\ \bullet &\longmapsto (\mathbb{F}^\emptyset \rightarrow \mathbb{F}; ! \mapsto 0). \end{aligned}$$

Note that the sum of two Dirichlet forms is given pointwise by the addition in \mathbb{F} .

Proof. As composition of functions is associative and has an identity, Dirich is a functor. The naturality of the $\delta_{N,M}$ follows from the universal property of the coproduct in FinSet , while the symmetric monoidal coherence axioms follow from the associativity, unitality, and commutativity of addition in \mathbb{F} . \square

Using decorated cospans, we thus obtain a hypergraph category DirichCospan where a morphism is a cospan of finite sets whose apex is equipped with a Dirichlet form. Next, we use decorated cospans to construct a strict hypergraph functor $\text{Circ} \rightarrow \text{DirichCospan}$ sending a circuit to a cospan decorated by its extended power functional. For this we need a monoidal natural transformation $\theta: (\text{Circuit}, \rho) \Rightarrow (\text{Dirich}, \delta)$.

Proposition 6.30. *The collection of maps*

$$\begin{aligned} \theta_N: \text{Circuit}(N) &\longrightarrow \text{Dirich}(N); \\ (N, E, s, t, r) &\longmapsto \left(\phi \in \mathbb{F}^N \mapsto \frac{1}{2} \sum_{e \in E} \frac{1}{r(e)} (\phi(s(e)) - \phi(t(e)))^2 \right). \end{aligned}$$

defines a monoidal natural transformation

$$\theta: (\text{Circuit}, \rho) \Longrightarrow (\text{Dirich}, \delta).$$

Proof. Naturality requires that the square

$$\begin{array}{ccc} \text{Circuit}(N) & \xrightarrow{\theta_N} & \text{Dirich}(N) \\ \text{Circuit}(f) \downarrow & & \downarrow \text{Dirich}(f) \\ \text{Circuit}(M) & \xrightarrow{\theta_M} & \text{Dirich}(M) \end{array}$$

commutes. Let (N, E, s, t, r) be an \mathbb{F}^+ -graph on N and $f: N \rightarrow M$ be a function N to M . Then both $\text{Dirich}(f) \circ \theta_N$ and $\theta_M \circ \text{Circuit}(f)$ map (N, E, s, t, r) to the Dirichlet form

$$\begin{aligned} \mathbb{F}^M &\longrightarrow \mathbb{F}; \\ \psi &\longmapsto \frac{1}{2} \sum_{e \in E} \frac{1}{r(e)} (\psi(f(s(e))) - \psi(f(t(e))))^2. \end{aligned}$$

Thus both methods of constructing a power functional on a set of nodes M from a circuit on N and a function $f: N \rightarrow M$ produce the same power functional.

To show that θ is a monoidal natural transformation, we must check that the square

$$\begin{array}{ccc} \text{Circuit}(N) \times \text{Circuit}(M) & \xrightarrow{\theta_N \times \theta_M} & \text{Dirich}(N) \times \text{Dirich}(M) \\ \rho_{N,M} \downarrow & & \downarrow \delta_{N,M} \\ \text{Circuit}(N + M) & \xrightarrow{\theta_{N+M}} & \text{Dirich}(N + M) \end{array}$$

and the triangle

$$\begin{array}{ccc} & 1 & \\ \rho_\emptyset \swarrow & & \searrow \delta_\emptyset \\ \text{Circuit}(\emptyset) & \xrightarrow{\theta_\emptyset} & \text{Dirich}(\emptyset) \end{array}$$

commute. It is readily observed that both paths around the square lead to taking two graphs and summing their corresponding Dirichlet forms, and that the triangle commutes immediately as all objects in it are the one element set. \square

From decorated cospans, we thus obtain a strict hypergraph functor

$$Q: \text{Circ} = \text{CircuitCospan} \longrightarrow \text{DirichCospan}.$$

Informally, this says that the process of composition for circuit diagrams is the same as that of composition for Dirichlet cospans. Note that this is not a faithful functor. For example, applying Q to a circuit

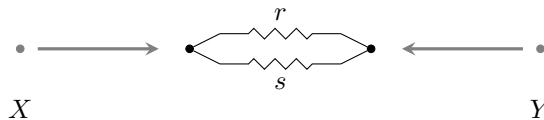

with two parallel edges of resistance r and s respectively, we obtain the same result as for the circuit

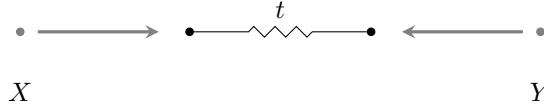

with just a single edge with resistance

$$t = \frac{1}{\frac{1}{r} + \frac{1}{s}}.$$

That is, both map to the Dirichlet cospan $X = \{x\} \rightarrow \{x, y\} \leftarrow \{y\} = Y$ with $\{x, y\}$ decorated by the Dirichlet form $P(\psi) = \frac{1}{t}(\psi_x - \psi_y)^2$. Nonetheless, this functor is far from the desired semantic functor: many different extended power functionals can restrict to the same power functional on the boundary.

6.4.4 A category of behaviours

For our functorial semantics, we wish to map a circuit to its power functional. We take a moment to briefly sketch how one could use decorated corelations to construct a codomain for such a functor. The result, however, is a little ad hoc, and we shall not pursue it in depth. Instead, in the next section, we shall generalize Dirichlet forms to Lagrangian relations.

Indeed, ideally we would have liked to use an isomorphism-morphism factorisation on FinSet , to construct isomorphism-morphism corelations decorated by Dirichlet forms. Then for a map $X \rightarrow Y$ the Dirichlet form must decorate the set $X + Y$, and we need not talk at all about cospans. We saw however, in the previous section, that a category with morphisms Dirichlet forms on the disjoint union of the domain and codomain is not possible. As a consolation prize we may use the epi-mono factorisation system (Sur, Inj) on FinSet .

The key idea is that given an injection $m: \overline{N} \rightarrow N$, we may minimise a Dirichlet form on N over the complement of the image of \overline{N} to obtain, in effect, a Dirichlet form on \overline{N} . Given a circuit $X \rightarrow Y$, we may factor the function $X + Y \rightarrow N$ as $X + Y \xrightarrow{e} \overline{N} \xrightarrow{m} N$, where e is a surjection and m is an injection. Note the image $m(\overline{N})$ of m in N is equal to the boundary ∂N of the circuit. Thus if we map a circuit to its extended power functional, and then minimise the Dirichlet form onto \overline{N} , we obtain the power functional of the circuit.

This motivates the following proposition.

Proposition 6.31. *There is a lax symmetric monoidal functor*

$$\text{Dirich}: (\text{FinSet}; \text{Inj}^{\text{op}}, +) \longrightarrow (\text{Set}, \times),$$

extending the functor $\text{Dirich}: (\text{FinSet}, +) \rightarrow (\text{Set}, \times)$, such that the image of the cospan $N \xrightarrow{f} A \xleftarrow{m} M$, where f is a function and m an injection, is the map

$$\begin{aligned} \text{Dirich}(f; m^{\text{op}}): \text{Dirich}(N) &\longrightarrow \text{Dirich}(M); \\ Q &\longmapsto \min_{A \setminus M} f_* Q. \end{aligned}$$

Note that in writing $A \setminus M$ we are considering M as a subset of A by way of the injection m .

By extending the previous functor Dirich , we mean the triangle

$$\begin{array}{ccc} (\text{FinSet}, +) & \xrightarrow{\text{Dirich}} & (\text{Set}, \times) \\ \downarrow & & \uparrow \\ (\text{FinSet}; \text{Inj}^{\text{op}}, +) & \xrightarrow{\text{Dirich}} & (\text{Set}, \times) \end{array}$$

commutes, where the vertical map is the subcategory inclusion.

There are two aspects of this proposition that require detailed proof: that the map Dirich preserves composition, and that the coherence maps δ are still natural in this larger category. Both facts come down to proving that the minimisation and pushforward commute in certain required circumstances.

This extended functor Dirich then gives rise to a decorated corelations category DirichCorel with morphisms jointly-epic cospans decorated by Dirichlet forms; composition is given by summing the Dirichlet forms on the factors, then minimising over the interior.

This category satisfies the two precise desiderata for a semantic category: each behaviour is uniquely represented, and the map of a circuit to its behaviour preserves all compositional structure. Nonetheless, we will not pursue this construction in depth, feeling that this construction uses corelations to shoehorn in the necessary compositional structure. Instead, we find that a cleaner, more general construction, based on the idea of a linear relation, can be given by a slight generalisation of our decorations.

6.5 Networks as Lagrangian relations

In the first part of this chapter, we explored the semantic content contained in circuit diagrams, leading to an understanding of circuit diagrams as expressing some relationship between the potentials and currents that can simultaneously be imposed on some subset, the so-called terminals, of the nodes of the circuit. We called this collection of possible relationships the behaviour of the circuit. While in that setting we used the concept of Dirichlet forms to describe this relationship, we saw in the end that describing circuits as Dirichlet forms does not allow for a straightforward notion of composition of circuits.

In this section, inspired by the principle of least action of classical mechanics in analogy with the principle of minimum power, we develop a setting for describing behaviours that allows for easy discussion of composite behaviours: Lagrangian subspaces of symplectic vector spaces. These Lagrangian subspaces provide a more direct, invariant perspective, comprising precisely the set of vectors describing the possible simultaneous potential and current readings at all terminals of a given circuit. As we shall see, one immediate and important advantage of this setting is that we may model wires of zero resistance. Moreover, they lie within our Willems-esque aesthetic, choosing to define physical systems via a complete list of possible observations at the terminals.

Recall that we write \mathbb{F} for some field, which for our applications is usually the field \mathbb{R} of real numbers or the field $\mathbb{R}(s)$ of rational functions of one real variable.

6.5.1 Symplectic vector spaces

A circuit made up of wires of positive resistance defines a function from boundary potentials to boundary currents. A wire of zero resistance, however, does not define a function: the principle of minimum power is obeyed as long as the potentials at the two ends of the wire are equal. More generally, we may thus think of circuits as specifying a set of allowed voltage-current pairs, or as a relation between boundary potentials and boundary currents. This set forms what is called a Lagrangian subspace, and is given by the graph of the differential of the power functional. More generally, Lagrangian submanifolds graph derivatives of smooth functions: they describe the point evaluated and the tangent to that point within the same space.

The material in this section is all known, and follows without great difficulty from the definitions. To keep this section brief we omit proofs. See any introduction to

symplectic vector spaces, such as Cimasoni and Turaev [CT05] or Piccione and Tausk [PT08], for details.

Definition 6.32. Given a finite-dimensional vector space V over a field \mathbb{F} , a **symplectic form** $\omega: V \times V \rightarrow \mathbb{F}$ on V is an alternating nondegenerate bilinear form. That is, a symplectic form ω is a function $V \times V \rightarrow \mathbb{F}$ that is

- (i) bilinear: for all $\lambda \in \mathbb{F}$ and all $u, v \in V$ we have $\omega(\lambda u, v) = \omega(u, \lambda v) = \lambda \omega(u, v)$;
- (ii) alternating: for all $v \in V$ we have $\omega(v, v) = 0$; and
- (iii) nondegenerate: given $v \in V$, $\omega(u, v) = 0$ for all $u \in V$ if and only if $u = 0$.

A **symplectic vector space** (V, ω) is a vector space V equipped with a symplectic form ω .

Given symplectic vector spaces $(V_1, \omega_1), (V_2, \omega_2)$, a **symplectic map** is a linear map

$$f: (V_1, \omega_1) \longrightarrow (V_2, \omega_2)$$

such that $\omega_2(f(u), f(v)) = \omega_1(u, v)$ for all $u, v \in V_1$. A **symplectomorphism** is a symplectic map that is also an isomorphism.

An alternating form is always **antisymmetric**, meaning that $\omega(u, v) = -\omega(v, u)$ for all $u, v \in V$. The converse is true except in characteristic 2. A **symplectic basis** for a symplectic vector space (V, ω) is a basis $\{p_1, \dots, p_n, q_1, \dots, q_n\}$ such that $\omega(p_i, p_j) = \omega(q_i, q_j) = 0$ for all $1 \leq i, j \leq n$, and $\omega(p_i, q_j) = \delta_{ij}$ for all $1 \leq i, j \leq n$, where δ_{ij} is the Kronecker delta, equal to 1 when $i = j$, and 0 otherwise. A symplectomorphism maps symplectic bases to symplectic bases, and conversely, any map that takes a symplectic basis to another symplectic basis is a symplectomorphism.

Example 6.33. Given a finite set N , we consider the vector space $\mathbb{F}^N \oplus (\mathbb{F}^N)^*$ a symplectic vector space $(\mathbb{F}^N \oplus (\mathbb{F}^N)^*, \omega)$, with symplectic form

$$\omega((\phi, i), (\phi', i')) = i'(\phi) - i(\phi').$$

Let $\{\phi_n\}_{n \in N}$ be the basis of \mathbb{F}^N consisting of the functions $N \rightarrow \mathbb{F}$ mapping n to 1 and all other elements of N to 0, and let $\{i_n\}_{n \in N} \subseteq (\mathbb{F}^N)^*$ be the dual basis. Then $\{(\phi_n, 0), (0, i_n)\}_{n \in N}$ forms a symplectic basis for $\mathbb{F}^N \oplus (\mathbb{F}^N)^*$.

This is known as the **standard symplectic space**; an important structure theorem states that every finite dimensional symplectic vector space is symplectomorphic—that is, isomorphic as a symplectic vector space—to one of this form.

There are two common ways we will build symplectic spaces from other symplectic spaces: conjugation and summation. Given a symplectic form ω on V , we may define its **conjugate** symplectic form $\bar{\omega} = -\omega$, and write the conjugate symplectic space $(V, \bar{\omega})$ as \bar{V} . Given two symplectic vector spaces (U, ν) , (V, ω) , we consider their direct sum $U \oplus V$ a symplectic vector space with the symplectic form $\nu + \omega$, and call this the **sum** of the two symplectic vector spaces. Note that this is not a product in the category of symplectic vector spaces and symplectic maps.

Example 6.34. A symplectic vector space and its conjugate are symplectomorphic. This is a necessary consequence of the fact that they have the same dimension, and so are both symplectomorphic to the same standard symplectic space.

We also define the conjugate of the standard symplectic space, $\overline{\mathbb{F}^N \oplus (\mathbb{F}^N)^*}$, as the vector space $\mathbb{F}^N \oplus (\mathbb{F}^N)^*$ together with the (unsurprising) symplectic form

$$\omega((\phi, i), (\phi', i')) = i(\phi') - i'(\phi).$$

We write

$$\overline{\text{id}_N}: \mathbb{F}^N \oplus (\mathbb{F}^N)^* \longrightarrow \overline{\mathbb{F}^N \oplus (\mathbb{F}^N)^*}$$

for the symplectomorphism mapping (ϕ, i) to $(\phi, -i)$ relating these two spaces.

The symplectic form provides a notion of orthogonal complement. Given a subspace S of V , we define its **complement**

$$S^\circ = \{v \in V \mid \omega(v, s) = 0 \text{ for all } s \in S\}.$$

Note that this construction obeys the following identities, where S and T are subspaces of V :

$$\begin{aligned} \dim S + \dim S^\circ &= \dim V \\ (S^\circ)^\circ &= S \\ (S + T)^\circ &= S^\circ \cap T^\circ \\ (S \cap T)^\circ &= S^\circ + T^\circ. \end{aligned}$$

In the symplectic vector space $\mathbb{F}^N \oplus (\mathbb{F}^N)^*$, the subspace \mathbb{F}^N has the property of being a maximal subspace such that the symplectic form restricts to the zero form on this subspace. Subspaces with this property are known as Lagrangian subspaces, and they may all be realized as the image of $\mathbb{F}^N \oplus (\mathbb{F}^N)^*$ under symplectomorphisms from $\mathbb{F}^N \oplus (\mathbb{F}^N)^*$ to itself.

Definition 6.35. Let S be a linear subspace of a symplectic vector space (V, ω) . We say that S is **isotropic** if $\omega|_{S \times S} = 0$, and that S is **coisotropic** if S° is isotropic. A subspace is **Lagrangian** if it is both isotropic and coisotropic, or equivalently, if it is a maximal isotropic subspace.

Lagrangian subspaces are also known as Lagrangian correspondences and canonical relations. Note that a subspace S is isotropic if and only if $S \subseteq S^\circ$. This fact helps with the following characterizations of Lagrangian subspaces.

Proposition 6.36. *Given a subspace $L \subset V$ of a symplectic vector space (V, ω) , the following are equivalent:*

- (i) L is Lagrangian.
- (ii) L is maximally isotropic.
- (iii) L is minimally coisotropic.
- (iv) $L = L^\circ$.
- (v) L is isotropic and $\dim L = \frac{1}{2} \dim V$.

From this proposition it follows easily that the direct sum of two Lagrangian subspaces is Lagrangian in the sum of their ambient spaces. We also observe that an advantage of isotropy is that there is a good way to take a quotient of a symplectic vector space by an isotropic subspace—that is, there is a way to put a natural symplectic structure on the quotient space.

Proposition 6.37. *Let S be an isotropic subspace of a symplectic vector space (V, ω) . Then S°/S is a symplectic vector space with symplectic form $\omega'(v+S, u+S) = \omega(v, u)$.*

Proof. The function ω' is well defined due to the isotropy of S —by definition adding any pair (s, s') of elements of S to a pair (v, u) of elements of S° does not change the value of $\omega(v+s, u+s')$. As ω is a symplectic form, one can check that ω' is too. \square

6.5.2 Lagrangian subspaces from quadratic forms

Lagrangian subspaces are of relevance to us here as the behaviour of any passive linear circuit forms a Lagrangian subspace of the symplectic vector space generated by the nodes of the circuit. We think of this vector space as comprising two parts: a space \mathbb{F}^N of potentials at each node, and a dual space $(\mathbb{F}^N)^*$ of currents. To make clear how

circuits can be interpreted as Lagrangian subspaces, here we describe how Dirichlet forms on a finite set N give rise to Lagrangian subspaces of $\mathbb{F}^N \oplus (\mathbb{F}^N)^*$. More generally, we show that there is a one-to-one correspondence between Lagrangian subspaces and quadratic forms.

Proposition 6.38. *Let N be a finite set. Given a quadratic form Q over \mathbb{F} on N , the subspace*

$$L_Q = \{(\phi, dQ_\phi) \mid \phi \in \mathbb{F}^N\} \subseteq \mathbb{F}^N \oplus (\mathbb{F}^N)^*,$$

where $dQ_\phi \in (\mathbb{F}^N)^*$ is the formal differential of Q at $\phi \in \mathbb{F}^N$, is Lagrangian. Moreover, this construction gives a one-to-one correspondence

$$\left\{ \begin{array}{l} \text{Quadratic forms over } \mathbb{F} \text{ on } N \end{array} \right\} \longleftrightarrow \left\{ \begin{array}{l} \text{Lagrangian subspaces of } \mathbb{F}^N \oplus (\mathbb{F}^N)^* \\ \text{with trivial intersection with} \\ \{0\} \oplus (\mathbb{F}^N)^* \subseteq \mathbb{F}^N \oplus (\mathbb{F}^N)^* \end{array} \right\}.$$

Proof. The symplectic structure on $\mathbb{F}^N \oplus (\mathbb{F}^N)^*$ and our notation for it is given in Example 6.33.

Note that for all $n, m \in N$ the corresponding basis elements

$$\frac{\partial^2 Q}{\partial \phi_n \partial \phi_m} = dQ_{\phi_n}(\phi_m) = dQ_{\phi_m}(\phi_n),$$

so $dQ_\phi(\psi) = dQ_\psi(\phi)$ for all $\phi, \psi \in \mathbb{F}^N$. Thus L_Q is indeed Lagrangian: for all $\phi, \psi \in \mathbb{F}^N$

$$\omega((\phi, dQ_\phi), (\psi, dQ_\psi)) = dQ_\psi(\phi) - dQ_\phi(\psi) = 0.$$

Observe also that for all quadratic forms Q we have $dQ_0 = 0$, so the only element of L_Q of the form $(0, i)$, where $i \in (\mathbb{F}^N)^*$, is $(0, 0)$. Thus L_Q has trivial intersection with the subspace $\{0\} \oplus (\mathbb{F}^N)^*$ of $\mathbb{F}^N \oplus (\mathbb{F}^N)^*$. This L_Q construction forms the leftward direction of the above correspondence.

For the rightward direction, suppose that L is a Lagrangian subspace of $\mathbb{F}^N \oplus (\mathbb{F}^N)^*$ such that $L \cap (\{0\} \oplus (\mathbb{F}^N)^*) = \{(0, 0)\}$. Then for each $\phi \in \mathbb{F}^N$, there exists a unique $i_\phi \in (\mathbb{F}^N)^*$ such that $(\phi, i_\phi) \in L$. Indeed, if i_ϕ and i'_ϕ were distinct elements of $(\mathbb{F}^N)^*$ with this property, then by linearity $(0, i_\phi - i'_\phi)$ would be a nonzero element of $L \cap (\{0\} \oplus (\mathbb{F}^N)^*)$, contradicting the hypothesis about trivial intersection. We thus can define a function, indeed a linear map, $\mathbb{F}^N \rightarrow (\mathbb{F}^N)^*; \phi \mapsto i_\phi$. This defines a bilinear form $Q(\phi, \psi) = i_\phi(\psi)$ on $\mathbb{F}^N \oplus \mathbb{F}^N$, and so $Q(\phi) = i_\phi(\phi)$ defines a quadratic form on \mathbb{F}^N .

Moreover, L is Lagrangian, so

$$\omega((\phi, i_\phi), (\psi, i_\psi)) = i_\psi(\phi) - i_\phi(\psi) = 0,$$

and so $Q(-, -)$ is a symmetric bilinear form. This gives a one-to-one correspondence between Lagrangian subspaces of specified type, symmetric bilinear forms, and quadratic forms, and so in particular gives the claimed one-to-one correspondence. \square

In particular, every Dirichlet form defines a Lagrangian subspace.

6.5.3 Lagrangian relations

Recall that a relation between sets X and Y is a subset R of their product $X \times Y$. Furthermore, given relations $R \subseteq X \times Y$ and $S \subseteq Y \times Z$, there is a composite relation $(S \circ R) \subseteq X \times Z$ given by pairs (x, z) such that there exists $y \in Y$ with $(x, y) \in R$ and $(y, z) \in S$ —a direct generalization of function composition. A Lagrangian relation between symplectic vector spaces V_1 and V_2 is a relation between V_1 and V_2 that forms a Lagrangian subspace of the symplectic vector space $\overline{V_1} \oplus V_2$. This gives us a way to think of certain Lagrangian subspaces, such as those arising from circuits, as morphisms, giving a way to compose them.

Definition 6.39. A **Lagrangian relation** $L: V_1 \rightarrow V_2$ is a Lagrangian subspace L of $\overline{V_1} \oplus V_2$.

This is a generalization of the notion of symplectomorphism: any symplectomorphism $f: V_1 \rightarrow V_2$ forms a Lagrangian subspace when viewed as a relation $f \subseteq \overline{V_1} \oplus V_2$. More generally, any symplectic map $f: V_1 \rightarrow V_2$ forms an isotropic subspace when viewed as a relation in $\overline{V_1} \oplus V_2$.

Importantly for us, the composite of two Lagrangian relations is again a Lagrangian relation. This is well known [Wei81], but sufficiently easy and important to us that we provide a proof.

Proposition 6.40. *Let $L: V_1 \rightarrow V_2$ and $L': V_2 \rightarrow V_3$ be Lagrangian relations. Then their composite relation $L' \circ L$ is a Lagrangian relation $V_1 \rightarrow V_3$.*

We prove this proposition by way of two lemmas detailing how the Lagrangian property is preserved under various operations. The first lemma says that the intersection of a Lagrangian space with a coisotropic space is in some sense Lagrangian, once we account for the complement.

Lemma 6.41. *Let $L \subseteq V$ be a Lagrangian subspace of a symplectic vector space V , and $S \subseteq V$ be an isotropic subspace of V . Then $(L \cap S^\circ) + S \subseteq V$ is Lagrangian in V .*

Proof. Recall from Proposition 6.36 that a subspace is Lagrangian if and only if it is equal to its complement. The lemma is then immediate from the way taking the symplectic complement interacts with sums and intersections:

$$\begin{aligned} ((L \cap S^\circ) + S)^\circ &= (L \cap S^\circ)^\circ \cap S^\circ = (L^\circ + (S^\circ)^\circ) \cap S^\circ \\ &= (L + S) \cap S^\circ = (L \cap S^\circ) + (S \cap S^\circ) = (L \cap S^\circ) + S. \end{aligned}$$

Since $(L \cap S^\circ) + S$ is equal to its complement, it is Lagrangian. \square

The second lemma says that if a subspace of a coisotropic space is Lagrangian, taking quotients by the complementary isotropic space does not affect this.

Lemma 6.42. *Let $L \subseteq V$ be a Lagrangian subspace of a symplectic vector space V , and $S \subseteq L$ an isotropic subspace of V contained in L . Then $L/S \subseteq S^\circ/S$ is Lagrangian in the quotient symplectic space S°/S .*

Proof. As L is isotropic and the symplectic form on S°/S is given by $\omega'(v+S, u+S) = \omega(v, u)$, the quotient L/S is immediately isotropic. Recall from Proposition 6.36 that an isotropic subspace S of a symplectic vector space V is Lagrangian if and only if $\dim S = \frac{1}{2} \dim V$. Also recall that for any subspace $\dim S + \dim S^\circ = \dim V$. Thus

$$\begin{aligned} \dim(L/S) &= \dim L - \dim S = \frac{1}{2} \dim V - \dim S \\ &= \frac{1}{2}(\dim S + \dim S^\circ) - \dim S = \frac{1}{2}(\dim S^\circ - \dim S) = \frac{1}{2} \dim(S^\circ/S). \end{aligned}$$

Thus L/S is Lagrangian in S°/S . \square

Combining these two lemmas gives a proof that the composite of two Lagrangian relations is again a Lagrangian relation.

Proof of Proposition 6.40. Let Δ be the diagonal subspace

$$\Delta = \{(0, v_2, v_2, 0) \mid v_2 \in V_2\} \subseteq \overline{V}_1 \oplus V_2 \oplus \overline{V}_2 \oplus V_3.$$

Observe that Δ is isotropic, and has coisotropic complement

$$\Delta^\circ = \{(v_1, v_2, v_2, v_3) \mid v_i \in V_i\} \subseteq \overline{V}_1 \oplus V_2 \oplus \overline{V}_2 \oplus V_3.$$

As Δ is the kernel of the restriction of the projection map $\overline{V}_1 \oplus V_2 \oplus \overline{V}_2 \oplus V_3 \rightarrow \overline{V}_1 \oplus V_3$ to Δ° , and after restriction this map is still surjective, the quotient space Δ°/Δ is isomorphic to $\overline{V}_1 \oplus V_3$.

Now, by definition of composition of relations,

$$L' \circ L = \{(v_1, v_3) \mid \text{there exists } v_2 \in V_2 \text{ such that } (v_1, v_2) \in L, (v_2, v_3) \in L'\}.$$

But note also that

$$L \oplus L' = \{(v_1, v_2, v'_2, v_3) \mid (v_1, v_2) \in L, (v'_2, v_3) \in L'\},$$

so

$$(L \oplus L') \cap \Delta^\circ = \{(v_1, v_2, v_2, v_3) \mid \text{there exists } v_2 \in V_2 \text{ such that } (v_1, v_2) \in L, (v_2, v_3) \in L'\}.$$

Quotienting by Δ then gives

$$L' \circ L = ((L \oplus L') \cap \Delta^\circ + \Delta) / \Delta.$$

As $L' \oplus L$ is Lagrangian in $\overline{V}_1 \oplus V_2 \oplus \overline{V}_2 \oplus V_3$, Lemma 6.41 says that $(L' \oplus L) \cap \Delta^\circ + \Delta$ is also Lagrangian in $\overline{V}_1 \oplus V_2 \oplus \overline{V}_2 \oplus V_3$. Lemma 6.42 thus shows that $L' \circ L$ is Lagrangian in $\Delta^\circ/\Delta = \overline{V}_1 \oplus V_3$, as required. \square

Note that this composition is associative. We shall prove this composition agrees with composition of Dirichlet forms, and hence also composition of circuits.

6.5.4 The symmetric monoidal category of Lagrangian relations

Lagrangian relations solve the identity problems we had with Dirichlet forms: given a symplectic vector space V , the Lagrangian relation $\text{id}: V \rightarrow V$ specified by the Lagrangian subspace

$$\text{id} = \{(v, v) \mid v \in V\} \subseteq \overline{V} \oplus V,$$

acts as an identity for composition of relations. We thus have a category. As our circuits have finitely many nodes, we choose only the finite dimensional symplectic vector spaces as objects.

Definition 6.43. We write LagrRel for the category with finite dimensional symplectic vector spaces as objects and Lagrangian relations as morphisms.

We define the tensor product of two objects of LagrRel to be their direct sum. Similarly, we define the tensor product of two morphisms $L: U \rightarrow V$, $L \subseteq \overline{U} \oplus V$ and $K: T \rightarrow W$, $K \subseteq \overline{T} \oplus W$ to be their direct sum

$$L \oplus K \subseteq \overline{U} \oplus V \oplus \overline{T} \oplus W,$$

but considered as a subspace of the naturally isomorphic space $\overline{U \oplus T} \oplus V \oplus W$. Despite this subtlety, we abuse our notation and write their tensor product $L \oplus K: U \oplus T \rightarrow V \oplus W$, and move on having sounded this note of caution.

Note that the direct sum of two Lagrangian subspaces is again Lagrangian in the direct sum of their ambient spaces, and the zero dimensional vector space $\{0\}$ acts as an identity for direct sum. Indeed, defining for all objects U, V, W in LagrRel unitors:

$$\begin{aligned} \lambda_V &= \{(0, v, v)\} \subseteq \overline{\{0\} \oplus V} \oplus V, \\ \rho_V &= \{(v, 0, v)\} \subseteq \overline{V \oplus \{0\}} \oplus V, \end{aligned}$$

associators:

$$\alpha_{U,V,W} = \{(u, v, w, u, v, w)\} \subseteq \overline{(U \oplus V) \oplus W} \oplus U \oplus (V \oplus W),$$

and braidings:

$$\sigma_{U,V} = \{(u, v, v, u) \mid u \in U, v \in V\} \subseteq \overline{U \oplus V} \oplus V \oplus U,$$

we have a symmetric monoidal category. Note that all these structure maps come from symplectomorphisms between the domain and codomain. From this viewpoint it is immediate that all the necessary diagrams commute, so we have a symmetric monoidal category.

In fact the move to the setting of Lagrangian relations, rather than Dirichlet forms, adds far richer structure than just identity morphisms. In the next section we endow LagrRel with a hypergraph structure.

6.6 Ideal wires and corelations

We want to give a decorated corelations construction of LagrRel for two main reasons: first, it endows LagrRel with a hypergraph structure, and second, it allows us to use decorated corelations to construct functors to it.

The key takeaway of this section is that examining the graphical elements that facilitate composition—here ideal wires—shows us how to define hypergraph structure

and hence obtain a decorated correlations construction. More broadly, to turn a semantic function into a semantic *functor*, it's enough to look at the Frobenius maps.

In this section we shall see that these ideal wires are modelled by epi-mono corelations in FinSet , a generalization of the notion of function that forgets the directionality from the domain to the codomain. We then observe that Kirchhoff's laws follow directly from interpreting these structures in the category of linear relations.

A more powerful route to the same conclusion might be to directly define a hypergraph structure on LagrRel and then use Theorem 4.13 to obtain a decorated correlations construction; we nonetheless favour the following as it sheds insight into remarkable links between the corelations and ideal wires, the contravariant 'free' vector space functor and Kirchhoff's voltage law, and the covariant free vector space functor and Kirchhoff's current law.

6.6.1 Ideal wires as corelations

The term corelation in this section exclusively refers to epi-mono corelations in FinSet . As such, we write this hypergraph category Corel .

To motivate the use of this category, let us start with a set of input terminals X , and a set of output terminals Y . We may connect these terminals with ideal wires of zero impedance, whichever way we like—input to input, output to output, input to output—producing something like:

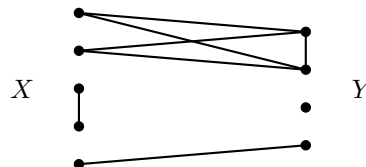

In doing so, we introduce a notion of equivalence on our terminals, where two terminals are equivalent if we, or if electrons, can traverse from one to another via some sequence of wires. Because of this, we consider our perfectly-conducting components to be equivalence relations on $X + Y$, transforming the above picture into

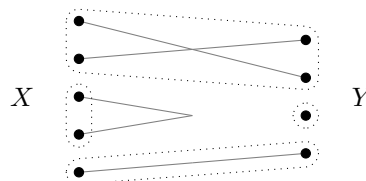

The dotted lines indicate equivalence classes of points, while for reference the grey lines indicate ideal wires connecting these points, running through a central hub.

Given another circuit of this sort, say from sets Y to Z ,

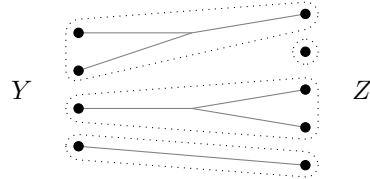

we may combine these circuits in to a circuit X to Z

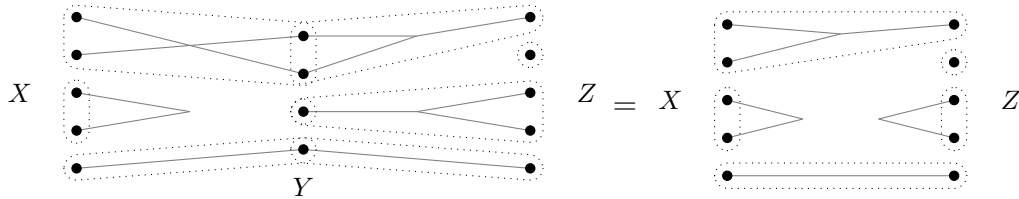

by taking the transitive closure of the two equivalence relations, and then restricting this to an equivalence relation on $X + Z$.

In the category of sets we hold the fundamental relationship between sets to be that of functions. These encode the idea of a deterministic process that takes each element of one set to a unique element of the other. For the study of networks this is less appropriate, as the relationship between terminals is not an input-output one, but rather one of interconnection. Willems has repeatedly emphasised the prevalence of input-output thinking as a limitation of current techniques in control theory [Wil07, Wil89].

In particular, the direction of a function becomes irrelevant, and to describe these interconnections via the category of sets we must develop an understanding of how to compose functions head to head and tail to tail. We have so far used cospans and pushouts to address this. Cospans, however, come with an apex, which represents extraneous structure beyond the two sets we wish to specify a relationship between. Corelations, in line with our ‘black boxing’ intuition for them, arise from omitting this information.

6.6.2 Potentials on corelations

Chasing our interpretation of corelations as ideal wires, our aim now is to build a functor

$$S: \text{Corel} \longrightarrow \text{LagrRel}$$

that expresses this interpretation. We break this functor down into the sum of two parts, according to the behaviours of potentials and currents respectively.

The consideration of potentials gives a functor $\Phi: \text{Corel} \rightarrow \text{LinRel}$, where LinRel is the symmetric monoidal dagger category of finite-dimensional \mathbb{F} -vector spaces, linear relations, direct sum, and transpose. In particular, this functor expresses Kirchhoff's voltage law: it requires that if two elements are in the same part of the corelation partition—that is, if two nodes are connected by ideal wires—then the potential at those two points must be the same.

To construct this functor, we recall Subsection 3.4.2, where we observed that LinRel is the category of jointly-epic corelations in $\text{FinVect}^{\text{op}}$, and then appeal to our results on functors between corelation categories.

Proposition 6.44. *Define the functor*

$$\Phi: \text{Corel} \longrightarrow \text{LinRel},$$

on objects by sending a finite set X to the vector space \mathbb{F}^X , and on morphisms by sending a corelation $e: X \rightarrow Y$ to the linear subspace $\Phi(e)$ of $\mathbb{F}^X \oplus \mathbb{F}^Y$ comprising functions $\phi: X + Y \rightarrow \mathbb{F}$ that are constant on each element of the equivalence class induced by e . This is a strong symmetric monoidal functor, with coherence maps the usual natural isomorphisms $\mathbb{F}^X \oplus \mathbb{F}^Y \cong \mathbb{F}^{X+Y}$ and $\{0\} \cong \mathbb{F}^\emptyset$.

Proof. This functor Φ extends the contravariant functor $\text{FinSet} \rightarrow \text{FinVect}$ that maps a set to the vector space of \mathbb{F} -valued functions on that set. Indeed, define the contravariant functor $\Psi: \text{FinSet} \rightarrow \text{FinVect}$ mapping a finite set X to the vector space \mathbb{F}^X , and the function $f: X \rightarrow Y$ to the linear map $f_*: \mathbb{F}^Y \rightarrow \mathbb{F}^X$ sending $\phi: Y \rightarrow \mathbb{F}$ to $\phi \circ f: X \rightarrow \mathbb{F}$.

The functor Ψ maps finite colimits to finite limits. To show this, we need only check it maps coproducts to products and coequalisers to equalisers. The former follows from the same well-known natural isomorphisms as the coherence maps: $\mathbb{F}^X \oplus \mathbb{F}^Y \cong \mathbb{F}^{X+Y}$. To see the latter, write $C = Y/(f(x) \sim g(x))$ for the coequaliser of the diagram

$$X \begin{array}{c} \xrightarrow{f} \\ \xrightarrow{g} \end{array} Y.$$

This is the quotient of the set Y by the equivalence relation induced by $f(x) \sim g(x)$ for all $x \in X$; write $c: Y \rightarrow C$ for the quotient map. Now the equaliser of the image of this diagram under Ψ ,

$$F^Y \begin{array}{c} \xrightarrow{f_*} \\ \xrightarrow{g_*} \end{array} F^X.$$

is the kernel of $f_* - g_*$. This kernel comprises those $v \in \mathbb{F}^Y$ such that $v(f(x)) = v(g(x))$ for all $x \in X$. But this is precisely the image of $c_*: \mathbb{F}^C \rightarrow \mathbb{F}^Y$. Thus Ψ sends coequalisers to equalisers, and hence finite colimits to finite limits.

Note also that the image of an injective function in FinSet is a surjective linear transformation $\mathbb{F}^Y \rightarrow \mathbb{F}^X$, and hence a monomorphism in $\text{FinVect}^{\text{op}}$. Thus, considering Ψ as a covariant functor $\text{FinSet} \rightarrow \text{FinVect}^{\text{op}}$, we have a functor that preserves finite colimits and such that the image of the monomorphisms of FinSet is contained in the monomorphisms of $\text{FinVect}^{\text{op}}$.

Recall that FinVect has an epi-mono factorisation system, and that LinRel is the category of relations with respect to it; equivalently, this means that $\text{FinVect}^{\text{op}}$ has an epi-mono factorisation system, and LinRel is the its category of corelations (Subsection 3.4.2). Thus Ψ extends to a functor

$$\Phi: \text{Corel}(\text{FinSet}) = \text{Corel} \longrightarrow \text{Corel}(\text{FinVect}^{\text{op}}) \cong \text{LinRel}.$$

This functor Φ maps a corelation $e = [i, o]: X + Y \rightarrow N$ to the linear relation $e_*(\mathbb{F}^N) \subset \mathbb{F}^X \oplus \mathbb{F}^Y$ comprising functions $X + Y \rightarrow \mathbb{F}$ that are constant on each equivalence class of elements of $X + Y$. \square

To recap, we have now constructed a functor $\Phi: \text{Corel} \rightarrow \text{LinRel}$ expressing the behaviour of potentials on corelations interpreted as ideal wires. Next, we do the same for currents.

6.6.3 Currents on corelations

In this subsection we consider the case of currents, described by a functor $I: \text{Corel} \rightarrow \text{LinRel}$. This functor expresses Kirchhoff's current law: it requires that the sum of currents flowing into each part of the corelation partition must equal to the sum of currents flowing out.

Proposition 6.45. *Define the functor*

$$I: \text{Corel} \longrightarrow \text{LinRel}.$$

as follows. On objects send a finite set X to the vector space $(\mathbb{F}^X)^ = \mathbb{F}[X]$, the free vector space on X . On morphisms send a corelation $e = [i, o]: X + Y \rightarrow N$ to the linear relation $I(e)$ comprising precisely those*

$$(i_X, i_Y) = \left(\sum_{x \in X} \lambda_x dx, \sum_{y \in Y} \lambda_y dy \right) \in (\mathbb{F}^X)^* \oplus (\mathbb{F}^Y)^*$$

such that for all $n \in N$ the sum of the coefficients of the elements of $i^{-1}(n) \subseteq X$ is equal to that for $o^{-1}(n) \subseteq Y$:

$$\sum_{i(x)=n} \lambda_x = \sum_{o(y)=n} \lambda_y.$$

This is a strong symmetric monoidal functor, with coherence maps the natural isomorphisms $(\mathbb{F}^X)^* \oplus (\mathbb{F}^Y)^* \rightarrow (\mathbb{F}^{X+Y})^*$ and $\{0\} \rightarrow (\mathbb{F}^\emptyset)^*$.

Proof. The functor I is a generalization of the covariant functor $\text{FinSet} \rightarrow \text{FinVect}$ that maps a set to the vector space of \mathbb{F} -linear combinations of elements of that set. We proceed in a similar fashion to the functor for potentials. Define the functor $J: \text{FinSet} \rightarrow \text{FinVect}$ mapping a finite set X to the vector space $(\mathbb{F}^X)^*$, the sum of formal linear combinations of the symbols dx , where x is an element of X . Given a function $f: X \rightarrow Y$, J maps f to the linear map $f^*: (\mathbb{F}^X)^* \rightarrow (\mathbb{F}^Y)^*$ taking $\sum_{x \in X} \lambda_x dx \in (\mathbb{F}^X)^*$ to $\sum_{x \in X} \lambda_x d(fx)$.

This is the restriction to FinSet of the free vector space functor $\text{Set} \rightarrow \text{Vect}$. As the free vector space functor is left adjoint to the forgetful functor, it preserves finite colimits. Hence FinSet also preserves finite colimits. Moreover, J maps monomorphisms in FinSet to monomorphisms in FinVect . By Proposition 3.14, J thus extends to a functor

$$I: \text{Corel}(\text{FinSet}) = \text{Corel} \longrightarrow \text{Corel}(\text{FinVect}) = \text{LinRel}.$$

This functor maps a corelation $e = [i, o]: X + Y \rightarrow N$ to the kernel $\ker(Ie)$ of the linear map $Ie: (\mathbb{F}^X)^* \oplus (\mathbb{F}^Y)^* \rightarrow (\mathbb{F}^N)^*$. This comprises all linear combinations $\left(\sum_{x \in X} \lambda_x dx, \sum_{y \in Y} \lambda_y dy \right)$ such that $\sum_{x \in X} \lambda_x d(ix) = \sum_{y \in Y} \lambda_y d(oy)$. This is what we wanted to show. \square

6.6.4 The symplectification functor

We have now defined functors that, when interpreting corelations as connections of ideal wires, describe the behaviours of the currents and potentials at the terminals of these wires. In this section, we combine these to define a single functor $S: \text{Corel} \rightarrow \text{LagrRel}$ describing the behaviour of both currents and potentials as a Lagrangian subspace.

Proposition 6.46. *We define the symplectification functor*

$$S: \text{Corel} \longrightarrow \text{LagrRel}$$

sending a finite set X to the symplectic vector space

$$SX = \mathbb{F}^X \oplus (\mathbb{F}^X)^*,$$

and a corelation $e = [i, o]: X + Y \rightarrow N$ to the Lagrangian relation

$$Se = \Phi e \oplus Ie \subseteq \overline{\mathbb{F}^X \oplus (\mathbb{F}^X)^*} \oplus \mathbb{F}^Y \oplus (\mathbb{F}^Y)^*.$$

Then S is a strong symmetric monoidal functor, with coherence maps those of Φ and I .

Note that $\Phi e \oplus Ie$ is more properly a subspace of the vector space $\mathbb{F}^X \oplus \mathbb{F}^Y \oplus (\mathbb{F}^X)^* \oplus (\mathbb{F}^Y)^*$. In the above we consider it instead as a subspace of the symplectic vector space $\overline{\mathbb{F}^X \oplus (\mathbb{F}^X)^*} \oplus \mathbb{F}^Y \oplus (\mathbb{F}^Y)^*$, whose underlying vector space is canonically isomorphic to $\mathbb{F}^X \oplus \mathbb{F}^Y \oplus (\mathbb{F}^X)^* \oplus (\mathbb{F}^Y)^*$.

Proof. As S is the monoidal product in LinRel of the strong symmetric monoidal functors $\Phi, I: \text{Corel} \rightarrow \text{LinRel}$, it is itself a strong symmetric monoidal functor $\text{Corel} \rightarrow \text{LinRel}$. Thus it only remains to be checked that, with respect to the symplectic structure we put on the objects SX , the image of each corelation e is Lagrangian.

This follows from condition (v) of Proposition 6.36: that a Lagrangian subspace is an isotropic subspace of dimension half that of the symplectic vector space.

Given $(\phi_X, i_X, \phi_Y, i_Y) \in Se$, note that for each $n \in N$ there exists a constant $\phi_n \in \mathbb{F}$ such that $\phi_n = \phi_X(x) = \phi_Y(y)$ for all $x \in X$ such that $i(x) = n$ and all $y \in Y$ such that $o(y) = n$. Then Se is isotropic as, for all $(\phi_X, i_X, \phi_Y, i_Y)$,

$(\phi'_X, i'_X, \phi'_Y, i'_Y) \in Se$ we have

$$\begin{aligned}
& \omega((\phi_X, i_X, \phi_Y, i_Y), (\phi'_X, i'_X, \phi'_Y, i'_Y)) \\
&= \overline{\omega_X}((\phi_X, i_X), (\phi'_X, i'_X)) + \omega_Y((\phi_Y, i_Y), (\phi'_Y, i'_Y)) \\
&= -(i'_X(\phi_X) - i_X(\phi'_X)) + i'_Y(\phi_Y) - i_Y(\phi'_Y) \\
&= i_X(\phi'_X) - i_Y(\phi'_Y) + i'_X(\phi_X) - i'_Y(\phi_Y) \\
&= \sum_{x \in X} \lambda_x dx(\phi'_X) - \sum_{y \in Y} \lambda_y dy(\phi'_Y) + \sum_{y \in Y} \lambda'_y dy(\phi_Y) - \sum_{x \in X} \lambda'_x dx(\phi_X) \\
&= \sum_{n \in N} \left(\sum_{i(x)=n} \lambda_x dx(\phi'_X) - \sum_{o(y)=n} \lambda_y dy(\phi'_Y) \right) \\
&\quad + \sum_{n \in N} \left(\sum_{i(x)=n} \lambda'_x dx(\phi_X) - \sum_{o(y)=n} \lambda'_y dy(\phi_Y) \right) \\
&= \sum_{n \in N} \left(\sum_{i(x)=n} \lambda_x - \sum_{o(y)=n} \lambda_y \right) \phi'_n + \sum_{n \in N} \left(\sum_{i(x)=n} \lambda'_x - \sum_{o(y)=n} \lambda'_y \right) \phi_n \\
&= 0.
\end{aligned}$$

Second, Se has dimension equal to

$$\begin{aligned}
\dim(\Phi e) + \dim(Ie) &= \#N + \#(X + Y) - \#N \\
&= \#(X + Y) = \frac{1}{2} \dim(\overline{\mathbb{F}^X \oplus (\mathbb{F}^X)^*} \oplus \mathbb{F}^Y \oplus (\mathbb{F}^Y)^*).
\end{aligned}$$

This proves the proposition. \square

We have thus shown that we do indeed have a functor $S: \text{Corel} \rightarrow \text{LagrRel}$. In the next section we shall see that this functor provides the engine of our black box functor. To get there, an understanding of the action of S on functions will be helpful.

Example 6.47 (Symplectification of functions). Let $f: X \rightarrow Y$ be a function; we may also consider it as the corelation $X \xrightarrow{f} Y \xleftarrow{\text{id}_Y} Y$. In this example we show that Sf has the form

$$Sf = \{(\phi_X, i_X, \phi_Y, i_Y) \mid \phi_X = f^* \phi_Y, i_Y = f_* i_X\} \subseteq \overline{\mathbb{F}^X \oplus (\mathbb{F}^X)^*} \oplus \mathbb{F}^Y \oplus (\mathbb{F}^Y)^*,$$

where f^* is the pullback map

$$\begin{aligned}
f^*: \mathbb{F}^Y &\longrightarrow \mathbb{F}^X; \\
\phi &\longmapsto \phi \circ f,
\end{aligned}$$

and f_* is the pushforward map

$$\begin{aligned} f_*: (\mathbb{F}^X)^* &\longrightarrow (\mathbb{F}^Y)^*; \\ i(-) &\longmapsto i(- \circ f). \end{aligned}$$

The claim is then that these pullback and pushforward constructions express Kirchhoff's laws.

Recall that the corelation corresponding to f partitions $X + Y$ into $\#Y$ parts, each of the form $f^{-1}(y) \cup \{y\}$. The linear relation $\Phi(f)$ requires that if $x \in X$ and $y \in Y$ lie in the same part of the partition, then they have the same potential: that is, $\phi_X(x) = \phi_Y(y)$. This is precisely the arrangement imposed by $f^*\phi_Y = \phi_X$:

$$\phi_X(x) = \phi_Y(f(x)) = \phi_Y(y).$$

On the other hand, the linear relation $I(f)$ requires that if $i_X = \sum_{x \in X} \lambda_x dx$, $i_Y = \sum_{y \in Y} \lambda_y dy$, then for each $y \in Y$ we have

$$\sum_{x \in f^{-1}(y)} \lambda_x = \lambda_y.$$

This is precisely what is required by f_* : given any $\phi \in \mathbb{F}^Y$, we have

$$f_*i_X(\phi) = f_* \sum_{x \in X} \lambda_x dx(\phi) = \sum_{x \in X} \lambda_x dx(\phi \circ f) = \sum_{y \in Y} \left(\sum_{x \in f^{-1}(y)} \lambda_x \right) dy.$$

This gives us the above representation of Sf when f is a function.

6.6.5 Lagrangian relations as decorated corelations

Recall that symplectic vector spaces of the form $\mathbb{F}^X \oplus (\mathbb{F}^X)^*$ are known as standard symplectic spaces. Here we shall use decorated corelations to construct a hypergraph category LagrCorel in which the objects are standard symplectic spaces and the morphisms are in one-to-one correspondence with Lagrangian relations between them. As every finite dimensional symplectic vector space is symplectomorphic to a standard symplectic space, LagrCorel is equivalent as a symmetric monoidal category to LagrRel . This equivalence allows us to endow LagrRel with a hypergraph structure so that the two categories are hypergraph equivalent.

Analogous with our constructions in §2.4 and §4.4, we will use the composite of the hom functor $\text{LagrRel}(\emptyset, -): \text{LagrRel} \rightarrow \text{Set}$, the symplectification functor $S: \text{Corel} \rightarrow \text{LagrRel}$, and the functor $\text{Cospan}(\text{FinSet}) \rightarrow \text{Corel}$.

Proposition 6.48. *Define*

$$\text{Lagr}: (\text{Cospan}(\text{FinSet}), +) \longrightarrow (\text{Set}, \times)$$

as follows. For objects let Lagr map a finite set X to the set $\text{Lagr}(X)$ of Lagrangian subspaces of the symplectic vector space $\mathbb{F}^X \oplus (\mathbb{F}^X)^*$. For morphisms, given a cospan of finite sets $X \rightarrow Y$ we take its jointly-epic part e , and thus obtain a map $Se: \mathbb{F}^X \oplus (\mathbb{F}^X)^* \rightarrow \mathbb{F}^Y \oplus (\mathbb{F}^Y)^*$. As Lagrangian relations map Lagrangian subspaces to Lagrangian subspaces (Proposition 6.40), this gives a map:

$$\begin{aligned} \text{Lagr}(f): \text{Lagr}(X) &\longrightarrow \text{Lagr}(Y); \\ L &\longmapsto Se(L). \end{aligned}$$

Moreover, equipping this functor with the family of maps

$$\begin{aligned} \lambda_{N,M}: \text{Lagr}(N) \times \text{Lagr}(M) &\longrightarrow \text{Lagr}(N + M); \\ (L_N, L_M) &\longmapsto L_N \oplus L_M, \end{aligned}$$

and unit

$$\begin{aligned} \lambda_1: 1 &\longrightarrow \text{Lagr}(\emptyset); \\ \bullet &\longmapsto \{0\} \end{aligned}$$

defines a lax symmetric monoidal functor.

Proof. The functoriality of this construction follows from the functoriality of S ; the lax symmetric monoidality from the relevant properties of the direct sum of vector spaces. \square

This functor gives us two categories. First, we can construct a decorated cospans category LagrCospan on the functor Lagr restricted to FinSet , giving a category with each morphism a cospan of finite sets $X \rightarrow N \leftarrow Y$ decorated by a Lagrangian subspace of $\mathbb{F}^N \oplus (\mathbb{F}^N)^*$. This will be useful for interpreting extended power functionals as Lagrangian subspaces in a compositional setting.

The second category is LagrCorel . This as usual has finite sets as objects. For morphisms $X \rightarrow Y$ it has Lagrangian subspaces of

$$\mathbb{F}^{X+Y} \oplus (\mathbb{F}^{X+Y})^* \cong \mathbb{F}^X \oplus (\mathbb{F}^X)^* \oplus \mathbb{F}^Y \oplus (\mathbb{F}^Y)^*$$

not, as might be expected, Lagrangian subspaces of $\overline{\mathbb{F}^X \oplus (\mathbb{F}^X)^*} \oplus \mathbb{F}^Y \oplus (\mathbb{F}^Y)^*$. The reason is that composition is also a slightly tweaked from relational composition.

Composition in LagrCorel is enacted by the symplectification of the cospan

$$X + Y + Y + Z \xrightarrow{\text{id}_X + [\text{id}_Y, \text{id}_Y] + \text{id}_Z} X + Y + Z \xleftarrow{\iota_X + \iota_Z} X + Z.$$

This relation relates

$$(\phi_X, \phi_Y, \phi'_Y, \phi'_Z, i_X, i_Y, i'_Y, i'_Z) \in \mathbb{F}^{X+Y+Y+Z} \oplus (\mathbb{F}^{X+Y+Y+Z})^*$$

with

$$(\phi_X, \phi'_Z, i_X, i'_Z) \in \mathbb{F}^{X+Z} \oplus (\mathbb{F}^{X+Z})^*$$

if and only if two conditions hold: (i) $\phi_Y = \phi'_Y$ and (ii) $i_Y + i'_Y = 0$. Thus on the ‘potentials’ ϕ we have relational composition, but on the ‘currents’ we instead require $i_Y = -i'_Y$. We interpret this to mean that the decorations of LagrCorel record only the currents *out* of the nodes of the circuit. Thus if we were to interconnect two nodes, the current out of the first must be equal to the negative of the current out—that is, the current *in*—of the second node. It is remarkable that this physical fact is embedded so deeply in the underlying mathematics.

As these categories are constructed using decorated corelations, we have for free a hypergraph functor

$$\text{LagrCospan} \longrightarrow \text{LagrCorel}.$$

The above discussion shows that we also have an embedding

$$\text{LagrCorel} \hookrightarrow \text{LagrRel}$$

mapping a finite set X to the standard symplectic space $\mathbb{F}^X \oplus (\mathbb{F}^X)^*$, and a morphism $L \subset \mathbb{F}^X \oplus (\mathbb{F}^X)^* \oplus \mathbb{F}^Y \oplus (\mathbb{F}^Y)^*$ to its image under the symplectomorphism

$$\overline{\text{id}_X} \oplus \text{id}_Y: \mathbb{F}^X \oplus (\mathbb{F}^X)^* \oplus \mathbb{F}^Y \oplus (\mathbb{F}^Y)^* \xrightarrow{\cong} \overline{\mathbb{F}^X \oplus (\mathbb{F}^X)^*} \oplus \mathbb{F}^Y \oplus (\mathbb{F}^Y)^*.$$

This is a fully faithful and essentially surjective strong symmetric monoidal functor. Recall that LagrCorel is a hypergraph category; indeed, the hypergraph structure is given by ‘ideal wires’, as we have spent this chapter exploring. Choosing an isomorphism of each symplectic vector space with a standard symplectic vector space, we may equip each object of LagrRel with special commutative Frobenius structure, and hence consider the above embedding an equivalence of hypergraph categories.

6.7 The black box functor

We have now developed enough machinery to prove Theorem 6.1: there is a hypergraph functor, the black box functor

$$\blacksquare: \text{Circ} \rightarrow \text{LagrRel}$$

taking passive linear circuits to their behaviours. To recap, we have so far developed two categories: Circ , in which morphisms are passive linear circuits, and LagrRel , which captures the external behaviour of such circuits. We now define a functor that maps each circuit to its behaviour, before proving it is indeed a hypergraph functor.

The role of the functor we construct here is to identify all circuits with the same external behaviour, making the internal structure of the circuit inaccessible. Circuits treated this way are frequently referred to as ‘black boxes’, so we call this functor the **black box functor**,

$$\blacksquare: \text{Circ} \rightarrow \text{LagrRel}.$$

In this section we first provide the definition of this functor, check that our definition really does map a circuit to its behaviour, and then finally use decorated corelations to verify its functoriality.

6.7.1 Definition

It should be no surprise that the black box functor maps a finite set X to the symplectic vector space $\mathbb{F}^X \oplus (\mathbb{F}^X)^*$ of potentials and currents that may be placed on that set. The challenge is to provide a succinct statement of its action on the circuits themselves. To do this we take advantage of three processes defined above.

Let $\Gamma: X \rightarrow Y$ be a circuit, that is a cospan of finite sets $X \xrightarrow{i} N \xleftarrow{o} Y$ decorated by an \mathbb{F}^+ -graph (N, E, s, t, r) . To define the image of Γ under our functor \blacksquare , by definition a Lagrangian relation $\blacksquare(\Gamma): \blacksquare(X) \rightarrow \blacksquare(Y)$, we must specify a Lagrangian subspace $\blacksquare(\Gamma) \subseteq \overline{\mathbb{F}^X \oplus (\mathbb{F}^X)^*} \oplus \mathbb{F}^Y \oplus (\mathbb{F}^Y)^*$.

Recall that to each \mathbb{F}^+ -graph Γ we can associate a Dirichlet form, the extended power functional

$$P_\Gamma: \mathbb{F}^N \longrightarrow \mathbb{F};$$

$$\phi \longmapsto \frac{1}{2} \sum_{e \in E} \frac{1}{r(e)} (\phi(t(e)) - \phi(s(e)))^2,$$

and to this Dirichlet form we associate a Lagrangian subspace, thought of as a Lagrangian relation:

$$\text{Graph}(dP_\Gamma) = \{(\phi, d(P_\Gamma)_\phi) \mid \phi \in \mathbb{F}^N\} : \{0\} \rightarrow \mathbb{F}^N \oplus (\mathbb{F}^N)^*.$$

Next, from the legs of the cospan Γ , the symplectification functor S gives the Lagrangian relation

$$S[i, o]^{\text{op}} : \mathbb{F}^N \oplus (\mathbb{F}^N)^* \longrightarrow \mathbb{F}^X \oplus (\mathbb{F}^X)^* \oplus \mathbb{F}^Y \oplus (\mathbb{F}^Y)^*.$$

Lastly, we have the symplectomorphism

$$\begin{aligned} \overline{\text{id}_X} : \mathbb{F}^X \oplus (\mathbb{F}^X)^* &\longrightarrow \overline{\mathbb{F}^X \oplus (\mathbb{F}^X)^*}; \\ (\phi, i) &\longmapsto (\phi, -i). \end{aligned}$$

Putting these all together:

Definition 6.49. We define the black box functor

$$\blacksquare : \text{Circ} \rightarrow \text{LagrRel}$$

on objects by mapping a finite set X to the symplectic vector space

$$\blacksquare(X) = \mathbb{F}^X \oplus (\mathbb{F}^X)^*.$$

and on morphisms by mapping a circuit $(X \xrightarrow{i} N \xleftarrow{o} Y, (N, E, s, t, r))$, to the Lagrangian relation

$$\blacksquare(\Gamma) = (\overline{\text{id}_X} \oplus \text{id}_Y) \circ S[i, o]^{\text{op}} \circ \text{Graph}(dP_\Gamma).$$

The coherence maps are given by the natural isomorphisms $\mathbb{F}^X \oplus (\mathbb{F}^X)^* \oplus \mathbb{F}^Y \oplus (\mathbb{F}^Y)^* \cong \mathbb{F}^{X+Y} \oplus (\mathbb{F}^{X+Y})^*$ and $\{0\} \cong \mathbb{F}^\emptyset \oplus (\mathbb{F}^\emptyset)^*$

As isomorphisms of cospans of \mathbb{F}^+ -graphs amount to no more than a relabelling of nodes and edges, this construction is independent of the cospan chosen as representative of the isomorphism class of cospans forming the circuit.

Theorem 6.50. *The black box functor is a well-defined hypergraph functor.*

We will prove this shortly. Before we get there, we first assure ourselves that we have indeed arrived at the theorem we set out to prove.

6.7.2 Minimization via composition of relations

At this point the reader might voice two concerns: firstly, why does the *black box* functor refer to the *extended* power functional P and, secondly, since it fails to talk about power minimization, how is it the same functor as that defined in Theorem 6.1? These fears are allayed by the remarkable trinity of minimization, the symplectification of functions, and Kirchhoff's laws.

We have seen that symplectification of functions views the cograph of the function as a picture of ideal wires, governed by Kirchhoff's laws (Example 6.47). We have also seen that Kirchhoff's laws are closely related to the principle of minimum power (Theorems 6.21 and 6.22). The final aspect of this relationship is that we may use symplectification of functions to enact minimization.

Theorem 6.51. *Let $\iota : \partial N \rightarrow N$ be an injection, and let P be a Dirichlet form on N . Write $Q = \min_{N \setminus \partial N} P$ for the Dirichlet form on ∂N given by minimization over $N \setminus \partial N$. Then we have an equality of Lagrangian subspaces*

$$S\iota^{\text{op}}(\text{Graph}(dP)) = \text{Graph}(dQ).$$

Proof. Recall from Example 6.47 that $S\iota^{\text{op}}$ is the Lagrangian relation

$$S\iota^{\text{op}} = \{(\phi, \iota_*i, \phi \circ \iota, i) \mid \phi \in \mathbb{F}^N, i \in (\mathbb{F}^{\partial N})^*\} \subseteq \overline{\mathbb{F}^N \oplus (\mathbb{F}^N)^*} \oplus \mathbb{F}^{\partial N} \oplus (\mathbb{F}^{\partial N})^*,$$

where $\iota_*i(\phi) = i(\phi \circ \iota)$, and note that

$$\text{Graph}(dP) = \{(\phi, dP_\phi) \mid \phi \in \mathbb{F}^N\}.$$

This implies that their composite is given by the set

$$S\iota^{\text{op}} \circ \text{Graph}(dP) = \{(\phi \circ \iota, i) \mid \phi \in \mathbb{F}^N, i \in (\mathbb{F}^{\partial N})^*, dP_\phi = \iota_*i\}.$$

We must show this Lagrangian subspace is equal to $\text{Graph}(dQ)$.

Consider the constraint $dP_\phi = \iota_*i$. This states that for all $\varphi \in \mathbb{F}^N$ we have $dP_\phi(\varphi) = i(\varphi \circ \iota)$. Letting $\chi_n : N \rightarrow \mathbb{F}$ be the function sending $n \in N$ to 1 and all other elements of N to 0, we see that when $n \in N \setminus \partial N$ we must have

$$\left. \frac{dP}{d\varphi(n)} \right|_{\varphi=\phi} = dP_\phi(\chi_n) = i(\chi_n \circ \iota) = i(0) = 0.$$

So ϕ must be a realizable extension of $\psi = \phi \circ \iota$. We henceforth write $\tilde{\psi} = \phi$. As ι is injective, $\psi = \phi \circ \iota$ gives no constraint on $\psi \in \mathbb{F}^{\partial N}$.

We next observe that we can write $S\iota^{\text{op}} \circ \text{Graph}(dP) = \text{Graph}(dO)$ for some quadratic form O . Recall that Proposition 6.38 states that a Lagrangian subspace L of $\mathbb{F}^{\partial N} \oplus (\mathbb{F}^{\partial N})^*$ is of the form $\text{Graph}(dO)$ if and only if L has trivial intersection with $\{0\} \oplus (\mathbb{F}^{\partial N})^*$. But indeed, if $\psi = 0$ then 0 is a realizable extension of ψ , so $\iota_*i = dP_0 = 0$, and hence $i = 0$.

It remains to check that $O = Q$. This is a simple computation:

$$O(\psi) = dO_\psi(\psi) = dO_\psi(\tilde{\psi} \circ \iota) = \iota_*dQ_\psi(\tilde{\psi}) = dP_{\tilde{\psi}}(\tilde{\psi}) = P(\tilde{\psi}) = Q(\psi),$$

where $\tilde{\psi}$ is any realizable extension of $\psi \in \mathbb{F}^{\partial N}$. □

Write $\iota : \partial N \rightarrow N$ for the inclusion of the terminals into the set of nodes of the circuit, and $i|^{\partial N} : X \rightarrow \partial N$, $o|^{\partial N} : Y \rightarrow \partial N$ for the respective corestrictions of the input and output map to ∂N . Note that $[i, o] = \iota \circ [i|^{\partial N}, o|^{\partial N}]$. Also, in the introduction, we introduced the ‘twisted symplectification’ S^t , which we can now understand as an application of the functor S followed by the isomorphism $\overline{\text{id}_X}$ of a standard symplectic space with its conjugate. Then we have the equalities of sets, and thus Lagrangian relations:

$$\begin{aligned} & (\overline{\text{id}_X} \oplus \text{id}_Y) \circ S[i, o]^{\text{op}} \circ \text{Graph}(dP_\Gamma) \\ &= (\overline{\text{id}_X} \oplus \text{id}_Y) \circ S[i|^{\partial N}, o|^{\partial N}]^{\text{op}} \circ S\iota^{\text{op}} \circ \text{Graph}(dP_\Gamma) \\ &= (\overline{\text{id}_X} \oplus \text{id}_Y) \circ S[i|^{\partial N}, o|^{\partial N}]^{\text{op}} \circ \text{Graph}(dQ_\Gamma) \\ &= \bigcup_{v \in \text{Graph}(dQ)} S^t i|^{\partial N}(v) \times S o|^{\partial N}(v) \end{aligned}$$

We see now that Theorem 6.50 is a restatement of Theorem 6.1 in the introduction.

6.7.3 Proof of functoriality

To prove that the black box functor is a hypergraph functor, we merely assemble it from other functors, almost all of which we have already discussed. Indeed, our factorisation will run

$$\blacksquare : \text{Circ} \rightarrow \text{DirichCospan} \rightarrow \text{LagrCospan} \rightarrow \text{LagrCorel} \rightarrow \text{LagrRel}.$$

The first three of these functors are decorated corelations functors, assembled from the monoidal natural transformations

$$\begin{array}{ccc}
 (\text{FinSet}, +) & \xrightarrow{\text{Circuit}} & (\text{Set}, \times) \\
 \parallel & \Downarrow \theta & \parallel \\
 (\text{FinSet}, +) & \xrightarrow{\text{Dirich}} & (\text{Set}, \times) \\
 \parallel & \Downarrow \beta & \parallel \\
 (\text{FinSet}, +) & \xrightarrow{\text{Lagr}} & (\text{Set}, \times) \\
 \downarrow & \Downarrow \pi & \parallel \\
 (\text{Cospan}(\text{FinSet}), +) & \xrightarrow{\text{Lagr}} & (\text{Set}, \times).
 \end{array}$$

The last factor, the functor from LagrCorel to LagrRel , is the hypergraph equivalence discussed at the end of Subsection 6.6.5.

We have also already discussed the strict hypergraph functors $\text{Circ} \rightarrow \text{DirichCospan}$ given by θ (in §6.4.3) and $\text{LagrCospan} \rightarrow \text{LagrCorel}$ given by π (in §6.6.5). It remains to address β .

Proposition 6.52. *Let*

$$\beta: (\text{Dirich}, \delta) \Longrightarrow (\text{Lagr}, \lambda)$$

be the collection of functions

$$\begin{aligned}
 \beta_N: \text{Dirich}(N) &\longrightarrow \text{Lagr}(N); \\
 Q &\longmapsto \{(\phi, dQ_\phi) \mid \phi \in \mathbb{F}^N\} \subseteq \mathbb{F}^N \oplus (\mathbb{F}^N)^*.
 \end{aligned}$$

Then β is a monoidal natural transformation.

Proof. Naturality requires that the square

$$\begin{array}{ccc}
 \text{Dirich}(N) & \xrightarrow{\beta_N} & \text{Lagr}(N) \\
 \text{Dirich}(f) \downarrow & & \downarrow \text{Lagr}(f) \\
 \text{Dirich}(M) & \xrightarrow{\beta_M} & \text{Lagr}(M)
 \end{array}$$

commutes for every function $f: N \rightarrow M$. This is primarily a consequence of the fact that the differential commutes with pullbacks. As we did in Example 6.47, write f^* for the pullback map and f_* for the pushforward map. Then $\text{Dirich}(f)$ maps a

Dirichlet form Q on N to the form f_*Q , and β_M in turn maps this to the Lagrangian subspace

$$\{(\psi, d(f_*Q)_\psi) \mid \psi \in \mathbb{F}^M\} \subseteq \mathbb{F}^M \oplus (\mathbb{F}^M)^*.$$

On the other hand, β_N maps a Dirichlet form Q on N to the Lagrangian subspace

$$\{(\phi, dQ_\phi) \mid \phi \in \mathbb{F}^N\} \subseteq \mathbb{F}^N \oplus (\mathbb{F}^N)^*,$$

before $\text{Lagr}(f)$ maps this to the Lagrangian subspace

$$\{(\psi, f_*dQ_\phi) \mid \psi \in \mathbb{F}^M, \phi = f^*(\psi)\} \subseteq \mathbb{F}^M \oplus (\mathbb{F}^M)^*.$$

But

$$f_*dQ_{f^*\psi} = d(f_*Q)_\psi,$$

so these two processes commute.

Monoidality requires that the diagrams

$$\begin{array}{ccc} \text{Dirich}(N) \times \text{Dirich}(M) & \xrightarrow{\beta_N \times \beta_M} & \text{Lagr}(N) \times \text{Lagr}(M) \\ \delta_{N,M} \downarrow & & \downarrow \lambda_{N,M} \\ \text{Dirich}(N+M) & \xrightarrow{\beta_{N+M}} & \text{Lagr}(N+M) \end{array}$$

and

$$\begin{array}{ccc} & 1 & \\ \delta_\emptyset \swarrow & & \searrow \lambda_\emptyset \\ \text{Dirich}(\emptyset) & \xrightarrow{\beta_\emptyset} & \text{Lagr}(\emptyset) \end{array}$$

commute. These do: the Lagrangian subspace corresponding to the sum of Dirichlet forms is equal to the sum of the Lagrangian subspaces that correspond to the summand Dirichlet forms, while there is only a unique map $1 \rightarrow \text{Lagr}(\emptyset)$. \square

We thus obtain a strict hypergraph functor

$$\text{DirichCospan} \rightarrow \text{LagrCospan},$$

which simply replaces the decoration on each cospan in DirichCospan with the corresponding Lagrangian subspace.

Observe now that the black box functor does indeed factor as described:

$$\blacksquare: \text{Circ} \rightarrow \text{DirichCospan} \rightarrow \text{LagrCospan} \rightarrow \text{LagrCorel} \rightarrow \text{LagrRel}.$$

The first factor takes a circuit Γ to its extended power functional P_Γ and the second to its graph $\text{Graph}(P_\Gamma)$. The next two functors turn this from a cospan of finite sets decorated by a Lagrangian subspace into a genuine Lagrangian relation.

Chapter 7

Further directions

In summary, we have set up a framework for formalising network-style diagrammatic languages, and illustrated it in detail with applications to two types of such languages.

We close with a few words regarding ongoing research extending these ideas. For balance, the first is theoretical, regarding the use of epi-mono factorisation systems for black boxing systems, and the second applied, regarding consequences of our work on passive linear networks in Chapter 6. In particular, we include these to illustrate that the existence of the black box functor is not just a pretty category theoretic abstraction, but creates a language in which genuinely applied, novel results can be formulated and proved.

7.1 Bound colimits

A theme of this thesis is that while cospans in some category \mathcal{C} with finite colimits are adequate for describing the interconnection of open systems, their composition often retains more information than can be observed from the boundary. In the cases of ideal wires (§3.4.1), linear relations (§3.4.2), and signal flow diagrams (Chapter 5), corelations with respect to an epi-mono factorisation system instead provide the right notion of black boxed open system. Why? What do different factorisation systems model, and how to choose the right one?

In [RSW08], Rosebrugh, Sabadini, and Walters describe how composition of cospans can be used to calculate colimits. Here we argue that the idea of an open system or, equivalently, a system with boundary, motivates a variant of the colimit, which we term the bound colimit.

Given a category, an open system is a morphism $s: B \rightarrow T$. Call B the boundary, and T the (total) system. For example, in FinSet a system is just a set of ‘connected

components', and the boundary describes how we may connect other systems to these components.

In the above, we have worked with the boundary as two objects, so an open system is a cospan $B_1 \rightarrow T \leftarrow B_2$. To return to the above picture, we just observe our boundary consists of the discrete two object category $\{B_1, B_2\}$, and take a colimit, yielding the open system $B_1 + B_2 \rightarrow T$.

In general we can think of specifying an open system in this way: not just as a single morphism $B \rightarrow T$, but as a diagram in our category, where some objects B_i are denoted 'boundary' objects, and the remainder T_j 'system' objects. It helps intuition to add the condition that our diagram cannot contain maps from a system object to a boundary object.

We can compute a more efficient representation of our diagrammed open system by first taking the colimit of the full subcategory with objects the boundary objects B_i , to arrive at a single boundary object B . We can also take a colimit over the entire diagram to arrive at a single total system object T . Since a cocone over the entire diagram is a fortiori a cocone over the boundary subdiagram, we get a map $B \rightarrow T$. This is our open system.

Suppose now we are interested in the most efficient representation of this system. In the examples mentioned above this has meant $s: B \rightarrow T$ is an epimorphism. Why? Consider the following intuition. Varying over all 'viewing objects' V , a system T is completely described by $\text{hom}(T, V)$ (in the sense of the Yoneda lemma). But from the boundary B , not all of these maps can be witnessed. Instead the best we can do is study the image of $\text{hom}(T, V)$ in $\text{hom}(B, V)$, where the image is given by precomposition with $s: B \rightarrow T$. Call two systems with boundary B equivalent if for all objects V they give the same image in $\text{hom}(B, V)$.

Now, many different systems will be equivalent. For example, if we take any open system $s: B \rightarrow T$ and split mono $m: T \rightarrow T'$ (with retraction $m': T' \rightarrow T$), then any map $f: B \xrightarrow{s} T \xrightarrow{r} V$ can be written $f: B \xrightarrow{s;m} T' \xrightarrow{m';r} V$. And any map $g: B \xrightarrow{s;m} T' \xrightarrow{r'} V$ can be written $g: B \xrightarrow{s} T \xrightarrow{m;r'} V$. So $s: B \rightarrow T$ and $s;m: B \rightarrow T'$ give the same image in $\text{hom}(B, V)$. (These images being the images of the maps $\text{hom}(T, V) \rightarrow \text{hom}(B, V)$ and $\text{hom}(T', V) \rightarrow \text{hom}(B, V)$ they respectively induce.)

Consequently, if we are interested in efficient representations, then we should subtract the largest split monic we can from T . This retracts the redundant information. Also note that if we have an epimorphism $e: B \rightarrow T$ then the map $\text{hom}(T, V) \rightarrow \text{hom}(B, V)$ is one-to-one.

Thus, if our category has an epi-split mono factorisation system, then equivalence classes of open systems can be indexed by epis $e: B \rightarrow T$. The epi e is the minimal representation, or the black boxed system.

Suppose now that we want to compute the interconnection—or colimit—and minimal representation—the epi part—simultaneously. This allows us to consider a setting where there are only minimal representations: where everything is always ‘black boxed’. The object of this computation is the bound colimit.

To compute the minimal representation we were interested in the image of system homset $\text{hom}(T, V)$ in the boundary homset $\text{hom}(B, V)$. What is the universal property of the epi part $e: B \rightarrow M$ of an open system $s: B \rightarrow T$?

First, assuming we have an epi-split mono factorisation $s = e; m$, with some retraction m' , then $e: B \rightarrow M$ is a cocone over B that extends (nonuniquely) to a cocone

$$\begin{array}{ccc} & M & \\ e \nearrow & & \nwarrow m' \\ B & \xrightarrow{s} & T \end{array}$$

over $s: B \rightarrow T$. Second, if there is another cocone $c: B \rightarrow N$ over B that extends to some cocone

$$\begin{array}{ccc} & N & \\ c \nearrow & & \nwarrow x \\ B & \xrightarrow{s} & T \end{array}$$

over $s: B \rightarrow T$, then there exists a unique map $m; x: M \rightarrow N$ such that

$$\begin{array}{ccc} M & \xrightarrow{m;x} & N \\ e \swarrow & & \searrow c \\ & B & \end{array}$$

commutes. Uniqueness is by the epi property of e .

Thus the ‘minimal representation’ M is initial in the cocones over B that extend to cocones over $s: B \rightarrow T$. The intuition is that M finds the balance between removing useful information—if we remove too much it won’t extend to a cocone over $B \rightarrow T$ —and removing redundant information—if we don’t remove enough then it won’t be initial.

To generalise this diagrams of open systems, rather than just an arrow $B \rightarrow T$, we instead want the apex of the cocone that is initial out of all cocones over the boundary diagram that extend to a cocone over the system diagram. Call this the bound colimit. Then, instead of describing composition of corelations as ‘taking

the jointly epic part of the pushout’, we might simply say we ‘compute the bound pushout’. Further work will explore the relationship between epi-mono corelations and bound colimits in analogy with the relationship between cospans and colimits.

7.2 Open circuits and other systems

We conclude with brief mentions of two applications of the category of passive linear networks, illustrating the further utility of formalising network-style diagrammatic languages as hypergraph categories.

The first application concerns explicit use of the compositional structure to study networks of linear resistors. In [Jek], Jekel uses the compositional structure on circuits to analyse the inverse problem. Roughly speaking, the inverse problem seeks to determine the resistances on the edges of a circuit knowing only the underlying graph and the behaviour. Jekel defines a notion of elementary factorisation of circuits in terms of the compositional structure in Circ , and shows that these factorisations can be used to state a sufficient condition for the size of connections through the graph to be detectable from the linear-algebraic properties of the behaviour.

The second application demonstrates how formalisation of network-style diagrammatic languages allows formal exploration of the relationships between them. Indeed, work with Baez and Pollard [BFP16, Pol16] defines a decorated cospan category DetBalMark in which the morphisms are open detailed balanced continuous-time Markov chains, or open detailed balanced Markov processes for short. An open Markov process is one where probability can flow in or out of certain states called ‘inputs’ and ‘outputs’. A detailed balanced Markov process is one equipped with a chosen equilibrium distribution such that the flow of probability from any state i to any state j is equal to the flow of probability from j to i .

The behaviour of a detailed balanced open Markov process is determined by a principle of minimum dissipation, closely related to Prigogine’s principle of minimum entropy production. Moreover, the semantics of these Markov processes are given by a functor $\square: \text{DetBalMark} \rightarrow \text{LagrRel}$. This has a strong analogy with the principle of minimum power and the black box functor, and we show there is a functor $K: \text{DetBalMark} \rightarrow \text{Circ}$ and a natural transformation α

$$\begin{array}{ccc}
 \text{DetBalMark} & & \\
 \downarrow K & \searrow \square & \\
 \text{Circ.} & \xrightarrow{\quad \blacksquare \quad} & \text{LagrRel} \\
 & \swarrow \alpha & \\
 & &
 \end{array}$$

This natural transformation makes precise these analogies, and shows that we can model detailed balanced Markov processes with circuits of linear resistors in a compositional way.

Bibliography

- [Abr93] S. Abramsky. Interaction categories (extended abstract). In G. L. Burn, S. J. Gay, and M. D. Ryan, editors, *Theory and Formal Methods 1993: Proceedings of the First Imperial College Department of Computing Workshop on Theory and Formal Methods*, pp.57–70. Springer-Verlag Workshops in Computer Science, 1993. (Referred to on page [xii](#).)
- [Abr94] S. Abramsky. Interaction Categories and communicating sequential processes. In A. W. Roscoe, editor, *A Classical Mind: Essays in Honour of C.A.R. Hoare*, pp.1–15, Prentice-Hall International Englewood Cliffs, 1994. (Referred to on page [xii](#).)
- [AGN95] S. Abramsky, S. Gay, and R. Nagarajan. Interaction categories and the foundations of typed concurrent programming. In M. Broy, editor, *Deductive Program Design: Proceedings of the 1994 Marktoberdorf International Summer School*, NATO Advanced Study Institute Series F: Computer and Systems Sciences, pp.35–113, Springer-Verlag New York, 1995. (Referred to on page [xii](#).)
- [AC04] S. Abramsky and B. Coecke. A categorical semantics of quantum protocols. *Proceedings of the 19th IEEE Conference on Logic in Computer Science (LiCS'04)*, IEEE Computer Science Press, 2004. [arXiv:quant-ph/0402130](#). (Referred to on page [14](#).)
- [AHS04] J. Adámek, H. Herrlich, and G. E. Strohker. *Abstract and Concrete Categories: The Joy of Cats*. Online edition, 2004. Available at: <http://katmat.math.uni-bremen.de/acc/acc.pdf>. (Referred to on page [54](#).)
- [ASW11] L. Albasini, N. Sabadini, and R. F. C. Walters. The compositional construction of Markov processes. *Applied Categorical Structures*, 19(1):425–437, 2011. doi: 10.1007/s10485-010-9233-0. (Referred to on page [xii](#).)

- [Amb91] S. J. Ambler. *First order linear logic in symmetric monoidal closed categories*. PhD thesis, University of Edinburgh, 1991. (Referred to on page 55.)
- [Arb65] M. A. Arbib. A common framework for automata theory and control theory. *SIAM J. Contr.*, 3:206–222, 1965. (Referred to on page xii.)
- [AM74a] M. A. Arbib and E. G. Manes. Foundations of system theory: decomposable systems. *Automatica*, 10:285–302, 1974. (Referred to on page xii.)
- [AM74b] M. A. Arbib and E. G. Manes. Machines in a category: an expository introduction. *SIAM Review*, 16:163–192, 1974. (Referred to on page xii.)
- [AM80] M. A. Arbib and E. G. Manes. Machines in a category. *Journal of Pure and Applied Algebra*, 19:9–20, 1980. (Referred to on page xii.)
- [Ati88] M. Atiyah. Topological quantum field theory. *Inst. Hautes Études Sci. Publ. Math.*, 68:175–186, 1988. (Referred to on page xii.)
- [AV73] B. D. O. Anderson and S. Vongpanitlerd. *Network Analysis and Synthesis: a Modern Systems Theory Approach*. Prentice-Hall, Englewood Cliffs, 1973. (Referred to on page 130.)
- [Bae05] J. C. M. Baeten. A brief history of process algebra. *Theoretical Computer Science*, 335(2):131–146, 2005. (Referred to on page xiii.)
- [Bae06] J. C. Baez. Quantum quandaries: a category-theoretic perspective. In S. French, D. Rickles and J. Saatsi, editors, *Structural Foundations of Quantum Gravity*, pp.240–265. Oxford U. Press, Oxford, 2006. [arXiv:quant-ph/0404040](https://arxiv.org/abs/quant-ph/0404040). (Referred to on page .)
- [BE15] J. C. Baez and J. Erbele. Categories in control. *Theory and Applications of Categories*, 30:836–881, 2015. Available at <http://www.tac.mta.ca/tac/volumes/30/24/30-24abs.html>. (Referred to on page xiii, 69, 105.)
- [BF] J. C. Baez and B. Fong. A compositional framework for passive linear networks. Preprint. [arXiv:1504.05625](https://arxiv.org/abs/1504.05625). (Referred to on page xiv, 57, 97.)
- [BFP16] J. C. Baez, B. Fong, and B. Pollard. A compositional framework for Markov processes. *Journal of Mathematical Physics*, 57(3):033301, 2016. [doi:10.1063/1.4941578](https://doi.org/10.1063/1.4941578) (Referred to on page xi, xiii, 198.)

- [BL11] J. C. Baez and A. Lauda. A prehistory of n -categorical physics. In H. Halvorson, editor, *Deep Beauty: Mathematical Innovation and the Search for an Underlying Intelligibility of the Quantum World*, pp.13–128. Cambridge U. Press, Cambridge, 2011, [arXiv:0908.2469](https://arxiv.org/abs/0908.2469). (Referred to on page [xii](#).)
- [BS11] J. C. Baez and M. Stay. Physics, topology, logic and computation: a Rosetta Stone. In B. Coecke, editor, *New Structures for Physics*, Lecture Notes in Physics, 813:173–286. Springer, Berlin, 2011. [arXiv:0903.0340](https://arxiv.org/abs/0903.0340). (Referred to on page [xii](#), [129](#).)
- [BS82] P. Bamberg and S. Sternberg. Chap. 12: The theory of electrical circuits, *A Course of Mathematics for Students of Physics*, Vol. 2. Cambridge U. Press, Cambridge, UK, 1982. (Referred to on page [145](#).)
- [Bar70] M. Barr. Relational algebras. In S. Mac Lane *et al.*, editors, *Reports of the Midwest Category Seminar IV*, Lecture Notes in Mathematics, 137:39–55. Springer, Berlin, 1970. (Referred to on page [52](#).)
- [Bar71] M. Barr. Exact categories. In M. Barr, P. A. Grillet, and D. H. van Osdol, *Exact categories and categories of sheaves*, Lecture Notes in Mathematics, 236:1–120. 1971. (Referred to on page [54](#).)
- [Ben63] J. Bénabou. Catégories avec multiplication. *C. R. Acad. Sci. Paris*, 256:1887–1890, 1963. (Referred to on page [5](#).)
- [Ben67] J. Bénabou. Introduction to bicategories I. In J. Bénabou *et al*, editors, *Reports of the Midwest Category Seminar*, Springer Lecture Notes in Mathematics 47:1–77. Springer, New York, 1967. (Referred to on page [19](#), [35](#).)
- [Ber68] L. von Bertalanffy. *General Systems Theory: Foundations, Development, Applications*. George Braziller, New York, 1968. Available at https://monoskop.org/images/7/77/Von_Bertalanffy_Ludwig_General_System_Theory_1968.pdf. (Referred to on page [v](#), [vi](#).)
- [Bou90] N. Bourbaki. *Algebra II. Chapters 4–7*. Elements of Mathematics, Springer, 1990. Translated from the 1981 French edition by P. M. Cohn and J. Howie. (Referred to on page [157](#).)

- [BGKSZ] F. Bonchi, F. Gadducci, A. Kissinger, P. Sobociński, and F. Zanasi. Rewriting modulo symmetric monoidal structure. To appear in *Proceedings of Logic in Computer Science 2016, LICS16*. [arXiv:1602.06771](https://arxiv.org/abs/1602.06771). (Referred to on page 13.)
- [BSZ14] F. Bonchi, P. Sobociński, and F. Zanasi. A categorical semantics of signal flow graphs. In P. Baldan and D. Gorla, editors, *CONCUR 2014: Concurrency Theory*, Lecture Notes in Computer Science, 8704:435–450. Springer, Berlin 2014. Also available at <http://users.ecs.soton.ac.uk/ps/papers/sfg.pdf>. (Referred to on page xiii, 69, 97, 105, 119.)
- [BSZ15] F. Bonchi, P. Sobociński, and F. Zanasi. Full abstraction for signal flow graphs. In *PoPL '15*, pp.515–526. New York, 2015. (Referred to on page xiii, 104, 105, 119.)
- [BSZ16] F. Bonchi, P. Sobociński, and F. Zanasi. Interacting Hopf algebras. *J Pure Appl Algebra*, 2016. [doi:10.1016/j.jpaa.2016.06.002](https://doi.org/10.1016/j.jpaa.2016.06.002) (Referred to on page xiii, 104, 105, 108, 109, 111, 117, 124.)
- [BN37] R. Brauer and C. Nesbitt. On the regular representations of algebras. *Proceedings of the National Academy of Sciences of the United States of America*, 23(4):236, 1937. (Referred to on page 11.)
- [Bro07] F. T. Brown. *Engineering System Dynamics: a Unified Graph-Centered Approach*. Taylor and Francis, New York, 2007. (Referred to on page 155.)
- [Bru31] O. Brune. Synthesis of a finite two-terminal network whose driving-point impedance is a prescribed function of frequency. PhD thesis, MIT, 1931. Available at <http://dspace.mit.edu/bitstream/handle/1721.1/10661/36311006.pdf?sequence=1>. (Referred to on page 153.)
- [Bud74] A. Budak. *Passive and Active Network Analysis and Synthesis*, Houghton Mifflin, Boston, 1974. (Referred to on page 130.)
- [Car91] A. Carboni. Matrices, relations and group representations. *J. Algebra*, 138(2):497–529, 1991. (Referred to on page xii, 13.)

- [CW87] A. Carboni and R. F. C. Walters. Cartesian bicategories I. *J. Pure Appl. Alg.* 49(1-2):11–32, 1987. (Referred to on page 11.)
- [CT05] D. Cimasoni and V. Turaev. A Lagrangian representation of tangles. *Topology* 44(4):747–767, 2005. (Referred to on page 171.)
- [CS94] J. R. B. Cockett and D. A. Spooner. SProc categorically. In B. Jonsson and J. Parrow, editors, *Proceedings of CONCUR '94: Concurrency Theory*, pp.146–159, Springer-Verlag, 1994. (Referred to on page xiii.)
- [CK16] B. Coecke and A. Kissinger. *Picturing Quantum Processes: A First Course in Quantum Theory and Diagrammatic Reasoning*. Cambridge University Press, Cambridge, 2016. (Referred to on page 11.)
- [CP11] B. Coecke and É. O. Paquette. Categories for the practising physicist. In B. Coecke, editor, *New Structures for Physics*, Lecture Notes in Physics, 813:173–286. Springer, Berlin, 2011. [arXiv:0905.3010](https://arxiv.org/abs/0905.3010). (Referred to on page 129.)
- [CPP09] B. Coecke, E. Paquette and D. Pavlovic. Quantum and classical structuralism. In I. Mackie and S. Gay, editors, *Semantic Techniques for Quantum Computation*, pp.29–69. Cambridge University Press, Cambridge, 2009. [arXiv:0904.1997](https://arxiv.org/abs/0904.1997). (Referred to on page 11.)
- [Cou] K. Courser. A bicategory of decorated cospans. Preprint. [arXiv:1606.08100](https://arxiv.org/abs/1606.08100). (Referred to on page xiii, 35, 161.)
- [CF] B. Coya and B. Fong. Corelations are the prop for extraspecial commutative Frobenius monoids. Preprint. [arXiv:1601.02307](https://arxiv.org/abs/1601.02307). (Referred to on page 57, 68, 116.)
- [Dav80] B. Davies. A web of naked fancies?. *Phys. Educ.* 15(1):57–61, 1980. (Referred to on page 139.)
- [DeM60] A. De Morgan. *Syllabus of a Proposed System of Logic*, Walton and Maberly, London, 1860. (Referred to on page 52.)
- [Deu13] D. Deutch. Constructor theory. *Synthese*, 190(18):4331–4359, 2013. (Referred to on page viii.)

- [DS84] P. G. Doyle and J. L. Snell. *Random Walks and Electrical Circuits*. Mathematical Association of America, 1984. Also available at <http://www.math.dartmouth.edu/~doyle/>. (Referred to on page 149.)
- [Ell14] D. Ellerman. An introduction to partition logic. *Logic Journal of the Interest Group in Pure and Applied Logic*. 22(1):94–125, 2014. [doi:10.1093/jigpal/jzt036](https://doi.org/10.1093/jigpal/jzt036). (Referred to on page 57.)
- [Erb16] J. Erbele. *Categories in Control: applied PROPs*. PhD thesis, University of California, Riverside, 2016. (Referred to on page xiii.)
- [Fon15] B. Fong. Decorated Cospans. *Theory and Applications of Categories*, 30(33):25–50, 2015. [arXiv: 1502.00872](https://arxiv.org/abs/1502.00872). (Referred to on page xiii, 13.)
- [FRS16] B. Fong, P. Rapisarda and P. Sobocinski. A categorical approach to open and interconnected dynamical systems. To appear in *Proceedings of Logic in Computer Science 2016, LICS16*. [arXiv:1510.05076](https://arxiv.org/abs/1510.05076). (Referred to on page xiii, 69.)
- [For61] J. W. Forrester. *Industrial Dynamics*. Pegasus Communications, 1961. (Referred to on page 129.)
- [FS90] P. Freyd and A. Scedrov. *Categories, Allegories*. Mathematical Library 39, North Holland, 1990. (Referred to on page 52.)
- [Fri86] B. Friedland. *Control System Design: An Introduction to State-Space Methods*. McGraw-Hill, New York, 1986. (Referred to on page 101.)
- [FH15] P.A. Fuhrmann and U. Helmke. *The Mathematics of Networks of Linear Systems*, Springer-Verlag, Berlin Heidelberg, Berlin Heidelberg, 2015. (Referred to on page 126.)
- [Fuk80] M. Fukushima. *Dirichlet Forms and Markov Processes*. Elsevier Science & Technology Books, North-Holland, 1st edition, 1980. (Referred to on page 131, 143, 149.)
- [GH98] F. Gadducci, R. Heckel. An inductive view of graph transformation. In *Recent Trends in Algebraic Development Techniques*, Lecture Notes in Computer Science 1376:223–237. Springer-Verlag, Berlin Heidelberg, 1998. [10.1007/3-540-64299-4_36](https://doi.org/10.1007/3-540-64299-4_36). (Referred to on page 13.)

- [Gog72] J. Goguen. Minimal realization of machines in closed categories. *Bull. Am. Math. Soc.*, 78:777–783, 1972. (Referred to on page [xii](#).)
- [Gog75] J. Goguen. Discrete-time machines in closed monoidal categories I. *J Comput Systems Sci*, 10(1):1–43, 1975. doi:10.1016/S0022-0000(75)80012-2. (Referred to on page [xi](#).)
- [Gog91] J. A. Goguen. A Categorical Manifesto. In *Mathematical Structures in Computer Science*, 1(1):49–67, 1991. (Referred to on page [xi](#).)
- [Gri71] P. A. Grillet. Regular categories. In *Exact categories and categories of sheaves*, Lecture Notes in Mathematics 236:1–120. Springer–Verlag, Berlin Heidelberg, 1971. (Referred to on page [54](#).)
- [Har23] I. B. Hart. *Makers of Science*, p. 243. Oxford U. Press, Oxford, 1923. (Referred to on page [139](#).)
- [Hoa78] C. A. R. Hoare. Communicating sequential processes. *The origin of concurrent programming*, pp.413–443, Springer New York, 1978. (Referred to on page [xiii](#).)
- [Jan86] T. M. V. Janssen. *Foundations and applications of Montague grammar. Part 1: Philosophy, framework, computer science*. CWI tract 19, Centrum voor Wiskunde en Informatica, Amsterdam, 1986. <http://www.ilic.uva.nl/Research/Publications/Dissertations/HDS-10-Theo-Janssen.text.pdf>. (Referred to on page [vi](#).)
- [JW00] R. Jayawardene and O. Wyler. Categories of relations and functional relations. *Appl Categorical Str* 8(1):279–305, 2000. (Referred to on page [52](#), [58](#), [60](#).)
- [Jek] D. Jekel. Layering ∂ -graphs and networks. Preprint. [arXiv:1601.00247](https://arxiv.org/abs/1601.00247) (Referred to on page [xi](#), [198](#).)
- [JS91] A. Joyal and R. Street. The geometry of tensor calculus I. *Advances in Mathematics* 88(1):55–112, 1991. doi:10.1016/0001-8708(91)90003-P. (Referred to on page [xii](#), [5](#), [7](#), [9](#), [10](#), [129](#).)
- [JS93] A. Joyal and R. Street. Braided tensor categories. *Adv. Math.*, 102(1):20–78, 1993. (Referred to on page [xii](#), [129](#).)

- [Kai80] T. Kailath. *Linear Systems*, Prentice-Hall, Upper Saddle River, 1980. (Referred to on page 114.)
- [KSW97] P. Katis, N. Sabadini, and R. F. C. Walters. Span(Graph): A Categorical Algebra of Transition Systems. *AMAST '97 Proceedings of the 6th International Conference on Algebraic Methodology and Software Technology*, 307–321, 1997. (Referred to on page xii, 22.)
- [KSW00] P. Katis, N. Sabadini, and R. F. C. Walters. On the algebra of systems with feedback & boundary. *Rendiconti del Circolo Matematico di Palermo Serie II, Suppl.* 63:123–156, 2000. (Referred to on page xii.)
- [KT84] H. W. Knobloch and M. Thoma. Aspects of modern control theory. In *Perspectives in Mathematics: Anniversary of Oberwolfach 1984*, pp.337–376. Birkhäuser, Basel, 1984. (Referred to on page 102.)
- [KMR90] D. C. Karnopp, D. L. Margolis, and R. C. Rosenberg. *System Dynamics: a Unified Approach*. Wiley, New York, 1990. (Referred to on page 155.)
- [Kis] A. Kissinger. Finite matrices are complete for (dagger-)hypergraph categories. Preprint. [arXiv:1406.5942](https://arxiv.org/abs/1406.5942). (Referred to on page 13.)
- [Kle70] A. Klein. Relations in categories. *Illinois Journal of Mathematics*, 14(4):536–550, 1970. (Referred to on page 52.)
- [Lac04] S. Lack. Composing PROPs. *Theory and Applications of Categories*, 13(9):147–163, 2004. Available at <http://www.tac.mta.ca/tac/volumes/13/9/13-09abs.html> (Referred to on page 11, 19.)
- [Lac11] S. Lack. An embedding theorem for adhesive categories. *Theory and Applications of Categories*, 25(7):180–188, 2011. Available at <http://www.tac.mta.ca/tac/volumes/25/7/25-07abs.html>. (Referred to on page 59.)
- [LS04] S. Lack and P. Sobociński. Adhesive categories. In *Foundations of software science and computation structures*, LNCS 2987:273–288, Springer, Berlin, 2004. (Referred to on page 59.)
- [LS06] S. Lack and P. Sobociński. Toposes are adhesive. In *Graph transformations*, LNCS 4178:184–198, Springer, Berlin, 2006. (Referred to on page 59.)

- [Law63] F. W. Lawvere. Functorial semantics of algebraic theories and some algebraic problems in the context of functorial semantics of algebraic theories. *Reprints in Theory Appl. Categ.* 5:1–121. Available at <http://www.tac.mta.ca/tac/reprints/articles/5/tr5abs.html>. (Referred to on page 40.)
- [LR03] F. W. Lawvere, R. Rosebrugh. *Sets for Mathematics*. Cambridge University Press, Cambridge, 2003. (Referred to on page 57.)
- [LO73] M. van Lier and R. Otten. Planarization by transformation. *IEEE Transactions on Circuit Theory*, 20(2):169–171, 1973. (Referred to on page 150.)
- [MR91] Z.-M. Ma and M. Röckner. *Introduction to the Theory of (Non-Symmetric) Dirichlet Forms*, Springer, Berlin, 1991. (Referred to on page 131.)
- [Mac63a] S. Mac Lane. An algebra of additive relations *Proc. Nat. Acad. Sci. U.S.A* 47(4):1043–1051, 1963. (Referred to on page 52.)
- [Mac63b] S. Mac Lane. Natural associativity and commutativity. *Rice Univ. Studies*, 49(4):28–46, 1963. (Referred to on page 5.)
- [Mac98] S. Mac Lane. *Categories for the Working Mathematician*, Springer, Berlin, 1998. (Referred to on page 2, 6, 15, 19.)
- [Max68] J. Clerk Maxwell. On governors. *Proceedings of the Royal Society* no 100, 1868. Available at <http://rspl.royalsocietypublishing.org/content/16/270.full.pdf> (Referred to on page 101.)
- [Mil00] S. Milius. *Relations in categories*. MA thesis, York University, Ontario, 2000. (Referred to on page 52.)
- [Mil80] R. Milner. *A Calculus of Communicating Systems*. Springer-Verlag (LNCS 92), 1980. (Referred to on page xiii.)
- [Mon07] M. I. Monastyrsky. *Topology in Molecular Biology: DNA and Proteins*. Springer-Verlag, Berlin Heidelberg, 2007. doi:10.1007/978-3-540-49858-2 (Referred to on page v.)
- [Mon70] R. Montague. Universal Grammar. Reprinted in R. Thomason, editor, *Formal Philosophy*, pp.222–246. Yale University Press, New Haven, 1974. (Referred to on page vi.)

- [Mor14] J. Morton. Belief propagation in monoidal categories. In B. Coecke, I. Hasuo, P. Panangaden, editors, *Quantum Physics and Logic 2014 (QPL 2014)*, EPTCS 172:262–269. Tokyo, 2014. doi:10.4204/EPTCS.172.18 (Referred to on page 13.)
- [Nob06] D. Noble. *The Music of Life: Biology Beyond the Genome*, Oxford University Press, Oxford, 2006. (Referred to on page vi.)
- [Odu84] H. T. Odum. *Ecological and General Systems: An Introduction to Systems Ecology*. Wiley, New York, 1984. (Referred to on page 129.)
- [Ohm27] G. Ohm. *Die Galvanische Kette, Mathematisch Bearbeitet*. T. H. Riemann, Berlin, 1827. Also available at www.ohm-hochschule.de/bib/textarchiv/Ohm.Die_galvanische_Kette.pdf. (Referred to on page 139.)
- [OFM07] R. Olfati-Saber, J.A. Fax, and R.M. Murray. Consensus and cooperation in networked multi-agent systems. *Proc. IEEE*, 96(1):215–233, 2007. (Referred to on page 106, 125.)
- [Ols43] H. F. Olson. *Dynamical Analogies*. Van Nostrand, New York, 1943. Also available at <https://archive.org/details/DynamicalAnalogies>. (Referred to on page 129.)
- [Pay61] H. M. Paynter. *Analysis and Design of Engineering Systems*, MIT Press, Cambridge, 1961. (Referred to on page 129.)
- [PT08] P. Piccione and D. V. Tausk. *A student’s guide to symplectic spaces, Grassmannians and Maslov index*, Publicações Matemáticas do IMPA, Rio de Janeiro, 2008. Also available at <http://www.ime.usp.br/~piccione/Downloads/MaslovBook.pdf>. (Referred to on page 171.)
- [Pie70] C. S. Pierce. Description of a Notation for the Logic of Relatives, Resulting from an Amplification of the Conceptions of Boole’s Calculus of Logic. *Memoirs of the American Academy of Arts and Sciences*, 9:317–378, 1870. (Referred to on page 52.)
- [Pol16] B. Pollard. Open Markov processes: a compositional perspective on non-equilibrium steady states in biology. *Entropy*, 18(4):140. (Referred to on page xi, xiii, 198.)

- [Pup62] D. Puppe. Korrespondenzen in abelschen Kategorien. *Math. Annalen* 148:1–30, 1962. (Referred to on page 52.)
- [RSW05] R. Rosebrugh, N. Sabadini, and R. F. C. Walters. Generic commutative separable algebras and cospans of graphs. *Th. App. Cat.* 15(6):164–177, 2005. Available at <http://www.tac.mta.ca/tac/volumes/15/6/15-06abs.html>. (Referred to on page xii, 11, 13.)
- [RSW08] R. Rosebrugh, N. Sabadini, and R. F. C. Walters. Calculating colimits compositionally. In P. Degano *et al.*, *Montanari Festschrift, LNCS*, 5065:581–592. Springer–Verlag, Berlin Heidelberg, 2008. (Referred to on page xii, 19, 20, 195.)
- [Ros12] R. Rosen. *Anticipatory Systems: Philosophical, Mathematical, and Methodological Foundations*, Springer, New York, 2nd ed., 2012. (Referred to on page xi.)
- [Ros70] H. H. Rosenbrock. *State Space and Multivariable Theory*. Wiley, New York, 1970. (Referred to on page 107.)
- [Sab97] C. Sabot. Existence and uniqueness of diffusions on finitely ramified self-similar fractals, Section 1: Dirichlet forms on finite sets and electrical networks. *Annales Scientifiques de l'École Normale Supérieure*, 4(30):605–673, 1997. Also available at http://www.numdam.org/numdam-bin/item?id=ASENS_1997_4_30_5_605_0. (Referred to on page 131, 132.)
- [Sab04] C. Sabot. Electrical networks, symplectic reductions, and application to the renormalization map of self-similar lattices. *Proc. Symp. Pure Math.* 72:155–205, 2004. Also available as [arXiv:math-ph/0304015](https://arxiv.org/abs/math-ph/0304015). (Referred to on page 131, 132.)
- [Sch88] J. M. Schumacher. Transformations of linear systems under external equivalence. *Linear Algebra and its Applications*, 102:1–33, 1988. (Referred to on page 115.)
- [SS71] D. Scott and C. Strachey. *Toward a mathematical semantics for computer languages*, Oxford Computing Lab. Programming Research Group, Oxford, 1971. (Referred to on page vi.)

- [Sel07] P. Selinger. Dagger compact closed categories and completely positive maps. *Proceedings of the 3rd International Workshop on Quantum Programming Languages (QPL 2005)*, *ENTCS* 170(6): 139–163, 2007. Also available at <http://www.mscs.dal.ca/~selinger/papers/dagger.pdf>. (Referred to on page .)
- [Sel11] P. Selinger. A survey of graphical languages for monoidal categories. In B. Coecke, ed., *New Structures for Physics*, Lecture Notes in Physics 813:289–355. Springer, Berlin, 2011. Available as [arXiv:0908.3347](https://arxiv.org/abs/0908.3347). (Referred to on page 5, 7.)
- [Sha42] C. E. Shannon. The theory and design of linear differential equation machines. Reported to National Defence Research Council, 1942. (Referred to on page 103.)
- [Sle68] P. Slepian. *Mathematical Foundations of Network Analysis*. Springer, Berlin, 1968. (Referred to on page 130.)
- [Sma72] S. Smale. On the mathematical foundations of electrical network theory. *J. Diff. Geom.* 7(1-2):193–210, 1972. (Referred to on page 130.)
- [Son98] E. D. Sontag. *Mathematical Control Theory: Deterministic Finite Dimensional Systems*. Springer, Berlin, 1998. (Referred to on page 101.)
- [Son04] E. D. Sontag. Some new directions in control theory inspired by systems biology. *Syst. Biol.* 1(1):9–18, 2004. (Referred to on page 101.)
- [Spi] D. I. Spivak. The operad of wiring diagrams: formalizing a graphical language for databases, recursion, and plug-and-play circuits. Preprint. [arXiv:1305.0297](https://arxiv.org/abs/1305.0297). (Referred to on page xiii.)
- [SSR] D. I. Spivak, P. Schultz, and D. Rupel. String diagrams for traced and compact categories are oriented 1-cobordisms. Preprint. [arXiv:1508.01069](https://arxiv.org/abs/1508.01069). (Referred to on page xiii.)
- [Sta16] M. Stay. Compact closed bicategories. To appear in *Theory and Applications of Categories*. [arXiv:1301.1053](https://arxiv.org/abs/1301.1053). (Referred to on page 161.)
- [Sza13] Z. G. Szabó. Compositionality. In E. N. Zalta, editor, *The Stanford Encyclopedia of Philosophy* (Fall 2013 Edition). The Metaphysics Research Lab, Center for the Study of Language and Information, Stanford, 2013.

- <http://plato.stanford.edu/archives/fall2013/entries/compositionality/>.
(Referred to on page vi.)
- [VSL15] D. Vagner, D. I. Spivak, and E. Lerman. Algebras of open dynamical systems on the operad of wiring diagrams. *Theory and Applications of Categories*, 30(51):1793–1822, 2015. (Referred to on page xiii.)
- [VSS] D. Vagner, D. I. Spivak, and P. Schultz. Topological compositionality in various doctrines. Unpublished manuscript. (Referred to on page 91.)
- [Wei81] A. Weinstein. Symplectic geometry. *Bull. Amer. Math. Soc.* 5(1):1–13, 1981. Also available at <https://projecteuclid.org/euclid.bams/1183548217>. (Referred to on page 132, 175.)
- [Wey23] H. Weyl. Repartición de corriente en una red conductora. *Rev. Mat. Hisp. Amer.* 5(6):153–164, 1923. <http://math.ucr.edu/home/baez/weyl1923.pdf> (Referred to on page 130, 145.)
- [Wig60] E. P. Wigner. The unreasonable effectiveness of mathematics in the natural sciences. *Communications on Pure and Applied Mathematics*, 13(1):1–14, 1960. (Referred to on page v.)
- [Wil86] J. C. Willems. From time series to linear system—Part I. Finite dimensional linear time invariant systems. *Automatica*, 22(5):561–580, 1986. (Referred to on page 103, 105, 106, 108, 115.)
- [Wil89] J. C. Willems. Models for dynamics. In U. Kirchgraber and H. O. Walther, editors, *Dynamics Reported, Volume 2*, pp.171-269. John Wiley & Sons Ltd and B. G. Teubner, 1989. (Referred to on page 102, 121, 126, 180.)
- [Wil07] J. Willems. The behavioral approach to open and interconnected systems. *IEEE Control Systems Magazine* 27:46–99, 2007. Also available at <http://homes.esat.kuleuven.be/~jwillems/>. (Referred to on page viii, 102, 105, 106, 122, 126, 180.)
- [Yon54] N. Yoneda. On Ext and exact sequences. *J. Fac. Sci. Univ. Tokyo, Sec. I*, 7:193–227, 1954. (Referred to on page 19.)
- [Zan15] F. Zanasi. *Interacting Hopf algebras—the theory of linear systems*. PhD thesis, École Normale Supérieure de Lyon, 2015. Available at

<https://tel.archives-ouvertes.fr/tel-01218015/>. (Referred to on page [xiii](#), [104](#), [105](#), [111](#), [112](#), [113](#), [114](#), [117](#), [124](#).)