

Polarization Sensitive Multi-Chroic MKIDs

Bradley R. Johnson^a, Daniel Flanigan^a, Maximilian H. Abitbol^a, Peter A. R. Ade^b,
Sean Bryan^c, Hsiao-Mei Cho^g, Rahul Datta^e, Peter Day^f, Simon Doyle^b,
Kent Irwin^{d,g}, Glenn Jones^a, Sarah Kernasovskiy^d, Dale Li^g, Phil Mauskopf^c,
Heather McCarrick^a, Jeff McMahon^e, Amber Miller^a, Giampaolo Pisano^b,
Yanru Song^d, Harshad Surdi^c, and Carole Tucker^b

^aDepartment of Physics, Columbia University, New York, NY, 10027, USA;

^bSchool of Physics & Astronomy, Cardiff University, Cardiff, CF243AA, UK;

^cSchool of Earth and Space Exploration, Arizona State University, Tempe, AZ, 85287, USA;

^dDepartment of Physics, Stanford University, Stanford, CA, 94305-4085, USA;

^eDepartment of Physics, University of Michigan, Ann Arbor, MI, 48103, USA;

^fNASA, Jet Propulsion Lab, Pasadena, CA, 91109, USA;

^gSLAC National Accelerator Laboratory, Menlo Park, CA 94025, USA

ABSTRACT

We report on the development of scalable prototype microwave kinetic inductance detector (MKID) arrays tailored for future multi-kilo-pixel experiments that are designed to simultaneously characterize the polarization properties of both the cosmic microwave background (CMB) and Galactic dust emission. These modular arrays are composed of horn-coupled, polarization-sensitive MKIDs, and each pixel has four detectors: two polarizations in two spectral bands between 125 and 280 GHz. A horn is used to feed each array element, and a planar orthomode transducer, composed of two waveguide probe pairs, separates the incoming light into two linear polarizations. Diplexers composed of resonant-stub band-pass filters separate the radiation into 125 to 170 GHz and 190 to 280 GHz pass bands. The millimeter-wave power is ultimately coupled to a hybrid co-planar waveguide microwave kinetic inductance detector using a novel, broadband circuit developed by our collaboration. Electromagnetic simulations show the expected absorption efficiency of the detector is approximately 90%. Array fabrication will begin in the summer of 2016.

Keywords: CMB, Polarization, MKID

1. INTRODUCTION

Microwave kinetic inductance detectors (MKIDs) are superconducting thin-film, GHz resonators that are designed to also be optimal photon absorbers.¹ Absorbed photons with energies greater than the superconducting gap ($\nu > 2\Delta/h \cong 74 \text{ GHz} \times (T_c/1 \text{ K})$) break Cooper pairs, changing the density of quasiparticles in the device. The quasiparticle density affects the kinetic inductance and the dissipation of the superconducting film, so a changing optical signal will cause the resonant frequency and internal quality factor of the resonator to shift. These changes in the properties of the resonator can be detected as changes in the amplitude and phase of a probe tone that drives the resonator at its resonant frequency. This detector technology is particularly well-suited for sub-kelvin, kilo-pixel detector arrays because each detector element can be dimensioned to have a unique resonant frequency, and the probe tones for hundreds to thousands of detectors can be carried into and out of the cryostat on a single pair of coaxial cables.

In this paper, we report on the development of modular arrays of horn-coupled, polarization-sensitive MKIDs that are each sensitive to two spectral bands between 125 and 280 GHz. The scalable prototype MKID arrays we are developing are tailored for future multi-kilo-pixel experiments that are designed to simultaneously characterize the polarization properties of both the cosmic microwave background (CMB) and Galactic dust emission. Our device design builds from successful transition edge sensor (TES) bolometer architectures that

E-mail: bjohnson@phys.columbia.edu

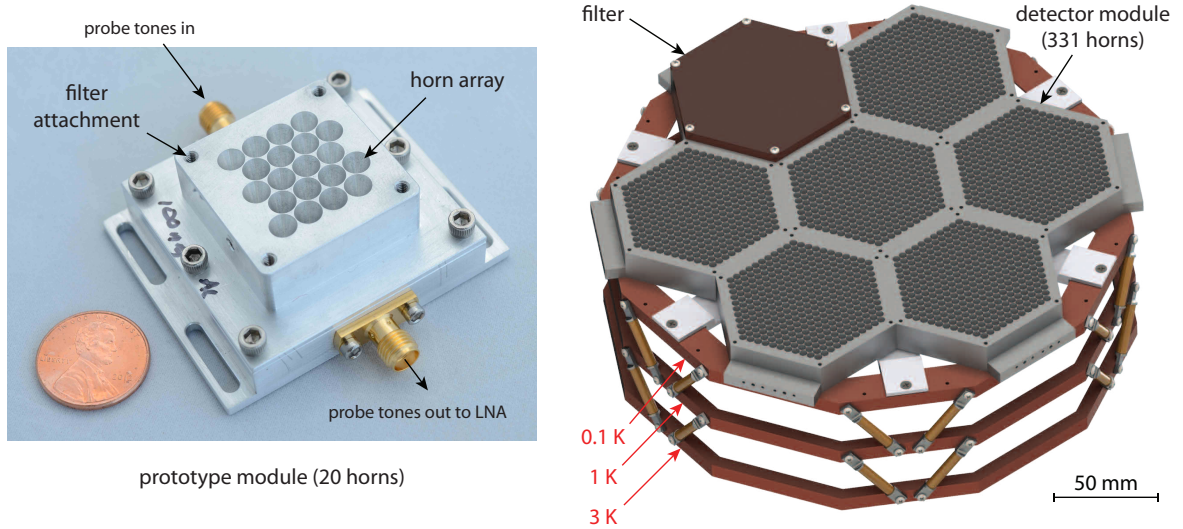

Figure 1. **Left:** A scalable 20-element prototype module for dual-polarization LEKIDs. The module we are currently building for our prototype multi-chroic MKID arrays looks similar. **Right:** Future focal plane concept. By design, the module architecture shown on the left is scalable to one of the seven modules shown on the right. The concept detector array on the right includes 9268 single polarization detectors spread over two spectral bands.

have been developed by the Truce Collaboration* and demonstrated to work in receivers on the ACT and SPT telescopes.²⁻⁵ Detector modules like these could be a strong candidate for a future CMB satellite mission and/or CMB-S4^{6,7} because these future multi-kilo-pixel programs will require efficient multiplexing schemes and MKID arrays could out-perform current technologies in this regard (see Figure 1).

A range of MKID-based instruments have already shown that MKIDs work well at millimeter and sub-millimeter wavelengths. Early MKIDs used antenna coupling,⁸ and these antenna-coupled MKIDs were demonstrated at the Caltech Submillimeter Observatory (CSO) in 2007⁹ leading to the development of MUSIC, a multi-chroic antenna-coupled MKID camera.¹⁰ A simpler device design that uses the inductor in a single-layer *LC* resonator to directly absorb the millimeter and sub-millimeter-wave radiation was published in 2008.¹¹ This style of MKID, called the lumped-element kinetic inductance detector (LEKID), was first demonstrated in 2011 in the 224-pixel NIKA dual-band millimeter-wave camera on the IRAM 30 m telescope in Spain.¹²

Laboratory studies have shown that state-of-the-art MKID and LEKID designs can achieve photon noise limited performance.^{13,14} Photon noise limited horn-coupled LEKIDs sensitive to 1.2 THz were recently demonstrated¹⁵ and these detectors will be used in BLAST-TNG.^{16,17} Members of our collaboration conducted studies of horn-coupled LEKIDs to see if LEKIDs would be suitable for CMB polarimetry. These studies revealed that the sensitivity of the LEKID variety of MKID can be compared with that of state-of-the-art TES bolometers.^{18,19} On-chip spectrometers based on MKIDs are currently being developed.^{20,21} And a large format sub-millimeter wavelength camera, called A-MKID, with more than 10,000 pixels and readout multiplexing factors greater than 1,000 has been built and is currently being commissioned.²²

2. METHODS

Our horn-coupled, multi-chroic devices are based on the polarimeters that were developed for the Advanced ACTPol experiment.^{23,24} These devices were recently deployed and field tested, and early indications are they work well. Our MKID development program is focused on re-optimizing this design for silicon-on-insulator (SOI) wafers and replacing the TES bolometers with hybrid co-planar waveguide (CPW) MKIDs. Our design is shown in Figure 2. The microstrip to CPW coupling technology is a critical part of our development program, and the move to SOI wafers is motivated in Section 2.2. Note that the nominal Advanced ACTPol design uses a

*<http://casa.colorado.edu/~henin/jw/TRUCE/TRUCE.html>

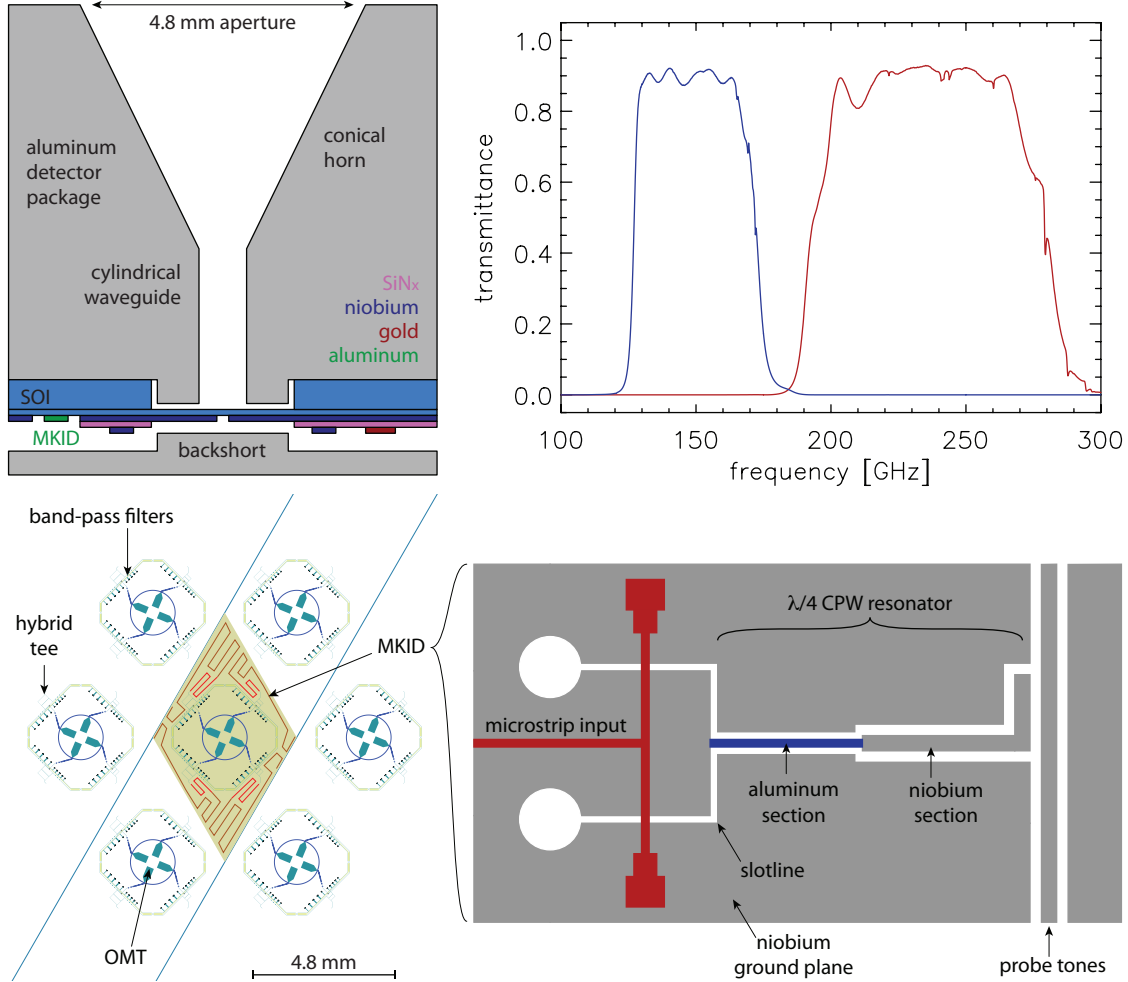

Figure 2. **Top Left:** A cross-sectional view of one focal-plane element. In an effort to minimize two-level system (TLS) noise, the MKID sensing element is deposited directly on the silicon wafer, and it is not covered with silicon nitride. **Bottom Left:** A scale drawing of the dual-polarization multi-chroic MKID device we propose to develop. **Bottom Right:** A schematic of the co-planar waveguide MKID we are developing. Photons from the sky are brought to the detector on a microstrip from the hybrid tee. These photons then couple to our resonator and are absorbed in the aluminum section of the CPW $\lambda/4$ resonator. **Top Right:** End-to-end electromagnetic simulations show the expected absorption efficiency is approximately 90% across the 150 GHz and the 235 GHz spectral bands.

ring-loaded corrugated feed. For our laboratory development work we will use a conical horn for simplicity and switch to profiled horns in the future. Profiled horns are easier to fabricate and they have been shown to perform like corrugated feeds.²⁵

2.1 Horn Coupling and RF Circuit

In our prototype design, a conical horn is used to feed each array element. Each horn is machined into a monolithic horn plate that also serves as both the top of the detector module and the mounting surface for the MKID arrays. The bottom plate, which closes the module, also contains backshorts, which are used to optimize photon coupling. Light emerging from the cylindrical waveguide is coupled to a broadband orthomode transducer (OMT). A choke around the exit aperture of the waveguide minimizes lateral leakage of the fields. The OMT is composed of two probe pairs, and it separates the incoming light into two linear polarizations. For example, one linear polarization couples to one pair of probes, and the wave then propagates through identical

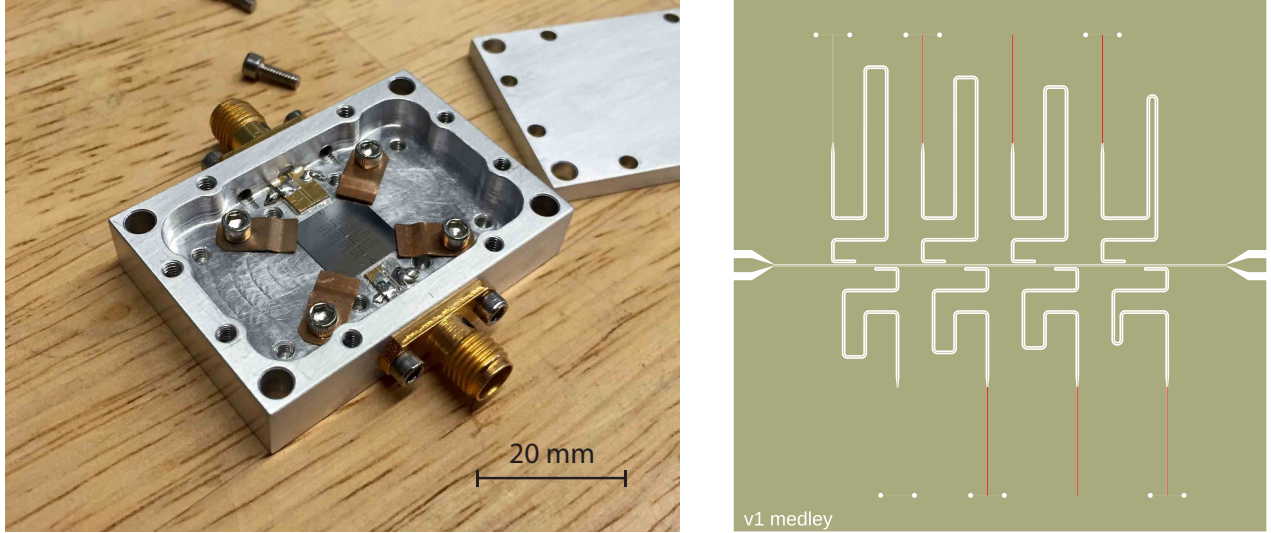

Figure 3. A photograph of our MKID test chip mounted inside an aluminum package designed for dark testing. The test chip layout is shown on the right. Each chip contains eight hybrid CPW MKIDs with different lengths and meander properties. The red elements are made from aluminum and the gray regions are niobium.

electrical paths in the subsequent millimeter-wave circuit en route to the MKID absorbing element. Along each path, a broadband CPW-to-microstrip transition composed of seven alternating sections of CPW and microstrip is first used to transition the radiation onto microstrip lines. Next, diplexers composed of two separate five-pole resonant-stub band-pass filters separate the radiation into 125 to 170 GHz and 190 to 280 GHz pass bands. The signals from opposite probes within a single sub-band are then combined onto a single microstrip line using the difference output of a hybrid tee. Signals at the sum output of the hybrid are routed to a termination resistor and discarded, while the output of the difference port is detected.

These polarimeters operate over a 2.25:1 ratio bandwidth over which cylindrical waveguide becomes multimoded. However, the TE₁₁ mode, which has the desirable polarization properties, couples to opposite fins of the OMT with a 180° phase shift while the higher order modes, which also couple efficiently to the OMT probes have a 0° phase shift. This phase difference allows the hybrid tee to isolate the TE₁₁ signal at the difference port and reject the unwanted modes at the sum port. This ensures single-moded performance over our 2.25:1 bandwidth. The architecture described above offers a frequency *independent* polarimeter axis defined by the orientation of the planar OMT. Figure 2 shows a schematic of our microstrip-to-CPW coupler. The the HFSS/Sonnet simulation results in this figure show the expected absorption efficiency of the detector is approximately 90% taking into account all of the elements in the circuit except the OMT probes.

2.2 MKID Design

The total instrument noise is the quadrature sum of the detector noise and the photon noise, and the fundamental performance goal is to achieve a sensitivity that is dominated by the random arrival of background photons. For an MKID, the detector noise includes contributions from three sources: generation-recombination (g-r) noise, two-level system (TLS) noise, and amplifier noise.¹ The g-r noise comes from the random recombination of quasiparticles. At typical operating temperatures and optical loads, quasiparticle generation noise is dominated by optical generation – the photon noise – and thermal generation is negligible. TLS noise is produced by dielectric fluctuations due to quantum two level systems in amorphous dielectric surface layers surrounding the MKID. The scaling of TLS noise with operating temperature, resonator geometry, and readout tone power and frequency has been extensively studied experimentally. We used a semi-empirical model²⁶ to design the resonators in order to reduce TLS noise. Finally, the amplifier noise is the electronic noise of the readout system, which is dominated by the cryogenic microwave low-noise amplifier. Our modeling of these noise sources indicates that

the detector sensitivity will be limited by photon noise under the 5–20 pW optical loads typically present for 150 GHz detectors in ground-based CMB experiments.

Our MKID design is based on a quarter-wavelength CPW resonator (see Figure 2 & 3). The design uses a hybrid CPW transmission line composed of two different metals. The ground plane is made of a superconductor with Cooper pair binding energy greater than the optical photon energy; our design uses niobium. Most of the CPW center trace is made from the same high-gap superconductor, except for a small active region adjacent to the grounded end. This active region is made from a lower-gap superconductor in which the optical photons can break Cooper pairs; our design uses aluminum. The quasiparticles excited by optical photons alter the dissipation and kinetic inductance of the device, and these changes are probed by a tone produced in the ROACH-based readout (see Section 2.4). Devices like these have achieved photon-noise-limited performance over a wide range of millimeter and sub-millimeter wavelengths with optical loading levels well under 1 pW.^{27,28}

Because of the gap difference, the quasiparticles are trapped in the active region, the volume of which can be reduced to increase the device responsivity. The active region of our baseline design is 2 mm long with an 8 μm wide aluminum center line and a 5 to 10 μm gap. Greater than 90% of the millimeter-wave power is dissipated here due to Cooper pairs breaking. The length of the second section varies from detector to detector because it is used to tune the resonant frequency. This section can have a much wider gap to the ground plane, which reduces TLS noise. In our baseline design, the second section of CPW is ~ 8 mm long with a 10 μm niobium center trace and a gap of 30 μm to the niobium ground plane. This ~ 10 mm length of transmission line will have a resonant frequency of approximately 3 GHz.

The millimeter-wave power is coupled from the microstrip output of the hybrid tee to the CPW of the MKID using a novel, broadband circuit developed by our collaboration²⁹ (see Figure 2). First, the power is evenly divided in-phase onto two microstrips each with twice the impedance of the incoming microstrip. Each branch feeds a standard broadband microstrip-to-slotline transition, where the slotline is formed in the niobium ground plane that is common to the microstrip and the MKID CPW. The two slotlines are then brought together and become the gaps of the CPW transmission line, efficiently coupling the radiation into the aluminum CPW center line, where it dissipates by exciting quasiparticles. The slotline is electrically short at the resonant frequency of the MKID, and thus it does not impact the microwave characteristics of the resonators.

2.3 Fabrication

The arrays will be fabricated on SOI wafers 100 mm in diameter. Each SOI wafer consist of a 5 μm thick silicon device layer and a 350 μm thick handling wafer held together by a 0.5 μm thick oxide layer. The MKID arrays are fabricated on the device layer, which is made of high-purity, float-zone silicon (>10 k Ω cm resistivity). The first metal deposition is a niobium film which is patterned to produce the ground plane and the OMT. The aluminum film that will form the MKID sensing element is then deposited after the niobium ground plane is patterned. The aluminum MKID element is co-planar with the niobium ground plane on the 5 μm thick silicon device layer. Silicon nitride is then deposited as an electrically insulating dielectric material, which will be used to form the substrate of the microstrip lines. A second niobium film is used to form the top microstrip line. Our design uses crossunders rather than crossovers, so a second silicon nitride and third niobium layer are not need. The layer of silicon nitride is removed to reduce loss and TLS noise. A gold film is deposited and patterned to construct the termination in the hybrid tee. The thick silicon handling wafer and the oxide underneath the OMT and the MKID will be removed using deep reactive ion etching (DRIE) to improve the bandwidth and the optical coupling and to minimize TLS noise.

2.4 Readout

All tests of the resonator performance are made by injecting sinusoidal tones near the resonant frequency of the MKID and measuring the amplitude and phase of the emerging waveform. To measure the resonant frequency and quality factor, the frequency of the sine wave is stepped through the resonance, effectively measuring the complex forward transmission (S_{21}) as with a vector network analyzer. Once the resonant frequency has been found from these sweeps, the probe tone frequency is tuned to this resonant frequency and a complex voltage time series is recorded. This time series can then be decomposed into fluctuations of the resonant frequency and of

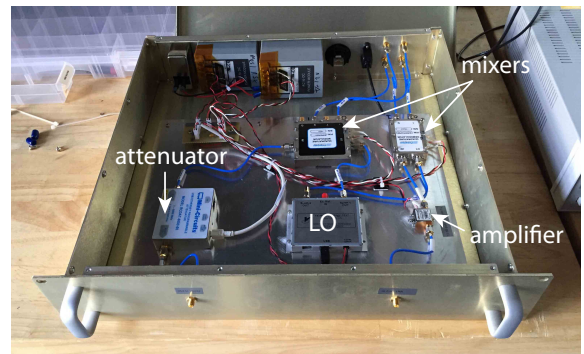
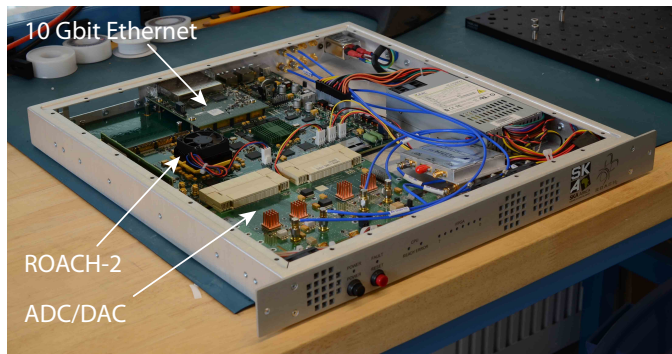
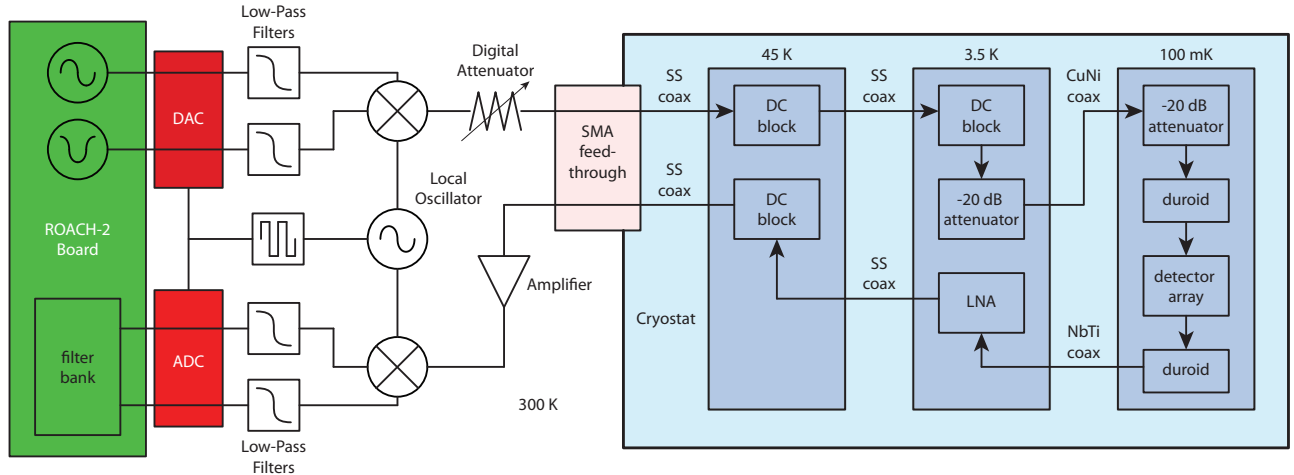

Figure 4. **Top:** Readout schematic showing the probe tone path. **Bottom Left:** The ROACH-2 with the DAC/ADC. **Bottom Right:** The analog signal conditioning hardware. This chassis houses the filters, room-temperature mixers, attenuator, warm amplifier, and the local oscillator shown in the schematic above.

the quality factor of the resonator. Standard spectral analysis is then used to determine the noise characteristics of the detector.

While all of the measurements just described can be done for a single resonator at a time using a microwave synthesizer and homodyne mixer, one of the major advantages of MKIDs is that a digital waveform generator and a digital filter bank and demodulator can be used to measure hundreds of resonators simultaneously by superimposing sine waves of different frequencies. Several such systems have been developed and deployed.³⁰ Many of these systems, including one developed at Columbia University for this work, are based around the CASPER ROACH-1 and ROACH-2 FPGA boards[†]. A schematic and photos of a ROACH-based read out system developed at Columbia are shown in Figure 4. Using this system, we can characterize hundreds of resonators simultaneously, so readout of the 80 resonators per prototype detector module is straightforward.

While the ROACH-1 is a robust and well-proven board, it is now several years old and is being superseded by the ROACH-2 board. We have ported our readout design to the ROACH-2, which allows us to read out over a thousand resonators at full bandwidth for extensive laboratory testing, and is suitable for deployment of a future large format array. We have designed an analog signal conditioning system based around Polyphase Microwave quadrature modulators and demodulators to convert the baseband signals generated and analyzed by the ROACH to the target 3–4 GHz readout band.

[†]<https://casper.berkeley.edu/>

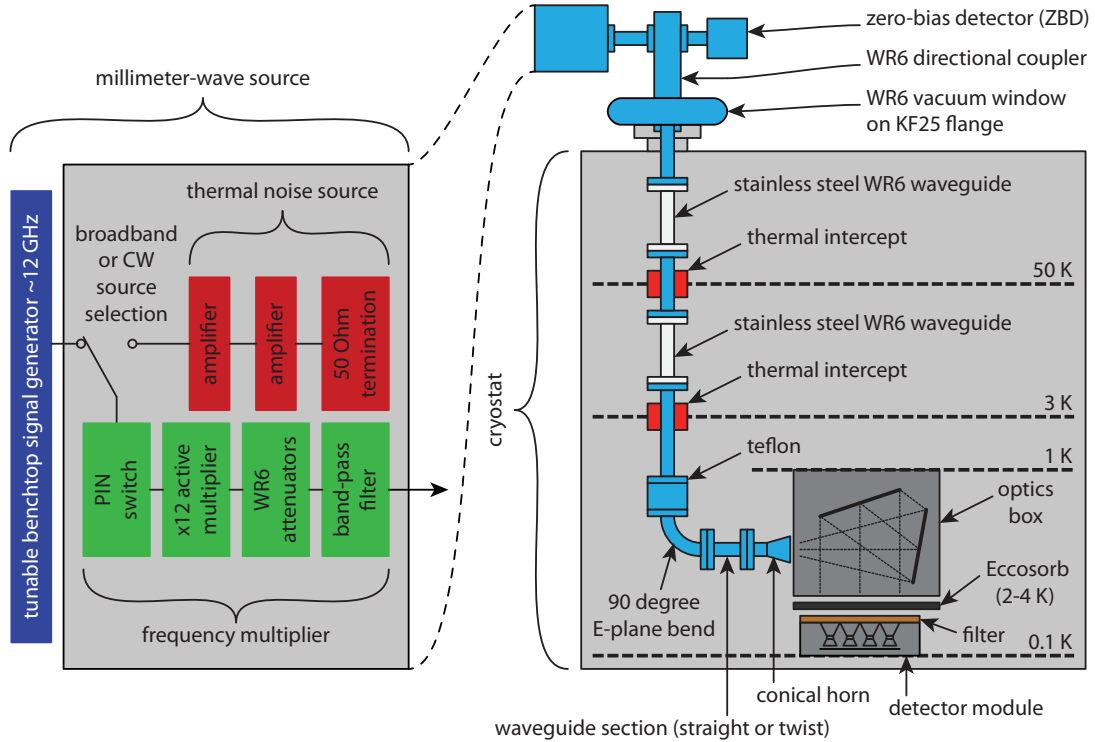

Figure 5. A schematic of the testing apparatus that is already successfully operating in the laboratory at Columbia. Millimeter-wave radiation is coupled into the cryostat using WR-6 waveguide, and this radiation illuminates the detector array via a horn and a collimating reflective optical assembly. The cold Eccosorb acts as both an attenuator and a diffuse background signal for the detectors. By changing the temperature of the Eccosorb we obtain an absolute brightness temperature calibration. We will use this existing setup to characterize the spectral response of the lower frequency band, and a similar ~ 235 GHz source will be constructed to test the high-frequency spectral band.

3. TESTING PLAN

To characterize the detector arrays, we will install them in superconducting aluminum detector packages and cool the assemblies to approximately 120 mK using the STAR Cryoelectronics DRC-100 cryostat system. This system includes a two-stage adiabatic demagnetization refrigerator (ADR) backed by a Cryomech PT-407 pulse tube cooler. We have developed and built a cryogenic optical test setup inside this cryostat, which is schematically described in Figure 5. The testing system consists of two main photon sources.

3.1 Millimeter-Wave Source

A millimeter-wave signal source, which is based on a Millitech active 12-times frequency multiplier, was built by the group at Columbia. The multiplier can be driven by a sweepable microwave signal generator, which is useful for measuring the frequency response of the detectors, or it can be driven by a broadband noise source to mimic a diffuse astrophysical background signal such as the CMB or Galactic dust emission. The input to the frequency multiplier is connected through a PIN diode switch, which allows the signals to be chopped on and off with sub-microsecond time resolution. This functionality provides a direct way of measuring the response time of the detectors. The millimeter-wave source is operated outside the cryostat at room temperature, and photons are brought to the detectors using WR-6 waveguide. The waveguide is passed into the cryostat through a vacuum waveguide window, and sections of stainless steel waveguide are used to decrease the thermal load on the cryogenic system. Inside the cryostat, the WR-6 waveguide feeds a horn (mounted at 4 K) and a small crossed-Dragone optics box (mounted at 1 K), which converts the diverging horn beam into a plane wave that illuminates the detectors. This configuration will be ideal for testing the 150 GHz spectral band of the detectors. To test the high frequency band, we will build a similar frequency multiplier-based source to cover the 190-280 GHz band.

To test the polarization response, we currently have interchangeable waveguide sections with 0° , 45° , and 90° twists to set the polarization angle of the radiation emitted from the horn in the cryostat. We are also building a small cryogenic rotateable half-wave plate that can be placed between the horn and the crossed-Dragone optics, allowing the polarization angle to be continuously adjusted without having to open the cryostat.

3.2 Cryogenic Blackbody

A slab of beam-filling Eccosorb absorber, which is coated with etched Teflon for impedance matching, serves as a cold diffuse blackbody load, and it is mounted directly in front of the horn apertures approximately 1 cm from the detector module. The temperature of the Eccosorb load is controlled using a heater resistor and a weak thermal link that is connected to either the 3 K stage of the pulse tube cooler or the 1 K stage of the ADR. By changing the temperature of this load we can measure the absolute brightness temperature calibration, which is used to compute the NET.

3.3 Measurements

The sources described above will allow us to extensively characterize our detectors. In particular, we will be able to measure: (i) calibrated NEP and NET under loading levels spanning 0.1-100 pW, which correspond to the loading expected for a wide range of experiments, including space-based, balloon-borne and ground-based telescopes, (ii) calibrated spectral response, both across the desired bands, but also including any undesired out-of-band response, (iii) detector response times to pulses of millimeter wavelength radiation at realistic sky loading levels, and (iv) the response of the detectors versus polarization angle of the incoming radiation, including both the co-polarization and cross-polarization response. All of these measurements will be directly compared to our design simulations and performance forecasts, providing the essential feedback needed to identify any issues to be corrected in subsequent wafer fabrication runs.

4. DISCUSSION

One of the primary goals of this project is to bring the functionality of MKIDs for CMB studies in line with state-of-the-art TES bolometers.³¹⁻³⁶ To date we have (i) designed the critical broadband microstrip-to-CPW coupler, (ii) modified the existing Advanced ACTPol design for SOL, (iii) fabricated MKID optimization chips, and (iv) developed several of the critical fabrication steps. We are currently dark testing the MKIDs and laying out our final array design. Prototype array fabrication will begin in the summer of 2016.

In the future, we plan on making the sensing element in the MKIDs out of aluminum manganese instead of aluminum. By adding manganese to the aluminum, the T_c of the sensor decreases in a controllable way,³⁷ which does two critical things. First and foremost, in our current 150 and 235 GHz spectral bands, the photons are energetic enough to break multiple Cooper pairs in the sensing element, so the detector noise will be suppressed below the photon noise – even for the low optical loads that are expected in a space-like environment. Second, a lower T_c makes the detector technology sensitive to lower frequencies, so this technology will open the door to low-frequency (~ 30 GHz) MKIDs in the future.

ACKNOWLEDGMENTS

This project is supported by a grant from the National Science Foundation (Award #1509211, #1509078, and #1506074) and a NASA/NESSF Fellowship for McCarrick.

REFERENCES

- [1] Zmuidzinas, J., “Superconducting Microresonators: Physics and Applications,” *Ann. Rev. Cond. Matt. Phys.* **3**, 169–214 (2012).

- [2] Thornton, R. J., Ade, P. A. R., Aiola, S., Angile, F. E., Amiri, M., Beall, J. A., Becker, D. T., Cho, H., Choi, S. K., Corlies, P., Coughlin, K. P., Datta, R., Devlin, M. J., Dicker, S. R., Dunner, R., Fowler, J. W., Fox, A. E., Gallardo, P. A., Gao, J., Grace, E., Halpern, M., Hasselfield, M., Henderson, S. W., Hilton, G. C., Hincks, A. D., Ho, S. P., Hubmayr, J., Irwin, K. D., Klein, J., Koopman, B., Li, D., Louis, T., Lungu, M., Maurin, L., McMahon, J., Munson, C. D., Naess, S., Nati, F., Newburgh, L., Nibarger, J., Niemack, M. D., Niraula, P., Nolta, M. R., Page, L. A., Pappas, C. G., Schillaci, A., Schmitt, B. L., Sehgal, N., Sievers, J. L., Simon, S. M., Staggs, S. T., Tucker, C., Uehara, M., van Lanen, J., Ward, J. T., and Wollack, E. J., “The Atacama Cosmology Telescope: The polarization-sensitive ACTPol instrument,” *ArXiv e-prints* (May 2016).
- [3] Niemack, M. D., Ade, P. A. R., Aguirre, J., Barrientos, F., Beall, J. A., Bond, J. R., Britton, J., Cho, H. M., Das, S., Devlin, M. J., Dicker, S., Dunkley, J., Dünner, R., Fowler, J. W., Hajian, A., Halpern, M., Hasselfield, M., Hilton, G. C., Hilton, M., Hubmayr, J., Hughes, J. P., Infante, L., Irwin, K. D., Jarosik, N., Klein, J., Kosowsky, A., Marriage, T. A., McMahon, J., Menanteau, F., Moodley, K., Nibarger, J. P., Nolta, M. R., Page, L. A., Partridge, B., Reese, E. D., Sievers, J., Spergel, D. N., Staggs, S. T., Thornton, R., Tucker, C., Wollack, E., and Yoon, K. W., “ACTPol: a polarization-sensitive receiver for the Atacama Cosmology Telescope,” in [*Society of Photo-Optical Instrumentation Engineers (SPIE) Conference Series*], *Society of Photo-Optical Instrumentation Engineers (SPIE) Conference Series* **7741** (July 2010).
- [4] Austermann, J. E., Aird, K. A., Beall, J. A., Becker, D., Bender, A., Benson, B. A., Bleem, L. E., Britton, J., Carlstrom, J. E., Chang, C. L., Chiang, H. C., Cho, H.-M., Crawford, T. M., Crites, A. T., Datesman, A., de Haan, T., Dobbs, M. A., George, E. M., Halverson, N. W., Harrington, N., Henning, J. W., Hilton, G. C., Holder, G. P., Holzzapfel, W. L., Hoover, S., Huang, N., Hubmayr, J., Irwin, K. D., Keisler, R., Kennedy, J., Knox, L., Lee, A. T., Leitch, E., Li, D., Lueker, M., Marrone, D. P., McMahon, J. J., Mehl, J., Meyer, S. S., Montroy, T. E., Natoli, T., Nibarger, J. P., Niemack, M. D., Novosad, V., Padin, S., Pryke, C., Reichardt, C. L., Ruhl, J. E., Saliwanchik, B. R., Sayre, J. T., Schaffer, K. K., Shirokoff, E., Stark, A. A., Story, K., Vanderlinde, K., Vieira, J. D., Wang, G., Williamson, R., Yefremenko, V., Yoon, K. W., and Zahn, O., “SPTpol: an instrument for CMB polarization measurements with the South Pole Telescope,” in [*Millimeter, Submillimeter, and Far-Infrared Detectors and Instrumentation for Astronomy VI*], *Proc. SPIE* **8452**, 84521E (Sept. 2012).
- [5] Henning, J. W., Ade, P., Aird, K. A., Austermann, J. E., Beall, J. A., Becker, D., Benson, B. A., Bleem, L. E., Britton, J., Carlstrom, J. E., Chang, C. L., Cho, H.-M., Crawford, T. M., Crites, A. T., Datesman, A., de Haan, T., Dobbs, M. A., Everett, W., Ewall-Wice, A., George, E. M., Halverson, N. W., Harrington, N., Hilton, G. C., Holzzapfel, W. L., Hubmayr, J., Irwin, K. D., Karfunkle, M., Keisler, R., Kennedy, J., Lee, A. T., Leitch, E., Li, D., Lueker, M., Marrone, D. P., McMahon, J. J., Mehl, J., Meyer, S. S., Montgomery, J., Montroy, T. E., Nagy, J., Natoli, T., Nibarger, J. P., Niemack, M. D., Novosad, V., Padin, S., Pryke, C., Reichardt, C. L., Ruhl, J. E., Saliwanchik, B. R., Sayre, J. T., Schaffer, K. K., Shirokoff, E., Story, K., Tucker, C., Vanderlinde, K., Vieira, J. D., Wang, G., Williamson, R., Yefremenko, V., Yoon, K. W., and Young, E., “Feedhorn-coupled TES polarimeter camera modules at 150 GHz for CMB polarization measurements with SPTpol,” in [*Society of Photo-Optical Instrumentation Engineers (SPIE) Conference Series*], *Society of Photo-Optical Instrumentation Engineers (SPIE) Conference Series* **8452**, 3 (Sept. 2012).
- [6] Bock, J., Aljabri, A., Amblard, A., Baumann, D., Betoule, M., Chui, T., Colombo, L., Cooray, A., Crumb, D., Day, P., Dickinson, C., Dowell, D., Dragovan, M., Golwala, S., Gorski, K., Hanany, S., Holmes, W., Irwin, K., Johnson, B., Keating, B., Kuo, C.-L., Lee, A., Lange, A., Lawrence, C., Meyer, S., Miller, N., Nguyen, H., Pierpaoli, E., Ponthieu, N., Puget, J.-L., Raab, J., Richards, P., Satter, C., Seiffert, M., Shimon, M., Tran, H., Williams, B., and Zmuidzinas, J., “Study of the Experimental Probe of Inflationary Cosmology (EPIC)-Intermediate Mission for NASA’s Einstein Inflation Probe,” *ArXiv e-prints* (June 2009).
- [7] Abazajian, K. N., Arnold, K., Austermann, J., Benson, B. A., Bischoff, C., Bock, J., Bond, J. R., Borrill, J., Buder, I., Burke, D. L., Calabrese, E., Carlstrom, J. E., Carvalho, C. S., Chang, C. L., Chiang, H. C., Church, S., Cooray, A., Crawford, T. M., Crill, B. P., Dawson, K. S., Das, S., Devlin, M. J., Dobbs, M., Dodelson, S., Doré, O., Dunkley, J., Feng, J. L., Fraisse, A., Gallicchio, J., Giddings, S. B., Green, D., Halverson, N. W., Hanany, S., Hanson, D., Hildebrandt, S. R., Hincks, A., Hlozek, R., Holder, G., Holzzapfel, W. L., Honscheid, K., Horowitz, G., Hu, W., Hubmayr, J., Irwin, K., Jackson, M., Jones, W. C., Kallosh, R., Kamionkowski, M., Keating, B., Keisler, R., Kinney, W., Knox, L., Komatsu, E., Kovac, J., Kuo, C.-L.,

- Kusaka, A., Lawrence, C., Lee, A. T., Leitch, E., Linde, A., Linder, E., Lubin, P., Maldacena, J., Martinec, E., McMahon, J., Miller, A., Mukhanov, V., Newburgh, L., Niemack, M. D., Nguyen, H., Nguyen, H. T., Page, L., Pryke, C., Reichardt, C. L., Ruhl, J. E., Sehgal, N., Seljak, U., Senatore, L., Sievers, J., Silverstein, E., Slosar, A., Smith, K. M., Spergel, D., Staggs, S. T., Stark, A., Stompor, R., Vieregg, A. G., Wang, G., Watson, S., Wollack, E. J., Wu, W. L. K., Yoon, K. W., Zahn, O., and Zaldarriaga, M., “Inflation Physics from the Cosmic Microwave Background and Large Scale Structure,” *ArXiv e-prints* (Sept. 2013).
- [8] Day, P. K., Leduc, H. G., Goldin, A., Vayonakis, T., Mazin, B. A., Kumar, S., Gao, J., and Zmuidzinas, J., “Antenna-coupled microwave kinetic inductance detectors,” *Nuclear Instruments and Methods in Physics Research A* **559**, 561–563 (Apr. 2006).
- [9] Schlaerth, J., Vayonakis, A., Day, P., Glenn, J., Gao, J., Golwala, S., Kumar, S., Leduc, H., Mazin, B., Vaillancourt, J., and Zmuidzinas, J., “A Millimeter and Submillimeter Kinetic Inductance Detector Camera,” *Journal of Low Temperature Physics* **151**, 684–689 (May 2008).
- [10] Golwala, S. R., Bockstiegel, C., Brugger, S., Czakon, N. G., Day, P. K., Downes, T. P., Duan, R., Gao, J., Gill, A. K., Glenn, J., Hollister, M. I., LeDuc, H. G., Maloney, P. R., Mazin, B. A., McHugh, S. G., Miller, D., Noroozian, O., Nguyen, H. T., Sayers, J., Schlaerth, J. A., Siegel, S., Vayonakis, A. K., Wilson, P. R., and Zmuidzinas, J., “Status of MUSIC, the MULTIWavelength Sub/millimeter Inductance Camera,” in [*Society of Photo-Optical Instrumentation Engineers (SPIE) Conference Series*], **8452** (Sept. 2012).
- [11] Doyle, S., Mauskopf, P., Naylon, J., Porch, A., and Duncombe, C., “Lumped Element Kinetic Inductance Detectors,” *Journal of Low Temperature Physics* **151**, 530–536 (Apr. 2008).
- [12] Monfardini, A., Benoit, A., Bideaud, A., Swenson, L., Cruciani, A., Camus, P., Hoffmann, C., Désert, F. X., Doyle, S., Ade, P., Mauskopf, P., Tucker, C., Roesch, M., Leclercq, S., Schuster, K. F., Endo, A., Baryshev, A., Baselmans, J. J. A., Ferrari, L., Yates, S. J. C., Bourrion, O., Macias-Perez, J., Vescovi, C., Calvo, M., and Giordano, C., “A Dual-band Millimeter-wave Kinetic Inductance Camera for the IRAM 30 m Telescope,” *Astrophys. J. Supp.* **194**, 24 (June 2011).
- [13] Mauskopf, P., Doyle, S., Barry, P., Rowe, S., Bidead, A., Ade, P., Tucker, C., Castillo, E., Monfardini, A., Goupy, J., and Calvo, M., “Photon-Noise Limited Performance in Aluminum LEKIDs,” *Journal of Low Temperature Physics*, 1–8 (2014).
- [14] McKenney, C., Leduc, H. G., Swenson, L. J., Day, P. K., Eom, B. H., and Zmuidzinas, J., “Design considerations for a background limited 350 micron pixel array using lumped element superconducting microresonators,” in [*Society of Photo-Optical Instrumentation Engineers (SPIE) Conference Series*], **84520S–84520S–10** (July 2012).
- [15] Hubmayr, J., Beall, J., Becker, D., Cho, H.-M., Devlin, M., Dober, B., Groppi, C., Hilton, G. C., Irwin, K. D., Li, D., Mauskopf, P., Pappas, D. P., Van Lanen, J., Vissers, M. R., and Gao, J., “Photon-noise limited sensitivity in titanium nitride kinetic inductance detectors,” *ArXiv e-prints* (June 2014).
- [16] Galitzki, N., Ade, P. A. R., Angilè, F. E., Ashton, P., Beall, J. A., Becker, D., Bradford, K. J., Che, G., Cho, H.-M., Devlin, M. J., Dober, B. J., Fissel, L. M., Fukui, Y., Gao, J., Groppi, C. E., Hillbrand, S., Hilton, G. C., Hubmayr, J., Irwin, K. D., Klein, J., van Lanen, J., Li, D., Li, Z.-Y., Lourie, N. P., Mani, H., Martin, P. G., Mauskopf, P., Nakamura, F., Novak, G., Pappas, D. P., Pascale, E., Pisano, G., Santos, F. P., Savini, G., Scott, D., Stanchfield, S., Tucker, C., Ullom, J. N., Underhill, M., Vissers, M. R., and Ward-Thompson, D., “The Next Generation BLAST Experiment,” *Journal of Astronomical Instrumentation* **3**, 1440001 (2014).
- [17] Dober, B. J., Ade, P. A. R., Ashton, P., Angilè, F. E., Beall, J. A., Becker, D., Bradford, K. J., Che, G., Cho, H.-M., Devlin, M. J., Fissel, L. M., Fukui, Y., Galitzki, N., Gao, J., Groppi, C. E., Hillbrand, S., Hilton, G. C., Hubmayr, J., Irwin, K. D., Klein, J., Van Lanen, J., Li, D., Li, Z.-Y., Lourie, N. P., Mani, H., Martin, P. G., Mauskopf, P., Nakamura, F., Novak, G., Pappas, D. P., Pascale, E., Santos, F. P., Savini, G., Scott, D., Stanchfield, S., Ullom, J. N., Underhill, M., Vissers, M. R., and Ward-Thompson, D., “The next-generation BLASTPol experiment,” in [*Society of Photo-Optical Instrumentation Engineers (SPIE) Conference Series*], *Society of Photo-Optical Instrumentation Engineers (SPIE) Conference Series* **9153**, 0 (July 2014).
- [18] Flanigan, D., McCarrick, H., Jones, G., Johnson, B. R., Abitbol, M. H., Ade, P., Araujo, D., Bradford, K., Cantor, R., Che, G., Day, P., Doyle, S., Kjellstrand, C. B., Leduc, H., Limon, M., Luu, V., Mauskopf, P., Miller, A., Mroczkowski, T., Tucker, C., and Zmuidzinas, J., “Photon noise from chaotic and coherent

- millimeter-wave sources measured with horn-coupled, aluminum lumped-element kinetic inductance detectors,” *Applied Physics Letters* **108**(8) (2016).
- [19] McCarrick, H., Flanigan, D., Jones, G., Johnson, B. R., Ade, P., Araujo, D., Bradford, K., Cantor, R., Che, G., Day, P., Doyle, S., Leduc, H., Limon, M., Luu, V., Mauskopf, P., Miller, A., Mroczkowski, T., Tucker, C., and Zmuidzinas, J., “Horn-coupled, commercially-fabricated aluminum lumped-element kinetic inductance detectors for millimeter wavelengths,” *Review of Scientific Instruments* **85**, 123117 (Dec. 2014).
- [20] Kovács, A., Barry, P. S., Bradford, C. M., Chattopadhyay, G., Day, P., Doyle, S., Hailey-Dunsheath, S., Hollister, M., McKenney, C., LeDuc, H. G., Lombart, N., Marrone, D. P., Mauskopf, P., O’Brien, R. C., Padin, S., Swenson, L. J., and Zmuidzinas, J., “SuperSpec: design concept and circuit simulations,” in [*Society of Photo-Optical Instrumentation Engineers (SPIE) Conference Series*], *Society of Photo-Optical Instrumentation Engineers (SPIE) Conference Series* **8452** (Sept. 2012).
- [21] Patel, A., Brown, A., Hsieh, W., Stevenson, T., Moseley, S., U-yen, K., Ehsan, N., Barrentine, E., Manos, G., and Wollack, E., “Fabrication of mkids for the microspec spectrometer,” *Applied Superconductivity, IEEE Transactions on* **23**, 2400404–2400404 (June 2013).
- [22] Baryshev, A., Baselmans, J., Yates, S., Ferrari, L., Bisigello, L., Janssen, R., Endo, A., Klapwijk, T., Klein, B., Heyminck, S., and Güsten, R., “Large Format Antenna Coupled Microwave Kinetic Inductance Detector Arrays for Radio Astronomy,” in [*IRMMW-THz 39*], (Sept. 2014).
- [23] Henderson, S. W., Allison, R., Ausermann, J., Baildon, T., Battaglia, N., Beall, J. A., Becker, D., De Bernardis, F., Bond, J. R., Calabrese, E., Choi, S. K., Coughlin, K. P., Crowley, K. T., Datta, R., Devlin, M. J., Duff, S. M., Dunkley, J., Dünner, R., van Engelen, A., Gallardo, P. A., Grace, E., Hasselfield, M., Hills, F., Hilton, G. C., Hincks, A. D., Hložek, R., Ho, S. P., Hubmayr, J., Huppenberger, K., Hughes, J. P., Irwin, K. D., Koopman, B. J., Kosowsky, A. B., Li, D., McMahon, J., Munson, C., Nati, F., Newburgh, L., Niemack, M. D., Niraula, P., Page, L. A., Pappas, C. G., Salatino, M., Schillaci, A., Schmitt, B. L., Sehgal, N., Sherwin, B. D., Sievers, J. L., Simon, S. M., Spergel, D. N., Staggs, S. T., Stevens, J. R., Thornton, R., Van Lanen, J., Vavagiakis, E. M., Ward, J. T., and Wollack, E. J., “Advanced ACTPol Cryogenic Detector Arrays and Readout,” *Journal of Low Temperature Physics* (Mar. 2016).
- [24] Datta, R., Hubmayr, J., Munson, C., Ausermann, J., Beall, J., Becker, D., Cho, H. M., Halverson, N., Hilton, G., Irwin, K., Li, D., McMahon, J., Newburgh, L., Nibarger, J., Niemack, M., Schmitt, B., Smith, H., Staggs, S., Van Lanen, J., and Wollack, E., “Horn Coupled Multichroic Polarimeters for the Atacama Cosmology Telescope Polarization Experiment,” *Journal of Low Temperature Physics* **176**, 670–676 (Sept. 2014).
- [25] Zeng, L., Bennett, C. L., Chuss, D. T., and Wollack, E. J., “A Low Cross-Polarization Smooth-Walled Horn With Improved Bandwidth,” *IEEE Transactions on Antennas and Propagation* **58**, 1383–1387 (Apr. 2010).
- [26] Gao, J., Daal, M., Martinis, J. M., Vayonakis, A., Zmuidzinas, J., Sadoulet, B., Mazin, B. A., Day, P. K., and Leduc, H. G., “A semiempirical model for two-level system noise in superconducting microresonators,” *Applied Physics Letters* **92**, 212504 (May 2008).
- [27] Janssen, R. M. J., Baselmans, J. J. A., Endo, A., Ferrari, L., Yates, S. J. C., Baryshev, A. M., and Klapwijk, T. M., “Performance of hybrid NbTiN-Al microwave kinetic inductance detectors as direct detectors for sub-millimeter astronomy,” in [*Society of Photo-Optical Instrumentation Engineers (SPIE) Conference Series*], *Society of Photo-Optical Instrumentation Engineers (SPIE) Conference Series* **9153**, 0 (July 2014).
- [28] Yates, S. J. C., Baselmans, J. J. A., Endo, A., Janssen, R. M. J., Ferrari, L., Diener, P., and Baryshev, A., “Photon noise limited radiation detection with lens-antenna coupled microwave kinetic inductance detectors,” *Appl. Phys. Lett.* **99**(7) (2011).
- [29] Surdi, H., *Applications of Kinetic Inductance: Parametric Amplifier & Phase Shifter, 2DEG Coupled Coplanar Structures & Microstrip to Slotline Transition at RF Frequencies*, PhD thesis, ARIZONA STATE UNIVERSITY (2016).
- [30] Duan, R., McHugh, S., Serfass, B., Mazin, B. A., Merrill, A., Golwala, S. R., Downes, T. P., Czakon, N. G., Day, P. K., Gao, J., Glenn, J., Hollister, M. I., Leduc, H. G., Maloney, P. R., Noroozian, O., Nguyen, H. T., Sayers, J., Schlaerth, J. A., Siegel, S., Vaillancourt, J. E., Vayonakis, A., Wilson, P. R., and Zmuidzinas, J., “An open-source readout for MKIDs,” in [*Society of Photo-Optical Instrumentation Engineers (SPIE) Conference Series*], **7741** (July 2010).

- [31] Ade, P. A. R., Aikin, R. W., Amiri, M., Barkats, D., Benton, S. J., Bischoff, C. A., Bock, J. J., Brevik, J. A., Buder, I., Bullock, E., Davis, G., Day, P. K., Dowell, C. D., Duband, L., Filippini, J. P., Fliescher, S., Golwala, S. R., Halpern, M., Hasselfield, M., Hildebrandt, S. R., Hilton, G. C., Irwin, K. D., Karkare, K. S., Kaufman, J. P., Keating, B. G., Kernasovskiy, S. A., Kovac, J. M., Kuo, C. L., Leitch, E. M., Llombart, N., Lueker, M., Netterfield, C. B., Nguyen, H. T., O’Brien, R., Ogburn, IV, R. W., Orlando, A., Pryke, C., Reintsema, C. D., Richter, S., Schwarz, R., Sheehy, C. D., Staniszewski, Z. K., Story, K. T., Sudiwala, R. V., Teply, G. P., Tolan, J. E., Turner, A. D., Vieregg, A. G., Wilson, P., Wong, C. L., Yoon, K. W., and Bicep2 Collaboration, “BICEP2. II. Experiment and three-year Data Set,” *Astrophys. J.* **792**, 62 (Sept. 2014).
- [32] Suzuki, A., Arnold, K., Edwards, J., Engargiola, G., Ghribi, A., Holzzapfel, W., Lee, A., Meng, X., Myers, M., O’Brien, R., Quealy, E., Rebeiz, G., and Richards, P., “Multi-chroic Dual-Polarization Bolometric Focal Plane for Studies of the Cosmic Microwave Background,” *Journal of Low Temperature Physics* **167**, 852–858 (June 2012).
- [33] Arnold, K., Ade, P. A. R., Anthony, A. E., Barron, D., Boettger, D., Borrill, J., Chapman, S., Chinone, Y., Dobbs, M. A., Errard, J., Fabbian, G., Flanigan, D., Fuller, G., Ghribi, A., Grainger, W., Halverson, N., Hasegawa, M., Hattori, K., Hazumi, M., Holzzapfel, W. L., Howard, J., Hyland, P., Jaffe, A., Keating, B., Kermish, Z., Kisner, T., Le Jeune, M., Lee, A. T., Linder, E., Lungu, M., Matsuda, F., Matsumura, T., Miller, N. J., Meng, X., Morii, H., Moyerman, S., Myers, M. J., Nishino, H., Paar, H., Quealy, E., Reichardt, C., Richards, P. L., Ross, C., Shimizu, A., Shimmin, C., Shimon, M., Sholl, M., Siritanasak, P., Spieler, H., Stebor, N., Steinbach, B., Stompor, R., Suzuki, A., Tomaru, T., Tucker, C., and Zahn, O., “The bolometric focal plane array of the POLARBEAR CMB experiment,” in [*Millimeter, Submillimeter, and Far-Infrared Detectors and Instrumentation for Astronomy VI*], *Proc. SPIE* **8452**, 84521D (Sept. 2012).
- [34] Kermish, Z. D., Ade, P., Anthony, A., Arnold, K., Barron, D., Boettger, D., Borrill, J., Chapman, S., Chinone, Y., Dobbs, M. A., Errard, J., Fabbian, G., Flanigan, D., Fuller, G., Ghribi, A., Grainger, W., Halverson, N., Hasegawa, M., Hattori, K., Hazumi, M., Holzzapfel, W. L., Howard, J., Hyland, P., Jaffe, A., Keating, B., Kisner, T., Lee, A. T., Le Jeune, M., Linder, E., Lungu, M., Matsuda, F., Matsumura, T., Meng, X., Miller, N. J., Morii, H., Moyerman, S., Myers, M. J., Nishino, H., Paar, H., Quealy, E., Reichardt, C. L., Richards, P. L., Ross, C., Shimizu, A., Shimon, M., Shimmin, C., Sholl, M., Siritanasak, P., Spieler, H., Stebor, N., Steinbach, B., Stompor, R., Suzuki, A., Tomaru, T., Tucker, C., and Zahn, O., “The POLARBEAR experiment,” in [*Society of Photo-Optical Instrumentation Engineers (SPIE) Conference Series*], *Society of Photo-Optical Instrumentation Engineers (SPIE) Conference Series* **8452** (Sept. 2012).
- [35] Rostem, K., Ali, A., Appel, J. W., Bennett, C. L., Chuss, D. T., Colazo, F. A., Crowe, E., Denis, K. L., Essinger-Hileman, T., Marriage, T. A., Moseley, S. H., Stevenson, T. R., Towner, D. W., U-Yen, K., and Wollack, E. J., “Scalable background-limited polarization-sensitive detectors for mm-wave applications,” in [*Society of Photo-Optical Instrumentation Engineers (SPIE) Conference Series*], *Society of Photo-Optical Instrumentation Engineers (SPIE) Conference Series* **9153**, 0 (July 2014).
- [36] Benson, B. A., Ade, P. A. R., Ahmed, Z., Allen, S. W., Arnold, K., Austermann, J. E., Bender, A. N., Bleem, L. E., Carlstrom, J. E., Chang, C. L., Cho, H. M., Cliche, J. F., Crawford, T. M., Cukierman, A., de Haan, T., Dobbs, M. A., Dutcher, D., Everett, W., Gilbert, A., Halverson, N. W., Hanson, D., Harrington, N. L., Hattori, K., Henning, J. W., Hilton, G. C., Holder, G. P., Holzzapfel, W. L., Irwin, K. D., Keisler, R., Knox, L., Kubik, D., Kuo, C. L., Lee, A. T., Leitch, E. M., Li, D., McDonald, M., Meyer, S. S., Montgomery, J., Myers, M., Natoli, T., Nguyen, H., Novosad, V., Padin, S., Pan, Z., Pearson, J., Reichardt, C., Ruhl, J. E., Saliwanchik, B. R., Simard, G., Smecher, G., Sayre, J. T., Shirokoff, E., Stark, A. A., Story, K., Suzuki, A., Thompson, K. L., Tucker, C., Vanderlinde, K., Vieira, J. D., Vikhlinin, A., Wang, G., Yefremenko, V., and Yoon, K. W., “SPT-3G: a next-generation cosmic microwave background polarization experiment on the South Pole telescope,” in [*Millimeter, Submillimeter, and Far-Infrared Detectors and Instrumentation for Astronomy VII*], *Proc. SPIE* **9153**, 91531P (July 2014).
- [37] Deiker, S. W., Doriese, W., Hilton, G. C., Irwin, K. D., Rippard, W. H., Ullom, J. N., Vale, L. R., Ruggiero, S. T., Williams, A., and Young, B. A., “Superconducting transition edge sensor using dilute AlMn alloys,” *Applied Physics Letters* **85**, 2137 (Sept. 2004).