

An introduction to Differential Linear Logic: proof-nets, models and antiderivatives

Thomas Ehrhard
CNRS, IRIF, UMR 8243
Univ Paris Diderot, Sorbonne Paris Cité F-75205 Paris, France

February 2016

Abstract

Differential Linear Logic enriches Linear Logic with additional logical rules for the exponential connectives, dual to the usual rules of dereliction, weakening and contraction. We present a proof-net syntax for Differential Linear Logic and a categorical axiomatization of its denotational models. We also introduce a simple categorical condition on these models under which a general antiderivative operation becomes available. Last we briefly describe the model of sets and relations and give a more detailed account of the model of finiteness spaces and linear and continuous functions.

Introduction

Extending Linear Logic (LL) with differential constructs has been considered by Girard at a very early stage of the design of this system. This option appears at various places in the conclusion of [Gir86], entitled *Two years of linear logic: selection from the garbage collector*. In Section *V.2 The quantitative attempt* of that conclusion, the idea of a syntactic Taylor expansion is explicitly mentioned as a syntactic counterpart of the quantitative semantics of the λ -calculus [Gir88]. However it is contemplated there as a reduction process rather than as a transformation on terms. In Section *V.5 The exponentials*, the idea of reducing λ -calculus substitution to a more elementary linear operation explicitly viewed as differentiation is presented as one of the basic intuitions behind the exponential of LL. The connection of this idea with Krivine's Machine [Kri85, Kri07] and its *linear head reduction* mechanism [DR99] is explicitly mentioned. In this mechanism, first considered by De Bruijn and called *mini-reduction* in [DB87], it is only the head occurrence of a variable which is substituted during reduction. This restriction is very meaningful in LL: the head occurrence is the only occurrence of a variable in a term which is linear.

LL is based on the distinction of particular proofs among all proofs, that are linear wrt. their hypotheses. The word *linear* has here two deeply related meanings.

- An algebraic meaning: a linear morphism is a function which preserves sums, linear combinations, joins, unions (depending on the context). In most denotational models of LL, linear proofs are interpreted as functions which are linear in that sense.
- An operational meaning: a proof is linear wrt. an hypothesis if the corresponding argument is used exactly once (neither erased nor duplicated) during cut-elimination.

LL has an essential operation, called *dereliction*, which allows one to turn a linear proof into a non linear one, or, more precisely, to forget the linearity of a proof. Differentiation, which in some sense is the converse of dereliction, since it turns a non linear morphism (proof) into a linear one, has not been included in LL at an early stage of its development.

We think that there are two deep reasons for that omission.

- First, differentiation seems fundamentally incompatible with *totality*, a denotational analogue of normalization usually considered as an essential feature of any reasonable logical system. Indeed, turning a non-linear proof into a linear one necessarily leads to a loss of information and to the production of *partial* linear proofs. This is typically what happens when one takes the derivative of a constant proof, which must produce a zero proof.
- Second, they seem incompatible with determinism because, when one linearizes a proof obtained by contracting two linear inputs of a proof, one has to choose between these two inputs, and there is no canonical way of doing so: we take the non-deterministic superposition of the two possibilities. Syntactically, this means that one must accept the possibility of adding proofs of the same formula, which is standard in mathematics, but hard to accept as a primitive logical operation on proofs (although it is present, in a tamed version, in the additive rules of LL).

The lack of totality is compatible with most mathematical interpretations of proofs and with most denotational models of LL: Scott domains (or more precisely, prime algebraic complete lattices, see [Hut93, Win04, Ehr12]), dI-domains, concrete data structures, coherence spaces, games, hypercoherence spaces etc. Moreover, computer scientists are acquainted with the use of syntactic partial objects (fix-point operators in programming languages, Böhm trees of the λ -calculus etc.) and various modern proof formalisms, such as Girard's Ludics, also incorporate partiality for enlarging the world of "proof-objects" so as to allow the simultaneous existence of "proofs" and "counter-proofs" in order to obtain a rich duality theory on top of which a notion of totality discriminating genuine proofs from partial proof-objects can be developed.

It is only when we observed that the differential extension of LL is the mirror image of the structural (and dereliction) rules of LL that we considered this extension as logically meaningful and worth being studied more deeply. The price to pay was the necessity of accepting an intrinsic non determinism and partiality in logic (these two extensions being related: failure is the neutral element of non-determinism), but the gain was a new viewpoint on the exponentials, related to the Taylor Formula of calculus.

In LL, the exponential is usually thought of as the modality of duplicable information. Linear functions are not allowed to copy their arguments and are therefore very limited in terms of computational expressive power, the exponential allows one to define non linear functions which can duplicate and erase their arguments and are therefore much more powerful. This duplication and erasure capability seems to be due to the presence of the rules of contraction and weakening in LL, but this is not quite true: the genuinely infinite rule of LL is promotion which makes a proof duplicable an arbitrary number of times, and erasable. This fact could not be observed in LL because promotion is the only rule of LL which allows one to introduce the “!” modality: without promotion, it is impossible to build a proof object that can be cut on a contraction or a weakening rule.

In Differential LL (DiLL), there are two new rules to introduce the “!” modality: *coweakening* and *codereliction*. The first of these rules allows one to introduce an empty proof of type $!A$ and the second one allows one to turn a proof of type A into a proof of type $!A$, *without making it duplicable* in sharp contrast with the promotion rule. The last new rule, called *cocontraction*, allows one to merge two proofs of type $!A$ for creating a new proof of type $!A$. This latter rule is similar to the *tensor* rule of ordinary LL with the difference that the two proofs glued together by a cocontraction must have the same type and cannot be distinguished anymore deterministically, whereas the two proofs glued by a tensor can be separated again by cutting the resulting proof against a *par* rule. These new rules are called *costructural* rules to stress the symmetry with the usual structural rules of LL.

DiLL has therefore a *finite* fragment which contains the standard “?” rules (weakening, contraction and dereliction) as well as the new “!” ones (coweakening, cocontraction and codereliction), but not the promotion rule. Cut elimination in this system generates sums of proofs, and therefore it is natural to endow proofs with a vector space (or module) structure over a field (or more generally over a semi-ring¹). This fragment has the following pleasant properties:

- It enjoys strong normalization, even in the untyped case, as long as one considers only proof-nets which satisfy a correctness criterion similar to the standard Danos-Regnier criterion for multiplicative LL (MLL).
- In this fragment, all proofs are linear combinations of “simple proofs” which do not contain linear combinations: this is possible because all the

¹This general setting allows us to cover also “qualitative” situations where sums of proofs are lubs in a poset.

syntactic constructions of this fragment are multilinear. So proofs are similar to polynomials or power series, simple proofs playing the role of monomials in this algebraic analogy which is strongly suggested by the denotational models of DiLL.

Moreover, it is possible to transform any instance of the promotion rule (which is applied to a sub-proof π) into an infinite linear combination of proofs containing copies of π : this is the Taylor expansion of promotion. This operation can be applied hereditarily to all instances of the promotion rule in a proof, giving rise to an infinite linear combinations of promotion-free DiLL simple proofs with positive rational coefficients.

Outline.

We start with a syntactic presentation of DiLL, in a proof-net formalism which uses terms instead of graphs (in the spirit of Abramsky’s linear chemical abstract machine [Abr93] or of the formalisms studied by Fernandez and Mackie, see for instance [FM99, MS08]) and we present a categorical formalism which allows us to describe denotational models of DiLL. We define the interpretation of proof-nets in such categories.

Then we shortly describe a differential λ -calculus formalism and we summarize some results, giving bibliographical references.

The end of the paper is devoted to concrete models of DiLL. We briefly review the relational model, which is based on the $*$ -autonomous category of sets and relations (with the usual cartesian product of sets as tensor product) because it underlies most denotational models of (differential) LL. Then we describe the *finiteness space* model which was one of our main motivations for introducing DiLL. We provide a thorough description of this model, insisting on various aspects which were not covered by our initial presentation in [Ehr05] such as *linear boundedness* (whose relevance in this semantical setting has been pointed out by Tasson in [Tas09b, Tas09a]), or the fact that function spaces in the Kleisli category admit an intrinsic description.

One important step in our presentation of the categorical setting for interpreting differential LL is the notion of an *exponential structure*. It is the categorical counterpart of the finitary fragment of DiLL, that is, the fragment DiLL_0 where the promotion rule is not required to hold.

An exponential structure consists of a preadditive² $*$ -autonomous category \mathcal{L} together with an operation which maps any object X of \mathcal{L} to an object $!X$ of \mathcal{L} equipped with a structure of \otimes -bialgebra (representing the structural and costructural rules) as well as a “dereliction” morphism in $\mathcal{L}(!X, X)$ and a “codereliction” morphism $\mathcal{L}(X, !X)$. The important point here is that the operation $X \mapsto !X$ is not assumed to be functorial (it has nevertheless to be a

²This means that the monoidal category is enriched over commutative monoids. Actually, we assume more generally that it is enriched over the category of \mathbf{k} -modules, where \mathbf{k} is a given semi-ring.

functor on isomorphisms). Using this simple structure, we define in particular morphisms $\bar{\partial}_X \in \mathcal{L}(!X \otimes X, !X)$ and $\partial_X \in \mathcal{L}(!X, !X \otimes X)$.

An element of $\mathcal{L}(!X, Y)$ can be considered as a non-linear morphism from X to Y (some kind of generalized polynomial, or analytical function), but these morphisms cannot be composed. It is nevertheless possible to define a notion of polynomial such morphism, and these polynomial morphisms can be composed, giving rise to a category which is cartesian if \mathcal{L} is cartesian.

By composition with $\bar{\partial}_X \in \mathcal{L}(!X \otimes X, !X)$, any element f of $\mathcal{L}(!X, Y)$ can be differentiated, giving rise to an element f' of $\mathcal{L}(!X \otimes X, Y)$ that we consider as its derivative³. This operation can be performed again, giving rise to $f'' \in \mathcal{L}(!X \otimes X \otimes X, Y)$ and, assuming that cocontraction is commutative, this morphism is symmetric in its two last linear parameters (a property usually known as *Shwarz Lemma*).

In this general context, a very natural question arises. Given a morphism $g \in \mathcal{L}(!X \otimes X, Y)$ whose derivative $g' \in \mathcal{L}(!X \otimes X \otimes X, Y)$ is symmetric, can one always find a morphism $f \in \mathcal{L}(!X, Y)$ such that $g = f'$? Inspired by the usual proof of *Poincaré's Lemma*, we show that such an *antiderivative* is always available as soon as the natural morphism $\text{Id}_{!X} + (\bar{\partial}_X \partial_X) \in \mathcal{L}(!X, !X)$ is an isomorphism for each object X . We explain how this property is related to a particular case of integration by parts. We also describe briefly a syntactic version of antiderivatives in a promotion-free differential λ -calculus.

To interpret the whole of DiLL, including the promotion rule, one has to assume that $!_-$ is an endofunctor on \mathcal{L} and that this functor is endowed with a structure of comonad and a monoidal structure; all these data have to satisfy some coherence conditions wrt. the exponential structure. These conditions are essential to prove that the interpretation of proof-nets is invariant under the various reduction rules, among which the most complicated one is an LL version of the usual *chain rule* of calculus. Our main references here are the work of Bierman [Bie95], Mellès [Mel09] and, for the commutations involving costructural logical rules, our concrete models [Ehr05, Ehr02], the categorical setting developed by Blute, Cockett and Seely [BCS06] and, very importantly, the work of Fiore [Fio07].

One major *a priori* methodological principle applied in this paper is to stick to *Classical Linear Logic*, meaning in particular that the categorical models we consider are $*$ -autonomous categories. This is justified by the fact that most of the concrete models we have considered so far satisfy this hypothesis (with the noticeable exception of [BET12]) and it is only in this setting that the new symmetries introduced by the differential and costructural rules appear clearly. A lot of material presented in this paper could probably be carried to a more general intuitionistic Linear Logic setting.

Some aspects of DiLL are only alluded to in this presentation, the most

³Or differential, or Jacobian: by monoidal closedness, f' can be seen as an element of $\mathcal{L}(!X, X \multimap Y)$ where $X \multimap Y$ is the object of morphisms from X to Y in \mathcal{L} , that is, of linear morphisms from X to Y , and the operation $f \mapsto f'$ satisfies all the ordinary properties of differentiation.

significant one being certainly the Taylor expansion formula and its connection with linear head reduction. On this topic, we refer to [ER08, ER06, Ehr10].

Note on this version.

A final version of this paper will appear in *Mathematical Structures in Computer Science*. The first version of this survey (already containing the material on antiderivatives) has been written in 2011 and has been improved and enriched since that time.

Notations

In this paper, a set of coefficients is needed, which has to be a commutative semi-ring. This set will be denoted as \mathbf{k} . In Section 4.3, \mathbf{k} will be assumed to be a field but this assumption is not needed before that section.

1 Syntax for DiLL proof-structures

We adopt a presentation of proof-structures and proof-nets which is based on terms and not on graphs. We believe that this presentation is more suitable to formalizable mathematical developments, although it sometimes gives rise to heavy notations, especially when one has to deal with the promotion rule (Section 1.5). We try to provide graphical intuitions on proof-structures by means of figures.

1.1 General constructions

1.1.1 Simple proof-structures.

Let \mathcal{V} be an infinite countable set of variables. This set is equipped with an involution $x \mapsto \bar{x}$ such that $x \neq \bar{x}$ for each $x \in \mathcal{V}$.

Let $u \subseteq \mathcal{V}$. An element x of u is *bound* in u if $\bar{x} \in u$. One says that u is *closed* if all the elements of u are bound in u . If x is not bound in u , one says that x is *free* in u .

Let Σ be a set of *tree constructors*, given together with an arity map $\text{ar} : \Sigma \rightarrow \mathbb{N}$.

Proof trees are defined as follows, together with their associated set of variables:

- if $x \in \mathcal{V}$ then x is a tree and $V(x) = \{x\}$;
- if $\varphi \in \Sigma_n$ (that is $\varphi \in \Sigma$ and $\text{ar}(\varphi) = n$) and if t_1, \dots, t_n are trees with $V(t_i) \cap V(t_j) = \emptyset$ for $i \neq j$, then $t = \varphi(t_1, \dots, t_n)$ is a tree with $V(t) = V(t_1) \cup \dots \cup V(t_n)$. As usual, when φ is binary, we often use the infix notation $t_1 \varphi t_2$ rather than $\varphi(t_1, t_2)$.

A *cut* is an expression $\langle t | t' \rangle$ where t and t' are trees such that $V(t) \cap V(t') = \emptyset$. We set $V(c) = V(t) \cup V(t')$.

A *simple proof-structure* is a pair $p = (\vec{c}; \vec{t})$ where \vec{t} is a list of proof trees and \vec{c} is a list of cuts, whose sets of variables are pairwise disjoint.

Remark: The order of the elements of \vec{c} does not matter; we could have used multisets instead of sequences. In the sequel, we consider these sequences of cuts up to permutation.

Bound variables of $V(p)$ can be renamed in the obvious way in p (rename simultaneously x and \bar{x} avoiding clashes with other variables which occur in p) and simple proof-structures are considered up to such renamings: this is α -conversion. Let $FV(p)$ be the set of free variables of p . We say p is closed if $FV(p) = \emptyset$.

The simplest simple proof-structure is of course $(;)$. A less trivial closed simple proof-structure is $(\langle x | \bar{x} \rangle ;)$ which is a loop.

1.1.2 LL types.

Let \mathcal{A} be a set of type atoms ranged over by α, β, \dots , together with an involution $\alpha \mapsto \bar{\alpha}$ such that $\bar{\bar{\alpha}} = \alpha$. Types are defined as follows.

- if $\alpha \in \mathcal{A}$ then α is a type;
- if A and B are types then $A \otimes B$ and $A \wp B$ are types;
- if A is a type then $!A$ and $?A$ are types.

The linear negation A^\perp of a type A is given by the following inductive definition: $\alpha^\perp = \bar{\alpha}$, $(A \otimes B)^\perp = A^\perp \wp B^\perp$; $(A \wp B)^\perp = A^\perp \otimes B^\perp$; $(!A)^\perp = ?A^\perp$ and $(?A)^\perp = !A^\perp$.

An MLL type is a type built using only the \otimes and \wp constructions⁴.

1.2 Proof-structures for MLL

Assume that $\Sigma_2 = \{\otimes, \wp\}$ and that $\text{ar}(\otimes) = \text{ar}(\wp) = 2$.

A *typing context* is a finite partial function Φ (of domain $D(\Phi)$) from \mathcal{V} to formulas such that $\Phi(\bar{x}) = (\Phi(x))^\perp$ whenever $x, \bar{x} \in D(\Phi)$.

1.2.1 Typing rules.

We first explain how to type MLL proof trees. The corresponding typing judgments of the form $\Phi \vdash_0 t : A$ where Φ is a typing context, t is a proof tree and A is a formula.

The rules are

$$\frac{}{\Phi, x : A \vdash_0 x : A}$$

⁴We do not consider the multiplicative constants 1 and \perp because they are not essential for our purpose.

$$\frac{\Phi \vdash_0 s : A \quad \Phi \vdash_0 t : B}{\Phi \vdash_0 s \otimes t : A \otimes B} \quad \frac{\Phi \vdash_0 s : A \quad \Phi \vdash_0 t : B}{\Phi \vdash_0 s \wp t : A \wp B}$$

Given a cut $c = \langle s | s' \rangle$ and a typing context Φ , one writes $\Phi \vdash_0 c$ if there is a type A such that $\Phi \vdash_0 s : A$ and $\Phi \vdash_0 s' : A^\perp$.

Last, given a simple proof-structure $p = (\vec{c}; \vec{s})$ with $\vec{s} = (s_1, \dots, s_n)$ and $\vec{c} = (c_1, \dots, c_k)$, a sequence $\Gamma = (A_1, \dots, A_l)$ of formulas and a typing context Φ , one writes $\Phi \vdash_0 p : \Gamma$ if $l = n$ and $\Phi \vdash_0 s_i : A_i$ for $1 \leq i \leq n$ and $\Phi \vdash_0 c_i$ for $1 \leq i \leq k$.

1.2.2 Logical judgments.

A logical judgment is an expression $\Phi \vdash p : \Gamma$ where Φ is a typing context, p is a simple proof-structure and Γ is a list of formulas.

If one can infer that $\Phi \vdash p : \Gamma$, this means that the proof-structure p represents a proof of Γ . Observe that the inference rules coincide with the rules of the MLL sequent calculus.

We give now these logical rules.

$$\frac{}{\Phi, x : A, \bar{x} : A^\perp \vdash (; x, \bar{x}) : A, A^\perp} \text{ axiom}$$

$$\frac{\Phi \vdash (\vec{c}; t_1, \dots, t_n) : A_1, \dots, A_n}{\Phi \vdash (\vec{c}; t_{\sigma(1)}, \dots, t_{\sigma(n)}) : A_{\sigma(1)}, \dots, A_{\sigma(n)}} \text{ permutation rule, } \sigma \in \mathfrak{S}_n$$

$$\frac{\Phi \vdash (\vec{c}; \vec{s}, s) : \Gamma, A \quad \Phi \vdash (\vec{d}; \vec{t}, t) : \Delta, A^\perp}{\Phi \vdash (\vec{c}, \vec{d}, \langle s | t \rangle; \vec{s}, \vec{t}) : \Gamma, \Delta} \text{ cut rule}$$

$$\frac{\Phi \vdash (\vec{c}; \vec{t}, s, t) : \Gamma, A, B}{\Phi \vdash (\vec{c}; \vec{t}, s \wp t) : \Gamma, A \wp B} \wp\text{-rule}$$

$$\frac{\Phi \vdash (\vec{c}; \vec{s}, s) : \Gamma, A \quad \Phi \vdash (\vec{d}; \vec{t}, t) : \Delta, B}{\Phi \vdash (\vec{c}, \vec{d}; \vec{s}, \vec{t}, s \otimes t) : \Gamma, \Delta, A \otimes B} \otimes\text{-rule}$$

We add the mix rule for completeness because it is quite natural denotationally. Notice however that it is not necessary. In particular, mix-free proof-nets are closed under cut elimination.

$$\frac{\Phi \vdash (\vec{c}; \vec{s}) : \Gamma \quad \Phi \vdash (\vec{d}; \vec{t}) : \Delta}{\Phi \vdash (\vec{c}, \vec{d}; \vec{s}, \vec{t}) : \Gamma, \Delta} \text{ mix rule}$$

Lemma 1 *If $\Phi \vdash p : \Gamma$ then $\Phi \vdash_0 p : \Gamma$ and $\mathcal{V}(p)$ is closed.*

Proof.

Straightforward induction on derivations. □

1.3 Reducing proof-structures

The basic reductions concern cuts, and are of the form

$$c \rightsquigarrow_{\text{cut}} (\vec{d}; \vec{t})$$

where c is a cut, $\vec{d} = (d_1, \dots, d_n)$ is a sequence of cuts and $\vec{t} = (t_1, \dots, t_k)$ is a sequence of trees.

With similar notational conventions, here are the deduction rules for the reduction of MLL proof-structures.

$$\frac{c \rightsquigarrow_{\text{cut}} (\vec{d}; \vec{t})}{(c, \vec{b}; \vec{s}) \rightsquigarrow_{\text{cut}} (\vec{d}, \vec{b}; \vec{s}, \vec{t})} \quad \text{context}$$

$$\frac{\bar{x} \notin V(s)}{\langle x | s \rangle, \vec{c}; \vec{t} \rightsquigarrow_{\text{cut}} (\vec{c}; \vec{t}) [s/\bar{x}]} \quad \text{ax-cut}$$

For applying the latter rule (see Figure 3), we assume that $\bar{x} \notin V(s)$. Without this restriction, we would reduce the cyclic proof-structure $(\langle x | \bar{x} \rangle;)$ to $(;)$ and erase the cycle which is certainly not acceptable from a semantic viewpoint. For instance, in a model of proof-structures based on finite dimension vector spaces, the semantics of $(\langle x | \bar{x} \rangle;)$ would be the dimension of the space interpreting the type of x (trace of the identity).

Remark: We provide some pictures to help understand the reduction rules on proof structures. In these pictures, logical proof-net constructors (such as *tensor*, *par* etc.) are represented as white triangles labeled by the corresponding symbol – they correspond to the *cells* of interaction nets or to the *links* of proof-nets – and subtrees are represented as gray triangles.

Wires represent the edges of a proof tree. We also represent axioms and cuts as wires: an axiom looks like \cap and a cut looks like \sqcup . In Figure 3, we indicate the variables associated with the axiom, but in the next pictures, this information will be kept implicit.

Figure 1 represents the simple proof-structure

$$p = (\langle s_1 | s'_1 \rangle, \dots, \langle s_n | s'_n \rangle; t_1, \dots, t_k).$$

with free variables x_1, \dots, x_l . The box named *axiom links* contains axioms connecting variables occurring in the trees $s_1, \dots, s_n, s'_1, \dots, s'_n, t_1, \dots, t_k$. When we do not want to be specific about its content, we represent such a simple proof-structure as in Figure 2 by a gray box with indices $1, \dots, k$ on its border for locating the roots of the trees of p . The same kind of notation will be used also for proof-structures which are not necessarily simple, see the beginning of Paragraph 1.4.3 for this notion.

In MLL, we have only one basic reduction (see Figure 4):

$$\langle s_1 \wp s_2 | t_1 \otimes t_2 \rangle \rightsquigarrow_{\text{cut}} (\langle s_1 | t_1 \rangle, \langle s_2 | t_2 \rangle;)$$

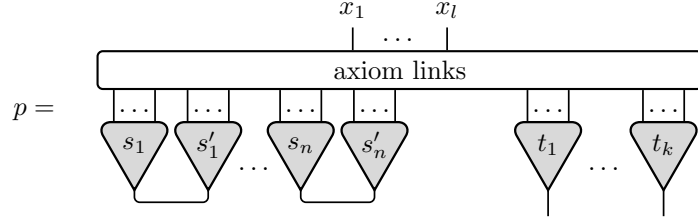

Figure 1: A simple proof-structure

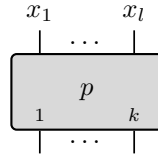

Figure 2: A synthetic representation of the proof-structure of Figure 1

1.4 DiLL₀

This is the promotion-free fragment of differential LL. In DiLL₀, one extends the signature of MLL with new constructors:

- $\Sigma_0 = \{w, \bar{w}\}$, called respectively *weakening* and *coweakening*.
- $\Sigma_1 = \{d, \bar{d}\}$, called respectively *dereliction* and *codereliction*.
- $\Sigma_2 = \{\wp, \otimes, c, \bar{c}\}$, the two new constructors being called respectively *contraction* and *cocontraction*.
- $\Sigma_n = \emptyset$ for $n > 2$.

1.4.1 Typing rules.

The typing rules for the four first constructors are similar to those of MLL.

$$\frac{}{\Phi \vdash_0 w : ?A} \quad \frac{}{\Phi \vdash_0 \bar{w} : !A}$$

$$\frac{\Phi \vdash_0 t : A}{\Phi \vdash_0 d(t) : ?A} \quad \frac{\Phi \vdash_0 t : A}{\Phi \vdash_0 \bar{d}(t) : !A}$$

The two last rules require the subtrees to have the same type.

$$\frac{\Phi \vdash_0 s_1 : ?A \quad \Phi \vdash_0 s_2 : ?A}{\Phi \vdash_0 c(s_1, s_2) : ?A} \quad \frac{\Phi \vdash_0 s_1 : !A \quad \Phi \vdash_0 s_2 : !A}{\Phi \vdash_0 \bar{c}(s_1, s_2) : !A}$$

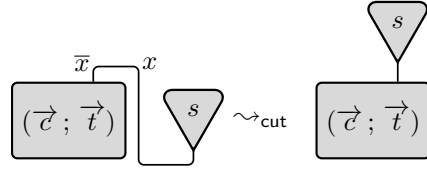

Figure 3: The axiom/cut reduction

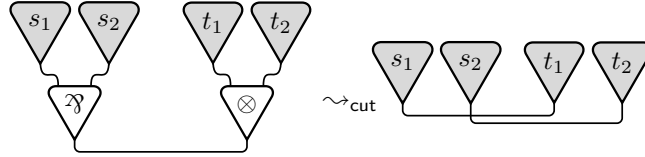

Figure 4: The tensor/par reduction

1.4.2 Logical rules.

The additional logical rules are as follows.

$$\begin{array}{c}
 \frac{\Phi \vdash (\vec{c}; \vec{s}) : \Gamma}{\Phi \vdash (\vec{c}; \vec{s}, w) : \Gamma, ?A} \quad \text{weakening} \quad \frac{}{\Phi \vdash (; \bar{w}) : !A} \quad \text{co-weakening} \\
 \\
 \frac{\Phi \vdash (\vec{c}; \vec{s}, s) : \Gamma, A}{\Phi \vdash (\vec{c}; \vec{s}, d(s)) : \Gamma, ?A} \quad \text{dereliction} \\
 \\
 \frac{\Phi \vdash (\vec{c}; \vec{s}, s) : \Gamma, A}{\Phi \vdash (\vec{c}; \vec{s}, \bar{d}(s)) : \Gamma, !A} \quad \text{co-dereliction} \\
 \\
 \frac{\Phi \vdash (\vec{c}; \vec{s}, s_1, s_2) : \Gamma, ?A, ?A}{\Phi \vdash (\vec{c}; \vec{s}, c(s_1, s_2)) : \Gamma, ?A} \quad \text{contraction} \\
 \\
 \frac{\Phi \vdash (\vec{c}; \vec{s}, s) : \Gamma, !A \quad \Phi \vdash (\vec{d}; \vec{t}, t) : \Delta, !A}{\Phi \vdash (\vec{c}, \vec{d}; \vec{s}, \vec{t}, \bar{c}(s, t)) : \Gamma, \Delta, !A} \quad \text{co-contraction}
 \end{array}$$

1.4.3 Reduction rules.

To describe the reduction rules associated with these new constructions, we need to introduce formal sums (or more generally \mathbf{k} -linear combinations) of simple proof-structures called *proof-structures* in the sequel, and denoted with capital letters P, Q, \dots . Such an extension by linearity of the syntax was already present in [ER03].

The empty linear combination 0 is a particular proof-structure which plays an important role. As linear combinations, proof-structures can be linearly combined.

The typing rule for linear combinations is



Figure 5: Weakening/coweakening reduction

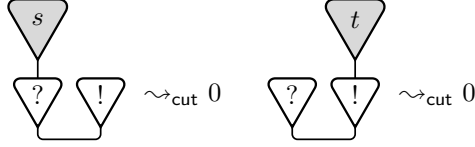

Figure 6: Dereliction/coweakening and weakening/codereliction reductions

$$\frac{\forall i \in \{1, \dots, n\} \quad \Phi \vdash p_i : \Gamma \text{ and } \mu_i \in \mathbf{k}}{\Phi \vdash \sum_{i=1}^n \mu_i p_i : \Gamma} \quad \text{sum}$$

The new basic reduction rules are:

$$\begin{aligned} \langle \mathbf{w} \mid \bar{\mathbf{w}} \rangle &\rightsquigarrow_{\text{cut}} (;) \quad \text{see Figure 5.} \\ \langle \mathbf{d}(s) \mid \bar{\mathbf{w}} \rangle &\rightsquigarrow_{\text{cut}} 0 \\ \langle \mathbf{w} \mid \bar{\mathbf{d}}(t) \rangle &\rightsquigarrow_{\text{cut}} 0 \quad \text{see Figure 6.} \\ \langle \mathbf{c}(s_1, s_2) \mid \bar{\mathbf{w}} \rangle &\rightsquigarrow_{\text{cut}} (\langle s_1 \mid \bar{\mathbf{w}} \rangle, \langle s_2 \mid \bar{\mathbf{w}} \rangle ;) \\ \langle \mathbf{w} \mid \bar{\mathbf{c}}(t_1, t_2) \rangle &\rightsquigarrow_{\text{cut}} (\langle \mathbf{w} \mid t_1 \rangle, \langle \mathbf{w} \mid t_2 \rangle ;) \quad \text{see Figure 7.} \\ \langle \mathbf{d}(s) \mid \bar{\mathbf{d}}(t) \rangle &\rightsquigarrow_{\text{cut}} (\langle s \mid t \rangle ;) \quad \text{see Figure 8.} \\ \langle \mathbf{c}(s_1, s_2) \mid \bar{\mathbf{d}}(t) \rangle &\rightsquigarrow_{\text{cut}} (\langle s_1 \mid \bar{\mathbf{d}}(t) \rangle, \langle s_2 \mid \bar{\mathbf{w}} \rangle ;) + (\langle s_1 \mid \bar{\mathbf{w}} \rangle, \langle s_2 \mid \bar{\mathbf{d}}(t) \rangle ;) \\ \langle \mathbf{d}(s) \mid \bar{\mathbf{c}}(t_1, t_2) \rangle &\rightsquigarrow_{\text{cut}} (\langle \mathbf{d}(s) \mid t_1 \rangle, \langle \mathbf{w} \mid t_2 \rangle ;) + (\langle \mathbf{w} \mid t_1 \rangle, \langle \mathbf{d}(s) \mid t_2 \rangle ;) \end{aligned}$$

see Figure 9.

$$\begin{aligned} \langle \mathbf{c}(s_1, s_2) \mid \bar{\mathbf{c}}(t_1, t_2) \rangle \\ \rightsquigarrow_{\text{cut}} (\langle s_1 \mid \bar{\mathbf{c}}(x_{11}, x_{12}) \rangle, \langle s_2 \mid \bar{\mathbf{c}}(x_{21}, x_{22}) \rangle, \langle \mathbf{c}(\bar{x}_{11}, \bar{x}_{21}) \mid t_1 \rangle, \langle \mathbf{c}(\bar{x}_{12}, \bar{x}_{22}) \mid t_2 \rangle ;) \end{aligned}$$

see Figure 10.

In the last reduction rule, the four variables that we introduce are pairwise distinct and fresh. Up to α -conversion, the choice of these variables is not relevant.

The contextual rule must be extended, in order to take sums into account.

$$\frac{c \rightsquigarrow_{\text{cut}} P}{(c, \vec{b} ; \vec{s}) \rightsquigarrow_{\text{cut}} \sum_{p=(\vec{c}; \vec{t})} P_p \cdot (\vec{c}, \vec{b} ; \vec{s}, \vec{t})} \quad \text{context}$$

Remark: In the premise of this rule, P is a linear combination of proof-structures, so that for a given proof-structure $p = (\vec{c}; \vec{t})$, $P_p \in \mathbf{k}$ is the coefficient of the proof-structure p in this linear combination P . The sum which appears in the conclusion ranges over all possible proof-structures p , but there are only finitely many p 's such that $P_p \neq 0$ so that this sum is actually finite. A particular case of this rule is $c \rightsquigarrow_{\text{cut}} 0 \Rightarrow (c, \vec{b} ; \vec{s}) \rightsquigarrow_{\text{cut}} 0$.

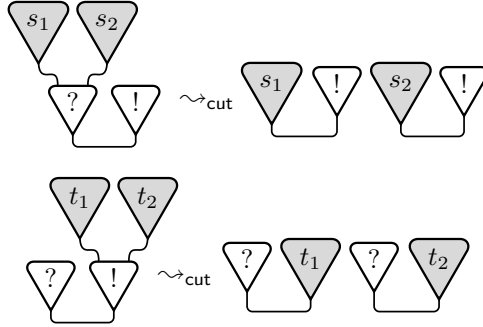

Figure 7: Contraction/coweakening and weakening/cocontraction reductions

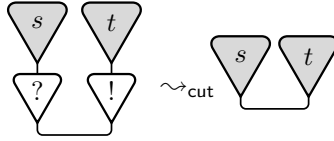

Figure 8: Dereliction/codereliction reduction

1.5 Promotion

Let $p = (\vec{c}; \vec{s})$ be a simple proof-structure. The *width* of p is the number of elements of the sequence \vec{s} .

By definition, a proof-structure of width n is a finite linear combination of simple proof-structures of width n .

Observe that 0 is a proof-structure of width n for all n .

Let P be a proof-structure⁵ of width $n+1$. We introduce a new constructor⁶ called *promotion box*, of arity n :

$$P^{!(n)} \in \Sigma_n.$$

The presence of n in the notation is useful only in the case where $P = 0$ so it can most often be omitted. The use of a non necessarily simple proof structure P in this construction is crucial: promotion is not a linear construction and is actually the only non linear construction of (differential) LL.

So if t_1, \dots, t_n are trees, $P^{!(n)}(t_1, \dots, t_n)$ is a tree. Pictorially, this tree will typically be represented as in Figure 11. A simple net p appearing in P is typically of the form $(\vec{c}; \vec{s})$ and its width is $n+1$, so that $\vec{s} = (s_1, \dots, s_n, s)$. The indices $1, \dots, n$ and \bullet which appear on the gray rectangle representing P stand for the roots of these trees s_1, \dots, s_n and s .

⁵To be completely precise, we should also provide a typing environment for the free variables of P ; this can be implemented by equipping each variable with a type.

⁶The definitions of the syntax of proof trees and of the signature Σ are mutually recursive when promotion is taken into account.

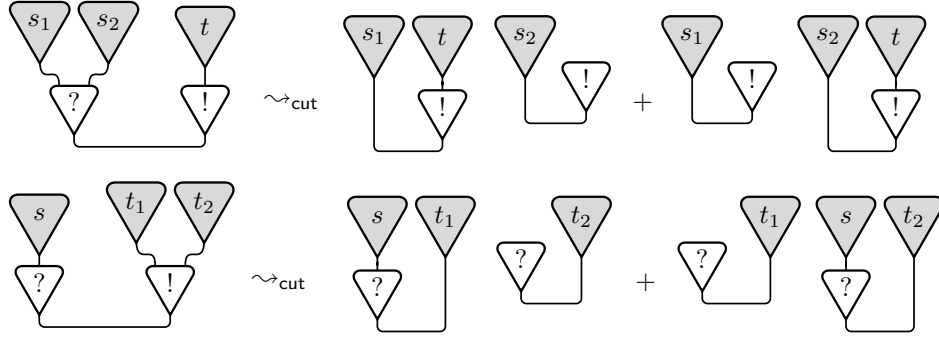

Figure 9: Contraction/codereliction and dereliction/cocontraction reductions

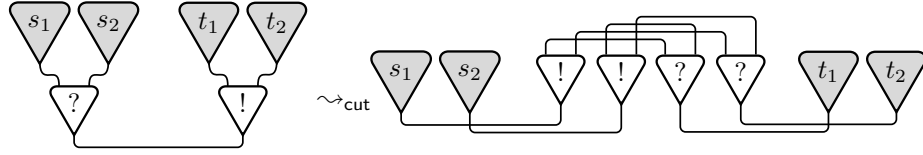

Figure 10: Contraction/cocontraction reduction

1.5.1 Typing rule.

The typing rule for this construction is

$$\frac{\Phi \vdash_0 P : ?A_1^\perp, \dots, ?A_n^\perp, B \quad \Phi \vdash_0 t_i : !A_i \quad (i = 1, \dots, n)}{\Phi \vdash_0 P^{!(n)}(t_1, \dots, t_n) : !B}$$

1.5.2 Logical rule.

The logical rule associated with this construction is the following.

$$\frac{\Phi \vdash P : ?A_1^\perp, \dots, ?A_n^\perp, B \quad \Phi \vdash (\vec{c}_i^\rightarrow; \vec{t}_i^\rightarrow, t_i) : \Gamma_i, !A_i \quad (i = 1, \dots, n)}{\Phi \vdash (\vec{c}_1^\rightarrow, \dots, \vec{c}_n^\rightarrow; \vec{t}_1^\rightarrow, \dots, \vec{t}_n^\rightarrow, P^{!(n)}(t_1, \dots, t_n)) : \Gamma_1, \dots, \Gamma_n, !B}$$

Remark: This promotion rule is of course highly debatable. We choose this presentation because it is compatible with our tree-based presentation of proof-structures.

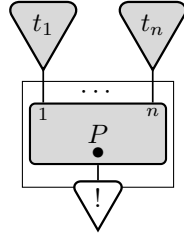

Figure 11: Graphical representation of a tree whose outermost constructor is a promotion box

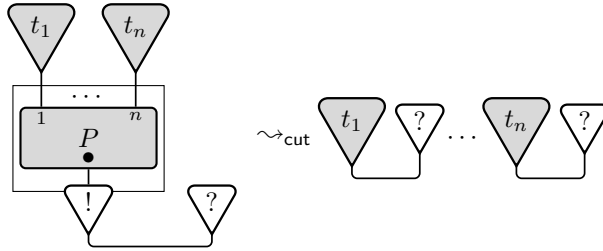

Figure 12: Promotion/weakening reduction

1.5.3 Cut elimination rules.

The basic reductions associated with promotion are as follows.

$$\langle P^{l(n)}(t_1, \dots, t_n) \mid \mathbf{w} \rangle \rightsquigarrow_{\text{cut}} (\langle t_1 \mid \mathbf{w} \rangle, \dots, \langle t_n \mid \mathbf{w} \rangle ;) \quad \text{see Figure 12.}$$

$$\langle P^{l(n)}(t_1, \dots, t_n) \mid \mathbf{d}(s) \rangle \rightsquigarrow_{\text{cut}} \sum_{p=(\vec{c}; \vec{s}, s')} P_p \cdot (\vec{c}, \langle s_1 \mid t_1 \rangle, \dots, \langle s_n \mid t_n \rangle, \langle s' \mid s \rangle ;)$$

see Figure 13.

$$\langle P^{l(n)}(t_1, \dots, t_n) \mid \mathbf{c}(s_1, s_2) \rangle \rightsquigarrow_{\text{cut}} (\langle P^{l(n)}(x_1, \dots, x_n) \mid s_1 \rangle, \langle P^{l(n)}(y_1, \dots, y_n) \mid s_2 \rangle, \langle t_1 \mid \mathbf{c}(\overline{x_1}, \overline{y_1}) \rangle, \dots, \langle t_n \mid \mathbf{c}(\overline{x_n}, \overline{y_n}) \rangle ;)$$

see Figure 14.

In the second reduction rule, one has to avoid clashes of variables.

In the last reduction rules, the variables x_1, \dots, x_n and y_1, \dots, y_n that we introduce together with their covariables are assumed to be pairwise distinct and fresh. Up to α -conversion, the choice of these variables is not relevant.

1.5.4 Commutative reductions.

There are also auxiliary reduction rules sometimes called *commutative reductions* which do not deal with cuts — at least in the formalization of nets we present here.

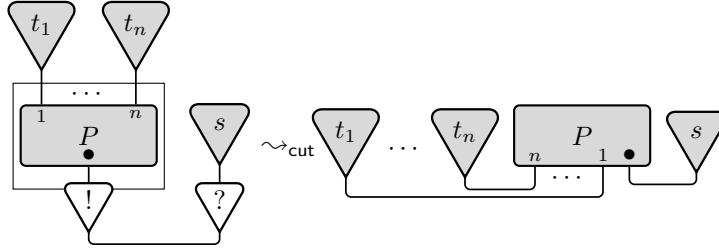

Figure 13: Promotion/dereliction reduction

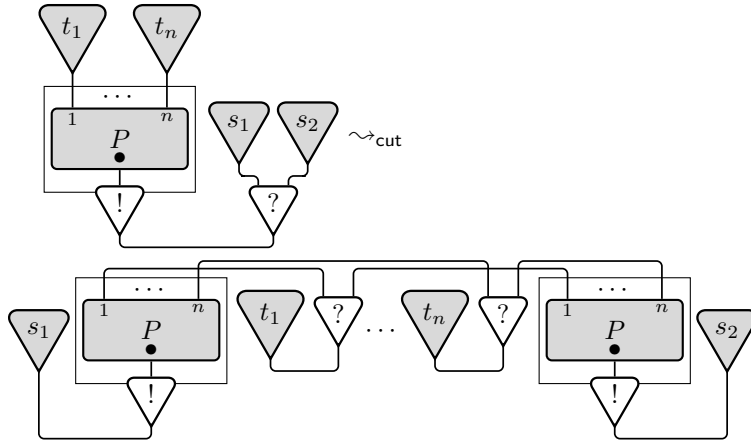

Figure 14: Promotion/contraction reduction

The format of these reductions is

$$t \rightsquigarrow_{\text{com}} P$$

where t is a simple tree and P is a (not necessarily simple) proof-structure whose width is exactly 1.

The first of these reductions is illustrated in Figure 15 and deals with the interaction between two promotions.

$$P^{l(n+1)}(t_1, \dots, t_{i-1}, Q^{l(k)}(t_i, \dots, t_{k+i-1}), t_{k+i}, \dots, t_{k+n}) \rightsquigarrow_{\text{com}} (; R^{l(k+n)}(t_1, \dots, t_{k+n})) \quad (1)$$

where

$$R = \sum_{p=(\vec{c}; s_1, \dots, s_{n+1}, s)} P_p \cdot (\vec{c}, \langle s_i \mid Q^{l(k)}(x_1, \dots, x_k) \rangle; s_1, \dots, s_{i-1}, \overline{x_1}, \dots, \overline{x_k}, s_{i+1}, \dots, s_{n+1}, s).$$

Remark: In Figure 15 and 17, for graphical reasons, we don't follow exactly the notations used in the text. For instance in Figure 15, the correspondence with the notations of (1) is given by $v_1 = t_1, \dots, v_{i-1} = t_{i-1}, u_1 = t_i, \dots, u_k = t_{k+i-1}, v_i = t_{k+i}, \dots, v_n = t_{k+n}$.

Remark: Figure 15 is actually slightly incorrect as the connections between the “auxiliary ports” of the cocontraction rule within the promotion box of the right hand proof-structure and the main ports of the trees u_1, \dots, u_k are represented as vertical lines whereas they involve axioms (corresponding to the pairs (x_i, \bar{x}_i) for $i = 1, \dots, k$ in the formula above). The same kind of slight incorrectness occurs in figure 17.

The three last commutative reductions deal with the interaction between a promotion and the costructural rules.

Interaction between a promotion and a coweakening, see Figure 16:

$$P^{!(n+1)}(t_1, \dots, t_{i-1}, \bar{w}, t_i, \dots, t_n) \rightsquigarrow_{\text{com}} (; R^{!(n)}(t_1, \dots, t_n))$$

where

$$R = \sum_{p=(\vec{c}; \vec{s}, s)} P_p \cdot (\vec{c}, \langle s_i | \bar{w} \rangle; s_1, \dots, s_{i-1}, s_{i+1}, \dots, s_{n+1}, s).$$

Interaction between a promotion and a cocontraction, see Figure 17:

$$P^{!(n+1)}(t_1, \dots, t_{i-1}, \bar{c}(t_i, t_{i+1}), t_{i+2}, \dots, t_{n+2}) \rightsquigarrow_{\text{com}} (; R^{!(n+2)}(t_1, \dots, t_{n+2})) \quad (2)$$

where

$$R = \sum_{p=(\vec{c}; \vec{s}, s)} P_p(\vec{c}, \langle s_i | \bar{c}(x, y) \rangle; s_1, \dots, s_{i-1}, \bar{x}, \bar{y}, s_i, \dots, s_n, s).$$

The interaction between a promotion and a codereliction is a syntactic version of the *chain rule* of calculus, see Figure 18.

$$\begin{aligned} & P^{!(n+1)}(t_1, \dots, t_{i-1}, \bar{d}(u), t_{i+1}, \dots, t_{n+1}) \\ & \rightsquigarrow_{\text{com}} \sum_{p=(\vec{c}; s_1, \dots, s_{n+1}, s)} P_p \cdot (\langle s_i | \bar{d}(u) \rangle, \\ & \quad \langle c(\bar{x}_1, s_1) | t_1 \rangle, \dots, \langle c(\widehat{\bar{x}_i, s_i}) | t_i \rangle, \dots, \langle c(\bar{x}_{n+1}, s_{n+1}) | t_{n+1} \rangle; \\ & \quad \bar{c}(P^{!(n+1)}(x_1, \dots, x_{i-1}, \bar{w}, x_{i+1}, \dots, x_{n+1}), \bar{d}(s))) \end{aligned}$$

where we use the standard notation $a_1, \dots, \hat{a}_i, \dots, a_n$ for the sequence

$$a_1, \dots, a_{i-1}, a_{i+1}, \dots, a_n.$$

We also have to explain how these commutative reductions can be used in arbitrary contexts. We deal first with the case where such a reduction occurs under a constructor symbol $\varphi \in \Sigma_{n+1}$.

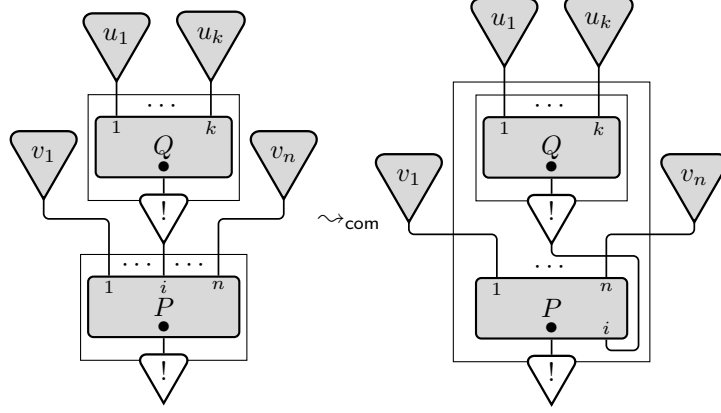

Figure 15: Promotion/promotion commutative reduction

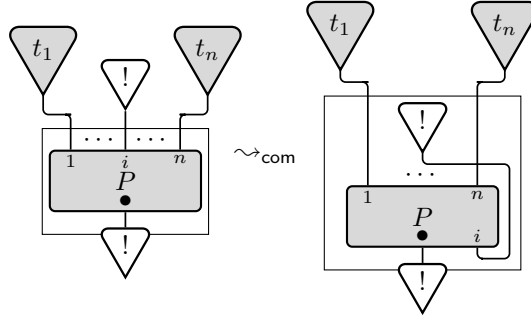

Figure 16: Promotion/commutative reduction

$$\frac{t \rightsquigarrow_{\text{com}} P}{\varphi(\vec{u}, t, \vec{v}) \rightsquigarrow_{\text{com}} \sum_{p=(\vec{c}; w)} P_p \cdot (\vec{c}; \varphi(\vec{u}, w, \vec{v}))}$$

Next we deal with the case where t occurs in outermost position in a proof-structure. There are actually two possibilities.

$$\frac{t \rightsquigarrow_{\text{com}} P}{(\vec{c}; \vec{u}, t, \vec{v}) \rightsquigarrow_{\text{com}} \sum_{p=(\vec{d}; w)} P_p \cdot (\vec{c}, \vec{d}; \vec{u}, w, \vec{v})}$$

$$\frac{t \rightsquigarrow_{\text{com}} P}{((t|t'), \vec{c}; \vec{t}) \rightsquigarrow_{\text{com}} \sum_{p=(\vec{d}; w)} P_p \cdot (\vec{c}, \vec{d}, \langle w|t' \rangle; \vec{t})}$$

We use \rightsquigarrow for the union of the reduction relations $\rightsquigarrow_{\text{cut}}$ and $\rightsquigarrow_{\text{com}}$. This formalization of nets enjoys a subject reduction property.

Theorem 2 *If $\Phi \vdash p : \Gamma$ and $p \rightsquigarrow P$ then $\Phi' \vdash P : \Gamma$ for some Φ' which extends Φ .*

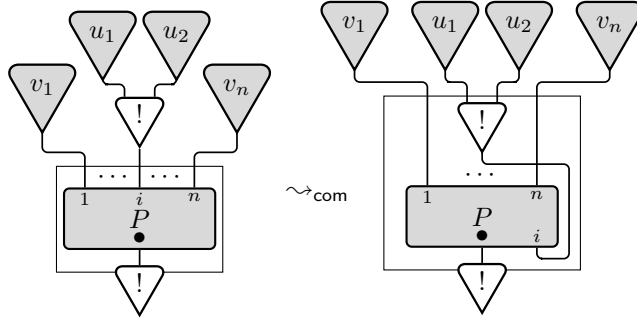

Figure 17: Promotion/cocontraction commutative reduction rules

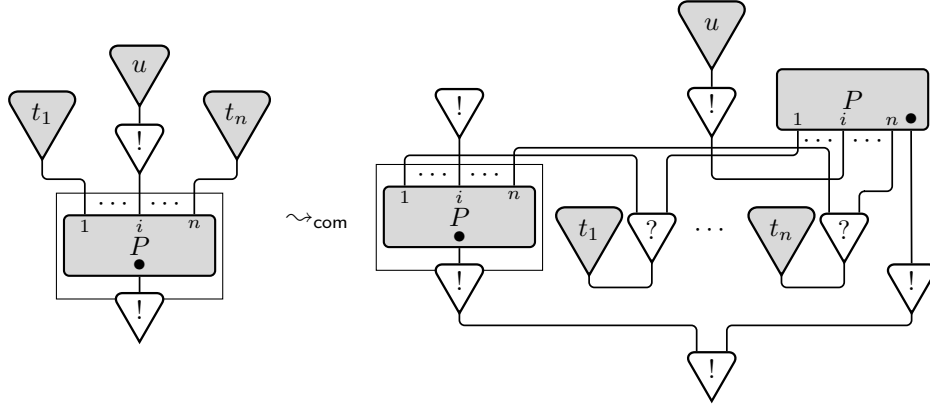

Figure 18: Promotion/codereliction commutative reduction (Chain Rule)

The proof is a rather long case analysis. We need to consider possible extensions of Φ because of the fresh variables which are introduced by several reduction rules.

1.6 Correctness criterion and properties of the reduction

Let P be proof-structure, Φ be a closed typing context and Γ be a sequence of formulas such that $\Phi \vdash_0 P : \Gamma$. One says that P is a *proof-net* if it satisfies $\Phi \vdash P : \Gamma$. A *correctness criterion* is a criterion on P which guarantees that P is a proof-net; of course, saying that $\Phi \vdash P : \Gamma$ is a correctness criterion, but is not a satisfactory one because it is not easy to prove that it is preserved by reduction.

Various such criteria can be found in the literature, but most of them apply to proof-structures considered as graphical objects and are not very suitable to our term-based approach. We rediscovered recently a correctness criterion initially due to Rétoré [Ret03] which seems more convenient for the kind of

presentation of proof-structures that we use here, see [Ehr14]. This criterion, which is presented for MLL, can easily be extended to the whole of DiLL.

So far, the reduction relation \rightsquigarrow is defined as a relation between simple proof-structures and proof-structures. It must be extended to a relation between arbitrary proof-structures. This is done by means of the following rules

$$\frac{p \rightsquigarrow P}{p + Q \rightsquigarrow P + Q} \quad \frac{p \rightsquigarrow P \quad \mu \in \mathbf{k} \setminus \{0\}}{\mu \cdot p \rightsquigarrow \mu \cdot P}$$

As it is defined, our reduction relation does not allow us to perform the reduction within boxes. To this end, one should add the following rule.

$$\frac{P \rightsquigarrow Q}{P^{!(n)}(t_1, \dots, t_n) \rightsquigarrow Q^{!(n)}(t_1, \dots, t_n)}$$

It is then possible to prove basic properties such as confluence and normalization⁷. For these topics, we refer mainly to the work of Pagani [Pag09], Tranquilli [PT09, Tra09, PT11], Gimenez [Gim11]. We also refer to Vaux [Vau09] for the link between the algebraic properties of \mathbf{k} and the properties of \rightsquigarrow , in a simpler λ -calculus setting.

Of course these proofs should be adapted to our presentation of proof structures. This has not been done yet but we are confident that it should not lead to difficulties.

2 Categorical denotational semantics

We describe now the denotational semantics of DiLL in a general categorical setting. This will give us an opportunity to provide more intuitions about the rules of this system. More intuition about the meaning of the differential constructs of DiLL is given in Section 3.

2.1 Notations and conventions

Let \mathcal{C} be a category. Given objects X and Y of \mathcal{C} , we use $\mathcal{C}(X, Y)$ for the set of morphisms from X to Y . Given $f \in \mathcal{C}(X, Y)$ and $g \in \mathcal{C}(Y, Z)$, we use $g f$ for the composition of f and g , which belongs to $\mathcal{C}(X, Z)$. In specific situations, we use also the notation $g \circ f$. When there are no ambiguities, we use X instead of Id_X to denote the identity from X to X .

Given $n \in \mathbb{N}$ and a functor $F : \mathcal{C} \rightarrow \mathcal{D}$, we use the same notation F for the functor $\mathcal{C}^n \rightarrow \mathcal{D}^n$ defined in the obvious manner: $F(X_1, \dots, X_n) = (F(X_1), \dots, F(X_n))$ and similarly for morphisms. If $F, G : \mathcal{C} \rightarrow \mathcal{D}$ are functors and if T is a natural transformation, we use again the same notation T for the corresponding natural transformation between the functors $F, G : \mathcal{C}^n \rightarrow \mathcal{D}^n$, so that $T_{X_1, \dots, X_n} = (T_{X_1}, \dots, T_{X_n})$.

⁷For confluence, one needs to introduce an equivalence relation on proof-structures which expresses typically that contraction is associative, see [Tra09]. For normalization, some conditions have to be satisfied by \mathbf{k} ; typically, it holds if one assumes that $\mathbf{k} = \mathbb{N}$ but difficulties arise if \mathbf{k} has additive inverses.

2.2 Monoidal structure

A symmetric monoidal category is a structure $(\mathcal{L}, I, \square, \lambda, \rho, \alpha, \sigma)$ where \mathcal{L} is a category, I is an object of \mathcal{L} , $\square : \mathcal{L}^2 \rightarrow \mathcal{L}$ is a functor and $\lambda_X \in \mathcal{L}(I \square X, X)$, $\rho_X \in \mathcal{L}(X \square I, X)$, $\alpha_{X,Y,Z} \in \mathcal{L}((X \square Y) \square Z, X \square (Y \square Z))$ and $\sigma_{X,Y} \in \mathcal{L}(X \square Y, Y \square X)$ are natural isomorphisms satisfying coherence conditions which can be expressed as commutative diagrams, and that we do not recall here. Following McLane [Mac71], we present these coherence conditions using a notion of *monoidal trees* (called *binary words* in [Mac71]).

Monoidal trees (or simply *trees* when there are no ambiguities) are defined by the following syntax.

- $\langle \rangle$ is the empty tree
- $*$ is the tree consisting of just one leaf
- and, given trees τ_1 and τ_2 , $\langle \tau_1, \tau_2 \rangle$ is a tree.

Let $L(\tau)$ be the number of leaves of τ , defined by

$$\begin{aligned} L(\langle \rangle) &= 0 \\ L(*) &= 1 \\ L(\langle \tau_1, \tau_2 \rangle) &= L(\tau_1) + L(\tau_2). \end{aligned}$$

Let \mathcal{T}_n be the set of trees τ such that $L(\tau) = n$. This set is infinite for all n .

Let $\tau \in \mathcal{T}_n$. Then we define in an obvious way a functor $\square^\tau : \mathcal{L}^n \rightarrow \mathcal{L}$. On object, it is defined as follows:

$$\begin{aligned} \square^{\langle \rangle} &= I \\ \square^* &= X \\ \square^{\langle \tau_1, \tau_2 \rangle}(X_1, \dots, X_{L(\tau_1)}, Y_1, \dots, Y_{L(\tau_2)}) &= (\square^{\tau_1}(\vec{X})) \square (\square^{\tau_2}(\vec{Y})). \end{aligned}$$

The definition on morphisms is similar.

2.2.1 Generalized associativity.

Given $\tau_1, \tau_2 \in \mathcal{T}_n$, the isomorphisms λ, ρ and α of the monoidal structure of \mathcal{L} allow us to build a unique natural isomorphism $\square_{\tau_2}^{\tau_1}$ from \square^{τ_1} to \square^{τ_2} . We have in particular

$$\begin{aligned} \lambda_X &= \square_{*}^{\langle \rangle, *} X \\ \rho_X &= \square_{*}^{*, \langle \rangle} X \\ \alpha_{X,Y,Z} &= \square_{\langle *, \langle *, * \rangle}^{\langle \langle *, * \rangle, * \rangle} X, Y, Z \end{aligned}$$

The coherence commutation diagrams (which include the McLane Pentagon) allow one indeed to prove that all the possible definitions of an isomorphism

$\square^{\tau_1}(\vec{X}) \rightarrow \square^{\tau_2}(\vec{X})$ using these basic ingredients give rise to the same result. This is McLane coherence Theorem for monoidal categories. In particular the following properties will be quite useful:

$$\square_{\vec{X}}^{\tau} = \text{Id}_{\square_{\tau}(\vec{X})} \quad \text{and} \quad \square_{\tau_3 \vec{X}}^{\tau_2} \square_{\tau_2 \vec{X}}^{\tau_1} = \square_{\tau_3 \vec{X}}^{\tau_1}. \quad (3)$$

We shall often omit the indexing sequence \vec{X} when using these natural isomorphisms, writing \square_{τ}^{σ} instead of $\square_{\tau}^{\sigma}(\vec{X})$.

2.2.2 Generalized symmetry.

Let $n \in \mathbb{N}$. Let $\varphi \in \mathfrak{S}_n$, we define a functor $\hat{\varphi} : \mathcal{L}^n \rightarrow \mathcal{L}^n$ by $\hat{\varphi}(X_1, \dots, X_n) = (X_{\varphi(1)}, \dots, X_{\varphi(n)})$

Assume that the monoidal category \mathcal{L} is also symmetric. The corresponding additional structure allows one to define a natural isomorphism $\hat{\square}^{\varphi, \tau}$ from the functor \square^{τ} to the functor $\square^{\tau} \circ \hat{\varphi}$. The correspondence $\varphi \mapsto \hat{\square}^{\varphi, \tau}$ is of course functorial. Moreover, given $\sigma, \tau \in \mathcal{T}_n$ and $\varphi \in \mathfrak{S}_n$, the following diagram is commutative

$$\begin{array}{ccc} \square^{\sigma} \vec{X} & \xrightarrow{\hat{\square}^{\varphi, \sigma}} & \square^{\sigma} \hat{\varphi}(\vec{X}) \\ \square_{\tau}^{\sigma} \downarrow & & \downarrow \square_{\tau}^{\sigma} \\ \square^{\tau} \vec{X} & \xrightarrow{\hat{\square}^{\varphi, \tau}} & \square^{\tau} \hat{\varphi}(\vec{X}) \end{array} \quad (4)$$

This is a consequence of McLane coherence Theorem for symmetric monoidal categories.

2.3 *-autonomous categories

A **-autonomous category* is a symmetric monoidal category $(\mathcal{L}, \otimes, \lambda, \rho, \alpha, \sigma)$ equipped with the following structure:

- an endomap on the objects of \mathcal{L} that we denote as $X \mapsto X^{\perp}$;
- for each object X , an evaluation morphism $\text{ev}_{\perp} \in \mathcal{L}(X^{\perp} \otimes X, \perp)$, where $\perp = 1^{\perp}$;
- a curryfication function $\text{cur}_{\perp} : \mathcal{L}(U \otimes X, \perp) \rightarrow \mathcal{L}(U, X^{\perp})$

subject to the following equations (with $f \in \mathcal{L}(U \otimes X, \perp)$ and $g \in \mathcal{L}(V, U)$, so that $g \otimes X \in \mathcal{L}(V \otimes X, U \otimes X)$):

$$\begin{aligned} \text{ev}_{\perp}(\text{cur}_{\perp}(f) \otimes X) &= f \\ \text{cur}_{\perp}(f)g &= \text{cur}_{\perp}(f(g \otimes X)) \\ \text{cur}_{\perp}(\text{ev}_{\perp}) &= \text{Id} . \end{aligned}$$

Then cur_{\perp} is a bijection. Indeed, let $g \in \mathcal{L}(U, X^{\perp})$. Then $g \otimes X \in \mathcal{L}(U \otimes X, X^{\perp} \otimes X)$ and hence $\text{ev}_{\perp}(g \otimes X) \in \mathcal{L}(U \otimes X, \perp)$. The equations allow one to prove that the function $g \mapsto \text{ev}_{\perp}(g \otimes X)$ is the inverse of the function cur_{\perp} .

For any object X of \mathcal{L} , let $\eta_X = \text{cur}_\perp(\text{ev}_\perp \sigma_{X, X^\perp}) \in \mathcal{L}(X, X^{\perp\perp})$.

The operation $X \mapsto X^\perp$ can be extended into a functor $\mathcal{L}^{\text{op}} \rightarrow \mathcal{L}$ as follows. Let $f \in \mathcal{L}(X, Y)$, then $\eta_Y f \in \mathcal{L}(X, Y^{\perp\perp})$, so $\text{ev}_\perp((\eta_Y f) \otimes Y^\perp) \in \mathcal{L}(X \otimes Y^\perp, \perp)$ and we set $f^\perp = \text{cur}_\perp(\text{ev}_\perp((\eta_Y f) \otimes Y^\perp) \sigma_{Y^\perp, X}) \in \mathcal{L}(Y^\perp, X^\perp)$. It can be checked that this operation is functorial.

We assume last that η_X is an iso for each object X .

One sets $X \multimap Y = (X \otimes Y^\perp)^\perp$ and one defines an evaluation morphism $\text{ev} \in \mathcal{L}((X \multimap Y) \otimes X, Y)$ as follows. We have

$$\text{ev}_\perp \in \mathcal{L}((X \otimes Y^\perp)^\perp \otimes (X \otimes Y^\perp), \perp)$$

hence

$$\text{ev}_\perp \otimes_{\langle \langle *, * \rangle, * \rangle} \in \mathcal{L}(((X \otimes Y^\perp)^\perp \otimes X) \otimes Y^\perp, \perp),$$

therefore

$$\text{cur}_\perp(\text{ev}_\perp \otimes_{\langle \langle *, * \rangle, * \rangle}) \in \mathcal{L}((X \otimes Y^\perp)^\perp \otimes X, Y^{\perp\perp})$$

and we set

$$\text{ev} = \eta^{-1} \text{cur}_\perp(\text{ev}_\perp \otimes_{\langle \langle *, * \rangle, * \rangle}) \in \mathcal{L}((X \otimes Y^\perp)^\perp \otimes X, Y).$$

Let $f \in \mathcal{L}(U \otimes X, Y)$. We have $\eta f \in \mathcal{L}(U \otimes X, Y^{\perp\perp})$, hence $\text{cur}_\perp^{-1}(\eta f) \in \mathcal{L}((U \otimes X) \otimes Y^\perp, \perp)$, so $\text{cur}_\perp^{-1}(\eta f) \otimes_{\langle \langle *, * \rangle, * \rangle} \in \mathcal{L}(U \otimes (X \otimes Y^\perp), \perp)$ and we can define a linear currying of f as

$$\text{cur}(f) = \text{cur}_\perp(\text{cur}_\perp^{-1}(\eta f) \otimes_{\langle \langle *, * \rangle, * \rangle}) \in \mathcal{L}(U, X \multimap Y).$$

One can prove then that the following equations hold, showing that the symmetric monoidal category \mathcal{L} is closed.

$$\begin{aligned} \text{ev}(\text{cur}(f) \otimes X) &= f \\ \text{cur}(f)g &= \text{cur}(f(g \otimes X)) \\ \text{cur}(\text{ev}) &= \text{ld} \end{aligned}$$

where $g \in \mathcal{L}(V, U)$.

It follows as usual that cur is a bijection from $\mathcal{L}(U \otimes X, Y)$ to $\mathcal{L}(U, X \multimap Y)$.

We set $X \wp Y = (X^\perp \otimes Y^\perp)^\perp = X^\perp \multimap Y$; this operation is the *cotensor product*, also called *par* in linear logic. Using the above properties one shows that this operation is a functor $\mathcal{L}^2 \rightarrow \mathcal{L}$ which defines another symmetric monoidal structure on \mathcal{L} . The operation $X \mapsto X^\perp$ is an equivalence of symmetric monoidal categories from $(\mathcal{L}^{\text{op}}, \otimes)$ to (\mathcal{L}, \wp) .

2.3.1 MIX.

A *mix *-autonomous category* is a *-autonomous category \mathcal{L} where \perp is endowed with a structure of commutative \otimes -monoid⁸. So we have two morphisms $\xi_0 \in$

⁸If we see \perp as the object of scalars, which is compatible with the intuition that $X \multimap \perp$ is the dual of X , that is, the “space of linear forms on X ”, then this monoid structure is an internal multiplication law on scalars.

$\mathcal{L}(1, \perp)$ and $\xi_2 \in \mathcal{L}(\perp \otimes \perp, \perp)$ and some standard diagrams must commute, which express that ξ_0 is left and right neutral for the binary operation ξ_2 , and that this binary operation is associative and commutative. Observe that $(\xi_2)^\perp \in \mathcal{L}(\perp^\perp, (\perp \otimes \perp)^\perp)$ so that

$$\xi'_2 = (\xi_2)^\perp \eta_1 \in \mathcal{L}(1, 1\mathfrak{Y}1)$$

and $(1, \xi_0, \xi'_2)$ is a commutative \mathfrak{Y} -comonoid.

2.3.2 Vectors.

Let \mathcal{L} be a $*$ -autonomous category and let X_1, \dots, X_n be objects of \mathcal{L} .

A (X_1, \dots, X_n) -vector is a family $(u_\tau)_{\tau \in \mathcal{T}_n}$ where $u_\tau \in \mathcal{L}(1, \mathfrak{Y}^\tau(X_1, \dots, X_n))$ satisfies $u_{\tau'} = \mathfrak{Y}_{\tau'}^\tau u_\tau$ for all $\tau, \tau' \in \mathcal{T}_n$. Of course such a vector u is determined as soon as one of the u_τ 's is given. The point of this definition is that none of these u_τ 's is more canonical than the others, that is why we find more convenient to deal with the whole family u . Let $\vec{\mathcal{L}}(X_1, \dots, X_n)$ be the set of these vectors. Notice that, since \mathcal{T}_n is infinite for all n , all vectors are infinite families.

2.3.3 MLL vector constructions.

Let $X \in \mathcal{L}$. We define $\mathfrak{a}x \in \vec{\mathcal{L}}(X^\perp, X)$ by setting $\mathfrak{a}x_\tau = \mathfrak{Y}_\tau^{\langle *, * \rangle} \text{cur}(\eta_X^{-1} \otimes_*^{\langle \langle \rangle, * \rangle}) \in \mathcal{L}(1, X^{\perp\perp} \multimap X) = \mathcal{L}(1, X^\perp \mathfrak{Y} X)$ for all $\tau \in \mathcal{T}_2$.

Let $u \in \vec{\mathcal{L}}(X_1, \dots, X_n, X, Y)$. We define $\mathfrak{Y}(u) \in \vec{\mathcal{L}}(X_1, \dots, X_n, X \mathfrak{Y} Y)$ as follows. Let $\tau \in \mathcal{T}_n$, we know that

$$u_{\langle \tau, \langle *, * \rangle \rangle} \in \mathcal{L}(1, (\mathfrak{Y}^\tau(X_1, \dots, X_n) \mathfrak{Y}(X \mathfrak{Y} Y))) = \mathcal{L}(1, (\mathfrak{Y}^{\langle \tau, * \rangle}(X_1, \dots, X_n, X \mathfrak{Y} Y))).$$

For any $\theta \in \mathcal{T}_{n+1}$, we set

$$\mathfrak{Y}(u)_\theta = \mathfrak{Y}_\theta^{\langle \tau, * \rangle} u_{\langle \tau, \langle *, * \rangle \rangle} \in \mathcal{L}(1, \mathfrak{Y}^\theta(X_1, \dots, X_n, X \mathfrak{Y} Y)).$$

One sees easily that this definition does not depend on the choice of τ : let $\tau' \in \mathcal{T}_n$, we have

$$\begin{aligned} \mathfrak{Y}_\theta^{\langle \tau, * \rangle} \mathfrak{Y}(u)_{\langle \tau, \langle *, * \rangle \rangle} &= \mathfrak{Y}_\theta^{\langle \tau, * \rangle} \mathfrak{Y}_{\langle \tau, * \rangle}^{\langle \tau', * \rangle} \mathfrak{Y}(u)_{\langle \tau', \langle *, * \rangle \rangle} \\ &= \mathfrak{Y}_\theta^{\langle \tau', * \rangle} \mathfrak{Y}(u)_{\langle \tau', \langle *, * \rangle \rangle}. \end{aligned}$$

thanks to the definition of vectors and to Equation (3).

Let U_i, X_i be objects of \mathcal{L} for $i = 1, 2$. Given

$$u_i \in \mathcal{L}(1, U_i \mathfrak{Y} X_i) = \mathcal{L}(1, U_i^\perp \multimap X_i)$$

for $i = 1, 2$, we define

$$\otimes_{U_1, X_1, U_2, X_2}(u_1, u_2) \in \mathcal{L}(1, (U_1 \mathfrak{Y} U_2) \mathfrak{Y}(X_1 \otimes X_2))$$

as follows. We have $\text{cur}^{-1}(u_i) \otimes_{\langle \cdot, * \rangle}^* \in \mathcal{L}(U_i^\perp, X_i)$ and hence

$$v = (\text{cur}^{-1}(u_1) \otimes_{\langle \cdot, * \rangle}^*) \otimes (\text{cur}^{-1}(u_2) \otimes_{\langle \cdot, * \rangle}^*) \in \mathcal{L}(U_1^\perp \otimes U_2^\perp, X_1 \otimes X_2).$$

We have

$$\text{cur}(v \otimes_{*}^{\langle \cdot, * \rangle}) \in \mathcal{L}(1, ((U_1^\perp \otimes U_2^\perp) \otimes (X_1 \otimes X_2)^\perp)^\perp)$$

So we set

$$\begin{aligned} \otimes_{U_1, X_1, U_2, X_2}(u_1, u_2) &= (\eta_{(U_1^\perp \otimes U_2^\perp)}^{-1} \otimes (X_1 \otimes X_2)^\perp)^\perp \text{cur}(v \otimes_{*}^{\langle \cdot, * \rangle}) \\ &\in \mathcal{L}(1, (U_1 \mathfrak{Y} U_2) \mathfrak{Y} (X_1 \otimes X_2)) \end{aligned}$$

where the natural iso η is defined in Section 2.3.

This construction is natural in the sense that, given $f_i \in \mathcal{L}(X_i, X'_i)$, $g_i \in \mathcal{L}(U_i, U'_i)$, one has

$$\begin{aligned} ((g_1 \mathfrak{Y} g_2) \mathfrak{Y} (f_1 \otimes f_2)) \otimes_{U_1, X_1, U_2, X_2}(u_1, u_2) \\ = \otimes_{U'_1, X'_1, U'_2, X'_2}((f_1 \mathfrak{Y} g_1) u_1, (f_2 \mathfrak{Y} g_2) u_2) \end{aligned} \quad (5)$$

Let $u \in \vec{\mathcal{L}}(X_1, \dots, X_n, X)$ and $v \in \vec{\mathcal{L}}(Y_1, \dots, Y_p, Y)$. Let $\sigma \in \mathcal{T}_n$ and $\tau \in \mathcal{T}_p$. Then we have

$$\begin{aligned} u_{\langle \sigma, * \rangle} &\in \mathcal{L}(1, (\mathfrak{Y}^\sigma(X_1, \dots, X_n)) \mathfrak{Y} X) \quad \text{and} \\ v_{\langle \tau, * \rangle} &\in \mathcal{L}(1, (\mathfrak{Y}^\tau(Y_1, \dots, Y_p)) \mathfrak{Y} Y) \end{aligned}$$

and we set

$$\begin{aligned} \otimes(u, v)_{\langle \langle \sigma, \tau \rangle, * \rangle} &= \otimes_{\mathfrak{Y}^\sigma(X_1, \dots, X_n), X, \mathfrak{Y}^\tau(Y_1, \dots, Y_p), Y}(u_{\langle \sigma, * \rangle}, v_{\langle \tau, * \rangle}) \\ &\in \mathcal{L}(1, \mathfrak{Y}^{\langle \langle \sigma, \tau \rangle, * \rangle}(X_1, \dots, X_n, Y_1, \dots, Y_p, X \otimes Y)) \end{aligned}$$

since

$$\begin{aligned} (\mathfrak{Y}^\sigma(X_1, \dots, X_n) \mathfrak{Y} (\mathfrak{Y}^\tau(Y_1, \dots, Y_p))) \mathfrak{Y} (X \otimes Y) \\ = \mathfrak{Y}^{\langle \langle \sigma, \tau \rangle, * \rangle}(X_1, \dots, X_n, Y_1, \dots, Y_p, X \otimes Y). \end{aligned}$$

Then, given $\theta \in \mathcal{T}_{n+p+1}$, one sets of course

$$\otimes(u, v)_\theta = \mathfrak{Y}_\theta^{\langle \langle \sigma, \tau \rangle, * \rangle} \otimes(u, v)_{\langle \langle \sigma, \tau \rangle, * \rangle}.$$

One checks easily that this definition does not depend on the choice of σ and τ , using Equations (3) and (5), and one can check that

$$\otimes(u, v) \in \vec{\mathcal{L}}(X_1, \dots, X_n, Y_1, \dots, Y_p, X \otimes Y).$$

Let $u \in \vec{\mathcal{L}}(X_1, \dots, X_n)$ and $\varphi \in \mathfrak{S}_n$. Given $\sigma \in \mathcal{T}_n$, we have $u_\sigma \in \mathcal{L}(1, \mathfrak{Y}^\sigma(X_1, \dots, X_n))$ and hence $\widehat{\mathfrak{Y}}^{\varphi, \sigma} u_\sigma \in \mathcal{L}(1, \mathfrak{Y}^\sigma(X_{\varphi(1)}, \dots, X_{\varphi(n)}))$. Given $\theta \in \mathcal{T}_n$, we set therefore

$$\text{sym}(\varphi, u)_\theta = \mathfrak{Y}_\theta^\sigma \widehat{\mathfrak{Y}}^{\varphi, \sigma} u_\sigma \in \mathcal{L}(1, \mathfrak{Y}^\theta(X_{\varphi(1)}, \dots, X_{\varphi(n)}))$$

defining an element $\text{sym}(\varphi, u)$ of $\vec{\mathcal{L}}(X_{\varphi(1)}, \dots, X_{\varphi(n)})$ which does not depend on the choice of σ . Indeed, let $\tau \in \mathcal{T}_n$, we know that $u_\sigma = \mathfrak{Y}_\sigma^\tau u_\tau$ and hence $\text{sym}(\varphi, u)_\theta = \mathfrak{Y}_\theta^\sigma \widehat{\mathfrak{Y}}^{\varphi, \sigma} \mathfrak{Y}_\sigma^\tau u_\tau = \mathfrak{Y}_\theta^\sigma \mathfrak{Y}_\sigma^\tau \widehat{\mathfrak{Y}}^{\varphi, \tau} u_\tau = \mathfrak{Y}_\theta^\tau \widehat{\mathfrak{Y}}^{\varphi, \tau} u_\tau$, using Diagram (4).

Let $u \in \vec{\mathcal{L}}(X_1, \dots, X_n, X^\perp)$ and $v \in \vec{\mathcal{L}}(Y_1, \dots, Y_p, X)$. We have

$$\otimes(u, v) \in \vec{\mathcal{L}}(X_1, \dots, X_n, Y_1, \dots, Y_p, X^\perp \otimes X)$$

Given $\sigma \in \mathcal{T}_n$ and $\tau \in \mathcal{T}_p$ we have

$$\otimes(u, v)_{\langle(\sigma, \tau), *\rangle} \in \mathcal{L}(1, ((\mathfrak{Y}^\sigma(X_1, \dots, X_n)) \mathfrak{Y}(\mathfrak{Y}^\tau Y_1, \dots, Y_p)) \mathfrak{Y}(X^\perp \otimes X))$$

so that

$$(\text{Id} \mathfrak{Y} \text{ev}_\perp) \otimes(u, v)_{\langle(\sigma, \tau), *\rangle} \in \mathcal{L}(1, \mathfrak{Y}^{\langle(\sigma, \tau), \langle \rangle \rangle}(X_1, \dots, X_n, Y_1, \dots, Y_p)).$$

Given $\theta \in \mathcal{T}_{n+p}$, we set

$$\text{cut}(u, v)_\theta = \mathfrak{Y}_\theta^{\langle(\sigma, \tau), \langle \rangle \rangle} (\text{Id} \mathfrak{Y} \text{ev}_\perp) \otimes(u, v)_{\langle(\sigma, \tau), *\rangle}$$

and we define in that way an element $\text{cut}(u, v)$ of $\vec{\mathcal{L}}(X_1, \dots, X_n, Y_1, \dots, Y_p)$.

Assume now that \mathcal{L} is a mix *-autonomous category (in the sense of Paragraph 2.3.1).

Let X_1, \dots, X_n and Y_1, \dots, Y_p be objects of \mathcal{L} . Let $u \in \vec{\mathcal{L}}(X_1, \dots, X_n)$ and $v \in \vec{\mathcal{L}}(Y_1, \dots, Y_p)$. Let $\sigma \in \mathcal{T}_n$ and $\tau \in \mathcal{T}_p$. We have $u_\sigma \in \mathcal{L}(1, \mathfrak{Y}^\sigma(X_1, \dots, X_n))$ and $v_\tau \in \mathcal{L}(1, \mathfrak{Y}^\tau(Y_1, \dots, Y_p))$. Hence

$$(u_\sigma \mathfrak{Y} v_\tau) \xi'_2 \in \mathcal{L}(1, (\mathfrak{Y}^\sigma(X_1, \dots, X_n)) \mathfrak{Y}(\mathfrak{Y}^\tau(Y_1, \dots, Y_p)))$$

and we define therefore $\text{mix}(u, v) \in \vec{\mathcal{L}}(X_1, \dots, X_n, Y_1, \dots, Y_p)$ by setting

$$\text{mix}(u, v)_\theta = \mathfrak{Y}_\theta^{\langle(\sigma, \tau), \langle \rangle \rangle} (u_\sigma \mathfrak{Y} v_\tau) \xi'_2 \in \mathcal{L}(1, \mathfrak{Y}^\theta(X_1, \dots, X_n, Y_1, \dots, Y_p))$$

for each $\theta \in \mathcal{T}_{n+p}$. As usual, this definition does not depend on the choice of σ and τ .

2.3.4 Interpreting MLL derivations.

We start with a valuation which, with each $\alpha \in \mathcal{A}$, associates $[\alpha] \in \mathcal{L}$ in such a way that $[\bar{\alpha}] = [\alpha]^\perp$. We extend this valuation to an interpretation of all MLL types as objects of \mathcal{L} in the obvious manner, so that we have a *De Morgan* iso $\text{dm}_A \in \mathcal{L}([A]^\perp, [A]^\perp)$ defined inductively as follows.

We set first $\text{dm}_\alpha = \text{Id}_{[\alpha]^\perp}$. We have $\text{dm}_A \in \mathcal{L}([A]^\perp, [A]^\perp)$ and $\text{dm}_B \in \mathcal{L}([B]^\perp, [B]^\perp)$, therefore $\text{dm}_A \mathfrak{Y} \text{dm}_B \in \mathcal{L}([(A \otimes B)^\perp], [A]^\perp \mathfrak{Y} [B]^\perp)$. We have

$$[A]^\perp \mathfrak{Y} [B]^\perp = ([A]^\perp \otimes [B]^\perp)^\perp$$

by definition of \mathfrak{Y} and remember that $\eta_{[A]} \in \mathcal{L}([A], [A]^\perp)$ and so we set

$$\text{dm}_{A \otimes B} = (\eta_{[A]} \otimes \eta_{[B]})^\perp (\text{dm}_A \mathfrak{Y} \text{dm}_B).$$

We have $[(A\mathfrak{A}B)^\perp] = [A^\perp] \otimes [B^\perp]$ so $\mathbf{dm}_A \otimes \mathbf{dm}_B \in \mathcal{L}([(A\mathfrak{A}B)^\perp], [A]^\perp \otimes [B]^\perp)$. By definition we have $[A\mathfrak{A}B]^\perp = ([A]^\perp \otimes [B]^\perp)^{\perp\perp}$. So we set

$$\mathbf{dm}_{A\mathfrak{A}B} = \eta_{[A]^\perp \otimes [B]^\perp} (\mathbf{dm}_A \otimes \mathbf{dm}_B).$$

Given a sequence $\Gamma = (A_1, \dots, A_n)$ of types, we denote as $[\Gamma]$ the sequence of objects $([A_1], \dots, [A_n])$.

Given a derivation π of a logical judgment $\Phi \vdash p : \Gamma$ we define now $[\pi] \in \vec{\mathcal{L}}([\Gamma])$, by induction on the structure of π .

Assume first that $\Gamma = (A^\perp, A)$, $p = (; \bar{x}, x)$ and that π is the axiom

$$\frac{}{\Phi \vdash p : \Gamma} \text{ axiom}$$

We have $\mathbf{ax}_{[A]} \in \mathcal{L}(1, [A]^\perp \mathfrak{A} [A])$ and $\mathbf{dm}_A \in \mathcal{L}([A]^\perp, [A]^\perp)$ so that we can set

$$[\pi]_\sigma = \mathfrak{A}_\sigma^{(*,*)} (\mathbf{dm}_A^{-1} \mathfrak{A} \mathbf{Id}_{[A]}) \mathbf{ax}_{[A]}$$

and we have $[\pi] \in \vec{\mathcal{L}}([\Gamma])$ as required.

Assume next that $\Gamma = (\Delta, A\mathfrak{A}B)$, that $p = (\vec{c} ; \vec{s}, s\mathfrak{A}t)$ and that π is the following derivation, where λ is the derivation of the premise:

$$\frac{\Phi \vdash (\vec{c} ; \vec{s}, s, t) : \Delta, A, B}{\Phi \vdash (\vec{c} ; \vec{s}, s\mathfrak{A}t) : \Delta, A\mathfrak{A}B} \mathfrak{A}\text{-rule}$$

then by inductive hypothesis we have $[\lambda] \in \vec{\mathcal{L}}([\Delta, A, B])$ and hence we set

$$[\pi] = \mathfrak{A}([\lambda]) \in \vec{\mathcal{L}}([\Delta, A\mathfrak{A}B]).$$

Assume now that $\Gamma = (\Delta, \Lambda, A \otimes B)$, that $p = (\vec{c}, \vec{d} ; \vec{s}, \vec{t}, s \otimes t)$ and π is the following derivation, where λ is the derivation of the left premise and ρ is the derivation of the right premise:

$$\frac{\Phi \vdash (\vec{c} ; \vec{s}, s) : \Delta, A \quad \Phi \vdash (\vec{d} ; \vec{t}, t) : \Lambda, B}{\Phi \vdash (\vec{c}, \vec{d} ; \vec{s}, \vec{t}, s \otimes t) : \Delta, \Lambda, A \otimes B} \otimes\text{-rule}$$

then by inductive hypothesis we have $[\lambda] \in \vec{\mathcal{L}}([\Delta, A])$ and $[\rho] \in \vec{\mathcal{L}}([\Lambda, B])$ and hence we set

$$[\pi] = \otimes([\lambda], [\rho]) \in \vec{\mathcal{L}}([\Delta, \Lambda, A \otimes B]).$$

Assume that $\varphi \in \mathfrak{S}_n$, $\Gamma = (A_{\varphi(1)}, \dots, A_{\varphi(n)})$, $p = (\vec{c} ; s_{\varphi(1)}, \dots, s_{\varphi(n)})$ and that π is the following derivation, where λ is the derivation of the premise:

$$\frac{\Phi \vdash (\vec{c} ; s_1, \dots, s_n) : A_1, \dots, A_n}{\Phi \vdash p : \Gamma} \text{ permutation rule}$$

By inductive hypothesis we have $[\lambda] \in \vec{\mathcal{L}}([A_1], \dots, [A_n])$ and we set

$$[\pi] = \mathbf{sym}(\varphi, [\lambda]) \in \vec{\mathcal{L}}([\Gamma]).$$

Assume that $\Gamma = (\Delta, \Lambda)$, that $p = (\vec{c}, \vec{d}, \langle s | t \rangle ; \vec{s}, \vec{t})$ and that π is the following derivation, where λ is the derivation of the left premise and ρ is the derivation of the right premise:

$$\frac{\Phi \vdash (\vec{c}; \vec{s}, s) : \Delta, A^\perp \quad \Phi \vdash (\vec{d}; \vec{t}, t) : \Lambda, A}{\Phi \vdash (\vec{c}, \vec{d}, \langle s | t \rangle; \vec{s}, \vec{t}) : \Delta, \Lambda} \text{ cut rule}$$

By inductive hypothesis we have $[\lambda] \in \vec{\mathcal{L}}([\Delta, A^\perp])$ and $[\rho] \in \vec{\mathcal{L}}([\Lambda, A])$. Let n be the length of Δ . Let $\sigma \in \mathcal{T}_n$. We have $[\lambda]_{\langle \sigma, * \rangle} \in \mathcal{L}(1, (\mathfrak{A}^\sigma([\Delta]))\mathfrak{A}[A^\perp])$ and hence $(\text{Id}^{\mathfrak{A}\text{dm}_A})[\lambda]_{\langle \sigma, * \rangle} \in \mathcal{L}(1, (\mathfrak{A}^\sigma([\Delta]))\mathfrak{A}[A^\perp])$. We define therefore $l \in \vec{\mathcal{L}}([\Delta], [A]^\perp)$ by $l_{\langle \sigma, * \rangle} = (\text{Id}^{\mathfrak{A}\text{dm}_A})[\lambda]_{\langle \sigma, * \rangle}$ (this definition of l does not depend on the choice of σ). We set

$$[\pi] = \text{cut}(l, [\rho]) \in \vec{\mathcal{L}}([\Delta, \Lambda]).$$

Assume last that $\Gamma = (\Delta, \Lambda)$, that $p = (\vec{c}, \vec{d}; \vec{s}, \vec{t})$ and that π is the following derivation, where λ is the derivation of the left premise and ρ is the derivation of the right premise:

$$\frac{\Phi \vdash (\vec{c}; \vec{s}) : \Delta \quad \Phi \vdash (\vec{d}; \vec{t}) : \Lambda}{\Phi \vdash (\vec{c}, \vec{d}; \vec{s}, \vec{t}) : \Delta, \Lambda} \text{ mix rule}$$

so that by inductive hypothesis $[\lambda] \in \vec{\mathcal{L}}([\Delta])$ and $[\rho] \in \vec{\mathcal{L}}([\Lambda])$. We set

$$[\pi] = \text{mix}([\lambda], [\rho]) \in \vec{\mathcal{L}}([\Delta, \Lambda]).$$

The first main property of this interpretation of derivations is that they only depend on the underlying nets.

Theorem 3 *Let π and π' be derivations of $\Phi \vdash p : \Gamma$. Then $[\pi] = [\pi']$.*

The proof is a (tedious) induction on the structure of the derivations π and π' .

We use therefore $[p]$ to denote the value of $[\pi]$ where π is an arbitrary derivation of $\vdash p : \Gamma$.

Remark: It would be much more satisfactory to be able to define $[p]$ directly, without using the intermediate and non canonical choice of a derivation π . Such a definition would use directly the fact that p fulfills a correctness criterion in order to build a morphism of \mathcal{L} . It is not very clear yet how to do that in general, though such definitions are available in many concrete models of LL , such as coherence spaces.

The second essential property of this interpretation is that it is invariant under reductions (subject reduction)

Theorem 4 *Assume that $\Phi \vdash p : \Gamma$, $\Phi \vdash p' : \Gamma$ and that $p \rightsquigarrow p'$. Then $[p] = [p']$.*

2.4 Preadditive models

Let \mathcal{L} be a $*$ -autonomous category. We say that \mathcal{L} is *preadditive* if each hom-set $\mathcal{L}(X, Y)$ is equipped with a structure of \mathbf{k} -module (we use standard additive notations: 0 for the neutral element and + for the operation), which is compatible

with composition of morphisms and tensor product:

$$\begin{aligned} \left(\sum_{j \in J} \nu_j t_j \right) \left(\sum_{i \in I} \mu_i s_i \right) &= \sum_{(i,j) \in I \times J} \nu_j \mu_i (t_j s_i) \\ \left(\sum_{i \in I} \mu_i s_i \right) \otimes \left(\sum_{j \in J} \nu_j t_j \right) &= \sum_{(i,j) \in I \times J} \mu_i \nu_j (s_i \otimes t_j) \end{aligned}$$

where the μ_i 's and the ν_j 's are elements of \mathbf{k} . It follows that, given a finite family $(s_i)_{i \in I}$ of morphisms $s_i \in \mathcal{L}(U \otimes X, \perp)$, one has $\text{cur}_\perp(\sum_{i \in I} \mu_i s_i) = \sum_{i \in I} \mu_i \text{cur}_\perp(s_i)$, and that the cotensor product is bilinear

$$\left(\sum_{i \in I} \mu_i s_i \right) \wp \left(\sum_{j \in J} \nu_j t_j \right) = \sum_{(i,j) \in I \times J} \mu_i \nu_j (s_i \wp t_j).$$

Let $(X_i)_{i=1}^n$ be a family of objects of \mathcal{L} . The set $\vec{\mathcal{L}}(X_1, \dots, X_n)$ inherits canonically a \mathbf{k} -module structure.

2.5 Exponential structure

If \mathcal{C} is a category, we use \mathcal{C}_{iso} to denote the category whose objects are those of \mathcal{C} and whose morphisms are the isos of \mathcal{C} (so \mathcal{C}_{iso} is a groupoid).

Let \mathcal{L} be a preadditive $*$ -autonomous category. An *exponential structure* on \mathcal{L} is a tuple $(!_-, w, c, \bar{w}, \bar{c}, d, \bar{d})$ where $!_-$ is a functor $\mathcal{L}_{\text{iso}} \rightarrow \mathcal{L}_{\text{iso}}$ and the other ingredients are natural transformations: $w_X \in \mathcal{L}(!X, 1)$ (*weakening*), $c_X \in \mathcal{L}(!X, !X \otimes !X)$ (*contraction*), $\bar{w}_X \in \mathcal{L}(1, !X)$ (*coweakening*), $\bar{c}_X \in \mathcal{L}(!X \otimes !X, !X)$ (*cocontraction*), $d_X \in \mathcal{L}(!X, X)$ (*dereliction*) and $\bar{d}_X \in \mathcal{L}(X, !X)$ (*codereliction*).

These morphisms are assumed moreover to satisfy the following properties.

The structure $(!X, w_X, c_X, \bar{w}_X, \bar{c}_X)$ is required to be a commutative bialgebra. This means that $(!X, w_X, c_X)$ is a commutative comonoid, $(!X, \bar{w}_X, \bar{c}_X)$ is a commutative monoid and that the following diagrams commute (where $\varphi = (1, 3, 2, 4) \in \mathfrak{S}_4$)

$$\begin{array}{ccc} !X \otimes !X & \xrightarrow{c_X \otimes c_X} & (!X \otimes !X) \otimes (!X \otimes !X) \\ \bar{c}_X \downarrow & & \downarrow \otimes^{\varphi, \langle \langle *, * \rangle, \langle *, * \rangle \rangle} \\ !X & & \\ c_X \downarrow & & \\ !X \otimes !X & \xleftarrow{\bar{c}_X \otimes \bar{c}_X} & (!X \otimes !X) \otimes (!X \otimes !X) \end{array} \quad \begin{array}{ccc} 1 & \xrightarrow{\bar{w}_X} & !X \\ \text{Id}_1 \downarrow & & \downarrow \\ 1 & \xleftarrow{w_X} & !X \end{array}$$

Moreover, we also require the following commutations (in the dereliction/cocontraction and codereliction/contraction diagrams, we omit the isos $\otimes_*^{\langle \cdot, * \rangle}$ and $\otimes_*^{\langle *, \cdot \rangle}$ for the sake of readability).

$$\begin{array}{ccc}
\begin{array}{ccc} X & \xrightarrow{\bar{d}_X} & !X \\ 0 \downarrow & & \swarrow w_X \\ 1 & & \end{array} & & \begin{array}{ccc} X & \xrightarrow{\bar{d}_X} & !X \\ \bar{d}_X \otimes \bar{w}_X + \bar{w}_X \otimes \bar{d}_X \downarrow & & \swarrow c_X \\ !X \otimes !X & & \end{array} \\
\begin{array}{ccc} X & \xleftarrow{d_X} & !X \\ 0 \uparrow & & \swarrow \bar{w}_X \\ 1 & & \end{array} & & \begin{array}{ccc} X & \xleftarrow{d_X} & !X \\ d_X \otimes w_X + w_X \otimes d_X \uparrow & & \swarrow \bar{c}_X \\ !X \otimes !X & & \end{array}
\end{array}$$

and

$$\begin{array}{ccc} X & \xrightarrow{\bar{d}_X} & !X \\ \text{Id}_X \downarrow & & \swarrow d_X \\ X & & \end{array}$$

2.5.1 The *why not* modality.

We define $?X = (!X^\perp)^\perp$ and we extend this operation to a functor $\mathcal{L}_{\text{iso}} \rightarrow \mathcal{L}_{\text{iso}}$ in the same way (using the contravariant functoriality of $(-)^\perp$). We define

$$w'_X = w_{X^\perp}^\perp : \perp \rightarrow ?X.$$

Since $c_{X^\perp} : !(X^\perp) \rightarrow !(X^\perp) \otimes !(X^\perp)$, we have $c_{X^\perp}^\perp : (!(X^\perp) \otimes !(X^\perp))^\perp \rightarrow ?X$. But $\eta_{!(X^\perp)} : !(X^\perp) \rightarrow (?X)^\perp$, hence $(\eta_{!(X^\perp)} \otimes \eta_{!(X^\perp)})^\perp : ?X \wp ?X \rightarrow !(X^\perp) \otimes !(X^\perp)^\perp$ and we set

$$c'_X = c_{X^\perp}^\perp (\eta_{!(X^\perp)} \otimes \eta_{!(X^\perp)})^\perp \in \mathcal{L}(?X \wp ?X, ?X).$$

Then it can be shown that $(?X, w'_X, c'_X)$ is a commutative \wp -monoid (that is, a monoid in the monoidal category (\mathcal{L}, \wp)). Of course, w'_X and c'_X are natural transformations.

Last, we have $d_{X^\perp} : !(X^\perp) \rightarrow X^\perp$ and hence $(d_{X^\perp})^\perp : X^{\perp\perp} \rightarrow ?X$, so we can define the natural morphism

$$d'_X = (d_{X^\perp})^\perp \eta_X : X \rightarrow ?X.$$

2.5.2 Interpreting DiLL₀ derivations.

We extend the interpretation of derivations presented in Section 2.3.4 to the fragment DiLL₀ presented in Section 1.4.

We first have to extend the interpretation of formulas – this is done in the obvious way – and the definition of the De Morgan isomorphisms. We have

$[(!A)^\perp] = ?[A^\perp]$ and $[!A]^\perp = (![A])^\perp$. By inductive hypothesis, we have the iso $\mathbf{dm}_A : [A^\perp] \rightarrow [A]^\perp$, hence $?\mathbf{dm}_A : [(!A)^\perp] = [?(A^\perp)] \rightarrow ?([A]^\perp) = ![A]^\perp$ and since we have $(!\eta_{[A]})^\perp : !([A]^\perp)^\perp \rightarrow (![A])^\perp$, we set

$$\mathbf{dm}_{!A} = (!\eta_{[A]})^\perp ?\mathbf{dm}_A \in \mathcal{L}_{\text{iso}}([(!A)^\perp], [!A]^\perp).$$

We have $[(?A)^\perp] = ![A^\perp]$ and $[?A]^\perp = !([A]^\perp)^\perp$ so we set

$$\mathbf{dm}_{?A} = \eta_{([A]^\perp)} !\mathbf{dm}_A \in \mathcal{L}_{\text{iso}}([(?A)^\perp], [?A]^\perp)$$

Let π be a derivation of $\Phi \vdash p : \Gamma$, where $\Gamma = (A_1, \dots, A_n)$.

Assume first that $\Gamma = (\Delta, ?A)$, $p = (\vec{c} ; \vec{s}, \mathbf{w})$ and that π is the following derivation, denoting with λ the derivation of the premise:

$$\frac{\Phi \vdash (\vec{c} ; \vec{s}) : \Gamma}{\Phi \vdash (\vec{c} ; \vec{s}, \mathbf{w}) : \Gamma, ?A} \quad \text{weakening}$$

By inductive hypothesis we have $[\lambda] \in \vec{\mathcal{L}}([\Gamma])$. Let $\tau \in \mathcal{T}_n$, we have $[\lambda]_\tau \in \mathcal{L}(1, \mathfrak{A}^\tau([\Gamma]))$. We have $\mathbf{w}'_{[A]} \in \mathcal{L}(\perp, ?[A])$ and hence

$$[\lambda]_\tau \mathfrak{A}'_{[A]} \in \mathcal{L}(1 \mathfrak{A} \perp, \mathfrak{A}^{\langle \tau, * \rangle}([\Gamma, ?A]))$$

so that we can set

$$[\pi]_\theta = \mathfrak{A}_\theta^{\langle \tau, * \rangle}([\lambda]_\tau \mathfrak{A}'_{[A]}) \mathfrak{A}_{\langle *, \langle \rangle \rangle}^*$$

for any $\theta \in \mathcal{T}_n$. The fact that the family $[\pi]$ defined in that way does not depend on the choice of τ results from the fact that $[\lambda] \in \vec{\mathcal{L}}([\Gamma])$.

Assume that $\Gamma = (\Delta, ?A)$, $p = (\vec{c} ; \vec{s}, \mathbf{c}(t_1, t_2))$ and that π is the following derivation, denoting with λ the derivation of the premise:

$$\frac{\vdash (\vec{c} ; \vec{s}, t_1, t_2) : \Delta, ?A, ?A}{\vdash (\vec{c} ; \vec{s}, \mathbf{c}(t_1, t_2)) : \Delta, ?A} \quad \text{contraction}$$

We have $\mathbf{c}'_{[A]} \in \mathcal{L}([?A] \mathfrak{A} [?A], [?A])$. By inductive hypothesis $[\lambda] \in \vec{\mathcal{L}}([\Delta, ?A, ?A])$. Let $\tau \in \mathcal{T}_n$ where n is the length of Δ . We have

$$[\lambda]_{\langle \tau, \langle *, * \rangle \rangle} \in \mathcal{L}(1, (\mathfrak{A}^\tau([\Delta])) \mathfrak{A}([?A] \mathfrak{A} [?A]))$$

and hence, given $\theta \in \mathcal{T}_{n+1}$, we set

$$[\pi]_\theta = \mathfrak{A}_\theta^{\langle \tau, * \rangle} (\mathfrak{A}^\tau([\Delta]) \mathfrak{A}'_{[A]}) [\lambda]_{\langle \tau, \langle *, * \rangle \rangle}$$

defining in that way $[\pi] \in \vec{\mathcal{L}}([\Delta, ?A])$.

Assume that $\Gamma = (!A)$, $p = (; \bar{\mathbf{w}})$ and that π is the following derivation

$$\frac{}{\vdash (; \mathbf{w}) : !A} \quad \text{co-weakening}$$

then, for $\theta \in \mathcal{T}_1$ we set $[\pi]_\theta = \mathfrak{Y}_\theta^*([!A]) \bar{w}_{[A]}$ defining in that way an element $[\pi]$ of $\vec{\mathcal{L}}([!A])$.

Assume that $\Gamma = (\Delta, \Lambda, !A)$, $p = (\vec{c}, \vec{d}; \vec{s}, \vec{t}, \bar{c}(u, v))$ and that π is the following derivation

$$\frac{\Phi \vdash (\vec{c}; \vec{s}, u) : \Delta, !A \quad \Phi \vdash (\vec{d}; \vec{t}, v) : \Lambda, !A,}{\Phi \vdash (\vec{c}, \vec{d}; \vec{s}, \vec{t}, \bar{c}(u, v)) : \Delta, \Lambda, !A} \quad \text{co-contraction}$$

and we denote with λ and ρ the derivations of the two premises. By inductive hypothesis, we have $[\lambda] \in \vec{\mathcal{L}}([\Delta], [!A])$ and $[\rho] \in \vec{\mathcal{L}}([\Lambda], [!A])$. We have $\otimes([\lambda], [\rho]) \in \vec{\mathcal{L}}([\Delta], [\Lambda], [!A] \otimes [!A])$.

Let m be the length of Δ and n be the length of Λ . Let $\tau \in \mathcal{T}_{m+n}$, we have $\otimes([\lambda], [\rho])_{\langle \tau, * \rangle} \in \mathcal{L}(1, (\mathfrak{Y}^\tau([\Delta], [\Lambda])) \mathfrak{Y}([\Delta] \otimes [\Lambda]))$. Hence, given $\theta \in \mathcal{T}_{m+n+1}$ we set

$$[\pi]_\theta = \mathfrak{Y}_\theta^{\langle \tau, * \rangle} ((\mathfrak{Y}^\tau([\Delta], [\Lambda])) \mathfrak{Y} \bar{c}_X) \otimes ([\lambda], [\rho])_{\langle \tau, * \rangle}.$$

so that $[\pi] \in \vec{\mathcal{L}}([\Delta], [\Lambda], [!A])$, and this definition does not depend on the choice of τ .

Assume that $\Gamma = (\Delta, ?A)$, $p = (\vec{c}; \vec{s}, d(s))$ and that π is the following derivation

$$\frac{\Phi \vdash (\vec{c}; \vec{s}, s) : \Delta, A}{\Phi \vdash (\vec{c}; \vec{s}, d(s)) : \Delta, ?A} \quad \text{dereliction}$$

Let λ be the derivation of the premise, so that $[\lambda] \in \vec{\mathcal{L}}([\Delta], [A])$.

We have $d'_{[A]} : [A] \rightarrow [?A]$. Let n be the length of Δ , let $\tau \in \mathcal{T}_n$ and let $\theta \in \mathcal{T}_{n+1}$. We set

$$[\pi]_\theta = \mathfrak{Y}_\theta^{\langle \tau, * \rangle} ((\mathfrak{Y}^\tau([\Delta])) \mathfrak{Y} d'_{[A]}) [\lambda]_{\langle \tau, * \rangle}$$

and we define in that way an element π of $\vec{\mathcal{L}}([\Delta], [?A])$ which does not depend on the choice of τ .

Assume that $\Gamma = (\Delta, !A)$, $p = (\vec{c}; \vec{s}, \bar{d}(s))$ and that π is the following derivation

$$\frac{\Phi \vdash (\vec{c}; \vec{s}, s) : \Delta, A}{\Phi \vdash (\vec{c}; \vec{s}, \bar{d}(s)) : \Delta, !A} \quad \text{co-dereliction}$$

Let λ be the derivation of the premise, so that $[\lambda] \in \vec{\mathcal{L}}([\Delta], [A])$. We have $\bar{d}_{[A]} : [A] \rightarrow [!A]$. Let n be the length of Δ , let $\tau \in \mathcal{T}_n$ and let $\theta \in \mathcal{T}_{n+1}$. We set

$$[\pi]_\theta = \mathfrak{Y}_\theta^{\langle \tau, * \rangle} ((\mathfrak{Y}^\tau([\Delta])) \mathfrak{Y} \bar{d}_{[A]}) [\lambda]_{\langle \tau, * \rangle}$$

and we define in that way an element π of $\vec{\mathcal{L}}([\Delta], [!A])$ which does not depend on the choice of τ .

Last assume that $p = \sum_{i=1}^n \mu_i p_i$, that π is the following derivation

$$\frac{\Phi \vdash p_i : \Gamma \quad \forall i \in \{1, \dots, n\}}{\Phi \vdash \sum_{i=1}^n \mu_i p_i : \Gamma} \quad \text{sum}$$

and that λ_i is the derivation of the i -th premise in this derivation. Then by inductive hypothesis we have $[\lambda_i] \in \vec{\mathcal{L}}([\Delta])$ and we set of course

$$[\pi] = \sum_{i=1}^n \mu_i [\lambda_i].$$

One can prove for this extended interpretation the same results as for the MLL fragment.

Theorem 5 *Let π and π' be derivations of $\Phi \vdash p : \Gamma$. Then $[\pi] = [\pi']$.*

Again, we set $[p] = [\pi]$ where π is a derivation of $\Phi \vdash p : \Gamma$.

Theorem 6 *Assume that $\Phi \vdash p : \Gamma$, $\Phi \vdash p' : \Gamma$ and that $p \rightsquigarrow p'$. Then $[p] = [p']$.*

2.6 Functorial exponential

Let \mathcal{L} be a preadditive *-autonomous category with an exponential structure. A *promotion* operation on \mathcal{L} is given by an extension of the functor $!_-$ to all morphisms of \mathcal{L} and by a lax symmetric monoidal comonad structure on the “!” operation which satisfies additional conditions. More precisely:

- For each $f \in \mathcal{L}(X, Y)$ we are given a morphism $!f \in \mathcal{L}(!X, !Y)$ and the correspondence $f \mapsto !f$ is functorial. This mapping $f \mapsto !f$ extends the action of $!_-$ on isomorphisms.
- The morphisms $d_X, \bar{d}_X, w_X, \bar{w}_X, c_X$ and \bar{c}_X are natural with respect to this extended functor.
- There is a natural transformation $\mathfrak{p}_X : !X \rightarrow !!X$ which turns $(!X, d_X, \mathfrak{p}_X)$ into a comonad.
- There is a morphism $\mu^0 : 1 \rightarrow !1$ and a natural transformation⁹ $\mu_{X,Y}^2 : !X \otimes !Y \rightarrow !(X \otimes Y)$ which satisfy the following commutations

$$\begin{array}{ccccc} 1 \otimes !X & \xrightarrow{\mu^0 \otimes !X} & !1 \otimes !X & \xrightarrow{\mu_{1,X}^2} & !(1 \otimes X) \\ & \searrow \otimes_{*} \langle \langle \cdot, * \rangle \rangle & & & \downarrow !\otimes_{*} \langle \langle \cdot, * \rangle \rangle \\ & & & & !X \end{array} \quad (6)$$

⁹These morphisms are not required to be isos, whence the adjective “lax” for the monoidal structure.

$$\begin{array}{ccccc}
!X \otimes 1 & \xrightarrow{!X \otimes \mu^0} & !X \otimes !1 & \xrightarrow{\mu_{X,1}^2} & !(X \otimes 1) \\
& \searrow_{\otimes_* \langle *, \langle \rangle \rangle} & & & \downarrow !\otimes_* \langle *, \langle \rangle \rangle \\
& & & & !X
\end{array} \tag{7}$$

$$\begin{array}{ccccc}
(!X \otimes !Y) \otimes !Z & \xrightarrow{\otimes \langle \langle *, * \rangle, * \rangle} & !X \otimes (!Y \otimes !Z) & \xrightarrow{!X \otimes \mu_{Y,Z}^2} & !X \otimes !(Y \otimes Z) \\
\mu_{X,Y}^2 \otimes !Z \downarrow & & & & \downarrow \mu_{X,Y \otimes Z}^2 \\
!(X \otimes Y) \otimes !Z & \xrightarrow{\mu_{X \otimes Y, Z}^2} & !((X \otimes Y) \otimes Z) & \xrightarrow{!\otimes \langle \langle *, * \rangle, * \rangle} & !(X \otimes (Y \otimes Z))
\end{array} \tag{8}$$

$$\begin{array}{ccc}
!X \otimes !Y & \xrightarrow{\sigma_{!X, !Y}} & !Y \otimes !X \\
\mu_{X,Y}^2 \downarrow & & \downarrow \mu_{Y,X}^2 \\
!(X \otimes Y) & \xrightarrow{!\sigma_{X,Y}} & !(Y \otimes X)
\end{array} \tag{9}$$

- The following diagrams commute

$$\begin{array}{ccc}
!X \otimes !Y & \xrightarrow{\mu_{X,Y}^2} & !(X \otimes Y) \\
& \searrow_{d_X \otimes d_Y} & \downarrow d_{X \otimes Y} \\
& & X \otimes Y
\end{array} \quad \begin{array}{ccc}
1 & \xrightarrow{\mu^0} & !1 \\
& \searrow_1 & \downarrow d_1 \\
& & 1
\end{array}$$

$$\begin{array}{ccc}
!X \otimes !Y & \xrightarrow{\mu_{X,Y}^2} & !(X \otimes Y) \\
p_X \otimes p_Y \downarrow & & \downarrow p_{X \otimes Y} \\
!!X \otimes !!Y & \xrightarrow{\mu_{!X, !Y}^2} & !(X \otimes Y) \xrightarrow{!\mu_{X,Y}^2} & !!(X \otimes Y)
\end{array} \quad \begin{array}{ccc}
1 & \xrightarrow{\mu^0} & !1 \\
\mu^0 \downarrow & & \downarrow p_1 \\
!1 & \xrightarrow{!\mu^0} & !!1
\end{array}$$

When these conditions hold, one says that (μ^0, μ^2) is a lax symmetric monoidal structure on the comonad $(!, d, p)$.

2.6.1 Monoidality and structural morphisms.

This monoidal structure must also be compatible with the structural constructions.

$$\begin{array}{ccc}
!X \otimes !Y & \xrightarrow{\mu_{X,Y}^2} & !(X \otimes Y) \\
w_X \otimes w_Y \downarrow & \otimes_{\langle \langle \cdot, \cdot \rangle \rangle} & \downarrow w_{X \otimes Y} \\
1 \otimes 1 & \longrightarrow & 1
\end{array}
\qquad
\begin{array}{ccc}
1 & \xrightarrow{\mu^0} & !1 \\
\searrow 1 & & \downarrow w_1 \\
& & 1
\end{array}$$

$$\begin{array}{ccc}
!X \otimes !Y & \xrightarrow{c_X \otimes c_Y} & (!X \otimes !X) \otimes (!Y \otimes !Y) \\
\mu_{X,Y}^2 \downarrow & & \downarrow \widehat{\otimes}^{\varphi, \sigma} \\
!X \otimes !Y & & (!X \otimes !Y) \otimes (!X \otimes !Y) \\
\downarrow \mu_{X,Y}^2 & & \downarrow \mu_{X,Y}^2 \otimes \mu_{X,Y}^2 \\
!(X \otimes Y) & \xrightarrow{c_{X \otimes Y}} & !(X \otimes Y) \otimes !(X \otimes Y)
\end{array}
\qquad
\begin{array}{ccc}
1 & \xrightarrow{\otimes_{\langle \langle \cdot, \cdot \rangle \rangle}} & 1 \otimes 1 \\
\mu^0 \downarrow & & \downarrow \mu^0 \otimes \mu^0 \\
!1 & \xrightarrow{c_1} & !1 \otimes !1
\end{array}$$

where $\varphi = (1, 3, 2, 4) \in \mathfrak{S}_4$ and $\sigma = \langle \langle *, * \rangle, \langle *, * \rangle \rangle$.

2.6.2 Monoidality and costructural morphisms.

We need the following diagrams to commute in order to validate the reduction rules of DiLL.

$$\begin{array}{ccc}
1 \otimes !Y & \xrightarrow{\bar{w}_X \otimes !Y} & !X \otimes !Y \\
1 \otimes w_Y \downarrow & & \downarrow \mu_{X,Y}^2 \\
1 \otimes 1 & & \\
\otimes_{\langle \langle \cdot, \cdot \rangle \rangle} \downarrow & & \downarrow \bar{w}_{X \otimes Y} \\
1 & \xrightarrow{\bar{w}_{X \otimes Y}} & !(X \otimes Y)
\end{array}
\qquad
\begin{array}{ccc}
(!X \otimes !X) \otimes !Y & \xrightarrow{\bar{c}_X \otimes !Y} & !X \otimes !Y \\
(!X \otimes !X) \otimes c_Y \downarrow & & \downarrow \mu_{X,Y}^2 \\
(!X \otimes !X) \otimes (!Y \otimes !Y) & & \\
\widehat{\otimes}^{\varphi, \sigma} \downarrow & & \\
(!X \otimes !Y) \otimes (!X \otimes !Y) & & \\
\mu_{X,Y}^2 \otimes \mu_{X,Y}^2 \downarrow & & \\
!(X \otimes Y) \otimes !(X \otimes Y) & \xrightarrow{\bar{c}_{X \otimes Y}} & !(X \otimes Y)
\end{array}$$

where $\varphi = (1, 3, 2, 4) \in \mathfrak{S}_4$ and $\sigma = \langle \langle *, * \rangle, \langle *, * \rangle \rangle$.

$$\begin{array}{ccc}
X \otimes !Y & \xrightarrow{\bar{d}_X \otimes !Y} & !X \otimes !Y \\
X \otimes d_Y \downarrow & & \downarrow \mu_{X,Y}^2 \\
X \otimes Y & \xrightarrow{\bar{d}_{X \otimes Y}} & !(X \otimes Y)
\end{array}$$

2.6.3 Digging and structural morphisms.

We assume that p_X is a comonoid morphism from $(!X, w_X, c_X)$ to $(!X, w_{!X}, c_{!X})$, in other words, the following diagrams commute.

$$\begin{array}{ccc}
!X & \xrightarrow{p_X} & !!X \\
& \searrow w_X & \downarrow w_{!X} \\
& & 1
\end{array}
\qquad
\begin{array}{ccc}
!X & \xrightarrow{p_X} & !!X \\
c_X \downarrow & & \downarrow c_{!X} \\
!X \otimes !X & \xrightarrow{p_X \otimes p_X} & !!X \otimes !!X
\end{array}$$

2.6.4 Digging and costructural morphisms.

It is not required that p_X be a monoid morphism from $(!X, \bar{w}_X, \bar{c}_X)$ to $(!!X, \bar{w}_{!X}, \bar{c}_{!X})$, but the following diagrams must commute.

$$\begin{array}{ccc}
1 & \xrightarrow{\bar{w}_X} & !X \\
\mu^0 \downarrow & & \downarrow p_X \\
!1 & \xrightarrow{!\bar{w}_X} & !!X
\end{array}
\qquad
\begin{array}{ccc}
!X \otimes !X & \xrightarrow{\bar{c}_X} & !X \xrightarrow{p_X} !!X \\
p_X \otimes p_X \downarrow & & \downarrow !\bar{c}_X \\
!!X \otimes !!X & \xrightarrow{\mu^2_{!X, !X}} & !(X \otimes X)
\end{array}$$

In the same spirit, we need a last diagram to commute, which describes the interaction between codereliction and digging.

$$\begin{array}{ccc}
X & \xrightarrow{\bar{d}_X} & !X \xrightarrow{p_X} !!X \\
\otimes_{\langle \cdot, * \rangle}^* \downarrow & & \downarrow !\bar{c}_X \\
1 \otimes X & \xrightarrow{\bar{w}_X \otimes \bar{d}_X} & !X \otimes !X \xrightarrow{p_X \otimes \bar{d}_{!X}} !!X \otimes !!X
\end{array}$$

2.6.5 Preadditive structure and functorial exponential.

Our last requirement justifies the term “exponential” since it expresses that sums are turned into products by this functorial operation.

$$\begin{array}{ccc}
!X & \xrightarrow{!0} & !X \\
w_X \searrow & & \nearrow \bar{w}_X \\
& & 1
\end{array}
\qquad
\begin{array}{ccc}
!X & \xrightarrow{!(f+g)} & !Y \\
c_X \downarrow & & \downarrow \bar{c}_X \\
!X \otimes !X & \xrightarrow{!f \otimes !g} & !Y \otimes !Y
\end{array}$$

Remark: There is another option in the categorical axiomatization of models of Linear Logic that we briefly describe as follows.

- One requires the linear category \mathcal{L} to be cartesian, with a terminal object \top and a cartesian product usually denoted as $X_1 \& X_2$, projections $\pi_i \in \mathcal{L}(X_1 \& X_2, X_i)$ and pairing $\langle f_1, f_2 \rangle \in \mathcal{L}(Y, X_1 \& X_2)$ for $f_i \in \mathcal{L}(Y, X_i)$. This provides in particular \mathcal{L} with another symmetric monoidal structure.
- As above, one require the functor $!$ to be a comonad. But we equip it now with a symmetric monoidal structure (m^0, m^2) from the monoidal

category $(\mathcal{L}, \&)$ to the monoidal category (\mathcal{L}, \otimes) . This means in particular that $\mathbf{m}^0 \in \mathcal{L}(1, !\top)$ and $\mathbf{m}_{X_1, X_2}^2 \in \mathcal{L}(!X_1 \otimes !X_2, !(X_1 \& X_2))$ are isos. These isos are often called *Seely isos* in the literature, though Girard already stressed their significance in [Gir87], admittedly not in the general categorical setting of monoidal comonads. An additional commutation is required, which describes the interaction between \mathbf{m}^2 and \mathbf{p} .

Using this structure, the comonad $(!_-, \mathbf{d}, \mathbf{p})$ can be equipped with a lax symmetric monoidal structure (μ^0, μ^2) . Again, our main reference for these notions and constructions is [Mel09]. In this setting, the structural natural transformations w_X and c_X can be defined and it is well known that the Kleisli category $\mathcal{L}!$ of the comonad $!_-$ is cartesian closed.

If we require the category \mathcal{L} to be preadditive in the sense of Section 2.4, it is easy to see that \top is also an initial object and that $\&$ is also a coproduct. Using this fact, the natural transformations \bar{w}_X and \bar{c}_X can also be defined.

To describe a model of DiLL in this setting, one has to require these Seely monoidality isomorphisms to satisfy some commutations with the $\bar{\mathbf{d}}$ natural transformation.

Here, we prefer a description which does not use cartesian products because it is closer to the basic constructions of the syntax of proof-structures and makes the presentation of the semantics conceptually simpler and more canonical, to our taste at least.

2.6.6 Generalized monoidality, contraction and digging.

Just as the monoidal structure of a monoidal category, the monoidal structure of $!_-$ can be parameterized by monoidal trees. Let $n \in \mathbb{N}$ and let $\tau \in \mathcal{T}_n$. Given a family of objects $\vec{X} = (X_1, \dots, X_n)$ of \mathcal{L} , we define $\mu_{\vec{X}}^\tau : \otimes^\tau(!\vec{X}) \rightarrow !\otimes^\tau(\vec{X})$ by induction on τ as follows:

$$\begin{aligned} \mu^\langle \rangle &= \mu^0 \\ \mu_{\vec{X}}^* &= \text{Id}_{!X} \\ \mu_{\vec{X}, \vec{Y}}^{\langle \sigma, \tau \rangle} &= \mu_{\otimes^\sigma(\vec{X}), \otimes^\tau(\vec{Y})}^2 (\mu_{\vec{X}}^\sigma \otimes \mu_{\vec{Y}}^\tau). \end{aligned}$$

Given $\sigma, \tau \in \mathcal{T}_n$ and $\varphi \in \mathfrak{S}_n$, one can prove that the following diagrams commute

$$\begin{array}{ccc} \otimes^\sigma(!\vec{X}) & \xrightarrow{\otimes_\tau^\sigma(!\vec{X})} & \otimes^\tau(!\vec{X}) & & \otimes^\sigma(!\vec{X}) & \xrightarrow{\widehat{\otimes}^{\varphi, \sigma}(!\vec{X})} & \otimes^\sigma(\widehat{\varphi}(!\vec{X})) \\ \mu_{\vec{X}}^\sigma \downarrow & & \downarrow \mu_{\vec{X}}^\tau & & \mu_{\vec{X}}^\sigma \downarrow & & \downarrow \mu_{\widehat{\varphi}(\vec{X})}^\sigma \\ !\otimes^\sigma(\vec{X}) & \xrightarrow{!\otimes_\tau^\sigma(\vec{X})} & !\otimes^\tau(\vec{X}) & & !\otimes^\sigma(\vec{X}) & \xrightarrow{!\widehat{\otimes}^{\varphi, \sigma}(\vec{X})} & !\otimes^\sigma(\widehat{\varphi}(\vec{X})) \end{array}$$

$$\begin{array}{ccc}
\otimes^\sigma(!\vec{X}) & \xrightarrow{\otimes^\sigma(w_{\vec{X}})} & \otimes^\sigma \vec{1} = \otimes^{\sigma_0} & \otimes^\sigma(!\vec{X}) & \xrightarrow{\otimes^\sigma(d_{\vec{X}})} & \otimes^\sigma \vec{X} \\
\mu_{\vec{X}}^\sigma \downarrow & & \downarrow \otimes^{\sigma_0} & \mu_{\vec{X}}^\sigma \downarrow & & \downarrow \otimes^\sigma \\
! \otimes^\sigma(\vec{X}) & \xrightarrow{w_{\otimes^\sigma(\vec{X})}} & 1 = \otimes^\langle \rangle & ! \otimes^\sigma(\vec{X}) & \xrightarrow{d_{\otimes^\sigma(\vec{X})}} & \otimes^\sigma \vec{X}
\end{array}$$

where $\vec{1}$ is the sequence $(1, \dots, 1)$ (n elements) and $\sigma_0 = \sigma[\langle \rangle / *] \in \mathcal{T}_0$ (the tree obtained from σ by replacing each occurrence of $*$ by $\langle \rangle$).

Before stating the next commutation, we define a generalized form of contraction $c_{\vec{X}}^\sigma : \otimes^\sigma ! \vec{X} \rightarrow \otimes^{\langle \sigma, \sigma \rangle} (! \vec{X}, ! \vec{X})$ as the following composition of morphisms:

$$\otimes^\sigma ! \vec{X} \xrightarrow{\otimes^\sigma c_{\vec{X}}} \otimes^{\sigma_2} ! \vec{X}' \xrightarrow{\hat{\otimes}^{\varphi, \sigma}} \otimes^{\sigma_2} (! \vec{X}, ! \vec{X}) \xrightarrow{\otimes^{\sigma_2}} \otimes^{\langle \sigma, \sigma \rangle} (! \vec{X}, ! \vec{X})$$

where $\vec{X}' = (X_1, X_1, X_2, X_2, \dots, X_n, X_n)$, $\sigma_2 = \sigma[(*, *) / *]$ and $\varphi \in \mathfrak{S}_{2n}$ is defined by $\varphi(2i+1) = i+1$ and $\varphi(2i+2) = i+n+1$ for $i \in \{0, \dots, n-1\}$. With these notations, one can prove that

$$\begin{array}{ccc}
\otimes^\sigma ! \vec{X} & \xrightarrow{c_{\vec{X}}^\sigma} & \otimes^{\langle \sigma, \sigma \rangle} (! \vec{X}, ! \vec{X}) = (\otimes^\sigma ! \vec{X}) \otimes (\otimes^\sigma ! \vec{X}) \\
\mu_{\vec{X}}^\sigma \downarrow & & \downarrow \mu_{\vec{X}}^\sigma \otimes \mu_{\vec{X}}^\sigma \\
! \otimes^\sigma \vec{X} & \xrightarrow{c_{\otimes^\sigma(\vec{X})}} & (! \otimes^\sigma \vec{X}) \otimes (! \otimes^\sigma \vec{X})
\end{array}$$

We also define a generalized version of digging $p_{\vec{X}}^\sigma : \otimes^\sigma ! \vec{X} \rightarrow ! \otimes^\sigma \vec{X}$ as the following composition of morphisms:

$$\otimes^\sigma ! \vec{X} \xrightarrow{\otimes^\sigma p_{\vec{X}}} \otimes^\sigma !! \vec{X} \xrightarrow{\mu_{!! \vec{X}}^\sigma} ! \otimes^\sigma \vec{X}$$

With this notation, one can prove that

$$\begin{array}{ccc}
\otimes^\sigma ! \vec{X} & \xrightarrow{p_{\vec{X}}^\sigma} & ! \otimes^\sigma \vec{X} \\
\mu_{\vec{X}}^\sigma \downarrow & & \downarrow ! \mu_{\vec{X}}^\sigma \\
! \otimes^\sigma \vec{X} & \xrightarrow{p_{\otimes^\sigma \vec{X}}} & !! \otimes^\sigma \vec{X}
\end{array}$$

We have $p^\langle \rangle = \mu^0$, $p_X^* = p_X$, and observe that the following generalizations of the comonad laws hold. The two commutations involving digging and dereliction generalize to:

$$\begin{array}{ccccc}
& & \otimes^\sigma ! \vec{X} & & \\
& \swarrow & \downarrow p_{\vec{X}}^\sigma & \searrow \mu_{\vec{X}}^\sigma & \\
\otimes^\sigma ! \vec{X} & & ! \otimes^\sigma \vec{X} & & ! \otimes^\sigma \vec{X} \\
& \swarrow d_{\otimes^\sigma \vec{X}} & & \searrow ! \otimes^\sigma d_{\vec{X}} & \\
& & & &
\end{array}$$

The square diagram involving digging generalizes as follows. Let $\vec{Y} = (Y_1, \dots, Y_m)$ be another list of objects and let $\tau \in \mathcal{T}_m$. One can prove that

$$\begin{array}{ccc} \otimes^\sigma !\vec{X} & \xrightarrow{p_{\vec{X}}^\sigma} & !\otimes^\sigma \vec{X} \\ p_{\vec{X}}^\sigma \downarrow & & \downarrow !p_{\vec{X}}^\sigma \\ !\otimes^\sigma !\vec{X} & \xrightarrow{p_{\otimes^\sigma !\vec{X}}} & !!\otimes^\sigma !\vec{X} \end{array}$$

and then one can generalize this property as follows

$$\begin{array}{ccc} (\otimes^\sigma !\vec{X}) \otimes (\otimes^\tau !\vec{Y}) & \xrightarrow{p_{\vec{X}, \vec{Y}}^{(\sigma, \tau)}} & !((\otimes^\sigma !\vec{X}) \otimes (\otimes^\tau !\vec{Y})) \\ p_{\vec{X}}^\sigma \otimes (\otimes^\tau !\vec{Y}) \downarrow & & \downarrow !(p_{\vec{X}}^\sigma \otimes (\otimes^\tau !\vec{Y})) \\ !(\otimes^\sigma !\vec{X}) \otimes (\otimes^\tau !\vec{Y}) & \xrightarrow{p_{\otimes^\sigma !\vec{X}, \vec{Y}}^{(*, \tau)}} & !(!(\otimes^\sigma !\vec{X}) \otimes (\otimes^\tau !\vec{Y})) \end{array} \quad (10)$$

2.6.7 Generalized promotion and structural constructions.

Let $f : \otimes^\sigma !\vec{X} \rightarrow Y$, we define the *generalized promotion* $f^! : \otimes^\sigma !\vec{X} \rightarrow !Y$ by $f^! = !f \circ p_{\vec{X}}^\sigma$. Using the commutations of Section 2.6.6, one can prove that this construction obeys the following commutations.

$$\begin{array}{ccc} \otimes^\sigma !\vec{X} & \xrightarrow{f^!} & !Y \\ \otimes^\sigma w_{\vec{X}} \downarrow & & \downarrow w_Y \\ \otimes^\sigma \vec{1} = \otimes^{\sigma_0} & \xrightarrow{\otimes_{\langle \rangle}^{\sigma_0}} & \otimes_{\langle \rangle} = 1 \end{array}$$

with the same notations as before.

With these notations, we have

$$\begin{array}{ccc} \otimes^\sigma !\vec{X} & \xrightarrow{f^!} & !Y \\ c_{\vec{X}}^\sigma \downarrow & & \downarrow c_Y \\ \otimes^{\langle \sigma, \sigma \rangle} (!\vec{X}, !\vec{X}) & \xrightarrow{f^! \otimes f^!} & !Y \otimes !Y \end{array}$$

The next two diagrams deal with the interaction between generalized promotion and dereliction (resp. digging).

$$\begin{array}{ccc} \otimes^\sigma !\vec{X} & \xrightarrow{f^!} & !Y \\ & \searrow f & \downarrow d_Y \\ & & Y \end{array}$$

$$\begin{array}{ccc}
(\otimes^\sigma !\vec{X}) \otimes (\otimes^\tau !\vec{Y}) & \xrightarrow{f^! \otimes (\otimes^\tau !\vec{Y})} & !Y \otimes (\otimes^\tau !\vec{Y}) \\
\downarrow \mathfrak{p}_{\vec{X}, \vec{Y}}^{(\sigma, \tau)} & & \downarrow \mathfrak{p}_{Y, \vec{Y}}^{(*, \tau)} \\
!(\otimes^\sigma !\vec{X}) \otimes (\otimes^\tau !\vec{Y}) & \xrightarrow{!(f^! \otimes (\otimes^\tau !\vec{Y}))} & !(Y \otimes (\otimes^\tau !\vec{Y}))
\end{array}$$

The second diagram follows easily from (10) and allows one to prove the following property. Let $f : \otimes^\sigma !\vec{X} \rightarrow Y$ and $g : !Y \otimes (\otimes^\tau !\vec{Y}) \rightarrow Z$ so that $f^! : \otimes^\sigma !\vec{X} \rightarrow !Y$ and $g^! : !Y \otimes (\otimes^\tau !\vec{Y}) \rightarrow !Z$; one has

$$g^!(f^! \otimes (\otimes^\tau !\vec{Y})) = (g^!(f^! \otimes (\otimes^\tau !\vec{Y})))^! : (\otimes^\sigma !\vec{X}) \otimes (\otimes^\tau !\vec{Y}) \rightarrow !Z$$

Remark: We actually need a more general version of this property, where $f^!$ is not necessarily in leftmost position in the \otimes tree. It is also easy to obtain, but notations are more heavy. We use the same kind of convention in the sequel but remember that the corresponding properties are easy to generalize.

2.6.8 Generalized promotion and costructural constructions.

Let $f : !X \otimes (\otimes^\sigma !\vec{X}) \rightarrow Y$. Observe that $f(\bar{w}_X \otimes (\otimes^\sigma !\vec{X})) \otimes_{\langle \langle \cdot, \sigma \rangle \rangle !\vec{X}}^\sigma : \otimes^\sigma !\vec{X} \rightarrow Y$. The following equation holds:

$$f^!(\bar{w}_X \otimes (\otimes^\sigma !\vec{X})) \otimes_{\langle \langle \cdot, \sigma \rangle \rangle !\vec{X}}^\sigma = (f(\bar{w}_X \otimes (\otimes^\sigma !\vec{X})) \otimes_{\langle \langle \cdot, \sigma \rangle \rangle !\vec{X}}^\sigma)^!$$

Similarly, we have $f(\bar{c}_X \otimes (\otimes^\sigma !\vec{X})) : (!X \otimes !X) \otimes (\otimes^\sigma !\vec{X}) \rightarrow Y$ and the following equation holds:

$$f^!(\bar{c}_X \otimes (\otimes^\sigma !\vec{X})) = (f(\bar{c}_X \otimes (\otimes^\sigma !\vec{X})))^!$$

This results from the commutations of Sections 2.6.2 and 2.6.4.

2.6.9 Generalized promotion and codereliction (also known as *chain rule*).

Let $f : !X \otimes (\otimes^\sigma !\vec{X}) \rightarrow Y$. We set

$$f_0 = f(\bar{w}_X \otimes (\otimes^\sigma !\vec{X})) \otimes_{\langle \langle \cdot, \sigma \rangle \rangle}^\sigma : \otimes^\sigma !\vec{X} \rightarrow Y$$

Then we have

$$\begin{array}{ccccc}
X \otimes (\otimes^\sigma !\vec{X}) & \xrightarrow{\bar{d}_X \otimes (\otimes^\sigma !\vec{X})} & !X \otimes (\otimes^\sigma !\vec{X}) & \xrightarrow{f^!} & !Y \\
\downarrow \bar{d}_X \otimes c_X^\sigma & & & & \uparrow \bar{c}_Y \\
!X \otimes ((\otimes^\sigma !\vec{X}) \otimes (\otimes^\sigma !\vec{X})) & & & & \\
\downarrow \otimes_{\langle \langle (*, *) \rangle \rangle}^{(*, (*, *), *)} & & & & \\
(!X \otimes (\otimes^\sigma !\vec{X})) \otimes (\otimes^\sigma !\vec{X}) & \xrightarrow{f \otimes f_0} & Y \otimes !Y & \xrightarrow{\bar{d}_Y \otimes !Y} & !Y \otimes !Y
\end{array}$$

This results from the commutations of Sections 2.6.2 and 2.6.4.

2.6.10 Interpreting DILL derivations.

For the sake of readability, we assume here that the De Morgan isomorphisms (see 2.3.4) are identities, so that $[A^\perp] = [A]^\perp$ for each formula A . The general definition of the semantics can be obtained by inserting De Morgan isomorphisms at the correct places in the forthcoming expressions.

Let P be a net of arity $n+1$ and let $p_i = (\vec{c}_i; \vec{t}_i, t_i)$ for $i = 1, \dots, n$. Consider the following derivation π , where we denote as $\lambda, \rho_1, \dots, \rho_n$ the derivations of the premises.

$$\frac{\Phi \vdash P : ?A_1^\perp, \dots, ?A_n^\perp, B \quad \Phi \vdash p_1 : \Gamma_1, !A_1 \cdots \Phi \vdash p_n : \Gamma_n, !A_n}{\Phi \vdash (\vec{c}_1, \dots, \vec{c}_n; \vec{t}_1, \dots, \vec{t}_n, P^{!(n)}(t_1, \dots, t_n)) : \Gamma_1, \dots, \Gamma_n, !B}$$

By inductive hypothesis, we have $[\lambda] \in \vec{\mathcal{L}}((!A_1)^\perp, \dots, (!A_n)^\perp, [B])$ so that, picking an element σ of \mathcal{T}_n we have

$$\begin{aligned} [\lambda]_{\langle \sigma, * \rangle} &\in \mathcal{L}(1, \mathfrak{A}^\sigma((!A_1)^\perp, \dots, (!A_n)^\perp) \mathfrak{A}[B]) \\ &= \mathcal{L}(1, \otimes^\sigma(!A_1, \dots, !A_n) \multimap [B]) \end{aligned}$$

and hence

$$(\text{cur}^{-1}([\lambda]_{\langle \sigma, * \rangle}) \otimes_{\langle \langle \rangle, \sigma \rangle}^\sigma)^! \in \mathcal{L}(\otimes^\sigma(!A_1, \dots, !A_n), ![B]).$$

For $i = 1, \dots, n$, we have $[\rho_i] \in \vec{\mathcal{L}}([\Gamma_i], ![A_i])$. Let l_i be the length of Γ_i , and let us choose $\tau_i \in \mathcal{T}_{l_i}$. We have $[\rho_i]_{\langle \tau_i, * \rangle} \in \mathcal{L}(1, \mathfrak{A}^{\tau_i}([\Gamma_i]) \mathfrak{A}![A_i])$ and hence, setting

$$r_i = \text{cur}^{-1}([\rho_i]_{\langle \tau_i, * \rangle}) \otimes_{\langle \langle \rangle, \tau_i \rangle}^{\tau_i} \in \mathcal{L}(\otimes^{\tau_i}([\Gamma_i]^\perp, ![A_i]))$$

we have $\otimes^\sigma(\vec{r}) \in \mathcal{L}(\otimes^\theta([\Delta]^\perp), \otimes^\sigma(!A_1, \dots, !A_n))$ where

$$\begin{aligned} \Delta &= \Gamma_1, \dots, \Gamma_n \\ \theta &= \sigma(\tau_1, \dots, \tau_n) \end{aligned}$$

where $\sigma(\tau_1, \dots, \tau_n)$ (for $\sigma \in \mathcal{T}_n$ and $\tau_i \in \mathcal{T}_{n_i}$ for $i = 1, \dots, k$) is the element of $\mathcal{T}_{n_1 + \dots + n_k}$ defined inductively by

$$\begin{aligned} \langle \rangle &= \langle \rangle \\ * &(\tau) = \tau \\ \langle \sigma, \sigma' \rangle &(\tau_1, \dots, \tau_n) = \langle \sigma(\tau_1, \dots, \tau_k), \sigma'(\tau_{k+1}, \dots, \tau_n) \rangle \\ &\text{where } \sigma \in \mathcal{T}_k, \sigma' \in \mathcal{T}_{n-k} \end{aligned}$$

We have therefore

$$(\text{cur}^{-1}([\lambda]_{\langle \sigma, * \rangle}) \otimes_{\langle \langle \rangle, \sigma \rangle}^\sigma)^! \otimes^\sigma(\vec{r}) \in \mathcal{L}(\otimes^\theta([\Delta]^\perp), [B])$$

We set

$$[\pi]_\theta = \text{cur}((\text{cur}^{-1}([\lambda]_{\langle \sigma, * \rangle}) \otimes_{\langle \langle \rangle, \sigma \rangle}^\sigma)^! \otimes^\sigma(\vec{r}) \otimes_\theta^{\langle \langle \rangle, \theta \rangle}) \in \mathcal{L}(1, \mathfrak{A}^{\langle \theta, * \rangle}([\Delta], !B))$$

and this gives us a definition of $[\pi] \in \vec{\mathcal{L}}([\Delta], !B)$ which does not depend on the choice of θ .

Theorem 7 *Let π and π' be derivations of $\Phi \vdash p : \Gamma$. Then $[\pi] = [\pi']$.*

Again, we set $[p] = [\pi]$ where π is a derivation of $\Phi \vdash p : \Gamma$.

Theorem 8 *Assume that $\Phi \vdash p : \Gamma$, $\Phi \vdash p' : \Gamma$ and that $p \rightsquigarrow p'$. Then $[p] = [p']$.*

The proofs of these results are tedious inductions, using the commutations described in paragraphs 2.6.7, 2.6.8 and 2.6.9.

2.7 The differential λ -calculus

Various λ -calculi have been proposed, as possible extensions of the ordinary λ -calculus with constructions corresponding to the above differential and costructural rules of differential LL. We record here briefly our original syntax of [ER03], simplified by Vaux in [Vau05]¹⁰.

A *simple term* is either

- a variable x ,
- or an ordinary application $(M)R$ where M is a simple terms and R is a term,
- or an abstraction $\lambda x M$ where x is a variable and M is a simple term,
- or a differential application $DM \cdot N$ where M and N are simple terms.

A *term* is a finite linear combination of simple terms, with coefficients in \mathbf{k} . Substitution of a term R for a variable x in a simple term M , denoted as $M[R/x]$ is defined as usual, whereas differential (or linear) substitution of a simple term for a variable in another simple term, denoted as $\frac{\partial M}{\partial x} \cdot N$, is defined as follows:

$$\begin{aligned} \frac{\partial y}{\partial x} \cdot t &= \begin{cases} t & \text{if } x = y \\ 0 & \text{otherwise} \end{cases} \\ \frac{\partial \lambda y M}{\partial x} \cdot N &= \lambda y \frac{\partial M}{\partial x} \cdot N \\ \frac{\partial DM \cdot N}{\partial x} \cdot P &= D\left(\frac{\partial M}{\partial x} \cdot P\right) \cdot N + DM \cdot \left(\frac{\partial N}{\partial x} \cdot P\right) \\ \frac{\partial (M)R}{\partial x} \cdot N &= \left(\frac{\partial M}{\partial x} \cdot N\right)R + \left(DM \cdot \left(\frac{\partial R}{\partial x} \cdot N\right)\right)R \end{aligned}$$

All constructions are linear, except for ordinary application which is not linear in the argument. This means that when we write e.g. $(M_1 + M_2)R$, what we actually intend is $(M_1)R + (M_2)R$. Similarly, substitution $M[R/x]$ is linear in

¹⁰Alternative syntaxes have been proposed, which are formally closer to Boudol's calculus with multiplicities or with resources and are therefore often called *resource λ -calculi*

M and not in R , whereas differential substitution $\frac{\partial M}{\partial x} \cdot N$ is linear in both M and N . There are two reduction rules:

$$(\lambda x M) R \beta M [R/x]$$

$$D(\lambda x M) \cdot N \beta_d \lambda x \left(\frac{\partial M}{\partial x} \cdot N \right)$$

which have of course to be closed under arbitrary contexts. The resulting calculus can be proved to be Church-Rosser using fairly standard techniques (Tait - Martin-Löf), to have good normalization properties in the typed case etc, see [ER03, Vau05]. To be more precise, Church-Rosser holds only up to the least congruence on terms which identifies $D(DM \cdot N_1) \cdot N_2$ and $D(DM \cdot N_2) \cdot N_1$, a syntactic version of Schwarz Lemma: terms are always considered up to this congruence called below *symmetry of derivatives*.

2.7.1 Resource calculus.

Differential application can be iterated: given simple terms M, N_1, \dots, N_n , we define $D^n M \cdot (N_1, \dots, N_n) = D(\dots DM \cdot N_1 \dots) \cdot N_n$; the order on the terms N_1, \dots, N_n does not matter, by symmetry of derivatives. The (general) resource calculus is another syntax for the differential λ -calculus, in which the combination $(D^n M \cdot (N_1, \dots, N_n)) R$ is considered as one single operation denoted e.g. as $M[N_1, \dots, N_n, R^\infty]$ where the superscript ∞ is here to remind that R can be arbitrarily duplicated during reduction, unlike the N_i 's. This presentation of the calculus, studied in particular by Tranquilli and Pagani, and also used for instance in [BCEM11], has very good properties as well. It is formally close to Boudol's λ -calculus with multiplicities such as presented in [BCL99], with the difference that the operational semantics of Boudol's calculus is given as a rewriting strategy whereas in the differential version of the resource λ -calculus, redexes can be reduced everywhere in terms. The price to pay is that reduction becomes non-deterministic in the sense that it can produce formal sums of terms.

2.7.2 The finite resource calculus.

If, in the resource calculus above, one restricts one's attention to the terms where all applications are of the form

$$M[N_1, \dots, N_n, 0^\infty]$$

which corresponds to the differential term $(D(\dots DM \cdot N_1 \dots) \cdot N_n) 0$, then one gets a calculus which is stable under reduction and where all terms are strongly normalizing. This calculus, called the *finite resource calculus*, can be presented as follows.

- Any variable x is a term.
- If x is a variable and s is a simple term then $\lambda x s$ is a simple term.

- If S is a finite multiset (also called *bunch* in the sequel) of simple terms then $\langle s \rangle S$ is a simple term. Intuitively, this term stands for the application $s[s_1, \dots, s_n, 0^\infty]$ of the resource calculus, where $[s_1, \dots, s_n] = S$.

A term is a (possibly infinite¹¹) linear combination of finite terms. This syntax is extended from simple terms to general terms by linearity. For instance, the term $\langle x \rangle [y + z, y + z]$ stands for $\langle x \rangle [y, y] + 2 \langle x \rangle [y, z] + \langle x \rangle [z, z]$.

In the finite resource calculus, it is natural to perform several β_d -reductions in one step, and one gets

$$\langle \lambda x s \rangle S \beta_d \begin{cases} \sum_{f \in \mathfrak{S}_n} s [s_{f(1)}/x_1, \dots, s_{f(n)}/x_n] & \text{if } \mathbf{deg}_s x = n \\ 0 & \text{otherwise} \end{cases}$$

where $d = \mathbf{deg}_x s$ is the number of occurrences of x in s (which is a simple term), x_1, \dots, x_d are the occurrences of x in s and the multiset S is $[s_1, \dots, s_n]$.

Again, this calculus enjoys confluence, and also strong normalization (even in the untyped case). It can be used for hereditarily Taylor expanding λ -terms as explained in [ER08, ER06, Ehr10].

Taylor expansion consists in hereditarily replacing, in a differential λ -term, any ordinary application $(M) N$ by the infinite sum

$$\sum_{n=0}^{\infty} \frac{1}{n!} (D^n M \cdot (N, \dots, N)) 0.$$

More precisely, it is a transformation $M \mapsto M^*$ from resource terms to finite resource terms which is defined as follows:

$$\begin{aligned} x^* &= x \\ (\lambda x M)^* &= \lambda x (M^*) \\ M[N_1, \dots, N_n, R^\infty]^* &= \sum_{p=0}^{\infty} \frac{1}{p!} \langle M^* \rangle [N_1^*, \dots, N_n^*, R^*, \dots, R^*] \end{aligned}$$

so that the Taylor expansion of a resource term is a generally infinite linear combination of finite resource terms. In the definition above, we use the extension by linearity of the syntax of finite resource terms to arbitrary (possibly infinite) linear combinations. The coefficients belong to the considered semi-ring \mathbf{k} where division by positive natural numbers must be possible.

In [ER08, ER06] we studied the behavior of this expansion with respect to differential β -reduction in the case where the expanded terms come from the λ -calculus (that is, do not contain differential applications; this is the *uniform* case), and we exhibited tight connections between this operation and Krivine's machine, an implementation of linear head reduction.

¹¹When considering infinite linear combinations, one has to deal with the possibility of unbounded coefficients appearing during the reduction. One option is to accept infinite coefficients, but it is also possible to prevent this phenomenon to occur by topological means as explained in [Ehr10].

There is a simple translation from resource terms (or differential terms) to DiLL proof-nets. When restricted to the finite resource calculus, this translation ranges in DiLL₀. This translation extends Girard's Translation from the λ -calculus to LL proof-nets.

3 More on exponential structures

We address here two aspects of exponential structures: we study a simple condition expressing that a map whose derivative is uniformly equal to 0 must be constant, and we propose an axiomatization of antiderivatives in this categorical setting.

So we assume to be given a preadditive *-autonomous category \mathcal{L} equipped with an exponential structure in the sense of Section 2.5, and we use the same notations as in this section.

For the sake of notational simplicity, we do as if \otimes were strictly associative and 1 were strictly neutral for \otimes . In other words, we do not mention the isos λ , ρ and α in our computations, just as if they were identities (see Section 2.2). Given an object X and $n \in \mathbb{N}$ of \mathcal{L} , we use $X^{\otimes n}$ for the n th tensor power of X : $X^{\otimes 0} = 1$ and $X^{\otimes(n+1)} = X^{\otimes n} \otimes X$.

Given an object X of \mathcal{L} , we define a morphism $\bar{\partial}_X \in \mathcal{L}(!X \otimes X, !X)$ as the following composition of morphisms

$$!X \otimes X \xrightarrow{!X \otimes \bar{d}_X} !X \otimes !X \xrightarrow{\bar{c}_X} !X$$

More generally, we define $\bar{\partial}_X^n \in \mathcal{L}(!X \otimes X^{\otimes n}, !X)$:

$$\begin{aligned} \bar{\partial}_X^0 &= \text{Id}_{!X} \\ \bar{\partial}_X^{n+1} &= \bar{\partial}_X (\bar{\partial}_X^n \otimes X) \end{aligned}$$

Last we set

$$\bar{d}_X^n = \bar{\partial}_X^n (\bar{w}_X \otimes X^{\otimes n}) \in \mathcal{L}(X^{\otimes n}, !X).$$

We define dually $\partial_X \in \mathcal{L}(!X, !X \otimes X)$ as $\partial_X = (!X \otimes d_X) c_X$ and $\partial_X^n \in \mathcal{L}(!X, !X \otimes X^{\otimes n})$ by $\partial_X^0 = \text{Id}_{!X}$ and $\partial_X^{n+1} = (\partial_X^n \otimes X) \partial_X$. And we set

$$d_X^n = (w_X \otimes X^{\otimes n}) \partial_X^n \in \mathcal{L}(!X, X^{\otimes n}).$$

Observe that we have $\bar{d}_X^1 = \bar{d}_X$ and $d_X^1 = d_X$.

Consider now some $f \in \mathcal{L}(!X, Y)$, to be intuitively seen as a non linear map from X to Y (if $!_-$ were assumed to be a comonad as in Section 2.6, then f would be a morphism in the Kleisli category $\mathcal{L}_!$). Such a morphism will sometimes be called a “regular function” in the sequel, but keep in mind that it is not even a function in general. For instance, if X and Y are vector spaces (with a topological structure, in the infinite dimensional case), such a regular function could typically be a smooth or an analytic function.

With these notations, $f \bar{w}_X \in \mathcal{L}(1, Y)$ should be understood as the point of Y obtained by applying the regular function f to 0. Similarly, $f \bar{c}_X \in \mathcal{L}(!X \otimes !X, Y)$ should be understood as the regular function $g : X \times X \rightarrow Y$ defined by $g(x_1, x_2) = f(x_1 + x_2)$.

Dually, given $y \in \mathcal{L}(1, Y)$ considered as a point of Y , then $y w_X \in \mathcal{L}(!X, Y)$ should be understood as the constant regular function which takes y as unique value. If $g \in (!X \otimes !X, Y)$, to be considered as a regular function with two parameters $X \times X \rightarrow Y$, then $f = g c_X \in \mathcal{L}(!X, Y)$ should be understood as the regular function $X \rightarrow Y$ given by $f(x) = g(x, x)$. Given $g \in \mathcal{L}(X, Y)$, to be considered as a linear function from X to Y , $f = g d_X \in \mathcal{L}(!X, Y)$ is g , considered now as a regular function from X to Y .

The basic idea of DiLL is that $f' = f \bar{\partial}_X \in \mathcal{L}(!X \otimes X, Y)$ (that is $f' \in \mathcal{L}(!X, X \multimap Y)$, up to linear curryfication) represents the *derivative* of f .

Remember indeed that if $f : X \rightarrow Y$ is a smooth function from a vector space X to a vector space Y , the derivative of f is a function f' from X to the space $X \multimap Y$ of (continuous) linear functions from X to Y : f' maps $x \in X$ to a linear map $f'(x) : X \rightarrow Y$, the differential (or Jacobian) of f at point x , which maps $u \in X$ to $f'(x) \cdot u$.

In particular, $f d_X = f \bar{\partial}_X (\bar{w}_X \otimes X) \in \mathcal{L}(X, Y)$ corresponds to $f'(0)$, the differential of f at 0.

More generally, $f \bar{\partial}_X^n \in \mathcal{L}(!X \otimes X^{\otimes n}, Y)$ represents the n th derivative of f , which is a regular function from X to the space of n -linear functions from X^n to Y (these n linear functions are actually symmetric, a property called ‘‘Schwarz Lemma’’ and is axiomatized here by the commutativity of the algebra structure of $!X$).

The axioms of an exponential structure express that this categorical definition of differentiation satisfies the usual laws of differentiation. Let us give a simple example. Consider $f \in \mathcal{L}(!X \otimes !X, Y)$, to be seen as a regular function $f(x_1, x_2)$ depending on two parameters x_1 and x_2 in X . Remember that $g = f c_X \in \mathcal{L}(!X, Y)$ represents the map depending on one parameter x in X given by $g(x) = f(x, x)$.

Using the axioms of exponential structures, one checks easily that

$$c_X \bar{\partial}_X = (!X \otimes \bar{\partial}_X) + (\bar{\partial}_X \otimes !X) (!X \otimes \sigma) (c_X \otimes X)$$

which, by composing with f and using standard algebraic notations, gives

$$g'(x) \cdot u = f'_1(x, x) \cdot u + f'_2(x, x) \cdot u$$

where we use f'_i for the i th partial derivative of f and ‘‘ \cdot ’’ for the linear application of the differential. This is Leibniz law.

Similarly, the easily proven equation $w_X \bar{\partial}_X = 0$ expresses that the derivative of a constant map is equal to 0.

It is a nice exercise to interpret similarly the dual equations

$$\begin{aligned} \partial_X \bar{c}_X &= (\bar{c}_X \otimes X) (!X \otimes \partial_X) + (!X \otimes \sigma) (\partial_X \otimes !X) \\ \partial_X \bar{w}_X &= 0 \end{aligned}$$

Consider $g \in \mathcal{L}(!X \otimes X, Y)$, to be considered as a regular function $X \times X \rightarrow Y$ which is linear in its second parameter. Then $f = g \partial_X \in \mathcal{L}(!X, Y)$ is the regular function $X \rightarrow Y$ given by $g(x) = f(x, x)$. The second equation corresponds to the fact that $g(0, 0) = 0$, and the first one, to the fact that $g(x_1 + x_2, x_1 + x_2) = g(x_1 + x_2, x_1) + g(x_1 + x_2, x_2)$.

3.1 Taylor exponential structures.

Let \mathcal{L} be an exponential structure and let $f \in \mathcal{L}(!X, Y)$, to be considered as a “regular function” from X to Y . The condition $f \bar{\partial}_X = 0$ means intuitively that the derivative of f is uniformly equal to 0, and hence, according to standard intuitions on differentiation, f should be a constant map. In other words we should have $f = f \bar{w}_X w_X$.

This property can be stated in a more general way as follows: let $f_1, f_2 : !X \rightarrow Y$, then

$$f_1 \bar{\partial}_X = f_2 \bar{\partial}_X \Rightarrow f_1 + (f_2 \bar{w}_X w_X) = f_2 + (f_1 \bar{w}_X w_X)$$

and does not seem to be derivable from the other axioms of exponential structures. The converse implication is easy to prove.

Remark: There is a dual condition which reads as follows: if $f_1, f_2 : Y \rightarrow !X$, then

$$\partial_X f_1 = \partial_X f_2 \Rightarrow f_1 + (\bar{w}_X w_X f_2) = f_2 + (\bar{w}_X w_X f_1)$$

The intuition is that, given $f : Y \rightarrow !X$, to be considered as a generalized point of $!X$, if $\partial_X f = 0$, then the range of f is included in the subspace of $!X$ generated by the unit of the bialgebra $!X$. In other words, this condition means that the kernel of ∂_X is generated by this unit.

We say that the exponential structure \mathcal{L} is Taylor if it satisfies the first condition.

For $n \in \mathbb{N}$, let $T_X^n \in \mathcal{C}(!X, !X)$ be defined by

$$T_X^n = \sum_{i=0}^n \frac{1}{i!} \bar{d}_X^i d_X^i.$$

Lemma 9 *For any $n > 0$, we have*

$$T_X^n \bar{\partial}_X = \bar{\partial}_X (T_X^{n-1} \otimes \text{Id}_X).$$

Proof.

This results from

$$\bar{d}_X^n d_X^n \bar{\partial}_X = n \bar{\partial}_X ((\bar{d}_X^{n-1} d_X^{n-1}) \otimes \text{Id}_X)$$

which comes from the basic equations of exponential structures. \square

Remember that a commutative monoid M is cancellative if, in M , one has $u + v = u' + v \Rightarrow u = u'$.

Proposition 10 *Assume that \mathcal{L} is Taylor and that each homset $\mathcal{L}(X, Y)$ is a cancellative monoid. Let $n \in \mathbb{N}$ and let $f_1, f_2 : !X \rightarrow Y$. If $f_1 \bar{\partial}_X^{n+1} = f_2 \bar{\partial}_X^{n+1}$ then $f_1 + (f_2 \mathbb{T}_X^n) = f_2 + (f_1 \mathbb{T}_X^n)$.*

In particular, if $f \bar{\partial}_X^{n+1} = 0$ (that is, the $(n+1)$ -th derivative of f is uniformly equal to 0), then $f = f \mathbb{T}_X^n$, meaning that f is equal to its Taylor expansion of rank n .

Proof.

By induction on n . For $n = 0$, this is simply the hypothesis that \mathcal{L} is Taylor. Assume now that $f_1 \bar{\partial}_X^{n+2} = f_2 \bar{\partial}_X^{n+2}$ and let us prove that $f_1 + (f_2 \mathbb{T}_X^{n+1}) = f_2 + (f_1 \mathbb{T}_X^{n+1})$.

We have $f_1 \bar{\partial}_X (\bar{\partial}_X^{n+1} \otimes \text{Id}_X) = f_2 \bar{\partial}_X (\bar{\partial}_X^{n+1} \otimes \text{Id}_X)$. By monoidal closeness, we have $\text{cur}(f_1 \bar{\partial}_X) \bar{\partial}_X^{n+1} = \text{cur}(f_2 \bar{\partial}_X) \bar{\partial}_X^{n+1}$ and hence, by inductive hypothesis, we have

$$\text{cur}(f_1 \bar{\partial}_X) + (\text{cur}(f_2 \bar{\partial}_X) \mathbb{T}_X^n) = \text{cur}(f_2 \bar{\partial}_X) + (\text{cur}(f_1 \bar{\partial}_X) \mathbb{T}_X^n)$$

that is

$$\text{cur}(f_1 \bar{\partial}_X) + (\text{cur}(f_2 \bar{\partial}_X (\mathbb{T}_X^n \otimes \text{Id}_X))) = \text{cur}(f_2 \bar{\partial}_X) + (\text{cur}(f_1 \bar{\partial}_X (\mathbb{T}_X^n \otimes \text{Id}_X)))$$

and hence

$$(f_1 \bar{\partial}_X) + (f_2 \bar{\partial}_X (\mathbb{T}_X^n \otimes \text{Id}_X)) = (f_2 \bar{\partial}_X) + (f_1 \bar{\partial}_X (\mathbb{T}_X^n \otimes \text{Id}_X))$$

so applying Lemma 9, we get

$$(f_1 + f_2 \mathbb{T}_X^{n+1}) \bar{\partial}_X = (f_2 + f_1 \mathbb{T}_X^{n+1}) \bar{\partial}_X.$$

Applying the hypothesis that \mathcal{L} is Taylor, we get

$$f_1 + f_2 \mathbb{T}_X^{n+1} + (f_2 + f_1 \mathbb{T}_X^{n+1}) \bar{w}_X w_X = f_2 + f_1 \mathbb{T}_X^{n+1} + (f_1 + f_2 \mathbb{T}_X^{n+1}) \bar{w}_X w_X$$

and since $\mathbb{T}_X^{n+1} \bar{w}_X w_X = \bar{w}_X w_X$ we get $f_1 + f_2 \mathbb{T}_X^{n+1} + (f_1 + f_2) \bar{w}_X w_X = f_2 + f_1 \mathbb{T}_X^{n+1} + (f_2 + f_1) \bar{w}_X w_X$ and so, applying the cancellativeness hypothesis, we get finally

$$f_1 + f_2 \mathbb{T}_X^{n+1} = f_2 + f_1 \mathbb{T}_X^{n+1}$$

as required. \square

3.1.1 The category of polynomials.

We say that $f \in \mathcal{L}(!X, Y)$ is *polynomial* if there exists $n \in \mathbb{N}$ such that $f \bar{\partial}_X^{n+1} = 0$, and we call *degree* of f the least such n . The morphism $\text{d}_X \in \mathcal{C}(!X, X)$ is polynomial of degree 1.

Let $f \in \mathcal{L}(!X, Y)$ and $g \in \mathcal{L}(!Y, Z)$ be polynomial of degree m and n respectively. We define the composition $g \circ f \in \mathcal{L}(!X, Z)$ as follows

$$g \circ f = \sum_{i=0}^n \frac{1}{i!} g \bar{d}_Y^i f^{\otimes i} c_X^i.$$

where $f^{\otimes i} = \overbrace{f \otimes \cdots \otimes f}^{i \times}$.

Since $d_X \bar{d}_X^i = 0$ for $i \neq 1$, we get $d_X \circ g = g$. Next observe that $g \circ d_X = g T_X^g = g$ by Proposition 10. One can prove that $g \circ f$ is polynomial of degree $\leq mn$, that is $(g \circ f) \bar{\partial}_X^{mn} = 0$ by a straightforward (though boring) categorical computation using the basic axioms of exponential structures. Using the same axioms, one shows that this notion of composition is associative, so that we have defined a category of polynomial morphisms.

3.1.2 Weak functoriality and the category of polynomials.

We do not require this operation $X \mapsto !X$ to be functorial, but some weak form of functoriality can be derived from the above categorical axioms. Let $f \in \mathcal{L}(X, Y)$. By induction on n , we define a family of morphisms $f^n : !X \rightarrow !X$ as follows: $f^0 = \bar{w}_X w_X$ and

$$f^{n+1} = \bar{\partial}_X (f^n \otimes f) \partial_X.$$

Proposition 11 *Let $f \in \mathcal{L}(X, Y)$ and $g \in \mathcal{L}(Y, Z)$ and let $n, p \in \mathbb{N}$. Then*

$$g^p f^n = \begin{cases} n!(g f)^n & \text{if } n = p \\ 0 & \text{otherwise.} \end{cases}$$

Proof.

Simple calculation using the diagram commutations which define an exponential structure. \square

So for each $n \in \mathbb{N}$ we can define $!_n f = \sum_{q=0}^n \frac{1}{q!} f^q : !X \rightarrow !X$, and we have $!_n g !_n f = !_n (g f)$. So $f \mapsto !_n f$ is a quasifunctor, but not a functor as it does not map Id_X to $\text{Id}_{!X}$, but to an idempotent morphism $\rho_X^n : !X \rightarrow !X$.

In some concrete models, this sequence $(!_n f)_{n \in \mathbb{N}}$ can be said to be convergent, in a sense which depends of course on the model. The limit is then denoted as $!f$ and the operation defined in that way turns out often to be a true functor, defining a functorial exponential in the sense of Section 2.6.

3.2 Computing antiderivatives.

We say that an exponential structure \mathcal{L} has *antiderivatives* if the morphism

$$J_X = \text{Id}_X + (\bar{\partial}_X \partial_X) : !X \rightarrow !X$$

is an isomorphism. We explain why.

We assume to be given an exponential structure \mathcal{L} which has antiderivatives in that sense and we set $I_X = J_X^{-1}$.

In the sequel, we use the following notation

$$\psi_X = (\bar{\partial}_X \otimes \text{ld}_X) \sigma_{23} (\partial_X \otimes \text{ld}_X) : !X \otimes X \rightarrow !X \otimes X$$

where $\sigma_{23} = !X \otimes \sigma$ is an automorphism on $!X \otimes X \otimes X$, because this morphism ψ_X will show up quite often. Observe in particular that

$$\partial_X \bar{\partial}_X = \text{ld}_{!X \otimes X} + \psi_X .$$

Lemma 12 *The following commutation holds*

$$(I_X \otimes \text{ld}_X) \psi_X = \psi_X (I_X \otimes \text{ld}_X) \quad (11)$$

Proof.

Since $I_X = (\text{ld}_{!X} + (\bar{\partial}_X \partial_X))^{-1}$, we have $I_X \otimes \text{ld}_X = \varphi^{-1}$ where $\varphi = \text{ld}_{!X \otimes X} + ((\bar{\partial}_X \partial_X) \otimes \text{ld}_X)$ by functoriality of \otimes . To prove (11), it suffices therefore to prove that φ commutes with ψ_X . For this, it suffices to show that

$$((\bar{\partial}_X \partial_X) \otimes \text{ld}_X) \psi_X = \psi_X ((\bar{\partial}_X \partial_X) \otimes \text{ld}_X) .$$

We have

$$((\bar{\partial}_X \partial_X) \otimes \text{ld}_X) \psi_X = ((\bar{\partial}_X \partial_X \bar{\partial}_X) \otimes \text{ld}_X) \sigma_{23} (\partial_X \otimes \text{ld}_X)$$

but remember that $\partial_X \bar{\partial}_X = \text{ld}_{!X \otimes X} + \psi_X$, and hence

$$((\bar{\partial}_X \partial_X) \otimes \text{ld}_X) \psi_X = \psi_X + ((\bar{\partial}_X \psi_X) \otimes \text{ld}_X) \sigma_{23} (\partial_X \otimes \text{ld}_X)$$

But $\bar{\partial}_X (\bar{\partial}_X \otimes \text{ld}_X) \sigma_{23} = \bar{\partial}_X (\bar{\partial}_X \otimes \text{ld}_X)$ by commutativity of the bialgebra $!X$ and by definition of $\bar{\partial}_X$. Therefore $\bar{\partial}_X \psi_X = \bar{\partial}_X ((\bar{\partial}_X \partial_X) \otimes \text{ld}_X)$. So we can write

$$\begin{aligned} & ((\bar{\partial}_X \partial_X) \otimes \text{ld}_X) \psi_X \\ &= \psi_X + (\bar{\partial}_X \otimes \text{ld}_X) ((\bar{\partial}_X \partial_X) \otimes \text{ld}_X \otimes \text{ld}_X) \sigma_{23} (\partial_X \otimes \text{ld}_X) \\ &= \psi_X + (\bar{\partial}_X \otimes \text{ld}_X) ((\bar{\partial}_X \partial_X) \otimes \sigma) (\partial_X \otimes \text{ld}_X) \end{aligned}$$

A similar, and completely symmetric computation, using this time the cocommutativity of the bialgebra $!X$, leads to

$$\psi_X ((\bar{\partial}_X \partial_X) \otimes \text{ld}_X) = \psi_X + (\bar{\partial}_X \otimes \text{ld}_X) ((\bar{\partial}_X \partial_X) \otimes \sigma) (\partial_X \otimes \text{ld}_X)$$

and we are done. \square

We can now prove a completely categorical version of the following proposition which is the key step in the usual proof of Poincaré's Lemma.

Proposition 13 *Let $f : !X \otimes X \rightarrow Y$ be such that the differential $f(\partial_X \otimes \text{ld}_X) : !X \otimes X \otimes X \rightarrow Y$ satisfies*

$$f(\partial_X \otimes \text{ld}_X) \sigma_{23} = f(\partial_X \otimes \text{ld}_X).$$

Then there exists $g : !X \rightarrow Y$ such that $g\bar{\partial}_X = f$; in other words, g is an “antiderivative” of f .

Proof.

One sets

$$g = f(I_X \otimes \text{ld}_X) \partial_X. \quad (12)$$

Then we have

$$\begin{aligned} g\bar{\partial}_X &= f(I_X \otimes \text{ld}_X) \partial_X \bar{\partial}_X \\ &= f(I_X \otimes \text{ld}_X) (\text{ld}_{!X \otimes X} + \psi_X) \\ &= f(I_X \otimes \text{ld}_X) + f(I_X \otimes \text{ld}_X) \psi_X \\ &= f(I_X \otimes \text{ld}_X) + f\psi_X(I_X \otimes \text{ld}_X) \end{aligned}$$

by Lemma 12. But

$$\begin{aligned} f\psi_X &= f(\bar{\partial}_X \otimes \text{ld}_X) \sigma_{23} (\partial_X \otimes \text{ld}_X) \\ &= f(\bar{\partial}_X \otimes \text{ld}_X) (\partial_X \otimes \text{ld}_X) \quad \text{by our hypothesis on } f \\ &= f((\bar{\partial}_X \partial_X) \otimes \text{ld}_X). \end{aligned}$$

So we get

$$\begin{aligned} g\bar{\partial}_X &= f(I_X \otimes \text{ld}_X) + f((\bar{\partial}_X \partial_X I_X) \otimes \text{ld}_X) \\ &= f(((\text{ld}_{!X} + (\bar{\partial}_X \partial_X)) I_X) \otimes \text{ld}_X) \\ &= f \end{aligned}$$

since I_X is the inverse of $\text{ld}_{!X} + (\bar{\partial}_X \partial_X)$. □

3.2.1 Comments.

Let us give some intuition about our axiom that J_X has an inverse. Given $f : !X \rightarrow Y$ seen as a “regular function” from X to Y , we explain why the morphism $fI_X : !X \rightarrow Y$ should be understood as representing the regular function g defined by

$$g(x) = \int_0^1 f(tx) dt$$

assuming of course that this integral makes sense. With this interpretation, $g\bar{\partial}_X : !X \otimes X \rightarrow Y$ represents the differential Dg of g , a regular function $X \times X \rightarrow Y$ which maps (x, y) to $Dg(x) \cdot y$ and is linear in y . Then, applying the

ordinary rules of differential calculus, and the fact that differentiation commutes with integration, we get

$$Dg(x) \cdot y = \int_0^1 t(Df(tx) \cdot y) dt.$$

The morphism $h = g \bar{\partial}_X \partial_X : !X \rightarrow Y$ corresponds to the regular function from X to Y such that

$$\begin{aligned} h(x) &= \int_0^1 (Df(tx) \cdot (tx)) dt \\ &= \int_0^1 t(Df(tx) \cdot x) dt \\ &= \int_0^1 t \frac{df(tx)}{dt} dt \\ &= f(x) - \int_0^1 f(tx) dt, \end{aligned}$$

integrating by parts. In other words, we have seen that

$$f I_X \bar{\partial}_X \partial_X = f - (f I_X)$$

that is

$$f I_X (\text{Id}_{!X} + (\bar{\partial}_X \partial_X)) = f$$

this is why our first axiom on I_X is that $I_X (\text{Id}_{!X} + (\bar{\partial}_X \partial_X)) = \text{Id}_{!X}$. To explain why we also require $(\text{Id}_{!X} + (\bar{\partial}_X \partial_X)) I_X = \text{Id}_{!X}$, observe that

$$l = f \bar{\partial}_X \partial_X : !X \rightarrow Y$$

corresponds to the regular function defined by $l(x) = Df(x) \cdot x$ and hence $l I_X$ corresponds to the regular function $m : X \rightarrow Y$ given by

$$m(x) = \int_0^1 (Df(tx) \cdot (tx)) dt = h(x)$$

by linearity of the differential. So we have

$$f \bar{\partial}_X \partial_X I_X = f - (f I_X)$$

that is

$$f (\text{Id}_{!X} + (\bar{\partial}_X \partial_X)) I_X = f.$$

A remarkable and quite natural feature of this axiomatization of antiderivatives is the fact that it is actually a mere *property* of the exponential structure, and not an additional structure: it must be such that $\text{Id}_{!X} + (\bar{\partial}_X \partial_X)$ has an inverse.

Remark: The definition (12) of the antiderivative g of f in the proof above reads as follows, if we use this intuitive interpretation of I_X :

$$g(x) = \int_0^1 f(tx) \cdot x dt \quad (13)$$

which is exactly its definition, in the standard proof of Poincaré's Lemma. The proof of Proposition 13 is a rephrasing of the standard proof, which uses an integration by parts.

3.2.2 The fundamental theorem of calculus.

This is the statement according to which one can use antiderivatives for computing integrals: if $f, g : \mathbb{R} \rightarrow \mathbb{R}$ are such that $g' = f$, then $\int_a^b f(t) dt = g(b) - g(a)$. In the present setting, it boils down to a simple categorical equation.

Proposition 14 *Let \mathcal{L} be an exponential structure which has antiderivatives and is Taylor. Then*

$$\bar{\partial}_X (I_X \otimes \text{Id}_X) \partial_X + \bar{w}_X w_X = \text{Id}_{!X} .$$

Proof.

Let $f_1 = \bar{\partial}_X (I_X \otimes \text{Id}_X) \partial_X : !X \rightarrow !X$ and let $f_2 = \text{Id}_{!X}$. We have

$$\begin{aligned} f_1 \bar{\partial}_X &= \bar{\partial}_X (I_X \otimes \text{Id}_X) \partial_X \bar{\partial}_X \\ &= \bar{\partial}_X (I_X \otimes \text{Id}_X) + \bar{\partial}_X (I_X \otimes \text{Id}_X) (\bar{\partial}_X \otimes \text{Id}_X) \sigma_{23} (\partial_X \otimes \text{Id}_X) \\ &= \bar{\partial}_X (I_X \otimes \text{Id}_X) + \bar{\partial}_X (\bar{\partial}_X \otimes \text{Id}_X) \sigma_{23} (\partial_X \otimes \text{Id}_X) (I_X \otimes \text{Id}_X) \\ &\quad \text{by Lemma 12} \\ &= \bar{\partial}_X (I_X \otimes \text{Id}_X) + \bar{\partial}_X (\bar{\partial}_X \otimes \text{Id}_X) (\partial_X \otimes \text{Id}_X) (I_X \otimes \text{Id}_X) \\ &\quad \text{by commutativity of cocontraction} \\ &= \bar{\partial}_X ((\text{Id}_{!X} + (\bar{\partial}_X \partial_X)) \otimes \text{Id}_X) (I_X \otimes \text{Id}_X) \\ &= \bar{\partial}_X \quad \text{since } I_X = (\text{Id}_{!X} + (\bar{\partial}_X \partial_X))^{-1} \\ &= f_2 \bar{\partial}_X . \end{aligned}$$

Since \mathcal{L} is Taylor and since $f_1 \bar{w}_X w_X = 0$, we have therefore $f_1 + (f_2 \bar{w}_X w_X) = f_2 + (f_1 \bar{w}_X w_X)$, which is exactly the announced equation. \square

Remark: We give now an intuitive interpretation of this property. Let $f : !X \rightarrow Y$, considered as a regular function from X to Y . Then $f \bar{\partial}_X (I_X \otimes \text{Id}_X) \partial_X : !X \rightarrow Y$ represents the regular function $g : X \rightarrow Y$ given by

$$g(x) = \int_0^1 Df(tx) \cdot x dt = \int_0^1 \frac{df(tx)}{dt} dt$$

so that $g(x) = f(x) - f(0)$ by the Fundamental Theorem of Calculus. In other words $g(x) + f(0) = f(x)$, that is $f(\bar{\partial}_X (I_X \otimes \text{Id}_X) \partial_X + \bar{w}_X w_X) = f$.

3.3 Computing antiderivatives in the resource calculus

We can consider finite linear combinations of finite resource terms (see 2.7.2) as polynomials, and with this respect, it seems natural to formally compute the antiderivative of such a term, as one does for polynomials. This is the purpose of this short section. We use Δ for the set of simple resource terms and $\mathbf{k}\langle S \rangle$ for the free \mathbf{k} -module generated by the set S .

As with ordinary polynomials, we define first the antiderivative of a monomial, that is, of a simple resource term. Remember that, for ordinary one variable polynomials, the antiderivative of X^d is $\frac{1}{d+1}X^{d+1}$; the definition is completely similar here. Let $t \in \Delta$ be a simple resource term and let x be a variable. We set

$$I_x(t) = \frac{1}{\deg_x t + 1} t.$$

We extend this operation by linearity to all elements $u \in \mathbf{k}\langle \Delta \rangle$, that is we set $I_x(u) = \sum_{t \in \Delta} u_t I_x(t)$.

For $d \in \mathbb{N}$, let $\Delta_x^{(d)} = \{t \in \Delta \mid \deg_x t = d\}$ be the set of all simple resource terms of degree d in x . The elements of $\mathbf{k}\langle \Delta_x^{(d)} \rangle$ are said to be homogeneous of degree d in x .

With these notations, we can write

$$I_x(u) = \sum_{d=0}^{\infty} \frac{1}{d+1} \sum_{t \in \Delta_x^{(d)}} u_t t$$

Intuitively, $I_x(u)$ stands for the integral $\int_0^1 u(\tau x) d\tau$ which is the basic ingredient in the proof above of Poincaré's Lemma.

Let $u \in \mathbf{k}\langle \Delta \rangle$ which is linear in the variable h , in other words $u \in \mathbf{k}\langle \Delta_h^{(1)} \rangle$. Let h' be a variable which does not occur free in u , we assume that

$$\frac{\partial u}{\partial x} \cdot h' = \frac{\partial u [h'/h]}{\partial x} \cdot h$$

which is our symmetry hypothesis on u . In other words, for any $d \in \mathbb{N}$, we have

$$\sum_{t \in \Delta_x^{(d)}} u_t \frac{\partial t}{\partial x} \cdot h' = \sum_{t \in \Delta_x^{(d)}} u_t \frac{\partial t [h'/h]}{\partial x} \cdot h. \quad (14)$$

Mimicking (13), we set

$$v = I_x(u) [x/h]$$

and we prove that

$$\frac{\partial v}{\partial x} \cdot h = u. \quad (15)$$

Choose h' as above, we prove that $\frac{\partial v}{\partial x} \cdot h' = u [h'/h]$ which of course implies (15). We have, keeping in mind that h has exactly one free occurrence in each $t \in \Delta$

such that $u_t \neq 0$

$$\begin{aligned}
\frac{\partial v}{\partial x} \cdot h' &= \sum_{d=0}^{\infty} \frac{1}{d+1} \sum_{t \in \Delta_x^{(d)}} u_t \frac{\partial t [x/h]}{\partial x} \cdot h' \\
&= \sum_{d=0}^{\infty} \frac{1}{d+1} \sum_{t \in \Delta_x^{(d)}} u_t \left(\frac{\partial t}{\partial x} \cdot h' [x/h] + t [h'/h] \right) \\
&= \sum_{d=0}^{\infty} \frac{1}{d+1} \sum_{t \in \Delta_x^{(d)}} u_t \left(\left(\frac{\partial t [h'/h]}{\partial x} \cdot h \right) [x/h] + t [h'/h] \right) \quad \text{by (14)} \\
&= \sum_{d=0}^{\infty} \frac{1}{d+1} \sum_{t \in \Delta_x^{(d)}} u_t \left(\frac{\partial t [h'/h]}{\partial x} \cdot x + t [h'/h] \right) \\
&= \sum_{d=0}^{\infty} \frac{1}{d+1} \sum_{t \in \Delta_x^{(d)}} u_t (d t [h'/h] + t [h'/h]) \quad \text{since } \frac{\partial s}{\partial x} \cdot x = d s \text{ for all } s \in \Delta_x^{(d)} \\
&= u [h'/h]
\end{aligned}$$

and we are done.

4 Concrete models

We want now to give concrete examples of categorical models of DiLL.

4.1 Products, coproducts and the Seely isomorphisms

In Section 2.6, we introduced the functorial version of the exponential without mentioning the Seely isomorphisms: as explained in Paragraph 2.6.5, this choice is very natural when presenting the denotational interpretation of proof-nets. But when describing the structure of concrete models, as we want to do now, it is more natural to assume that the linear category \mathcal{L} is cartesian and that the $!_-$ comonad is equipped with a strong symmetric monoidal structure from $\&$ to \otimes .

So we assume to be given a preadditive $*$ -autonomous category \mathcal{L} equipped with an exponential structure (Section 2.5) where $!_-$ is a monoidal comonad satisfying the conditions of Section 2.6.

We assume moreover that \mathcal{L} is cartesian, with terminal object \top , cartesian product $\&$, projections $\pi_i \in \mathcal{L}(X_1 \& X_2, X_i)$. Because \mathcal{L} is preadditive, this implies that \top is also an initial object, and that $X_1 \& X_2$ (together with suitably defined injections) is also the coproduct of X_1 and X_2 . In other words, \mathcal{L} is an additive monoidal category.

We assume to be given an isomorphism $m^0 \in \mathcal{L}(1, !\top)$ and a natural isomorphism $m_{X_1, X_2}^2 \in \mathcal{L}(!X_1 \otimes !X_2, !(X_1 \& X_2))$ which endow the functor $!_-$ with a monoidal structure. This means that diagrams similar to (6), (7), (8) and (9) hold.

We also require the following diagram to commute

$$\begin{array}{ccc}
!X \otimes !Y & \xrightarrow{m_{X,Y}^2} & !(X \& Y) \\
\downarrow p_X \otimes p_Y & & \downarrow p_{X \& Y} \\
!!X \otimes !!Y & \xrightarrow{m_{!X,!Y}^2} & !(X \& Y) \\
& & \downarrow !(! \pi_1, ! \pi_2) \\
& & !(X \& Y) \\
& & \downarrow p_{X \& Y} \\
& & !(X \& Y)
\end{array}$$

Of course, there is a connection between these two monoidal structures on $!_.$. The morphism μ^0 is the following composition of morphisms:

$$1 \xrightarrow{m^0} !\top \xrightarrow{p_\top} !!\top \xrightarrow{!(m_1^0)^{-1}} !1$$

and $\mu_{X,Y}^2$ is

$$!X \otimes !Y \xrightarrow{m_{X,Y}^2} !(X \& Y) \xrightarrow{p_{X \& Y}} !!(X \& Y) \xrightarrow{!(m_{X,Y}^2)^{-1}} !(X \otimes Y) \xrightarrow{!(d_X \otimes d_Y)} !(X \otimes Y)$$

The bi-algebraic structure of $!X$ presented in Section 2.5 is also related to this Seelye monoidal structure.

For the coalgebraic part, let $\Delta^X \in \mathcal{L}(X, X \& X)$ be the diagonal morphism associated with the cartesian product of X with itself. Then we have

$$c_X = m_{X,X}^2{}^{-1} !\Delta^X : !X \rightarrow !X \otimes !X$$

Similarly we set

$$w_X = m_1^0 !\tau_X$$

where $\tau_X : X \rightarrow \top$ is the unique morphism to the terminal object. The algebraic part satisfies similar conditions, using the codiagonal $a^X : X \& X \rightarrow X$ and the morphism $\tau'_X : \top \rightarrow X$.

4.2 Relational semantics

We introduce now the simplest $*$ -autonomous category equipped with an exponential structure: the category of sets and relations. For this model, we assume that $\mathbf{k} = \{0, 1\}$ with addition defined by $1 + 1 = 1$.

Let \mathbf{Rel} be the category whose objects are sets and where $\mathbf{Rel}(X, Y) = \mathcal{P}(X \times Y)$, identities being the diagonal relations and composition being defined as follows: if $R \in \mathbf{Rel}(X, Y)$ and $S \in \mathbf{Rel}(Y, Z)$ then

$$SR = \{(a, c) \in X \times Z \mid \exists b \in Y (a, b) \in R \text{ and } (b, c) \in S\}.$$

Let $x \subseteq X$, we set $Rx = \{b \in Y \mid \exists a \in x (a, b) \in R\} \subseteq Y$ which is the direct image of x by R . We also define $R^\perp = \{(b, a) \in Y \times X \mid (a, b) \in R\}$ which is the transpose of R . Given $x \subseteq X$ and $y' \subseteq Y$, we have

$$(Rx) \cap y' = \text{pr}_2(R \cap (x \times y')) \quad \text{and} \quad (R^\perp y') \cap x = \text{pr}_1(R \cap (x \times y')) \quad (16)$$

where pr_1 and pr_2 are the two projections of the cartesian product in the category **Set** of sets and functions (the ordinary cartesian product “ \times ”).

Observe that an isomorphism in **Rel** is a relation which is a bijection.

The symmetric monoidal structure is given by the tensor product $X \otimes Y = X \times Y$ and the unit 1 an arbitrary singleton. The neutrality, associativity and symmetry isomorphisms are defined as the obvious corresponding bijections (for instance, the symmetry isomorphism $\sigma_{X,Y} \in \mathbf{Rel}(X \otimes Y, Y \otimes X)$ is given by $\sigma(a, b) = (b, a)$). This symmetric monoidal category is closed, with linear function space given by $X \multimap Y = X \times Y$, the natural bijection between $\mathbf{Rel}(Z \otimes X, Y)$ and $\mathbf{Rel}(Z, X \multimap Y)$ being induced by the cartesian product associativity isomorphism. Last, one takes for \perp an arbitrary singleton, and this turns **Rel** into a \star -autonomous category. One denotes as \star the unique element of 1 and \perp .

This category is additive, with cartesian product $X_1 \& X_2$ of X_1 and X_2 defined as $\{1\} \times X_1 \cup \{2\} \times X_2$ with projections $\pi_i = \{(i, a), a \mid a \in X_i\}$ (for $i = 1, 2$), and terminal object $\top = \emptyset$. Then the commutative monoid structure on homsets $\mathbf{Rel}(X, Y)$ is defined by $0 = \emptyset$ and $f + g = f \cup g$ and the action of \mathbf{k} on morphisms is defined by $0 f = 0$ and $1 f = f$ (there are no other possibilities).

Rel is also a Seely category (see Section 4.1), for a comonad $!_-$ defined as follows:

- $!X$ is the set of all finite multisets of elements of X ;
- if $R \in \mathbf{Rel}(X, Y)$, then we set $!R = \{([a_1, \dots, a_n], [b_1, \dots, b_n]) \mid n \in \mathbb{N} \text{ and } \forall i (a_i, b_i) \in R\}$;
- $\mathbf{d}_X \in \mathbf{Rel}(!X, X)$ is $\mathbf{d}_X = \{([a], a) \mid a \in X\}$;
- $\mathbf{p}_X = \{(m_1 + \dots + m_n, [m_1, \dots, m_n]) \mid n \in \mathbb{N} \text{ and } m_1, \dots, m_n \in !X\}$.

The monoidality isomorphism $\mathbf{m}_{X,Y}^2 \in \mathbf{Rel}(!X \otimes !Y, !(X \& Y))$ is the bijection which maps $([a_1, \dots, a_l], [b_1, \dots, b_r])$ to $[(1, a_1), \dots, (1, a_l), (2, b_1), \dots, (2, b_r)]$.

Last, we also provide a codereliction natural transformation $\bar{\mathbf{d}}_X \in \mathbf{Rel}(X, !X)$ which is simply given by $\bar{\mathbf{d}}_X = \{(a, [a]) \mid a \in X\}$.

With these definitions, it is easy to see that $\mathbf{c}_X = \{(l + r, (l, r)) \mid l, r \in !X\}$, $\mathbf{w}_X = \{(\square, \star)\}$, $\bar{\mathbf{c}}_X = \{(l, r), l + r \mid l, r \in !X\}$ and $\bar{\mathbf{w}}_X = \{(\star, \square)\}$. The required diagrams are easily seen to commute.

4.2.1 Antiderivatives.

This exponential structure is bicommutative and can easily be seen to be Taylor in the sense of Section 3.1. Moreover, it has antiderivatives in the sense of Section 3.2, simply because the morphism $J_X = \text{Id}_X + (\bar{\partial}_X \partial_X) : !X \rightarrow !X$

coincides here with the identity. Indeed $\partial_X = \{(l + [a], (l, a)) \mid l \in !X \text{ and } a \in X\}$, $\bar{\partial}_X = \{(l, a), l + [a] \mid l \in !X \text{ and } a \in X\}$ and therefore $\bar{\partial}_X \partial_X = \{(l, l) \mid l \in !X \text{ and } \#l > 0\}$.

Concretely, saying that a morphism $f \in \mathbf{Rel}(!X \otimes X, Y)$ satisfies the symmetry condition of Proposition 13 simply means that, given $m \in \mathcal{M}_{\text{fin}}(X)$, $a, a' \in X$ and $b \in Y$, one has $((m + [a], a'), b) \in f \Leftrightarrow ((m + [a'], a), b) \in f$. In that case, the antiderivative $g \in \mathbf{Rel}(!X, Y)$ given by that proposition is simply

$$g = \{(m + [a], b) \mid ((m, a), b) \in f\}.$$

4.3 Finiteness spaces

This model can be seen as an enrichment of the model of sets and relations of Section 4.2. It can also be described as a category of topological vector spaces and linear continuous maps. From now on, \mathbf{k} denotes an arbitrary field which is always endowed with the discrete topology.

4.4 Linearly topologized vector spaces (ltvs)

Let E be a \mathbf{k} -vector space. A *linear topology* on E is a topology λ such that there is a filter \mathcal{L} of linear subspaces of E with the following property: a subset U of E is λ -open iff for any $x \in U$ there exists $V \in \mathcal{L}$ such that $x + V \subseteq U$. One says that such a filter \mathcal{L} *generates* the topology \mathcal{L} . A \mathbf{k} -ltvs is a \mathbf{k} -vector space equipped with a linear topology. Observe that E is Hausdorff iff $\bigcap \mathcal{L} = \{0\}$ (for some, and hence any, generating filter \mathcal{L}); from now on we assume always that this is the case.

Proposition 15 *Let E be a \mathbf{k} -ltvs. Any linear subspace U of E which is a neighborhood of 0 is both open and closed. So E is totally disconnected (the only subsets of E which are connected are the empty set and the one point sets).*

Proof.

Let \mathcal{L} be a generating filter for the topology of E . First, let $x \in U$ and let $V \in \mathcal{L}$ be such that $V \subseteq U$ (such a V exists because U is a neighborhood of 0), then we have $x + V \subseteq U$ since U is a linear subspace and hence U is open. Next let $x \in E \setminus U$. If $y \in U \cap (x + U)$ then we have $y - x \in U$ and hence $x \in U$ since $y \in U$ and U is a linear subspace: contradiction. Therefore $U \cap (x + U) = \emptyset$ and U is closed since U is open. \square

Any linear subspace which contains an open linear subspace is open.

4.4.1 Cauchy completeness.

A *net* in E is a family $(x(d))_{d \in D}$ of elements of E indexed by a directed set D . The net $(x(d))_{d \in D}$ *converges* to $x \in E$ if, for any neighborhood U of 0, there exists $d \in D$ such that $\forall e \in D \ e \geq d \Rightarrow x(e) - x \in U$. Because E is Hausdorff, a net converges to at most one point. As usual, one can check that a subset U

of E is open iff, for any net $(x(d))_{d \in D}$ which converges to a point $x \in U$, there exists $d \in D$ such that $\forall e \in D \ e \geq d \Rightarrow x(e) \in U$.

A net $(x(d))_{d \in D}$ is *Cauchy* if, for any neighborhood U of 0, there exists $d \in D$ such that $\forall e, e' \in D \ e, e' \geq d \Rightarrow x(e) - x(e') \in U$. This latter statement is equivalent to $\forall e \in D \ e \geq d \Rightarrow x(e) - x(d) \in U$.

One says that E is *complete* if any Cauchy net in E converges.

4.4.2 Linear boundedness.

Let E be an ltvs and let U be an open linear subspace of E . Let $\pi_U : E \rightarrow E/U$ be the canonical projection. This map is of course linear, and its kernel is U which is a neighborhood of 0. This means that, endowing E/U with the discrete topology, π_U is continuous. Hence the quotient topology on E/U is the discrete topology.

We say that a subspace B of E is *linearly bounded* if $\pi_U(B)$ is finite dimensional, for every linear open subspace U of E . In other words, for any linear open subspace U , there is a finite dimensional subspace A of E such that $B \subseteq U + A$.

Proposition 16 *Any finite dimensional subspace of an ltvs E is linearly bounded. Let B_1 and B_2 be subspaces of E . If $B_1 \subseteq B_2$ and B_2 is linearly bounded, so is B_1 . If B_1 and B_2 are linearly bounded, so is $B_1 + B_2$.*

A collection of subspaces of a vector space F having these properties is called a *linear bornology* on F .

An ltvs E is *locally linearly bounded* if it has a linear open subspace which is linearly bounded.

4.4.3 Linear and multilinear maps.

Let E_1, \dots, E_n and F be \mathbf{k} -ltvs's. An n -multilinear function $f : E_1 \times \dots \times E_n \rightarrow F$ is *hypocontinuous* if, for any $i \in \{1, \dots, n\}$, any linear open subspace $V \subseteq F$ and any linearly bounded subspaces $B_1 \subseteq E_1, \dots, B_{i-1} \subseteq E_{i-1}, B_{i+1} \subseteq E_{i+1}, \dots, B_n \subseteq E_n$, there exists an open linear subspace $U \subseteq E_i$ such that $f(B_1 \times \dots \times B_{i-1} \times U \times B_{i+1} \times \dots \times B_n) \subseteq V$.

We denote by $(E_1, \dots, E_n) \multimap F$ the \mathbf{k} -vector space of all such multilinear maps. Given linearly bounded subspaces B_1, \dots, B_n of E_1, \dots, E_n respectively and given a linear open subspace V of F , we define

$$\text{Ann}(B_1, \dots, B_n, V) = \{f \in (E_1, \dots, E_n) \multimap F \mid f(B_1 \times \dots \times B_n) \subseteq V\}.$$

This is a linear subspace of $(E_1, \dots, E_n) \multimap F$ and by Proposition 16 these subspaces form a filter which defines a linear topology on $(E_1, \dots, E_n) \multimap F$ and this topology is Hausdorff. Indeed, if $f \in (E_1, \dots, E_n) \multimap F$ is $\neq 0$, then take $x_i \in E_i$ such that $f(x_1, \dots, x_n) \neq 0$. Since F is Hausdorff, there is a linear neighborhood V of 0 in F such that $f(x_1, \dots, x_n) \notin V$. Let $B_i = \mathbf{k}x_i$; this is a linearly bounded subspace of E_i and $f(B_1 \times \dots \times B_n) \not\subseteq V$.

In the case $n = 1$ (and $E = E_1$), the corresponding maps $f : E \rightarrow F$ are simply called linear, and they are continuous. The corresponding function space is denoted as $E \multimap F$.

If $F = \mathbf{k}$, the corresponding maps are called (multi)linear (hypo)continuous forms. If furthermore $n = 1$ the corresponding function space is denoted as E' and is called *topological dual* of E .

Proposition 17 *Let $f : E_1 \times \cdots \times E_n \rightarrow F$ be multilinear and hypocontinuous and let $B_i \subseteq E_i$ be linearly bounded subspaces for $i = 1, \dots, n$. Then $f(B_1 \times \cdots \times B_n)$ is a linearly bounded subspace of F .*

Proof.

Let V be an open linear subspace of F . Let U_1 be an open linear subspace of E_1 such that $f(U_1 \times B_1 \times \cdots \times B_n) \subseteq V$. Let A_1 be a finite dimensional subspace of E_1 such that $B_1 \subseteq U_1 + A_1$, we have $f(B_1 \times \cdots \times B_n) \subseteq V + f(A_1 \times B_2 \times \cdots \times B_n)$. Since A_1 is bounded, one can find similarly a finite dimensional subspace A_2 of E_2 such that $f(A_1 \times B_2 \times \cdots \times B_n) \subseteq V + f(A_1 \times A_2 \times B_3 \times \cdots \times B_n)$ and hence (since $V + V = V$) we get $f(B_1 \times \cdots \times B_n) \subseteq V + f(A_1 \times A_2 \times B_3 \times \cdots \times B_n)$. Continuing this process, we find finite dimensional subspaces A_i of E_i for $i = 1, \dots, n$ such that $f(B_1 \times \cdots \times B_n) \subseteq V + f(A_1 \times \cdots \times A_n)$ and we conclude that $f(B_1 \times \cdots \times B_n)$ is linearly bounded since $f(A_1 \times \cdots \times A_n)$ is finite dimensional. \square

It is tempting to think that (multi)linear continuous maps could be characterized as those which preserve linear boundedness. This cannot be the case: think of a linear map $f : E \rightarrow F$ where F is finite dimensional. Such a map preserves linear boundedness (any subspace of F is linearly bounded) but has no reason to be continuous.

4.5 Finiteness spaces and the related ltv's

We restrict now our attention to particular ltv's which can be described in a simple combinatorial way.

4.5.1 Basic definitions.

Let I be a set. Given $\mathcal{F} \subseteq \mathcal{P}(I)$, we define $\mathcal{F}^\perp \subseteq \mathcal{P}(I)$ by

$$\mathcal{F}^\perp = \{u' \subseteq I \mid \forall u \in \mathcal{F} \ u \cap u' \text{ is finite}\}.$$

We have $\mathcal{F} \subseteq \mathcal{G} \Rightarrow \mathcal{G}^\perp \subseteq \mathcal{F}^\perp$, $\mathcal{F} \subseteq \mathcal{F}^{\perp\perp}$ and therefore $\mathcal{F}^{\perp\perp\perp} = \mathcal{F}^\perp$.

A *finiteness space* is a pair $X = (|X|, \mathbf{F}(X))$ where $|X|$ is a set and $\mathbf{F}(X) \subseteq \mathcal{P}(|X|)$ satisfies $\mathbf{F}(X) = \mathbf{F}(X)^{\perp\perp}$. The following properties follow easily from the definition

- if $u \subseteq |X|$ is finite then $u \in \mathbf{F}(X)$
- if $u, v \in \mathbf{F}(X)$ then $u \cup v \in \mathbf{F}(X)$

- if $u \subseteq v \in \mathbf{F}(X)$, then $u \in \mathbf{F}(X)$.

Let us prove for instance the second statement. Let $u' \in \mathbf{F}(X)^\perp$, then $(u \cup v) \cap u' = (u \cap u') \cup (v \cap u')$ is finite since both sets $u \cap u'$ and $v \cap u'$ are finite by our hypothesis that $u, v \in \mathbf{F}(X)$. Since this holds for all $u' \in \mathbf{F}(X)^\perp$, we have $u \cup v \in \mathbf{F}(X)^{\perp\perp} = \mathbf{F}(X)$.

A *strong isomorphism*¹² between two finiteness spaces X and Y is a bijection $\varphi : |X| \rightarrow |Y|$ such that, for all $u \subseteq |X|$, one has $u \in \mathbf{F}(X)$ iff $\varphi(u) \in \mathbf{F}(Y)$.

Let X be a finiteness space. We define a \mathbf{k} -vector space $\mathbf{k}\langle X \rangle$ as the set of all families $x \in \mathbf{k}^{|X|}$ such that the set $\text{supp}(x) = \{a \in |X| \mid x_a \neq 0\}$ belongs to $\mathbf{F}(X)$.

Given $u' \in \mathbf{F}(X)^\perp$, we define a linear subspace of $\mathbf{k}\langle X \rangle$ by

$$\mathcal{V}_X(u') = \{x \in \mathbf{k}\langle X \rangle \mid \text{supp}(x) \cap u' = \emptyset\}.$$

Observe first that $\forall u', v' \in \mathbf{F}(X)^\perp \quad u' \subseteq v' \Leftrightarrow \mathcal{V}_X(v') \subseteq \mathcal{V}_X(u')$.

Since, given $u', v' \in \mathbf{F}(X)^\perp$, we have $\mathcal{V}_X(u' \cup v') = \mathcal{V}_X(u') \cap \mathcal{V}_X(v')$, the set $\{\mathcal{V}_X(u') \mid u' \in \mathbf{F}(X)^\perp\}$ is a filter of linear subspaces of $\mathbf{k}\langle X \rangle$. Moreover, observe that $\bigcap_{u' \in \mathbf{F}(X)^\perp} \mathcal{V}_X(u') = \{0\}$ (because $\forall a \in |X| \{a\} \in \mathbf{F}(X)^\perp$), and therefore this filter defines an Hausdorff linear topology on $\mathbf{k}\langle X \rangle$, that we call the *canonical topology* of $\mathbf{k}\langle X \rangle$.

Proposition 18 *For any finiteness space X , the ltvs $\mathbf{k}\langle X \rangle$ is Cauchy-complete.*

Proof.

Let $(x(d))_{d \in D}$ be a Cauchy net in $\mathbf{k}\langle X \rangle$. Let $a \in |X|$. By taking $u' = \{a\}$ in the definition of a Cauchy net, we see that there exist $x_a \in \mathbf{k}$ and $d_a \in D$ such that $\forall e \geq d_a \quad x(e)_a = x_a$. In that way we have defined $x = (x_a)_{a \in |X|} \in \mathbf{k}^{|X|}$

We prove first that

$$\forall u' \in \mathbf{F}(X)^\perp \exists d \in D \forall e \geq d \forall a \in u' \quad x(e)_a = x_a. \quad (17)$$

Let $u' \in \mathbf{F}(X)^\perp$. Let $d^0 \in D$ be such that $x(e) - x(d^0) \in \mathcal{V}_X(u')$ for all $e \geq d^0$. Let $a \in u'$ and let $d_a \geq d^0$ be such that $x(e)_a = x_a$ for all $e \geq d_a$. Let $e \geq d^0$. Let $e' \geq e, d_a$. We have $x_a = x(e')_a$ since $e' \geq d_a$ and $x(e')_a = x(e)_a$ since $e, e' \geq d^0$ and $a \in u'$. It follows that $\forall a \in u' \quad x_a = x(e)_a$.

From this we deduce now that $x \in \mathbf{k}\langle X \rangle$. Let $u' \in \mathbf{F}(X)^\perp$. Let $d \in D$ be such that $\forall e \geq d \forall a \in u' \quad x(e)_a = x_a$. Then $\text{supp}(x) \cap u' = \text{supp}(x(d)) \cap u'$ is finite, so $\text{supp}(x) \in \mathbf{F}(X)^{\perp\perp} = \mathbf{F}(X)$, that is $x \in \mathbf{k}\langle X \rangle$.

Now Condition (17) expresses exactly that $\lim_{d \in D} x(d) = x$ and hence the net $(x(d))_{d \in D}$ converges. \square

¹²This would coincide with the categorical notion of isomorphism if we were using morphisms which are defined as relations. With linear continuous maps (between the associated ltvs's) as morphisms, the present notion of isomorphism is a particular case of the standard categorical one: we can have more linear homeomorphisms from $\mathbf{k}\langle X \rangle$ to $\mathbf{k}\langle Y \rangle$ than those which are generated by such finiteness-preserving bijections between webs.

A natural question is whether the ltvs $\mathbf{k}\langle X \rangle$, which is Hausdorff, is always metrizable. We provide a necessary and sufficient condition under which this is the case.

Proposition 19 *Let X be a finiteness space. The ltvs $\mathbf{k}\langle X \rangle$ is metrizable iff there exists a sequence $(u'_n)_{n \in \mathbb{N}}$ of elements of $\mathbf{F}(X)^\perp$ which is monotone ($n \leq m \Rightarrow u'_n \subseteq u'_m$) and such that $\forall u' \in \mathbf{F}(X)^\perp \exists n \in \mathbb{N} u' \subseteq u'_n$.*

Proof.

Let first $(u'_n)_{n \in \mathbb{N}}$ be a sequence of elements of $\mathbf{F}(X)^\perp$ which satisfies the condition stated above. Given $x, y \in \mathbf{k}\langle X \rangle$, we define

$$d(x, y) = \begin{cases} 0 & \text{if } x = y \\ 2^{-n} & \text{if } x \neq y \text{ and } n \text{ is the least integer} \\ & \text{such that } u'_n \cap \text{supp}(x - y) \neq \emptyset. \end{cases}$$

Indeed, if $x \neq y$, then $\text{supp}(x - y) \neq \emptyset$ and hence, taking $a \in \text{supp}(x - y)$, we can find $n \in \mathbb{N}$ such that $\{a\} \subseteq u'_n$. This function d is easily seen to be an ultrametric distance (that is $d(x, z) \leq \max(d(x, y), d(y, z))$) and it generates the canonical topology of $\mathbf{k}\langle X \rangle$. Indeed we have

$$d(x, y) < 2^{-n} \quad \text{iff} \quad x - y \in \mathcal{V}_X(u'_n)$$

(indeed, $d(x, y) < 2^{-n}$ means that the least m such that $x - y \notin \mathcal{V}_X(u'_m)$ satisfies $m > n$) and hence $B_{2^{-n}} = \mathcal{V}_X(u'_n)$, where B_ε is the open ball centered at 0 and of radius ε .

Conversely, assume that $\mathbf{k}\langle X \rangle$ is metrizable and let d be a distance defining the canonical topology of $\mathbf{k}\langle X \rangle$. For each $n \in \mathbb{N}$, $B_{2^{-n}}$ is a neighborhood of 0 and hence there exist $v'_n \in \mathbf{F}(X)^\perp$ such that $\mathcal{V}_X(v'_n) \subseteq B_{2^{-n}}$. Let $u'_n = v'_0 \cup \dots \cup v'_n \in \mathbf{F}(X)^\perp$. Then $\mathcal{V}_X(u'_n) \subseteq \mathcal{V}_X(v'_n) \subseteq B_{2^{-n}}$. Now let $u' \in \mathbf{F}(X)^\perp$, then $\mathcal{V}_X(u')$ is a neighborhood of 0 and hence there exists n such that $B_{2^{-n}} \subseteq \mathcal{V}_X(u')$, which implies $\mathcal{V}_X(u'_n) \subseteq \mathcal{V}_X(u')$ and hence $u' \subseteq u'_n$. \square

It follows that there are non metrizable ltvs associated with finiteness spaces. We give in Proposition 20 an example of this situation which arises in the semantics of LL, using exponential constructions that will be introduced in Section 4.5.3.

Proposition 20 *The ltvs $\mathbf{k}\langle !?1 \rangle$ is not metrizable*

Proof.

Let $X = !?1$, so that $|X| = \mathcal{M}_{\text{fin}}(\mathbb{N})$ and a subset u for $|X|$ belongs to $\mathbf{F}(X)$ iff $\exists n \in \mathbb{N} u \subseteq \mathcal{M}_{\text{fin}}(\{0, \dots, n\})$. The proof is a typical Cantor diagonal reasoning. We assume towards a contradiction that $\mathbf{k}\langle X \rangle$ is metrizable, that is by Proposition 19, we assume that there is a monotone sequence $(u'_n)_{n \in \mathbb{N}}$ of

elements of $F(X)^\perp$ such that $\forall u' \in F(X)^\perp \exists n \in \mathbb{N} u' \subseteq u'_n$. Let $n \in \mathbb{N}$, we have $\{p[n] \mid p \in \mathbb{N}\} \in \mathcal{M}_{\text{fin}}(\{0, \dots, n\})$ and hence $u'_n \cap \{p[n] \mid p \in \mathbb{N}\}$ is finite. Therefore we can find a function $f : \mathbb{N} \rightarrow \mathbb{N}$ such that $\forall n \in \mathbb{N} f(n)[n] \notin u'_n$. Let $u' = \{f(n)[n] \mid n \in \mathbb{N}\}$. Then $u' \in F(X)^\perp$ since, for any $n \in \mathbb{N}$, $u' \cap \mathcal{M}_{\text{fin}}(\{0, \dots, n\}) = \{f(i)[i] \mid i \in [0, n]\}$ is finite. But for all $n \in \mathbb{N}$ we have $f(n)[n] \in u' \setminus u'_n$ and so $u' \not\subseteq u'_n$. \square

We consider this as a very interesting phenomenon which seems to reveal a relation between the topological complexity of the interpretation of a type with its logical complexity (alternation of exponentials).

4.5.2 Linearly bounded subspaces.

Let X be a finiteness space. We are interested in characterizing the linearly bounded subspaces of $\mathbf{k}\langle X \rangle$.

Given $u \subseteq |X|$, let $\mathcal{B}_X(u) = \{x \in \mathbf{k}\langle X \rangle \mid \text{supp}(x) \subseteq u\}$. This is a linear subspace of $\mathbf{k}\langle X \rangle$.

Let $u \in F(X)$. We prove that $\mathcal{B}_X(u)$ is linearly bounded. Let u' in $F(X)^\perp$. Observe that $\mathcal{V}_X(u') = \mathcal{B}_X(|X| \setminus u')$. We have therefore $\mathcal{B}_X(u) \subseteq \mathcal{V}_X(u') + \mathcal{B}_X(u \cap u')$, and since $u \cap u'$ is finite, the space $\mathcal{B}_X(u \cap u')$ is finite dimensional. Let U be an open subspace of U , let $u' \subseteq F(X)^\perp$ be such that $\mathcal{V}_X(u') \subseteq U$. Then $\mathcal{B}_X(u) \subseteq U + \mathcal{B}_X(u \cap u')$. Hence $\mathcal{B}_X(u)$ is linearly bounded. We show now that this condition is actually sufficient.

Proposition 21 *A linear subspace B of $\mathbf{k}\langle X \rangle$ is linearly bounded iff there exists $u \in F(X)$ such that $B \subseteq \mathcal{B}_X(u)$.*

Proof.

Assume that B is linearly bounded. Let $u = \bigcup_{x \in B} \text{supp}(x)$, so that $B \subseteq \mathcal{B}_X(u)$, we prove that $u \in F(X)$. Let $u' \in F(X)^\perp$. Let A be a finite dimensional subspace of E such that $B \subset \mathcal{V}_X(u') + A$. Let A_0 be a finite generating subset of A and let $u_0 = \bigcup_{y \in A_0} \text{supp}(y) \in F(X)$. Then $x \in A \Rightarrow \text{supp}(x) \subseteq u_0$ (that is $A \subseteq \mathcal{B}_X(u_0)$).

Let $x \in B$, we write $x = x_1 + x_2$ where $x_1 \in \mathcal{V}_X(u')$ and $x_2 \in A$. We have $\text{supp}(x) \subseteq \text{supp}(x_1) \cup \text{supp}(x_2)$ and hence $u' \cap \text{supp}(x) \subseteq (u' \cap \text{supp}(x_1)) \cup (u' \cap \text{supp}(x_2)) \subseteq u' \cap u_0$ since $u' \cap \text{supp}(x_1) = \emptyset$. Since this holds for all $x \in B$, we have $u' \cap u \subseteq u' \cap u_0$ so $u' \cap u$ is finite and hence $u \in F(X)$ \square

Proposition 22 *The ltvs $\mathbf{k}\langle X \rangle$ is locally linearly bounded iff there exist $u \in F(X)$ and $u' \in F(X)^\perp$ such that $u \cup u' = |X|$.*

This is an obvious consequence of Proposition 21.

$\mathbf{Fin}^{\mathbf{k}}$ is the category whose objects are the finiteness spaces and such that $\mathbf{Fin}^{\mathbf{k}}(X, Y)$ is the set of all continuous linear maps $\mathbf{k}\langle X \rangle \rightarrow \mathbf{k}\langle Y \rangle$.

4.5.3 Constructions of finiteness spaces.

We give a number of constructions on finiteness spaces which allow one to interpret differential LL, starting with the most important one, which is the linear function space.

The most striking features of these constructions can be summarized by the two following statements.

- In spite of the fact that these constructions are algebraic in nature (tensor product, linear function space, topological dual etc), they are entirely performed on the webs of the finiteness spaces and do not involve the scalar coefficients. This means in particular that they do not depend on the choice of the field, and this is quite surprising.
- So, these constructions are performed on the webs, but they do not really depend on them, in the following sense. Defining an *intrinsic finiteness space* as a \mathbf{k} -ltvs which is linearly homeomorphic to $\mathbf{k}\langle X \rangle$ for *some* finiteness space X , all these constructions can be transferred to the category of intrinsic finiteness spaces and continuous and linear maps.

Let X and Y be finiteness spaces. Let $X \multimap Y$ be the finiteness space such that $|X \multimap Y| = |X| \times |Y|$ and

$$\begin{aligned} \mathbf{F}(X \multimap Y) &= \{u \times v' \mid u \in \mathbf{F}(X) \text{ and } v' \in \mathbf{F}(Y^\perp)\}^\perp \\ &= \{w \subseteq |X| \times |Y| \mid \forall u \in \mathbf{F}(X) \forall v' \in \mathbf{F}(Y)^\perp \ w \cap (u \times v') \text{ is finite}\} \end{aligned}$$

Let $w \in \mathbf{F}(X \multimap Y)$, $u \in \mathbf{F}(X)$ and $v' \in \mathbf{F}(X)^\perp$. It follows from (16) that $wu \in \mathbf{F}(Y)$ and that $w^\perp v' \in \mathbf{F}(X)^\perp$.

Let $M \in \mathbf{k}\langle X \multimap Y \rangle$. If $x \in \mathbf{k}\langle X \rangle$ and $b \in |Y|$, then $\text{supp}(M)^\perp \{b\} \in \mathbf{F}(X)^\perp$ and hence the sum $\sum_{a \in |X|} M_{a,b} x_a$ is finite. Therefore we can define $Mx \in \mathbf{k}^{|Y|}$ by $Mx = (\sum_{a \in |X|} M_{a,b} x_a)_{b \in |Y|}$. Since $\text{supp}(Mx) \subseteq \text{supp}(M) \text{supp}(x)$, we have $Mx \in \mathbf{k}\langle Y \rangle$ and hence the function $\text{fun}(M)$ defined by $\text{fun}(M)(x) = Mx$ is a linear map $\mathbf{k}\langle X \rangle \rightarrow \mathbf{k}\langle Y \rangle$. Moreover, $\text{fun}(M)$ is continuous. Indeed, for any $v' \in \mathbf{F}(Y)^\perp$ we have $\mathcal{V}_X(\text{supp}(M)^\perp v') \subseteq \text{fun}(M)^{-1}(\mathcal{V}_Y(v'))$ and hence $\text{fun}(M)^{-1}(\mathcal{V}_Y(v'))$ is open since $\text{supp}(M)^\perp v' \in \mathbf{F}(X)^\perp$.

Given finiteness spaces Z_1, Z_2 , we define immediately the finiteness space $Z_1 \otimes Z_2$ as $Z_1 \otimes Z_2 = (Z_1 \multimap Z_2^\perp)^\perp$, so that $|Z_1 \otimes Z_2| = |Z_1| \times |Z_2|$. One of the most pleasant features of the theory of finiteness spaces is the following property (see [Ehr05]) which has been considerably generalized in [TV10].

Proposition 23 *Let $w \subseteq |Z_1| \times |Z_2|$. One has $w \in \mathbf{F}(Z_1 \otimes Z_2)$ iff $\text{pr}_i(w) \in \mathbf{F}(Z_i)$ for $i = 1, 2$.*

Coming back to linear function spaces, this means in particular that, given $w \subseteq |X| \times |Y|$, one has $w \in \mathbf{F}(X \multimap Y)^\perp$ iff there are $u \in \mathbf{F}(X)$ and $v' \in \mathbf{F}(Y)^\perp$ such that $w \subseteq u \times v'$, from which we derive a simple characterization of the topology of linear function spaces.

Proposition 24 *The function $\text{Fun}_{X,Y} : M \mapsto \text{fun}(M)$ is a linear homeomorphism from $\mathbf{k}\langle X \multimap Y \rangle$ to $\mathbf{k}\langle X \rangle \multimap \mathbf{k}\langle Y \rangle$, equipped with the topology of uniform convergence on linearly bounded subspaces.*

Proof.

The proof that $\text{Fun}_{X,Y}$ is a linear isomorphism can be found in [Ehr05]. We prove that this linear isomorphism is an homeomorphism. Let $B \subseteq \mathbf{k}\langle X \rangle$ be a bounded subspace and $V \subseteq \mathbf{k}\langle Y \rangle$ is an open subspace. Let $u \in \text{F}(X)$ be such that $B \subseteq \mathcal{B}_X(u)$ and let $v' \in \text{F}(Y)^\perp$ be such that $\mathcal{V}_Y(v') \subseteq V$. Then $u \times v' \in \text{F}(X \multimap Y)^\perp$ and hence $\mathcal{V}_{X \multimap Y}(u \times v') \subseteq \mathbf{k}\langle X \multimap Y \rangle$ is an open subspace. Let $M \in \mathcal{V}_{X \multimap Y}(u \times v')$, $x \in B$ and $b \in v'$, we have $(Mx)_b = 0$ since $\text{supp}(x) \subseteq u$, which shows that $\text{Fun}_{X,Y}(M)(B) \subseteq V$ and hence $\text{Fun}_{X,Y}$ is continuous.

Let now $W \subseteq \mathbf{k}\langle X \multimap Y \rangle$ be an open subspace. Let $w \in \text{F}(X \multimap Y)^\perp$ be such that $\mathcal{V}_{X \multimap Y}(w) \subseteq W$. By Proposition 23, there are $u \in \text{F}(X)$ and $v' \in \text{F}(Y)^\perp$ such that $w \subseteq u \times v'$, and hence $\mathcal{V}_{X \multimap Y}(u \times v') \subseteq W$. Then, given $M \in \mathcal{V}_{X \multimap Y}(u \times v')$, we have $\text{Fun}_{X,Y}(M)(\mathcal{B}_X(u)) \subseteq \mathcal{V}_Y(v')$, which shows that $\text{Fun}_{X,Y}(W)$ is an open linear subspace of $\mathbf{k}\langle X \rangle \multimap \mathbf{k}\langle Y \rangle$.

We have seen that $\text{Fun}_{X,Y}$ is a continuous and open bijection and hence it is an homeomorphism. \square

The tensor product $X \otimes Y$ defined above is characterized by a standard universal property: it classifies the hypocontinuous bilinear maps.

Given vectors $x \in \mathbf{k}\langle X \rangle$ and $y \in \mathbf{k}\langle Y \rangle$, then $x \otimes y \in \mathbf{k}^{|X \otimes Y|}$ defined by $(x \otimes y)_{(a,b)} = x_a y_b$ is clearly an element of $\mathbf{k}\langle X \otimes Y \rangle$ since $\text{supp}(x \otimes y) = \text{supp}(x) \times \text{supp}(y) \in \text{F}(X \otimes Y)$. The map

$$\begin{aligned} \tau : \mathbf{k}\langle X \rangle \times \mathbf{k}\langle Y \rangle &\rightarrow \mathbf{k}\langle X \otimes Y \rangle \\ (x, y) &\mapsto x \otimes y \end{aligned}$$

is obviously bilinear, let us check that it is hypocontinuous.

Let W be an open linear subspace of $\mathbf{k}\langle X \otimes Y \rangle$ and let $w' \in \text{F}(X \otimes Y)^\perp$ be such that $\mathcal{V}_{X \otimes Y}(w') \subseteq W$. Let $B \subseteq \mathbf{k}\langle X \rangle$ be a linearly bounded subspace and let $u \in \text{F}(X)$ be such that $B \subseteq \mathcal{B}_X(u)$. Since $w' \in \text{F}(X \multimap Y)^\perp$ we have $v' = w'u \in \text{F}(Y)^\perp$. Let $x \in B$ and $y \in \mathcal{V}_Y(v')$, we have $\text{supp}(x) \subseteq u$ and hence $\text{pr}_2(\text{supp}(x \otimes y) \cap w') \subseteq \text{pr}_2((u \times \text{supp}(y)) \cap w') = (w'u) \cap \text{supp}(y) = \emptyset$ by definition of $\mathcal{V}_Y(v')$. Therefore $x \otimes y \in \mathcal{V}_{X \otimes Y}(w') \subseteq W$. Symmetrically, taking a linearly bounded subspace C of $\mathbf{k}\langle Y \rangle$, we show that there is an open linear subspace U of $\mathbf{k}\langle X \rangle$ such that $\tau(U \times C) \subseteq W$. So the map τ is bilinear and hypocontinuous.

Proposition 25 *Let Z be a finiteness space and let $f : \mathbf{k}\langle X \rangle \times \mathbf{k}\langle Y \rangle \rightarrow \mathbf{k}\langle Z \rangle$ be bilinear and hypocontinuous. There exists exactly one continuous linear map $\tilde{f} : \mathbf{k}\langle X \otimes Y \rangle \rightarrow \mathbf{k}\langle Z \rangle$ such that $f = \tilde{f} \circ \tau$.*

Proof.

We define a matrix $M \in \mathbf{k}^{|X| \times |Y| \times |Z|}$ by $M_{a,b,c} = f(e_a, e_b)_c$ and we show first that $\text{supp}(M) \in \mathbf{F}(X \otimes Y \multimap Z)$.

So let $u \in \mathbf{F}(X)$, $v \in \mathbf{F}(Y)$ and $w' \in \mathbf{F}(Z)^\perp$; we must show that $\text{supp}(M) \cap (u \times v \times w')$ is finite. Let $v' \in \mathbf{F}(Y)^\perp$ and $u' \in \mathbf{F}(X)^\perp$ be such that

$$f(\mathcal{B}_X(u) \times \mathcal{V}_Y(v')) \subseteq \mathcal{V}_Z(w') \text{ and } f(\mathcal{V}_X(u') \times \mathcal{B}_Y(v)) \subseteq \mathcal{V}_Z(w').$$

Let $(a, b, c) \in \text{supp}(M) \cap (u \times v \times w')$, since $f(e_a, e_b)_c \notin \mathcal{V}_Z(w')$ (by definition of $\mathcal{V}_Z(w')$) and by our assumption about (a, b, c) , we must have

$$(e_a, e_b) \notin \mathcal{B}_X(u) \times \mathcal{V}_Y(v') \text{ and } (e_a, e_b) \notin \mathcal{V}_X(u') \times \mathcal{B}_Y(v).$$

But we know that $a \in u$ and $b \in v$, that is $e_a \in \mathcal{B}_X(u)$ and $e_b \in \mathcal{B}_Y(v)$. It follows that $e_a \notin \mathcal{V}_X(u')$, that is $a \in u'$, and similarly $b \in v'$.

Since $\mathcal{B}_X(u)$ and $\mathcal{B}_Y(v)$ are linearly bounded, so is $f(\mathcal{B}_X(u) \times \mathcal{B}_Y(v))$ by Proposition 17 and hence there exists $w \in \mathbf{F}(Z)$ such that

$$f(\mathcal{B}_X(u) \times \mathcal{B}_Y(v)) \subseteq \mathcal{B}_Z(w).$$

Therefore $f(e_a, e_b) \in \mathcal{B}_Z(w)$ and hence $c \in w$.

We have shown that

$$\text{supp}(M) \cap (u \times v \times w') \subseteq (u \cap u') \times (v \cap v') \times (w \cap w')$$

and hence $\text{supp}(M) \cap (u \times v \times w')$ is finite, so $M \in \mathbf{k}\langle X \otimes Y \multimap Z \rangle$.

Let $\tilde{f} = \text{fun}(M)$, it is a linear and continuous map from $\mathbf{k}\langle X \otimes Y \rangle$ to $\mathbf{k}\langle Z \rangle$. We have $\tilde{f}(e_a \otimes e_b) = f(e_a, e_b)$ for each $(a, b) \in |X| \times |Y|$. Let $x \in \mathbf{F}(X)$ and $y \in \mathbf{k}\langle Y \rangle$, by separate continuity of f (which is a consequence of hypocontinuity) we have

$$\begin{aligned} f(x, y) &= f\left(\sum_{a \in |X|} x_a e_a, \sum_{b \in |Y|} y_b e_b\right) \\ &= \sum_{(a,b) \in |X| \times |Y|} x_a y_b f(e_a, e_b) \\ &= \sum_{(a,b) \in |X| \times |Y|} x_a y_b \tilde{f}(e_a \otimes e_b) \\ &= \tilde{f}(x \otimes y) \text{ by continuity of } \tilde{f}. \end{aligned}$$

Uniqueness of the continuous linear map \tilde{f} results from the fact that necessarily $\tilde{f}(e_a \otimes e_b) = f(e_a, e_b)$. \square

Then one proves easily that the category $\mathbf{Fin}^{\mathbf{k}}$ equipped with this tensor product (whose neutral object is 1, which satisfies obviously $\mathbf{k}\langle 1 \rangle = \mathbf{k}$) is $*$ -autonomous, the object of morphisms from X to Y being $X \multimap Y$ and the dualizing object being $\perp = 1$ (indeed, the finiteness spaces $X \multimap \perp$ and X^\perp are obviously strongly isomorphic).

This category is preadditive in the sense of Section 2.4 since homsets $\mathbf{Fin}^{\mathbf{k}}(X, Y)$ have an obvious structure of \mathbf{k} -vector space which is compatible with all the categorical operations introduced so far.

Countable products and coproducts are available as well. Let $(X_i)_{i \in I}$ be a countable family of finiteness spaces. The finiteness space $X = \&_{i \in I} X_i$ is given by $|X| = \bigcup_{i \in I} |X_i|$ and $F(X) = \{w \subseteq |X| \mid \forall i \in I \ w_i \in F(X_i)\}$ where $w_i = \{a \in |X_i| \mid (i, a) \in w\}$. It is easy to check that

$$F(X)^\perp = \{w' \subseteq |X| \mid \forall i \in I \ w'_i \in F(X_i)^\perp \text{ and } w'_i = \emptyset \text{ for almost all } i\}$$

and it follows that $F(X)^{\perp\perp} = F(X)$. It is clear that $\mathbf{k}\langle \&_{i \in I} X_i \rangle = \prod_{i \in I} \mathbf{k}\langle X_i \rangle$ up to a straightforward strong isomorphism and that $\&_{i \in I} X_i$ together with projections $\pi_j : \mathbf{k}\langle \&_{i \in I} X_i \rangle \rightarrow \mathbf{k}\langle X_j \rangle$ defined in the obvious way, is the cartesian product of the X_i 's.

Thanks to $*$ -autonomy, the coproduct of the X_i 's is given by $\bigoplus_{i \in I} X_i = (\&_{i \in I} X_i^\perp)^\perp$ and $\mathbf{k}\langle \bigoplus_{i \in I} X_i \rangle \subseteq \prod_{i \in I} \mathbf{k}\langle X_i \rangle$ is the space of all families $(x_i)_{i \in I}$ of vectors such that $x_i = 0$ for almost all $i \in I$. Of course, the canonical linear topology on $\mathbf{k}\langle \&_{i \in I} X_i \rangle$ is the product topology, but the canonical topology on $\mathbf{k}\langle \bigoplus_{i \in I} X_i \rangle$ is much finer: it is generated by all products $\prod_{i \in I} V_i$ where V_i is a linear neighborhood of 0 in $\mathbf{k}\langle X_i \rangle$.

For finite families of objects, products and coproducts coincide.

Let X be a finiteness space. We define $!X$ by $!X = \mathcal{M}_{\text{fin}}(|X|)$ and

$$F(!X) = \{A \subseteq !X \mid \bigcup_{m \in A} \text{supp}(m) \in F(X)\}$$

and it can be proved that indeed $F(!X) = F(!X)^{\perp\perp}$ (again, see [TV10] for more general results of this kind).

Given $x \in \mathbf{k}\langle X \rangle$ and $m \in !X$, we set

$$x^m = \prod_{a \in |X|} x_a^{m(a)} \in \mathbf{k}$$

(this is a finite product since $\text{supp}(m)$ is a finite set), so that

$$x^! = (x^m)_{m \in !X} \in \mathbf{k}\langle !X \rangle$$

by definition of $F(!X)$. Let $M \in \mathbf{k}\langle !X \multimap Y \rangle$, it is not hard to see that one defines a map $\text{Fun}(M) : \mathbf{k}\langle X \rangle \rightarrow \mathbf{k}\langle Y \rangle$ by setting

$$\text{Fun}(M)(x) = \left(\sum_{m \in !X} M_{m,b} x^m \right)_{b \in |Y|}$$

all these sums are indeed finite, see [Ehr05] for the details. When the field \mathbf{k} is infinite, the map $M \mapsto \text{Fun}(M)$ is injective.

In [Ehr05], it is also proven that $!_-$ is a functor. Given $M \in \mathbf{k}\langle X \multimap Y \rangle$ one defines $!M \in \mathbf{k}\langle !X \multimap !Y \rangle$ by setting, for $m \in |!X|$ and $p \in |!Y|$,

$$(!M)_{m,p} = \sum_{r \in L(m,p)} [r] M^r$$

where

$$L(m,p) = \{r \in \mathcal{M}_{\text{fin}}(|X| \times |Y|) \mid \sum_{b \in |Y|} r(a,b) = m(a) \text{ and } \sum_{a \in |X|} r(a,b) = p(b)\}$$

(so that $r \in L(m,p) \Rightarrow \#m = \#r = \#p$) and

$$[r] = \prod_{b \in |Y|} \frac{p(b)!}{\prod_{a \in |X|} r(a,b)!} \in \mathbb{N}^+.$$

is a generalized multinomial coefficient.

This operation is functorial: $! \text{Id} = \text{Id}$ and $!M!N = !(MN)$, and we also have

$$\text{Fun}(!M)(x) = !M x^! = (Mx)^!.$$

When \mathbf{k} is infinite, this latter equation completely characterizes $!M$, by injectivity of the operation Fun in that case. This functor has a comonad structure, of which we recall here only the counit $\text{d}_X \in \mathbf{k}\langle !X \multimap X \rangle$ given by $(\text{d}_X)_{m,a} = \delta_{m,[a]}$.

The bijection $!(X \& Y) \rightarrow !X \otimes !Y$ which maps the element $q \in !(X \& Y)$ to the pair $(m,p) \in !X \otimes !Y$ defined by $m(a) = q(1,a)$ and $p(b) = q(2,b)$ is a strong isomorphism of finiteness spaces. We also have a strong isomorphism from $!\perp$ to 1 . These strong isomorphisms induce natural isomorphisms $m_{X,Y}^2 \in \mathbf{Fin}^{\mathbf{k}}(!X \otimes !Y, !(X \& Y))$ and $m^0 \in \mathbf{Fin}^{\mathbf{k}}(1, !\top)$ which endow the functor $!_-$ with a monoidality structure from $(\mathbf{Fin}^{\mathbf{k}}, \&, \top)$ to $(\mathbf{Fin}^{\mathbf{k}}, \otimes, 1)$, satisfying moreover the coherence diagram (??): to summarize, equipped with the structure described above, $\mathbf{Fin}^{\mathbf{k}}$ is a Seely category, that is, a categorical model of classical LL.

Applying the general recipe of Section 4.1, we get the contraction natural transformation $\text{c}_X : !X \rightarrow !X \otimes !X$ and the weakening morphism $\text{w}_X : !X \rightarrow 1$. We check that $(\text{w}_X)_{m,*} = \delta_{m,[]}$ and that $(\text{c}_X)_{m,(p,q)} = \delta_{m,p+q}$. We also get the cocontraction natural transformation $\bar{\text{c}}_X : !X \otimes !X \rightarrow !X$ and the coweakening morphism $\bar{\text{w}}_X : 1 \rightarrow !X$. And we check that $(\bar{\text{w}}_X)_{*,m} = \delta_{m,[]}$, and that $(\bar{\text{c}}_X)_{(p,q),m} = \binom{p+q}{p} \delta_{m,p+q}$ where

$$\binom{m}{p} = \prod_{a \in |X|} \frac{m(a)!}{p(a)!(m(a)-p(a))!} \in \mathbb{N}^+$$

is a generalized binomial coefficient.

We also have a codereliction natural transformation $\bar{\text{d}}_X : X \rightarrow !X$ given by $(\bar{\text{d}}_X)_{a,m} = \delta_{m,[a]}$, which is easily seen to satisfy the conditions of Section 2.5 and 2.6, so that $\mathbf{Fin}^{\mathbf{k}}$ is a model of full differential LL.

4.5.4 An intrinsic presentation of function spaces.

We have seen that a morphism from X to Y of the linear category $\mathbf{Fin}^{\mathbf{k}}$ can be seen both as an element of $\mathbf{k}\langle X \multimap Y \rangle$ and as a continuous linear function from $\mathbf{k}\langle X \rangle$ to $\mathbf{k}\langle Y \rangle$.

A morphism from X to Y in the Kleisli category $\mathbf{Rel}_!^{\mathbf{k}}$ is an element of $\mathbf{k}\langle !X \multimap Y \rangle$. Given $M \in \mathbf{k}\langle !X \multimap Y \rangle$, we have seen that we can define a function $\text{Fun } M : \mathbf{k}\langle X \rangle \rightarrow \mathbf{k}\langle Y \rangle$ by

$$\text{Fun}(M)(x) = M x^! = \left(\sum_{m \in !|X|} M_{m,b} x^m \right)_{b \in |Y|}.$$

Moreover, the correspondence $M \rightarrow \text{Fun}(M)$ is functorial. We provide here an intrinsic characterization of these functions.

Let E and F be ltv's. Let us say that a function $f : E \rightarrow F$ is *polynomial* if there is $n \in \mathbb{N}$ and *hypocontinuous* i -linear maps $f_i : E^i \rightarrow F$ (for $i = 0, \dots, n$) such that

$$f(x) = f_0 + f_1(x) + \dots + f_n(x, \dots, x).$$

A polynomial map f of the form $f(x) = f_n(x, \dots, x)$, where f_n is an n -linear hypocontinuous function, is said to be *homogeneous of degree n* (this condition implies of course $\forall t \in \mathbf{k} f(tx) = t^n f(x)$, and when \mathbf{k} is infinite, a polynomial function is homogeneous iff it satisfies this latter condition).

Let $\text{Pol}_{\mathbf{k}}(E, F)$ be the \mathbf{k} -vector space of polynomial functions from E to F . This space can be endowed with the linear topology of uniform convergence on all linearly bounded subspaces, which admits the following generating filter base of open neighborhoods of 0: the basic opens are the linear subspaces $\text{Ann}(B, V) = \{f \in \text{Pol}_{\mathbf{k}}(E, F) \mid f(B) \subseteq V\}$, where B is a linearly bounded subspace of E and V is a linear open subspace of F . Let $\text{Ana}_{\mathbf{k}}(E, F)$ be the completion¹³ of that ltv's.

Theorem 26 *Assume that \mathbf{k} is infinite. For any finiteness spaces X and Y , the ltv's $\mathbf{k}\langle !X \multimap Y \rangle$ is linearly homeomorphic to $\text{Ana}_{\mathbf{k}}(\mathbf{k}\langle X \rangle, \mathbf{k}\langle Y \rangle)$.*

Proof.

Let $h : \mathbf{k}\langle X \rangle^n \rightarrow \mathbf{k}\langle Y \rangle$ be an hypocontinuous n -linear function of matrix $M \in \mathbf{k}\langle X \otimes \dots \otimes X \multimap Y \rangle$, so that $h(x_1, \dots, x_n) = M(x_1 \otimes \dots \otimes x_n)$.

Remember that, using contraction and dereliction, we have defined in Section 3 the morphism $d_X^n \in \mathbf{k}\langle !X \multimap X \otimes \dots \otimes X \rangle$. Then we have $N = M d_X^n \in \mathbf{k}\langle !X \multimap Y \rangle$, and it is easy to see that

$$\text{Fun}(N)(x) = h(x, \dots, x).$$

¹³A completion of an ltv's E is a pair (\tilde{E}, h) where \tilde{E} is a complete ltv's and $h : E \rightarrow \tilde{E}$ is a linear and continuous map such that, for any complete ltv's F and any linear continuous map $f : E \rightarrow F$, there is a unique linear and continuous map $\tilde{f} : \tilde{E} \rightarrow F$ such that $\tilde{f} \circ h = f$. Using standard techniques, one can prove that any ltv's admits a completion, which is unique up to unique isomorphism.

In that way, we see that any polynomial map from $\mathbf{k}\langle X \rangle$ to $\mathbf{k}\langle Y \rangle$ is an element of $\mathbf{k}\langle !X \multimap Y \rangle$; we have an inclusion $\text{Pol}_{\mathbf{k}}(\mathbf{k}\langle X \rangle, \mathbf{k}\langle Y \rangle) \subseteq \mathbf{k}\langle !X \multimap Y \rangle$. Actually, the exponential structure $\mathbf{Fin}^{\mathbf{k}}$ is Taylor and this notion of polynomial map coincides with the general notion of Section 3.1.

Conversely, let $(m, b) \in !X \multimap Y$ with $m = [a_1, \dots, a_n]$. The map $f : \mathbf{k}\langle X \rangle^n \rightarrow \mathbf{k}$ defined by $f(x(1), \dots, x(n)) = x(1)_{a_1} \dots x(n)_{a_n}$ is multilinear and hypocontinuous. Hence the same holds for the map $x \mapsto f(x)_{e_b}$ from $\mathbf{k}\langle X \rangle^n$ to $\mathbf{k}\langle Y \rangle$. Therefore we have $\mathbf{k}\langle !X \multimap Y \rangle \subseteq \text{Pol}_{\mathbf{k}}(\mathbf{k}\langle X \rangle, \mathbf{k}\langle Y \rangle)$ (given a set I , remember that $\mathbf{k}\langle I \rangle$ is the \mathbf{k} -vector space generated by I , that is, the space of all families $(a_i)_{i \in I}$ of elements of \mathbf{k} such that $a_i = 0$ for almost all i 's).

Hence $\text{Pol}_{\mathbf{k}}(\mathbf{k}\langle X \rangle, \mathbf{k}\langle Y \rangle)$ is a dense subspace of $\mathbf{k}\langle !X \multimap Y \rangle$. To show that $\mathbf{k}\langle !X \multimap Y \rangle$ is the completion of $\text{Pol}_{\mathbf{k}}(\mathbf{k}\langle X \rangle, \mathbf{k}\langle Y \rangle)$ it suffices to show that the above defined linear topology on that space (uniform convergence on all linearly bounded subspaces) is the restriction of the topology of $\mathbf{k}\langle !X \multimap Y \rangle$.

Let $B \subseteq \mathbf{k}\langle X \rangle$ be a linearly bounded subspace and let $V \subseteq \mathbf{k}\langle Y \rangle$ be linear open. Let $v' \in F(Y)^\perp$ be such that $\mathcal{V}_Y(v') \subseteq V$. By Proposition 21, $\text{supp}(B) \in F(X)$, so $\mathcal{M}_{\text{fin}}(\text{supp}(B)) \in F(!X)$. Let

$$M \in \mathcal{V}_{!X \multimap Y}(\mathcal{M}_{\text{fin}}(\text{supp}(B)) \times v') \subseteq \mathbf{k}\langle !X \multimap Y \rangle,$$

then $\text{fun}(M)(x)_b = 0$ for each $x \in B$ and $b \in v'$. So we have

$$\mathcal{V}_{!X \multimap Y}(\mathcal{M}_{\text{fin}}(\text{supp}(B)) \times v') \cap \text{Pol}_{\mathbf{k}}(\mathbf{k}\langle X \rangle, \mathbf{k}\langle Y \rangle) \subseteq \text{Ann}(B, V).$$

Conversely let $U \in F(!X)$ and $v' \in F(Y)^\perp$, then we have $u = \bigcup_{m \in U} \text{supp}(m) \in F(X)$ and hence the subspace $B \subseteq \mathbf{k}\langle X \rangle$ of all vectors which vanish outside u is linearly bounded. Let $M \in \mathbf{k}\langle !X \multimap Y \rangle$ be such that the map $\text{Fun}(M) : \mathbf{k}\langle X \rangle \rightarrow \mathbf{k}\langle Y \rangle$ is polynomial and belongs to $\text{Ann}(B, \mathcal{V}_Y(v'))$. Then for any $m = [a_1, \dots, a_n] \in \mathcal{M}_{\text{fin}}(u)$ and $b \in v'$ we have $M_{m,b} = 0$ because this scalar is the coefficient of the monomial $\xi_1^{m(a_1)} \dots \xi_n^{m(a_n)}$ in the polynomial $P \in \mathbf{k}[\xi_1, \dots, \xi_n]$ such that $P(z_1, \dots, z_n) = \text{Fun}(M)(x)_b$ where $x \in \mathbf{k}\langle X \rangle$ is such that $x_a = z_i$ if $a = a_i$ and $x_a = 0$ if $a \notin \text{supp}(m)$, and $P = 0$ because $\text{Fun}(M)(B) \subseteq \mathcal{V}_Y(v')$ by assumption (we also use the fact that \mathbf{k} is infinite). Hence $M \in \mathcal{V}_{!X \multimap Y}(U \times v')$ and we have shown that

$$\text{Ann}(B, \mathcal{V}_Y(v')) \subseteq \mathcal{V}_{!X \multimap Y}(U \times v') \cap \text{Pol}_{\mathbf{k}}(\mathbf{k}\langle X \rangle, \mathbf{k}\langle Y \rangle),$$

showing that this latter set is a neighborhood of 0 in the space of polynomials. \square

The Taylor formula proved in [Ehr05] for the morphisms of this Kleisli category shows that actually any morphism is the sum of a converging series whose n -th term is an homogeneous polynomial of degree n .

As an example, take $E = \mathbf{k}[\xi] \simeq \mathbf{k}\langle !1 \multimap 1 \rangle$. The corresponding topology on E is the discrete topology. A typical example of generalized polynomial map is the function $\varphi : E \rightarrow \mathbf{k}$ which maps a polynomial P to $P(P(0))$, in other words, $\varphi(x_0 + x_1\xi + \dots + x_n\xi^n) = x_0 + x_1x_0 + \dots + x_nx_0^n$. Considered as a

generalized polynomial of infinitely many variables x_0, x_1, \dots , we see that φ is not of bounded degree, and so it is not polynomial. Nevertheless, it corresponds to a very simple and finite computation on polynomials.

4.5.5 Antiderivatives.

Just as **Rel**, the **Fin^k** exponential structure is Taylor in the sense of Section 3.1. Moreover, if **k** is of characteristic 0 (meaning that $\forall n \in \mathbb{N} \ n \neq 0 \Rightarrow n = 0$) it has antiderivatives in the sense of 3.2, because the morphism $J_X = \text{Id}_X + (\bar{\partial}_X \partial_X) : !X \rightarrow !X$ satisfies $(J_X)_{p,q} = (\#p+1)\delta_{p,q}$ for all $p, q \in |!X|$ and hence is an isomorphism whose inverse I_X is given by $(I_X)_{p,q} = \frac{1}{\#p+1}\delta_{p,q}$.

Acknowledgment

Part of the work reported in this article has been supported by the French-Chinese project ANR-11-IS02-0002 and NSFC 61161130530 *Locali*.

References

- [Abr93] Samson Abramsky. Computational interpretations of linear logic. *Theoretical Computer Science*, 111:3–57, 1993.
- [BCEM11] Antonio Bucciarelli, Alberto Carraro, Thomas Ehrhard, and Giulio Manzonetto. Full Abstraction for Resource Calculus with Tests. In Marc Bezem, editor, *CSL*, volume 12 of *LIPICs*. Schloss Dagstuhl - Leibniz-Zentrum fuer Informatik, 2011.
- [BCL99] Gérard Boudol, Pierre-Louis Curien, and Carolina Lavatelli. A semantics for lambda calculi with resource. *Mathematical Structures in Computer Science*, 9(4):437–482, 1999.
- [BCS06] Richard Blute, Robin Cockett, and Robert Seely. Differential categories. *Mathematical Structures in Computer Science*, 16(6):1049–1083, 2006.
- [BET12] Richard Blute, Thomas Ehrhard, and Christine Tasson. A convenient differential category. *Cahiers de Topologie et Géométrie Différentielle Catégoriques*, 53, 2012.
- [Bie95] Gavin Bierman. What is a categorical model of intuitionistic linear logic? In Mariangiola Dezani-Ciancaglini and Gordon D. Plotkin, editors, *Proceedings of the second Typed Lambda-Calculi and Applications conference*, volume 902 of *Lecture Notes in Computer Science*, pages 73–93. Springer-Verlag, 1995.

- [Cur09] Pierre-Louis Curien, editor. *Typed Lambda Calculi and Applications, 9th International Conference, TLCA 2009, Brasilia, Brazil, July 1-3, 2009. Proceedings*, volume 5608 of *Lecture Notes in Computer Science*. Springer, 2009.
- [DB87] N.G. De Bruijn. Generalizing Automath by means of a lambda-typed lambda calculus. In D.W. Kueker, E.G.K. Lopez-Escobar, and C.H. Smith, editors, *Mathematical Logic and Theoretical Computer Science*, Lecture Notes in Pure and Applied Mathematics, pages 71–92. Marcel Dekker, 1987. Reprinted in: Selected papers on Automath, *Studies in Logic*, volume 133, pages 313–337, North-Holland, 1994.
- [DR99] Vincent Danos and Laurent Regnier. Reversible, irreversible and optimal lambda-machines. *Theoretical Computer Science*, 227(1-2):273–291, 1999.
- [Ehr02] Thomas Ehrhard. On Köthe sequence spaces and linear logic. *Mathematical Structures in Computer Science*, 12:579–623, 2002.
- [Ehr05] Thomas Ehrhard. Finiteness spaces. *Mathematical Structures in Computer Science*, 15(4):615–646, 2005.
- [Ehr10] Thomas Ehrhard. A finiteness structure on resource terms. In *LICS*, pages 402–410. IEEE Computer Society, 2010.
- [Ehr12] Thomas Ehrhard. The Scott model of Linear Logic is the extensional collapse of its relational model. *Theoretical Computer Science*, 424:20–45, 2012.
- [Ehr14] Thomas Ehrhard. A new correctness criterion for MLL proof nets. In Thomas A. Henzinger and Dale Miller, editors, *Joint Meeting of the Twenty-Third EACSL Annual Conference on Computer Science Logic (CSL) and the Twenty-Ninth Annual ACM/IEEE Symposium on Logic in Computer Science (LICS), CSL-LICS '14, Vienna, Austria, July 14 - 18, 2014*, page 38. ACM, 2014.
- [ER03] Thomas Ehrhard and Laurent Regnier. The differential lambda-calculus. *Theoretical Computer Science*, 309(1-3):1–41, 2003.
- [ER06] Thomas Ehrhard and Laurent Regnier. Böhm trees, Krivine machine and the Taylor expansion of ordinary lambda-terms. In Arnold Beckmann, Ulrich Berger, Benedikt Löwe, and John V. Tucker, editors, *Logical Approaches to Computational Barriers*, volume 3988 of *Lecture Notes in Computer Science*, pages 186–197. Springer-Verlag, 2006. Long version available on <http://www.pps.univ-paris-diderot.fr/~ehrhards/>.

- [ER08] Thomas Ehrhard and Laurent Regnier. Uniformity and the Taylor expansion of ordinary lambda-terms. *Theoretical Computer Science*, 403(2-3):347–372, 2008.
- [Fio07] Marcelo P. Fiore. Differential structure in models of multiplicative biadditive intuitionistic linear logic. In Simona Ronchi Della Rocca, editor, *TLCA*, volume 4583 of *Lecture Notes in Computer Science*, pages 163–177. Springer, 2007.
- [FM99] Maribel Fernández and Ian Mackie. A Calculus for Interaction Nets. In Gopalan Nadathur, editor, *PPDP*, volume 1702 of *Lecture Notes in Computer Science*, pages 170–187. Springer-Verlag, 1999.
- [Gim11] Stéphane Gimenez. Realizability proof for normalization of full differential linear logic. In C.-H. Luke Ong, editor, *TLCA*, volume 6690 of *Lecture Notes in Computer Science*, pages 107–122. Springer-Verlag, 2011.
- [Gir86] Jean-Yves Girard. The system F of variable types, fifteen years later. *Theoretical Computer Science*, 45:159–192, 1986.
- [Gir87] Jean-Yves Girard. Linear logic. *Theoretical Computer Science*, 50:1–102, 1987.
- [Gir88] Jean-Yves Girard. Normal functors, power series and the λ -calculus. *Annals of Pure and Applied Logic*, 37:129–177, 1988.
- [Hut93] Michael Huth. Linear Domains and Linear Maps. In Stephen D. Brookes, Michael G. Main, Austin Melton, Michael W. Mislove, and David A. Schmidt, editors, *MFPS*, volume 802 of *Lecture Notes in Computer Science*, pages 438–453. Springer-Verlag, 1993.
- [Kri85] Jean-Louis Krivine. Un interpréteur du lambda-calcul. Unpublished note, 1985.
- [Kri07] Jean-Louis Krivine. A call-by-name lambda-calculus machine. *Higher-Order and Symbolic Computation*, 20(3):199–207, 2007.
- [Mac71] Saunders Mac Lane. *Categories for the Working Mathematician*, volume 5 of *Graduate Texts in Mathematics*. Springer-Verlag, 1971.
- [Mel09] Paul-André Melliès. Categorical semantics of linear logic. *Panoramas et Synthèses*, 27, 2009.
- [MS08] Ian Mackie and Shinya Sato. A Calculus for Interaction Nets Based on the Linear Chemical Abstract Machine. *Electronic Notes in Theoretical Computer Science*, 192(3):59–70, 2008.
- [Pag09] Michele Pagani. The cut-elimination theorem for differential nets with promotion. In Curien [Cur09], pages 219–233.

- [PT09] Michele Pagani and Paolo Tranquilli. Parallel Reduction in Resource Lambda-Calculus. In Zhenjiang Hu, editor, *APLAS*, volume 5904 of *Lecture Notes in Computer Science*, pages 226–242. Springer, 2009.
- [PT11] Michele Pagani and Paolo Tranquilli. The Conservation Theorem for Differential Nets. *Mathematical Structures in Computer Science*, 2011. To appear.
- [Ret03] Christian Retoré. Handsome proof-nets: perfect matchings and cographs. *Theoretical Computer Science*, 294(3):473–488, 2003.
- [Tas09a] Christine Tasson. Algebraic totality, towards completeness. In Curien [Cur09], pages 325–340.
- [Tas09b] Christine Tasson. *Sémantiques et syntaxes vectorielles de la logique linéaire*. Thèse de doctorat, Université Paris Diderot – Paris 7, 2009.
- [Tra09] Paolo Tranquilli. Confluence of pure differential nets with promotion. In Erich Grädel and Reinhard Kahle, editors, *CSL*, volume 5771 of *Lecture Notes in Computer Science*, pages 500–514. Springer-Verlag, 2009.
- [TV10] Christine Tasson and Lionel Vaux. Transport of finiteness structures and applications. *Mathematical Structures in Computer Science*, 2010. To appear.
- [Vau05] Lionel Vaux. The differential lambda-mu calculus. *Theoretical Computer Science*, 379(1-2):166–209, 2005.
- [Vau09] Lionel Vaux. The algebraic lambda-calculus. *Mathematical Structures in Computer Science*, 19(5):1029–1059, 2009.
- [Win04] Glynn Winskel. Linearity and non linearity in distributed computation. In Thomas Ehrhard, Jean-Yves Girard, Paul Ruet, and Philip Scott, editors, *Linear Logic in Computer Science*, volume 316 of *London Mathematical Society Lecture Notes Series*. Cambridge University Press, 2004.