

known to be fixed-parameter tractable [8, 14], to have constant-factor approximation algorithms [2, 5, 48], and to have kernels of polynomial size [10, 13, 48, 50], our understanding of CHORDAL VERTEX DELETION (CHVD) is lacking behind greatly. The problem is known to be fixed-parameter tractable by a result of Marx [47] and the current-best runtime is $2^{\mathcal{O}(k \log k)} \cdot n^{\mathcal{O}(1)}$ [18]. The kernelization and approximation complexity of CHVD has remained unresolved, however. The question whether CHVD has a polynomial kernel or not has been open for 10 years [46], and has been posed by several groups of authors [18, 29, 37] and during the 2013 Workshop on Kernelization [19]. The approximability of CHVD is similarly open. To the best of our knowledge, nothing was known prior to this work.

Results We resolve the kernelization complexity of CHVD and show that the problem has a kernel of polynomial size. Our main data reduction procedure is summarized by the following theorem.

Theorem 1. *There is a polynomial-time algorithm that, given an instance (G, k) of CHORDAL VERTEX DELETION and a modulator $M_0 \subseteq V(G)$ such that $G - M_0$ is chordal, outputs an equivalent instance (G', k') with $\mathcal{O}(k^{45} \cdot |M_0|^{29})$ vertices and $k' \leq k$.*

To be able to apply this reduction algorithm, a modulator M_0 is needed to reveal the structure of the chordal graph $G - M_0$. If CHVD would have a polynomial-time constant-factor approximation algorithm, or even a poly(OPT)-approximation algorithm, one could bootstrap Theorem 1 with an approximate solution as modulator to obtain a polynomial kernel for CHVD. Prior to this work, no such approximation algorithm was known. We developed a poly(OPT)-approximation algorithm to complete the kernelization, which we believe to be of independent interest.

Theorem 2. *There is a polynomial-time algorithm that, given an undirected graph G and an integer k , either correctly concludes that (G, k) is a no-instance of CHVD or computes a set $X \subseteq V(G)$ of size $\mathcal{O}(k^4 \log^2 k)$ such that $G - X$ is chordal.*

Combining the two theorems, we obtain a kernel with $\mathcal{O}(k^{161} \log^{58} k)$ vertices for CHVD. To appreciate the conceptual difficulties in obtaining a polynomial kernel for CHVD, let us point out why some popular kernelization strategies fail. In general, the difficulty of the \mathcal{G} VERTEX DELETION problem is tightly linked to the amount of structure of graphs in \mathcal{G} . If all graphs in \mathcal{G} have bounded treewidth, and \mathcal{G} is closed under taking minors, then one can obtain a kernel by repeatedly replacing large *protrusions* [9, 28] in the graph by smaller gadgets. Since edgeless graphs and acyclic graphs are minor-closed and have constant treewidth, this explains the existence of kernels for VERTEX COVER and FEEDBACK VERTEX SET. This approach does not work for CHVD, as chordal graphs can have arbitrarily large treewidth (every clique is chordal). Another kernelization strategy for vertex deletion problems into hereditary classes \mathcal{G} is to model the problem as an instance of HITTING SET and apply a kernelization strategy based on the Sunflower lemma (cf. [26, §9.1]). This yields polynomial kernels when there is a characterization of \mathcal{G} in terms of a finite set of forbidden induced subgraphs, such as co-graphs. However, the number of forbidden induced subgraphs for chordal graphs is infinite as this set contains all induced cycles of length at least four, making this approach infeasible as well.

Techniques Several recent kernelization results rely on matroid theory [41, 42] (resulting in randomized kernels), or on *finite integer index*, or the Graph-Minor Theorem [9, 28, 30, 39] (resulting in proofs that kernelization algorithms exist without showing how they should be constructed). In contrast, our kernelization algorithm is deterministic and fully explicit; it is based on new graph-theoretical insights into the structure of chordal graphs.

A key ingredient in our kernelization is an algorithmic version of Erdős-Pósa type [23] covering/packing duality for holes in chordal graphs, expressed in terms of *flowers*. A v -flower of order k in graph G is a set \mathcal{C} of k holes $\mathcal{C} = \{C_1, \dots, C_k\}$ in G , such that $V(C_i) \cap V(C_j) = \{v\}$ for all $i \neq j$.

Lemma 1. *There is a polynomial-time algorithm that, given a graph G and a vertex v such that $G - v$ is chordal, outputs a v -flower C_1, \dots, C_k and a set $S \subseteq V(G) \setminus \{v\}$ of size at most $12k$ such that $G - S$ is chordal.*

So either there is a large packing of holes intersecting only in v , or all the holes can be intersected by a small set of vertices. We prove Lemma 1 by presenting a local search algorithm that builds a flower, followed by a greedy algorithm to construct a hitting set when the local search cannot make further

progress. This procedure forms the first step in a series of arguments that *tidy the modulator* (in the sense of [52]) and narrow down the structure of the graph, which enables us to identify irrelevant parts of the graph which can be reduced. Section 3 describes the intuition behind the kernelization in more detail.

When it comes to the approximation algorithm, we combine linear-programming rounding techniques with structural insights into the behavior of nearly-chordal graphs. Since chordal graphs have balanced clique separators, if (G, k) is a yes-instance of CHVD then there is a balanced separator in G consisting of a clique plus k vertices. We use an approximation algorithm for minimum-weight vertex separators of Feige et al. [25] together with an enumeration of maximal cliques to decompose the graph. This decomposition step reduces the problem of finding an approximate solution to the setting in which we have an input graph G and a clique X such that $G - X$ is chordal, and the aim is to find a small chordal deletion set in G (smaller than $|X|$). After a second decomposition step, an analysis of the structure of holes allows the problem to be phrased in terms of multicut on a directed graph, to which we apply a result of Gupta [36].

Motivation The parameterized complexity of graph modification problems to chordal graphs and related graph classes gained significant interest in recent years. Several factors explain the popularity of such problems. First, chordal graphs and related graph classes, such as interval graphs, appear naturally in applications in solving linear equations [12], in scheduling [3], and in bioinformatics [49, 53]. Second, from a more theoretical perspective, these graph classes are closely related to widely used graph parameters, such as treewidth: a tree decomposition can be seen as a completion to a chordal graph, and similar relations hold between interval graphs and pathwidth, proper interval graphs and bandwidth, or trivially perfect graphs and treedepth (cf. [22]). Third, to this day, we do not know of a vertex-deletion problem that is FPT but has no polynomial kernel. (We do know of some ones that are not FPT, such as PERFECT DELETION [37].) It is tempting to conjecture that all FPT vertex deletion problems have polynomial kernels. CHVD is a candidate for refuting this conjecture, and resolving its complexity status gives us more insight into the landscape of kernelization complexity of vertex deletion problems. Fourth, as witnessed by numerous works in the past years [6, 7, 16, 17, 18, 22, 29], most graph modification problems to chordal graphs and related graph classes turn out to be tractable but very challenging; the corresponding algorithmic results build upon deep graph-theoretical insights into the studied graph class, making this study particularly interesting from the point of view of graph theory.

One motivation for studying the particular case of vertex deletion to a chordal graph comes from the following fact: given a graph G and a modulator M such that $G - M$ is chordal, one can find a maximum independent set, maximum clique, and minimum vertex cover of G in time $2^{|M|} \cdot n^{\mathcal{O}(1)}$ (cf. [15, §6]). Hence an efficient algorithm for chordal vertex deletion allows these fundamental optimization problems to be solved efficiently on almost-chordal graphs.

Related work Kernels are known for a wide variety of vertex-deletion problems [28, 29, 34, 42, 48, 50]. The recent kernels for ODD CYCLE TRANSVERSAL [42] and PROPER INTERVAL VERTEX DELETION [29] are noteworthy since, like chordal graphs, bipartite graphs and proper interval graphs do not have bounded treewidth and do not have a characterization by a finite set of forbidden induced subgraphs. There are linear kernels for CHVD on planar graphs [9] and H -topological-minor-free graphs [39]. Concerning *structural* parameterizations, the CHVD problem is known to have polynomial kernels when parameterized by the size of a vertex cover [27], when parameterized by the size of a set of candidate vertices from which the solution is required to be selected [37], and on bounded-expansion graphs when parameterized by a constant-treedepth modulator [30]. Approximation algorithms have been developed for (weighted) FEEDBACK VERTEX SET [2, 5], ODD CYCLE TRANSVERSAL [31], and its edge-deletion variant [1].

Organization We present preliminaries on graphs in Section 2. Section 3 contains an informal overview of the data reduction procedure. Section 4 is devoted to the proof of Lemma 1. We introduce an annotated version of CHVD in Section 5, which captures some of the structure we can obtain in the instance by appropriate use of Lemma 1. Sections 6–9 present reduction rules for instances of the annotated problem. The approximation algorithm is given in Section 10, which allows us to give the final kernel in Section 11.

2 Preliminaries

The set $\{1, \dots, n\}$ is abbreviated as $[n]$. A set S *avoids* a set U if $S \cap U = \emptyset$. For a set U , by $\binom{U}{2}$ we denote the family of all unordered pairs of distinct vertices of U . We often use xy instead of $\{x, y\}$ for an element of $\binom{U}{2}$. A graph G consists of a vertex set $V(G)$ and edge set $E(G) \subseteq \binom{V(G)}{2}$. For a vertex $v \in V(G)$ its open neighborhood is $N_G(v) := \{u \in V(G) \mid uv \in E(G)\}$ and its closed neighborhood is $N_G[v] := N_G(v) \cup \{v\}$. The open neighborhood of a set $S \subseteq V(G)$ is $N_G(S) := \bigcup_{v \in S} N_G(v) \setminus S$, and the closed neighborhood is $N_G[S] := \bigcup_{v \in S} N_G[v]$. The graph obtained from G by deleting all vertices in the set S and their incident edges is denoted $G - S$; for a single vertex $v \in V(G)$ we use $G - v$ as a shorthand for $G - \{v\}$.

An *st-walk* in a graph G is a sequence of vertices $s = v_1, v_2, \dots, v_\ell = t$ such that $v_i = v_{i+1}$ or $v_i v_{i+1} \in E(G)$ for $i \in [\ell - 1]$. An *st-path* is an *st-walk* on which all vertices are distinct. For a walk W or path P we use $V(W)$ and $V(P)$ to denote the vertices of W and P , respectively. For an *st-path* P , the vertices s and t are its *endpoints* and $V(P) \setminus \{s, t\}$ are its *interior vertices*.

Observation 1. For any *st-walk* W in a graph G , any shortest *st-path* in $G[V(W)]$ is an induced *st-path* P in G with $V(P) \subseteq V(W)$.

A *hole* is an induced (i.e., chordless) cycle of length at least four. A graph is *chordal* if it does not contain any holes; we say that such graphs are *hole-free*. The *independence number* of a graph G , denoted $\alpha(G)$, is the maximum cardinality of a set of vertices in G in which no pair is connected by an edge. Similarly, the *clique number* $\omega(G)$ is the maximum cardinality of a set of vertices that are pairwise all adjacent.

Proposition 1. Any chordal graph G satisfies $\alpha(G) \geq |V(G)|/\omega(G)$.

Proof. As any chordal graph is perfect [11], the chromatic number of G equals $\omega(G)$. A proper coloring with $\omega(G)$ colors is a partition into $\omega(G)$ independent sets. At least one color class has size $|V(G)|/\omega(G)$, guaranteeing an independent set of that size. \square

Tree decompositions A *tree decomposition* of a graph G is a pair (T, β) , where T is a rooted tree and $\beta: V(T) \rightarrow 2^{V(G)}$ assigns to every node $p \in V(T)$ a subset of the vertices of G , called a *bag*, such that the following holds:

1. $\bigcup_{p \in V(T)} \beta(p) = V(G)$, and
2. for each edge $uv \in E(G)$ there is a node $p \in V(T)$ such that $uv \subseteq \beta(p)$, and
3. for each $v \in V(G)$, the nodes of T whose bag contains v induce a connected subtree of T .

For a vertex $v \in V(G)$ we use $\beta^{-1}(v)$ to denote the set of nodes of T whose bag contains v . The third property ensures that $\beta^{-1}(v)$ is a subtree of T for all $v \in V(G)$. We use T_p to denote the subtree of T rooted at $p \in V(T)$. The *adhesion* of an edge $e = pq$ of the decomposition tree is $\text{ADH}(e) := \beta(p) \cap \beta(q)$. For a rooted tree decomposition (T, β) of G and a vertex $v \in V(G)$, define $\text{TOP}(v)$ to be the node $p \in V(T)$ whose bag $\beta(p)$ contains v and whose distance in T to the root node is minimum. The third property of tree decompositions ensures that this is well defined. For two nodes $p, q \in V(T)$, we use $\text{LCA}(p, q)$ to denote the lowest common ancestor of p and q in T .

For a graph G and two vertex sets X and Y , we use $d_G(X, Y)$ to denote the number of edges on a shortest path from a vertex in X to a vertex in Y . When (T, β) is a tree decomposition of G and $s, t \in V(G)$, this means that $d_T(\beta^{-1}(s), \beta^{-1}(t))$ is the distance between the subtree where s is represented and the subtree where t is represented. A path P in G *connects* vertex sets X and Y if one endpoint of P belongs to X and the other endpoint belongs to Y . It is a *minimal* path connecting X and Y when no interior vertex belongs to X or Y . Observe that for disjoint connected vertex subsets X and Y of a tree T , the minimal path connecting X and Y is unique. This implies that the minimal path connecting $\beta^{-1}(s)$ and $\beta^{-1}(t)$ is unique when s and t do not appear in the same bag of a tree decomposition (T, β) of G . We use $\Pi_T(s, t)$ to refer to a minimal path connecting $\beta^{-1}(s)$ and $\beta^{-1}(t)$ in T . We also use $\Pi_T(s, \text{ROOT})$ to refer to the path from $\text{TOP}(s)$ to the root of T , which is the minimal path connecting $\beta^{-1}(s)$ to the root node.

Observation 2. Let (T, β) be a tree decomposition of graph G . If s, t are distinct vertices of G and Π is a minimal path in T connecting $\beta^{-1}(s)$ to $\beta^{-1}(t)$, then for every edge e on Π all st -paths in G contain a vertex of $\text{ADH}(e)$.

Observation 3. Let (T, β) be a tree decomposition of graph G and let $p \in V(T)$. If $S \subseteq V(G)$ such that $G[S \setminus \beta(p)]$ is connected, then there is a single tree T' in the forest $T - p$ such that all bags containing a vertex of $S \setminus \beta(p)$, are contained in T' .

Clique trees A *clique tree* is a tree decomposition (T, β) such that each bag $\beta(p)$ is a maximal clique in G . It is known that a graph is chordal if and only if it has a clique tree [11, Theorem 1.2.3]. A clique tree of a chordal graph can be found in linear time [11, Theorem 1.2.4]. The definition implies that if (T, β) is a clique tree of G and $S \subseteq V(G)$ is a clique in G , then $S \subseteq \beta(p)$ for some node $p \in V(T)$.

Note that in a chordal graph G with a clique tree (T, β) , two vertices s, t appear in the same bag if and only if they are adjacent. Thus, in a chordal graph G with a clique tree (T, β) , there is a unique minimal path connecting $\beta^{-1}(s)$ and $\beta^{-1}(t)$ for every nonadjacent pair of vertices s, t .

In our proofs we often work with a clique tree (T, β) of a chordal graph G , and we will need to refer to both paths in G and paths in T . To maximize readability, we use the convention that identifiers such as P and P' are used for paths in G , while identifiers such as Π and Π' are used for paths in the decomposition tree T .

Proposition 2. Let (T, β) be a clique tree of a graph G , let $U \subseteq V(G)$, and let s and t be distinct vertices in $V(G) \setminus U$. If there is a path Π in T connecting $\beta^{-1}(s)$ to $\beta^{-1}(t)$ such that $\text{ADH}(e) \setminus U \neq \emptyset$ for each edge e on Π , then there is an induced st -path in $G - U$.

Proof. If $st \in E(G)$ the claim is trivial. Otherwise, the trees $\beta^{-1}(s)$ and $\beta^{-1}(t)$ are vertex-disjoint since each bag of the clique tree forms a clique in G . Consider a path Π as described, consisting of edges e_1, \dots, e_ℓ with $\ell \geq 1$. For each edge e_i with $i \in [\ell]$ pick a vertex $v_i \in \text{ADH}(e_i) \setminus U$ and note that, by definition of adhesion, v_i occurs in the bags of both endpoints of e_i . As v_1 is in a common bag with s and each bag is a clique in G , we know $sv_1 \in E(G)$. Similarly we have $v_\ell t \in E(G)$. Finally, edges e_i and e_{i+1} share an endpoint whose bag contains both v_i and v_{i+1} for $i < \ell$, implying that s, v_1, \dots, v_ℓ, t is an st -walk in G that avoids U . By Observation 1, this yields an induced st -path in G that avoids U . \square

Proposition 3. Let (T, β) be a clique tree of a graph G , let P be an induced st -path in G with $|V(P)| \geq 5$ for $s, t \in V(G)$, and let T^* be the tree in the forest $T - (\beta^{-1}(s) \cup \beta^{-1}(t))$ that contains the internal nodes of $\Pi_T(s, t)$. For any vertex u of P that is not among the first two or last two vertices on P , the subtree $\beta^{-1}(u)$ is contained entirely in T^* .

Proof. Assume the preconditions hold. Since u is not among the first two or last two vertices on the induced st -path P , vertex u is not adjacent to s or t and therefore $\beta^{-1}(u)$ is vertex-disjoint with $\beta^{-1}(s)$ and $\beta^{-1}(t)$. It follows that $\beta^{-1}(u)$ is contained entirely within one tree T' of the forest $T - (\beta^{-1}(s) \cup \beta^{-1}(t))$. Assume for a contradiction that $T' \neq T^*$. Then either $\Pi_T(u, s)$ goes through $\beta^{-1}(t)$, or $\Pi_T(u, t)$ goes through $\beta^{-1}(s)$. Assume without loss of generality (by symmetry) that $\Pi_T(u, s)$ goes through $\beta^{-1}(t)$.

The subpath P' of P from s to u is induced. None of the vertices on P' are adjacent to t , since P is induced and u itself is not adjacent to s or t . Let e be an edge on $\Pi_T(u, s)$ that has an endpoint p in $\beta^{-1}(t)$. By Observation 2, the su -path P' contains a vertex w of $\text{ADH}(e) \subseteq \beta(p)$, with $p \in \beta^{-1}(t)$. This shows that w is in a common bag with t . Since each bag of T forms a clique, vertex w on P' is adjacent to t ; a contradiction. \square

Proposition 4. Let (T, β) be a clique tree of graph G and let P be an induced st -path in G . For every internal vertex u of P , the tree $\beta^{-1}(u)$ contains a node of $\Pi_T(s, t)$.

Proof. Assume for a contradiction that there is an internal vertex u of P for which $\beta^{-1}(u)$ contains no node of $\Pi_T(s, t)$. Orient P from s to t and consider the first vertex u_1 for which this holds. Let u_0 be the predecessor of u_1 on P . Let u_2 be the first vertex after u_1 on P for which $\beta^{-1}(u_2)$ contains a node of $\Pi_T(s, t)$, which is well-defined since t is such a vertex.

Let T' be the tree in $T - V(\Pi_T(s, t))$ containing $\beta^{-1}(u_1)$, which is well-defined since u_1 does not occur in a bag of $\Pi_T(s, t)$ and the occurrences of u_1 form a connected subtree. Let q be the unique node

of $\Pi_T(s, t)$ that has a neighbor in T' . Since u_0 occurs in a common bag with u_1 and also occurs in a bag on $\Pi_T(s, t)$, by the connectivity property of tree decompositions we have $u_0 \in \beta(q)$. Since u_2 is the first vertex after u_1 that occurs in a bag of $\Pi_T(s, t)$, all interior vertices u of the subpath of P from u_0 to u_2 occur only in bags of T' by Observation 3. Since u_2 occurs in a common bag with the predecessor of u_2 on P , it follows that u_2 occurs both in a bag of T' and in a bag of $\Pi_T(s, t)$, and consequently $u_2 \in \beta(q)$. Hence u_0 and u_2 occur in a common clique, implying that u_0 and u_2 are connected in G . But this edge is a chord on P since u_0 and u_2 are not consecutive; a contradiction to the assumption that P is induced. \square

3 Informal description of the kernelization

In this section we give the high-level ideas behind the kernelization algorithm. Given an instance (G, k) of CHVD, we run the approximation algorithm of Theorem 2. If it concludes that (G, k) is a no-instance, then we output a constant-size no-instance as the result of the kernelization. Otherwise, we obtain an approximate solution $M_0 \subseteq V(G)$ of size $\text{poly}(k)$ such that $G - M_0$ is chordal. The reduction process proceeds in three phases.

1. We find a vertex set $Q \supseteq M_0$ of size $\text{poly}(k, |M_0|)$ such that all the connected components A of $G - Q$ (which are chordal graphs since Q contains M_0) are simple in the following way: all vertices in A have the same neighborhood in M_0 , and the neighborhood of A in the rest of the graph (i.e., $Q \setminus M_0$) consists of two cliques of size $\text{poly}(k, |M_0|)$.
2. We introduce a reduction rule that bounds the number of connected components of $G - Q$ in terms of $|Q|$.
3. We introduce a reduction rule that shrinks the size of each component A of $G - Q$ to polynomial in the size of the two boundary cliques.

This process reduces the size of the graph to polynomial in k , when starting with a modulator M_0 of size $\text{poly}(k)$.

Reduction phase 1. To be able to find the desired separator Q , several intermediate steps are needed. The flow of ideas is as follows. We prove Lemma 1: if G is a graph containing a distinguished vertex v such that $G - v$ is chordal, then either there are $k + 1$ holes in G that are vertex-disjoint except for intersecting at v , or there is a set $S_v \subseteq G$ of $12k$ vertices such that $G - S_v$ is chordal. The proof is algorithmic and yields a polynomial-time algorithm that computes the set of $k + 1$ holes or the set S_v , depending on the outcome. Given the input graph G and the modulator M_0 , we apply this algorithm to the graph $G_v := G - (M_0 \setminus \{v\})$ for each $v \in M$; note that $G_v - v$ is chordal. When G_v contains $k + 1$ holes that intersect only in v , we know that any size- k solution to the original instance must contain v . Hence we can delete such vertices and decrease the budget k by one. After exhaustively applying this rule, we can collect the hitting sets S_v for the remaining vertices and add them to M_0 , obtaining a larger modulator M . It yields the following useful structure: for every $v \in M$, the graph $G - (M \setminus \{v\})$ is chordal. This property is exactly the *tidyness of the modulator* as defined by Bevern et al [52].

For a vertex $v \in M$, we define $G(\neg v) = G - (M \cup N(v))$, that is, the subgraph of $G - M$ induced by the nonneighbors of v . By the previous Erdős-Pósa type step, a boundary of a component of $G(\neg v)$, i.e., the set $N_{G-M}(C)$ for a connected component C of $G(\neg v)$, is a clique. To achieve the desired set Q , we first reduce the graph in two ways.

- We shrink large cliques of $G - M$, bounding the size of a clique in $G - M$ polynomially in k and $|M|$ (Section 7).
- We reduce the number of connected components of $G(\neg v)$ for every $v \in M$ (Section 8).

We start with Q being all boundaries of connected components of $G(\neg v)$ for all $v \in M$. To ensure that the boundary of A consists of two cliques, we use lowest-common-ancestor (LCA) closure of marked bags in a clique tree, similarly as in the case of the protrusion technique [9]. This yields a separator Q with the desired properties.

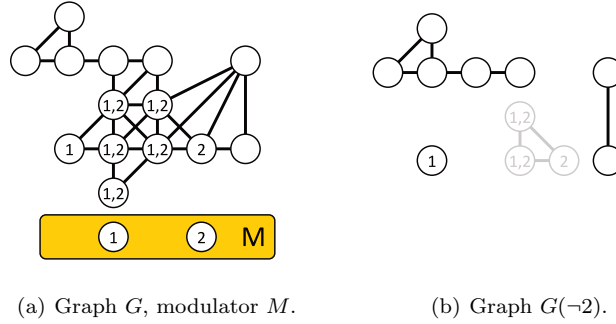

Figure 1: 1(a) A graph G with modulator M such that $G - (M \setminus \{v\})$ is chordal for each $v \in M$. To prevent clutter, the neighborhoods of the vertices $\{1, 2\} \in M$ are represented by drawing a 1 (resp. 2) in each circle representing a neighbor of 1 (resp. 2). 1(b) The graph $G(-2)$ is drawn in black. The three gray vertices form a clique, which is the neighborhood of the rightmost connected component of $G(-2)$.

Reduction phase 2. The second phase is easy and presented in Section 6. Since all holes pass through $M \subseteq Q$, a component A of $G - Q$ can only be used on a hole to connect two vertices in Q by an induced path; it turns out that two different types of connections are relevant. For each of the $|Q|^2$ pairs of vertices x, y of Q , we mark $k + 2$ components of each type that provide a connection between x and y (or fewer, if the connection type is realized by fewer than $k + 2$ components). Afterwards, any component that is not marked can be safely discarded from the problem.

Reduction phase 3. The third reduction phase is technical, and described in Section 9. Since a component A of $G - Q$ is chordal, has two cliques as its boundary, and all its vertices have the same neighborhood in M , the only way A can be used to make a hole in the graph is to provide an induced path between its two boundary cliques. To break the holes in the graph, it might therefore be beneficial to have a separator between the two boundary cliques in a solution. By analyzing the local structure, and exploiting the fact that an earlier reduction rule has reduced the sizes of all cliques in $G - M$ to $\text{poly}(k, |M|)$, we can pinpoint a small number of relevant cliques in A such that there is always an optimal solution that does not delete vertices of A that fall outside the relevant cliques. Afterwards we can shrink A by a “bypassing” operation on all the vertices that are not needed in an optimal solution.

4 Erdős-Pósa for almost chordal graphs

The main goal of this section is to prove Lemma 1. However, we first present some additional terminology and a subroutine that will be useful during the proof.

We use $V(\mathcal{C})$ to denote the union of the vertices used on the holes in a flower \mathcal{C} . Observe that for any v -flower $\mathcal{C} = \{C_1, \dots, C_k\}$ of order k , the structure $\mathcal{C} - v$ consists of k pairwise vertex-disjoint chordless paths P_1, \dots, P_k that connect two nonadjacent neighbors of v , whose internal vertices belong to $V(G) \setminus N_G[v]$. Throughout our proofs we will switch between the interpretation of a v -flower as a set of intersecting holes in G , and as a collection of induced paths in $G - v$ between nonadjacent neighbors of v .

Proposition 5. *There is a polynomial-time algorithm that, given a graph G and a vertex v such that $G - v$ is chordal, computes a v -flower of order two or correctly determines that no such flower exists.*

Proof. Observe that $\mathcal{C} = \{C_1, C_2\}$ is a v -flower of order two if and only if $P_1 := C_1 - v$ and $P_2 := C_2 - v$ are pairwise vertex-disjoint induced paths whose endpoints are nonadjacent neighbors of v , and whose internal vertices avoid $N_G[v]$. To search for a flower of order two, we try all $\mathcal{O}(n^4)$ tuples $(s_1, t_1, s_2, t_2) \in (N_G(v))^4$ for the endpoints of the paths P_1 and P_2 in the set $N_G(v)$. For all tuples consisting of distinct vertices for which $s_1 t_1 \notin E(G)$ and $s_2 t_2 \notin E(G)$, we formulate an instance of the DISJOINT PATHS problem in $G - (N_G[v] \setminus \{s_1, t_1, s_2, t_2\})$ in which we want to connect s_i to t_i for $i \in \{1, 2\}$ by pairwise vertex-disjoint paths. Any FPT-algorithm for the general k -DISJOINT PATHS problem suffices for this

purpose as the parameter is constant. We may also use the linear-time algorithm for k -DISJOINT PATHS IN CHORDAL GRAPHS due to Kammer and Tholey [38] since $G - v$ is chordal. If there are vertex-disjoint $s_i t_i$ -paths P_1 and P_2 , then we can shortcut them to *induced* paths, which gives a flower of order two. Conversely, if there is a flower of order two, then we will find such paths in the iteration where we guess the tuple containing their endpoints. Hence if the algorithm loops through all tuples without finding a solution to the DISJOINT PATHS problem, we may conclude that there is no flower of order two and terminate. \square

We are now ready to prove Lemma 1, which we re-state for completeness.

Lemma. *There is a polynomial-time algorithm that, given a graph G and a vertex v such that $G - v$ is chordal, outputs a v -flower C_1, \dots, C_k and a set $S \subseteq V(G) \setminus \{v\}$ of size at most $12k$ such that $G - S$ is chordal.*

Proof. We first present an algorithm to compute a v -flower \mathcal{C} . Then we show how to compute a hitting set based on the structure of the flower, and argue that the constructed set is not too large. To initialize the procedure, we compute a clique tree (T, β) of $G - v$ and root it at an arbitrary node.

Computing a flower. The algorithm to compute the flower is a local search procedure that maintains a v -flower \mathcal{C} , initially empty, and iteratively improves this structure according to three rules that are described below.

- (I) If $G - (V(\mathcal{C}) \setminus \{v\})$ contains a hole C , then add C to \mathcal{C} . Equivalently, if there are two distinct nonadjacent vertices $x, y \in N_G(v) \setminus V(\mathcal{C})$ such that graph $G - (V(\mathcal{C}) \cup N_G[v] \setminus \{x, y\})$ contains an induced xy -path P , then add the hole $\{v\} \cup V(P)$ to \mathcal{C} .
- (II) If the current flower \mathcal{C} contains a hole C_i such that the graph $G - (V(\mathcal{C}) \setminus V(C_i))$ contains a v -flower $\mathcal{C}' = \{C'_i, C''_i\}$ of order two, then remove the hole C_i from flower \mathcal{C} and add the holes C'_i and C''_i instead.
- (III) If the current flower \mathcal{C} contains a hole C_i such that the path $P_i := C_i - v$ has endpoints s and t , and there exists a $t' \in N_G(v) \setminus (V(\mathcal{C}) \cup N_G(s))$ such that:
 - $d_T(\beta^{-1}(s), \beta^{-1}(t)) > d_T(\beta^{-1}(s), \beta^{-1}(t'))$, and
 - the graph $(G - (N_G[v] \setminus \{s, t'\})) - (V(\mathcal{C}) \setminus V(P_i))$ contains an induced st' -path P' , i.e., there is an induced st' path P' in G whose interior vertices avoid the closed neighborhood of v and avoid all vertices used on other holes of the flower,

then replace C_i in the flower by the hole consisting of $\{v\} \cup V(P')$.

Figure 2 illustrates these concepts. The applicability of each of the three improvement steps can be tested in polynomial time. For (I) and (III) this follows from the fact that induced paths can be found using breadth-first search; for (II) this follows from Proposition 5. The number of improvement steps of type (I) and (II) is bounded by the maximum order of the flower, which is at most $|V(G)|$. Step (III) replaces a path in $\mathcal{C} - v$ by one whose endpoints are closer together in T . As there are only $|V(G)|^2$ pairs of possible endpoints, a path cannot be replaced more than $|V(G)|^2$ times by a better path. Since the flower contains at most $|V(G)|$ paths at any time, there can be no more than $|V(G)|^3$ successive applications of Step (III) before the algorithm either terminates, or applies a step that increases the order of the flower. The algorithm therefore terminates after a polynomial number of steps. It is easy to verify that the stated conditions ensure that the structure \mathcal{C} is a v -flower at all times. Hence we can compute a v -flower \mathcal{C} that is maximal with respect to the three improvement rules in polynomial time.

Computing a hitting set. Based on a maximal flower $\mathcal{C} = \{C_1, \dots, C_k\}$ and the associated set of paths P_1, \dots, P_k in $G - v$, we compute a set $S \subseteq V(G) \setminus \{v\}$ that hits all holes. To every vertex of $G - v$ we associate an edge of the decomposition tree T . For $u \in V(G) \setminus \{v\}$, define the *cutpoint above u* , denoted $\pi(u)$, as follows. Let $\pi(u)$ be the first edge $e \in E(T)$ on the path from $\text{TOP}(u)$ to the root for which $\text{ADH}(e) \subseteq N_G(v) \cup V(\mathcal{C})$, or NIL if no such edge exists. The hitting set S is constructed as follows.

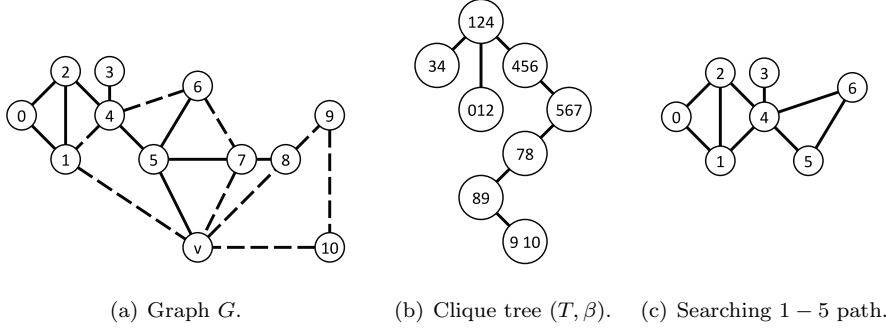

Figure 2: 2(a) A graph G such that $G - v$ is chordal. A v -flower of order two is highlighted by dotted edges. 2(b) A clique tree of $G - v$, visualized by drawing the contents bags inside the nodes. With respect to this clique tree, the v -flower can be improved by Step (III) by choosing $P_i := (s = 1, 4, 6, 7 = t)$ and $t' := 5$. Note that $d_T(\beta^{-1}(s), \beta^{-1}(t)) = 2$, while $d_T(\beta^{-1}(s), \beta^{-1}(t')) = 1$. 2(c) The graph $(G - (N_G[v] \setminus \{s, t'\})) - (V(\mathcal{C}) \setminus V(P_i))$ contains an induced st' -path $P' := (1, 4, 5)$.

- (a) For each path P_i with $i \in [k]$, add the endpoints of P_i to S .
- (b) For each vertex $u \in N_G(v) \setminus V(\mathcal{C})$ with $\pi(u) \neq \text{NIL}$, add $\text{ADH}(\pi(u)) \setminus N_G(v)$ to S .

It is easy to carry out this construction in polynomial time.

Claim 1. *The set S is a subset of $V(\mathcal{C}) \setminus \{v\}$.*

Proof. The endpoints of the paths P_i that are added to S in the first step clearly belong to the flower. The vertices added to S in the second step belong to $\text{ADH}(\pi(u)) \setminus N_G(v)$. By definition of cutpoint we have $\text{ADH}(\pi(u)) \subseteq N_G(v) \cup V(\mathcal{C})$, hence $\text{ADH}(\pi(u)) \setminus N_G(v) \subseteq V(\mathcal{C})$. As (T, β) is a clique tree of $G - v$, vertex v does not occur in any set $\text{ADH}(\pi(u))$ and is not added to S . \square

Claim 2. *If \mathcal{C} is a maximal v -flower, then for any distinct $s, t \in N_G(v) \setminus V(\mathcal{C})$ with $st \notin E(G)$, the path $\Pi_T(s, t)$ contains $\pi(s)$ or $\pi(t)$.*

Proof. Let $s, t \in N_G(v) \setminus V(\mathcal{C})$ be nonadjacent in G . Assume for a contradiction that $\text{ADH}(e) \setminus (N_G(v) \cup V(\mathcal{C})) \neq \emptyset$ for all e on $\Pi_T(s, t)$. Let $U := (N_G(v) \cup V(\mathcal{C})) \setminus \{s, t\}$, so $\text{ADH}(e) \setminus U \neq \emptyset$ for all edges e on $\Pi_T(s, t)$. By applying Proposition 2 to the chordal graph $G - v$ we find an induced st -path in $(G - v) - U$. Such a path forms a hole together with v , since $st \notin E(G)$. So Step (I) can be applied to increase the order of the v -flower, contradicting the maximality of \mathcal{C} .

Hence there is an edge e^* on $\Pi_T(s, t)$ for which $\text{ADH}(e^*) \subseteq N_G(v) \cup V(\mathcal{C})$. Observe that the trees $\beta^{-1}(s)$ and $\beta^{-1}(t)$ are vertex-disjoint as each bag forms a clique in G and $st \notin E(G)$. We conclude with a case distinction; see Figure 3 for an illustration.

1. If $\beta^{-1}(s)$ is contained in $T_{\text{TOP}(t)}$, then some vertex of $\beta^{-1}(t)$ is an ancestor to all vertices of $\beta^{-1}(s)$. Hence $\Pi_T(s, t)$ is the path from $\text{TOP}(s)$ to its first ancestor in $\beta^{-1}(t)$, so $\Pi_T(s, t) \subseteq \Pi_T(s, \text{ROOT})$. As e^* shows that at least one edge on $\Pi_T(s, \text{ROOT})$ satisfies the defining condition for a cutpoint, $\pi(s)$ is well-defined. As $\pi(s)$ is not higher than e^* , which lies on $\Pi_T(s, t)$, the edge $\pi(s)$ lies on $\Pi_T(s, t)$.
2. If $\beta^{-1}(t)$ is contained in $T_{\text{TOP}(s)}$, then reversing the roles of s and t in the previous argument shows that $\pi(t)$ lies on $\Pi_T(s, t)$.
3. If neither case holds, then $\beta^{-1}(s)$ and $\beta^{-1}(t)$ are contained in different child subtrees of $p := \text{LCA}(\text{TOP}(s), \text{TOP}(t))$, implying that $\Pi_T(s, t)$ is the concatenation of a path Π_s from $\text{TOP}(s)$ to its ancestor p , and a path Π_t from $\text{TOP}(t)$ to its ancestor p . Since e^* lies on $\Pi_T(s, t)$, it lies on Π_s or Π_t . Suppose that e^* lies on Π_s . Then $\pi(s)$ is well-defined, lies above $\text{TOP}(s)$ and no higher than e^* , and therefore lies on $\Pi_T(s, t)$. The case when e^* lies on Π_t is symmetric. \square

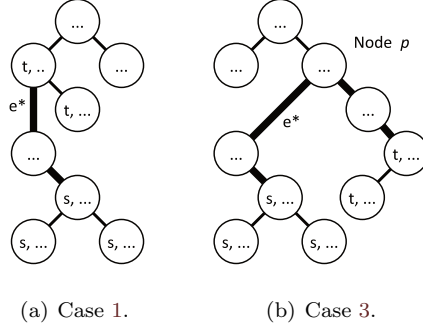

Figure 3: Illustration of the proof of Claim 2. The figure shows a tree decomposition (T, β) of $G - v$. The minimal path $\Pi_T(s, t)$ in T is drawn with thick edges. 3(a) All bags containing s are contained in the subtree of T rooted at the highest bag containing t . 3(b) If the first two cases do not hold, then the bags containing s are contained in a different subtree of the lowest common ancestor p than the bags containing t .

Claim 3. *The graph $G - S$ is chordal.*

Proof. Assume for a contradiction that $G - S$ contains a hole C^* . Since $G - v$ is chordal, C^* passes through v so that $C^* - v$ is an induced st -path in $G - S - v$ for nonadjacent $s, t \in N_G(v)$. By Step (a) we know that s and t are not endpoints of paths in $\mathcal{C} - v$, with respect to the computed maximal flower \mathcal{C} . Since paths in $\mathcal{C} - v$ cannot contain members of $N_G(v)$ as interior vertices either, we find $s, t \notin V(\mathcal{C})$.

Since s and t are nonadjacent vertices of $N_G(v) \setminus V(\mathcal{C})$, by Claim 2 we know $\Pi_T(s, t)$ contains $\pi(s)$ or $\pi(t)$. Let $e^* \in \{\pi(s), \pi(t)\}$ be a well-defined edge on $\Pi_T(s, t)$. As $s, t \in N_G(v) \setminus V(\mathcal{C})$, by Step (b) of the construction of S we know that $\text{ADH}(e^*) \setminus S \subseteq N_G(v)$. As only one bag of $\Pi_T(s, t)$ contains s by minimality of $\Pi_T(s, t)$, and only one bag of $\Pi_T(s, t)$ contains t , it follows that $s, t \notin \text{ADH}(e^*)$. On the other hand, since $\Pi_T(s, t)$ connects $\beta^{-1}(s)$ to $\beta^{-1}(t)$ in T and e^* lies on $\Pi_T(s, t)$, by Observation 2 we know that the st -path $P_v := C^* - v$ in $G - S - v$ contains a vertex $u \in \text{ADH}(e^*) \setminus S \subseteq N_G(v) \setminus \{s, t\}$. This shows that P_v contains a vertex from $N_G(v)$ in its interior, and hence has a chord; a contradiction to the assumption that C^* is a hole. \square

The claims so far established that we can compute a maximal v -flower \mathcal{C} and a corresponding chordal deletion set S that avoids v , in polynomial time. To complete the proof, it remains to show that the size of S is bounded by twelve times the order of the computed flower. This is the most technical part. It follows from the next claim.

Claim 4. *If C_i is a hole of the maximal flower \mathcal{C} and $P_i := C_i - v$, then S contains at most 12 vertices from P_i .*

Proof. Assume for a contradiction that C_i is a hole in \mathcal{C} such that S contains at least 13 vertices from the path $P_i := C_i - v$. Let $s, t \in N_G(v)$ be the endpoints of P_i . We identify two special vertices in $S \cap V(P_i)$ that allow us to derive a contradiction. Define $p := \text{LCA}(\text{TOP}(s), \text{TOP}(t))$ and note that p may coincide with $\text{TOP}(s)$ or $\text{TOP}(t)$. Since $\beta(p)$ is a clique in $G - v$ and P_i is an induced path, we know $|\beta(p) \cap V(P_i)| \leq 2$. Similarly, P_i contains at most two vertices of each of the sets $\text{ADH}(\pi(s))$ and $\text{ADH}(\pi(t))$.

Let X be the set containing the first two and last two vertices on P_i , together with $\beta(p) \cap V(P_i)$, $\text{ADH}(\pi(s)) \cap V(P_i)$, and $\text{ADH}(\pi(t)) \cap V(P_i)$. Since $|X| \leq 10$ and $|S \cap V(P_i)| \geq 13$, there are at least three vertices in $(S \cap V(P_i)) \setminus X$. Since they lie on the induced path P_i , these three vertices do not form a clique implying that there are two distinct vertices in $(S \cap V(P_i)) \setminus X$ that are not adjacent in G . Call these x and y and choose their labels such that when traversing the path P_i from s to t , we visit x before visiting y . We will use the pair $\{x, y\}$ to derive a contradiction to the maximality of \mathcal{C} with respect to the three presented improvement steps.

Since x and y are internal vertices of P_i and all paths in $\mathcal{C} - v$ are vertex-disjoint, x and y are not endpoints of any path in $\mathcal{C} - v$ and therefore Step (a) of the hitting set construction is not responsible for adding them to S . Consequently, x and y are in S because there are vertices $x', y' \in N_G(v) \setminus V(\mathcal{C})$

with well-defined cutpoints $\pi(x'), \pi(y')$ such that $x \in \text{ADH}(\pi(x')) \setminus N_G(v)$ and $y \in \text{ADH}(\pi(y')) \setminus N_G(v)$ that caused x and y to be added to S in Step (b); we will argue later that x' and y' are distinct.

Since no internal vertex of $\Pi_T(s, t)$ lies in $\beta^{-1}(s)$ or $\beta^{-1}(t)$, there is a unique tree T^* in the forest $T - (\beta^{-1}(s) \cup \beta^{-1}(t))$ that contains the internal nodes on $\Pi_T(s, t)$. To derive a contradiction we will argue for the following properties; note that (vii) contradicts the maximality of \mathcal{C} with respect to Step (II).

- (i) $\pi(x')$ and $\pi(y')$ are distinct edges, hence $x' \neq y'$.
- (ii) $\pi(x')$ and $\pi(y')$ both belong to T^* .
- (iii) The edges $\pi(x')$ and $\pi(y')$ are distinct from $\pi(s)$ and $\pi(t)$.
- (iv) Neither one of $\{x', y'\}$ is simultaneously adjacent to both s and t .
- (v) Neither one of $\{x', y'\}$ is adjacent to s or t .
- (vi) There are paths from x' to x and from y' to y that are pairwise vertex-disjoint and whose interior avoids $V(\mathcal{C}) \cup N_G(v)$.
- (vii) The graph $G - (V(\mathcal{C}) \setminus V(C_i))$ contains a v -flower of order two.

(i) If $\pi(x') = \pi(y')$, then $x, y \in \text{ADH}(\pi(x')) = \text{ADH}(\pi(y'))$ are adjacent in $G - v$ because they occur in a common bag of a clique tree. This contradicts our choice of x and y as nonadjacent vertices. Since $\pi(x') \neq \pi(y')$ we must have $x' \neq y'$.

(ii) Since $\pi(x')$ is an edge of T whose adhesion contains x , it follows that $\pi(x')$ is an edge of the subtree $\beta^{-1}(x)$. Similarly, $\pi(y')$ is an edge of $\beta^{-1}(y)$. It therefore suffices to prove that the subtrees $\beta^{-1}(x)$ and $\beta^{-1}(y)$ are entirely contained in T^* . This follows from Proposition 3, since both x and y are vertices on the induced st -path P_i in the chordal graph $G - v$ that are not among the first two or last two vertices.

(iii) Suppose that $\pi(x')$ equals $\pi(s)$ or $\pi(t)$. Then $x \in \text{ADH}(\pi(x'))$ is a vertex on P_i that is in $\text{ADH}(\pi(s)) \cup \text{ADH}(\pi(t))$. But this contradicts our choice of x to be a vertex of $(S \cap V(P_i)) \setminus X$ above, since X contains $\text{ADH}(\pi(s)) \cap V(P_i)$ and $\text{ADH}(\pi(t)) \cap V(P_i)$. The argument when $\pi(y')$ equals $\pi(s)$ or $\pi(t)$ is symmetric.

(iv) Assume for a contradiction that x' is adjacent to both s and t . We make a case distinction on the structure of $\beta^{-1}(s)$ and $\beta^{-1}(t)$ in the clique tree T .

1. If $\beta^{-1}(s)$ is contained in $T_{\text{TOP}(t)}$, then let p be the lowest node of $\beta^{-1}(t)$ for which $\beta^{-1}(s) \subseteq T_p$. Then tree T^* as defined above is contained in T_p . As we assumed x' is adjacent to both s and t , vertices x' and t occur in a common bag, showing that $\text{TOP}(x')$ is a proper ancestor to all nodes of T^* . Since $\pi(x')$ is an edge on $\Pi_T(x', \text{ROOT})$, the edge $\pi(x')$ lies above $\text{TOP}(x')$ while all of T^* lies below $\text{TOP}(x')$. This implies that $\pi(x')$ does not belong to T^* , contradicting (ii).
2. If $\beta^{-1}(t)$ is contained in $T_{\text{TOP}(s)}$, then reversing the roles of s and t in the previous argument yields a contradiction.
3. If neither case holds, then $\beta^{-1}(s)$ and $\beta^{-1}(t)$ are contained in different child subtrees of $p := \text{LCA}(\text{TOP}(s), \text{TOP}(t))$. It follows that $\Pi_T(s, t)$ is the concatenation of a path from $\text{TOP}(s)$ to p with a path from $\text{TOP}(t)$ to p . Since x' is adjacent to both s and t , we know that $\beta^{-1}(x')$ intersects both $\beta^{-1}(s)$ and $\beta^{-1}(t)$, and therefore contains p . It follows that $\text{TOP}(x')$ is an ancestor of p , and therefore that the edge $\pi(x')$ connects two ancestors of p . By Proposition 4 we know that x , which is a vertex on the induced st -path P_i , occurs in a bag on $\Pi_T(s, t)$. Since $x \in \text{ADH}(\pi(x'))$ and $\pi(x')$ is an edge connecting two ancestors of p , while all paths from ancestors of p to nodes in $\Pi_T(s, t)$ go through p , we have $x \in V(P_i) \cap \beta(p)$. This contradicts the choice of x , as we chose it from a set that excludes $V(P_i) \cap \beta(p)$.

The argument when y' is adjacent to both s and t is symmetric.

(v) Assume for a contradiction that $z' \in \{x', y'\}$ is adjacent to $r \in \{s, t\}$; by (iv) we then already know that z' is not adjacent to $\hat{r} := \{s, t\} \setminus \{r\}$. We distinguish two cases, depending on the relative position of $\beta^{-1}(r)$ and $\beta^{-1}(\hat{r})$.

1. If $\beta^{-1}(\hat{r}) \subseteq T_{\text{TOP}(r)}$, then let p be the lowest node of $\beta^{-1}(r)$ for which $\beta^{-1}(\hat{r}) \subseteq T_p$. It follows that $T^* \subseteq T_p$. Now observe that since z' is adjacent to r in G , the trees $\beta^{-1}(z')$ and $\beta^{-1}(r)$ share at least one node, and hence $\text{TOP}(z')$ is not a proper descendant of p . Since $\pi(z')$ is an edge on $\Pi_T(z', \text{ROOT})$, it follows that $\pi(z')$ does not lie in T^* . But this contradicts (ii).
2. If the previous case does not hold, then $\Pi_T(r, \hat{r})$ does not enter $\beta^{-1}(r)$ “from below”, which implies that $\Pi_T(r, \hat{r})$ contains the edge from $\text{TOP}(r)$ to its parent. We now distinguish two cases.
 - (a) If $\text{TOP}(z')$ is a proper ancestor of $\text{TOP}(r)$, then since z' occurs in a common bag with r we must have that z' is contained in the bag of the parent of $\text{TOP}(r)$. We claim that, in this situation, Step (III) is applicable to improve the structure of the flower, contradicting the maximality of \mathcal{C} with respect to the given rules. To see this, observe that the presence of z' in the parent bag of r , together with the fact that $\Pi_T(r, \hat{r})$ uses the edge from $\text{TOP}(r)$ to its parent, implies that $d_T(\beta^{-1}(z'), \beta^{-1}(\hat{r}))$ is strictly smaller than $d_T(\beta^{-1}(r), \beta^{-1}(\hat{r}))$; the latter quantity is exactly the number of edges on $\Pi_T(r, \hat{r})$. By Observation 2, the st -path P_i contains a vertex u of $\text{ADH}(e)$, where e is the edge from $\text{TOP}(r)$ to its parent in T . Consequently, u is not r itself since r does not appear in the parent bag of $\text{TOP}(r)$. Since both u and z' appear in that parent bag, we know that z' is adjacent to u and therefore that z' together with the subpath of P_i from u to \hat{r} is a $z'\hat{r}$ -path in G . Hence, there is an induced $z'\hat{r}$ -path in G on a vertex subset of $V(P_i) \cup \{z'\}$. As $z' \in \{x', y'\} \subseteq N_G(v) \setminus V(\mathcal{C})$ and z is not adjacent to \hat{r} , which is one of the endpoints of P_i , this shows that Step (III) can be applied to improve the structure of the flower \mathcal{C} ; a contradiction.
 - (b) If $\text{TOP}(z')$ is not a proper ancestor of $\text{TOP}(r)$, then since z' and r occur in a common bag we know that $\text{TOP}(z') \in T_{\text{TOP}(r)}$. Since the cutpoint $\pi(z')$ above z' lies on $\Pi_T(z', \text{ROOT})$ by definition, and is contained in T^* (by (ii)) which lies “above” $\text{TOP}(r)$ by the precondition to this case, it follows that $\pi(z')$ is an edge between two ancestors of $\text{TOP}(r)$. As the adjacent vertices z' and r occur in a common bag and $\text{TOP}(z')$ is not higher than $\text{TOP}(r)$, path $\Pi_T(z', \text{ROOT})$ goes through $\text{TOP}(r)$ and all bags on the path from $\text{TOP}(z')$ to $\text{TOP}(r)$ contain r . Since no bag in T^* contains r and $\pi(z') \in T^*$ it follows that $\pi(z')$ is an edge connecting two ancestors of r , and must therefore be the first edge e on the path from $\text{TOP}(r)$ to the root for which $\text{ADH}(e) \subseteq N_G(v) \cup V(\mathcal{C})$. But then $\pi(z') = \pi(r)$, which contradicts (iii).

(vi) We first construct the paths and then prove that they have interiors that avoid $V(\mathcal{C}) \cup N_G(v)$ and are pairwise vertex-disjoint. Let $z' \in \{x', y'\}$ and let z be the corresponding vertex in $\{x, y\}$. Let Π' be the path in T from $\text{TOP}(z')$ to the lower endpoint of $\pi(z')$. Since $z \in \text{ADH}(\pi(z'))$ by definition of x, y, x', y' , we know that z appears in the bag of the bottom endpoint of $\pi(z')$ and so Π' connects $\beta^{-1}(z)$ to $\beta^{-1}(z')$ in T . Since none of the edges of Π' satisfied the condition for being the cutpoint above z' , for each edge e on Π' the set $\text{ADH}(e) \setminus (N_G(v) \cup V(\mathcal{C}))$ is not empty. Define $U := (N_G(v) \cup V(\mathcal{C})) \setminus \{z, z'\}$. Applying Proposition 2 to the chordal graph $G - v$ where z' plays the role of s and z plays the role of t , we establish that there is an induced zz' -path in the graph $(G - v) - U$. The interior vertices on this path avoid $U \cup \{z, z'\}$ (since the latter are endpoints), and therefore the interior avoids $N_G(v) \cup V(\mathcal{C})$ as demanded by (vi). As this holds for both choices of z , we obtain an induced xx' -path $P_{x'}$ and an induced yy' -path $P_{y'}$. It remains to prove that $P_{x'}$ and $P_{y'}$ are pairwise vertex-disjoint. By (i) we know that $x' \neq y'$. As we chose x and y to be distinct vertices, and $x, y \in V(\mathcal{C})$ while $x', y' \in N(v) \setminus V(\mathcal{C})$, it is clear that the endpoints of $P_{x'}$ and $P_{y'}$ are four distinct vertices. It remains to prove that the interior of $P_{x'}$ is vertex-disjoint from the interior of $P_{y'}$. If one of the two paths has no interior, then this is trivial. So assume for a contradiction that both paths have an interior, which includes a vertex common to both paths. Orient both paths from the prime to the non-prime endpoint.

Choose $z' \in \{x', y'\}$ and $\hat{z}' \in \{x', y'\} \setminus \{z'\}$ such that the bottom endpoint p of $\pi(z')$ satisfies $\pi(\hat{z}') \notin T_p$. This is always possible; see Figure 4 for an illustration. Let $z \in \{x, y\}$ depending on whether $z' = x'$ or $z' = y'$; let $\hat{z} \in \{x, y\} \setminus \{z\}$. Since the two interiors of $P_{z'}$ and $P_{\hat{z}'}$ intersect, there is a path Q in $G - v$ from the successor $\text{SUCC}(z')$ of z' on $P_{z'}$, to the predecessor $\text{PRED}(\hat{z})$ of \hat{z} on $P_{\hat{z}'}$, such that all vertices on Q belong to the interior of $P_{x'}$ or $P_{y'}$. So $V(Q)$ avoids $N_G(v) \cup V(\mathcal{C})$. Vertex $\text{SUCC}(z')$ occurs in a bag of T_p , since it is adjacent to z' and $\text{TOP}(z')$ is a descendant of both endpoints of $\pi(z')$. To reach a contradiction we show that $\text{PRED}(\hat{z})$ does not occur in a bag in T_p . To that end, we first show that \hat{z} does not occur in a bag of T_p . This follows from the fact that \hat{z} occurs in the adhesion of $\pi(\hat{z}')$, that $\pi(\hat{z}')$

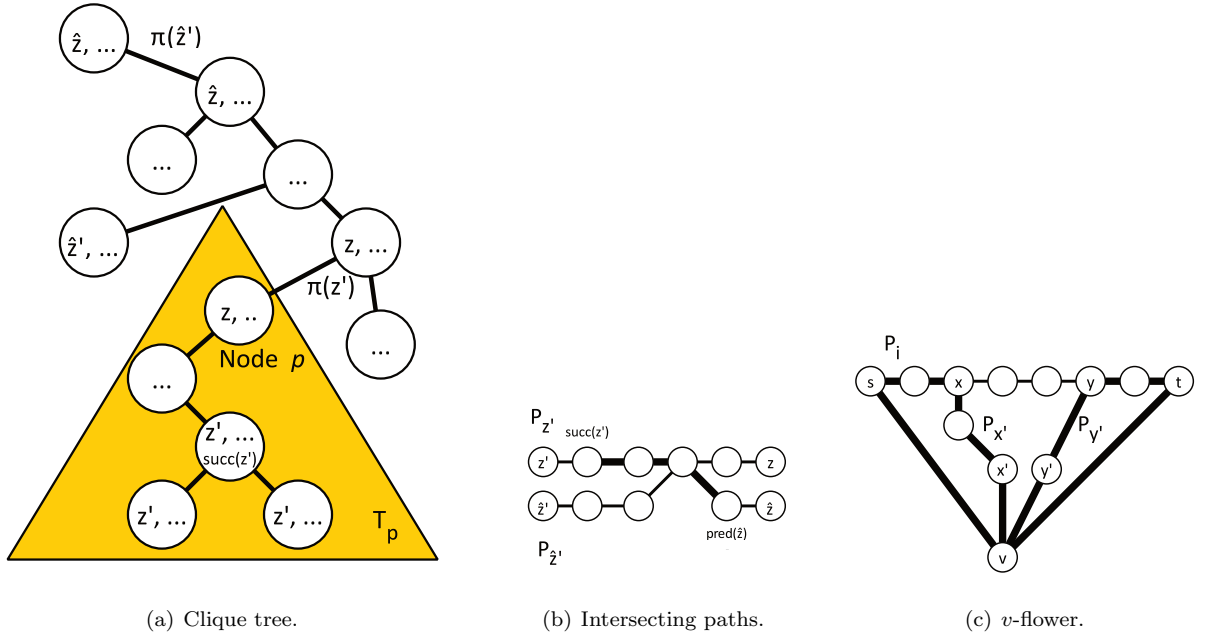

Figure 4: 4(a) Illustration for part (vi) of the proof of Claim 4. Example of how the different entities can be arranged in the clique tree (T, β) of $G - v$. 4(b) The structure of a hypothetical intersection in the interiors of the paths $P_{z'}$ and $P_{\hat{z}'}$. Path Q is shown by thick edges. 4(c) Illustration for part (vii) of Claim 4. Drawing of how the constructed paths $P_{x'}$ and $P_{y'}$ are combined with the original petal $P_i := C_i - v$ of the flower, to obtain a flower of order two (visualized by thick edges).

is not contained in T_p , and that if \hat{z} also occurred in a bag of T_p then this would force \hat{z} to be in $\beta(p)$ which contains $z \in \text{ADH}(\pi(z'))$; but this would imply that z and \hat{z} are adjacent, contradicting our choice of x and y in the beginning of the proof. So \hat{z} does not occur in T_p , implying that $\text{PRED}(\hat{z})$ occurs in some bag outside T_p . Consider a path Π in T from a bag in T_p containing $\text{SUCC}(z')$, to a bag outside T_p containing $\text{PRED}(\hat{z})$; we established that Π contains the edge from the root of T_p to its parent, which is $\pi(z')$. By Observation 2, the path Q connecting $\text{SUCC}(z')$ to $\text{PRED}(\hat{z})$ contains a vertex of $\text{ADH}(\pi(z'))$. By definition of cutpoint, we have that $\text{ADH}(\pi(z')) \subseteq N_G(v) \cup V(\mathcal{C})$. But Q avoids $N_G(v) \cup V(\mathcal{C})$; a contradiction. It follows that $P_{x'}$ and $P_{y'}$ are indeed vertex-disjoint, proving (vi).

(vii) Consider the xx' -path $P_{x'}$ and the yy' -path $P_{y'}$, whose existence we proved in (vi). The interiors of these paths avoid $V(\mathcal{C}) \cup N_G(v)$, the endpoints x' and y' belong to $N_G(v)$, and the endpoints x and y belong to $V(\mathcal{C}) \setminus N_G(v)$. Consider the walk in $G - v$ that starts at s , traverses the st -path $P_i = C_i - v$ until x , and then traverses $P_{x'}$ to x' . Since s is not adjacent to x' by (v) and $x' \in N_G(v)$, this walk contains an induced sx' -path between two neighbors of v , whose internal nodes avoid $N_G(v)$. Moreover, the only vertices of \mathcal{C} used on this path belong to P_i . Similarly, there is an induced ty' -path within the walk starting at t , traversing P_i from t to y , and then traversing $P_{y'}$ from y to y' . Since we chose x and y such that x occurs before y , the pieces of P_i used by these two induced paths are vertex-disjoint. By (vi), the pieces of $P_{x'}$ and $P_{y'}$ used are also vertex-disjoint. Hence these two induced paths are vertex-disjoint and each connect two nonadjacent neighbors of v . Together with v these form a v -flower of order two in G . Since the only vertices of \mathcal{C} used on this order-2 flower are those of P_i and v , it follows that there is a v -flower of order two in $G - (V(\mathcal{C}) \setminus V(C_i))$, establishing (vii). This contradicts the fact that \mathcal{C} is maximal with respect to Step (II) and completes the proof of Claim 4. \square

Armed with these claims we finish the proof of Lemma 1. Claim 3 shows that S is a hitting set avoiding v for the holes in G . All vertices of S belong to $V(\mathcal{C}) \setminus \{v\}$ by Claim 1, and therefore all lie on some path of the structure $\mathcal{C} - v$. Since the number of paths equals the order of the flower, while S contains at most 12 vertices from each path by Claim 4, it follows that the size of S is at most 12 times the order of the flower. This concludes the proof of Lemma 1. \square

5 Annotated Chordal Vertex Deletion

In what follows it is more convenient to work with a variant of the CHVD problem with some annotations on the set M . More formally, the input to the problem ANNOTATED CHORDAL VERTEX DELETION (A-CHVD for short) is a tuple (G, k, M, E^h) with the following properties:

1. G is a graph, k is an integer, $M \subseteq V(G)$, and $E^h \subseteq E(G[M])$;
2. $G - M$ is a chordal graph, and moreover, for every $v \in M$ the graph $G - (M \setminus \{v\})$ is a chordal graph.

The A-CHVD problem asks for the existence of a set $X \subseteq V(G)$, called henceforth a *solution*, such that $|X| \leq k$, $G - X$ is chordal, and for every pair $\{x, y\} \in E^h$, at least one of x and y belongs to X .

Lemma 1 can be used to transform an instance of the general CHVD problem into an equivalent instance satisfying the requirements of the annotated problem, if a modulator M is known. For the final kernelization algorithm, such a modulator will be obtained from the approximation algorithm of Theorem 2.

Lemma 2. *There is a polynomial-time algorithm that, given a graph G , an integer k , and a set $M_0 \subseteq V(G)$ such that $G - M_0$ is chordal, either correctly determines that (G, k) is a no-instance of CHVD or computes an instance (G', k', M, E^h) of A-CHVD with the same answer such that $|M| \in \mathcal{O}(k \cdot |M_0|)$ and $k' \leq k$.*

Proof. For every $v \in M_0$, we apply the algorithm of Lemma 1 to the nearly-chordal graph $G - (M_0 \setminus \{v\})$, obtaining a v -flower \mathcal{C}_v and a hitting set S_v . If $|\mathcal{C}_v| > k$ for some v , we delete the vertex v from G , decrease k by one, and restart the algorithm. If the budget k drops below zero then we report that the original input was a no-instance of CHVD. Clearly, if $|\mathcal{C}_v| > k$, then every size- k solution to CHVD on G contains the vertex v , so (G, k) is equivalent to $(G - v, k - 1)$. If $|\mathcal{C}_v| \leq k$ for every $v \in M_0$, we define $M := M_0 \cup \bigcup_{v \in M_0} S_v$; note that $|M| \leq |M_0|(12k + 1)$. Letting G' and k' denote the reduced graph and budget, we output the A-CHVD instance $(G', k', M, E^h = \emptyset)$. It follows from Lemma 1 that it is a valid A-CHVD instance, and clearly it is a yes-instance if and only if the original CHVD instance (G, k) is a yes-instance. \square

The next few sections are devoted to the proof of the following theorem.

Theorem 3. *A-CHVD admits a polynomial kernel when parameterized by $|M|$. More precisely, given an A-CHVD instance (G, k, M, E^h) , one can in polynomial time compute an equivalent instance (G', k, M, F^h) with $E^h \subseteq F^h$ and $|V(G')| \in \mathcal{O}(k^{16}|M|^{29})$.*

As typical for kernelization algorithms, the algorithm of Theorem 3 consists of a number of reduction rules; at every step, we apply the lowest-numbered reduction rule. Observe that any instance with $k \geq |M|$ has a trivial YES-answer as the set M is a solution. For such instances we can output a constant-size YES-instance of A-CHVD. In the remainder we assume $|M| > k$.

Let (G, k, M, E^h) be a A-CHVD instance. We say that a vertex set $S \subseteq V(G) \setminus M$ is *irrelevant* if the instances (G, k, M, E^h) and $(G - S, k, M, E^h)$ are equivalent. We say that a pair $xy \in \binom{M}{2}$ is a *new forced pair* if $xy \notin E^h$, but the instances (G, k, M, E^h) and $((V(G), E(G) \cup \{xy\}), k, M, E^h \cup \{xy\})$ are equivalent. Note that adding an edge xy to G is meaningless, as a solution is required to delete x or y anyway, but it makes notation later cleaner.

A hole H in the graph G is a *permitted hole* if $V(H)$ does not contain any pair of E^h . Note that a hole that is not permitted is hit by any solution to (G, k, M, E^h) due to the constraints imposed by E^h , and, informally speaking, we can ignore such holes in the further argumentation.

In what follows, we will use the following shorthand notation. Let $x_1, x_2, \dots, x_a, y_1, y_2, \dots, y_b \in M$ be (not necessarily distinct) vertices for some $a, b \geq 0$. Then we define:

$$V(x_1, x_2, \dots, x_a, \neg y_1, \neg y_2, \dots, \neg y_b) = \left((V(G) \setminus M) \cap \bigcap_{i=1}^a N(x_i) \right) \setminus \left(\bigcup_{j=1}^b N(y_j) \right)$$

$$G(x_1, x_2, \dots, x_a, \neg y_1, \neg y_2, \dots, \neg y_b) = G[V(x_1, x_2, \dots, x_a, \neg y_1, \neg y_2, \dots, \neg y_b)].$$

Consider the following reduction rule.

Reduction 1. For every $x, y \in M$ with $x \neq y$, $xy \notin E(G)$, if the size of the largest independent set in $G(x, y)$ is at least $k + 2$, then add xy to E^h and to $E(G)$.

The correctness is straightforward: any solution to (G, k, M, E^h) can delete at most k out of $k + 2$ vertices of any maximum independent set in $G(x, y)$; the remaining vertices form a C_4 with x and y , forcing the solution to delete either x or y . We add the edge xy to $E(G)$ to preserve the properties of an A-CHVD instance. Furthermore, note that as $G(x, y)$ is chordal, maximum independent sets can be computed in polynomial time [33].

In the remainder we will often use the following simple observation to find holes, in proofs by contraposition.

Observation 4 ([47, Proposition 3]). If a graph G contains a vertex v with two nonadjacent neighbors $u_1, u_2 \in N(v)$, and a walk from u_1 to u_2 with all internal vertices in $V(G) \setminus N[v]$, then G contains a hole passing through v .

We conclude this section with an important immediate observation about A-CHVD.

Proposition 6. Let (G, k, M, E^h) be an instance of A-CHVD. Then, for every $v \in M$ and every connected component A of $G(-v)$, the set $N_G(A) \setminus M$ is a clique.

Proof. Suppose there exist two nonadjacent vertices $u_1, u_2 \in N(A) \setminus M$. Apply Observation 4 to the graph $G - (M \setminus \{v\})$ with the vertex v and a path between u_1 and u_2 with internal vertices in A . This yields a hole in $G - (M \setminus \{v\})$, which contradicts the requirement of A-CHVD instances that $G - (M \setminus \{v\})$ is chordal for all $v \in M$. \square

6 Reducing the number of components wrt. a separator

The next procedure reduces an instance (G, k, M, E^h) of A-CHVD if we have access to a small vertex set whose removal splits the graph into many components. In general, it is not easy to find such a vertex set since it is related to computing the toughness of a graph, which is NP-hard [4]. The reduction can therefore only be applied for a concrete separator that is supplied to the procedure. For that reason, we call it a *reduction template*, instead of a concrete reduction rule. We will apply the template in situations where such a vertex set can be identified efficiently.

In the following, we will say “mark up to $f(k)$ objects of type X ” to mean the following. If there are more than $f(k)$ objects of type X , then choose $f(k)$ of them arbitrarily and mark them. If there are fewer, then mark all of them.

Reduction template 1. Given a vertex subset $S \supseteq M$ of G , do the following.

1. For every pair $xy \in \binom{S}{2} \setminus E(G)$, mark up to $k + 2$ connected components C of $G - S$ that contain both a neighbor of x and a neighbor of y .
2. For every pair $xy \in \binom{S}{2} \cap E(G)$, mark up to $k + 1$ connected components C of $G - S$ that contain a path P between a vertex in $N_G(x) \cap V(C)$ and a vertex in $N_G(y) \cap V(C)$ such that $V(P)$ avoids $N_G(x) \cap N_G(y)$.

Delete the vertices in an unmarked component C from the graph.

Template 1 yields a stand-alone reduction that does not rely on any other reduction rules being exhaustively applied. Observe that if $G - S$ has more than $(k + 2) \binom{|S|}{2}$ components, then the marking scheme will leave at least one component unmarked, and therefore the reduction will shrink the graph. Given S , it is easy to apply the procedure in polynomial time. Observe that the existence of a path P through a component C satisfying the conditions of the second item can be tested by trying for each $v \in N_G(x) \cap V(C)$ and $u \in N_G(y) \cap V(C)$ whether u and v belong to the same connected component of $G[V(C)] - (N_G(x) \cap N_G(y))$. Correctness follows from the next lemma.

Lemma 3. If a component C of $G - S$ is not marked by Reduction Template 1, then $V(C)$ is irrelevant.

Proof. Since $S \supseteq M$, no forced pairs involve $V(C)$. It therefore suffices to prove that if $(G - V(C)) - X$ is chordal for some set X of size at most k , then $G - X$ is chordal as well. Assume for a contradiction that $(G - V(C)) - X$ is chordal but $G - X$ is not, and consider some hole H in $G - X$. It uses at least one vertex $v \in V(C)$. Let x and y be the first vertices of S that you encounter when traversing the hole H forwards and backwards, respectively, when starting in v . By definition of A-CHVD and the fact that $M \subseteq S$ such vertices exist and $x \neq y$.

If $xy \notin E(G)$, then C is unmarked and contains a path from a neighbor of x to a neighbor of y . We marked at least $k + 2$ components that provide such a path and X intersects at most k of them, leaving two marked components C_1, C_2 free. As each component C_i contains a path between a neighbor of x and a neighbor of y , by shortcutting these paths we find induced xy -paths whose interior vertices belong to C_i , for each $i \in \{1, 2\}$. As C_1 and C_2 are distinct components of $G - S$ and the only vertices from S used on these paths are x and y , the interiors of the path are vertex-disjoint and the interior vertices of one path are not adjacent to interior of the other. Hence the concatenation of these paths is a hole in $(G - V(C)) - X$, a contradiction.

Now consider the case that $xy \in E(G)$. Since x and y are the first vertices of S encountered when traversing H starting at v , it follows that $H \cap V(C)$ is an induced path in C between a neighbor of x and a neighbor of y that avoids $N_G(x) \cap N_G(y)$. The hole H consists of xy together with this single segment in $H \cap V(C)$. Since C was not marked, there are $k + 1$ marked components containing a $N_G(x) \cap V(C)$ to $N_G(y) \cap V(C)$ path avoiding $N_G(x) \cap N_G(y)$. Consequently, one of these components C' is not intersected by X . Let P be an induced path in C' from $u_1 \in N_G(x) \cap V(C')$ to $u_2 \in N_G(y) \cap V(C')$ that avoids $N_G(x) \cap N_G(y)$. Let u'_1 be the last vertex on P that is adjacent to x , and let u'_2 be the first vertex after u'_1 that is adjacent to y . The subpath of P from u'_1 to u'_2 is an induced path with at least two vertices from a neighbor of x to a neighbor of y , and no interior vertex of this subpath is adjacent to x or y . Moreover, $u'_1, u'_2 \notin E(G)$ since P avoids $N_G(x) \cap N_G(y)$. Hence P forms a hole together with x and y , and this hole avoids X and $V(C)$. So $(G - V(C)) - X$ is not chordal; a contradiction. \square

7 Reducing cliques

Our goal for this section is to prove the following statement.

Lemma 4. *Given an A-CHVD instance (G, k, M, E^h) on which Reduction 1 is not applicable, and a clique K in $G - M$ of size $|K| > (k + 1)(|M|^3 + (k + 3)|M|^2)$, one can in polynomial time find either an irrelevant vertex or a new forced pair.*

Let $G^\circ := G - M$. Fix a clique tree of G° and root it in a vertex p such that $K \subseteq \beta(p)$.

7.1 Sets Q^{xy} and forced pairs

We first look for a new forced pair in the following manner. Let x and y be two distinct vertices of M with $xy \notin E(G)$. We say that a node $q \in V(T)$ is xy -good if there exists an xy -path P_q in G whose every internal vertex v belongs to G° and satisfies $\beta^{-1}(v) \subseteq T_q$. Note that if q is xy -good, then all its ancestors in the tree T are also xy -good. Let Q^{xy} be the set of all maximally bottommost xy -good nodes in T , that is, $q \in Q^{xy}$ if and only if q is xy -good but none of the children of q are xy -good. We claim the following.

Claim 5. *If $|Q^{xy}| \geq k + 2$ for some pair $xy \in \binom{M}{2} \setminus E(G)$, then every solution to the instance (G, k, M, E^h) contains at least one vertex from the pair xy .*

Proof. For every $q \in Q^{xy}$, let P_q be a path witnessing that q is xy -good; without loss of generality, assume that P_q is an induced path. Consider two distinct $q, q' \in Q^{xy}$. Observe that, by the definition of Q^{xy} , the nodes q and q' are not in ancestor-descendant relationship in T , and thus the subtrees T_q and $T_{q'}$ are node-disjoint. Consequently, no internal vertex of P_q is equal or adjacent to any internal vertex of $P_{q'}$. As $xy \notin E(G)$, the union of the paths P_q and $P_{q'}$ is a hole in G . As there are at least $k + 2$ elements of Q^{xy} , any solution to (G, k, M, E^h) avoids the set of internal vertices of at least two such paths, and therefore contains x or y . \lrcorner

Claim 5 justifies the following reduction rule.

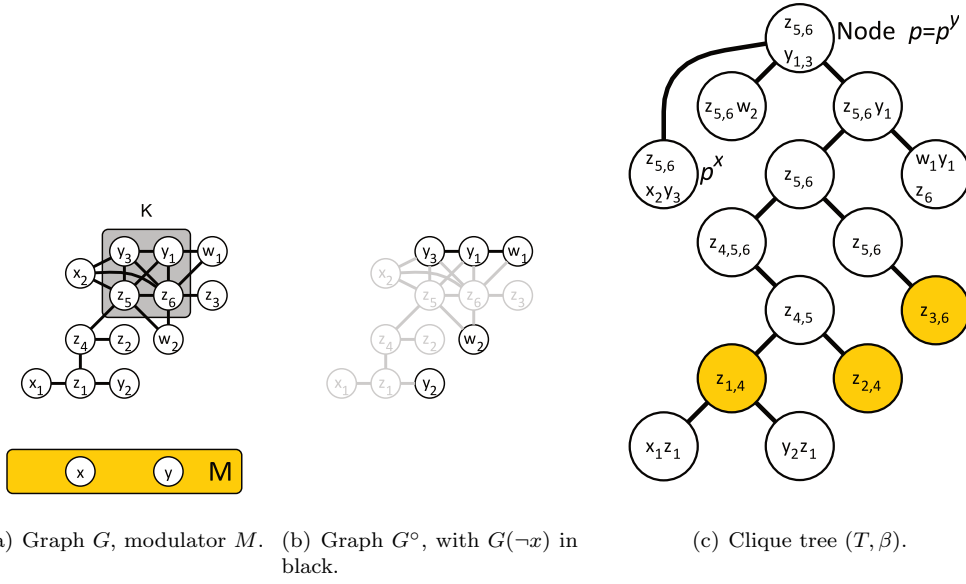

Figure 5: Illustration for the clique marking procedure. 5(a) Instance of A-CHVD with graph G and modulator M , and a clique K in G° . For readability, edges between G° and M are not drawn, but encoded through vertex names. Vertex x is adjacent to the x_i 's and z_i 's, vertex y is adjacent to the y_i 's and z_i 's. 5(b) The graph $G(-x)$ contains the vertices in black and has a component with vertex set $A^x = \{y_1, y_3, w_1\}$ that intersects K . Since $K \subseteq N_G(y)$ we have $A^y = \emptyset$. 5(c) A clique tree of G° rooted at a node p whose bag contains the entire clique K . The three nodes of Q^{xy} are yellow. A node p^x containing all vertices of A^x is chosen. When a letter such as $z_{5,6}$ has multiple subscripts, this means the bag contains both z_5 and z_6 .

Reduction 2. If $|Q^{xy}| \geq k + 2$ for some pair $xy \in \binom{M}{2} \setminus E(G)$, then add xy to E^h and to $E(G)$.

Observe that it is straightforward to check directly from the definition if a node $q \in V(T)$ is xy -good for a given pair xy . Thus, Reduction 2 can be applied in polynomial time, and henceforth we assume $|Q^{xy}| \leq k + 1$ for every pair $xy \in \binom{M}{2} \setminus E(G)$.

7.2 Marking relevant parts of a clique

Having bounded the size of the sets Q^{xy} , we now mark a number of vertices of the clique K , and then argue that any unmarked vertex is irrelevant. The argumentation here was loosely inspired by the analogous part of the work of Marx [47, Section 5].

Note that for every $x \in M$, there is at most one connected component of $G(-x)$ that contains a vertex of $\beta(p)$, since $\beta(p)$ is a clique in G° . By A^x we denote the vertex set of this connected component of $G(-x)$ if it exists. We define $A^x := \emptyset$ otherwise, which occurs when $\beta(p) \subseteq N(x)$. By Proposition 6, if $A^x \neq \emptyset$, then $N(A^x) \setminus M$ is a clique in G° ; let p^x be a node of T such that $N(A^x) \setminus M \subseteq \beta(p^x)$. For a vertex $x \in M$ with $A^x = \emptyset$, we define $p^x = p$, which is the root of the clique tree.

The marking procedure for this rule works with additional constraints. By a statement of the form “mark up to ℓ vertices of Z , preferring vertices maximizing/minimizing distance from q ” for some node $q \in V(T)$, we mean that we do not choose the vertices of Z to mark arbitrarily (in the case $|Z| > \ell$), but we sort vertices $u \in Z$ according to the distance between $\beta^{-1}(u)$ and q in T , and mark ℓ vertices with the largest/smallest distance. We are now ready to present our marking algorithm.

- (a) For every triple $(x_1, x_2, y) \in M \times M \times M$, mark up to $k + 1$ vertices from $K \cap V(x_1, x_2, \neg y)$.
- (b) For every pair $(x_1, x_2) \in \binom{M}{2} \setminus E(G)$ and every node $q \in Q^{x_1 x_2}$, mark up to $k + 1$ vertices of $K \cap V(x_1, x_2)$, preferring vertices maximizing distance from q .

- (c) For every pair $(x, y) \in M \times M$, mark up to $k + 1$ vertices from $K \cap V(x, \neg y)$, preferring vertices minimizing distance from p^y .
- (d) For every pair $(x, y) \in M \times M$, mark up to $k + 1$ vertices from $K \cap V(\neg x, \neg y)$, preferring vertices minimizing distance from p^y .

A direct calculation shows that we mark at most $(k + 1)(|M|^3 + (k + 3)|M|^2)$ vertices of K , and it is straightforward to implement the marking algorithm to run in polynomial time. Figure 6 illustrates the different types of holes that are preserved by this marking procedure.

7.3 Every unmarked vertex is irrelevant

The remainder of this section is devoted to the proof that any unmarked vertex of K is irrelevant. For that we need the following simple technical step.

Claim 6. *Let $v \in K$ be an unmarked vertex, $y \in M$ be a vertex such that $vy \notin E(G)$, and let P be a path between v and y with all internal vertices in G° . Then, for every $x \in M$, and every vertex v' marked for the pair (x, y) either in Point (c) if $vx \in E(G)$ or in Point (d) if $vx \notin E(G)$, the vertex v' is equal to or adjacent to at least one vertex of $V(P) \setminus \{v, y\}$.*

Proof. First, note that since in Points (c) and (d) we prefer vertices minimizing distance to p^y , and the vertex v is a candidate for marking when v' has been marked, the distance from $\beta^{-1}(v')$ to p^y is not larger than the distance from $\beta^{-1}(v)$ to p^y .

Without loss of generality we may assume that P is an induced path: shortcutting the path P to an induced one would only make our task harder. Let u be the neighbor of y on the path P . We have $u \in V(G^\circ)$; since $vy \notin E(G)$, we have also $u \neq v$. Furthermore, as P is an induced path, all vertices on P except for y and u lie outside $N[y]$, and thus they lie in A^y as $v \in A^y$. Consequently, $u \in N(A^y)$, and thus $p^y \in \beta^{-1}(u)$.

If $p^y \in \beta^{-1}(v)$, then also $p^y \in \beta^{-1}(v')$ and $v' = u$ or $v'u \in E(G)$. Otherwise, let e be the first edge of T on the unique path from p to p^y that is not contained in $T[\beta^{-1}(v)]$, and let p' be the endpoint of e that belongs to $\beta^{-1}(v)$. Since $P \setminus \{y\}$ induces a connected subgraph of G° containing vertices $v \in \beta(p)$ and $u \in \beta(p^y)$, there exists a vertex $w \in V(P) \setminus \{y\}$ with $w \in \text{ADH}(e)$. As $v \notin \text{ADH}(e)$ we know $w \neq v$. Furthermore, we have $p' \in \beta^{-1}(v')$, since $\beta^{-1}(v')$ is at least as close to p^y as $\beta^{-1}(v)$, and both $\beta^{-1}(v)$ and $\beta^{-1}(v')$ contain the root p . Hence, $w = v'$ or $wv' \in E(G)$. This finishes the proof of the claim. \square

We are now ready to prove the last claim, concluding the proof of Lemma 4.

Claim 7. *Every unmarked vertex of K is irrelevant.*

Proof. Let $v \in K$ be an unmarked vertex. It suffices to show that if X is a solution to $(G - v, k, M, E^h)$, then it is also a solution to (G, k, M, E^h) . Assume the contrary; as $v \notin M$, it must hold that there is a hole H in $G - X$. Since $G - v - X$ is chordal, $v \in V(H)$. By the properties of an A-CHVD instance (G, k, M, E^h) , the hole H contains at least two vertices of M . We make a case distinction, depending on whether the neighbors of v on the hole H belong to M or lie in G° (see Fig. 6).

Case 1: both neighbors of v on H lie in M . Denote these two neighbors by x_1, x_2 . As H is a hole, $x_1x_2 \notin E(G)$; in particular, $x_1x_2 \notin E^h$.

Assume first that x_1 and x_2 are the only two vertices of $V(H) \cap M$. Then H consists of vertices v, x_1, x_2 , and a path P between x_1 and x_2 with all internal vertices in G° . Consider the set P_T of all nodes of T whose bag contain at least one internal vertex of P . Since $v \in K \subseteq \beta(p)$, and H is a hole, we have $p \notin P_T$. Furthermore, by the connectivity of P , P_T induces a subtree of T . Let q_0 be the topmost (closest to p) vertex of P_T ; note that $q_0 \neq p$.

By the existence of the path P , the node q_0 is x_1x_2 -good. By the definition of $Q^{x_1x_2}$ there exists a node $q \in Q^{x_1x_2}$ that is a descendant of q_0 . Consider a vertex v' marked at Point (b) for the pair x_1x_2 and the node q that does not belong to the solution X . Since in Point (b) we mark vertices that maximize the distance from q , the distance between $\beta^{-1}(v')$ and q is at least as large as the distance between $\beta^{-1}(v)$ and q . Consequently, since the root p belongs to $\beta^{-1}(v')$ and to $\beta^{-1}(v)$, and q_0 is an ancestor of q , we have $q_0 \notin \beta^{-1}(v')$. We infer that v' is not adjacent to any internal vertex of P_T , and

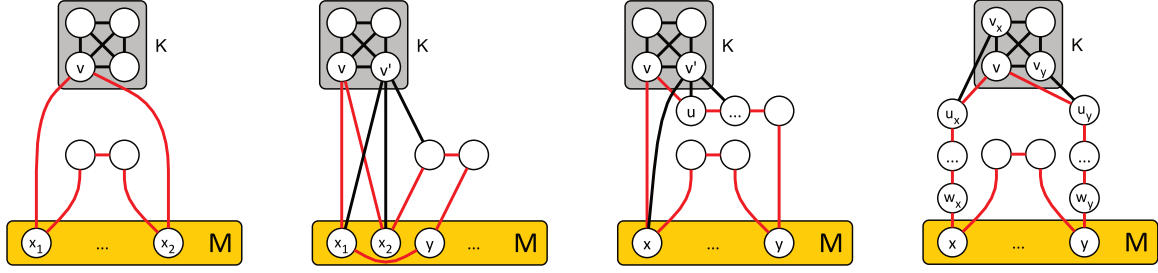

(a) $|N_H(v) \cap M| = 2$ and $|V(H) \cap M| = 2$. (b) $|N_H(v) \cap M| = 2$ and $|V(H) \cap M| > 2$. (c) $|N_H(v) \cap M| = 1$. (d) $|N_H(v) \cap M| = 0$.

Figure 6: Illustration for the correctness of the clique marking procedure (Claim 7). The four subfigures correspond to the four marking steps (a)–(d). Each subfigure shows a schematic view of an instance with a modulator M and clique K in G° that is the target of the marking procedure. For each of the four types of holes highlighted in red, the corresponding marking step ensures that the constraints they impose on size- k solutions are preserved after deleting the unmarked vertices. Vertex names correspond to those used in the proof of Claim 7.

thus if we replace v with v' on the hole H , we obtain a hole as well, contradicting the fact that $G - v - X$ is a chordal graph.

In the remaining case, there exists a third node $y \in V(H) \cap M$, different from x_1 and x_2 ; in particular, $vy \notin E(G)$. Consider a vertex v' marked at Point (a) for the triple (x_1, x_2, y) that does not belong to X . Consider the path $P := H - y$ between the neighbors of y on the hole H , and let P' be the walk created from P by replacing the vertex v with v' . Since $v' \in N(x_1) \cap N(x_2)$, P' is indeed a walk. Since $v' \notin N(y)$, all internal vertices of P' avoid $N[y]$. Since no vertex of P' belongs to X nor equals v , by Observation 4 the graph $G - v - X$ contains a hole, a contradiction.

Case 2: one neighbor of v on H lies in M . Let u and x be the two neighbors of v on H , with $x \in M$ and $u \in V(G^\circ)$. Let y be the first vertex of $V(H) \cap M$ that we encounter if we traverse H starting from v in the direction towards u . Since $V(H) \cap M$ contains at least two vertices, $x \neq y$, in particular, $vy \notin E(G)$. Let P_u, P_x be the subpaths of H between v and y , with $u \in V(P_u)$ and $x \in V(P_x)$.

Consider a vertex v' marked at Point (c) for the pair (x, y) that does not belong to the solution X . By Claim 6, $(V(P_u) \setminus \{v\}) \cup \{v'\}$ induces a connected subgraph of G . Since $v'y \notin E(G)$ and $v'x \in E(G)$, $(V(P_x) \cup V(P_u) \setminus \{v\}) \cup \{v'\}$ contains a path from the two neighbors of y on the hole H whose internal vertices belong to $V(G) \setminus (N[y] \cup \{v\})$. By Observation 4, the graph $G - v - X$ contains a hole, a contradiction.

Case 3: none of the neighbors of v on H lies in M . Let u_x and u_y be the two neighbors of v on H . Let x be the first vertex of M that we encounter if we traverse H starting from v in the direction towards u_x , and similarly define y for u_y . Since $V(H) \cap M$ contains at least two vertices, $x \neq y$. Clearly, we have also $vx, vy \notin E(G)$. Let P_x be the subpath of H between v and x containing u_x , and let w_x be the neighbor of x on P_x . Similarly define P_y and w_y . Note that it is possible that $w_x = u_x$ or $w_y = u_y$.

Consider vertices v_y and v_x marked at Point (d) for the pairs (x, y) and (y, x) , respectively, that do not belong to the solution X . Note that it is possible that $v_y = v_x$. By Claim 6, both $(V(P_x) \setminus \{v\}) \cup \{v_x\}$ and $(V(P_y) \setminus \{v\}) \cup \{v_y\}$ induce connected graphs. As both v_x and v_y belong to the clique K , it follows that $(V(P_x) \cup V(P_y) \cup \{v_x, v_y\}) \setminus \{v\}$ induces a connected subgraph of G ; in particular, it contains a path from w_x to w_y whose internal vertices belong to $V(-x, -y)$. This path, together with the subpath of H between x and y not containing v , witnesses that there exists a walk in $G - v - X$ between two neighbors of y on H whose internal vertices do not belong to $N[y]$. By Observation 4, $G - v - X$ contains a hole, a contradiction. \lrcorner

Define $\omega_{k,|M|} := (k+1)(|M|^3 + (k+3)|M|^2) \leq \mathcal{O}(k|M|^3)$ as a shorthand for the bound of Lemma 4; note that instances with $k \geq |M|$ trivially have a solution consisting of the entire set M . Having proven Lemma 4, we may state the following reduction rule.

Reduction 3. Apply the algorithm of Lemma 4 to any maximal clique of G° whose size is larger than $\omega_{k,|M|}$. Depending on the outcome, either add the new forced pair to E^h and to $E(G)$ or delete an irrelevant vertex from G .

Exhaustive application of Rule 3 ensures that the clique number $\omega(G^\circ)$ of the chordal graph G° is bounded by $\omega_{k,|M|}$. Since chordal graphs have perfect elimination orderings (cf. [11, §1.2]), the number of maximal cliques is linear in the number of vertices. The maximal cliques can be identified efficiently from a clique tree, implying that Rule 3 can be applied exhaustively in polynomial time.

8 Reducing the number of components of nonneighbors

The main goal in this section is to reduce the number of connected components of $G(\neg x)$ for each $x \in M$. Rather than reducing this number by deleting vertices, we will get rid of components of $G(\neg x)$ by making them adjacent to x . To ensure that this process does not change the answer of the instance, we have to understand how holes in G use such components. We therefore need to introduce some notation.

Definition 1. Let $x, y \in M$ with $x \neq y$. Let $\mathcal{C}_{\neg x}(y)$ be the connected components C of $G(\neg x)$ such that $V(C) \cap N_G(y) \neq \emptyset$ and $N_{G^\circ}(C) \setminus N_G(y) \neq \emptyset$.

A component C of $\mathcal{C}_{\neg x}(y)$ contains the interior vertices of an induced path P_C between y and a vertex v of $N_{G^\circ}(C) \setminus N_G(y)$, which has at least two edges. Observe that if we have two components $C_1, C_2 \in \mathcal{C}_{\neg x}(y)$ for which $v \in (N_{G^\circ}(C_1) \cap N_{G^\circ}(C_2)) \setminus N_G(y)$ is a common neighbor, then the concatenation of the two paths P_{C_1} and P_{C_2} is a hole through y and v (see Fig. 7(a)). The key point here is that since C_1 and C_2 are different components of $G(\neg x)$, no vertex of C_1 is adjacent to a vertex of C_2 . The role of x in Definition 1 is to ensure this property.

Furthermore, we observe that such a hole, created from a concatenation of P_{C_1} and P_{C_2} , contains only one vertex of M , namely y . This is a contradiction with the definition of an A-CHVD instance. Consequently, we have the following observation that is crucial to our goal of reducing the number of components of $G(\neg x)$ for all $x \in M$.

Observation 5. For fixed vertices $x, y \in M$, the sets $\{N_{G^\circ}(C) \setminus N_G(y) \mid C \in \mathcal{C}_{\neg x}(y)\}$ are pairwise disjoint.

We are now ready to state our reduction rule.

Reduction 4. Let (G, k, M, E^h) be exhaustively reduced under Rule 3. First, exhaustively apply Reduction Template 1 to sets

$$S_{\neg x, y} := M \cup \bigcup \{N_G(C) \mid C \text{ is a component of } G(\neg x) \text{ that contains a neighbor of } y\},$$

for all $x, y \in M$. Second, for every $x \in M$ do the following marking process.

1. For all $y \in M$ with $xy \notin E(G)$, mark up to $(k+1)((k+2) \cdot \omega_{k,|M|} + |M|)^2 + 1$ components C of $G(\neg x)$ that contain a neighbor of y .
2. For each $y \in M$ with $xy \in E(G)$, mark up to $k+1$ components C of $\mathcal{C}_{\neg x}(y)$.
3. For each $y_1, y_2 \in M$ with $y_1 y_2 \notin E(G)$, mark up to $k+1$ components C of $G(\neg x)$ for which $V(C) \cap N_G(y_1) \neq \emptyset$ and $V(C) \cap N_G(y_2) \neq \emptyset$.

If some component C of $G(\neg x)$ is unmarked when the process finishes, then make x adjacent to all vertices of C .

If $G(\neg x)$ has at least $(k+1)((k+2) \cdot \omega_{k,|M|} + |M|)^2 + (k+1)(|M| + |M|^2) + 2$ components, then Rule 4 will be triggered to make x adjacent to all vertices of one such component. Hence exhaustive application of the rule bounds the number of components of $G(\neg x)$ by $\mathcal{O}(k^5 |M|^6)$.

Lemma 5. If Rule 4 reduces an instance (G, k, M, E^h) of A-CHVD to (G', k, M, E^h) by making x adjacent to all vertices of C , then the instances are equivalent.

Proof. As adding edges to a nonchordal graph can make it chordal, and adding edges to a chordal graph can make it nonchordal, both directions of the equivalence are nontrivial.

(\Rightarrow) Assume that (G, k, M, E^h) has a solution X of size at most k , and assume for a contradiction that X is not a solution for the reduced instance. Since the instances have the same forced pairs, graph $G - X$ is chordal but $G' - X$ is not. Consider a hole H in $G' - X$. Since H is not a hole in $G - X$, while adding edges to a graph cannot make an existing cycle chordless, one of the edges that was added between x and C lies on H . Let $xv \in E(H)$ with $v \in V(C)$ be such an edge. Orient H such that x is the predecessor of v on H , and consider the successor y of v . Since H is a hole, $xy \notin E(G')$ and therefore $y \notin V(C)$ since G' has all edges between x and $V(C)$. Moreover, $y \notin N_G(C) \setminus M$ since $N_G(C) \setminus M \subseteq N_G(x)$ as C is a component of $G(-x)$. Hence $y \in M$. Since C is an unmarked component of $G(-x)$ that contains $v \in N_G(y)$, in Point (1) we marked $(k+1)((k+2) \cdot \omega_{k,|M|} + |M|)^2 + 1$ other components of $G(-x)$ that contain a neighbor of y . Consider the set \mathcal{C}' of components of $G(-x)$ that contain a G -neighbor of y and define $S := \bigcup_{C \in \mathcal{C}'} N_{G^\circ}(C)$.

Claim 8. *There is a subset $S' \subseteq S$ of size $k+2$ that is independent in G .*

Proof. Proposition 1 implies $\alpha(G[S]) \geq |S|/\omega(G[S])$. By the precondition that Rule 3 cannot be applied, we know $\omega(G[S]) \leq \omega_{k,|M|}$. It follows that if $|S| \geq (k+2) \cdot \omega_{k,|M|}$, an independent subset of size $k+2$ exists.

Assume for a contradiction that $|S| < (k+2) \cdot \omega_{k,|M|}$. Let $S^* := S \cup M$ and observe that each component of \mathcal{C}' occurs as a connected component of $G - S^*$. Hence $G - S^*$ has at least $|\mathcal{C}'| \geq (k+1)((k+2) \cdot \omega_{k,|M|} + |M|)^2 + 1 > (k+1)|S^*|^2$ connected components. But this implies that applying Template 1 with the separator $S^* = S_{-x,y}$ will remove an irrelevant component, contradicting the precondition that this template is exhaustively applied for $S_{-x,y}$. \perp

Claim 9. *There are two distinct marked components $C_1, C_2 \in \mathcal{C}'$ that avoid X , along with distinct vertices $u_1 \in N_G(C_1) \setminus (M \cup X)$ and $u_2 \in N_G(C_2) \setminus (M \cup X)$ such that there are no edges in G between $V(C_1) \cup \{u_1\}$ and $V(C_2) \cup \{u_2\}$.*

Proof. Consider an independent subset S' of S of size $k+2$, whose existence is guaranteed by Claim 8. By definition of S , for each $v \in S'$ there exists a component $C_v \in \mathcal{C}'$ whose G -neighborhood contains v . For $v \neq v' \in S'$, the corresponding components C_v and $C_{v'}$ are distinct. This follows from the fact that $vv' \notin E(G)$ as S' is independent in G , together with the fact that for each component C of $G(-x)$ the set $N_{G^\circ}(C)$ is a clique by Proposition 6. Moreover, v is not adjacent to any vertex in $C_{v'}$, as otherwise $v \in N_{G^\circ}(C_{v'})$ would be adjacent to $v' \in N_{G^\circ}(C_{v'})$ as the neighborhood is a clique. Similarly, v' is not adjacent to any vertex in $N_{G^\circ}(C_v)$.

Consider the set S' of size $k+2$. For each vertex $u \in X$, discard v from S' if $v = u$ or if $u \in C_v \cap X$. As each vertex of X discards at most one vertex, two vertices $u_1, u_2 \in S'$ exist that are not discarded. Let C_1 and C_2 in \mathcal{C}' be the corresponding components of $G(-x)$ that contain a G -neighbor of y . By the discarding process we know that X contains no vertex of $\{u_1, u_2\} \cup V(C_1) \cup V(C_2)$. The argumentation above shows that no vertex of $\{u_1\} \cup V(C_1)$ is adjacent in G to a vertex of $\{u_2\} \cup V(C_2)$. \perp

Claim 9 allows us to derive a contradiction. Consider the marked components C_1, C_2 with the corresponding vertices u_1 and u_2 , whose existence is guaranteed by that claim. Since each C_i contains a neighbor of y , while each u_i is in the G -neighborhood of a component of $G(-x)$ and is therefore adjacent to x , it follows that each $C_i \cup \{u_i\}$ contains the interior vertices of an induced xy -path in G . As the claim guarantees that these paths are vertex-disjoint, not adjacent to each other, and avoid X , their concatenation forms a hole in $G - X$ (see Fig. 7(b)). The hole avoids C , since its interior uses marked components and C is unmarked. But then this is also a hole in $G' - X$, a contradiction. This concludes the proof of the forward direction of the equivalence.

(\Leftarrow) Assume that $G' - X$ is chordal but $G - X$ is not, and let H be a hole in $G - X$. Since $G - X$ is obtained from $G' - X$ by removing all edges between v and $V(C) \setminus X$, hole H goes through x and the edges from x to C form chords on H in G' . Consider $N_H[x]$ containing x and its two neighbors on H . As H is a hole in $G - X$, for all $v \in V(H) \setminus N_H[x]$ we have $xv \notin E(G)$.

Claim 10. *All vertices of $V(H) \setminus N_H[x]$ belong to C .*

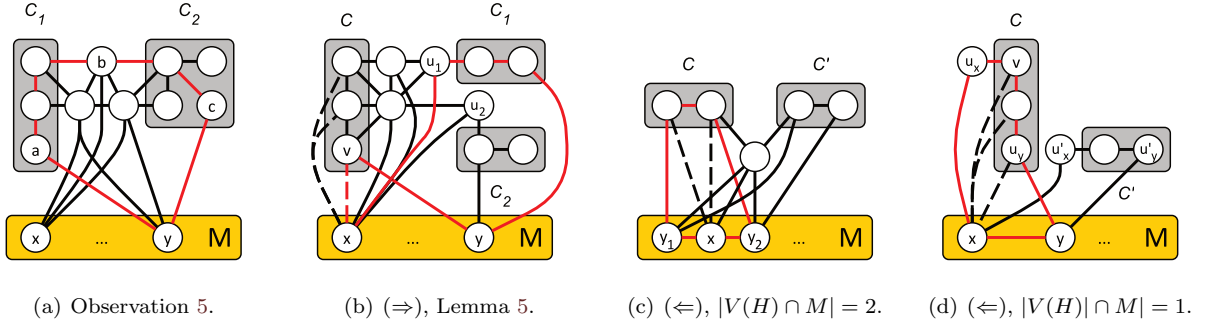

Figure 7: Illustrations for Section 8. All figures show an instance of A-CHVD with a graph G and modulator M . Gray boxes highlight components of $G(\neg x)$. Solid lines indicate edges in the graph. Red edges are used to highlight a hole. For the last three figures, dotted lines represent edges between v and C added by the reduction rule to obtain G' . 7(a) Illustration of Observation 5. Components C_1 and C_2 of $G(\neg x)$ contain neighbors a and c of y . The nonneighbor b of y that belongs to $N_{G^\circ}(C_1) \cap N_{G^\circ}(C_2)$ implies the existence of the red hole using only one vertex from M . 7(b) If adding edges between x and C creates a hole in $G' - X$ (in red) that was not in $G - X$, then a hole in $G - X$ can be found through the marked components. 7(c) Case 1 of Lemma 5. If $G' - X$ is chordal but $G - X$ contains a hole through x (in red), then another hole can be found in $G' - X$ through marked components. 7(d) Case 2 of Lemma 5.

Proof. If $v \in V(H) \setminus (N_H[x] \cup V(C))$, then $xv \notin E(G)$ implies $xv \notin E(G')$. The subpath of H connecting the neighbors of v on H forms a walk connecting $N_{G'}(v)$ in $G' - X$ whose interior avoids $N_{G'}[v]$, implying by Observation 4 that $G' - X$ has a hole. \square

We do a case distinction on where the neighbors of x on H appear in the graph.

Case 1: both neighbors of x on H lie in M . Denote these two neighbors by y_1, y_2 . As H is a hole in $G - X$ we have $y_1 y_2 \notin E(G)$, and as G' and G differ only in edges between x and $V(C)$ we have $y_1 y_2 \notin E(G')$. By Claim 10, all vertices of $V(H) \setminus \{y_1, y_2, x\}$ belong to C , showing that both y_1 and y_2 have a G -neighbor in C . Hence C was a candidate for marking in Point (3), and as C was not marked there is a marked component C' of $G(\neg x)$ containing a G -neighbor of y_1 as well as a neighbor of y_2 , such that X avoids C' . There is an induced path P connecting y_1 to y_2 such that the interior of P is contained in C' . As the interior of P belongs to a component of $G(\neg x)$, the interior is not adjacent to x in G . The concatenation of P with (y_1, x, y_2) is therefore a hole in $G - X$ (see Fig. 7(c)). Since no vertex belongs to C , this is also a hole in $G' - X$; a contradiction.

Case 2: one neighbor of x on H lies in M . Let u_x and y be the two neighbors of x on H , with $y \in M$ and $u_x \in V(G^\circ)$. Let v be the neighbor of u_x on H that is not x , and let u_y be the neighbor of y that is not x . Since the hole contains (y, x, u_x) we know $yu_x \notin E(G)$. By Claim 10 we have $v \in V(C)$ and therefore $u_x \in N_{G^\circ}(C)$. Claim 10 also ensures $u_y \in V(C)$.

So C is a component of $G(\neg x)$ that contains a neighbor u_y of y and the G° -neighborhood of C contains a nonneighbor u_x of y . It follows that $C \in \mathcal{C}_{\neg x}(y)$ and hence C was eligible for marking in Point (2), but was not marked because some other $k + 1$ components of $G(\neg x)$ were marked. Consider the set \mathcal{C}_M of marked components, and discard all components C that contain a vertex of X either in C or in $N_{G^\circ}(C) \setminus N_G(y)$. By Observation 5, every vertex of X discards at most one component of \mathcal{C}_M , implying that some marked component $C' \in \mathcal{C}_M$ is not discarded and C' contains a G -neighbor of y . Let u'_x be a vertex of $N_{G^\circ}(C') \setminus (N_G(y) \cup X)$, which exists by the discarding process, and note that this implies $u'_x x \in E(G)$. There is an induced path from y to u'_x whose interior belongs to C' , and therefore the path avoids X . Since the interior belongs to C' , which is a component of $G(\neg x)$, the interior is not adjacent to x . This path forms a hole in $G - X$ together with x (see Fig. 7(d)), and as the hole avoids C it is also a hole in $G' - X$; a contradiction.

Case 3: none of the neighbors of x on H lie in M . This case is the easiest. Claim 10 ensures that the vertices of H that are not x or its neighbors, belong to $C \subseteq G^\circ$. If the neighbors of x on H do not lie in M , then they also lie in G° so that x is the only vertex from H that belongs to M . But then $G - (M \setminus \{x\})$ is not chordal. So (G, k, M, E^h) is not a valid instance of A-CHVD; a contradiction. \square

9 Reducing a single component

In this section we assume that we are working with an A-CHVD instance (G, k, M, E^h) for which none of the so-far defined reduction rules apply. Recall that we denote $G^\circ = G - M$. We fix some clique tree (T, β) of G° . We mark a set $Q_0 \subseteq V(T)$ of important bags as follows.

1. For every pair $xy \in \binom{M}{2} \setminus E(G)$, for every maximal clique of $G(x, y)$ we mark a node of T that contains this clique in its bag.
2. For every $x \in M$ and every connected component A of $G(\neg x)$, we mark a node of T whose bag contains $N_{G^\circ}(A)$; recall that by Proposition 6 the set $N_{G^\circ}(A)$ induces a clique in G° .

Let Q be the set Q_0 together with the root of T and all lowest common ancestors in T of every pair of nodes from Q_0 . Standard arguments show that $|Q| \leq 1 + 2|Q_0|$. We define $S_Q = \bigcup_{s \in Q} \beta(s)$.

Reduction 5. Apply Reduction Template 1 with the separator $S_Q \cup M$.

Proposition 7. *If Rules 1, 2, 3, 4, and 5 have been applied exhaustively, then $|S_Q \cup M| \in \mathcal{O}(k^6|M|^{10})$ and $G - (S_Q \cup M) = G^\circ - S_Q$ has $\mathcal{O}(k^{13}|M|^{20})$ connected components.*

Proof. We first bound the size of Q_0 and Q . For every pair $xy \in \binom{M}{2} \setminus E(G)$, we add a bag to Q_0 in the first step for each maximal clique of $G(x, y)$. Since Rule 1 is not applicable and $xy \notin E(G)$, we have $\alpha(G(x, y)) < k + 2$. Proposition 1 shows that $|V(x, y)| \leq \alpha(G(x, y)) \cdot \omega(G(x, y))$, and since Rule 3 is not applicable we know $\omega(G(x, y)) \leq \omega(G^\circ) \leq \omega_{k, |M|}$. Hence $|V(x, y)| \leq (k + 2) \cdot \omega_{k, |M|}$. Since the number of maximal cliques in the chordal graph $G(x, y)$ does not exceed its order, for each nonadjacent pair x, y in M we add at most $|V(x, y)|$ bags to Q_0 . Hence the first step contributes at most $|M|^2(k + 2) \cdot \omega_{k, |M|} \in \mathcal{O}(k^2|M|^5)$ bags to $|Q_0|$.

In the second step, we add a bag to Q_0 for each connected component of $G(\neg x)$ for each $x \in M$. Since Rule 4 is not applicable, we know that each $x \in M$ yields $\mathcal{O}(k^5|M|^6)$ connected components in $G(\neg x)$. The contribution of the second step therefore dominates the size of Q_0 and we have $|Q_0| \in \mathcal{O}(k^5|M|^7)$, which implies $|Q| \in \mathcal{O}(k^5|M|^7)$.

Since each bag is a clique in G° , it contains $\omega_{k, |M|} \in \mathcal{O}(k|M|^3)$ vertices since Rule 3 is exhaustively applied. It follows that $|S_Q| \leq |Q| \cdot \omega_{k, |M|} \in \mathcal{O}(k^6|M|^{10})$ vertices, which also forms a size bound for the entire separator $S_Q \cup M$. As Rule 5 is exhaustively applied, it follows that the number of components of $G^\circ - S_Q$ is $\mathcal{O}(k \cdot |S_Q \cup M|^2) \in \mathcal{O}(k^{13}|M|^{20})$. \square

As Proposition 7 shows that $|S_Q \cup M|$ and the number of components of $G - (S_Q \cup M)$ is bounded polynomially in the parameter, it only remains to bound the size of each component. Our main focus in this section is therefore to bound the size of a single connected component A of $G^\circ - S_Q$. Let $Q^A = \bigcup_{v \in A} \beta^{-1}(v)$; since $G^\circ[A]$ is connected, $T[Q^A]$ is connected as well. By the construction of Q , there exists at most two nodes $q \in N_T(Q_A)$ such that if p is the unique neighbor of q in Q_A then $\beta(p) \cap \beta(q) \neq \emptyset$. Furthermore, one of these nodes q is the parent of the topmost vertex of Q^A , and we denote it by q^\uparrow . If the second one exists, we denote it by q^\downarrow ; otherwise, we add a dummy node q^\downarrow with an empty bag as a child of one of the leaves of $T[Q^A]$. Consequently, we have that

$$N_G(A) \subseteq M \cup \beta(q^\uparrow) \cup \beta(q^\downarrow). \quad (1)$$

Let Π be the unique path from q^\uparrow to q^\downarrow in the tree T . Refer to Figure 8 for an illustration of these concepts. We start with the following simple observation.

Observation 6. For every vertex $v \in A$ and two distinct neighbors $x \in N(v) \cap M$ and $u \in N(v)$ we have $xu \in E(G)$. In particular, we have $N(v) \cap M = N(A) \cap M$ (i.e., every vertex in A has exactly the same set of neighbors in M) and $N(A) \cap M$ is a clique in G .

Proof. First, assume the contrary of the first claim. If $u \in M$, then $v \in V(x, u)$, but since $xu \notin E(G)$, v belongs to $\bigcup_{q \in Q_0} \beta(q)$ by the first marking step. Hence $v \in S_Q$ and cannot belong to a component A of $G^\circ - S_Q$; contradiction. If $u \notin M$, then $v \in N_{G^\circ}(V(\neg x))$ since $u \in V(\neg x)$, and thus $v \in \bigcup_{q \in Q_0} \beta(q)$ by the second marking step. The second claim follows from the connectivity of A . \square

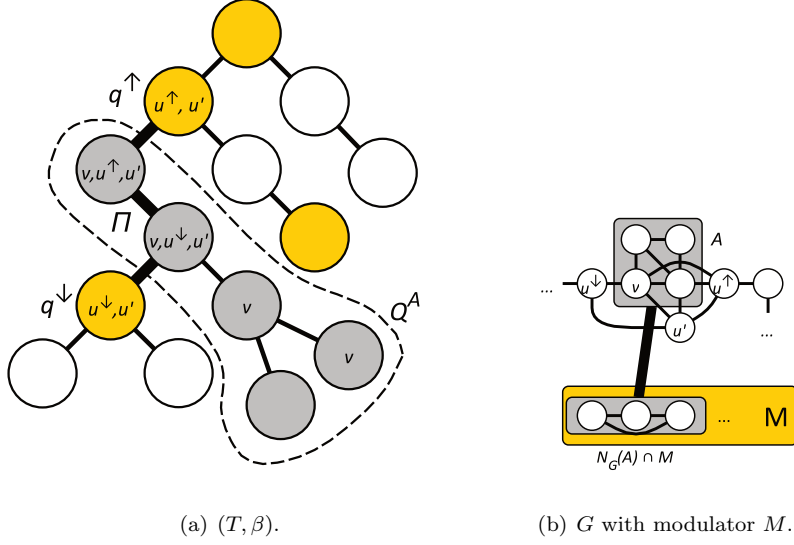

Figure 8: Illustration of the structure of components A of $G^\circ - S_Q$ analyzed in Section 9. 8(a) Clique tree (T, β) of the graph G° . The marked bags Q are drawn in yellow; note their closure under taking least common ancestors. The bags Q^A that contain a vertex of A are drawn gray. The subtree induced by Q^A has two neighbors in T , q^\uparrow and q^\downarrow . The unique simple $q^\uparrow q^\downarrow$ -path Π in T is highlighted with thick edges. 8(b) Local structure in the corresponding graph G with modulator M . The component A of $G^\circ - S_Q$ is visualized by a box. Its neighborhood in G° is a subset of the vertices in $\beta(q^\uparrow)$ and $\beta(q^\downarrow)$, both of which are cliques in G° . These two cliques can overlap, as they do here in vertex u' . By Observation 6, all vertices in A have the same neighborhood in M , which is visualized by a box. The thick edge between the two boxes represents all possible edges between the two sets. By Claim 11, any permitted hole H using a vertex of A uses A to form an induced path between some $u^\uparrow \in \beta(q^\uparrow)$ and $u^\downarrow \in \beta(q^\downarrow)$. For any vertex v used on such a path, the subtree $\beta^{-1}(v)$ uses a vertex of Π .

9.1 Permitted holes through A

In this section we analyze permitted holes in G that contain some vertices from A .

Claim 11. *Let H be a permitted hole in G that passes through A and let $v \in V(H) \cap A$ be arbitrary. Then:*

1. *both neighbors of v on H lie in G° ;*
2. *H contains a subpath between a vertex of $\beta(q^\uparrow)$ and a vertex of $\beta(q^\downarrow)$ that contains v and whose internal vertices all lie in A ;*
3. *$\beta^{-1}(v)$ contains at least one internal vertex of Π .*

Proof. The first claim follows from Observation 6: if one of the neighbors of v on H lies in M , then it is adjacent to the second neighbor of v on H , a contradiction.

For the second claim, let P be a maximal subpath of H containing v such that all internal vertices lie in A ; recall that at least two vertices of H lie in M , so the endpoints of P are distinct. Furthermore, from the first claim, applied to all internal vertices of P , we infer that the endpoints of P lie in G° . Since $N(A) \subseteq M \cup \beta(q^\uparrow) \cup \beta(q^\downarrow)$ by (1), they lie in $\beta(q^\uparrow) \cup \beta(q^\downarrow)$. Since H needs to contain at least two vertices of M , and P does not contain any such vertices but contains $v \in A$, the two endpoints of P are nonadjacent, and thus one endpoint of P lies in $\beta(q^\uparrow)$ and one lies in $\beta(q^\downarrow)$ as both sets are cliques.

For the last claim, let P' be a subpath of H between a vertex $u^\uparrow \in \beta(q^\uparrow)$ and $u^\downarrow \in \beta(q^\downarrow)$ that contains v , whose existence we just established. The minimal path $\Pi_T(u^\uparrow, u^\downarrow)$ connecting $\beta^{-1}(u^\uparrow)$ and $\beta^{-1}(u^\downarrow)$ in T is a subpath of Π . Since P' is an induced path in G° , Proposition 4 shows that $\beta^{-1}(v)$ contains a node of $\Pi_T(u^\uparrow, u^\downarrow) \subseteq \Pi$. This must be an internal node of Π , since $v \in A$ does not occur in $\beta(q^\uparrow)$ or $\beta(q^\downarrow)$. \lrcorner

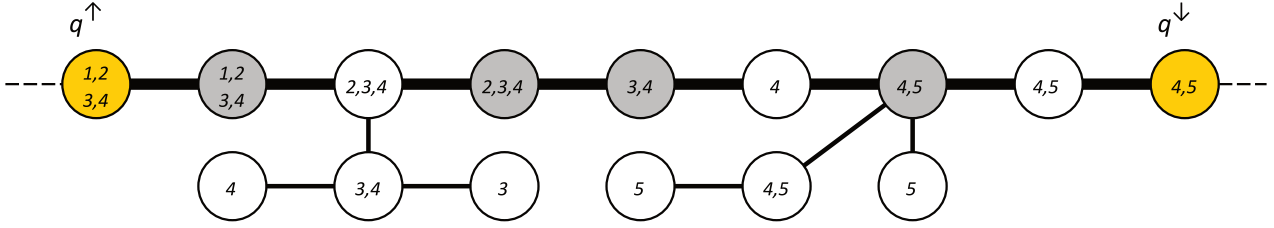

Figure 9: Illustration of the process of marking nodes on Π to determine sets $Q_i \subseteq V(\Pi)$ and $Z_i \subseteq V(A) \subseteq V(G^\circ)$. Path Π in (T, β) laid out horizontally. Only the occurrence of the vertices in $\beta(q^\uparrow) \cup \beta(q^\downarrow)$ in bags of T is shown. The bags also contain other vertices, which are hidden. Nodes $Q_0 = \{q^\uparrow, q^\downarrow\}$ are drawn in yellow. The set Q_{i+1} contains Q_i , and for each vertex v in a bag $q \in Q_i$ it contains the leftmost and rightmost occurrence of v on Π . The gray bags are added to Q_1 by this process. For example, the first gray node from the left is added to Q_1 because it has the rightmost occurrence of $1 \in \beta(q^\uparrow \in Q_0)$, i.e., the occurrence of 1 on Π that is closest to q^\uparrow in T .

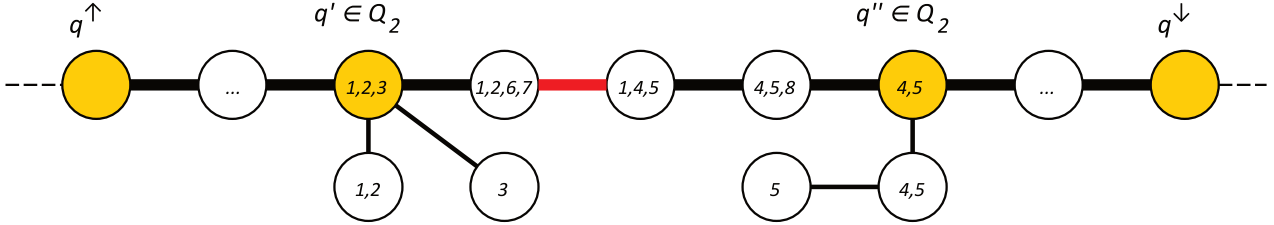

Figure 10: The set Q_2 on the $q^\uparrow q^\downarrow$ -path Π is drawn in yellow. For some bags on the path, the vertices from A they contain are drawn within their circles. Between consecutive nodes from Q_2 we find an edge e minimizing $|\text{ADH}(e) \cap A|$ and add it to R . The red edge is added to R , since its adhesion is $\{1, 2, 6, 7\} \cap \{1, 4, 5\} = \{1\} \in A$, while the other edges between q' and q'' all have at least two vertices from A in their adhesion.

9.2 Important vertices in A

We now define a set Z of important vertices in A . Intuitively, these are the only vertices that a “reasonable” solution may delete in A .

We define by induction sets $Q_i \subseteq V(\Pi)$ for $i \in \{0, 1, 2, \dots\}$. Let $Q_0 = \{q^\uparrow, q^\downarrow\}$. Given Q_i , we first define $Z_i = \bigcup_{q \in Q_i} \beta(q)$ and then Q_{i+1} as follows: we start with $Q_{i+1} = Q_i$ and then, for every $u \in Z_i$ we add to Q_{i+1} the node on $V(\Pi) \cap \beta^{-1}(u)$ that is closest to q^\uparrow and the node that is closest to q^\downarrow . In what follows we will work with sets Q_0 , Q_1 , and Q_2 (see Figure 9).

Furthermore, we construct a set of edges $R \subseteq E(\Pi)$ as follows: for every two nodes $q_1, q_2 \in Q_2$ that are consecutive on Π (i.e., no node of Π between them belongs to Q_2), we add to R an edge e of the subpath of Π between q_1 and q_2 that minimizes $|\text{ADH}(e) \cap A|$ (see Figure 10).

We define the set

$$Z := A \cap \left(Z_2 \cup \bigcup_{e \in R} \text{ADH}(e) \right).$$

Since every clique in G° has size $\mathcal{O}(k|M|^3)$ (by Reduction 3), we have $|Q_i| = \mathcal{O}(k^i|M|^{3i})$ and $|Z_i| = \mathcal{O}(k^{i+1}|M|^{3i+3})$ for every fixed i , and, consequently, $|Z| = \mathcal{O}(k^3|M|^9)$.

An important property of the set Q_1 is the following.

Claim 12. *Let H be a permitted hole containing a vertex $v \in A \setminus Z_1$. Then both neighbors of the vertex v on the hole H lie in A as well. In particular, if P is the path obtained from Claim 11 for H and v , then v is not adjacent to either of the endpoints of the path P .*

Proof. We apply Claim 11 to the hole H with vertex v , obtaining a path P with endpoints $u^\uparrow \in \beta(q^\uparrow)$ and $w^\downarrow \in \beta(q^\downarrow)$, and a node $s \in V(\Pi) \cap \beta^{-1}(v)$. Note that $s \notin Q_1$. Let s^\uparrow be the first node of Q_1 encountered if we traverse Π from s in the direction of q^\uparrow , and similarly define s^\downarrow (recall that $q^\uparrow, q^\downarrow \in Q_1$, so these nodes are well-defined).

The crucial observation, stemming from the definition of Q_1 , is that the bag of every node of $V(\Pi) \cap \beta^{-1}(v)$ contains exactly the same subset of vertices of Z_0 . Furthermore, this subset of vertices forms a clique in G° , as they appear together in $\beta(s)$. By Claim 11, each neighbor w of v on P lies in $A \cup Z_0$. We have that $\beta^{-1}(w)$ contains a node of $V(\Pi)$: this follows from Claim 11 if $w \in A$ and for $w \in Z_0$ it follows from the facts that $w \in \beta(q^\uparrow) \cup \beta(q^\downarrow)$ and w is adjacent to $v \in A$. Furthermore, since w is adjacent to v , we have that $\beta^{-1}(w)$ actually needs to contain a vertex of $V(\Pi) \cap \beta^{-1}(v)$. Consequently, every neighbor $w \in N(v) \cap Z_0$ is equal or adjacent to both neighbors of v on P , which implies that w cannot lie on P . \lrcorner

9.3 Vertices outside Z can be made undeletable

Our goal now is to show the following lemma that says that the vertices of $A \setminus Z$ can be made undeletable. In the following, Δ denotes symmetric difference.

Lemma 6. *For every solution X to (G, k, M, E^h) there exists a solution X' with $|X'| \leq |X|$, $X \Delta X' \subseteq A$, and $X' \cap A \subseteq Z$.*

Proof. Assume the contrary, and let X be a counterexample with minimum number of vertices from $A \setminus Z$. Let $v \in X \cap (A \setminus Z)$. By the minimality of X , we have that $G - (X \setminus \{v\})$ contains a hole H passing through v . Since X is a solution to (G, k, M, E^h) and $v \notin M$, this hole is permitted. We apply Claim 11: let P be a subpath of H whose existence is asserted in the second claim, and let $r \in \beta^{-1}(v) \cap V(\Pi)$.

Let x be an arbitrary vertex of $V(H) \cap M$. Note that by Claim 11 we have $vx \notin E(G)$ and, consequently, by Observation 6, $A \cap N(x) = \emptyset$.

Since $v \notin Z$ we have $\beta^{-1}(v) \cap Q_2 = \emptyset$, and in particular $r \notin Q_2$. Let r^\uparrow be the first vertex of Q_2 encountered if we traverse Π from r in the direction of q^\uparrow , and similarly define r^\downarrow (recall that $q^\uparrow, q^\downarrow \in Q_2$, so these nodes are well-defined). We claim the following:

Claim 13. *X contains $\text{ADH}(e_X) \cap A$ for some edge e_X that lies on Π between r^\uparrow and r^\downarrow .*

Proof. Assume the contrary. Construct a set $B \subseteq A \setminus X$ as follows: for every edge e that lies on Π between r^\uparrow and r^\downarrow , insert into B an arbitrary vertex of $\text{ADH}(e) \cap (A \setminus X)$. Since every bag of T is a clique, $G[B]$ is connected.

Let P^\uparrow be the subpath of P between v and the endpoint of P in $\beta(q^\uparrow)$ and P^\downarrow be the subpath of P between v and the endpoint of P in $\beta(q^\downarrow)$. Since r^\uparrow lies on the unique path in T between $\beta^{-1}(v)$ and q^\uparrow , P^\uparrow contains a vertex $w^\uparrow \in \beta(r^\uparrow)$; note that $w^\uparrow \neq v$ as $v \notin \beta(r^\uparrow)$. Similarly define $w^\downarrow \in \beta(r^\downarrow)$. By the construction of B , $w^\uparrow, w^\downarrow \in N[B]$.

We infer that $G[V(H) \setminus \{v\} \cup B]$ contains a walk between the neighbors of x on the hole H with internal vertices in $V(G) \setminus N[x]$ (recall that $B \subseteq A$ and $A \cap N[x] = \emptyset$). By Observation 4, $G - X$ contains a hole, which is easily seen to be permitted; a contradiction. \lrcorner

By construction of R in the beginning of §9.2, there is an edge e on R that lies between $r^\uparrow, r^\downarrow \in Q_2$ on Π . Let $X' = (X \setminus (\text{ADH}(e_X) \cap A)) \cup (\text{ADH}(e) \cap A)$, where the edge e_X is given by Claim 13. By the choice of e in the process of constructing R , we have $|X'| \leq |X|$. Clearly, also $X \Delta X' \subseteq A$. Since $\text{ADH}(e \in R) \cap A \subseteq Z$, to prove that X' contains strictly less vertices of $A \setminus Z$ than X it suffices to show the following.

Claim 14. *If e_X is an edge whose existence is asserted by Claim 13, then $v \in \text{ADH}(e_X)$.*

Proof. By Claim 12 for H and v , neither u^\uparrow nor w^\downarrow is adjacent to v , in particular, they do not belong to $\beta(r)$. By the definition of Q_1 , neither of them belongs to any bag on Π between r^\uparrow and r^\downarrow , exclusive.

Consequently, $u^\uparrow, w^\downarrow \notin \text{ADH}(e_X)$ and thus P contains a vertex of $\text{ADH}(e_X) \cap A$. Since H is a hole in $G - (X \setminus \{v\})$, and $\text{ADH}(e_X) \cap A \subseteq X$, this vertex is the vertex v . \lrcorner

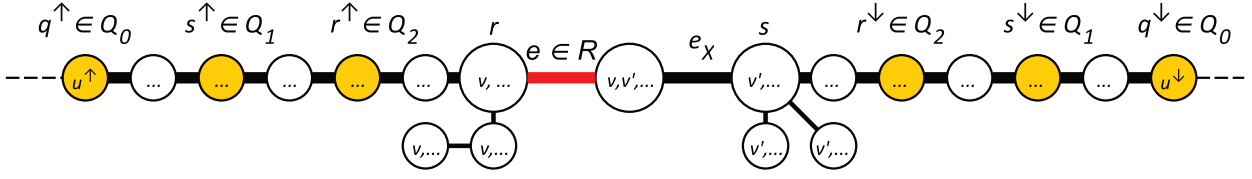

Figure 11: Illustration of the situation for Claim 15. The set $Q_2 \supseteq Q_1 \supseteq Q_0$ on the $q^\uparrow q^\downarrow$ -path Π is drawn in yellow. A marked edge $e \in R$ between r^\uparrow and r^\downarrow is drawn in red. An edge e_X for which $\text{ADH}(e_X) \cap A \subseteq X$ is also shown.

To reach a contradiction, it remains to show that X' is a solution to (G, k, M, E^h) as well. Since $X \triangle X' \subseteq A$, X' satisfies all the constraints imposed by the set E^h . Thus, it remains to prove that $G - X'$ is chordal. Assume the contrary, and let H' be a hole in $G - X'$.

Since $G - X$ is chordal, H' needs to contain a vertex $v' \in A \cap (\text{ADH}(e_X) \setminus \text{ADH}(e))$. Since e and e_X are edges of Π between two consecutive vertices of Q_2 (namely, r^\uparrow and r^\downarrow), it follows from the definition of Q_2 that $\text{ADH}(e) \cap Z_1 = \text{ADH}(e_X) \cap Z_1$. We infer that $v' \notin Z_1$. Refer to Figure 11 for an illustration.

We apply Claim 11 to the hole H' with vertex v' , obtaining a path P' with endpoints $u^\uparrow \in \beta(q^\uparrow)$ and $u^\downarrow \in \beta(q^\downarrow)$, and a node $s \in V(\Pi) \cap \beta^{-1}(v')$. Note that $s \notin Q_1$. Let s^\uparrow be the first node of Q_1 encountered if we traverse Π from s in the direction of q^\uparrow , and similarly define s^\downarrow (recall that $q^\uparrow, q^\downarrow \in Q_1$, so these nodes are well-defined). Observe that since $v' \in \text{ADH}(e_X)$, but $s^\uparrow, s^\downarrow \notin \beta^{-1}(v')$, we have that $r^\uparrow, r^\downarrow, e$, and e_X lie on the subpath of Π between s^\uparrow and s^\downarrow ; possibly $r^\uparrow = s^\uparrow$ or $r^\downarrow = s^\downarrow$. We now show the following corollary of Claim 12.

Claim 15. *The vertex u^\uparrow is not present in any bag on Π between s^\uparrow (exclusive) and q^\downarrow (inclusive), i.e., $\beta^{-1}(u^\uparrow) \cap V(\Pi)$ is contained in the subpath of Π between s^\uparrow and q^\uparrow . Symmetrically, the vertex u^\downarrow is not present in any bag on Π between s^\downarrow (exclusive) and q^\uparrow (inclusive), i.e., $\beta^{-1}(u^\downarrow) \cap V(\Pi)$ is contained in the subpath of Π between s^\downarrow and q^\downarrow .*

Proof. By Claim 12 for H' and $v' \notin Z_1$, neither u^\uparrow nor u^\downarrow is adjacent to v' , in particular, they do not belong to $\beta(s)$. By the definition of Q_1 , neither of them belongs to any bag on Π between s^\uparrow and s^\downarrow , exclusive. The statement for u^\uparrow follows from the fact that $\beta^{-1}(u^\uparrow) \cap V(\Pi)$ is connected and contains q^\uparrow , and similarly for u^\downarrow . \square

Since all internal vertices of P' lie in A , from Claim 15 it follows that P' needs to contain a vertex of $\text{ADH}(e) \cap A$, as e lies between s^\uparrow and s^\downarrow on Π . Consequently, P' is hit by X' , a contradiction. This concludes the proof of the lemma. \square

9.4 Reducing $A \setminus Z$

Our goal now is to reduce $A \setminus Z$. While by Lemma 6 we know that in a yes-instance there is a solution disjoint with $A \setminus Z$, we need to be careful as some permitted holes may contain vertices from $A \setminus Z$. We first filter out a simple case.

Observation 7. Any vertex of $A \setminus \bigcup_{q \in V(\Pi)} \beta(q)$ is irrelevant.

Proof. Let $v \in A \setminus \bigcup_{q \in V(\Pi)} \beta(q)$. By Claim 11, no permitted hole passes through v . Consequently, any solution X to $(G - v, k, M, E^h)$ is a solution to (G, k, M, E^h) as well: as $v \notin M$, X satisfies all constraints imposed by E^h , while G and $G - v$ contain the same permitted holes. \square

This allows us to formulate the following reduction rule.

Reduction 6. If $A \setminus \bigcup_{q \in V(\Pi)} \beta(q)$ is nonempty, remove any vertex from this set.

Other vertices of $A \setminus Z$ need to be handled differently. For a vertex $v \in V(G)$, by *bypassing the vertex* v we mean the following operation: we first turn $N_G(v)$ into a clique, and then delete v from G . We first observe that bypassing a vertex preserves being chordal.

Observation 8. A graph constructed from a chordal graph by bypassing a vertex is chordal as well.

Proof. Let G_1 be a chordal graph with clique tree (T_1, β_1) , let $v \in V(G_1)$, and let G_2 be constructed from G_1 by bypassing v . Consider the following tree decomposition (T_2, β_2) : we take $T_2 = T_1$ and then, for every $p \in V(T_2)$ we put $\beta_2(p) = N(v)$ if $v \in \beta_1(p)$ and $\beta_2(p) = \beta_1(p)$ otherwise. A direct check shows that (T_2, β_2) is a tree decomposition of G_2 in which every bag induces a clique. Thus, G_2 is chordal, as claimed. \square

Lemma 7. *Assume all previous reductions are inapplicable. Let $v \in A \setminus Z$ and let G' be constructed from G by first turning $N_G(v)$ into a clique, and then removing the vertex v . Then the instances (G, k, M, E^h) and (G', k, M, E^h) are equivalent.*

Proof. In one direction, assume (G, k, M, E^h) is a yes-instance. Lemma 6 asserts that there exists a solution X that does not contain v . Observation 8, applied to $G - X$ and vertex v implies that $G' - X$ is chordal as well. Consequently, X is a solution to (G', k, M, E^h) as well.

The other direction is significantly more involved. Intuitively, we want to rely on Claim 12 to show that v can only interact with permitted holes “locally”, and thus any permitted hole in G has its counterpart in G' : possibly shorter but still being a hole. We start with showing that the new edges in G' are actually only in $G[A]$.

Claim 16. *If u, w are two distinct nonadjacent neighbors of v in G , then $u, w \in A \setminus Z_1$.*

Proof. Pick u, w as in the statement. Observation 6 implies that $u, w \notin M$. Since Reduction 6 is not applicable to v , there exists $r \in \beta^{-1}(v) \cap V(\Pi)$. Since $v \notin Z$, we have $r \notin Q_2$. Let r^\uparrow be the first vertex of Q_2 encountered if we traverse Π from r in the direction of q^\uparrow , and similarly define r^\downarrow (recall that $q^\uparrow, q^\downarrow \in Q_2$, so these nodes are well-defined).

By contradiction, assume $u \in Z_1$. Note that all nodes of $\beta^{-1}(v) \cap V(\Pi)$ lie on Π between r^\uparrow and r^\downarrow , exclusive. By the definition of Q_2 , every the bag at every node of $\beta^{-1}(v) \cap V(\Pi)$ contains exactly the same subset of Z_1 ; in particular, it contains u . Since Reduction 6 does not apply to w , w is present in some bag on Π ; since $vw \in E(G)$, w is present in some bag of $\beta^{-1}(v) \cap V(\Pi)$. We infer that u and w meet in some bag of $\beta^{-1}(v) \cap V(\Pi)$, a contradiction to the assumption that they are nonadjacent. \lrcorner

Assume now (G', k, M, E^h) is a yes-instance, and let X be a solution. We claim that X is a solution to (G, k, M, E^h) as well; clearly it satisfies all the constraints imposed by E^h . By contradiction, let H be a hole in $G - X$; clearly, H is permitted. Since H is not a hole in $G' - X$, it contains either the vertex v or one of the edges of $E(G') \setminus E(G)$ is a chord of H in $G' - X$. We infer that in both cases H contains a vertex $w \in A \setminus Z_1$: in the first case we take $w = v$, in the second case it follows from Claim 16.

We apply Claim 11 to the hole H and the vertex w , obtaining a path P with endpoints $u^\uparrow \in \beta(q^\uparrow)$ and $u^\downarrow \in \beta(q^\downarrow)$. By the construction of G' , the subgraph $G'[V(P) \setminus \{v\}]$ is connected. By Claim 12, the vertex w is nonadjacent to neither u^\uparrow nor u^\downarrow , thus $u^\uparrow u^\downarrow \notin E(G')$ and the shortest path P' between u^\uparrow and u^\downarrow in $G'[V(P) \setminus \{v\}]$ is of length at least two. We infer that if we replace P with P' on the hole H , we obtain a hole in $G' - X$, a contradiction. \square

Lemma 7 justifies the following reduction rule.

Reduction 7. If there exists a vertex $v \in A \setminus Z$, bypass then v .

To conclude, observe that if the reductions introduced in this section are inapplicable, we have $|A| = \mathcal{O}(k^3|M|^9)$ for every connected component A of $G - (M \cup S_Q) = G^\circ - S_Q$. Since Proposition 7 shows that the number of such components is bounded by $\mathcal{O}(k^{13}|M|^{20})$ after exhaustive applications of all the reduction rules and $|S_Q| \in \mathcal{O}(k^6|M|^{10})$, we obtain a final size bound of $\mathcal{O}(k^{16}|M|^{29})$ vertices in an exhaustively reduced instance. All reduction rules can be applied in polynomial time. Each application either reduces the number of vertices, or adds an edge to the graph. It follows that an instance can be exhaustively reduced by $\mathcal{O}(|V(G)| + |E(G)|)$ applications of a reduction rule, which means the entire kernelization runs in polynomial time. This concludes the proof of Theorem 3.

10 Approximation algorithm

This section is devoted to the proof of Theorem 2. We start with an informal overview. Let (G, k) be a CHVD instance. First, we can assume that $\log n \leq k \log k$, as otherwise the algorithm of Cao and Marx [18] solves (G, k) in polynomial time.

We observe that in a yes-instance there exists a balanced vertex separator that consists of a clique and at most k vertices. To this end, it suffices to take a minimum solution and a “central” maximal clique of the remaining chordal graph. We can find an approximate variant of such a balanced vertex cut in the following fashion. Since we can assume that G is C_4 -free (e.g., by greedily deleting whole C_4 ’s in G), it has $\mathcal{O}(n^2)$ maximal cliques [24, Proposition 2]. We iterate over all choices of a maximal clique K in G , and apply the approximation algorithm for balanced vertex cut of [25] to $G - K$. In this manner, we can always find a balanced vertex cut in G consisting of a clique and $\mathcal{O}(k\sqrt{\log k})$ vertices.

We iteratively apply the above partitioning algorithm to a connected component of G that is not chordal, and remove the output cut. A simple charging argument shows that in a yes-instance such a procedure finishes after $\ell = \mathcal{O}(k \log n)$ steps. In the end, we obtain a partition

$$V(G) = A_0 \uplus K_1 \uplus K_2 \uplus \dots \uplus K_\ell \uplus X_0,$$

where $G[A_0]$ is chordal, every K_i is a clique, and $|X_0| = \mathcal{O}(\ell k \sqrt{\log k})$. We put X_0 into the solution we are constructing. To obtain the desired approximation algorithm, it is sufficient to tackle the special case where we are given a partition $V(G) = A \uplus B$, where $G[A]$ is chordal and B is a clique in G . We can initially apply an algorithm for this special case to the graph $G[A_0 \uplus K_1]$, obtaining a solution X_1 . We apply it again to $G[(A_0 \uplus K_1) - X_1] \uplus K_2$ to obtain X_2 , and then we repeat. After ℓ iterations of finding an approximate solution and adding back the next clique, we have found an approximate solution to the original input.

To find an approximate solution in the mentioned special case, we again apply the balanced partitioning approach, but with a different toolbox. Let L be a “central” maximal clique of $G[A]$, that is, a maximal clique such that every connected component of $G[A \setminus L]$ is of size at most $|A|/2$. If we find a small (bounded polynomially in the value of an LP relaxation) set of vertices that hits all holes passing through L , then we can delete such a set, discard L (as no holes now pass through L) and recurse on connected components of remaining graph.

Thus, we can now focus only on holes passing through L . We obtain an orientation G^\downarrow of G as follows: we root a clique tree of $G[A]$ in L , and orient every edge of G “downwards”, that is, $uv \in E(G)$ becomes $(u, v) \in E(G^\downarrow)$ if $\text{TOP}(u)$ is an ancestor of $\text{TOP}(v)$, breaking ties arbitrarily for $\text{TOP}(u) = \text{TOP}(v)$. We argue that the task of hitting all holes passing through L can be reduced to a MULTICUT instance in G^\downarrow , and we apply an approximation algorithm of Gupta [36] to find a small solution.

The rest of this section is organized as follows. First, in Section 10.1 we recall the definition of the MULTICUT problem, and formally define LP relaxations of MULTICUT and CHVD. We also recall the approximation algorithm of Gupta [36] that we will use. In Section 10.2 we focus on approximating CHVD in a special case of graphs G where $V(G)$ partitions into $A \uplus B$ such that $G[A]$ is chordal and B is a clique. Finally, we wrap up the approximation algorithm in Section 10.3.

10.1 Multicut and LP relaxations

An instance of the MULTICUT problem consists of a directed graph G and a family $\mathcal{T} \subseteq V(G) \times V(G)$ of *terminal pairs*. A set $X \subseteq V(G)$ is a feasible solution to a multicut instance (G, \mathcal{T}) if, for every $(s, t) \in \mathcal{T}$, there is no path from s to t in $G - X$. The MULTICUT problem asks for a feasible solution of minimum cardinality. That is, we focus on the unweighted node-deletion variant of MULTICUT, and note that the set X may contain terminals.

Given a MULTICUT instance (G, \mathcal{T}) , a *fractional solution* is a function $\mathbf{x}^* : V(G) \rightarrow [0, +\infty)$ such that for every $(s, t) \in \mathcal{T}$ and every path P from s to t in G , we have

$$\mathbf{x}^*(P) := \sum_{v \in V(P)} \mathbf{x}^*(v) \geq 1.$$

The equation above is a linear constraint on values of \mathbf{x}^* that defines the polytope of fractional solutions. Clearly, a feasible solution to the MULTICUT instance (G, \mathcal{T}) induces a fractional solution that assigns

1 to the vertices of the solution. Furthermore, the separation oracle of the aforementioned polytope is straightforward to implement by a shortest-path algorithm such as Dijkstra's. Consequently, using the ellipsoid method, in polynomial time we can find a fractional solution of total value arbitrarily close to minimum possible.

Very similarly we define a fractional solution to CHVD on an undirected graph G : it is a function $\mathbf{x}^* : V(G) \rightarrow [0, +\infty)$ such that for every hole H in G we have

$$\mathbf{x}^*(H) := \sum_{v \in V(H)} \mathbf{x}^*(v) \geq 1.$$

Again, the equation above defines a polytope containing all feasible solutions to CHVD on G , and there is a simple separation oracle for this polytope.¹

For a fractional solution \mathbf{x}^* (either to MULTICUT or CHVD), we use the notation $\mathbf{x}^*(X)$ for a vertex set $X \subseteq V(G)$ for $\sum_{v \in X} \mathbf{x}^*(v)$. Furthermore, we use $|\mathbf{x}^*|$ for $\mathbf{x}^*(V(G))$ and $\mathbf{x}^*(H) = \mathbf{x}^*(V(H))$ for a subgraph H of G (e.g., a path).

MULTICUT is NP-hard even in undirected graphs with three terminal pairs [20]. The best known approximation ratio for undirected graphs is $\mathcal{O}(\log n)$ [32], but for general directed graphs only $\mathcal{O}(\sqrt{n})$ -approximation is known [36]. We will need the following result from the work of Gupta [36].

Theorem 4 ([36]). *Given a MULTICUT instance (G, \mathcal{T}) and a fractional solution \mathbf{x}^* , one can compute in polynomial time an integral solution of size $\mathcal{O}(|\mathbf{x}^*|^2)$.*

Although [36] tackles the edge-deletion variant of MULTICUT, note that in directed graphs the edge- and node-deletion variants are equivalent via standard reductions.

Finally, we will frequently need the following observation

Observation 9 ([35, Theorem 1]). For every graph G , its tree decomposition (T, β) , and a function $f : V(G) \rightarrow \mathbb{R}_{\geq 0}$, there exists a bag $t \in V(T)$ such that every connected component C of $G - \beta(t)$ satisfies $f(V(C)) \leq f(V(G))/2$. In particular, for every chordal graph G and a function $f : V(G) \rightarrow \mathbb{R}_{\geq 0}$ there exists a maximal clique X in G such that every connected component C of $G - X$ satisfies $f(V(C)) \leq f(V(G))/2$.

10.2 Adding a clique to a chordal graph

In this section we develop an approximation algorithm for the following special case.

Lemma 8. *Assume we are given a graph G , a fractional solution \mathbf{x}^* to CHVD on G , and a partition $V(G) = A \uplus B$, such that $G[A]$ is chordal and $G[B]$ is complete. Then one can in polynomial time find an integral solution to CHVD on G of size $\mathcal{O}(|\mathbf{x}^*|^2 \log |\mathbf{x}^*|)$.*

As an intermediate step towards Lemma 8, we show the following.

Lemma 9. *Let G , \mathbf{x}^* , A , and B be as in the statement of Lemma 8. Furthermore, let L be a maximal clique of $G[A]$. Furthermore, assume that $\mathbf{x}^*(v) = 0$ for every $v \in B$ and $\mathbf{x}^*(v) < 1/10$ for every $v \in A$. Then one can in polynomial time find a set $X \subseteq V(G)$ of size at most $\mathcal{O}(|\mathbf{x}^*|^2)$ such that $G - X$ does not contain a hole passing through L .*

Proof. We fix a clique tree (T, β) of $G[A]$, and root it in a node root with $\beta(\text{root}) = L$. We define a partial order \preceq_0 on A as $v \prec_0 u$ if $\text{TOP}(v)$ is an ancestor of $\text{TOP}(u)$, and pick \preceq to be an arbitrary total order extending \preceq_0 . We obtain an orientation G^\downarrow of $G[A]$ by orienting the edges of G so that \preceq becomes a topological ordering of G^\downarrow (i.e., we orient $uv \in E(G)$ as (u, v) if $u \preceq v$). In G^\downarrow , we define a distance measure $\text{dist}_{G^\downarrow, \mathbf{x}^*}$ as distances with respect to the cost function \mathbf{x}^* ; that is, $\text{dist}_{G^\downarrow, \mathbf{x}^*}(u, v)$ is the minimum value of $\mathbf{x}^*(P)$ over all uv -paths P in G^\downarrow . Finally, we define

$$\mathcal{T} = \{(u, v) \in A \times A : \text{dist}_{G^\downarrow, \mathbf{x}^*}(u, v) \geq 1/10\}.$$

Clearly, $10\mathbf{x}^*$ is a fractional solution to the MULTICUT instance $(G^\downarrow, \mathcal{T})$. By applying the algorithm of Theorem 4, we obtain a set $X \subseteq V(G)$ of size $\mathcal{O}(|\mathbf{x}^*|^2)$ that is a solution to MULTICUT on $(G^\downarrow, \mathcal{T})$.

¹Iterate over all possibilities of three consecutive vertices v_1, v_2, v_3 on the hole H , and compute the shortest path from v_1 to v_3 in $G - N[v_2]$ with respect to the distances defined by the current values of \mathbf{x}^* .

To finish the proof of the lemma, it suffices to show that X is also good for our purposes, that is, $G - X$ does not contain any hole passing through L .

Assume the contrary, and let H be any such hole in $G - X$. Since $G[A]$ is chordal, H contains at least one vertex of B . Since both L and B are cliques in G , H contains at most two vertices of each of these cliques. Consequently, there exists a unique decomposition of H into two paths P^1, P^2 , such that every path P^i has an endpoint $x^i \in L$, and endpoint $y^i \in B$, and all internal vertices in $A \setminus L$. We have $V(P^1) \cup V(P^2) = V(H)$. Note that it is possible that $x^1 = x^2$ or $y^1 = y^2$.

Let u, v be two consecutive internal vertices on P^i , such that u is closer to x^i on P^i than v . Observe that $\text{TOP}(u)$ is an ancestor of $\text{TOP}(v)$, as otherwise v is adjacent in G to the predecessor of u on P^i , a contradiction to the assumption that H is a hole. Consequently, $P^i - \{x^i, y^i\}$ is a directed path in G^\downarrow .

Let u_j^i be the j -th internal vertex on P^i starting from x^i , that is, the consecutive vertices on P^i are $x^i, u_1^i, u_2^i, \dots, u_{\ell^i}^i, y^i$, where $\ell^i = |P^i| - 1$.

Since X is a multicut for terminals \mathcal{T} and $P^i - \{x^i, y^i\}$ is a directed path in $G^\downarrow - X$ for $i \in \{1, 2\}$, for any $1 \leq a < b \leq \ell^i$ the pair (u_a^i, u_b^i) is not a terminal pair. By definition of \mathcal{T} , this implies that there is a path P in G^\downarrow from u_a^i to u_b^i with $\mathbf{x}^*(P) < 1/10$. We define two alternative paths \hat{P}^i to derive a contradiction. If P^i has at most two internal vertices, then $\hat{P}^i := P^i$. Otherwise, define \hat{P}^i as (x^i, u_1^i, Q^i, y^i) where Q^i is a path in G^\downarrow from u_2^i to $u_{\ell^i}^i$ with $\mathbf{x}^*(Q^i) < 1/10$. No vertex on Q^i is adjacent to x^1 in G : since u_2^i is not adjacent to x^1 on the hole H , we know u_2^i and x^1 do not occur in a common bag. This implies that x^1 , which is in the root bag, does not belong to $\text{TOP}(u_2^i)$ and does not occur in the subtree rooted there; all vertices that can be reached from u_2^i in G^\downarrow have root bags that are descendants of $\text{TOP}(u_2^i)$.

The concatenation of \hat{P}^1 with \hat{P}^2 forms a (possibly nonsimple) walk in G that visits x^1 exactly once. Consider the walk W obtained by removing x^1 from this cycle. It connects the successor of x^1 on H to the predecessor of x^1 on H . All internal vertices of the walk are nonadjacent to x^1 , which follows from our claims on Q^i and the fact that H is a hole. Hence we can shortcut W to an induced path P connecting the predecessor and successor of x^1 on H , to obtain a hole H' in G . Since $\mathbf{x}^*(v) < 1/10$ for each vertex $v \in G$, and $\mathbf{x}^*(Q^i) < 1/10$, it follows that $\mathbf{x}^*(\hat{P}^i) < 3/10 + 1/10 = 4/10$. Hence $\mathbf{x}^*(H') < 8/10 < 1$, a contradiction to the assumption that \mathbf{x}^* is a fractional solution to CHVD on G . \square

Proof of Lemma 8. First, we take $X_0 = \{v \in V(G) : \mathbf{x}^*(v) \geq 1/20\}$, put X_0 into the solution we are constructing, and delete X_0 from the graph. Clearly, $|X_0| \leq 20|\mathbf{x}^*|$; from this point, we can assume that $\mathbf{x}^*(v) < 1/20$ for every $v \in V(G)$.

Second, we modify $\mathbf{x}^*(v)$ as follows: we put $\mathbf{x}_2^*(v) := 2\mathbf{x}^*(v)$ for every $v \in A$ and $\mathbf{x}_2^*(v) := 0$ for every $v \in B$. Since $\mathbf{x}^*(v) < 1/20$ for every $v \in V(G)$, the length of the shortest hole in G is at least 21, while at most two vertices of such a hole can lie in the clique $G[B]$. Consequently, \mathbf{x}_2^* is a fractional solution to CHVD on G with the additional properties that $\mathbf{x}_2^*(v) = 0$ for every $v \in B$ and $\mathbf{x}_2^*(v) < 1/10$ for every $v \in A$.

We now perform the following iterative procedure. Let \mathcal{C} be the set of connected components of $G[A]$. We pick a component $C \in \mathcal{C}$ with largest value $\mathbf{x}_2^*(C)$. If $\mathbf{x}_2^*(C) < 1$, we infer that $G[C \cup B]$ is chordal; by the choice of C , this implies that the entire graph G is chordal, and we are done. Otherwise, let L be a maximal clique of $G[C]$ such that $\mathbf{x}_2^*(D) \leq \mathbf{x}_2^*(C)/2$ for every connected component of $G[C] - L$ (Observation 9). We apply the algorithm of Lemma 9 to $G[C \cup B]$ with partition $C \uplus B$, the clique L , and a fractional solution $\mathbf{x}_2^*|_C$, obtaining a solution X_C of size $\mathcal{O}(\mathbf{x}_2^*(C)^2)$. We put X_C into the solution we are constructing, and delete it from the graph. At this point, no hole in G passes through L ; we delete L from the graph as well.

Consider a vertex $v \in C \setminus (L \cup X_C)$ after this step. Let D be a connected component of $G[A]$ containing v . Since we deleted the entire clique L , we have $\mathbf{x}_2^*(D) \leq \mathbf{x}_2^*(C)/2$. Consequently, every vertex v can be contained in a component C chosen by the algorithm at most $\lceil \log(1 + |\mathbf{x}_2^*|) \rceil$ times. Whenever an algorithm considers a component C , we charge a cost of $\mathcal{O}(\mathbf{x}_2^*(v)|\mathbf{x}_2^*|)$ to every vertex $v \in C$. Since the set X_C is of size $\mathcal{O}(\mathbf{x}_2^*(C)^2) \leq \mathcal{O}(\mathbf{x}_2^*(C)|\mathbf{x}_2^*|)$, the total size of all sets X_C in the course of the algorithm is bounded by the total charge. On the other hand, by the previous argument, every vertex v is charged a value of $\mathcal{O}(\mathbf{x}_2^*(v)|\mathbf{x}_2^*| \log |\mathbf{x}_2^*|)$. Consequently, the total size of all sets X_C is $\mathcal{O}(|\mathbf{x}_2^*|^2 \log |\mathbf{x}_2^*|)$. \square

10.3 The approximation algorithm

Let (G, k) be a CHVD instance. Our main goal in this section is to show that, after deleting a small number of vertices from G , we can decompose $V(G)$ into a chordal graph and a small number of cliques. Then, we can use Lemma 8 to add these cliques to the chordal graph one by one.

We start with a bit of preprocessing. As discussed before, it is straightforward to implement a separation oracle for the LP relaxation of CHVD. Using the ellipsoid method, we can compute a fractional solution \mathbf{x}^* to CHVD on G of cost arbitrarily close to the optimum. For our purposes, a 2-approximation \mathbf{x}^* suffices. If $|\mathbf{x}^*| > 2k$, we conclude that (G, k) is a no-instance. Otherwise, we proceed with \mathbf{x}^* further. We greedily take into the constructed solution and delete from G any vertex v with $\mathbf{x}^*(v) \geq 1/4$; note that there are at most $4|\mathbf{x}^*| \leq 8k$ such vertices. Thus, from this point we can assume that $\mathbf{x}^*(v) < 1/4$ for every $v \in V(G)$; in particular, G is C_4 -free.

Our main partitioning tool is an $\mathcal{O}(\sqrt{\log \text{opt}})$ -approximation algorithm for balanced vertex cut by Feige, Hajiaghayi, and Lee [25]. Given an n -vertex graph G , a *balanced vertex cut* is a set $X \subseteq V(G)$ such that every connected component of $G - X$ has at most $2n/3$ vertices. We use the approximation algorithm of [25] in the following lemma.

Lemma 10. *Given a CHVD instance (G, k) , we can in polynomial time find a set $Z \subseteq V(G)$ and a set $K \subseteq Z$ such that every connected component of $G - Z$ has size at most $3n/4$, $G[K]$ is complete, and $|Z \setminus K| = \mathcal{O}(k\sqrt{\log k})$, or correctly conclude that (G, k) is a no-instance to CHVD.*

Proof. Since G is C_4 -free, G has at most n^2 maximal cliques [24, Proposition 2]. Furthermore, we can enumerate all maximal cliques in G with polynomial delay [51]. If there exists a maximal clique K of size at least $n/4$, we can simply return $Z = K$, as $|V(G) \setminus K| \leq 3n/4$. Otherwise, for every maximal clique K of G , we invoke the approximation algorithm for balanced vertex cut of [25] on the graph $G - K$. If for some clique K the algorithm returns a cut Y of size $\mathcal{O}(k\sqrt{\log k})$, we output $Z := K \cup Y$ and K . Clearly, this output satisfies the desired properties.

It remains to argue that if (G, k) is a yes-instance, then the algorithm finds a desired cut. Let X be a solution to CHVD on G of size at most k . By Observation 9, the chordal graph $G - X$ contains a maximal clique K_0 such that every connected component of $G - (X \cup K_0)$ has at most $(n - |X|)/2 \leq n/2$ vertices. Consider the iteration of the algorithm for a maximal clique $K \supseteq K_0$ in G . Note that X is a balanced cut of $G - K$ of size at most k : every connected component of $G - (X \cup K)$ is of size at most

$$\frac{n}{2} = \frac{2}{3} \cdot \frac{3}{4}n \leq \frac{2}{3}|V(G) \setminus K|.$$

Consequently, for this choice of K , the algorithm of [25] finds a balanced vertex cut of size $\mathcal{O}(k\sqrt{\log k})$. This finishes the proof of the lemma. \square

By iteratively applying Lemma 10, we obtain the following.

Lemma 11. *Given a CHVD instance (G, k) , we can in polynomial time either correctly conclude that it is a no-instance, or find a partition $V(G) = A_0 \uplus K_1 \uplus K_2 \uplus \dots \uplus K_\ell \uplus X_0$ such that $G[A_0]$ is chordal, $G[K_i]$ is complete for every $1 \leq i \leq \ell$, $\ell = \mathcal{O}(k \log n)$, and $|X| = \mathcal{O}(\ell k \sqrt{\log k}) = \mathcal{O}(k^2 \sqrt{\log k} \log n)$.*

Proof. Consider the following iterative procedure. We start with $H := G$, $\ell := 0$, and $X_0 := \emptyset$. As long as H contains a connected component C that is not chordal, we apply the algorithm of Lemma 10 to a CHVD instance (C, k) . In case the algorithm returns that (C, k) is a no-instance, we can return the same answer for (G, k) , as we will maintain the invariant that H is an induced subgraph of G . Otherwise, if a pair (Z, K) is returned, we take K as a next clique K_i , insert $Z \setminus K$ into X_0 , and delete Z from H . The algorithm terminates when H is a chordal graph; we then put $A_0 := V(H)$. Clearly, the algorithm outputs a partition $V(G) = A_0 \uplus K_1 \uplus K_2 \uplus \dots \uplus K_\ell \uplus X_0$ as desired, and $|X| = \mathcal{O}(\ell k \sqrt{\log k})$. It remains to argue that if (G, k) is a yes-instance, then the algorithm always terminates after $\mathcal{O}(k \log n)$ steps, that is, $\ell = \mathcal{O}(k \log n)$.

Consider a solution X to CHVD on (G, k) . Whenever the algorithm applies Lemma 10 to a component C , we have $X \cap V(C) \neq \emptyset$, since C is not chordal. We charge this step of the algorithm to an arbitrarily chosen vertex $v \in X \cap V(C)$. Note that after the algorithm finds $Z \subseteq V(C)$, we have either $v \in Z$ or v lies in a connected component of $C - Z$ of size at most $2|V(C)|/3$. Consequently, every vertex $v \in X$ is charged at most $\log_{3/2} n$ times, and in a yes-instance the algorithm always terminates after $k \log_{3/2} n$

steps. (That is, if it runs longer than expected, we terminate the algorithm and claim that (G, k) is a no-instance.) \square

We can now conclude the proof of Theorem 2. Let (G, k) be a CHVD instance. First, if $\log n > k \log k$, the exact FPT algorithm of Cao and Marx [18] with runtime $2^{\mathcal{O}(k \log k)} \cdot n^{\mathcal{O}(1)}$ actually runs in polynomial time in n , and we can just solve the instance. Otherwise, we apply the algorithm of Lemma 11, either concluding that (G, k) is a no-instance, or finding the partition $V(G) = A_0 \uplus K_1 \uplus K_2 \uplus \dots \uplus K_\ell \uplus X_0$ with $\ell = \mathcal{O}(k \log n) = \mathcal{O}(k^2 \log k)$ and $|X_0| = \mathcal{O}(k^2 \sqrt{\log k} \log n) = \mathcal{O}(k^3 \log^{3/2} k)$. Then, for $i = 1, 2, \dots, \ell$, we construct sets A_i and X_i as follows. We apply the algorithm of Lemma 8 to a graph $G[A_{i-1} \cup K_i]$ with the clique K_i and the fractional solution \mathbf{x}^* restricted to $A_{i-1} \cup K_i$. The algorithm returns a solution X_i to CHVD on $G[A_{i-1} \cup K_i]$ of size $\mathcal{O}(|\mathbf{x}^*|^2 \log |\mathbf{x}^*|) = \mathcal{O}(k^2 \log k)$; we put $A_i := (A_{i-1} \cup K_i) \setminus X_i$.

Note that every $G[A_i]$ is chordal, and

$$V(G) \setminus A_\ell = X_0 \cup X_1 \cup \dots \cup X_\ell.$$

Thus, we can return a solution $X := X_0 \cup X_1 \cup \dots \cup X_\ell$ which is of size

$$|X| = |X_0| + \sum_{i=1}^{\ell} |X_i| = \mathcal{O}(k^3 \log^{3/2} k) + \mathcal{O}(k^2 \log k) \cdot \mathcal{O}(k^2 \log k) = \mathcal{O}(k^4 \log^2 k).$$

This concludes the proof of Theorem 2.

11 Kernelization algorithm

The next theorem summarizes the data reduction procedure for the unannotated problem and shows that the annotations can be simulated by small gadgets.

Theorem. *There is a polynomial-time algorithm that, given an instance (G, k) of CHORDAL VERTEX DELETION and a modulator $M_0 \subseteq V(G)$ such that $G - M_0$ is chordal, outputs an equivalent instance (G', k') with $\mathcal{O}(k^{45} \cdot |M_0|^{29})$ vertices and $k' \leq k$.*

Proof. Given a CHVD instance (G, k) and a modulator M_0 , apply Lemma 2. If it reports that (G, k) is a no-instance, output a constant-size no-instance of CHVD. Otherwise, we obtain an equivalent instance (G', k', M, E^h) of A-CHVD with $k' \leq k$ and $|M| \in \mathcal{O}(k \cdot |M_0|)$. Apply Theorem 3 to (G', k', M, E^h) to obtain an equivalent instance (G'', k', M, F^h) of A-CHVD with $\mathcal{O}(k^{16} |M|^{29}) \in \mathcal{O}(k^{45} |M_0|^{29})$ vertices. To turn this into an instance of the original CHVD problem, we simulate the annotations.

By definition of the annotated problem, we have $xy \in E(G''[M])$ for each pair $\{x, y\} \in F^h$ and therefore $x, y \in M$. For each pair $\{x, y\} \in F^h$, we simulate the annotation by adding two new vertices x', y' and the edges $xx', x'y'$, and $y'y$ to G'' , thereby creating a C_4 . As all holes passing through x' or y' also pass through x and y , there is always a minimum chordal modulator in the resulting graph that does not contain any of the newly added vertices. Moreover, since we introduce a C_4 containing x and y for each annotated pair $\{x, y\} \in F^h$, such solutions hit at least one vertex of each annotated pair. Letting G^* denote the graph resulting from adding such C_4 's for all annotated pairs, we therefore establish that if G^* has a chordal modulator of size k' , then G'' has a solution of size k' that hits all annotated pairs. Conversely, any solution X to the annotated problem on G'' is a chordal deletion set in G^* , since in $G^* - X$ the newly added vertices form a pendant path and are therefore not part of any hole. Consequently, the CHVD instance (G^*, k') is equivalent to the annotated instance and therefore to the original input (G, k) . Since the definition of A-CHVD ensures that we only annotate pairs of vertices from M , we add at most $|M|^2$ vertices. Hence the asymptotic size bound for G^* is dominated by the size of G'' . The pair (G^*, k') is given as the output of the procedure. \square

Combining the previous theorem with our approximation algorithm in Theorem 2, we obtain a polynomial kernel for CHVD. The size bound follows from plugging in $\mathcal{O}(k^4 \log^2 k)$ for the modulator size.

Corollary 1. *CHORDAL VERTEX DELETION has a kernel with $\mathcal{O}(k^{161} \log^{58} k)$ vertices.*

12 Conclusion

We presented a polynomial kernel for CHORDAL VERTEX DELETION based on new graph-theoretic insights and a poly(OPT)-approximation algorithm. Our work raises several questions for future research. The most obvious questions concern the kernel size and the approximation factor; both have room for significant improvements. Since CHVD is a vertex-deletion problem into an efficiently recognizable nontrivial and hereditary graph class, by the results of Dell and van Melkebeek [21] there is no kernel for CHVD that can be encoded in $\mathcal{O}(k^{2-\epsilon})$ bits unless $\text{NP} \subseteq \text{coNP/poly}$. The bound of $\tilde{\mathcal{O}}(k^{161})$ vertices given by Corollary 1 vertices is very far from this, and we expect the optimal kernel to have a size bound with degree at most ten. As Theorem 1 shows, a better approximation ratio will directly translate into a better kernel size.

From a purely graph-theoretical perspective, one could investigate whether Erdős-Pósa type packing/covering duality holds for holes in general graphs, rather than for holes in nearly-chordal graphs as treated in Lemma 1. Is there a function $f: \mathbb{N} \rightarrow \mathbb{N}$ such that for any k , an arbitrary graph G either has at least k vertex-disjoint holes, or has a set of $f(k)$ vertices that intersects all holes? A final open problem is to determine whether the INTERVAL VERTEX DELETION problem admits a polynomial kernel.

References

- [1] A. Agarwal, M. Charikar, K. Makarychev, and Y. Makarychev. $O(\sqrt{\log n})$ approximation algorithms for min UnCut, min 2CNF deletion, and directed cut problems. In *Proc. 37th STOC*, pages 573–581, 2005. doi:10.1145/1060590.1060675.
- [2] V. Bafna, P. Berman, and T. Fujito. A 2-approximation algorithm for the undirected feedback vertex set problem. *SIAM Journal on Discrete Mathematics*, 12(3):289–297, 1999. doi:10.1137/S0895480196305124.
- [3] A. Bar-Noy, R. Bar-Yehuda, A. Freund, J. Naor, and B. Schieber. A unified approach to approximating resource allocation and scheduling. *J. ACM*, 48(5):1069–1090, 2001. doi:10.1145/502102.502107.
- [4] D. Bauer, S. L. Hakimi, and E. F. Schmeichel. Recognizing tough graphs is NP-hard. *Discrete Applied Mathematics*, 28(3):191–195, 1990. doi:10.1016/0166-218X(90)90001-S.
- [5] A. Becker and D. Geiger. Optimization of Pearl’s method of conditioning and greedy-like approximation algorithms for the vertex feedback set problem. *Artificial Intelligence*, 83(1):167–188, 1996. doi:10.1016/0004-3702(95)00004-6.
- [6] I. Bliznets, F. V. Fomin, M. Pilipczuk, and M. Pilipczuk. A subexponential parameterized algorithm for proper interval completion. *SIAM J. Discrete Math.*, 29(4):1961–1987, 2015. doi:10.1137/140988565.
- [7] I. Bliznets, F. V. Fomin, M. Pilipczuk, and M. Pilipczuk. Subexponential parameterized algorithm for interval completion. In R. Krauthgamer, editor, *Proceedings of the Twenty-Seventh Annual ACM-SIAM Symposium on Discrete Algorithms, SODA 2016, Arlington, VA, USA, January 10-12, 2016*, pages 1116–1131. SIAM, 2016. doi:10.1137/1.9781611974331.ch78.
- [8] H. L. Bodlaender. On linear time minor tests with depth-first search. *J. Algorithms*, 14(1):1–23, 1993. doi:10.1006/jagm.1993.1001.
- [9] H. L. Bodlaender, F. V. Fomin, D. Lokshtanov, E. Penninkx, S. Saurabh, and D. M. Thilikos. (Meta) Kernelization. In *50th Annual IEEE Symposium on Foundations of Computer Science, FOCS 2009, October 25-27, 2009, Atlanta, Georgia, USA*, pages 629–638. IEEE Computer Society, 2009. doi:10.1109/FOCS.2009.46.
- [10] H. L. Bodlaender and T. C. van Dijk. A cubic kernel for feedback vertex set and loop cutset. *Theory Comput. Syst.*, 46(3):566–597, 2010.
- [11] A. Brandstädt, V. B. Le, and J. P. Spinrad. *Graph classes: a survey*. Society for Industrial and Applied Mathematics, Philadelphia, PA, USA, 1999.
- [12] P. Buneman. A characterisation of rigid circuit graphs. *Discrete Mathematics*, 9(3):205 – 212, 1974. doi: http://dx.doi.org/10.1016/0012-365X(74)90002-8.
- [13] K. Burrage, V. Estivill-Castro, M. R. Fellows, M. A. Langston, S. Mac, and F. A. Rosamond. The undirected feedback vertex set problem has a poly(k) kernel. In H. L. Bodlaender and M. A. Langston, editors, *Parameterized and Exact Computation, Second International Workshop, IWPEC 2006, Zürich, Switzerland, September 13-15, 2006, Proceedings*, volume 4169 of *Lecture Notes in Computer Science*, pages 192–202. Springer, 2006. doi:10.1007/11847250_18.
- [14] J. F. Buss and J. Goldsmith. Nondeterminism within P. *SIAM J. Comput.*, 22(3):560–572, 1993. doi:10.1137/0222038.

- [15] L. Cai. Parameterized complexity of vertex colouring. *Discrete Appl. Math.*, 127(3):415–429, 2003. doi:[10.1016/S0166-218X\(02\)00242-1](https://doi.org/10.1016/S0166-218X(02)00242-1).
- [16] Y. Cao. Linear recognition of almost interval graphs. In R. Krauthgamer, editor, *Proceedings of the Twenty-Seventh Annual ACM-SIAM Symposium on Discrete Algorithms, SODA 2016, Arlington, VA, USA, January 10-12, 2016*, pages 1096–1115. SIAM, 2016. doi:[10.1137/1.9781611974331.ch77](https://doi.org/10.1137/1.9781611974331.ch77).
- [17] Y. Cao and D. Marx. Interval deletion is fixed-parameter tractable. In C. Chekuri, editor, *Proceedings of the Twenty-Fifth Annual ACM-SIAM Symposium on Discrete Algorithms, SODA 2014, Portland, Oregon, USA, January 5-7, 2014*, pages 122–141. SIAM, 2014. doi:[10.1137/1.9781611973402.9](https://doi.org/10.1137/1.9781611973402.9).
- [18] Y. Cao and D. Marx. Chordal editing is fixed-parameter tractable. *Algorithmica*, pages 1–20, 2015. doi:[10.1007/s00453-015-0014-x](https://doi.org/10.1007/s00453-015-0014-x).
- [19] M. Cygan, L. Kowalik, and M. Pilipczuk. Open problems from workshop on kernels, 2013. URL: <http://worker2013.mimuw.edu.pl/slides/worker-opl.pdf>.
- [20] E. Dahlhaus, D. S. Johnson, C. H. Papadimitriou, P. D. Seymour, and M. Yannakakis. The complexity of multiterminal cuts. *SIAM J. Comput.*, 23(4):864–894, 1994. doi:[10.1137/S0097539792225297](https://doi.org/10.1137/S0097539792225297).
- [21] H. Dell and D. van Melkebeek. Satisfiability allows no nontrivial sparsification unless the polynomial-time hierarchy collapses. *J. ACM*, 61(4):23:1–23:27, 2014. doi:[10.1145/2629620](https://doi.org/10.1145/2629620).
- [22] P. G. Drange, F. V. Fomin, M. Pilipczuk, and Y. Villanger. Exploring the subexponential complexity of completion problems. *TOCT*, 7(4):14, 2015. doi:[10.1145/2799640](https://doi.org/10.1145/2799640).
- [23] P. Erdős and L. Pósa. On independent circuits contained in a graph. *Canad. J. Math.*, 17:347–352, 1965. doi:[10.4153/CJM-1965-035-8](https://doi.org/10.4153/CJM-1965-035-8).
- [24] M. Farber. On diameters and radii of bridged graphs. *Discrete Mathematics*, 73(3):249–260, 1989. doi:[10.1016/0012-365X\(89\)90268-9](https://doi.org/10.1016/0012-365X(89)90268-9).
- [25] U. Feige, M. Hajiaghayi, and J. R. Lee. Improved approximation algorithms for minimum weight vertex separators. *SIAM J. Comput.*, 38(2):629–657, 2008. doi:[10.1137/05064299X](https://doi.org/10.1137/05064299X).
- [26] J. Flum and M. Grohe. *Parameterized Complexity Theory*. Springer-Verlag, 2006.
- [27] F. V. Fomin, B. M. P. Jansen, and M. Pilipczuk. Preprocessing subgraph and minor problems: When does a small vertex cover help? In *Proc. 7th IPEC*, pages 97–108, 2012. doi:[10.1007/978-3-642-33293-7_11](https://doi.org/10.1007/978-3-642-33293-7_11).
- [28] F. V. Fomin, D. Lokshtanov, N. Misra, and S. Saurabh. Planar \mathcal{F} -Deletion: Approximation, kernelization and optimal FPT algorithms. In *Proc. 53rd FOCS*, pages 470–479, 2012. doi:[10.1109/FOCS.2012.62](https://doi.org/10.1109/FOCS.2012.62).
- [29] F. V. Fomin, S. Saurabh, and Y. Villanger. A polynomial kernel for proper interval vertex deletion. *SIAM J. Discrete Math.*, 27(4):1964–1976, 2013. doi:[10.1137/12089051X](https://doi.org/10.1137/12089051X).
- [30] J. Gajarský, P. Hliněný, J. Obdržálek, S. Ordyniak, F. Reidl, P. Rossmanith, F. S. Villaamil, and S. Sikdar. Kernelization using structural parameters on sparse graph classes. In H. L. Bodlaender and G. F. Italiano, editors, *Algorithms - ESA 2013 - 21st Annual European Symposium, Sophia Antipolis, France, September 2-4, 2013. Proceedings*, volume 8125 of *Lecture Notes in Computer Science*, pages 529–540. Springer, 2013. doi:[10.1007/978-3-642-40450-4_45](https://doi.org/10.1007/978-3-642-40450-4_45).
- [31] N. Garg, V. V. Vazirani, and M. Yannakakis. Multiway cuts in directed and node weighted graphs. In *Proc. 21st ICALP*, pages 487–498, 1994.
- [32] N. Garg, V. V. Vazirani, and M. Yannakakis. Approximate max-flow min-(multi)cut theorems and their applications. *SIAM Journal on Computing*, 25(2):235–251, 1996. doi:[10.1137/S0097539793243016](https://doi.org/10.1137/S0097539793243016).
- [33] F. Gavril. Algorithms for minimum coloring, maximum clique, minimum covering by cliques, and maximum independent set of a chordal graph. *SIAM Journal on Computing*, 1(2):180–187, 1972. doi:[10.1137/0201013](https://doi.org/10.1137/0201013).
- [34] A. C. Giannopoulou, B. M. P. Jansen, D. Lokshtanov, and S. Saurabh. Uniform kernelization complexity of hitting forbidden minors. In M. M. Halldórsson, K. Iwama, N. Kobayashi, and B. Speckmann, editors, *Automata, Languages, and Programming - 42nd International Colloquium, ICALP 2015, Kyoto, Japan, July 6-10, 2015, Proceedings, Part I*, volume 9134 of *Lecture Notes in Computer Science*, pages 629–641. Springer, 2015. doi:[10.1007/978-3-662-47672-7_51](https://doi.org/10.1007/978-3-662-47672-7_51).
- [35] J. R. Gilbert, D. J. Rose, and A. Edenbrandt. A separator theorem for chordal graphs. *SIAM Journal on Algebraic and Discrete Methods*, 5(3):306–313, 1984.
- [36] A. Gupta. Improved results for directed multicut. In *Proceedings of the Fourteenth Annual ACM-SIAM Symposium on Discrete Algorithms, January 12-14, 2003, Baltimore, Maryland, USA.*, pages 454–455. ACM/SIAM, 2003. URL: <http://dl.acm.org/citation.cfm?id=644108.644181>.
- [37] P. Heggernes, P. van ’t Hof, B. M. P. Jansen, S. Kratsch, and Y. Villanger. Parameterized complexity of vertex deletion into perfect graph classes. *Theor. Comput. Sci.*, 511:172–180, 2013. doi:[10.1016/j.tcs.2012.03.013](https://doi.org/10.1016/j.tcs.2012.03.013).
- [38] F. Kammer and T. Tholey. The k-disjoint paths problem on chordal graphs. In *Proc. 35th WG*, volume 5911 of *Lecture Notes in Computer Science*, pages 190–201, 2009. doi:[10.1007/978-3-642-11409-0_17](https://doi.org/10.1007/978-3-642-11409-0_17).

- [39] E. J. Kim, A. Langer, C. Paul, F. Reidl, P. Rossmanith, I. Sau, and S. Sikdar. Linear kernels and single-exponential algorithms via protrusion decompositions. In *Proc. 40th ICALP*, pages 613–624, 2013.
- [40] S. Kratsch. Recent developments in kernelization: A survey. *Bulletin of the EATCS*, 113, 2014. URL: <http://eatcs.org/beatcs/index.php/beatcs/article/view/285>.
- [41] S. Kratsch and M. Wahlström. Representative sets and irrelevant vertices: New tools for kernelization. In *Proc. 53rd FOCS*, pages 450–459, 2012. doi:10.1109/FOCS.2012.46.
- [42] S. Kratsch and M. Wahlström. Compression via matroids: A randomized polynomial kernel for odd cycle transversal. *ACM Transactions on Algorithms*, 10(4):20:1–20:15, 2014. doi:10.1145/2635810.
- [43] J. M. Lewis and M. Yannakakis. The node-deletion problem for hereditary properties is NP-complete. *J. Comput. Syst. Sci.*, 20(2):219–230, 1980. doi:10.1016/0022-0000(80)90060-4.
- [44] D. Lokshtanov. Kernelization: An overview. In O. Owe, M. Steffen, and J. A. Telle, editors, *Fundamentals of Computation Theory - 18th International Symposium, FCT 2011, Oslo, Norway, August 22-25, 2011. Proceedings*, volume 6914 of *Lecture Notes in Computer Science*, pages 39–40. Springer, 2011. doi:10.1007/978-3-642-22953-4_3.
- [45] D. Lokshtanov, N. Misra, and S. Saurabh. Kernelization - preprocessing with a guarantee. In H. L. Bodlaender, R. Downey, F. V. Fomin, and D. Marx, editors, *The Multivariate Algorithmic Revolution and Beyond - Essays Dedicated to Michael R. Fellows on the Occasion of His 60th Birthday*, volume 7370 of *Lecture Notes in Computer Science*, pages 129–161. Springer, 2012. doi:10.1007/978-3-642-30891-8_10.
- [46] D. Marx. Chordal deletion is fixed-parameter tractable. In F. V. Fomin, editor, *Graph-Theoretic Concepts in Computer Science, 32nd International Workshop, WG 2006, Bergen, Norway, June 22-24, 2006, Revised Papers*, volume 4271 of *Lecture Notes in Computer Science*, pages 37–48. Springer, 2006. doi:10.1007/11917496_4.
- [47] D. Marx. Chordal deletion is fixed-parameter tractable. *Algorithmica*, 57(4):747–768, 2010. doi:10.1007/s00453-008-9233-8.
- [48] G. Nemhauser and L. Trotter. Vertex packings: structural properties and algorithms. *Math. Program.*, 8:232–248, 1975. doi:10.1007/BF01580444.
- [49] D. J. Rose. A graph-theoretic study of the numerical solution of sparse positive definite systems of linear equations. *Graph theory and computing*, pages 183–217, 1972.
- [50] S. Thomassé. A $4k^2$ kernel for feedback vertex set. *ACM Trans. Algorithms*, 6(2), 2010. doi:10.1145/1721837.1721848.
- [51] S. Tsukiyama, M. Ide, H. Ariyoshi, and I. Shirakawa. A new algorithm for generating all the maximal independent sets. *SIAM J. Comput.*, 6(3):505–517, 1977. doi:10.1137/0206036.
- [52] R. van Bevern, H. Moser, and R. Niedermeier. Approximation and tidying - A problem kernel for s-plex cluster vertex deletion. *Algorithmica*, 62(3-4):930–950, 2012. doi:10.1007/s00453-011-9492-7.
- [53] P. Zhang, E. A. Schon, S. G. Fischer, E. Cayanis, J. Weiss, S. Kistler, and P. E. Bourne. An algorithm based on graph theory for the assembly of contigs in physical mapping of DNA. *Computer Applications in the Biosciences*, 10(3):309–317, 1994. doi:10.1093/bioinformatics/10.3.309.