

SHADOWS OF 4-MANIFOLDS WITH COMPLEXITY ZERO AND POLYHEDRAL COLLAPSING

HIRONOBU NAOE

ABSTRACT. Our purpose is to classify acyclic 4-manifolds having shadow complexity zero. In this paper, we focus on simple polyhedra and discuss this problem combinatorially. We consider a shadowed polyhedron X and a simple polyhedron X_0 that is obtained by collapsing from X . Then we prove that there exists a canonical way to equip internal regions of X_0 with gleams so that two 4-manifolds reconstructed from X_0 and X are diffeomorphic. We also show that any acyclic simple polyhedron whose singular set is a union of circles can collapse onto a disk. As a consequence of these results, we prove that any acyclic 4-manifold having shadow complexity zero with boundary is diffeomorphic to a 4-ball.

INTRODUCTION

In 1990s Turaev introduced the notion of *shadows* of 3- and 4-manifolds with the intention of studying quantum invariants of knots and 3-manifolds. A simple polyhedron X is called a *shadow* of a 4-manifold M if M collapses onto X and X is embedded properly and locally-flat in M . As it is well-known, M can be reconstructed from X and an appropriate decoration of its regions with some half-integers called *gleams*. It is called Turaev's reconstruction. Shadows provide many geometric properties of 3- and 4-manifolds. We refer the reader to Costantino [3, 4] for studies of Stein structures, Spin^c structures and complex structures of 4-manifolds. In [5] Costantino and Thurston established the relation between shadows and Stein factorizations of stable maps from 3-manifolds into \mathbb{R}^2 . Consequently they observed the relation between hyperbolicity of 3-manifolds and their *shadow complexities*, which was strengthened by Ishikawa and Koda later [9]. Here the *shadow complexity* of M is defined as the minimum number of true vertices of a shadow of M . This notion is introduced by Costantino in [2], in which he studied closed 4-manifolds with shadow complexities 0 and 1 in a special case. In [10] Martelli completely classified the closed 4-manifolds with shadow complexity 0 in the general case.

In this paper we study acyclic 4-manifolds with shadow complexity zero by observing the structure of simple polyhedra.

To state the first theorem, we introduce a canonical way to equip internal regions of a subpolyhedron of a shadowed polyhedron with gleams. Let

2010 *Mathematics Subject Classification.* Primary 57N13, 57M20; Secondary 57R65.
Key words and phrases. 4-manifolds, shadows, polyhedra, complexity.

(X, gl) be a shadowed polyhedron, and X_0 a simple polyhedron with $X_0 \subset X$. Let R be an internal region of X_0 . We observe that $\text{Sing}(X_0) \subset \text{Sing}(X)$ and that R might be split by $\text{Sing}(X)$ into some internal regions R_1, \dots, R_n of X ($n \geq 1$). Then we assign a gleam to R by

$$(1) \quad \text{gl}(R) = \sum_{i=1}^n \text{gl}(R_i).$$

Suppose that there exist a triangulation (K, K_0) of the pair (X, X_0) and a sequence of elementary simplicial collapses from K onto K_0 . Then we say that X *collapses* X_0 . Moreover, this removal is called a *polyhedral collapse* (or simply *collapse*) and denoted by $X \searrow X_0$.

We denote by M_X the 4-manifold obtained from a shadowed polyhedron (X, gl) by Turaev's reconstruction. Now we state our first theorem.

Theorem 1. *Let (X, gl) be a shadowed polyhedron, and X_0 a simple polyhedron collapsed from X . Assign a gleam to each internal region of X_0 by formula (1). Then we have $M_X \cong M_{X_0}$.*

In the second theorem, we will study acyclic simple polyhedra and their collapsibility. Martelli introduced a way to convert a simple polyhedron whose singular set is a disjoint union of circles to a graph in [10]. We will use his notations and introduce some moves on a graph that correspond to collapsings.

Theorem 2. *Any acyclic simple polyhedron whose singular set is a disjoint union of circles collapses onto D^2 .*

We have an important consequence of Theorem 1 and Theorem 2 as follows:

Corollary 3. *Every acyclic 4-manifold with shadow complexity zero is diffeomorphic to D^4 .*

This paper consists of 4 sections. In Section 1 we review the definitions of simple polyhedra and shadows. In Section 2 and in Section 3, we give the proofs of Theorem 1 and Theorem 2 respectively. In Section 4, we discuss some consequences of our theorems.

Throughout this paper, we work in smooth category unless otherwise mentioned.

Acknowledgments. The author would like to thank his supervisor, Masaharu Ishikawa, for his useful comments and encouragement. He would also like to thank the referee for careful reading and helpful suggestions.

1. SIMPLE POLYHEDRA AND SHADOWS

A compact topological space X is called a *simple polyhedron* if any point x of X has a regular neighborhood $\text{Nbd}(x; X)$ homeomorphic to one of the five local models shown in Figure 1. A *true vertex* is a point whose regular

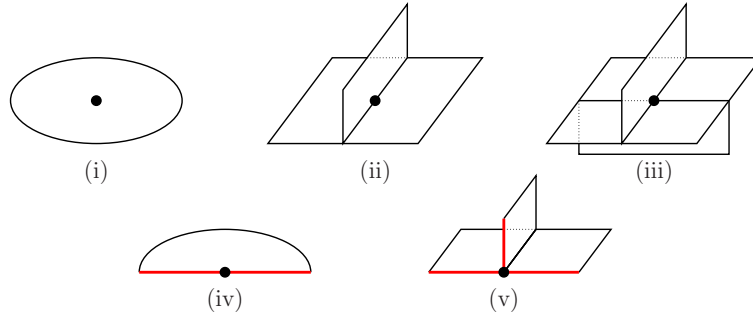

Figure 1. The local models of simple polyhedra.

neighborhood has a model of type (iii). We note that the model of type (iii) is homeomorphic to a cone over the complete graph K_4 with 4 vertices. The point $(p, 0) \in (K_4 \times [0, 1]) / (K_4 \times \{0\})$ is just a true vertex. A connected component of the set of points whose regular neighborhoods are of type (ii) or (v) is called a *triple line*. The union of all true vertices and triple lines is called the *singular set* of X and denoted by $Sing(X)$. The boundary ∂X of X is the set of points whose regular neighborhoods are of type (iv) or (v). Each component of $X \setminus Sing(X)$ is called a *region* of X . If a region R contains points of type (iv) then R is called a *boundary region*, and otherwise it is called an *internal region*.

Definition 1.1. Let M be a compact oriented 4-manifold and let T be a (possibly empty) trivalent graph in the boundary ∂M of M . A simple polyhedron X in M is called a *shadow* of (M, T) if the following hold:

- M collapses onto X ,
- X is locally flat in M , that is, for each point x of X there exists a local chart (U, ϕ) of M around x such that $\phi(U \cap X) \subset \mathbb{R}^3 \subset \mathbb{R}^4$, and
- $X \cap \partial M = \partial X = T$.

The following theorem by Turaev is very important and is called *Turaev's reconstruction*.

Theorem 1.2 (Turaev [13]). *Let X be a shadow of a 4-manifold M . Then there exists a canonical way to equip each internal region of X with a half-integer. Conversely, we can reconstruct M uniquely from X and the half-integers.*

Each half-integer in the above is called a *gleam*. A simple polyhedron X whose internal regions are equipped with a gleam is called a *shadowed polyhedron* and denoted by (X, gl) (or simply X).

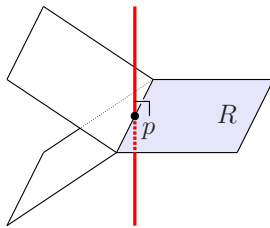

Figure 2. The fiber of the interval bundle at $p \in \partial R$.

Remark 1.3. As pointed out by Turaev [13], a gleam generalizes the Euler number of closed surfaces embedded in oriented 4-manifolds. We can interpret the gleam as follows. Let R be an intenal region of a shadow X in a 4-manifold M and let p be a point of ∂R . By the locally flatness there exists a 3-ball B^3 around p such that B^3 contains $\text{Nbd}(p; X)$. We take interval which passes through p and is transverse to R after giving an auxiliary Euclidean metric for B^3 as shown in Figure 2. By taking intervals for each point of ∂R continuously, we get an interval bundle over ∂R . We note that the interval bundle is a subbundle of the normal bundle over ∂R in M . Let R' be a small perturbation of R such that $\partial R'$ is lying in the interval bundle. If R' is generically chosen, then R and R' have only isolated intersections. Counting them with signs, we have

$$(2) \quad \text{gl}(R) = \frac{1}{2} \#(\partial R \cap \partial R') + \#(R \cap R').$$

For this formula we refer the reader to Carrega and Martelli [1].

We close this section with the definition of the shadow complexity.

Definition 1.4. Let M be a compact oriented 4-manifold having a shadow. We define the *shadow complexity* $sc(M)$ of M to be the minimum number of true vertices of a shadow of M .

Remark 1.5. Costantino defined the shadow complexity for “closed” 4-manifolds in [2]. A shadow of a closed 4-manifold M is defined as a shadow of a 4-manifold to which M is obtained by attaching 3- and 4-handles.

2. PROOF OF THEOREM 1

In this section we introduce a proposition on PL topology and provide a lemma for the proof of Theorem 1.

Proposition 2.1. *Let M be an n -dimensional compact PL manifold and fix a triangulation K of M . Let L_i be a subcomplex of a double barycentric subdivision of K for $i \in \{0, 1\}$. If $L_0 \searrow L_1$, then $\text{Nbd}(|L_0|; X)$ and $\text{Nbd}(|L_1|; X)$ are PL-homeomorphic.*

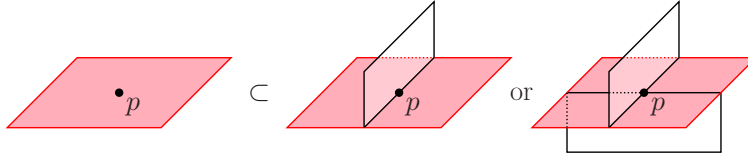

Figure 3. The leftmost picture shows $\text{Nbd}(p; R)$. The two right pictures are $\text{Nbd}(p; X)$.

For the proof of this proposition we refer the reader to [11, Lemma 3.25, Theorem 3.26].

Remark 2.2. A PL manifold has a unique smoothing in dimension $n \leq 6$ [7]. In our case $n = 4$, Proposition 2.1 with “PL-homeomorphic” replaced by “diffeomorphic” also holds.

Lemma 2.3. *Let (X, gl) be a shadowed polyhedron, and X_0 a simple sub-polyhedron of X . Assign a gleam to each internal region of X_0 by formula (1). Then we have $M_{X_0} \cong \text{Nbd}(X_0; M_X)$.*

Proof. Let K be the second barycentric subdivision of a given triangulation of X_0 , and set

$$K' = K \setminus \{\tau \in K \mid \tau \cap \partial X_0 \neq \emptyset\}.$$

Then K' is a subcomplex of K , and $K \searrow K'$. We have $\text{Nbd}(X_0; M_X) \cong \text{Nbd}(X'_0; M_X)$ by Proposition 2.1, where $X'_0 = |K'|$. Note that X_0 is proper and locally flat in $\text{Nbd}(X'_0; M_X)$. Hence X_0 is a shadow of $\text{Nbd}(X'_0; M_X)$.

By Turaev’s reconstruction, there should exist gleams for the internal regions of X_0 so that the 4-manifold reconstructed from them is diffeomorphic to $\text{Nbd}(X'_0; M_X)$. It suffices to show that such gleams coincide with ones given by formula (1).

Let R be an internal region of X_0 , and set $S = R \cap \text{Sing}(X)$. If $S = \emptyset$, the region R is also an internal region for X . Hence it is obvious that their gleams coincide by Remark 1.3.

We turn to the case $S \neq \emptyset$. As mentioned above, the region R is split into internal regions R_1, \dots, R_n of X . Let p be a point contained in S . Then $\text{Nbd}(p; X)$ can be described in either of the two right parts of Figure 3, where the colored areas indicate $\text{Nbd}(p; R)$. Note that $\text{Nbd}(p; R) = \text{Nbd}(p; X_0)$. We assume that these pictures are drawn in \mathbb{R}^3 and consider the regular neighborhood of $\text{Nbd}(p; X)$. Carrying out Turaev’s reconstruction with such 3-dimensional blocks, we get M_X in which R is smoothly embedded.

Next we consider the interval bundle over ∂R_i as mentioned in Remark 1.3 for $i \in \{1, \dots, n\}$. By the smoothness of R , if $\partial R_i \cap \partial R_j \neq \emptyset$, the restrictions of the interval bundles of ∂R_i and ∂R_j to $\partial R_i \cap \partial R_j$ coincide. Hence the union of the interval bundles is regarded as an interval bundle over $S \cup \partial R$, and we denote it by L . Let S' be a generic small perturbation

of S in L such that the images of the true vertices of X do not lie in the zero section. Then let R' be a generic small perturbation of R such that $S' \subset R'$ and $\partial R'$ lies in the restriction of the interval bundle L to ∂R . By restricting R' we get a small perturbation R'_i of R_i as in Remark 1.3 for $i \in \{1, \dots, n\}$. Note that each point $p \in S$ except for a true vertex is sandwiched between R_i and R_j for some $i, j \in \{1, \dots, n\}$, in other words, the point p belongs to both ∂R_i and ∂R_j . By formula (2), we have the following:

$$\begin{aligned}
\text{gl}(R) &= \frac{1}{2} \#(\partial R \cap \partial R') + \#(R \cap R') \\
&= \frac{1}{2} \sum_{i=1}^n \#((\partial R_i \cap \partial R) \cap (\partial R'_i \cap \partial R')) + \#(S \cap S') + \sum_{i=1}^n \#(R_i \cap R'_i) \\
&= \frac{1}{2} \sum_{i=1}^n \#(\partial R_i \cap \partial R'_i) + \sum_{i=1}^n \#(R_i \cap R'_i) \\
&= \sum_{i=1}^n \text{gl}(R_i),
\end{aligned}$$

and the proof is completed. \square

Proof of Theorem 1. There exist diffeomorphisms

$$M_X \cong \text{Nbd}(X; M_X) \cong \text{Nbd}(X_0; M_X) \cong M_{X_0}$$

by Turaev's reconstruction, Proposition 2.1 and Lemma 2.3. \square

3. PROOF OF THEOREM 2

In this section we study simple polyhedra and its graph notation introduced by Martelli, and give the proof of Theorem 2.

3.1. Basic lemmas for simple polyhedra. We first introduce convenient lemmas. We note that the first one was shown by Ikeda in [8, Lemma 12].

Lemma 3.1 (Ikeda [8]). *Any region of a simple polyhedron X is orientable and has no genus if $H_1(X; \mathbb{Z}) = 0$.*

The proof of Lemma 3.1 is given by using Mayer Vietoris exact sequence. For any region R of X , he considered a closed surface \tilde{R} obtained from R by capping off the all boundary components of R by disks and constructed a new simple polyhedron that contains \tilde{R} . He checked that $H_1(\tilde{R}; \mathbb{Z})$ must vanish.

Lemma 3.2. *Let X be an acyclic simple polyhedron and γ be a simple closed curve in $X \setminus \text{Sing}(X)$. Then γ splits X into two parts such that one of them is acyclic and the other is a homology- S^1 . Moreover the first homology of the latter is generated by γ .*

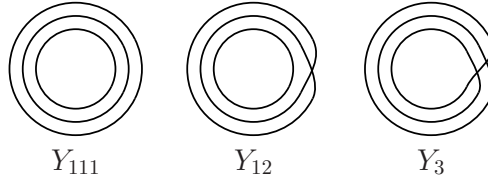

Figure 4. The three types of Y -bundle over S^1 . These pictures indicate the only boundaries of them.

Proof. Since any region of X is orientable by Lemma 3.1, $\text{Nbd}(\gamma; X)$ is homeomorphic to an annulus. Set $\Gamma = \text{Nbd}(\gamma; X)$ and $X' = X \setminus \text{IntNbd}(\gamma; X)$. Using the Mayer Vietoris exact sequence for the decomposition $X = \Gamma \cup X'$, we have the isomorphism $H_q(\Gamma; \mathbb{Z}) \oplus H_q(X'; \mathbb{Z}) \cong H_q(\Gamma \cap X'; \mathbb{Z})$ for $q \geq 1$. Hence $H_q(X'; \mathbb{Z}) = 0$ for $q \geq 2$ and $H_1(X'; \mathbb{Z}) \cong \mathbb{Z}$. Moreover $\chi(X') = 1$ holds from the following equality

$$\chi(X) = \chi(\Gamma) + \chi(X') - \chi(\Gamma \cap X').$$

Hence $\text{rank}H_0(X'; \mathbb{Z}) = 2$, that is, X' has two connected components: one of them is acyclic and the other is a homology- S^1 . Let X_0 be the acyclic connected component of X' and X_1 the other component. We regard X as the union $X_0 \cup X_1$. From the Mayer Vietoris exact sequence for this decomposition, it follows that γ generates $H_1(X_1; \mathbb{Z})$. \square

3.2. Martelli's graph encoding a simple polyhedron. Let X be a simple polyhedron whose singular set is a disjoint union of circles. In [10], Martelli introduced a graph encoded from X and classified closed 4-manifolds with shadow complexity zero.

A regular neighborhood of $S^1 \subset \text{Sing}(X)$ has a structure of Y -bundle over S^1 , where Y is a cone of three points. There are three topological types Y_{111} , Y_{12} and Y_3 , and they are shown in Figure 4. Each connected component of $X \setminus \text{Nbd}(\text{Sing}(X); X)$ is a surface homeomorphic to a region of X . Any surface is decomposed into disks, pairs of pants and Möbius strips. Hence we have the following.

Proposition 3.3 (Martelli [10]). *Any simple polyhedron whose singular set is a disjoint union of circles is decomposed along simple closed curves into pieces homeomorphic to D^2 , a pair of pants, the Möbius strip, Y_{111} , Y_{12} or Y_3 .*

A decomposition of X as in Proposition 3.3 provides a graph G consisting of some edges and vertices (B), (D), (P), (2), (111), (12) or (3) as in Figure 5. The vertices of type (D), (P), (2), (111), (12) and (3) denote some portions homeomorphic to D^2 , a pair of pants, the Möbius strip, Y_{111} , Y_{12} and Y_3 respectively. A vertex of type (B) denotes a boundary component of X . Note that each edge encodes a simple closed curve along which X

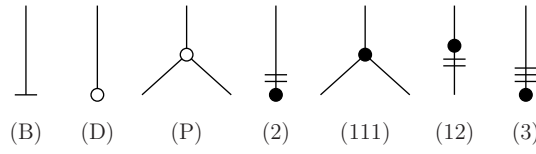

Figure 5. A simple polyhedron without true vertices is encoded by a graph having these vertices.

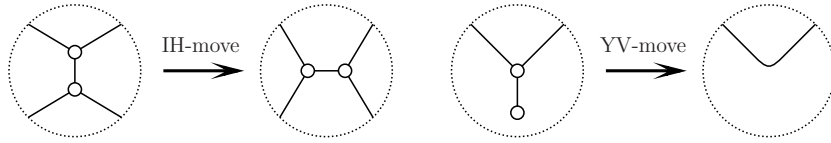

Figure 6. The move in the left part of the figure, called *IH-move*, corresponds to A-move for pants-decompositions in [6]. The move in the right part of the figure, called *YV-move*, means that an annulus plays a role of connecting two polyhedral pieces.

decomposes except the edges adjoining a vertex of type (B). We also note that we distinguish the two edges adjoining the vertex of type (12): the edge marked with two lines corresponds to a simple closed curve winding twice along the circle in $Sing(X)$.

As Martelli said, we can uniquely reconstruct the simple polyhedron X from a pair consisting of a graph G and a map $\beta : H_1(G; \mathbb{Z}_2) \rightarrow \mathbb{Z}_2$. It is necessary to choose homeomorphisms that glues polyhedral pieces at each edge of G since there are two self-homeomorphisms of S^1 , orientation-preserving and -reversing, up to isotopy. It is encoded by a map from $H_1(G; \mathbb{Z}_2)$ to \mathbb{Z}_2 .

The graph G that describes X is not unique since a surface decomposes into disks, pairs of pants and Möbius strips in several ways. There are some local moves as two examples shown in Figure 6 that do not change the topological type of the polyhedron. We call the two moves in Figure 6 *IH-move* and *YV-move*.

Definition 3.4. If there exists an edge connecting two vertices u and v of a graph, then u and v are said to be *adjacent*.

3.3. Acyclic case. Let X be an acyclic simple polyhedron whose singular set consists of circles. We note that we only need to consider the case $\partial X \neq \emptyset$ since there is no acyclic closed simple polyhedron without true vertices [8, Theorem 1].

Let G be a graph obtained from X . Our goal is to transform G into a 1-valent graph whose vertices are type (B) and type (D) as shown in Figure 7. It is obvious that this graph corresponds to the polyhedron D^2 .



Figure 7. This graph encodes D^2 .

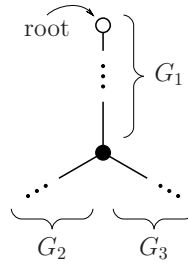

Figure 8. The central vertex of type (111) is v_0 . The subgraph G_1 contains the root of G .

Assertion 1. *There is no embedded Y_3 in any acyclic simple polyhedron.*

Proof. Assume that there exists Y_3 in an acyclic simple polyhedron X . By Lemma 3.2, a simple closed curve ∂Y_3 splits X into Y_3 and an acyclic subpolyhedron but does not generate $H_1(Y_3; \mathbb{Z})$. It is a contradiction. \square

Assertion 2. *The graph G is a tree.*

Proof. This follows readily from Lemma 3.2. \square

If X is decomposed into some pieces as in Proposition 3.3, there must be at least one piece homeomorphic to D^2 by applying iteratively Lemma 3.2. Choose one of such pieces and let the corresponding vertex of type (D) be the root of G .

We assume that G has at least one vertex of type (111). We transform G into a tree having no vertex of type (111).

Consider the farthest vertex of type (111) from the root. Let us denote it by v_0 . If we remove the corresponding piece Y_{111} from X , it is decomposed into three subpolyhedra. Let X_1 be one of them such that it contains D^2 corresponding to the root and X_2 and X_3 be the remaining two subpolyhedra. Let G_1, G_2 and G_3 be the subgraphs of G corresponding to X_1, X_2 and X_3 respectively as shown in Figure 8. By Lemma 3.2, at least one of X_2 and X_3 is homologically S^1 . Assume that X_2 is so. Let γ be the simple closed curve that cuts X_2 off from X . By Lemma 3.2, γ generates $H_1(X_2; \mathbb{Z})$. If X_2 has no boundary except γ , the simple polyhedron obtained from X_2 by capping off the boundary component by a disk is closed, acyclic and without true vertices, contrary to [8, Theorem 1]. Hence X_2 has some boundary components other than γ . In other words, there exists a vertex of type (B) in G_2 .

Assertion 3. *Let v_1 be a vertex of type (P) such that it is adjacent to a vertex of type (B). If v_1 is adjacent to a vertex of type (12), the edge between them is marked with two lines.*

Proof. Assume that there is an edge, denoted by e , adjoining v_1 and a vertex of type (12) such that the edge is not marked with two lines. Let v_2 be the vertex of type (12). Along the simple closed curve corresponding to e , X is decomposed into two subpolyhedra: one contains a region R corresponding to v_1 and another contains Y_{12} corresponding to v_2 . Since R has two boundary components, the former subpolyhedron has a 1-cycle. By Lemma 3.2, the latter subpolyhedron should be acyclic. However the subpolyhedron collapses so that it contains a Möbius strip in a region. This contradicts Lemma 3.1. \square

Assertion 4. *The moves of G described in Figure 9 (a), (b) and (c) are realized by collapsings of X .*

Proof. (a) (resp. (b)) The corresponding part of X is shown in Figure 10 (a1) (resp. (b1)). It can collapse along the boundary component in the direction of the arrows described in the figure, and the resulting polyhedron is shown in Figure 10 (a2) (resp. (b2)).

(c) Figure 10 (c1) shows the corresponding part of X . After we glue the two pieces, a pair of pants and Y_{12} as in Figure 10 (c1), it turns out that X can be described as in Figure 10 (c2). Let X collapse along a part of the boundary component as indicated by the arrows. Then the resulting polyhedron is shown in Figure 10 (c3). \square

Assertion 5. *The graph G can change into a subgraph that does not contain v_0 and G_2 only by the moves (a),(b),(c) in Figure 9, the IH-move and the YV-move.*

Proof. Let v be a vertex of type (B) in G_2 . Then v is adjacent to a unique vertex v' of type (111), (12) or (P).

If v' is of type (111), that is $v' = v_0$, we apply the move (a) and the proof is completed.

We consider the case where v' is type (12) or (P). If v' is of type (12), the edge between v and v' must be marked with two lines as shown in Figure 11 (1) by the same reason of Assertion 3. If v' is of type (P), the two vertices adjacent to v' other than v can not be of type (B) by the acyclicity of X . Therefore the possible cases are as shown in Figure 11.

Set $H_0 = G_2$. In each case of (1)–(7) in Figure 11, we apply some moves to H_k as follows and denote the resulting graph by H_{k+1} ($k = 0, 1, \dots$).

- (1) In this case we apply the move (b). Then the number of vertices in H_{k+1} is less than the one in H_k .
- (2)–(4) In these cases we apply the move (c). Then the number of vertices in H_{k+1} is less than the one in H_k .
- (5) In this case we apply YV-move. Then the number of vertices in H_{k+1} is less than the one in H_k .
- (6),(7) Let v'_k be the vertex adjacent to v in H_k . We define a set V_k of vertices of type (P) as follows: $u \in V_k$ if and only if there is a path

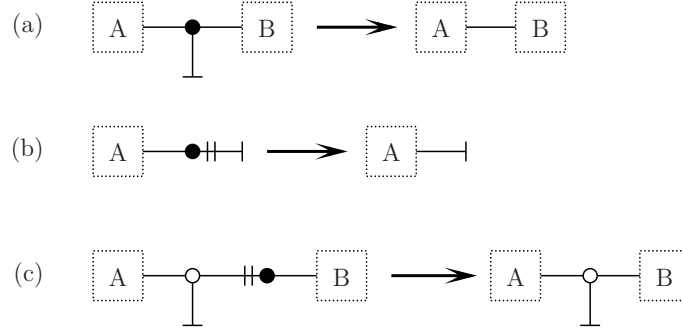

Figure 9. Three moves of graphs in Assertion 4.

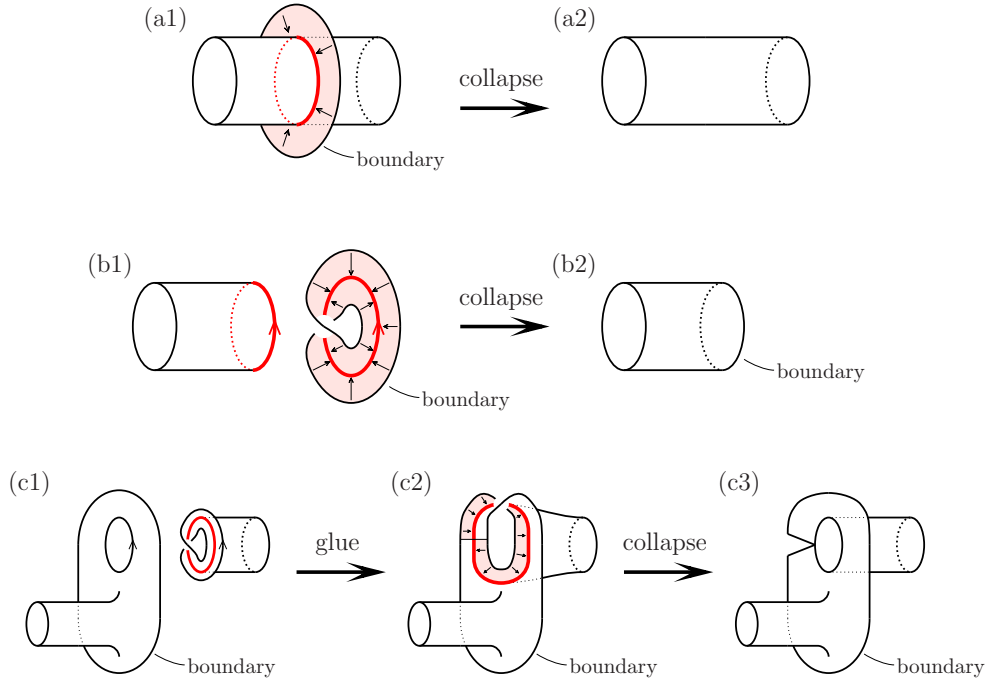

Figure 10. Collapses realizing the moves of graph in Figure 9.

between v'_k and u in H_k such that it contains vertices only of type (P). Then there exists at least one vertex in V_k which is adjacent to a vertex different from v and of type other than (P) or (111) since G is a tree. Choose such a vertex u in V_k and a path between v'_k and u as above. We apply IH-moves along the path, and then the resulting graph H_{k+1} is as in one of the cases (1)–(5).

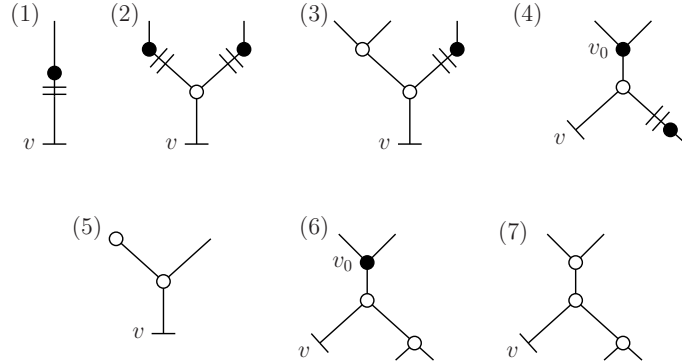

Figure 11. If a vertex of type (B) is adjacent to one of type (12) or (P), the graph must have one of these structures locally.

In all cases (1)–(7) we can decrease the number of vertices in H_k but this is finite. Hence it comes down to the case where v is adjacent to one of type (111), and the proof is completed. \square

We iterate Assertion 5 until all the vertices of type (111) in G disappear and denote the resulting graph by G' . There still exists a vertex of type (B) in G' by [8, Theorem 1]. We denote it by v . The vertex adjacent to v is of type (D), (12) or (P). If it is of type (D), G' is as in Figure 7, which corresponds to D^2 . If the vertex adjacent to v is of type (12) or (P), the possible cases are (1)–(3),(5),(7) in Figure 11. As in the proof of Assertion 5 we apply some moves to G' and finally obtain a graph such that v is adjacent to one of type (D). This completes the proof of Theorem 2.

4. APPLICATIONS

In this section, we discuss applications of our results.

Proof of Corollary 3. Let M be an acyclic 4-manifold with shadow complexity zero, and let X be a shadow of M without true vertices. Then each connected component of $Sing(X)$ is S^1 or a closed interval. If $Sing(X)$ consists of only circles, then X collapses onto D^2 by Theorem 2. By Theorem 1, a disk D^2 is a shadow of M_X , and then M_X is diffeomorphic to D^4 .

Assume that $Sing(X)$ has a closed interval component. We decompose X into subpolyhedra X_1, \dots, X_n along all closed interval components of $Sing(X)$. From Turaev's reconstruction [13], the boundary connected sum $M_{X_1} \natural \cdots \natural M_{X_n}$ and M_X are diffeomorphic. For $1 \leq i \leq n$, the 4-manifold M_{X_i} is diffeomorphic to D^4 as mentioned above since $Sing(X_i)$ consists of only circles. It follows that $M_X \cong D^4$. \square

We have another application to the study of 3-manifolds. Let N be a closed connected 3-manifold. A shadow of N is defined as a shadow of a

4-manifold whose boundary is N . Costantino and Thurston indicated in [5] that the Stein factorization of a stable map on N to \mathbb{R}^2 can be seen as a shadow of N with a certain modification if necessary. The notion of complexity of stable maps was introduced by Ishikawa and Koda in [9]. Especially, the complexity of a stable map is zero if and only if the map has no singular fiber of type II^2 and type II^3 . See [12, 9] for the precise definitions. These observations and our results immediately yield the following:

Corollary 4.1. *Let N be a closed connected 3-manifold. Then N admits a stable map with complexity zero and acyclic Stein factorization if and only if N is homeomorphic to S^3 .*

REFERENCES

- [1] A. Carrega and B. Martelli, *Shadows, ribbon surfaces, and quantum invariants*, arXiv preprint arXiv:1404.5983, to appear in Quantum Topology.
- [2] F. Costantino, *Complexity of 4-manifolds*, Experiment. Math. **15** (2006), 237-249.
- [3] F. Costantino, *Stein domains and branched shadows of 4-manifolds*, Geom. Dedicata **121** (2006), 89-111.
- [4] F. Costantino, *Branched shadows and complex structures on 4-manifolds*, J. Knot Theory Ramifications **17** (2008), 14291454.
- [5] F. Costantino and D. Thurston, *3-manifolds efficiently bound 4-manifolds*, J. Topol. **1** (2008), 703745.
- [6] A. Hatcher, *Pants decompositions of surfaces*, arXiv:9906084.
- [7] M. Hirsch and B. Mazur, *Smoothings of piecewise linear manifolds*, Ann. Math. Studies 80, Princeton University Press, Princeton NJ 1974.
- [8] H. Ikeda, *Acyclic fake surfaces*, Topology **10** (1971), 936.
- [9] M. Ishikawa and Y. Koda, *Stable maps and branched shadows of 3-manifolds*, arXiv preprint arXiv:1403.0596, to appear in Math. Ann.
- [10] B. Martelli, *Four-manifolds with shadow-complexity zero*, Int. Math. Res. Not. IMRN **2011**, 12681351.
- [11] C. Rourke and B. Sanderson, *Introduction to piecewise-linear topology*, Ergebnisse der Mathematik, Band 69, Springer-Verlag, New York-Heidelberg, 1972.
- [12] O. Saeki, *Topology of singular fibers of differentiable maps*, Lecture Notes in Mathematics 1854, Springer-Verlag, Berlin, 2004.
- [13] V. G. Turaev, *Quantum invariants of knots and 3-manifolds*, de Gruyter Studies in Math., 18, Walter de Gruyter & Co., Berlin, 1994.

TOHOKU UNIVERSITY, SENDAI, 980-8578, JAPAN
E-mail address: sb3m22@math.tohoku.ac.jp