

A YANG-BAXTER EQUATION FOR METAPLECTIC ICE

BEN BRUBAKER, VALENTIN BUCIUMAS, AND DANIEL BUMP

ABSTRACT. We will give new applications of quantum groups to the study of spherical Whittaker functions on the metaplectic n -fold cover of $\mathrm{GL}(r, F)$, where F is a nonarchimedean local field. Earlier Brubaker, Bump, Friedberg, Chinta and Gunnells had shown that these Whittaker functions can be identified with the partition functions of statistical mechanical systems. They postulated that a Yang-Baxter equation underlies the properties of these Whittaker functions. We will confirm this, and identify the corresponding Yang-Baxter equation with that of the quantum affine Lie superalgebra $U_v(\widehat{\mathfrak{gl}}(1|n))$, modified by Drinfeld twisting to introduce Gauss sums. (The deformation parameter v is specialized to the inverse of the residue field cardinality.)

Moreover, we will interpret the standard intertwining integrals as R -matrices. The Whittaker models are not unique, so the scattering matrix for the standard intertwining operators is vector valued. For a simple reflection, it was computed by Kazhdan and Patterson, who applied it to generalized theta series, and it was also applied and generalized by Chinta–Offen and McNamara to the “metaplectic Casselman-Shalika formula.” We will show that the scattering matrix on the space of Whittaker functions for a simple reflection coincides with the twisted R -matrix of the quantum group $U_v(\widehat{\mathfrak{gl}}(n))$. This is a piece of the twisted R -matrix for $U_v(\widehat{\mathfrak{gl}}(1|n))$, mentioned above.

1. INTRODUCTION

The important formula of Casselman and Shalika [9] expresses values of the spherical Whittaker function for a principal series representation of a reductive algebraic group over a p -adic field in terms of the characters of irreducible finite-dimensional representations of the Langlands dual group. Their proof relies on knowing the effect of the intertwining integrals on the normalized Whittaker functional. Since the Whittaker functional is unique, the intertwining integral just multiplies it by a constant, which they computed.

In contrast with this algebraic case, Whittaker models of principal series representations of metaplectic groups are generally not unique. The effect of the intertwining operators on the Whittaker models was computed by Kazhdan and Patterson [19]. Specifically, they computed the scattering matrix of the intertwining operator corresponding to a simple reflection on the finite-dimensional vector space of Whittaker functionals for the n -fold metaplectic cover of $\mathrm{GL}(r, F)$, where F is a p -adic field. Some terms in this matrix are simple rational functions of the Langlands parameters, while others involve n -th order Gauss sums. Though complicated in appearance, this scattering matrix was a key ingredient in their study of generalized theta series, and also in the later development of a metaplectic Casselman-Shalika formula by Chinta and Offen [11] and McNamara [28].

We will show that this scattering matrix computed by Kazhdan and Patterson is the R -matrix of a quantum group, quantum affine $\mathfrak{gl}(n)$, modified by Drinfeld twisting to introduce

Gauss sums. This appears to be a new connection between the representation theory of p -adic groups and quantum groups. Moreover we will also encounter the R -matrix for the larger quantum group associated with the affinization of the Lie superalgebra $\mathfrak{gl}(1|n)$.

To elaborate, we will exhibit solvable lattice models whose partition functions are values of metaplectic Whittaker functions. This is a modification of a family of models proposed earlier in Brubaker, Bump, Chinta, Friedberg and Gunnells [5]. Let \tilde{G} denote an n -fold metaplectic cover of $G := \mathrm{GL}(r, F)$ where the non-archimedean local field F contains the $2n$ -th roots of unity. If λ is a partition of length $\leq r$, a system \mathfrak{S}_λ was exhibited in [5] whose partition function equaled the value of one particular spherical Whittaker function W at

$$\mathfrak{s} \left(\begin{array}{ccc} p^{\lambda_1} & & \\ & \ddots & \\ & & p^{\lambda_r} \end{array} \right),$$

where $\mathfrak{s} : \mathrm{GL}(r, F) \rightarrow \widetilde{\mathrm{GL}}(F)$ is a standard section.

The systems proposed in [5] were generalizations of the six-vertex model. The six-vertex model with field-free boundary conditions was solved by Lieb [23], Sutherland [32] and Baxter [2] and were motivating examples that led to the discovery of quantum groups. (See [22, 16, 12].) In Baxter's work, the solvability of the models is dictated by the Yang-Baxter equation. The relevant quantum group is $U_q(\widehat{\mathfrak{sl}}_2)$. In the special case $n = 1$, then the systems proposed in [5] coincide with those discussed in Brubaker, Bump and Friedberg [6, 7] and there is a Yang-Baxter equation available. However even in this case these models differ from those considered by Lieb, Sutherland and Baxter since although they are true six-vertex models, they are not field-free. Based on the results of this paper, we understand that the relevant quantum group for [6, 7] is not $U_q(\widehat{\mathfrak{sl}}_2)$ but $U_q(\widehat{\mathfrak{gl}}(1|1))$, as we will make clear in subsequent sections.

It was explained in [5] that a Yang-Baxter equation for metaplectic ice would give new proofs of two important results in the theory of metaplectic Whittaker functions. The first is a set of local functional equations corresponding to the permutation of the Langlands-Satake parameters. The second is an equivalence of two explicit formulas for the Whittaker function, leading to analytic continuation and functional equations for associated Weyl group multiple Dirichlet series. The proof of this latter statement occupies the majority of [7].

However, no Yang-Baxter equation for the metaplectic ice in [5] could be found. In this paper we will make a small but crucial modification of the Boltzmann weights for the model in [5]. This change does not affect the partition function, but it makes possible a Yang-Baxter equation. This is Theorem 3 in Section 3. The solutions to the Yang-Baxter equation may be encoded in a matrix commonly referred to as an R -matrix.

We further prove that the resulting R -matrix has two important properties:

- (1) It is a Drinfeld twist of the R -matrix for quantum affine $\widehat{\mathfrak{gl}}(1|n)$, a Lie superalgebra.
- (2) It contains the R -matrix of a Drinfeld twist of $\widehat{\mathfrak{gl}}(n)$, which, as we have already explained, can be identified with the scattering matrix of the intertwining operators on the Whittaker models.

Consider the quantized enveloping algebra of the untwisted affine Lie algebra $\widehat{\mathfrak{gl}}(n)$. We denote the quantized enveloping algebra as $U_v(\widehat{\mathfrak{gl}}(n))$ instead of the usual U_q because in our application the deformation parameter v will be q^{-1} , where q is the cardinality of the residue

field of F . If V and W are vector spaces, let $\tau = \tau_{V,W}$ denote the flip operator $V \otimes W \rightarrow W \otimes V$. The Hopf algebra $U_v(\widehat{\mathfrak{gl}}(n))$ is (essentially) quasitriangular, so given any two modules V and W , there is an R -matrix $R_{V,W} \in \text{End}(V \otimes W)$ such that $\tau R_{V,W} : V \otimes W \rightarrow W \otimes V$ is a module homomorphism. The R -matrices satisfy a Yang-Baxter equation, which is one of the properties needed to make the modules into a braided monoidal category. The R -matrices for $U_v(\widehat{\mathfrak{gl}}(n))$ acting on the standard module were found by Jimbo [17]. (See also Frenkel and Reshetikhin [14], Remark 4.1.)

The quantum group $U_v(\widehat{\mathfrak{gl}}(n))$ has one n -dimensional standard module $V_+(z)$ for every complex parameter value z . We will label a basis of the module $v_{+a}(z)$ where a runs through the integers modulo n . The parameter $+a$ will be called a *decorated spin* (to be supplemented later by another one, denoted -0), generalizing the so-called *spin* \pm in the literature of the six-vertex model. We may think of the decoration $a \pmod{n}$ as roughly corresponding to the sheets of the metaplectic cover $\tilde{G} \rightarrow \text{GL}(r)$ of degree n .

The matrix $R_{z_1, z_2} \in \text{End}(V_+(z_1) \otimes V_+(z_2))$ may be defined by specifying the values $R_{\alpha, \beta}^{\gamma, \delta}(z_1, z_2)$ for decorated spins α, β, γ and δ such that

$$R_{z_1, z_2}(v_\alpha(z_1) \otimes v_\beta(z_2)) = \sum_{\gamma, \delta} R_{\alpha, \beta}^{\gamma, \delta}(z_1, z_2) v_\gamma(z_1) \otimes v_\delta(z_2).$$

These are given by the following table:

$\alpha, \beta, \gamma, \delta$	$+a, +a, +a, +a$ ($0 \leq a \leq n$)	$+b, +a, +b, +a$ ($0 \leq a, b \leq n, a \neq b$)	$+b, +a, +a, +b$ ($0 \leq a, b \leq n, a \neq b$)
$R_{\alpha, \beta}^{\gamma, \delta}(z_1, z_2)$	$\frac{-v+(z_1/z_2)^{-n}}{1-v(z_1/z_2)^{-n}}$	$g(a-b) \frac{1-(z_1/z_2)^{-n}}{1-v(z_1/z_2)^{-n}}$	$\begin{cases} (1-v) \frac{(z_1/z_2)^{-n}}{1-v(z_1/z_2)^{-n}} & a > b, \\ (1-v) \frac{1}{1-v(z_1/z_2)^{-n}} & a < b. \end{cases}$

Here $g(a-b)$ is an n -th order Gauss sum. These are not present in the out-of-the-box $U_v(\widehat{\mathfrak{gl}}(n))$ R -matrix but may be introduced by Drinfeld twisting that will be discussed below in Section 6. This procedure does not affect the validity of the Yang-Baxter equations, but is better for comparison with the R -matrix for the partition functions of metaplectic ice giving rise to Whittaker functions.

To obtain the full R -matrix used in the Yang-Baxter equation for metaplectic ice, we must enlarge the set of decorated spins $+a$ to include one more, labelled -0 . Then the n -dimensional vector space $V_+(z)$ is enlarged to an $n+1$ “super” vector space $V_\pm(z)$. In Section 6, we show this is a module for the quantum affine Lie superalgebra $U_v(\widehat{\mathfrak{gl}}(n|1))$.

Finally, we explain the connection between the R -matrix of Theorem 3 and the structure constants alluded to in item (2) above. The local functional equations for metaplectic Whittaker functions mentioned earlier may be understood as arising from intertwining operators. Let \hat{T} be the diagonal torus in $\text{GL}(r, \mathbb{C})$, the Langlands dual group of G . Each diagonal matrix

$$\mathbf{z} = \begin{pmatrix} z_1 & & \\ & \ddots & \\ & & z_r \end{pmatrix} \in \hat{T}(\mathbb{C})$$

indexes a principal series representation $\pi_{\mathbf{z}}$ of \tilde{G} . Let $\mathcal{W}_{\mathbf{z}}$ be the finite-dimensional vector space of spherical Whittaker functions. If $n = 1$, $\mathcal{W}_{\mathbf{z}}$ is one-dimensional, but not in general since if $n > 1$ the representation $\pi_{\mathbf{z}}$ does not have unique Whittaker models. If s_i is a simple reflection in the Weyl group W , then let \mathcal{A}_{s_i} denote the standard *intertwining integral* $\mathcal{A}_{s_i} : \pi_{\mathbf{z}} \rightarrow \pi_{s_i \mathbf{z}}$ (see (13) for the precise definition). This induces a map $\mathcal{W}_{\mathbf{z}} \rightarrow \mathcal{W}_{s_i \mathbf{z}}$. If $n > 1$ then \mathcal{A}_{s_i} has an interesting scattering matrix on the Whittaker model that was computed by Kazhdan and Patterson (Lemma I.3.3 of [19]). This calculation underlies their work on generalized theta series, and was used by Chinta and Offen [11] and generalized by McNamara [28] to study the analog of the Casselman-Shalika formula for the spherical Whittaker functions.

In Section 9, we will prove that the scattering matrix of the intertwining integrals on the spherical Whittaker functions is essentially $\tau R_{z_i, z_{i+1}}$, where $R_{z_i, z_{i+1}}$ is the R -matrix for a Drinfeld twist of $U_v(\widehat{\mathfrak{gl}}(n))$.

Theorem 1. *There is an isomorphism $\theta_{\mathbf{z}}$ of the space $\mathcal{W}_{\mathbf{z}}$ of spherical Whittaker functions to the vector space $V_+(z_1) \otimes \cdots \otimes V_+(z_r)$, which takes the vectors $v_{+a_1}(z_1) \otimes \cdots \otimes v_{+a_r}(z_r)$ into the basis of $\mathcal{W}_{\mathbf{z}}$ given in [19, 11, 28]. Then the following diagram commutes:*

$$\begin{array}{ccc} \mathcal{W}_{\mathbf{z}} & \xrightarrow{\theta_{\mathbf{z}}} & V_+(z_1) \otimes \cdots \otimes V_+(z_i) \otimes V_+(z_{i+1}) \otimes \cdots \otimes V_+(z_r) \\ \downarrow \bar{\mathcal{A}}_{s_i}^* & & \downarrow I_{V_+(z_1)} \otimes \cdots \otimes \tau R_{z_i, z_{i+1}} \otimes \cdots \otimes I_{V_+(z_r)} \\ \mathcal{W}_{s_i \mathbf{z}} & \xrightarrow{\theta_{s_i \mathbf{z}}} & V_+(z_1) \otimes \cdots \otimes V_+(z_{i+1}) \otimes V_+(z_i) \otimes \cdots \otimes V_+(z_r) \end{array}$$

where $\bar{\mathcal{A}}_{s_i}^*$ denotes the map obtained by $W_b^X \mapsto W_b^X \circ \bar{\mathcal{A}}_{s_i}$ with normalized intertwining operator $\bar{\mathcal{A}}_{s_i}$ defined in (14).

Important future questions include the generalization of the above results to other Cartan types and relations between them and other literature such as Weissman [33] and Gaitsgory [15].

This work was supported by NSF grants DMS-1406238 (Brubaker) and DMS-1001079, DMS-1601026 (Bump and Buciumas). We thank Gautam Chinta, Solomon Friedberg and Paul Gunnells for their support and encouragement, and David Kazhdan and Daniel Orr for helpful comments on an earlier version of this paper.

2. THE PARTITION FUNCTION

In the language of statistical mechanics, the partition function of a model is a generating function, where the sum is taken over a collection of *admissible states* of the model. Each such admissible state is then weighted by a *Boltzmann weight*. We first define the admissible states of our model, and then the associated weights.

Consider a two-dimensional rectangular grid with r rows and N columns, where N is any sufficiently large number. The columns will be numbered $N - 1, N - 2, \dots, 2, 1, 0$ in decreasing order. Every edge will be assigned a *spin*, which has value $+$ or $-$. The spins along the boundary edges will be fixed as part of the data specifying the system; the spins on the interior edges will be allowed to vary. Thus with the spins on the boundary fixed, a *state* of the system will be an assignment of spins to the interior edges. Only certain assignments will be considered. The state will be called *admissible* if the four spins on adjacent edges

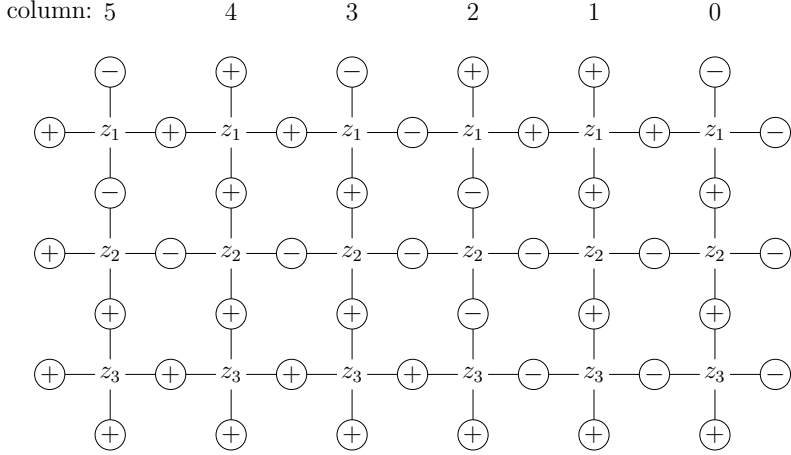

FIGURE 1. A state of a six-vertex model system. The columns are labeled in descending order by 0 through $N - 1$, where in this example $N = 6$. The partition λ in this case is $(3, 2, 0)$, so $\lambda + \rho = (5, 3, 0)$; therefore the $-$ in the top row are placed in columns 5, 3, 0.

of any vertex are in one of the six configurations in Figure 2. An example of an admissible state is shown in Figure 1. (The appearance of labels z_i on the vertices in the figure will be explained momentarily.)

Define the *charge* at each horizontal edge in the configuration to be the number of $+$ spins at or to the right of the edge, along the same row. We also will speak of the charge at a vertex, defined to be the charge on the edge to the right of the vertex. There is a finer notion of admissible states depending on charge that will appear often in subsequent sections. Given a fixed positive integer n , we say that a state is *n-admissible* if every edge with $-$ spin has charge a multiple of n .

Not all choices of fixed boundary spins produce a system with admissible states. In this paper, we consider systems with boundary spins of the following type. The spins along the left and bottom edges of the grid will be $+$, while the spins along the right edge of the grid will all be $-$. The spins along the top edge will be a mixture of $+$ and $-$, and the number of $-$ signs appearing will be equal to r , the number of rows. Thus any choice of top boundary spins corresponds to a strict partition with r parts (one of which can be 0). We choose to index these using a partition λ of length $\leq r$ and a vector $\rho = (r - 1, \dots, 3, 2, 1, 0)$, so that $\lambda + \rho$ is a strict partition of length r . Place $-$ spins at the top of the columns $\lambda_1 + r - 1, \lambda_2 + r - 2, \dots, \lambda_r$, and $+$ in all other columns.

This completes the description of admissible (and *n-admissible*) states in a system, determined by a fixed rectangular grid with fixed boundary spins as above. Now we explain how to attach a weight to each admissible state. This *Boltzmann weight* of a state is obtained as a product of weights attached to each vertex in the model. The weight attached to any vertex makes use of a pair of functions h and g on the integers satisfying the following properties.

Let n be a fixed positive integer and v a fixed parameter. Let $g(a)$ be a function of the integer a which is periodic modulo n , and such that $g(0) = -v$, while $g(a)g(n - a) = v$ if n

a_1	a_2	b_1	b_2	c_1	c_2
1	z_i	$g(a)$	z_i	$h(a)z_i$	1

FIGURE 2. The Boltzmann weights at a vertex for our ice model. The illustrated vertices are at a vertex in the i -th row of charge a . (The charge is the number of + signs in the row to the right of the vertex.) The Boltzmann weight of any configuration not appearing in this table is zero. In an n -admissible state, any horizontal edge with a $-$ spin will have its charge divisible by n .

does not divide a . Let

$$h(a) = \begin{cases} 1 - v & \text{if } n|a, \\ 0 & \text{otherwise.} \end{cases}$$

Remark. In [5] and [7], the functions g and h are defined using n -th order Gauss sums, with $v = q^{-1}$, and shown to satisfy the above properties. We will use this specific choice later in Theorem 2 and in Section 9 to connect the partition function to metaplectic Whittaker functions. However, only the above properties are required for their study by statistical mechanical methods in subsequent sections.

To define the Boltzmann weight at a vertex, choose r nonzero complex numbers z_1, \dots, z_r , one for each row, as indicated in Figure 1. Then given a vertex in the i -th row, its Boltzmann weight is given in Figure 2. Note that this weight depends on the spins and the charges on adjacent edges, and the row i in which it appears. Then the Boltzmann weight $B_{z_1, \dots, z_r}^{(n)}(\mathfrak{s})$ of the state \mathfrak{s} is the product of the Boltzmann weights over all vertices in the grid. We often omit the n or the z_1, \dots, z_r in the notation for B , as the weights may be stated uniformly for all such choices.

Thus in the example state in Figure 1, the vertex in the first row and column 5 is of type b_1 with charge 4, so the Boltzmann weight at this vertex is $g(4)$. There are two c_2 vertices in columns 3 and 0, a c_1 vertex in column 2, and a_1 vertices in columns 4 and 1. The c_1 vertex and one of the c_2 vertices has charge 2, so the state is n -admissible only if $n = 1$ or 2. Assuming this, the $g(4)$ from the b_1 vertex evaluates to $-v$ and the c_1 vertex evaluates to $(1 - v)z_1$, while the remaining vertices in the row have weight 1. Thus the total contribution of this row is $(-v)(1 - v)z_1$. The second row has a vertex c_2 (with charge 0) the remaining vertices are all b_2 or a_2 , so this row contributes z_2^5 . The last row has a c_2 vertex (with charge 0) and two b_2 vertices. The remaining three vertices in the row are of type a_1 with Boltzmann weight 1. The Boltzmann weight of this state is $(-v)(1 - v)z_1z_2^5z_3^2$ if $n = 1$ or 2, and 0 otherwise.

Note that, although the Boltzmann weights depend only on the charge a modulo n , we take charge to be an integer, not an integer modulo n . This will be important mainly in Section 5.

Proposition 1. *Suppose that \mathfrak{s} is an admissible state such that the Boltzmann weight $B^{(n)}(\mathfrak{s}) \neq 0$. Then the state is n -admissible.*

Proof. We must show that, under this assumption, the charge on every edge with spin $-$ is a multiple of n . Suppose not and consider the right-most edge in any row where this condition fails. Then the charge at the vertex v to the right of this edge is not a multiple of n . We claim that the edge to the right of v has spin $+$. We know that v is not the rightmost vertex in its row since its charge is nonzero. So if the edge to the right of v has spin $-$, then the vertex to the right of v has the same charge as v , contradicting our assumption that v is the rightmost counterexample in its row.

Since the edge to the left of v is $-$ and the edge to the right is $+$, consulting Figure 2 we see that the only admissible configuration of spins at the vertex v is of type c_1 , so the Boltzmann weight at v is $h(a)z_i = 0$ because $n \nmid a$. This contradicts our assumption that $B^{(n)}(\mathfrak{s}) \neq 0$. \square

Let $\mathfrak{S}_\lambda^{(n)}$ denote the set of n -admissible states with fixed boundary spins determined by a partition λ . The sum $Z(\mathfrak{S}_\lambda^{(n)})$ of its Boltzmann weights is called the *partition function*. (We could just as easily sum over all admissible states, since the Boltzmann weights of the states that are not n -admissible vanish.)

Theorem 2 (Theorem 4 of [5]). *Let λ be a partition with r parts and let n be a fixed positive integer. Then the partition function $Z(\mathfrak{S}_\lambda^{(n)})$ is (up to normalization) a value of a p -adic spherical Whittaker function on the metaplectic n -fold cover of $\mathrm{GL}(r, F)$, where F is a nonarchimedean local field with residue field of cardinality $q \equiv 1 \pmod{2n}$.*

In the above result, the Boltzmann weights used in $Z(\mathfrak{S}_\lambda)$ have parameter $v = q^{-1}$ where q is the cardinality of the residue field of F . In Proposition 7 of Section 9, we give a more precise and more refined version of this result.

3. THE YANG-BAXTER EQUATION

The partition functions described in Section 2 differ from those of the classical six-vertex model in a crucial way: the Boltzmann weights depend on a global statistic, the charge. If we wish to use statistical mechanical techniques like the Yang-Baxter equation, we need the weight at any vertex to be *local*, that is, depending only on nearest-neighbor interactions. We achieve this by a slight change in point of view, introducing *decorated spins* for the horizontal edges. Given a fixed positive integer n , a *decorated spin* is an ordered pair (σ, a) where the *spin* σ is $+$ or $-$ and the *decoration* a is an integer mod n . Moreover if $\sigma = -$, we will only consider $a = 0 \pmod{n}$. In figures we will sometimes draw the spin σ in a circle and write the decoration a next to it. In text we will denote (σ, a) as σa . The key point is that the decoration is now viewed as part of the data attached to a horizontal edge. Now there are $n + 1$ possible decorated spins for horizontal edges, rather than just the spins $+$ and $-$; we have left the six-vertex model.

Given a state of the system, each horizontal edge receives a decoration a depending on its spin σ and the charge b of the edge to its right. If $\sigma = +$, then $a = b + 1$ and if $\sigma = -$, then $a = b$. If we set the initial decorations of the right-hand boundary edges (which all have spin $-$) to be 0, then this rule clearly recovers the charge (mod n) of the previous section. Thus the Boltzmann weights in Figure 2 may be interpreted as purely local; in the figure, we have indicated the decoration by writing it over the spin. We are justified in requiring the decoration at a $-$ edge to be 0 modulo n (without affecting the resulting partition functions) by Proposition 1.

We use the term *decoration* (rather than “charge” again) to emphasize this change to the local point of view and because the Boltzmann weights of Figure 2 depend only on the congruence class of charge mod n . Thus there are only finitely many admissible configurations of decorated spins at a given vertex.

Now that the weights at any vertex may be viewed as local, we are ready to present our solution to the Yang-Baxter equation. Three vertices with different Boltzmann weights will appear in the Yang-Baxter equation (1) below. These will be labeled z_1 , z_2 and R_{z_1, z_2} . Here z_1 and z_2 are nonzero complex numbers used in the Boltzmann weight of the associated vertex, which double as labels for the vertices. At the vertices labeled z_1 and z_2 we will use the Boltzmann weights already described in Figure 2.

In Figure 3 we describe the Boltzmann weights at the vertices labeled R_{z_1, z_2} . The Boltzmann weights depend only on the residue classes modulo n of the integers a, b, c, \dots that appear in these formulas, but in some cases depend on a particular choice of representatives for residue classes. These choices are indicated in the description below the figure.

 $z_2^n - v z_1^n$	 $g(a-b)(z_1^n - z_2^n)$	 $(1-v)z_1^c z_2^{n-c} (*)$	 $z_1^n - v z_2^n$
 $v(z_1^n - z_2^n)$	 $z_1^n - z_2^n$	 $(1-v)z_1^a z_2^{n-a} (**)$	 $(1-v)z_1^{n-a} z_2^a (**)$

FIGURE 3. Boltzmann weights for the R -vertex R_{z_1, z_2} . It is assumed that b is not equal to a . (*) Here $c \equiv a - b \pmod n$ with $0 \leq c < n$. (**) Here we choose the representative of a modulo n with $1 \leq a \leq n$, so if $a \equiv 0 \pmod n$, $n - a$ means 0, not n .

Theorem 3. *The partition functions of the following two systems are equal. That is, if we fix the charges $\sigma, \tau, \beta, \rho, \alpha$ and μ and the decorations a, b, c, d , and sum over the possible values of the inner edge (decorated) spins, we obtain the same result in both cases.*

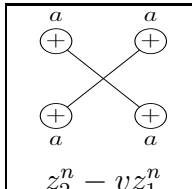
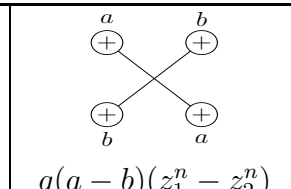
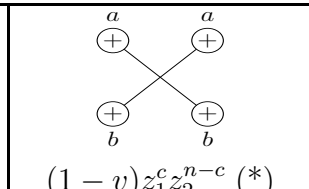
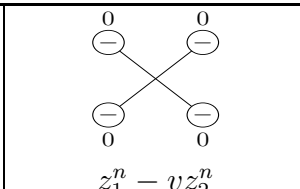
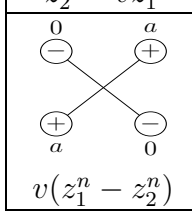
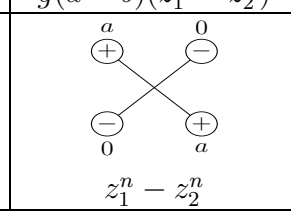
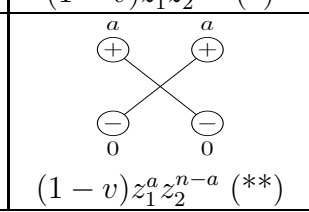
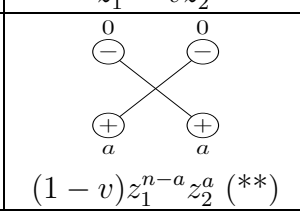
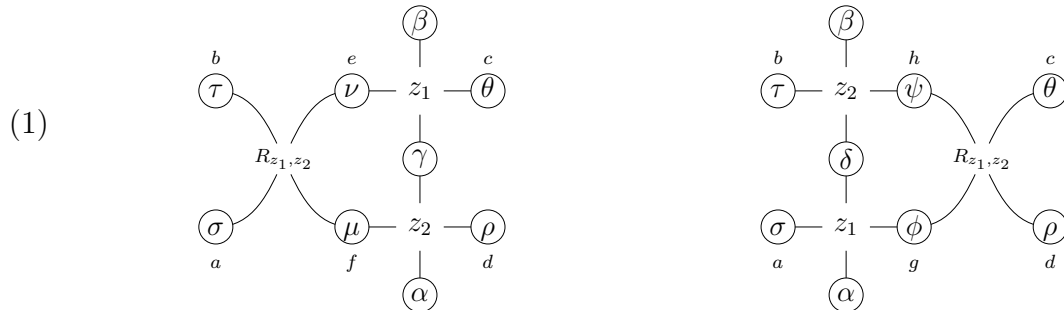

Proof. In every admissible configuration there are an even number of + spins on the six boundary edges. Therefore there are 32 possible boundary conditions and we will consider these 32 cases separately. Each case breaks into subcases depending on the decorations at σ, τ, θ and ρ . We exhaustively considered all cases where there is a nonzero contribution. To give the reader a feeling for the possibilities, we will do one case in detail, but in the interest of keeping the publication concise, the remaining cases may be found in [4].

In our enumeration of cases, the case we will consider carefully is Case 10. Assume that $(\sigma, \tau, \beta, \theta, \rho, \alpha) = (+, +, -, +, -, +)$.

Case 10a: With $k \neq 0$, suppose that the (decorated) spins on the six boundary edges are as follows:

a	b	β	c	d	α
σ	τ	β	θ	ρ	α
$k+1$	1	-	k	0	
+	+	-	+	-	+

On each side there is one n -admissible state:

left hand side				right hand side			
e	f	γ	weight	g	h	δ	weight
ν	μ			ϕ	ψ		
$k+1$	1		$(z_1^n - z_2^n) g(k) g(-k)$	k	0		$(z_1^n - z_2^n) v$
+	+	-		+	-	+	

Thus the configurations are as follows:

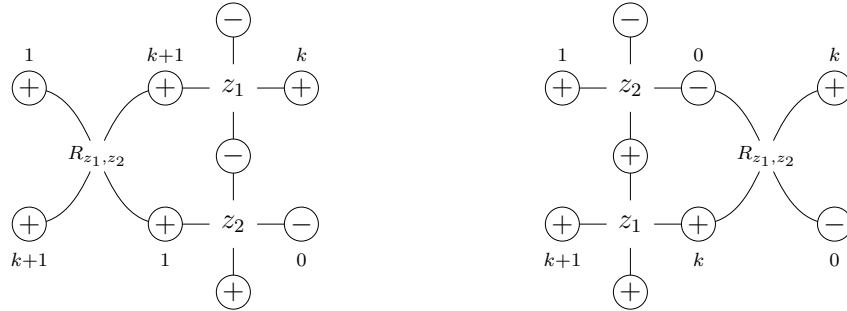

Since $g(k) g(-k) = v$, (1) is satisfied in this case.

Case 10b: With $k \neq 0$,

a	b	β	c	d	α
σ	τ	β	θ	ρ	α
1	$k+1$	-	k	0	
+	+	-	+	-	+

left hand side				right hand side			
e	f	γ	weight	g	h	δ	weight
ν	μ			ϕ	ψ		
$k+1$	1		$(1 - v) z_1^k z_2^{n-k} g(k)$	0	k		$(1 - v) z_1^k z_2^{n-k} g(k)$
+	+	-		-	+	-	

Case 10c:

a	b	β	c	d	α
σ	τ		θ	ρ	
1	1		0	0	
+	+	-	+	-	+

left hand side

e	f	γ	weight
ν	μ		
1	1		$v(z_1^n v - z_2^n)$
+	+	-	

right hand side

g	h	δ	weight
ϕ	ψ		
0	0		$(v-1)v z_1^n$
-	+	-	
0	0		$(z_1^n - z_2^n)v$
+	-	+	

This completes the proof of Case 10. See the appendix in [4] for the other cases. \square

4. PARTITION FUNCTION IDENTITIES WITH WEIGHTS R_{z_i, z_j}

If $\alpha = (\pm, c)$ is a decorated spin, let us say that α is *visible* if either the spin is +, or if the decoration $c \equiv 0$ modulo n . It is a consequence of Proposition 1 that only n -admissible states have nonzero Boltzmann weights, and in any n -admissible state, only vertices with visible spins on all adjacent edges produce nonzero Boltzmann weights as given in Figure 2. Furthermore the nonzero Boltzmann weights of type R_{z_1, z_2} given in Figure 3 occur only at vertices with visible spins on all adjacent edges.

Theorem 4. *Let z_1, z_2 and z_3 be given. Then for every choice of visible decorated boundary spins $\alpha, \beta, \gamma, \delta, \epsilon, \phi$, the partition functions of the following two systems are equal:*

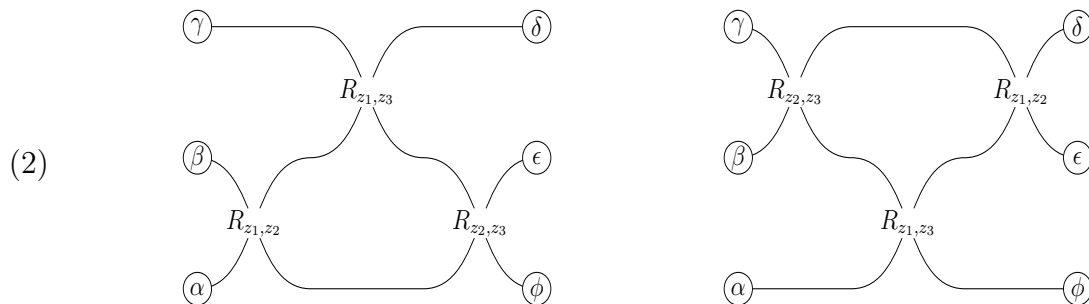

Theorem 4 is a form of parametrized Yang-Baxter equation. This result allows us to construct a braided monoidal category in the sense of Joyal and Street [18]. For each $z \in \mathbb{C}^\times$ let V_z be a complex (super) vector space of dimension $n+1$ with a basis indexed by the decorated spins $+a$ and -0 . We may consider the monoidal category \mathcal{C} of vector spaces generated by these under tensor product. Not all vector space homomorphisms will be morphisms. There will be morphisms $V_{z_1} \otimes \cdots \otimes V_{z_k} \rightarrow V_{w_1} \otimes \cdots \otimes V_{w_l}$ if $k=l$ and if (w_1, \dots, w_l) is a permutation $(z_{\sigma(1)}, \dots, z_{\sigma(k)})$, with σ in the symmetric group S_k . In this case, there will be a linear transformation $R_{\tilde{\sigma}} : V_{z_1} \otimes \cdots \otimes V_{z_k} \rightarrow V_{w_1} \otimes \cdots \otimes V_{w_l}$ for each element $\tilde{\sigma}$ of the Artin braid group B_k that projects onto σ , and the Hom space will be generated by these homomorphisms. It is enough to specify how the generators of the braid group act, and this requires us to specify a linear transformation $V_{z_i} \otimes V_{z_j} \rightarrow V_{z_j} \otimes V_{z_i}$. This is through the matrix $\tau R_{z_i, z_j}$ where $\tau(x \otimes y) = y \otimes x$. Theorem 4 implies that the

morphism $R_{\bar{\sigma}}$ is well defined, depending only on the choice of braid. Our goal is to embed this category in a category of modules of a quantum group, which will be a twist of the quantized enveloping algebra of $\widehat{\mathfrak{gl}}(1|n)$.

Theorem 5. *Let $\alpha, \beta, \gamma, \delta$ be visible decorated spins. Then the partition function*

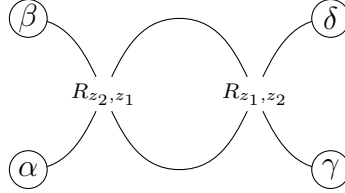

equals

$$\begin{cases} (z_1^n - vz_2^n)(z_2^n - vz_1^n) & \text{if } \alpha = \gamma, \beta = \delta \\ 0 & \text{otherwise.} \end{cases}$$

As we mentioned in the introduction, we will show in Section 9 that Theorem 4 is related to the intertwining integrals for principal series representations of the metaplectic group, which were calculated in Kazhdan and Patterson [19]. From this point of view, Theorem 5 is related to Theorem I.2.6 of [19].

Because of the last result, it is *almost* true that if we modified the R -matrix R_{z_1, z_2} by dividing by $z_1^n - vz_2^n$, the associated quantum (super) group (which will be identified in Section 6) would be *triangular* in the sense of Drinfeld [12]. However because this factor $z_1^n - vz_2^n$ can be zero, this is not quite true, and the braided category of modules is also not triangular.

5. PROOFS OF THEOREMS 4 AND 5

The goal of this section will be to prove the theorems in Section 4. Some of the facts we uncover are of interest beyond this goal. Although the statement of these two theorems is independent of the systems \mathfrak{S}_λ in Section 2, those systems will appear in the proof.

In this section, we view the Boltzmann weights in Figures 2 and 3 as depending on the charge, an integer, so that a and b appearing in those figures are integer valued rather than integers mod n . Let us consider some implications of this alternative point of view. In Figure 2, we recorded Boltzmann weights which were 0 unless the adjacent charges were of the form (a, a) or $(a + 1, a)$ for some a mod n . Now wherever $a + 1$ appears, it must be interpreted as the integer $a + 1$. If we replaced it by $a' + 1$ where $a' \equiv a$ modulo n , the Boltzmann weight would be interpreted as *zero* unless $a' = a$. In particular, we may change the charge a adjacent to a vertex to a' without changing the Boltzmann weight, but we must change it both adjacent edges – to the left and right of the vertex. A similar situation occurs with Figure 3; if we change a to a' where $a' \equiv a$ modulo n , we must change it in both places where it occurs.

The use of integer-valued charge leads to the following paradox: If $a \equiv b$ modulo n but $a \neq b$, observe that the integer-valued pair of charges (a, b) is no longer allowable in the top-left pattern in Figure 3. Instead it is associated with the second and the third patterns in the top row of the table. At first this is disconcerting because it seems to suggest a new proof of the Yang-Baxter equation is required. However, this is not a problem because the

contributions of the second and third patterns together give the same result as the first pattern in this case. Indeed in this case, $g(a - b) = -v$ and so

$$(3) \quad z_2^n - vz_1^n = [g(0)(z_1^n - z_2^n)] + [(1 - v)z_2^n].$$

Let nonzero complex numbers z_1, \dots, z_r be given. Regard $\mathbf{z} = (z_1, \dots, z_r)$ as coordinates in a complex torus T , and $\Lambda = X^*(T) \cong \mathbb{Z}^r$ will be the GL_r weight lattice. Elements of the weight lattice will be called *weights*, not to be confused with Boltzmann weights. We will denote $\mathbf{z}^\mu = \prod z_i^{\mu_i}$ if $\mu = (\mu_1, \dots, \mu_r) \in \Lambda$. We fix an integer N , large enough so that $N \geq \mu_i$ whenever $\mu = (\mu_1, \dots, \mu_r)$ is a weight that occurs in our considerations.

In Section 2, the partition function $Z(\mathfrak{S}_\lambda)$ was a sum over all admissible states with boundary spins corresponding to the choice of λ . If we view the data on any edge as both a spin and an integer charge, then the partition function $Z(\mathfrak{S}_\lambda)$ can be written as a sum of much smaller partition functions having both fixed boundary spins *and* fixed boundary charges. To explain this point, let $\mathbf{a} = (a_1, \dots, a_r)$ where a_1, \dots, a_r are positive integers. Consider the system \mathfrak{S}_λ with the same grid and the same Boltzmann weights as in Section 2, but at each horizontal boundary edge, we attach a spin and a charge as follows. On the horizontal edges along the right-hand boundary, use the decorated spins -0 . On the left-hand boundary, we use $+a_1, \dots, +a_r$. Let $\mathfrak{S}_{\lambda, \mathbf{a}}$ be the set of states whose left and right boundary conditions match these, and whose top and bottom edges have the same boundary conditions (using undecorated spins) as \mathfrak{S}_λ . Then the following identity of partition functions is immediate:

$$Z(\mathfrak{S}_\lambda) = \sum_{\mathbf{a}} Z(\mathfrak{S}_{\lambda, \mathbf{a}}),$$

where $Z(\mathfrak{S}_{\lambda, \mathbf{a}})$ is the partition function of the restricted system $\mathfrak{S}_{\lambda, \mathbf{a}}$. Let N be the width of the grid, that is, the number of vertices in each row. Since the only admissible vertices augment charge by at most one moving from right to left, then N is an upper bound for each possible choice of a_i such that $\mathfrak{S}_{\lambda, \mathbf{a}}$ is nonempty. In particular, the above sum is finite.

Lemma 1. *Let $\mathbf{a} = (a_1, \dots, a_r)$, and let $\mu = (N - a_1, \dots, N - a_r)$. Then the Boltzmann weight of every state in $\mathfrak{S}_{\lambda, \mathbf{a}}$ equals \mathbf{z}^μ times a polynomial in v .*

Proof. Consulting Figure 2 we see that the power of z_i equals the number of vertices in the i -th row whose configuration of adjacent spins is of type a_2, b_2 or c_1 . These are exactly the cases where the vertex to the left of the vertex is $-$, that is, precisely those that do not contribute to the charge at the left edge of the row. Since this charge is a_i , the power of z_i that occurs is $N - a_i = \mu_i$. \square

Thus we will call μ the *weight* of the state. Let W be the Weyl group of Λ , which is the symmetric group S_r .

Proposition 2. *Suppose that $\mu = (\mu_1, \dots, \mu_r)$ is a weight with $0 \leq \mu_i \leq N$, and suppose that the μ_i are all distinct. Let $a_i = N - \mu_i$. Then there exists a dominant weight λ such that for every permutation $w \in W$ the system $\mathfrak{S}_{\lambda, w(\mathbf{a})}$ consists of a single element. The Boltzmann weight of this state is $\mathbf{z}^{w\lambda}$ times a nonzero constant depending only on w .*

Proof. Since μ has distinct entries, there exists a dominant weight λ such that the μ_i are the elements of $\lambda + \rho$, permuted. We will show that \mathfrak{S}_λ has a unique state with weight $w(\mu)$ for any w in W .

We will make use of the bijection between states of \mathfrak{S}_λ and strict Gelfand-Tsetlin patterns with top row λ . (A Gelfand-Tsetlin pattern is called *strict* if its rows are strictly decreasing.) This bijection is explained in [5], [6], and [7] (Proposition 19.5). Briefly, the elements of the i -th row of the pattern consists of the columns in which there are $-$ spins in the vertical edges above the vertices in the i -th row of the grid. Thus the state illustrated in Figure 1 corresponds to the Gelfand-Tsetlin pattern

$$\left\{ \begin{array}{ccc} 5 & 3 & 0 \\ & 5 & 2 \\ & & 2 \end{array} \right\}.$$

The weight of the state can be read off from the pattern: the exponents of z_1, z_2, \dots are the differences between consecutive row sums. This is Lemma 11 in [6]. In the example above, the row sums are 8, 7, and 2, and so the weight is $(8 - 7, 7 - 2, 2) = (1, 5, 2)$, and indeed, the Boltzmann weight is $h(2)g(4)z_1^1z_2^5z_3^2$.

A pattern is called *stable* if the corresponding pattern involves no vertices in configuration c_1 . By Proposition 1, any c_2 configuration that occurs has charge 0. Consequently, every vertex has weight 1, or z_i or $g(a)$ for some a . In terms of the Gelfand-Tsetlin pattern, every entry (except of course those of the top row) equals one of the two above it, since otherwise (it is easy to see) it would produce an configuration of type c_1 . This means that each row of the pattern (except the first row, which is $\lambda + \rho$) is obtained from the row above it by deleting a single entry, and so the differences of the row sums are the entries of the top row in some order. There are thus $r!$ stable patterns, and their weights are permutations of $\lambda + \rho$, that is, permutations of μ . It is clear from the Gelfand-Tsetlin description that these are the extremal weights that can occur; in other words, every weight lies in the convex hull of the polytope spanned by the weights of the stable patterns, that is, by the $w(\mu)$ with $w \in W$. Moreover, only the stable pattern can produce such a weight, so the weights $w(\mu)$ are each produced by a unique state. It follows that if $\mathbf{a} = (N - \mu_1, \dots, N - \mu_r)$, then $\mathfrak{S}_{\lambda, \mathbf{a}}$ consists of a single state.

The Boltzmann weight of a stable state is nonzero, since (due to the fact that c_1 vertices do not appear and c_2 vertices only appear with charge 0) it equals $\mathbf{z}^{w(\mu)}$ times a product of $g(a)$, which do not vanish. \square

We will need a generalization of this statement. To this end, we slightly generalize the class of boundary conditions. We still require $+$ signs along the bottom vertical spins, and $-$ signs along the right-hand edge, but now, in addition to allowing both $+$ and $-$ spins along the top edge, we allow both $+$ and $-$ spins along the left edge. We will call such a system a *mixed system*.

Proposition 3. *Let $\alpha_1, \dots, \alpha_r$ be visible spins. Assume that the spins among these with $\alpha_i = +a_i$ have distinct charges a_i , and that the spins $-a_i$ have $a_i = 0$. Then there exists a mixed system that has a unique state with left edge spins α_i (in order).*

Proof. First we discard the α_i with spin $-$, and build a system as in Proposition 2. Then we modify this by inserting, corresponding to each α_i with spin $-$, another row with (as boundary conditions) $-$ on both the left and right edge. This system will have a unique solution with left edge spins α_i . The last step is to add back rows with $-$ spins to the left and right at the locations where the α_i with spin $-$ were discarded.

Let us illustrate this with an example. Suppose that $r = 3$, $N = 5$ and

$$\alpha_1 = +3, \quad \alpha_2 = -0, \quad \alpha_3 = +1.$$

First we discard α_2 . With $\mu = (N - a_1, N - a_3) = (2, 4)$ we must have $\lambda + \rho = (4, 2)$. This tells us the boundary condition of a 2-rowed system according to the recipe in Proposition 2. We construct the system with top row spins $-, +, -, +$ (in order) and left row spins $+, +$. In accordance with Proposition 2 this system has a unique state with left charges 2, 4 corresponding to α_1 and α_3 . This state is

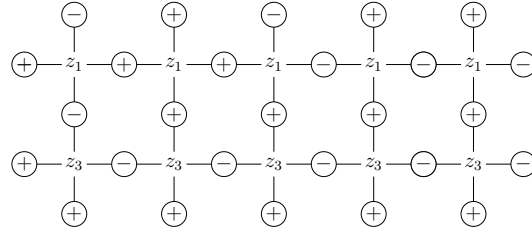

Now we insert a row of $-$ spins:

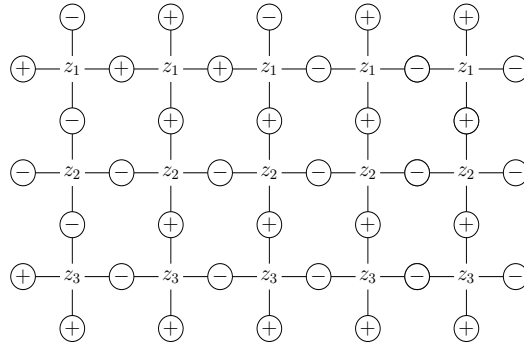

to obtain the desired mixed system. □

Let us prove Theorem 4. We will make two assumptions that we will remove later.

- We will assume that the α , β and γ appearing in (2) are decorated $+$ spins. Thus we write $\gamma = +a_1$, $\beta = +a_2$ and $\alpha = +a_3$ for some integer charges a_i .
- We will also assume that a_1 , a_2 and a_3 are distinct.

Note that both partition functions in (2) vanish unless δ , ϵ , and ϕ are a permutation of the α , β , and γ , and we will assume this.

Consider the system \mathfrak{S}_λ described in Proposition 2. The dependence of this system on $\mathbf{z} = (z_1, z_2, z_3)$ will be important and so we emphasize this by writing $\mathfrak{S}_\lambda(\mathbf{z})$. Begin by attaching the configurations in Theorem 4 to the left of the three-rowed system $\mathfrak{S}_\lambda(\mathbf{z})$ as

follows:

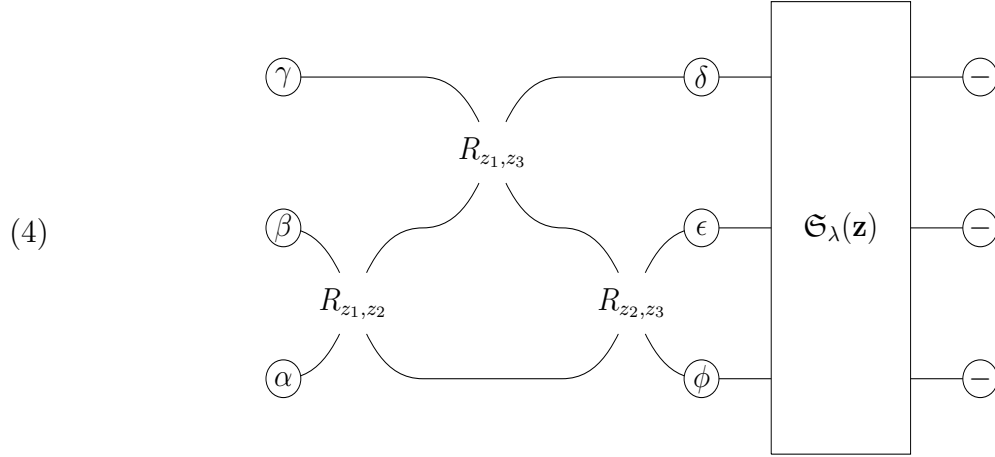

We are now regarding α , β and γ as fixed boundary spins, part of the boundary conditions. However ϕ , ϵ and δ are interior spins and must be summed over, though as we have noted, only a permutation of α , β and γ can produce a nonzero weight.

By Proposition 2, if

$$\delta = +a_{w(1)}, \quad \epsilon = +a_{w(2)}, \quad \phi = +a_{w(3)},$$

then $\mathfrak{S}_{\lambda, w(\mathbf{a})}$ consists of a single state whose Boltzmann weight is $\mathbf{g}(w)\mathbf{z}^{w(\mu)}$ for some nonzero value $\mathbf{g}(w)$ made from Gauss sums. Let $B(w)$ and $C(w)$ be the partition functions of the two systems in Theorem 4, when w is the permutation of γ , β , α that produces ϕ , ϵ , δ . We have proved that the composite system described above has partition function

$$\sum_{w \in W} B(w) \mathbf{g}(w) \mathbf{z}^{w(\mu)}.$$

On the other hand, using the Yang-Baxter equation of Theorem 3, (4) equals the partition function of

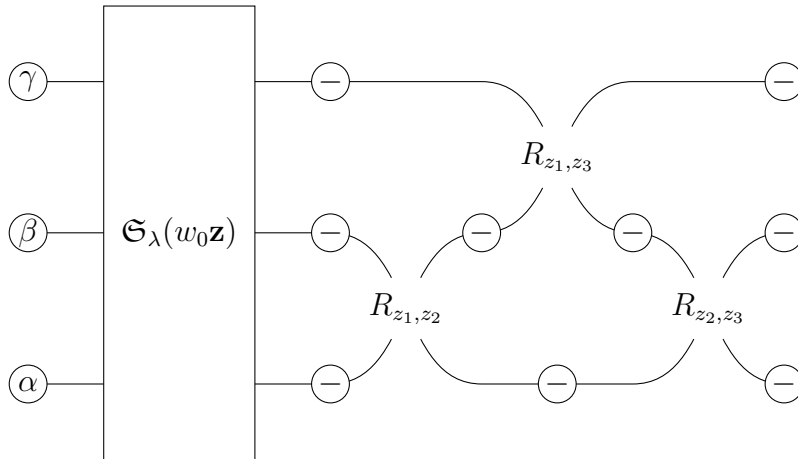

Here $w_0 \mathbf{z} = (z_3, z_2, z_1)$. Although the spins of interior edges are summed over all possibilities, we have taken the liberty of filling in the spins of six interior edges that are forced to be -0 because, according to the Boltzmann weights in Figure 3, each R_{z_i, z_j} has only one admissible

state with right edge spins zero. We may fill in the values of these states and we have proved that

$$\sum_{w \in W} B(w) \mathbf{g}(w) \mathbf{z}^{w(\mu)} = (z_1^n - vz_2^n)(z_1^n - vz_3^n)(z_2^n - vz_3^n) Z(\mathfrak{S}_\lambda(w_0 \mathbf{z})).$$

Identical arguments apply when we attach the second configuration in Theorem 4 to the same system $\mathfrak{S}_\lambda(\mathbf{z})$ producing the same evaluation, and therefore

$$(5) \quad \sum_{w \in W} B(w) \mathbf{g}(w) \mathbf{z}^{w(\mu)} = \sum_{w \in W} C(w) \mathbf{g}(w) \mathbf{z}^{w(\mu)}.$$

We need to deduce from this that each individual term agrees, namely $B(w) = C(w)$, which is the content of Theorem 4. This requires a new idea. Even though we have repeatedly insisted for the purpose of this proof that the charges are integers, not integers modulo n , we may still make use of the periodicity of the Boltzmann weights. Let K be some large positive integer that is a multiple of n . Recalling that $\gamma = +a_1$, $\beta = +a_2$ and $\delta = +a_3$, let $\gamma' = +a'_1$, $\beta' = +a'_2$, $\alpha' = +a'_3$, where

$$(a'_1, a'_2, a'_3) = (a_1, a_2, a_3) + (2K, K, 0).$$

Moreover, recalling that δ, ϵ, ϕ are permutations of γ, β, α (since otherwise Theorem 4 is trivially true), let $\delta', \epsilon', \phi'$ be the corresponding permutation of α', β', γ' . By the charge-periodicity of the Boltzmann weights for R_{z_1, z_2} , and because $\alpha \equiv \alpha'$ modulo n , etc. the partition function of the first configuration in Theorem 4 equals the partition function of

$$(6) \quad \begin{array}{ccc} \textcircled{\gamma'} & & \textcircled{\delta'} \\ & \text{---} R_{z_1, z_3} \text{---} & \\ & \text{---} R_{z_1, z_2} \text{---} & \text{---} R_{z_2, z_3} \text{---} \\ \textcircled{\beta'} & & \textcircled{\epsilon'} \\ \textcircled{\alpha'} & & \textcircled{\phi'} \end{array} .$$

Before proceeding, we may now remove one of the two assumptions that we imposed on the boundary spins. We will continue to assume that α, β and γ are decorated $+$ spins, but we may drop the assumption that the a_i are distinct. Because we will be applying (5) to the last configuration, we will need the a'_i to be distinct, but this will certainly be true if K is sufficiently large. Let us suppose for the sake of explanation that $a_1 = a_2$, and that $\beta = \gamma = \delta = \epsilon$ while a_3 is distinct. Using (3) we see that the first partition function in Theorem 4 equals the sum of the partition functions (6) plus another similar one with β' and γ' interchanged. Since the same is true of the second partition function in Theorem 4, this is sufficient.

Let A_0 be the \mathbb{C} -algebra generated by v and the $g(a)$. Given an expression

$$\xi = \sum_{\mu \in \Lambda} c(\mu) \mathbf{z}^\mu, \quad c(\mu) \in A_0,$$

we define $\text{supp}(\xi) = \{\mu \in \Lambda \mid c(\mu) \neq 0\}$. We will use the following trivial observation to separate out the individual terms in (5). Namely, if $\xi + \eta = \xi' + \eta'$ and $\text{supp}(\xi) \cup \text{supp}(\xi')$ is disjoint from $\text{supp}(\eta) \cup \text{supp}(\eta')$ then $\xi = \xi'$ and $\eta = \eta'$. Now, consider what happens to

the supports of the individual terms on both sides of (5) as we increase K . (This requires increasing N , but that is harmless.) As we vary K , the support of $B(w)$ and $C(w)$ are unchanged. However as the vector $\mu = (N - a_1 - 2K, N - a_1 - K)$ becomes increasingly antidominant the weights $w(\mu)$ move apart. Hence if K is large enough, the individual terms on both sides have disjoint support, and we conclude that they are individually equal. Recalling that $\mathfrak{g}(w) \neq 0$, this proves that $B(w) = C(w)$ for all w .

Theorem 4 is now proved except that we must remove the assumption that α , β and γ are decorated $+$ spins. This can be accomplished by a similar argument making use of the systems in Proposition 3. We leave the details to the reader. Theorem 5 is simpler and may be proved in the same way.

6. METAPLECTIC ICE AND SUPERSYMMETRY

Perk and Schultz [30] found new solutions of the Yang-Baxter equation. Meanwhile graded (supersymmetric) Yang-Baxter equations were introduced by Bazhanov and Shadrnikov [3]. It was found by Yamane [34] that the Perk-Schultz equations were related to the R -matrix of the quantized enveloping algebra of the $\mathfrak{gl}(m|n)$ Lie superalgebra in the standard representation. The quantized enveloping algebra of the corresponding affine Lie superalgebra was considered by [36]. A convenient reference for us is Kojima [20]. See also Zhang [35].

We will explain how to relate Theorem 4 to the $\mathfrak{gl}(1|n)$ R -matrix. The relationship is not an entirely simple one, since we will have to perform manipulations on the Perk-Schultz R -matrix in order to make the comparison. These manipulations preserve the Yang-Baxter equation, but (among other things) they introduce the Gauss sum $g(a)$ and in our view this is a nontrivial change. For example, the partition functions on Section 2 would be fundamentally changed without the $g(a)$. They could not be used as p -parts of multiple Dirichlet series ([5, 7]). Therefore, although we are able to relate the Yang-Baxter equation in Theorem 4 to the Perk-Schultz equation, the relationship is more subtle than one might guess.

The quantized enveloping algebra of $\mathfrak{gl}(1|n)$ (or its affinization) has a universal R -matrix which produces an R -matrix in $\text{End}(V_1 \otimes V_2)$ where V_1 and V_2 are any pair of modules. Taking three such modules, there is then a graded Yang-Baxter equation in $\text{End}(V_1 \otimes V_2 \otimes V_3)$ which we wish to compare with that in Theorem 4. We will be interested in the standard module, which is a graded $(1|n)$ -dimensional vector space. Using the corresponding affine Lie superalgebra produces one copy of this module for every value of a parameter $z \in \mathbb{C}^\times$, which may be identified with the parameter in Figure 2. A basis of the graded $(1|n)$ -dimensional vector space can be taken to be the decorated edge spins -0 for the even part, and $+a$ with a modulo n for the odd part. As noted by Kojima [20], we may change some signs in the graded Yang-Baxter equation to produce an ungraded Yang-Baxter equation. We will return to this point at the very end of the discussion.

Referring to [20] for notation, we will take the decorated spin -0 to have graded degree 0, and the spins $+a$, where a is an integer modulo n , to have degree 1. Thus we are concerned with $\widehat{\mathfrak{gl}}(1|n)$. In Figure 4 we have the Boltzmann weights from Figure 3 divided by z_1^n , compared with the corresponding coefficients from (2.4)-(2.7) of [20] which we have multiplied by the constant $1 - q^2 z$.

We will give two ways of modifying the R -matrix to obtain another R -matrix that is also a solution of the Yang-Baxter equation. One method only affects the weights in cases III,

VII and VIII. The other only affects the weights in cases II, V and VI. After these changes, we will be able to match the Kojima Boltzmann weights up to sign, with $z = z_2/z_1$ and $q^2 = v$. (Then we will have to discuss the sign.)

	This paper	Kojima		This paper	Kojima
I. 	$(z_2/z_1)^n - v$	$z - q^2$	V. 	$v(1 - (z_2/z_1)^n)$	$q(1 - z)$
II. 	$g(a - b)(1 - (z_2/z_1)^n)$	$q(1 - z)$	VI. 	$1 - (z_2/z_1)^n$	$q(1 - z)$
III. 	$(1 - v)(z_2/z_1)^{n-a+b}$ $(1 - v)(z_2/z_1)^{-a+b}$	$z(q^2 - 1)$ if $a > b$, $(q^2 - 1)$ if $a < b$	VII. 	$(1 - v)(z_2/z_1)^{n-a}$	$z(1 - q^2)$
IV. 	$1 - v(z_2/z_1)^n$	$q^2 z - 1$	VIII. 	$(1 - v)(z_2/z_1)^a$	$1 - q^2$

FIGURE 4. Left: The R -matrix from Figure 3, divided by z_1^n . Right: the Boltzmann weights of Kojima's $\widehat{\mathfrak{gl}}(1|n)$ R -matrix multiplied by $1 - q^2 z$. Just taking the first three cases (and discarding any case with a decorated spin -0) gives the $\widehat{\mathfrak{gl}}(n)$ R -matrix.

For each nonzero complex number z , let $V(z)$ be an $n + 1$ dimensional vector space with basis $v_\alpha = v_\alpha(z)$, where α runs through $n + 1$ “decorated spins.” These are the ordered pairs $+a$ with $0 \leq a < n$ and -0 .

Previously we interpreted the vertex R_{z_1, z_2} as a vertex in a graph with certain Boltzmann weights attached to it. We now reinterpret it as an endomorphism of a vector space, as usual in the application of quantum groups to solvable lattice models. If $\alpha, \beta, \gamma, \delta$ are decorated spins, let $R_{\alpha, \beta}^{\gamma, \delta}(z_1, z_2)$ be the Boltzmann weight of vertex R_{z_1, z_2} with the decorated spins $\alpha, \beta, \gamma, \delta$ arranged as follows:

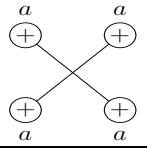
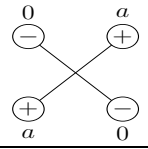
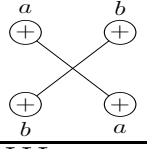
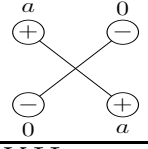
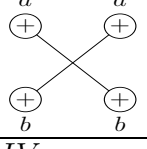
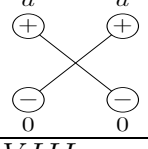
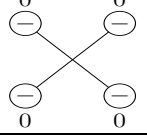
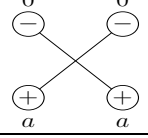
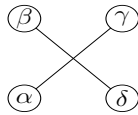

We assemble these into an endomorphism R_{z_1, z_2} of $V(z_1) \otimes V(z_2)$ as follows:

$$R_{z_1, z_2}(v_\alpha \otimes v_\beta) = \sum_{\gamma, \delta} R_{\alpha, \beta}^{\gamma, \delta}(z_1, z_2) v_\gamma \otimes v_\delta.$$

Lemma 2. *We have*

$$(7) \quad (R_{z_2, z_3})_{23} (R_{z_1, z_3})_{13} (R_{z_1, z_2})_{12} = (R_{z_1, z_2})_{12} (R_{z_1, z_3})_{13} (R_{z_2, z_3})_{23}$$

as endomorphisms of $V(z_1) \otimes V(z_2) \otimes V(z_3)$.

Here the notation is (as usual in quantum group theory) that R_{ij} where $1 \leq i < j \leq 3$ means a matrix R acting on the i, j components in $V(z_1) \otimes V(z_2) \otimes V(z_3)$ with the identity acting on the third component.

Proof. Applying the left-hand side of (7) to $v_\alpha \otimes v_\beta \otimes v_\gamma$ and extracting the coefficient of $v_\delta \otimes v_\varepsilon \otimes v_\phi$; the coefficient is found to be

$$\sum_{\mu, \nu, \sigma} R_{\alpha, \beta}^{\mu, \sigma}(z_1, z_2) R_{\mu, \gamma}^{\delta, \nu}(z_1, z_3) R_{\sigma, \nu}^{\varepsilon, \phi}(z_2, z_3),$$

which is the partition of the first system in Theorem 4. The same calculation applied to the right hand side of (7) gives the partition function of the second system in Theorem 4. So they are equal. \square

We will now describe two operations that one may perform on the Boltzmann weights that do not affect the validity of the Yang-Baxter equation.

Change of basis. We may change basis in $V(z)$. Let $f(\alpha, z)$ be a function of a decorated spin α and a complex number z . Let $u_\alpha = f(\alpha, z)v_\alpha$ for $v_\alpha \in V(z)$. Then

$$R_{z_1, z_2}(u_\alpha \otimes u_\beta) = \sum_{\gamma, \delta} \hat{R}_{\alpha, \beta}^{\gamma, \delta}(z_1, z_2) u_\gamma \otimes u_\delta$$

where

$$(8) \quad \hat{R}_{\alpha, \beta}^{\gamma, \delta} = \frac{f(\alpha, z_1)f(\beta, z_2)}{f(\gamma, z_1)f(\delta, z_2)} R_{\alpha, \beta}^{\gamma, \delta}.$$

Note that replacing R by \hat{R} only affects the weights in cases III, VII, and VIII in Figure 4.

Let us translate this into the language of Boltzmann weights. At the moment we are only concerned with Theorem 4. Later in Section 9 we will apply this technique to the first Yang-Baxter equation in Theorem 3. Thus we note the affect on the weights for both types of vertices. Taking the Boltzmann weights from Figures 3 and 2, with z_i and z_j as in those figures, the weights of



will respectively be multiplied by

$$(9) \quad \frac{f(\alpha, z_i)f(\beta, z_j)}{f(\gamma, z_i)f(\delta, z_j)}, \quad \frac{f(\alpha, z_i)}{f(\beta, z_i)}.$$

The first statement is a paraphrase of (8), and the second is checked the same way.

Returning to the comparison with Kojima's weights, we take

$$f(\alpha, z) = \begin{cases} z^a, & \alpha = +a, \\ 1 & \alpha = -0 \end{cases}$$

This puts our R -matrix into agreement with Kojima in cases III, VII, and VIII but has no effect on the other cases.

Twisting. The modification in the previous subsection did not fundamentally change the R -matrix. We simply made a change of basis in the vector space on which it acts. In this section we will consider a more fundamental change of the R -matrix which does not affect the validity of the Yang-Baxter equation. This procedure is closely related to Drinfeld [13] twisting, a procedure which modifies a Hopf algebra. See Majid [24], Theorem 2.3.4 and Chari and Pressley [10] Section 4.2.E. In Reshetikhin [31] section 3, Drinfeld twisting is used to obtain multiparameter deformations of $U_q(\mathfrak{sl}(n))$.

The procedure we will use to introduce Gauss sums into the R -matrix corresponds to a similar multiparameter deformation of $U_v(\widehat{\mathfrak{gl}}(n|1))$. We can give a simple explanation of this by making use of a feature of the Boltzmann weights in Figure 3. That is, if we have a nonzero weight for the vertex of form

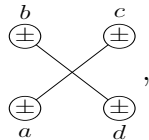

then either $a = c$ and $b = d$ or $a = d$ and $b = c$.

Now let us consider a modification of the Boltzmann weights in case II. We will multiply this weight by a function $\phi(a, b)$ of the decorations a, b that has the following properties. First, it is independent of z_1 and z_2 . Second, $\phi(a, b)\phi(b, a) = 1$.

Proposition 4. *If \tilde{R} is the R -matrix with this modification of the weights in case II, then \tilde{R} also satisfies the same Yang-Baxter equation that R does (Theorem 4).*

Proof. From the Boltzmann weights in Figure 4, we see that the decorated spins of the two edges to the right of the vertex will have the same decorations as the two edges to the left of the vertex, in some order. Therefore, referring to the proof of Theorem 4, if either partition function is nonzero, the decorated spins δ, ϵ and ϕ must be the same as α, β and γ in some order. From this ordering, we may infer the number of case II vertices, and (with an exception to be explained below) it will be the same for both partition functions. That is, if $+a$ and $+b$ occur on the left in the opposite order that they do on the right, then a case II crossing must occur somewhere on a vertex between the four edges. And this will be true on both sides of the equation, so multiplying the case II Boltzmann weight by $\phi(a, b)$ will have the same effect on both sides of the equation.

The exception is that if two weights appear in the same order on the left and right, there may be two case II vertices or none between them. Thus suppose that $\alpha = \phi = +a$ and $\beta = \epsilon = +b$. Then in the first partition function in Theorem 5 we may have R_{z_1, z_2} and R_{z_2, z_3} either both in case II or both in case III. However if they are both in case II, the factor that we have to multiply is $\phi(a, b)\phi(b, a)$, which equals 1 by assumption. \square

We may use this method of twisting in order to remove the $g(a - b)$ in case II, and replace them by q , since $g(a - b)g(b - a) = v = q^2$. We may also adjust the weights in cases V and VI so that in both cases the coefficient agrees with Kojima's weights.

Using the two methods available to us, we see that we can adjust the Boltzmann weights to agree with Kojima's, up to sign. We must now discuss the sign. We have agreement for all signs except case IV. As Kojima notes (below his equation (2.12)) his R -matrix, being supersymmetric, satisfies a graded Yang-Baxter equation. As he points out, an ungraded Yang-Baxter equation may be obtained by changing the sign when all edges are odd-graded. For us, this would mean changing the sign in cases I, II and III. However it works equally well to change the sign in the case where all edges are even-graded, that is, in case IV.

In conclusion, the supersymmetric Yang-Baxter equation in Kojima [20] is equivalent to our Theorem 4.

7. METAPLECTIC PRELIMINARIES

In these last sections of the paper, we present a more refined version of Theorem 2, an identity between Whittaker functions on metaplectic covers of $GL(r)$ and the partition functions of Section 2. Moreover we connect intertwining operators for metaplectic principal series representations to the Boltzmann weights in the R -matrix given in Figure 3. Before getting to these, we need to introduce the metaplectic group over a local field and its representation theory. In describing this construction, we rely on the prior work and notation of McNamara in [27] and [28], building on the foundational papers of Matsumoto [25] and Kazhdan-Patterson [19]. The reader should refer to these works for complete details; we say just enough here to make the presentation self-contained.

Let F be a non-archimedean local field with ring of integers \mathfrak{o}_F and a choice of local uniformizer ϖ . Let q be the cardinality of the residue field $\mathfrak{o}_F/\varpi\mathfrak{o}_F$. Let n be a fixed positive integer. We assume that $q \equiv 1 \pmod{2n}$ so that F contains the $2n$ -th roots of unity. Let μ_n denote the group of n -th roots of unity in F and fix an embedding $\epsilon : \mu_n \rightarrow \mathbb{C}^\times$.

Let $G := GL(r, F)$ with maximal split torus $T(F)$. We begin by constructing a metaplectic n -fold cover of G , denoted $\tilde{G}^{(n)}$ or just \tilde{G} when the degree of the cover is understood. Recall that \tilde{G} is constructed as a central extension of G by μ_n :

$$1 \longrightarrow \mu_n \longrightarrow \tilde{G} \xrightarrow{p} G \longrightarrow 1.$$

Thus as a set, $\tilde{G} \simeq G \times \mu_n$, but the multiplication in \tilde{G} is dictated by a choice of cocycle in $H^2(G, \mu_n)$. One may construct the cocycle explicitly, as in Kubota [21], Matsumoto [25], Kazhdan and Patterson [19] and Banks-Levi-Sepanski [1], or realize the central extension as coming from an extension of $K_2(F)$ constructed by Brylinski-Deligne [8]. For the applications at hand, we need only a few facts about the multiplication on $\tilde{T} = p^{-1}(T)$, the inverse image of a maximal split torus $T := T(F)$ in G , and the splitting properties of some familiar subgroups.

Our cocycle $\sigma \in H^2(G, \mu_n)$ is chosen so that its restriction to $T(F) \times T(F) \rightarrow \mu_n$ is given on any \mathbf{x}, \mathbf{y} in $T(F)$ explicitly by

$$(10) \quad \sigma(\mathbf{x}, \mathbf{y}) = \sigma \left(\left(\begin{pmatrix} x_1 & & \\ & \ddots & \\ & & x_r \end{pmatrix}, \begin{pmatrix} y_1 & & \\ & \ddots & \\ & & y_r \end{pmatrix} \right) \right) = (\det(\mathbf{x}), \det(\mathbf{y}))_{2n} \prod_{i>j} (x_i, y_j)^{-1},$$

where $(\cdot, \cdot) : F^\times \times F^\times \rightarrow \mu_n$ is the n -th power Hilbert symbol and $(\cdot, \cdot)_{2n}$ is the $2n$ -th power Hilbert symbol. In this formula the Hilbert symbol (a, b) is the unramified n -th norm residue symbol. It is defined, for $a, b \in F^\times$ to be the image of the unit

$$\left((-1)^{v(a)v(b)} \frac{a^{v(b)}}{b^{v(a)}} \right)^{\frac{q-1}{n}},$$

under a fixed n -th order character of $(\mathfrak{o}/\varpi\mathfrak{o})^\times$. General properties of the Hilbert symbol may be found in [29] noting that the symbol there is the inverse of ours; one property we use frequently is that $(x, x) = 1$ for any element $x \in F^\times$, since F contains the $2n$ -th roots of unity.

The cocycle σ in (10) is the inverse of the one appearing on p. 39 of [19]. A short computation shows that the commutator of any pair of elements $\tilde{\mathbf{x}}, \tilde{\mathbf{y}}$ in \tilde{T} projecting to \mathbf{x} and \mathbf{y} , respectively, in $T(F)$ is

$$(11) \quad [\tilde{\mathbf{x}}, \tilde{\mathbf{y}}] = \prod_{i=1}^r (x_i, y_i).$$

In particular if $x, y \in F^\times$ and λ, μ are elements of $X_*(T)$, let $\widetilde{\lambda(x)}, \widetilde{\mu(y)} \in \tilde{T}$ map to x^λ and y^μ , respectively, under the projection p to $T(F)$. Then according to (11),

$$(12) \quad [\widetilde{\lambda(x)}, \widetilde{\mu(y)}] = (x, y)^{\langle \lambda, \mu \rangle},$$

where $\langle \cdot, \cdot \rangle$ denotes the usual dot product on $X_*(T) \simeq \mathbb{Z}^r$.

In order to make use of results in [28], we must connect this explicit construction to the one used there. In [28] the construction of \tilde{G} is obtained by first constructing the extension of $G(F)$ by $K_2(F)$ using a W -invariant quadratic form Q , and then using a push forward from $K_2(F)$ to the residue field, containing μ_n . The calculation in (12) implies that the bilinear form $B(\lambda, \mu) := Q(\lambda + \mu) - Q(\lambda) - Q(\mu)$ for our extension, as described in Equation (2.1) of [28], is given by the dot product.

Finally, we record that the cocycle splits over any unipotent subgroup and over the maximal compact subgroup $K = G(\mathfrak{o})$ has a splitting in \tilde{G} . The splitting over the maximal unipotent is clear from the description of the cocycle in [19] and the splitting over K is their Proposition 0.1.2.

Next we recall the construction of unramified principal series on \tilde{G} . Let $H := C_{\tilde{T}}(\tilde{T}(\mathfrak{o}))$ denote the centralizer of $\tilde{T} \cap K$ in \tilde{T} . The subgroup H is abelian. It consists of elements in \tilde{T} whose projection to the torus $\mathfrak{t} = (t_1, \dots, t_r) \in T \simeq (F^\times)^r$ has $\text{ord}_\varpi(t_j) \equiv 0 \pmod{n}$ for $j = 1, \dots, r$. Thus we may identify $\tilde{T}/\mu_n\tilde{T}(\mathfrak{o})$ and $H/\mu_n\tilde{T}(\mathfrak{o})$ with lattices Λ and $n\Lambda$, respectively. In particular Λ is isomorphic to the cocharacter lattice $X_*(T)$ of T . The map $\lambda \mapsto \varpi^\lambda$ induces an isomorphism from $X_*(T)$ to $T/T(\mathfrak{o})$. Let $\mathbf{s} : G \rightarrow \tilde{G}$ denote the standard section. By abuse of notation we will also denote by ϖ^λ the image of ϖ^λ under \mathbf{s} . Thus coset representatives for \tilde{T}/H may be taken of the form ϖ^λ with $\lambda \in X_*(T)$.

The principal series is constructed starting from a genuine character χ on H , trivial on $\tilde{T} \cap K$; we call these characters ‘‘unramified.’’ First we induce the character χ up to \tilde{T} , and denote the resulting representation by $i(\chi) = \text{Ind}_H^{\tilde{T}}(\chi)$. Then we perform normalized parabolic induction to obtain a representation of \tilde{G} . This is done by first inflating the representation from \tilde{T} to \tilde{B} , the inverse image of the standard Borel subgroup $B \supset T$ in

G and then inducing to obtain $I(\chi) := \text{Ind}_{\tilde{B}}^{\tilde{G}}(i(\chi))$. Explicitly $I(\chi)$ is the space of locally constant functions $f : \tilde{G} \rightarrow i(\chi)$ such that

$$f(bg) = \delta^{1/2} \chi(b) f(g) \quad \text{for all } g \in \tilde{G}, b \in \tilde{B},$$

where δ denotes the modular quasicharacter. Thus $I(\chi)$ is a \tilde{G} -module under the action of right translation. Let ϕ_K denote any of the $i(\chi)$ -valued functions in the one dimensional space of K -fixed vectors in $I(\chi)$; our results will be independent of this choice.

8. INTERTWINING OPERATORS AND WHITTAKER FUNCTIONS

For any positive root $\alpha \in \Phi^+$, let U_α denote the one-parameter unipotent subgroup corresponding to the embedding $\iota_\alpha : SL_2 \rightarrow G$. To any element $w \in W$, we may define the unipotent subgroup U_w by

$$U_w := \prod_{\alpha \in \Phi^+, w(\alpha) \in \Phi^-} U_\alpha.$$

Then define the intertwining operator $\mathcal{A}_w : I(\chi) \rightarrow I(w\chi)$ by

$$(13) \quad \mathcal{A}_w(f)(g) := \int_{U_w} f(w^{-1}ug) du$$

whenever the above integral is absolutely convergent, and by the usual meromorphic continuation in general. Recall that on any spherical vector ϕ_K ,

$$\mathcal{A}_w \phi_K^\chi = c_w(\chi) \phi_K^{w\chi}$$

where for any simple reflections $s = s_\alpha$ and any w such that the length function $\ell(s_\alpha w) = \ell(w) + 1$,

$$c_s(\chi) = \frac{1 - q^{-1} \mathbf{z}^{-n\alpha}}{1 - \mathbf{z}^{-n\alpha}}, \quad \text{and} \quad c_{sw}(\chi) = c_s(\chi^w) c_w(\chi).$$

Let $\bar{\mathcal{A}}_w$ denote the normalized intertwiner:

$$(14) \quad \bar{\mathcal{A}}_w := c_w(\chi)^{-1} \mathcal{A}_w.$$

Recall that, to any unramified character ψ on U , the unipotent radical of B , a Whittaker functional on a representation (π, V) of \tilde{G} is a linear functional W for which

$$W(\pi(u)v) = \psi(u)W(v) \quad \text{for all } u \in U \text{ and } v \in V.$$

As stated in Section 6 of [28], the dimension of the space of Whittaker functionals for the principal series $I(\chi)$ is equal to the cardinality of \tilde{T}/H . If we let \mathcal{W}^χ be the $i(\chi)$ -valued Whittaker functional on $I(\chi)$ defined by

$$\mathcal{W}^\chi(\phi) := \int_{U^-} \phi(uw_0) \psi(u) du : I(\chi) \rightarrow i(\chi),$$

then there is an isomorphism between the linear dual $i(\chi)^*$ and Whittaker functionals to \mathbb{C} on $I(\chi)$ given by

$$(15) \quad \mathcal{L} \mapsto \mathcal{L}(\mathcal{W}^\chi), \quad \text{for } \mathcal{L} \text{ in } i(\chi)^*.$$

Let us describe a particularly nice basis of $i(\chi)^*$ for the computation of the spherical function under the Whittaker functional. Let $v_0 := \phi_K(1)$, an element of $i(\chi)$. Let π_χ denote the representation of \tilde{T} on $i(\chi)$. Then to any set of coset representatives b for \tilde{T}/H , the set

$\{\pi_\chi(b)v_0\}$ is a basis for the representation on $i(\chi)$. Let $\{\mathcal{L}_b^{(\chi)}\}$ denote the corresponding dual basis of $i(\chi)^*$. More explicitly, given any weight μ , we write $\mu = \beta + \gamma$ where β is one of the chosen coset representatives in $\Lambda/n\Lambda$ and $\gamma \in n\Lambda$, the lattice for our isotropic subgroup. Then writing our \tilde{T}/H coset representative $b = \varpi^\nu$, we define

$$(16) \quad \begin{aligned} \mathcal{L}_{\varpi^\nu}^{(\chi)}(\pi_\chi(\varpi^\mu)\phi_K(1)) &= \mathcal{L}_{\varpi^\nu}^{(\chi)}(\pi_\chi(\varpi^{\beta+\gamma})\phi_K(1)) = \chi(\varpi^\gamma)\mathcal{L}_{\varpi^\nu}^{(\chi)}(\pi_\chi(\varpi^\beta)\phi_K(1)) \\ &= \chi(\varpi^\gamma) \cdot \begin{cases} 1 & \beta = \nu, \\ 0 & \text{else.} \end{cases} \end{aligned}$$

Thus we obtain a corresponding basis of the space of Whittaker functionals on $I(\chi)$, denoted W_b^χ , according to the isomorphism (15).

We wish to investigate the functions $W_b^\chi(\pi(\varpi^\lambda)\phi_K)$ for dominant weights λ . Indeed, the Whittaker functions $g \mapsto W_b^\chi(\pi(g)\phi_K)$ are determined by their values on $T(F)/T(\mathfrak{o})$, and it is easily shown that these Whittaker functions vanish off of dominant weights. It is perhaps most natural to view $W_b^\chi(\pi(\varpi^\lambda)\phi_K)$ as a function of the Langlands parameters $\mathbf{z} = (z_1, \dots, z_r)$ defining the character $\chi =: \chi_{\mathbf{z}}$ on the subgroup H . Thinking in this way,

$$(17) \quad \mathbf{z} \mapsto W_b^{\chi_{\mathbf{z}}}(\pi(\varpi^\lambda)\phi_K)$$

takes values in $\mathcal{O}(\hat{T}) \simeq \text{Frac}(\mathbb{C}[\Lambda'])$, the field of fractions of the group algebra of the cocharacter lattice. Similarly, the functionals \mathcal{L}_b in $i(\chi_{\mathbf{z}})^*$ may be viewed as functions of \mathbf{z} taking values in $\mathcal{O}(\hat{T})$. We highlight that, from this point of view, the functional \mathcal{L}_b (and hence the corresponding Whittaker functional W_b) takes values on the subfield $\text{Frac}(\mathbb{C}[\Lambda])$, where Λ is the lattice corresponding to $H/\mu_n\tilde{T}(\mathfrak{o})$.

One approach to studying the resulting Whittaker function in (17), going back to Casselman and Shalika in the linear group case and used by Kazhdan and Patterson for metaplectic covers of $\text{GL}(r)$, is to exploit the fact that $\mathcal{W}^{w\chi} \circ \bar{\mathcal{A}}_w$ is an $i(\chi)$ valued Whittaker functional for $I(\chi)$. Composing with the functional \mathcal{L}_a for some coset representative $a \in \tilde{T}/H$, we obtain an expansion:

$$(18) \quad W_a^{\chi^w} \circ \bar{\mathcal{A}}_w = \sum_{b \in \tilde{T}/H} \tau_{a,b} W_b^\chi$$

for some rational functions $\tau_{a,b} := \tau_{a,b}^{(w)}(\mathbf{z})$ in $\text{Frac}(\mathbb{C}[\Lambda'])$. It suffices to understand these structure constants on simple reflections $w = s_\alpha$. These were computed for metaplectic covers of $\text{GL}(r)$ by Kazhdan and Patterson, and we discuss their explicit form in the following result. A nice alternate proof of this result is given as Theorem 13.1 in [28], and our notation more closely parallels this latter source. We take our coset representatives a, b for \tilde{T}/H of the form ϖ^μ with $\mu \in X_*(T)$ and use the more succinct notation $\tau_{\mu,\nu}(\mathbf{z})$ for their associated structure constants.

Proposition 5 (Kazhdan-Patterson, [19], Lemma I.3.3). *The structure constants $\tau_{\mu,\nu} := \tau_{\mu,\nu}^{(w)}$ for coset representatives $(a, b) = (\varpi^\mu, \varpi^\nu)$ appearing in (18) with $w = s_\alpha$, a simple reflection, can be broken into two pieces:*

$$\tau_{\mu,\nu} = \tau_{\mu,\nu}^1 + \tau_{\mu,\nu}^2$$

where τ^1 vanishes unless $\nu \sim \mu \bmod \Lambda$ and τ^2 vanishes unless $\nu \sim s(\mu) + \alpha \bmod \Lambda$. Moreover:

$$(19) \quad \tau_{\mu,\mu}^1 = (1 - q^{-1}) \frac{\mathbf{z}^{-n \lceil \frac{\langle \alpha, \mu \rangle}{n} \rceil \alpha}}{1 - q^{-1} \mathbf{z}^{-n\alpha}}$$

where $\lceil x \rceil$ denotes the smallest integer at least x , and

$$(20) \quad \tau_{\mu, s(\mu) + \alpha}^2 = g(\langle \alpha, \mu - \rho \rangle) \frac{1 - \mathbf{z}^{-n\alpha}}{1 - q^{-1} \mathbf{z}^{-n\alpha}}.$$

Remark. In order to translate from the notation of [28], we choose $Q(\alpha) = 1$ on simple roots α which then implies $n_\alpha := n / \gcd(n, Q(\alpha)) = n$. Our cocycle has been chosen so that $B(\alpha, \mu) = \langle \alpha, \mu \rangle$. Moreover, our n -th order Gauss sum g is denoted \mathfrak{g} in [28]. Finally, make the substitution $x_\alpha \mapsto \mathbf{z}^{-\alpha}$ in Theorem 13.1 of [28] to obtain the above formulas.

Remark. We caution the reader that τ^1 is not independent of the choice of representative $a = \varpi^\mu$ in the quotient $\Lambda/n\Lambda$. The function τ^2 does satisfy this property, since replacing μ by $\mu + \gamma$ with $\gamma \in \Lambda$ increases the inner product by a multiple of $n = n_\alpha$ which leaves the evaluation of the Gauss sum \mathfrak{g} fixed (as it depends only on the congruence class of the argument mod n). Note however, that the formula for τ^2 is only applicable if both μ and its “dot” action $s \cdot \mu = s(\mu) + \alpha$ are coset representatives.

9. INTERTWINING INTEGRALS AS R -MATRICES

Now specialize to the case $G = \mathrm{GL}(r)$. In this section, we prove relations between the spherical Whittaker functions $W_b^X(\pi(\varpi^\lambda)\phi_K)$ of the previous section and certain partition functions of metaplectic ice with fixed boundary charges. Then we show that the identity (18) is likewise expressible in terms of braided ice models, where the structure constants $\tau_{a,b}$ are given by corresponding R -vertices matching those in Figure 3 up to a simple normalization. We continue to assume that the set of coset representatives $b \in \tilde{T}/H$ are of the form $b = \varpi^\nu$ with $\nu \in X_*(T)$, considered as elements of \tilde{G} under the split section discussed above.

In order to compare Whittaker functions and metaplectic ice, we use a modified system of Boltzmann weights from those in Figures 2 and 3. The weights we need now are given in Figures 5 and 6. We remind the reader that in Section 2, we stressed that it suffices to consider only the decoration 0 associated to a $-$ spin, and the table below reflects this assumption. So we omit other $-a$ decorated spins with $a \neq 0$.

Proposition 6. *The Yang-Baxter equation is satisfied with the weights in Figures 5 and 6.*

Proof. To obtain these from the weights in Figure 2 and 3, we make use of the *change of basis* method described in Section 6. We take the function $f(\alpha, z)$ to equal

$$\begin{cases} z^a & \text{if } \alpha = +a, 0 \leq a < n, \\ 1 & \text{if } \alpha = -0. \end{cases}$$

In Figure 5 we further divide each weight by z_i , and in Figure 6 we divide by $z_1^n - \nu z_2^n$. These multiplications applies to all weights, so we may do this at our convenience without affecting the Yang-Baxter equation.

We only have to check that this procedure gives the advertised weights. Let us just check this for the a_1 case in Figure 5. The corresponding weight in Figure 2 is 1. If $a \neq n - 1$, then according to (9), we multiply by z_i^{a+1} and divide by z_i^a . However we are additionally

dividing by z_i , so we obtain 1, which is consistent with Figure 5 since $\delta(a+1) = 0$. On the other hand, if $a = n-1$, then $a+1$ modulo n is zero, so we multiply by 1 and divide by $z_i^a = z_i^{n-1}$. Additionally dividing by n , we obtain z_i^{-n} , which again equals $z_i^{-n\delta(a+1)}$. We leave the remaining cases to the reader. \square

a_1	a_2	b_1	b_2	c_1	c_2
					
$z_i^{-n\delta(a+1)}$	1	$g(a)z_i^{-n\delta(a+1)}$	1	$1 - v$	$z_i^{-n\delta(1)}$

FIGURE 5. Modified Boltzmann weights

Let e_i denote the weight $(0, \dots, 0, 1, 0, \dots, 0)$ with a 1 in the i -th position under the isomorphism $X_*(T) \simeq \mathbb{Z}^r$. Because we want to present very precise equalities between Whittaker functions and partition functions, we must choose specific representatives for the space of Whittaker functionals indexed by cosets in $\Lambda/n\Lambda$. We choose a basis for the space of Whittaker functionals consisting of W_b with $b = \pi^\nu$ and $\nu \in \Lambda$ of the form

$$(21) \quad \nu - \rho = c_1 e_1 + \dots + c_r e_r, \quad \text{with } c_i \in \{0, \dots, n-1\} \text{ for all } i.$$

Proposition 7. *Fix a dominant weight $\lambda = (\lambda_1, \dots, \lambda_r) \in \mathbb{Z}^r$. Given the coset representative $b = \varpi^\nu$ with $\nu - \rho = c_1 e_1 + \dots + c_r e_r$ with each $c_i \in \{0, \dots, n-1\}$. Then*

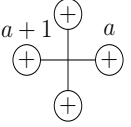
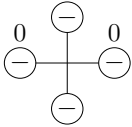
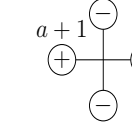
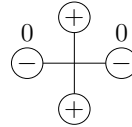
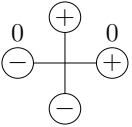
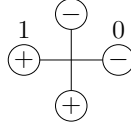
$$\mathbf{z}^{\nu-\rho} W_b(\pi_\chi(\varpi^\lambda) \phi_K) = z_1^{\lambda_1+r-c_1} \dots z_r^{\lambda_r+r-c_r} Z_\lambda(\mathbf{z}; c_1, \dots, c_r).$$

Proof. The result follows by refining theorems from the papers [5] and [26]. Indeed if we sum over all possible left-charge configurations $\mathbf{c} = (c_1, \dots, c_r)$ with $c_i \in \mathbb{Z}/n\mathbb{Z}$, then

$$(22) \quad \sum_{\mathbf{c}=(c_1, \dots, c_r) \in [0, n]^r} z_1^{\lambda_1+r-c_1} \dots z_r^{\lambda_r+r-c_r} Z_\lambda(\mathbf{z}; c_1, \dots, c_r)$$

is equal to the partition function called $Z(\mathfrak{S}^\Gamma) := Z(\mathfrak{S}_\lambda^\Gamma)$ in Section 3.4 of [5]. (Note the partition function in [5] is made using the Boltzmann weights from Figure 2, which are normalized slightly differently than the modified weights above and account for the monomial in \mathbf{z} in (22).) In Theorem 4 of [5], we explain that

$$(23) \quad Z(\mathfrak{S}^\Gamma) = \mathbf{z}^{-\rho} W^\circ(\varpi^\lambda) \quad \text{where} \quad W^\circ(\varpi^\lambda) := \mathcal{L}^\circ(\mathcal{W}(\pi_\chi(\varpi^\lambda) \phi_K))$$

and $\mathcal{L}^\circ : i(\chi) \rightarrow \mathbb{C}$ is the linear functional defined in Proposition 5.2 of [26]. More explicitly, \mathcal{L}° is defined as the unique functional \mathcal{L} such that, taking coset representatives of the form $b = \varpi^\nu$ for \tilde{T}/H , where H is the maximal abelian subgroup of \tilde{T} :

$$\mathcal{L}(\pi_\chi(b) \phi_K) = \chi(\varpi^\nu).$$

Here we have extended the definition of $\chi := \chi_{\mathbf{z}}$ on H to elements of the form ϖ^ν by

$$\chi(\varpi^\nu) = \mathbf{z}^\nu.$$

(Choosing the functional compatible with the choice of spherical vector ϕ_K in this way gives a result independent of the choice of spherical vector in the one-dimensional space of them.)

Recall from Lemma 1 that the partition function $Z_\lambda(\mathbf{z}; \lambda_1 + r - c_1, \dots, \lambda_1 + r - c_r)$ made from the weights in Figure 2 is the unique summand in (22) taking values in $\mathbb{C}[\Lambda]$ that are restricted to the coset $\mathbf{z}^c \mathbb{C}[n\Lambda]$. Thus using the modified weights of Figure 5, each summand

$$z_1^{\lambda_1+r-c_1} \dots z_r^{\lambda_1+r-c_r} Z_\lambda(\mathbf{z}; c_1, \dots, c_r)$$

appearing in (22) gives precisely the contribution to $W^\circ(\varpi^\lambda)$ taking values on the coset $z_1^{c_1} z_2^{c_2} \dots z_r^{c_r} \mathbb{C}[n\Lambda]$.

To finish, it remains to relate this functional \mathcal{L}° to the functionals \mathcal{L}_b with $\mathcal{L}_b \circ \mathcal{W} =: W_b$ defined above. From the definition of \mathcal{L}_b with $b = \varpi^\nu$, we see

$$\mathcal{L}^\circ = \sum_{b \in \tilde{T}/H} \chi(b) \mathcal{L}_b = \sum_{b \in \tilde{T}/H} \mathbf{z}^\nu \mathcal{L}_b,$$

so we immediately conclude that

$$(24) \quad W^\circ(\varpi^\lambda) = \sum_{b = \varpi^\nu \in \tilde{T}/H} \mathbf{z}^\nu W_b(\pi_\chi(\varpi^\lambda) \phi_K).$$

Since each of the functionals \mathcal{L}_b take values on $\mathbb{C}[n\Lambda]$, the summand $\mathbf{z}^\nu W_b(\pi_\chi(\varpi^\lambda) \phi_K)$ is the unique summand in (24) taking values on the coset $\mathbf{z}^\nu \mathbb{C}[n\Lambda]$. Combining this with (23) gives the result. \square

Now that we have connected the Whittaker models W_b to sums of partition functions on metaplectic ice with fixed boundary charge, we make a connection between braided ice (using the R -vertices for metaplectic ice discussed above) and the identity of Whittaker functionals in (18). It says that, with the right choice of normalization on the R -matrix, the structure constants $\tau_{a,b}^{(s)}$ are given by a subset of the R -vertices. More precisely, the Boltzmann weights associated to R -vertices needed for this matching are given in the following figure. They are obtained by dividing each of the entries in Figure 3 by the value of the a_2 R -vertex. We refer to the resulting system of weights as \hat{R} , which have be expressed in terms of $\mathbf{z}^{-\alpha}$ in the table. (For the application to metaplectic Whittaker functionals, set $v = q^{-1}$ as usual.)

In the table, we're assuming that charges depicted as a and b are in distinct residue classes mod n . In the case that $a \equiv b \pmod{n}$, the reader may easily check that the weight of the first entry in the top row above is equal to the sum of the weights of the second and third entries in the top row, analogous to the identity (3) earlier.

Proposition 8. *Let $\mu \in X_*(T) \simeq \mathbb{C}[\Lambda]$ with $\mu - \rho = c_1 e_1 + \dots + c_r e_r$ for some integers $c_i \in [0, n)$. Let $\tau_{\mu,\nu}(\mathbf{z}) := \tau_{\mu,\nu}^{(s_i)}(\mathbf{z})$ as in Proposition 5. Let wt be the weights for \hat{R} in Figure 6 above with $v = q^{-1}$. Given any pair of integers a, b with $a \equiv c_i$ and $b \equiv c_{i+1} \pmod{n}$, if $a \not\equiv b \pmod{n}$, then*

$$\tau_{\mu,\mu}^1(\mathbf{z}) = \text{wt} \left(\begin{array}{cc} \textcircled{+}^a & \textcircled{+}^a \\ \textcircled{+}^b & \textcircled{+}^b \end{array} \right) \quad \text{and} \quad \tau_{\mu, s_i(\mu) + \alpha_i}^2(\mathbf{z}) = \text{wt} \left(\begin{array}{cc} \textcircled{+}^a & \textcircled{+}^b \\ \textcircled{+}^b & \textcircled{+}^a \end{array} \right).$$

a_1  $\frac{-v + \mathbf{z}^{-n\alpha}}{1 - v\mathbf{z}^{-n\alpha}}$	 $g(a-b) \frac{1 - \mathbf{z}^{-n\alpha}}{1 - v\mathbf{z}^{-n\alpha}}$	 $\frac{(1-v)}{1 - v\mathbf{z}^{-n\alpha}} \cdot \begin{cases} \mathbf{z}^{-n\alpha} & \text{if } a > b, \\ 1 & \text{if } a < b, \end{cases}$	a_2  1
b_1  $\frac{v(1 - \mathbf{z}^{-n\alpha})}{1 - v\mathbf{z}^{-n\alpha}}$	b_2  $\frac{1 - \mathbf{z}^{-n\alpha}}{1 - v\mathbf{z}^{-n\alpha}}$	c_1  $\frac{(1-v)\mathbf{z}^{-n\alpha}}{1 - v\mathbf{z}^{-n\alpha}}$	c_2  $\frac{(1-v)}{1 - v\mathbf{z}^{-n\alpha}}$

FIGURE 6. Modified weights $\hat{R}_{\mathbf{z}}$. When combined with the weights in Figure 5, they satisfy a Yang-Baxter equation. This follows from Theorem 3.

If $a \equiv b \pmod{n}$, then

$$\tau_{\mu,\mu}^1(\mathbf{z}) + \tau_{\mu,s_i(\mu)+\alpha_i}^2(\mathbf{z}) = \text{wt} \left(\begin{array}{cc} \begin{array}{c} a \\ \oplus \end{array} & \begin{array}{c} a \\ \oplus \end{array} \\ \begin{array}{c} \oplus \\ a \end{array} & \begin{array}{c} \oplus \\ a \end{array} \end{array} \right).$$

Proof. Suppose that $a \not\equiv b \pmod{n}$. Then we must compare the weights in the above table with the results of Proposition 5. Recall from (19) that with $\alpha = \alpha_i$

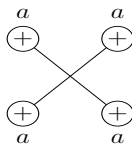
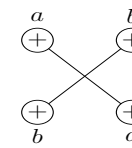
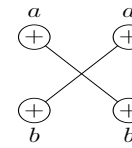
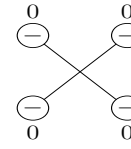
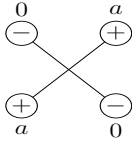
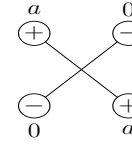
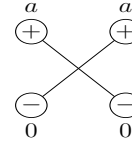
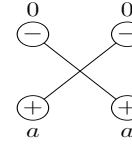
$$\tau_{\mu,\mu}^1 = (1 - q^{-1}) \frac{\mathbf{z}^{-n \lceil \frac{\langle \alpha, \mu \rangle}{n} \rceil \alpha}}{1 - q^{-1} \mathbf{z}^{-n\alpha}} = \frac{(1 - q^{-1})}{1 - q^{-1} \mathbf{z}^{-n\alpha}} \begin{cases} \mathbf{z}^{-n\alpha} & \text{if } c_i - c_{i+1} > 0 \\ 1 & \text{if } c_i - c_{i+1} \leq 0. \end{cases}$$

Since $c_i - c_{i+1} \equiv a - b$, the above matches the weight of the \hat{R} -vertex in the statement of the lemma according to Figure 6. From (20),

$$\tau_{\mu,s(\mu)+\alpha}^2 = g(\langle \alpha, \mu - \rho \rangle) \frac{1 - \mathbf{z}^{-n\alpha}}{1 - q^{-1} \mathbf{z}^{-n\alpha}} = g(a-b) \frac{1 - \mathbf{z}^{-n\alpha}}{1 - q^{-1} \mathbf{z}^{-n\alpha}}$$

since $\langle \alpha, \mu - \rho \rangle = c_i - c_{i+1} \equiv a - b \pmod{n}$.

If instead $a \equiv b \pmod{n}$, then the result follows from the identity of \hat{R} vertices analogous to (3):

$$(25) \quad \text{wt} \left(\begin{array}{cc} \begin{array}{c} a \\ \oplus \end{array} & \begin{array}{c} a \\ \oplus \end{array} \\ \begin{array}{c} \oplus \\ a \end{array} & \begin{array}{c} \oplus \\ a \end{array} \end{array} \right) = \text{wt} \left(\begin{array}{cc} \begin{array}{c} a \\ \oplus \end{array} & \begin{array}{c} b \\ \oplus \end{array} \\ \begin{array}{c} \oplus \\ b \end{array} & \begin{array}{c} \oplus \\ a \end{array} \end{array} \right) \Big|_{a=b} + \text{wt} \left(\begin{array}{cc} \begin{array}{c} a \\ \oplus \end{array} & \begin{array}{c} a \\ \oplus \end{array} \\ \begin{array}{c} \oplus \\ b \end{array} & \begin{array}{c} \oplus \\ b \end{array} \end{array} \right) \Big|_{a=b+0}.$$

By $a = b + 0$ we mean that we take the value in the third case of Figure 6 when $a > b$. So remembering that $g(0) = -v$ equation (25) means

$$\frac{-v + \mathbf{z}^{-n\alpha}}{1 - v\mathbf{z}^{-n\alpha}} = (-v) \frac{1 - \mathbf{z}^{-n\alpha}}{1 - v\mathbf{z}^{-n\alpha}} + \frac{(1 - v)\mathbf{z}^{-n\alpha}}{1 - v\mathbf{z}^{-n\alpha}}.$$

□

Proposition 9. *Let ϖ^μ be a representative in \tilde{T}/H with $\mu - \rho = c_1 e_1 + \cdots + c_r e_r$ with $c_i \in [0, n)$. Then for a simple reflection s_i , the fundamental scattering matrix identity*

$$(26) \quad W_{\varpi^\mu}^{s_i \chi} \circ \overline{\mathcal{A}}_{s_i}(\pi(\varpi^\lambda)\phi_K) = \tau_{\mu, \mu}^1 W_{\varpi^\mu}^\chi(\pi(\varpi^\lambda)\phi_K) + \tau_{\mu, s_i \cdot \mu}^2 W_{s_i \cdot \varpi^\mu}^\chi(\pi(\varpi^\lambda)\phi_K)$$

is equivalent to the following identity of partition functions.

$$(27) \quad Z_\lambda \left(\begin{array}{c|c|c} \vdots & & \\ \hline c_{i-1} \oplus & z_{i-1} & \\ \hline & & \dots \\ \hline c_i \oplus & z_{i+1} & \\ \hline & & \\ \hline c_{i+1} \oplus & z_i & \\ \hline & & \dots \\ \hline c_{i+2} \oplus & z_{i+2} & \\ \hline \vdots & & \end{array} \right) = Z_\lambda \left(\begin{array}{c|c|c} \vdots & & \\ \hline c_{i-1} \oplus & z_{i-1} & \\ \hline & & \dots \\ \hline c_i \oplus & z_i & \\ \hline & & \\ \hline c_{i+1} \oplus & z_{i+1} & \\ \hline & & \dots \\ \hline c_{i+2} \oplus & z_{i+2} & \\ \hline \vdots & & \end{array} \right) \\ = \text{wt} \left(\begin{array}{c} c_i \oplus \quad c_i \oplus \\ \diagdown \quad \diagup \\ c_{i+1} \oplus \quad c_{i+1} \oplus \end{array} \right) Z_\lambda(\mathbf{z}; \mathbf{c}) + \text{wt} \left(\begin{array}{c} c_i \oplus \quad c_{i+1} \oplus \\ \diagup \quad \diagdown \\ c_{i+1} \oplus \quad c_i \oplus \end{array} \right) Z_\lambda(\mathbf{z}; s_i(\mathbf{c}))$$

where the Boltzmann weights are given by Figures 5 and 6 and the weights wt are understood to be the right-hand side of (25) in the special case $c_i = c_{i+1}$.

The identity (27) is just a consequence of the Yang-Baxter equation for our choice of Boltzmann weights. Indeed, by repeated use of the Yang-Baxter equation, we may push the R -vertex appearing in the partition function above rightward until it reaches the right-hand side. On the right-hand side its only admissible configuration is an R -vertex of type a_2 with modified Boltzmann weight equal to 1 according to Figure 6. Thus it matches the partition function on the left-hand side of (27). Note that the spectral parameters z_i and z_{i+1} are reversed in the two models, as a consequence of these Yang-Baxter moves.

Proof. We apply the previous two Propositions to show that each of the Whittaker functions and structure constants τ appearing in (26) is equal to the corresponding partition function or Boltzmann weight for metaplectic ice in (27).

For the left-hand side of (26), recall that the normalized intertwiner $\bar{\mathcal{A}}_{s_i}$ takes the spherical vector ϕ_K in $I(\chi)$ to the spherical vector ϕ_K in $I(s_i\chi)$ and commutes with the action by right-translation by $\pi(\varpi^\lambda)$. Thus,

$$W_{\varpi^\mu}^{s_i\chi} \circ \bar{\mathcal{A}}_{s_i}(\pi(\varpi^\lambda)\phi_K^\chi) = W_{\varpi^\mu}^{s_i\chi}(\pi(\varpi^\lambda)\phi_K^{s_i\chi})$$

and this Whittaker function is given by the partition function on the left-hand side above, according to Proposition 7 (up to a power of \mathbf{z} that will cancel with a matching power of \mathbf{z} in the identity of partition functions).

The coefficients τ^1 and τ^2 appearing on the right-hand side of (26) match the weights of the two R -vertices appearing on the right-hand side of (27) by Proposition 8. The matching of Whittaker functions and partition functions on the respective right-hand sides (up to a constant in \mathbf{z}) is again given by Proposition 7. To apply the Proposition, we must compare the decorations \mathbf{c} defining the left-hand boundary of Z_λ 's and the representatives μ and $s_i \cdot \mu$ in the Whittaker functions. Note that we are using the “dot” action defined by $s_i \cdot \mu = s_i(\mu) + \alpha_i = s_i(\mu - \rho) + \rho$. Thus

$$s_i \cdot (\mu) - \rho = s_i(\mu - \rho) = s_i(c_1e_1 + \cdots + c_re_r),$$

where s_i acts by swapping e_i and e_{i+1} , reversing the roles of the decorations c_i and c_{i+1} in the partition function. \square

Proof of Theorem 1. For any choice of $\mathbf{z} = (z_1, \dots, z_r)$, define the map $\theta_{\mathbf{z}}$ in the statement of the Theorem according to Proposition 7 – each W_b^χ is mapped to the collection of left-edge boundary decorations whose partition function matches W_b . That is, write $b = \varpi^\nu$ with $\nu - \rho = a_1e_1 + \cdots + a_re_r$, so $\theta_{\mathbf{z}}$ maps $W_b^\chi(\phi_K)$ to $v_{+a_1}(z_1) \otimes \cdots \otimes v_{+a_r}(z_r)$. Then the commutativity of the diagram is immediate from Proposition 9. \square

REFERENCES

- [1] William D. Banks, Jason Levy, and Mark R. Sepanski. Block-compatible metaplectic cocycles. *J. Reine Angew. Math.*, 507:131–163, 1999.
- [2] Rodney J. Baxter. *Exactly solved models in statistical mechanics*. Academic Press Inc. [Harcourt Brace Jovanovich Publishers], London, 1982.
- [3] V. V. Bazhanov and A. G. Shadrnikov. Trigonometric solutions of the triangle equations, and simple Lie superalgebras. *Teoret. Mat. Fiz.*, 73(3):402–419, 1987.
- [4] Ben Brubaker, Valentin Buciumas, and Daniel Bump. [arXiv:1604.02206v2](https://arxiv.org/abs/1604.02206v2) (earlier draft of this paper), 2016.
- [5] Ben Brubaker, Daniel Bump, Gautam Chinta, Solomon Friedberg, and Paul E. Gunnells. Metaplectic ice. In *Multiple Dirichlet series, L-functions and automorphic forms*, volume 300 of *Progr. Math.*, pages 65–92. Birkhäuser/Springer, New York, 2012.
- [6] Ben Brubaker, Daniel Bump, and Solomon Friedberg. Schur polynomials and the Yang-Baxter equation. *Comm. Math. Phys.*, 308(2):281–301, 2011.
- [7] Ben Brubaker, Daniel Bump, and Solomon Friedberg. *Weyl group multiple Dirichlet series: type A combinatorial theory*, volume 175 of *Annals of Mathematics Studies*. Princeton University Press, Princeton, NJ, 2011.
- [8] Jean-Luc Brylinski and Pierre Deligne. Central extensions of reductive groups by \mathbf{K}_2 . *Publ. Math. Inst. Hautes Études Sci.*, (94):5–85, 2001.
- [9] W. Casselman and J. Shalika. The unramified principal series of p -adic groups. II. The Whittaker function. *Compositio Math.*, 41(2):207–231, 1980.
- [10] Vyjayanthi Chari and Andrew Pressley. *A guide to quantum groups*. Cambridge University Press, Cambridge, 1994.

- [11] Gautam Chinta and Omer Offen. A metaplectic Casselman-Shalika formula for GL_r . *Amer. J. Math.*, 135(2):403–441, 2013.
- [12] V. G. Drinfeld. Quantum groups. In *Proceedings of the International Congress of Mathematicians, Vol. 1, 2 (Berkeley, Calif., 1986)*, pages 798–820. Amer. Math. Soc., Providence, RI, 1987.
- [13] V. G. Drinfeld. Quasi-Hopf algebras. *Algebra i Analiz*, 1(6):114–148, 1989.
- [14] I. B. Frenkel and N. Yu. Reshetikhin. Quantum affine algebras and holonomic difference equations. *Comm. Math. Phys.*, 146(1):1–60, 1992.
- [15] D. Gaitsgory. Twisted Whittaker model and factorizable sheaves. *Selecta Math. (N.S.)*, 13(4):617–659, 2008.
- [16] Michio Jimbo. A q -difference analogue of $U(\mathfrak{g})$ and the Yang-Baxter equation. *Lett. Math. Phys.*, 10(1):63–69, 1985.
- [17] Michio Jimbo. Quantum R matrix related to the generalized Toda system: an algebraic approach. In *Field theory, quantum gravity and strings (Meudon/Paris, 1984/1985)*, volume 246 of *Lecture Notes in Phys.*, pages 335–361. Springer, Berlin, 1986.
- [18] André Joyal and Ross Street. Braided tensor categories. *Adv. Math.*, 102(1):20–78, 1993.
- [19] D. A. Kazhdan and S. J. Patterson. Metaplectic forms. *Inst. Hautes Études Sci. Publ. Math.*, (59):35–142, 1984.
- [20] Takeo Kojima. Diagonalization of transfer matrix of supersymmetry $U_q(\widehat{sl}(M+1|N+1))$ chain with a boundary. *J. Math. Phys.*, 54(4), 2013.
- [21] Tomio Kubota. *On automorphic functions and the reciprocity law in a number field*. Lectures in Mathematics, Department of Mathematics, Kyoto University, No. 2. Kinokuniya Book-Store Co., Ltd., Tokyo, 1969.
- [22] P. P. Kulish, N. Yu. Reshetikhin, and E. K. Sklyanin. Yang-Baxter equations and representation theory. I. *Lett. Math. Phys.*, 5(5):393–403, 1981.
- [23] Elliott Lieb. Exact solution of the problem of entropy in two-dimensional ice. *Phys. Rev. Lett.*, 18:692–694, 1967.
- [24] Shahn Majid. *Foundations of quantum group theory*. Cambridge University Press, Cambridge, 1995.
- [25] Hideya Matsumoto. Sur les sous-groupes arithmétiques des groupes semi-simples déployés. *Ann. Sci. École Norm. Sup. (4)*, 2:1–62, 1969.
- [26] Peter J. McNamara. Metaplectic Whittaker functions and crystal bases. *Duke Math. J.*, 156(1):1–31, 2011.
- [27] Peter J. McNamara. Principal series representations of metaplectic groups over local fields. In *Multiple Dirichlet series, L-functions and automorphic forms*, volume 300 of *Progr. Math.*, pages 299–327. Birkhäuser/Springer, New York, 2012.
- [28] Peter J. McNamara. The metaplectic Casselman-Shalika formula, [arXiv:1103.4653](https://arxiv.org/abs/1103.4653). *Transactions of the AMS (to appear)*, 2014.
- [29] Jürgen Neukirch. *Algebraic number theory*, volume 322 of *Grundlehren der Mathematischen Wissenschaften [Fundamental Principles of Mathematical Sciences]*. Springer-Verlag, Berlin, 1999. Translated from the 1992 German original and with a note by Norbert Schappacher, With a foreword by G. Harder.
- [30] Jacques H. H. Perk and Cherie L. Schultz. New families of commuting transfer matrices in q -state vertex models. *Phys. Lett. A*, 84(8):407–410, 1981.
- [31] N. Reshetikhin. Multiparameter quantum groups and twisted quasitriangular Hopf algebras. *Lett. Math. Phys.*, 20(4):331–335, 1990.
- [32] Bill Sutherland. Exact solution for a model for hydrogen-bonded crystals. *Phys. Rev. Lett.*, 19(3):103–4, 1967.
- [33] Martin H. Weissman. Split metaplectic groups and their L-groups. *J. Reine Angew. Math.*, 696:89–141, 2014.
- [34] Hiroyuki Yamane. Quantized enveloping algebras associated with simple Lie superalgebras and their universal R -matrices. *Publ. Res. Inst. Math. Sci.*, 30(1):15–87, 1994.
- [35] Huafeng Zhang. Fundamental representations of quantum affine superalgebras and R -matrices. Preprint. [arXiv:1506.06093](https://arxiv.org/abs/1506.06093). 2015.

- [36] R. B. Zhang. Structure and representations of the quantum general linear supergroup. *Comm. Math. Phys.*, 195(3):525–547, 1998.

SCHOOL OF MATHEMATICS, UNIVERSITY OF MINNESOTA, MINNEAPOLIS, MN 55455
E-mail address: brubaker@math.umn.edu

THE MAX PLANCK INSTITUTE FOR MATHEMATICS, BONN
E-mail address: buciumas@stanford.edu

DEPARTMENT OF MATHEMATICS, STANFORD UNIVERSITY, STANFORD, CA 94305-2125
E-mail address: bump@math.stanford.edu