

MILNOR'S TRIPLE LINKING NUMBER AND DERIVATIVES OF GENUS THREE KNOTS

JUNGHWAN PARK

ABSTRACT. A derivative of an algebraically slice knot K is an oriented link disjointly embedded in a Seifert surface of K such that its homology class forms a basis for a metabolizer H of K . We show that for a genus three algebraically slice knot K , the set $\{\bar{\mu}_{\{\gamma_1, \gamma_2, \gamma_3\}}(123) - \bar{\mu}_{\{\gamma'_1, \gamma'_2, \gamma'_3\}}(123) | \{\gamma_1, \gamma_2, \gamma_3\} \text{ and } \{\gamma'_1, \gamma'_2, \gamma'_3\} \text{ are derivatives of } K \text{ associated with a metabolizer } H\}$ contains $n \cdot \mathbb{Z}$ where n is determined by a Seifert form of K and a metabolizer H . As a corollary, we show that it is possible to realize any integer as a Milnor's triple linking number of a derivative of the unknot on a fixed Seifert surface with a fixed metabolizer. In addition, we show that a knot, which is a connected sum of three genus one algebraically slice knots, has at least one derivative which has non-zero Milnor's triple linking number.

1. INTRODUCTION

A knot K is a smooth embedding of an oriented S^1 into S^3 . If K bounds a smoothly embedded 2-disk D^2 in the standard B^4 , we say K is a smoothly slice knot. Recall that any knot in S^3 bounds a Seifert surface F and from F we have a Seifert form $\beta_F : H_1(F) \times H_1(F) \rightarrow \mathbb{Z}$. Here $\beta_F([x], [y]) = \text{lk}(x, y^+)$, x is union of simple closed curves on F that represents $[x]$, and y^+ is positive push off of union of simple closed curves on F that represents $[y]$. If K is a smoothly slice knot there exists a metaboliser $H \cong \mathbb{Z}^{\frac{1}{2} \text{rank } H_1(F)}$, a direct summand of $H_1(F)$, such that β_F vanishes on H (see [Lev69, Lemma2]). In this case we say that the Seifert form is metabolic, and we call a knot algebraically slice if it has a metabolic Seifert form. From now we will assume K is algebraically slice and that H is a metaboliser of K . Let $\{\gamma_1, \gamma_2, \dots, \gamma_{\frac{1}{2} \text{rank } H_1(F)}\}$ be an oriented link disjointly embedded in the Seifert surface F whose homology class forms a basis for H . Such a link is called a derivative of K associated with H .

It is an interesting problem to understand the behavior of derivatives of a given algebraically slice knot. A lot of work has been done in this area (see [Gil83, Lit84, Gil93, GL92a, GL92b, GL13, CHL10, COT04, CD15, Par15]). However, not until recently has there been a study of the Milnor's invariants of derivatives (for the definition of Milnor invariants see section 2.2). In [JKP14], Jang-Kim-Powell studied Milnor invariants of derivatives of a boundary links where each of the components has a Seifert surface of genus one. In this paper we will be focusing on a knot which has a genus three Seifert surface and trying to understand the behavior of its derivatives. In particular, we are interested in calculating their Milnor's triple linking number. It turns out that the behavior of Milnor's triple linking number of derivatives is quite complex as suggested by the following main theorem.

Date: November 6, 2018.

2000 Mathematics Subject Classification. 57M25.

Theorem 4.3. *Let K be an algebraically slice knot with genus three Seifert surface F . Suppose H is a metabolizer of K and $\{a_1, a_2, a_3, b_1, b_2, b_3\}$ is a symplectic basis for $H_1(F)$ where $\text{span}(b_1, b_2, b_3) = H$. Let*

$$M = \begin{pmatrix} * & a & * & x_1 & * & y_1 \\ a-1 & 0 & x_2 & 0 & y_2 & 0 \\ * & x_2 & * & b & * & z_1 \\ x_1 & 0 & b-1 & 0 & z_2 & 0 \\ * & y_2 & * & z_2 & * & c \\ y_1 & 0 & z_1 & 0 & c-1 & 0 \end{pmatrix}$$

be the Seifert matrix with respect to the basis $\{a_1, b_1, a_2, b_2, a_3, b_3\}$. Then $S_{K,H} \supseteq \{n \cdot ((a-1)(b-1)(c-1) - abc + x_1x_2 + y_1y_2 + z_1z_2) | n \in \mathbb{Z}\}$, where $S_{K,H} = \{\bar{\mu}_{\{\gamma_1, \gamma_2, \gamma_3\}}(123) - \bar{\mu}_{\{\gamma'_1, \gamma'_2, \gamma'_3\}}(123) | \{\gamma_1, \gamma_2, \gamma_3\} \text{ and } \{\gamma'_1, \gamma'_2, \gamma'_3\} \text{ are derivatives of } K \text{ associated with } H\}$.

It is still an open problem whether $S_{K,H}$ is in fact equal to $\{n \cdot ((a-1)(b-1)(c-1) - abc + x_1x_2 + y_1y_2 + z_1z_2) | n \in \mathbb{Z}\}$. As a corollary of the main Theorem we show that even when we choose the knot to be the simplest possible knot, Milnor's triple linking number of derivatives can become very complicated.

Corollary 4.5. *Let U be the unknot with a Seifert surface F given in Figure 1. For $i = 1, 2, 3$, let β_i be the simple closed curve as in Figure 1. If $H := \text{span}([\beta_1], [\beta_2], [\beta_3])$, then*

$$\{\bar{\mu}_{\{\gamma_1, \gamma_2, \gamma_3\}}(123) | \{\gamma_1, \gamma_2, \gamma_3\} \text{ is a derivative of } U \text{ associated with } H\} = \mathbb{Z}$$

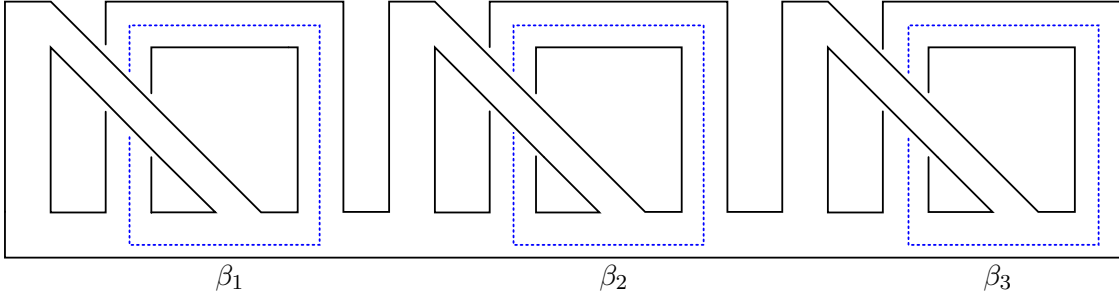

FIGURE 1. Disk-band form of Seifert surface F for the unknot U

In addition, we also show that a knot, which is a connected sum of three genus one algebraically slice knots, has at least one derivative which has non-zero Milnor's triple linking number.

2. PRELIMINARIES

2.1. Band form and Seifert matrix. Fix a knot K and its genus three Seifert surface F , then we have a Seifert form $\beta_F : H_1(F) \times H_1(F) \rightarrow \mathbb{Z}$. Since K is an algebraically slice knot there exists a metaboliser $H = \mathbb{Z}^{\frac{1}{2} \text{rank } H_1(F)} = \mathbb{Z}^3$, a direct summand of $H_1(F)$, such that β_F vanishes on H . Let $\{\gamma_1, \gamma_2, \dots, \gamma_{\frac{1}{2} \text{rank } H_1(F)}\} = \{\gamma_1, \gamma_2, \gamma_3\}$ be a derivative of K associated with H . Let $b_1 = [\gamma_1]$, $b_2 = [\gamma_2]$, and $b_3 = [\gamma_3]$ be elements in $H_1(F)$, then we can extend $\{b_1, b_2, b_3\}$ to a symplectic basis $\{a_1, a_2, a_3, b_1, b_2, b_3\}$ where a_i is an intersection

dual of b_i for each $i \in \{1, 2, 3\}$. This gives us a disk band form for the Seifert surface F as in Figure 2. From this we get a Seifert Matrix

$$M = \begin{pmatrix} * & a & * & x_1 & * & y_1 \\ a-1 & 0 & x_2 & 0 & y_2 & 0 \\ * & x_2 & * & b & * & z_1 \\ x_1 & 0 & b-1 & 0 & z_2 & 0 \\ * & y_2 & * & z_2 & * & c \\ y_1 & 0 & z_1 & 0 & c-1 & 0 \end{pmatrix}$$

for K with respect to a basis $\{a_1, b_1, a_2, b_2, a_3, b_3\}$, where $a, b, c, x_1, x_2, y_1, y_2, z_1$ and z_2 are integers.

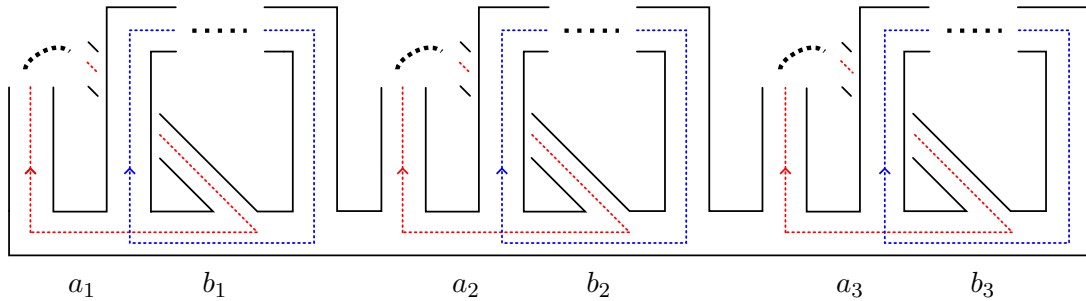

FIGURE 2. Disk-band form of Seifert surface F for K

2.2. Milnor's Triple Linking Number. In this section, we will recall some definitions and properties of Milnor's triple linking number (for more general setting and detailed discussion see [Mil54], [Mil57], [Orr89]). We will focus on 3-component link $L = \{L_1, L_2, L_3\}$ such that $\text{lk}(L_i, L_j) = 0$ for $i, j \in \{1, 2, 3\}$ where $i \neq j$. Let μ_1, μ_2 and μ_3 be meridians of L_1, L_2 and L_3 respectively and let λ_1, λ_2 and λ_3 be longitudes of L_1, L_2 and L_3 respectively. Let $\pi = \pi_1(S^3 - L)$ and F be a free group generated by x_1, x_2 and x_3 . Also, when G is a group, the n th lower central series of G is denoted as G_n and defined inductively by $G_1 = G$ and $G_i = [G, G_{i-1}]$ for $i > 1$. Note that, since $\text{lk}(L_i, L_j) = 0$ for $i, j \in \{1, 2, 3\}$ where $i \neq j$, $[\lambda_i] \in \pi_2$ for all $i \in \{1, 2, 3\}$. Hence, by [Mil57] we have an isomorphism $F/F_3 \rightarrow \pi/\pi_3$ which is induced by $\sqrt[3]{S^1} \rightarrow S^3 - L$ where each of the circle from the wedge gets map to each of the meridian of the link L , *i.e.* x_1 is identified with $[\mu_1]$, x_2 is identified with $[\mu_2]$, and x_3 is identified with $[\mu_3]$. So, from now on we will identify F/F_3 and π/π_3 .

Recall Magnus representation $\phi : F \rightarrow P$ where P is power series ring with non-commutative variable a_1, a_2 and a_3 , and $\phi(x_i) = 1 + a_i$ and $\phi(x_i^{-1}) = 1 - a_i + a_i^2 - a_i^3 + \dots$ for $i \in \{1, 2, 3\}$. Magnus proved that for any $y \in F$, $y \in F_k$ if and only if $\phi(y) = 1 + \sum c_i \cdot w_i$ where c_i is an integer, w_i is a word in a_1, a_2 and a_3 , and length of w_i is greater than equal to k for all i (see [MKS04]).

We define Milnor's triple linking number $\bar{\mu}_L(123)$ of a link L as the coefficient of $a_1 \cdot a_2$ in $\phi([\lambda_3]) \in P$. Notice that by Magnus's work, $[\lambda_3] \in \pi_3$ if and only if $\bar{\mu}_L(123) = 0$. It is also known that $F_2/F_3 \simeq \pi_2/\pi_3$ is a finitely generated free abelian group with a basis $\{[x_1, x_2], [x_1, x_3], [x_2, x_3]\}$ (see [Hal50]). Then it is not hard to see that $\bar{\mu}_L(123)$ is equal to n_1 where $p([\lambda_3]) = [x_1, x_2]^{n_1} \cdot [x_1, x_3]^{n_2} \cdot [x_2, x_3]^{n_3} \in F_2/F_3 = \pi_2/\pi_3$ where p is a projection $p : \pi_2 \rightarrow \pi_2/\pi_3$.

We will recall some properties of lower central series, which helps to compute $\bar{\mu}_L(123)$.

Proposition 2.1 (See [MKS04]). *Let a, b, c be elements of a group G . Then*

- (1) $[G_n, G_m] \subseteq G_{n+m}$ for any positive integers n and m
- (2) $[a, b \cdot c] = [a, b] \cdot [a, c] \pmod{G_3}$
- (3) $[a \cdot b, c] = [a, c] \cdot [b, c] \pmod{G_3}$

From Proposition 2.1(1) we have the following proposition.

Proposition 2.2 (See [Coc90]). *Let γ be a loop in $S^3 - L$ and let γ_1 and γ_2 be basings of γ . If either $[\gamma_1]$ or $[\gamma_2]$ is in π_2 , then $[\gamma_1] = [\gamma_2]$ in $\pi_2/\pi_3 = F_2/F_3$.*

Proof. For some $g \in \pi$ we have $\gamma_1 = g \cdot \gamma_2 \cdot g^{-1} = g \cdot \gamma_2 \cdot g^{-1} \cdot \gamma_2^{-1} \cdot \gamma_2 = [g, \gamma_2] \cdot \gamma_2$. We can conclude the statement since $[g, \gamma_2] \in \pi_3$ by Proposition 2.1(1). \square

This tells us that as long as any basing of a loop γ in $S^3 - L$ is contained in π_2 we do not need to specify the basing. Using Proposition 2.1(2), (3) we have the following proposition immediately.

Proposition 2.3. *Let w_1, w_2 be elements of F free group generated by x_1, x_2 and x_3 . For $i \in \{1, 2, 3\}$, let n_i denote the exponent sum of x_i 's occurring in w_1 , and let m_i denote the exponent sum of x_i 's occurring in w_2 . Then $[w_1, w_2] = [x_1, x_2]^{(n_1 m_2 - n_2 m_1)} \cdot [x_1, x_3]^{(n_1 m_3 - n_3 m_1)} \cdot [x_2, x_3]^{(n_2 m_3 - n_3 m_2)}$ in F_2/F_3 .*

Proof. By Proposition 2.1(2), (3) we can expand out $[w_1, w_2]$. Then the statement follows immediately. \square

There is a nice geometric interpretation of Milnor' triple linking number of a link L introduced by Cochran in [Coc90]. Given L as above, suppose F_1, F_2 and F_3 are Seifert surfaces for L_1, L_2 and L_3 respectively. Further, for $i, j \in \{1, 2, 3\}$ assume $F_i \cap L_j = \emptyset$ when $i \neq j$ and adjust so that triple intersection points are isolated. Then Milnor's triple linking number $\bar{\mu}_L(123)$ is the number of triple intersection points of F_1, F_2 and F_3 , counted with signs. The sign of intersection $p \in F_1 \cap F_2 \cap F_3$ is positive if and only if $\{\vec{v}_1, \vec{v}_2, \vec{v}_3\}$ agrees with standard orientation of S^3 where \vec{v}_i is a normal vector to F_i at p , for $i \in \{1, 2, 3\}$. This tells us that $\bar{\mu}_L(\sigma(123)) = \text{sign}(\sigma) \cdot \bar{\mu}_L(123)$ for $\sigma \in S_3$, and change of an orientation of a component of L changes the sign of Milnor' triple linking number.

2.3. Infection by String Links. In this section we will recall definitions of string link and string link infection. The following definitions are from [JKP14].

Definition 2.4. (String Link)

- (1) An r -multi-disk \mathbb{E} is an oriented disk D^2 with r ordered embedded open disks E_1, E_2, \dots, E_r . We have pairwise disjoint paths $\gamma_1, \gamma_2, \dots, \gamma_r$ such that $\gamma_i(0) \in \partial E_i$ and $\gamma_i(1) \in \partial \mathbb{E}$ (see Figure 3).
- (2) Let p_i be the fixed point in the interior of E_i for each $i = 1, 2, \dots, r$. An r -component string link is a smooth proper embedding $J : \bigsqcup_{i=1}^r p_i \times I \rightarrow D^2 \times I$ such that $J(p_i \times \{0\}) = p_i \times \{0\} \in D^2 \times \{0\}$ and $J(p_i \times \{1\}) = p_i \times \{1\} \in D^2 \times \{1\}$ for each $i = 1, 2, \dots, r$. We will denote $\nu(J) : \bigsqcup_{i=1}^r p_i \times I \rightarrow D^2 \times I$ as a tubular neighborhood of J . We will abuse notation and use J and $\nu(J)$ as image of J and image of $\nu(J)$ respectively.

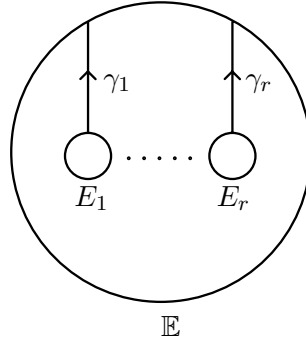

FIGURE 3. An r -multi-disk \mathbb{E}

- (3) For $i = 1, 2, \dots, r$, the meridian of a i th component of J is the simple closed curve, up to ambient isotopy, on the boundary of $\nu(J)(E_i \times I)$, which has the linking number 1 with the i th component of J . For $i = 1, 2, \dots, r$, let $\delta_i : I \rightarrow \partial E_i \times I$ be a 0-framed parallel of i th component such that $\delta_i(0) = \gamma_i(0) \times \{1\} \in \mathbb{E} \times I$ and $\delta_i(1) = \gamma_i(0) \times \{1\} \in \mathbb{E} \times I$. Then the longitude l_i of the i th component of J is the concatenation of arcs as follows: $l_i = \delta_i \cup (\gamma_i \times \{1\}) \cup (\gamma_i(1) \times I) \cup (-\gamma_i \times \{0\})$.

The following definitions are also from [JKP14].

Definition 2.5. (Infection by a string link) Let L be a link in S^3 and J be an r -component string link in $D^2 \times I$.

- (1) Let \mathbb{E} be an r -multi disk, then an embedding $\varphi : \mathbb{E} \rightarrow S^3$ is a proper r -multi disk in (S^3, L) if $\varphi(\mathbb{E})$ intersects L only in $\varphi(E_i)$ transversely for $i = 1, 2, \dots, r$.
- (2) Let \mathbb{E}_φ be the image of \mathbb{E} under φ and let E_φ be the image of $E_1 \sqcup E_2 \sqcup \dots \sqcup E_r$ under φ . We define the link $S(L, J, \varphi)$ to be the image of the link L under the following homeomorphism (for detailed discussion for this homeomorphism see [CFT09]):

$$\begin{aligned} & (S^3 \setminus (\text{int}(\mathbb{E}_\varphi \setminus E_\varphi) \times I)) \cup ((D^2 \times I) \setminus \nu(J)) \\ &= (S^3 \setminus (\mathbb{E}_\varphi \times I)) \cup (((D^2 \times I) \setminus \nu(J)) \cup (\overline{\mathbb{E}_\varphi} \times I)) \\ &\cong S^3. \end{aligned}$$

We call the resulting link $S(L, J, \varphi)$ multi-infection of L by J along \mathbb{E}_φ . In Figure 4 we present an example of $S(L, J, \varphi)$ for a particular L, J and \mathbb{E}_φ .

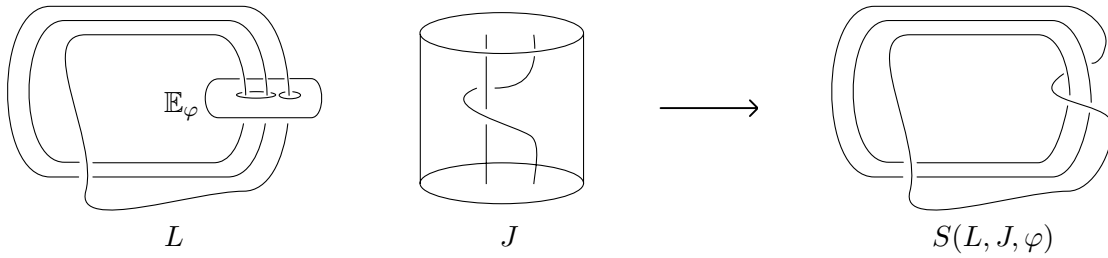

FIGURE 4. Infection by a string link

2.4. Geometric Moves on Knots. In this section we will recall definitions of double delta move and double Borromean rings insertion move and see how they are related. The following definitions are from [Mar15].

Definition 2.6. (Double delta move) A double delta move on a knot K is the local move described in Figure 5.

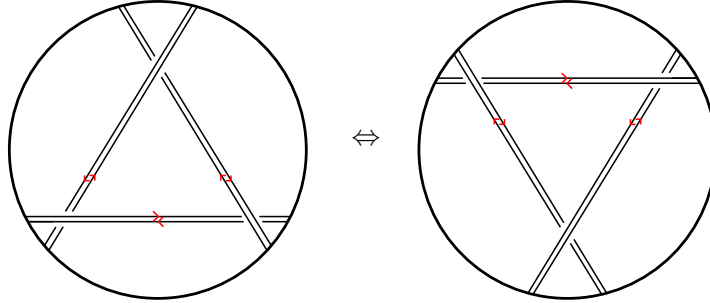

FIGURE 5. A double delta move

Definition 2.7. (Double Borromean rings insertion move) A double Borromean rings insertion move on a knot K is the local move described in Figure 6.

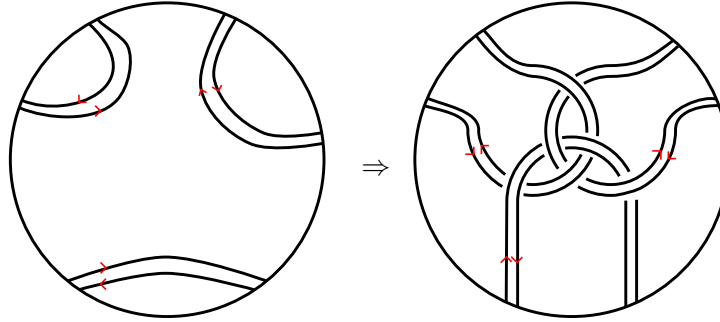

FIGURE 6. A double Borromean rings insertion move

Remark 2.8.

- (1) Notice that a double Borromean rings insertion move is a special case of a string link infection $S(L, J, \varphi)$ where $\varphi : \mathbb{E} \rightarrow S^3$ is given as in Figure 7, and \hat{J} is a Borromean ring.
- (2) A double delta move can be achieved by a double Borromean rings insertion move which is explained in Figure 8.

Let K_1 and K_2 be knots with a Seifert surface F_1 and F_2 respectively. Suppose that genus of F_1 and F_2 are the same and the Seifert Form of K_1 and K_2 are the same. Then it is known that it is possible to alter K_1 only by applying double delta move on the band of F_1 to obtain K_2 (see [NS03]). Then by the Remark 2.8.(2) we can get to K_2 from K_1 only by applying double Borromean rings insertion moves on the band of F_1 . We will use this fact later in Section 4.

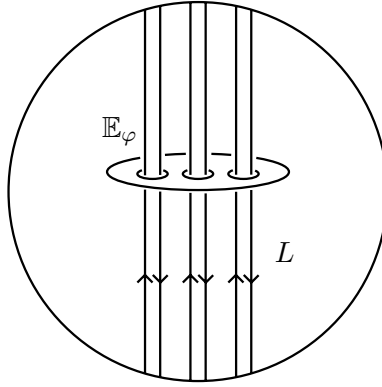

FIGURE 7. A double Borromean rings insertion move is a special case of a string link infection.

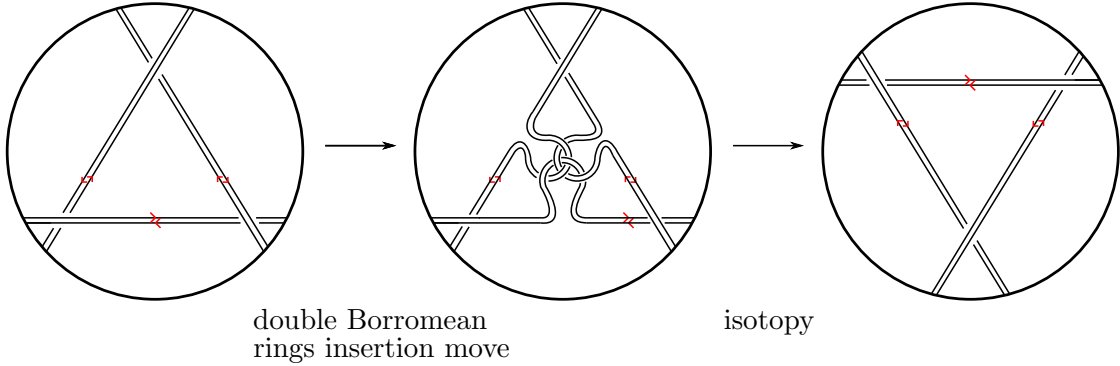

FIGURE 8. A double delta move achieved by a double Borromean rings insertion move.

3. THE EFFECT OF STRING LINK INFECTION ON MILNOR'S TRIPLE LINKING NUMBER

In this section we will recall a Lemma from [JKP14, Lemma 4.1]. We will change assumptions slightly from [JKP14, 4.1] for the purpose of this paper. For completeness we will also present the proof of the Lemma from [JKP14, Lemma 4.1].

Lemma 3.1. [JKP14, Lemma 4.1] *Let $L = L_1 \sqcup L_2 \sqcup L_3$ be an oriented three component link with pairwise linking number zero, and let J be an oriented three component string link whose closure \widehat{J} has pairwise linking number zero. Let $\varphi : \mathbb{E} \rightarrow S^3$ be a proper 3-multi disc in (S^3, L) . Denote the algebraic intersection number between $\varphi(E_i)$ and L_j by n_i^j for $i, j \in \{1, 2, 3\}$. Then $S(L, J, \varphi)$ has zero pairwise linking number and $\bar{\mu}_{S(L, J, \varphi)}(123) = \bar{\mu}_{\widehat{J}}(123) \left(\sum_{\sigma \in S_3} \text{sign}(\sigma) n_1^{\sigma(1)} n_2^{\sigma(2)} n_3^{\sigma(3)} \right) + \bar{\mu}_L(123)$.*

Proof. It is straightforward to see that $S(L, J, \varphi)$ has pairwise linking number zero, since \widehat{J} has pairwise linking number zero. Assume that $\varphi(E_i)$ intersects the link L transversely. Let α_i^j be the number of positive intersection and β_i^j be the number of negative intersection between $\varphi(E_i)$ and L_j for $i, j \in \{1, 2, 3\}$. Let J' be the oriented string link where we take

$\alpha_i^1 + \alpha_i^2 + \alpha_i^3$ many parallel copy of i th component with the same orientation and $\beta_i^1 + \beta_i^2 + \beta_i^3$ many parallel copy of i th component with the opposite orientation for $i \in \{1, 2, 3\}$. Then we can consider $S(L, J, \varphi)$ as the result of performing several exterior band sums between L and \widehat{J}' , the closure of J' (see Figure 9).

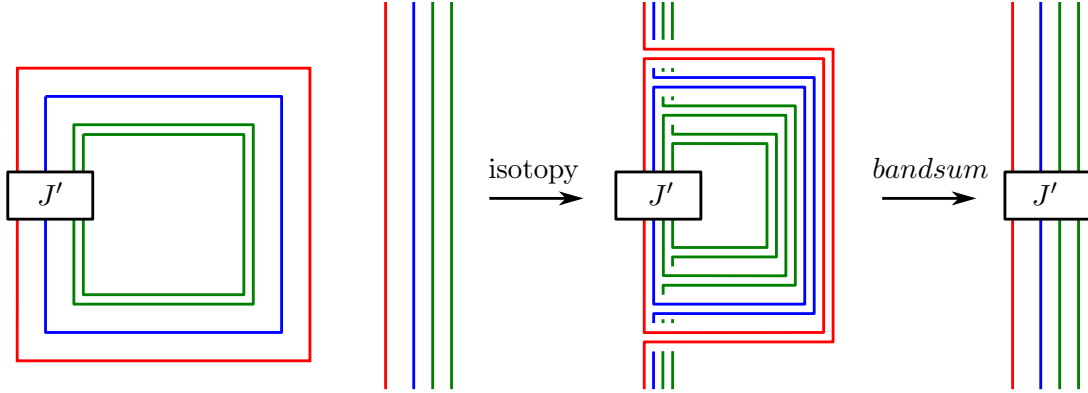

FIGURE 9. Band sums between L and \widehat{J}' , the closure of J' .

We will label each component of J' with index $\{1, 2, \dots, \sum_{i,j}(\alpha_i^j + \beta_i^j)\}$ and we define a set map $h : \{1, 2, \dots, \sum_{i,j}(\alpha_i^j + \beta_i^j)\} \rightarrow \{1, 2, 3\}$ where, for $n \in \{1, 2, \dots, \sum_{i,j}(\alpha_i^j + \beta_i^j)\}$, $h(n)$ is the index of the component of the link $L = L_1 \sqcup L_2 \sqcup L_3$ where n th component of J' is being banded summed to. It is known that the first non-vanishing Milnor invariant is additive under the exterior band sum (see [Coc90]). Hence, we have the following equation :

$$\bar{\mu}_{S(L,J,\varphi)}(123) = \sum_{\{I' \subset \{1,2,\dots,\sum_{i,j}(\alpha_i^j + \beta_i^j)\} | h(I') = \{1,2,3\}, |I'| = 3\}} \text{sign}(h(I'_1)h(I'_2)h(I'_3)) \cdot \bar{\mu}_{\widehat{J}'}(123) + \bar{\mu}_L(123)$$

where I'_i is i th component of I' for $i = 1, 2, 3$ and we are considering $(h(I'_1)h(I'_2)h(I'_3))$ as an element of S_3 .

Recall that reversing the orientation of a component of a link changes the sign of the Milnor's triple linking number (see section 1.2). Also, note that n_j^i , the algebraic intersection number between $\varphi(E_i)$ and L_j , is equal to $\alpha_i^j - \beta_i^j$. Combining these with the above equation, we have the following desired equation :

$$\begin{aligned}
\bar{\mu}_{S(L,J,\varphi)}(123) &= \bar{\mu}_{\hat{J}}(123) \cdot \sum_{\sigma \in S_3} (\text{sign}(\sigma) \cdot (\alpha_1^{\sigma(1)} \alpha_2^{\sigma(2)} \alpha_3^{\sigma(3)} - \beta_1^{\sigma(1)} \alpha_2^{\sigma(2)} \alpha_3^{\sigma(3)} - \alpha_1^{\sigma(1)} \beta_2^{\sigma(2)} \alpha_3^{\sigma(3)} - \\
&\quad \alpha_1^{\sigma(1)} \alpha_2^{\sigma(2)} \beta_3^{\sigma(3)} + \beta_1^{\sigma(1)} \beta_2^{\sigma(2)} \alpha_3^{\sigma(3)} + \alpha_1^{\sigma(1)} \beta_2^{\sigma(2)} \beta_3^{\sigma(3)} + \beta_1^{\sigma(1)} \alpha_2^{\sigma(2)} \beta_3^{\sigma(3)} - \\
&\quad \beta_1^{\sigma(1)} \beta_2^{\sigma(2)} \beta_3^{\sigma(3)})) + \bar{\mu}_L(123) \\
&= \bar{\mu}_{\hat{J}}(123) \cdot \sum_{\sigma \in S_3} (\text{sign}(\sigma) \cdot (n_1^{\sigma(1)} \alpha_2^{\sigma(2)} \alpha_3^{\sigma(3)} - \alpha_1^{\sigma(1)} \beta_2^{\sigma(2)} n_3^{\sigma(3)} - n_1^{\sigma(1)} \alpha_2^{\sigma(2)} \beta_3^{\sigma(3)} + \\
&\quad \beta_1^{\sigma(1)} \beta_2^{\sigma(2)} n_3^{\sigma(3)})) + \bar{\mu}_L(123) \\
&= \bar{\mu}_{\hat{J}}(123) \cdot \sum_{\sigma \in S_3} (\text{sign}(\sigma) \cdot (n_1^{\sigma(1)} \alpha_2^{\sigma(2)} n_3^{\sigma(3)} - n_1^{\sigma(1)} \beta_2^{\sigma(2)} n_3^{\sigma(3)})) + \bar{\mu}_L(123) \\
&= \bar{\mu}_{\hat{J}}(123) \cdot \sum_{\sigma \in S_3} (\text{sign}(\sigma) \cdot (n_1^{\sigma(1)} n_2^{\sigma(2)} n_3^{\sigma(3)})) + \bar{\mu}_L(123).
\end{aligned}$$

□

4. MAIN THEOREM AND APPLICATIONS

In this section we will present the main theorem and see its applications. Before that we prove two lemmas which will be useful. For any algebraically slice knot K with metabolizer H , where $\{b_1, b_2, b_3\}$ is a basis for H , we will define $S_{K,H,\{b_1,b_2,b_3\}}$ as a set of integers $\{\bar{\mu}_{\{\gamma_1,\gamma_2,\gamma_3\}}(123) - \bar{\mu}_{\{\gamma'_1,\gamma'_2,\gamma'_3\}}(123) \mid \{\gamma_1, \gamma_2, \gamma_3\}$ and $\{\gamma'_1, \gamma'_2, \gamma'_3\}$ are derivatives of K associated with H , $b_1 = [\gamma_1] = [\gamma'_1]$, $b_2 = [\gamma_2] = [\gamma'_2]$, $b_3 = [\gamma_3] = [\gamma'_3]$ \}. We will also define $S_{K,H}$ as a set of integers $\{\bar{\mu}_{\{\gamma_1,\gamma_2,\gamma_3\}}(123) - \bar{\mu}_{\{\gamma'_1,\gamma'_2,\gamma'_3\}}(123) \mid \{\gamma_1, \gamma_2, \gamma_3\}$ and $\{\gamma'_1, \gamma'_2, \gamma'_3\}$ are derivatives of K associated with $H\}$.

Lemma 4.1. *Let K and \tilde{K} be algebraically slice knots, and suppose F and \tilde{F} are genus three Seifert surfaces for K and \tilde{K} respectively. Let $\{a_1, a_2, a_3, b_1, b_2, b_3\}$ be a symplectic basis for $H_1(F)$ where $\text{span}(b_1, b_2, b_3)$ is a metaboliser H for K , and let $\{\tilde{a}_1, \tilde{a}_2, \tilde{a}_3, \tilde{b}_1, \tilde{b}_2, \tilde{b}_3\}$ be a symplectic basis for $H_1(\tilde{F})$ where $\text{span}(\tilde{b}_1, \tilde{b}_2, \tilde{b}_3)$ is a metaboliser \tilde{H} for \tilde{K} . We will denote M as the Seifert matrix which arises from the basis $\{a_1, b_1, a_2, b_2, a_3, b_3\}$ and \tilde{M} as the Seifert matrix which arises from the basis $\{\tilde{a}_1, \tilde{b}_1, \tilde{a}_2, \tilde{b}_2, \tilde{a}_3, \tilde{b}_3\}$. If $M = \tilde{M}$, we have $S_{K,H,\{b_1,b_2,b_3\}} = S_{\tilde{K},\tilde{H},\{\tilde{b}_1,\tilde{b}_2,\tilde{b}_3\}}$ as a set.*

Proof. Using symplectic bases $\{a_1, a_2, a_3, b_1, b_2, b_3\}$ and $\{\tilde{a}_1, \tilde{a}_2, \tilde{a}_3, \tilde{b}_1, \tilde{b}_2, \tilde{b}_3\}$ we can get disk-band form for F and \tilde{F} . As we previously observed at the end of section 2, we can get to \tilde{K} from K only by performing double Borromean rings insertion moves on the band of F , since K and \tilde{K} have the same Seifert form. Also, since we can think of double Borromean rings insertion move as a special case of a string link infection (see Remark 2.8.(1)), we can apply Lemma 3.1 to our situation. Suppose $L = \{\gamma_1, \gamma_2, \gamma_3\}$ and $L' = \{\gamma'_1, \gamma'_2, \gamma'_3\}$ are derivatives of K associated with H , where $[\gamma_1] = [\gamma'_1] = b_1$, $[\gamma_2] = [\gamma'_2] = b_2$ and $[\gamma_3] = [\gamma'_3] = b_3$. If we perform one double Borromean rings insertion move on bands of F , we get two links $S(L, J, \varphi)$ and $S(L', J, \varphi)$, where \hat{J} is a Borromean rings. By Lemma 3.1, for $i, j \in \{1, 2, 3\}$, Milnor's triple linking number of $S(L, J, \varphi)$ only depends on the algebraic intersection number between $\varphi(E_i)$ and γ_j , and Milnor's triple linking number of $S(L', J, \varphi)$ only depends on the algebraic intersection number between $\varphi(E_i)$ and γ'_j . Since $[\gamma_j] = [\gamma'_j] \in$

$H_1(F)$ for $j = 1, 2, 3$, we know that they have the same algebraic intersection number with $\varphi(E_i)$ for $i = 1, 2, 3$. Therefore, we can conclude $\bar{\mu}_L(123) - \bar{\mu}_{L'}(123) = \bar{\mu}_{S(L,J,\varphi)}(123) - \bar{\mu}_{S(L',J,\varphi)}(123)$, i.e. double Borromean rings insertion move does not change the difference of Milnor's triple linking number of two derivatives. By applying more double Borromean rings insertion moves, we can achieve \tilde{K} . Using the same argument, we know that difference of their Milnor's triple linking number after all the double Borromean rings insertion moves is still $\bar{\mu}_L(123) - \bar{\mu}_{L'}(123)$. Therefore we can conclude that $S_{K,H,\{b_1,b_2,b_3\}} \subseteq S_{\tilde{K},\tilde{H},\{\tilde{b}_1,\tilde{b}_2,\tilde{b}_3\}}$. We get the other inclusion by simply switching the roles of K and \tilde{K} . \square

We will present one more lemma which will be useful for the main theorem.

Lemma 4.2. *Let K be an algebraically slice knot and let F be a genus three Seifert surface for K . Suppose H is a metaboliser of K and $\{a_1, a_2, a_3, b_1, b_2, b_3\}$ is a symplectic basis for $H_1(F)$ where $\text{span}(b_1, b_2, b_3) = H$, then $S_{K,H} = S_{K,H,\{b_1,b_2,b_3\}} \cup -S_{K,H,\{b_1,b_2,b_3\}}$. (i.e. Choice of a basis does not matter once we pick a metaboliser for K .)*

Proof. It is obvious to see $S_{K,H} \supseteq S_{K,H,\{b_1,b_2,b_3\}} \cup -S_{K,H,\{b_1,b_2,b_3\}}$, since $-S_{K,H,\{b_1,b_2,b_3\}} = S_{K,H,\{-b_1,b_2,b_3\}}$.

For the other direction, we suppose $\{\gamma_1, \gamma_2, \gamma_3\}$ is a derivative of K associated with H . Take a parallel copy of γ_2 and perform a band sum on the Seifert surface F from γ_1 to the parallel copy of γ_2 (see Figure 10). Let γ'_1 be the resulting knot after the band sum. Also, let $\gamma'_2 = \gamma_2$ and $\gamma'_3 = \gamma_3$. We claim that $\bar{\mu}_{\{\gamma_1,\gamma_2,\gamma_3\}}(123) = \bar{\mu}_{\{\gamma'_1,\gamma'_2,\gamma'_3\}}(123)$. Recall from section 2.2 that there is a nice geometric interpretation of Milnor's triple linking number which was counting the number of triple intersection points of Seifert surfaces with sign. Let F_1, F_2 and F_3 be Seifert surfaces for γ_1, γ_2 and γ_3 respectively, where $F_i \cap \gamma_j = \emptyset$ for $i \neq j$ and F_1, F_2 and F_3 have isolated triple intersection points. We will take a parallel copy of F_2 which bounds the parallel copy of γ_2 and take a boundary sum with F_1 along the band which was used to perform band sum between γ_1 and the parallel copy of γ_2 (see Figure 10). Let F'_1 be the resulting surface which bounds γ'_1 . Also, let $F'_2 = F_2$ and $F'_3 = F_3$. Then notice that we have not introduced any new triple intersection points between F'_1, F'_2 and F'_3 , since parallel copy of F_2 and F_2 does not intersect.

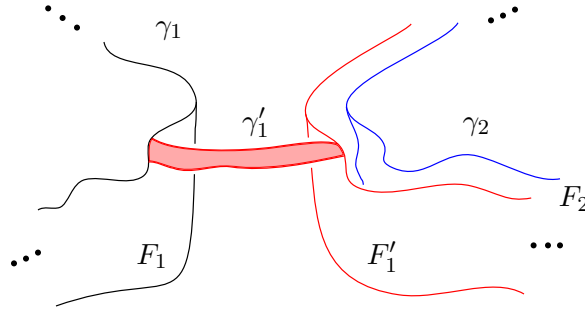

FIGURE 10. Taking a parallel copy of γ_2 and performing a band sum with γ_1 .

However, it is not guaranteed that $F'_i \cap \gamma'_j = \emptyset$ for $i \neq j$, and also it is not guaranteed that F'_1 is a Seifert surface for γ'_1 , since the band could have went through Seifert surfaces. We can fix this by altering Seifert surfaces. When the band goes through F'_1 we will take out two disks from F'_1 and attach a cylinder which connects the two circles as in Figure

11. When the band goes through either F'_2 or F'_3 , we will perform tubing as in Figure 12. After all the alterations, it is guaranteed that $F'_i \cap \gamma'_j = \emptyset$ for $i \neq j$ and F'_1 is a Seifert surface for γ'_1 . Since, we have not introduced any new triple intersection points, we have $\bar{\mu}_{\{\gamma_1, \gamma_2, \gamma_3\}}(123) = \bar{\mu}_{\{\gamma'_1, \gamma'_2, \gamma'_3\}}(123)$ as desired.

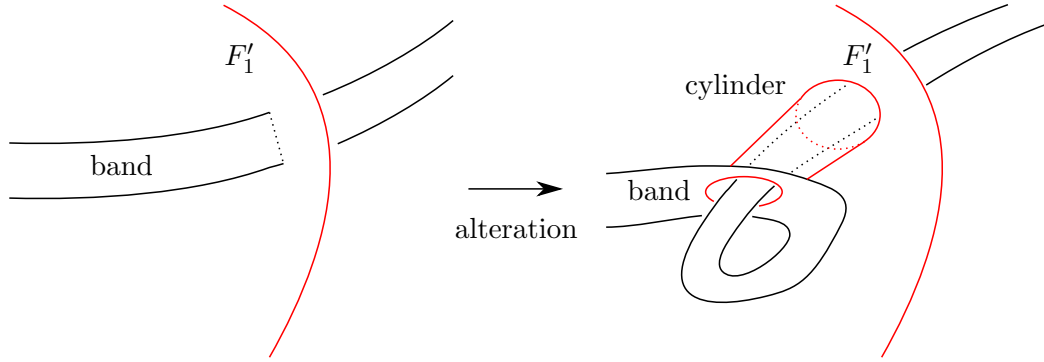

FIGURE 11. Alteration when F'_1 intersects the band

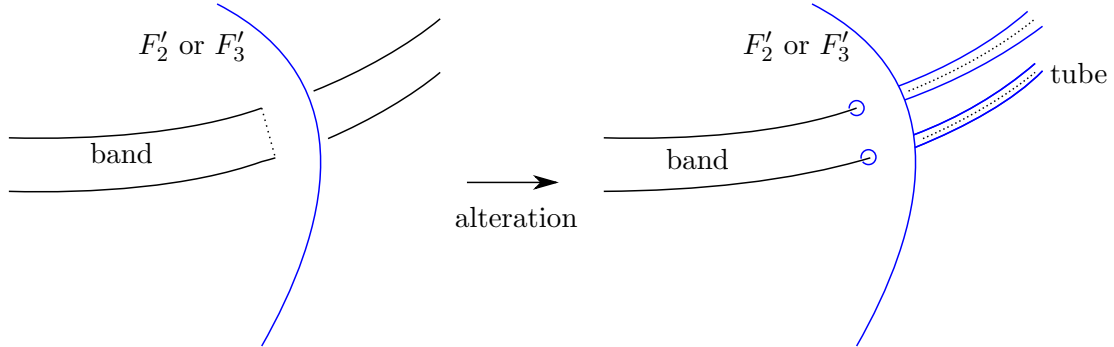

FIGURE 12. Alteration when F'_2 or F'_3 intersects the band

Notice that for any two derivative $\{\gamma_1, \gamma_2, \gamma_3\}$ and $\{\gamma'_1, \gamma'_2, \gamma'_3\}$ associated to H , we can perform several moves as above (i.e. taking a parallel copy of one component and performing a band sum with other component on the Seifert surface F) with possibly changing orientations to get from one to the other. While performing such moves we observed that up to change of sign, their Milnor's triple linking number does not change. Hence, we can conclude that $S_{K,H} \subseteq S_{K,H,\{b_1, b_2, b_3\}} \cup -S_{K,H,\{b_1, b_2, b_3\}}$ as needed. \square

Now, we state the main theorem.

Theorem 4.3. *Let K be an algebraically slice knot with genus three Seifert surface F . Suppose H is a metabolizer of K and $\{a_1, a_2, a_3, b_1, b_2, b_3\}$ is a symplectic basis for $H_1(F)$*

where $\text{span}(b_1, b_2, b_3) = H$. Let

$$M = (m_{ij})_{6 \times 6} = \begin{pmatrix} * & a & * & x_1 & * & y_1 \\ a-1 & 0 & x_2 & 0 & y_2 & 0 \\ * & x_2 & * & b & * & z_1 \\ x_1 & 0 & b-1 & 0 & z_2 & 0 \\ * & y_2 & * & z_2 & * & c \\ y_1 & 0 & z_1 & 0 & c-1 & 0 \end{pmatrix}$$

be the Seifert matrix with respect to the basis $\{a_1, b_1, a_2, b_2, a_3, b_3\}$. Then $S_{K,H} \supseteq S_{K,H,\{b_1, b_2, b_3\}} \supseteq \{n \cdot ((a-1)(b-1)(c-1) - abc + x_1x_2 + y_1y_2 + z_1z_2) | n \in \mathbb{Z}\}$.

Proof. Let K be a given algebraically slice knot. By Lemma 4.1 we can assume K is the knot described in Figure 21 at the end of this paper, which has the simplest Seifert surface Σ with Seifert matrix M . Notice that since $\{\gamma_1, \gamma_2, \gamma_3\}$ is the unlink, $\bar{\mu}_{\{\gamma_1, \gamma_2, \gamma_3\}}(123) = 0$, where $\{\gamma_1, \gamma_2, \gamma_3\}$ is the derivative of K associated with H described in Figure 21.

Now, we will produce links L_n which is a derivative associated with H such that $\bar{\mu}_{L_n}(123) = n \cdot ((a-1)(b-1)(c-1) - abc + x_1x_2 + y_1y_2 + z_1z_2)$ for each positive integer n . We will start with the case when $n = 1$. Let $\gamma_{1,1}, \gamma_{1,2}, \gamma_{1,3}$ be embedding of circles on the surface $\widetilde{\Sigma}_1$ as described in Figure 22, 23, and 24 at the end of this paper. We will denote $\gamma'_{1,i}$ as the intersection dual of $\gamma_{1,i}$ for $i = 1, 2, 3$. Let $\phi: \widetilde{\Sigma}_1 \rightarrow \Sigma$ be the obvious map which sends the core of i th band of $\widetilde{\Sigma}_1$ to the core of the i th band of Σ . By abusing notation we will denote image of $\gamma_{1,i}$ as $\gamma_{1,i}$ and image of $\gamma'_{1,i}$ as $\gamma'_{1,i}$, for $i = 1, 2, 3$. Then notice that for $i = 1, 2, 3$, $[\gamma'_{1,i}] = a_i$ and $[\gamma_{1,i}] = b_i$ in $H_1(\Sigma)$ and $\{\gamma_{1,1}, \gamma_{1,2}, \gamma_{1,3}\}$ is a derivative of K associated with H . Let L_1 be the link $\{\gamma_{1,1}, \gamma_{1,2}, \gamma_{1,3}\} \subset S^3$ on the Seifert surface Σ .

Now, we will show that $\bar{\mu}_{L_1}(123) = ((a-1)(b-1)(c-1) - abc + x_1x_2 + y_1y_2 + z_1z_2)$. Notice that $\bar{\mu}_{L_1}(123)$ is equal to $\bar{\mu}_{\gamma_{1,2}, \gamma_{1,3}, \gamma_{1,1}}(123)$ by the definition so we will calculate $\bar{\mu}_{\gamma_{1,2}, \gamma_{1,3}, \gamma_{1,1}}(123)$ instead. Let π be $\pi_1(S^3 - L_1)$, $\lambda_{1,1}, \lambda_{1,2}, \lambda_{1,3}$ be longitudes of $\gamma_{1,1}, \gamma_{1,2}, \gamma_{1,3}$ respectively, and $\mu_{1,1}, \mu_{1,2}, \mu_{1,3}$ be meridians of $\gamma_{1,1}, \gamma_{1,2}, \gamma_{1,3}$ respectively. Then $[\lambda_{1,1}] \in \pi_2$, since $\text{lk}(\gamma_{1,i}, \gamma_{1,j}) = 0$, for $i \neq j$. Hence by Proposition 2.2, it is not necessary to specify the basing of $\lambda_{1,1}$, for the calculation of $\bar{\mu}_{\gamma_{1,2}, \gamma_{1,3}, \gamma_{1,1}}(123)$. Suppose $\lambda_{1,1}$ bounds a Seifert surface Σ_1 which does not intersect $\gamma_{1,2}$ and $\gamma_{1,3}$. For $i = 1, 2, \dots, k_1$, where k_1 is the genus of Σ_1 , let φ_i and ψ_i be core of the $2i - 1$ th band and $2i$ th band respectively (see Figure 13). For $i = 1, 2, \dots, k_1$, let $c_i = [\varphi_i]$ and $d_i = [\psi_i]$ in $\pi_1(S^3 - L_1)$, then notice that $[\lambda_{1,1}] = \prod_{i=1}^{k_1} [c_i, d_i] \in \pi_2/\pi_3$. Then by Proposition 2.3 we only need to calculate exponent sum of $[\mu_{1,2}]$ and $[\mu_{1,3}]$ occurring in c_i and d_i , for all $i = 1, 2, \dots, k_1$. Notice that basing of φ_i and ψ_i does not matter since we are only interested in their exponent sum of $[\mu_{1,2}]$ and $[\mu_{1,3}]$. Hence, we need to find a Seifert surface Σ_1 for $\lambda_{1,1}$ which does not intersect $\gamma_{1,2}$ and $\gamma_{1,3}$. We will use the obvious surface Σ_1 which bounds $\lambda_{1,1}$ and we will push it to the negative direction of Σ (see Figure 14). The problem with this surface is that it intersects $\gamma_{1,1}, \gamma_{1,2}$, and $\gamma_{1,3}$. In order to fix this problem we need to perform several modifications, which are similar to the modifications performed in the proof of Lemma 4.2, on the surface Σ_1 .

First of all, Σ_1 intersects $\gamma_{1,1}$ only when the third band or the fifth band wraps around the second band. In this case we will drill out two disks from Σ_1 and connect them using a cylinder as in Figure 15 to modify the surface Σ_1 . Notice that whenever we do this we can use φ in Figure 15 as one of the core of the band. Since it has zero exponent sum of $[\mu_{1,2}]$

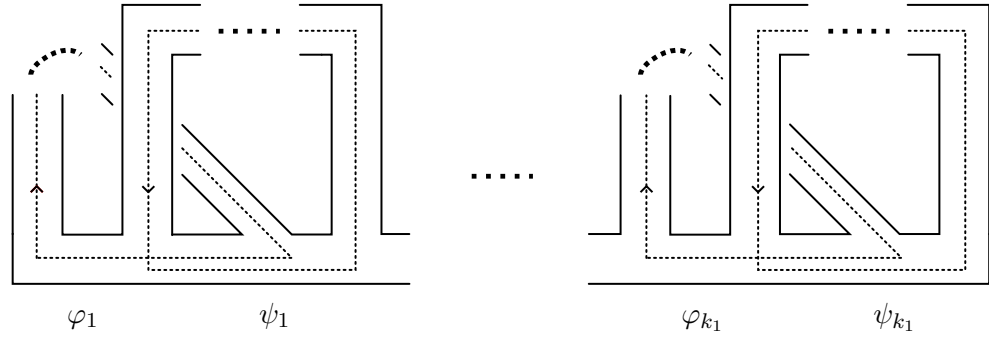

FIGURE 13. Label of core of the band of Seifert surface Σ_1 for $\lambda_{1,1}$

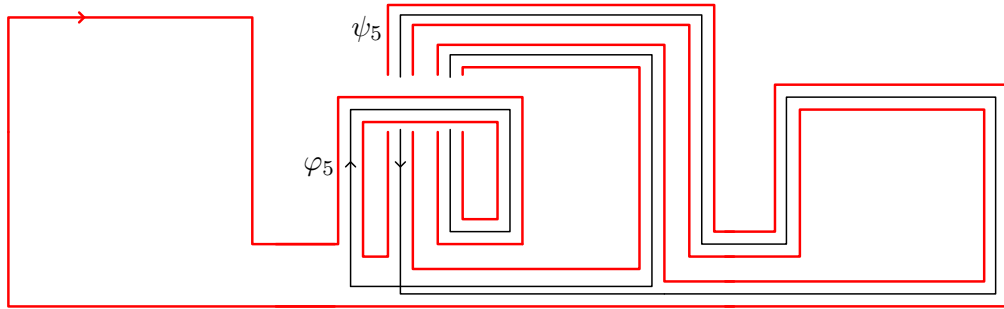

FIGURE 14. Seifert surface Σ_1 before modification and core of two bands φ_5 and ψ_5

and $[\mu_{1,3}]$ occurring in $[\varphi]$, we do not have to worry about the case when Σ_1 intersects $\gamma_{1,1}$ for the calculation of $\bar{\mu}_{L_1}(123)$.

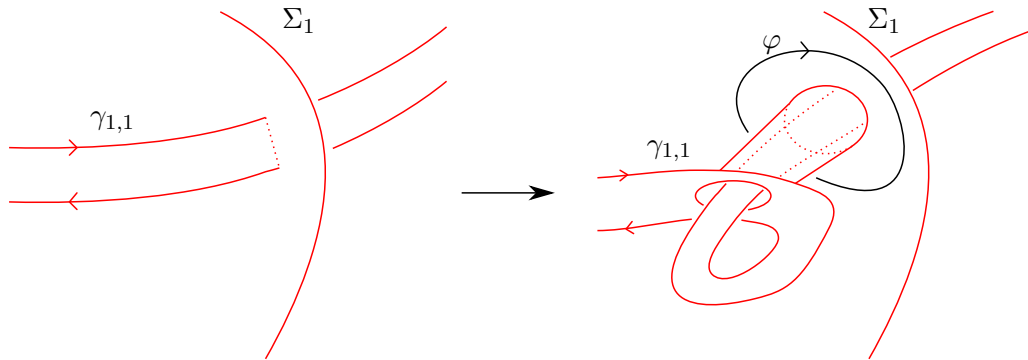

FIGURE 15. Modification of Σ_1 when $\gamma_{1,1}$ intersects Σ_1

When the first band goes through the surface Σ_1 , we will tube along the $\gamma_{1,2}$ and $\gamma_{1,3}$, where Σ_1 intersects $\gamma_{1,2}$ and $\gamma_{1,3}$, as in Figure 16. We will let $\varphi_1, \varphi_2, \psi_1, \psi_2$ be the circles described in Figure 16. Now, we need to calculate exponent sum of $[\mu_{1,2}]$ and $[\mu_{1,3}]$ occurring in $[\varphi_1], [\varphi_2], [\psi_1], [\psi_2]$. For $[\varphi_1]$, it has one exponent sum of $[\mu_{1,2}]$, and for $[\varphi_2]$, it has one

exponent sum of $[\mu_{1,3}]$. Therefore, we only need to calculate exponent sum of $[\mu_{1,3}]$ for $[\psi_1]$, and $[\mu_{1,2}]$ for $[\psi_2]$. Notice that we can think of ψ_1 as positive push off of a circle on the Seifert surface Σ which takes $-a_3$ value in $H_1(\Sigma)$ and we can think of ψ_2 as negative push off of a circle on the Seifert surface Σ which takes $b_1 + a_2 + b_2 + b_3$ value in $H_1(\Sigma)$. Then ψ_1 has $(c - 1)$ exponent sum of $[\mu_{1,3}]$ and ψ_2 has $-b$ exponent sum of $[\mu_{1,2}]$ by the following calculations :

$$\begin{aligned} \text{lk}(\psi_1, \gamma_{1,3}) &= (0 \ 0 \ 0 \ 0 \ 0 \ 1) \cdot M \cdot (0 \ 0 \ 0 \ 0 \ -1 \ 0)^T \\ &= -(c - 1) \\ \text{lk}(\psi_2, \gamma_{1,2}) &= (0 \ 1 \ 1 \ 1 \ 0 \ 1) \cdot M \cdot (0 \ 0 \ 0 \ 1 \ 0 \ 0)^T \\ &= b. \end{aligned}$$

Then in total we have $-(c - 1) - b$ exponent sum of $[[\mu_{1,2}], [\mu_{1,3}]]$ in $[\varphi_1, \psi_1] \cdot [\varphi_2, \psi_2] \in \pi_2/\pi_3$, by Proposition 2.3. Since the first band goes through the surface $(a - 1)$ times in total we have $(a - 1)(-(c - 1) - b)$ effect on the Milnor's triple linking number.

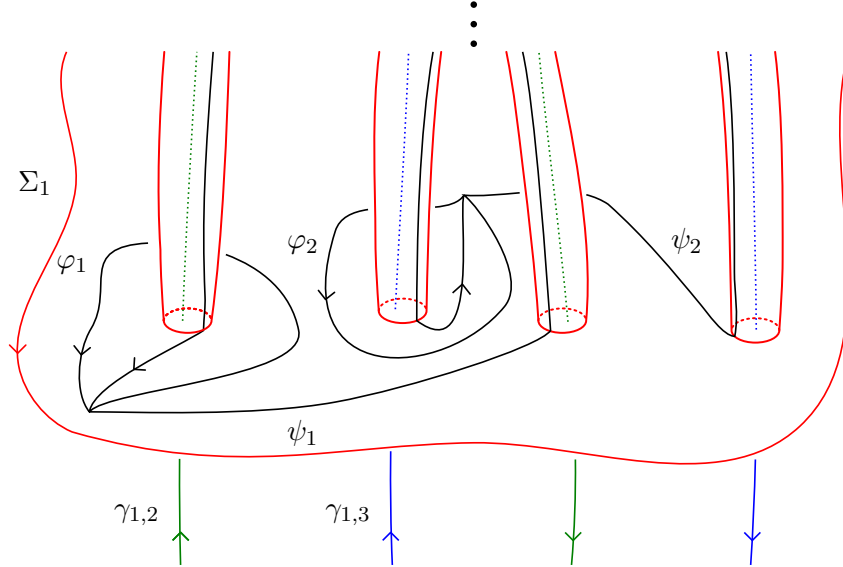

FIGURE 16. $\psi_1, \varphi_1, \psi_2$, and φ_2

For the case where the third band goes through the surface Σ_1 , we will use the same method. We will tube along the $\gamma_{1,3}$ as before (see Figure 17). We will let φ_3, ψ_3 be the circles described in Figure 17. Same as before we calculate exponent sum of $[\mu_{1,2}]$ and $[\mu_{1,3}]$ occurring in $[\varphi_3]$ and $[\psi_3]$, respectively. $[\varphi_3]$ has only one exponent sum of $[\mu_{1,3}]$, so for $[\psi_3]$ we only need to calculate exponent sum of $[\mu_{1,2}]$. We can think of ψ_3 as positive push off of a circle on the Seifert surface Σ which takes $-a_1 + b_1 - b_3$ value in $H_1(\Sigma)$, hence ψ_3 has $-x_1$ exponent sum of $[\mu_{1,2}]$ by the following calculations :

$$\begin{aligned} \text{lk}(\psi_3, \gamma_{1,2}) &= (0 \ 0 \ 0 \ 1 \ 0 \ 0) \cdot M \cdot (-1 \ 1 \ 0 \ 0 \ 0 \ -1)^T \\ &= -x_1 \end{aligned}$$

Then again by Proposition 2.3, in total we have x_1 exponent sum of $[[\mu_{1,2}], [\mu_{1,3}]]$ in $[\varphi_3, \psi_3] \in \pi_2/\pi_3$. Since the third band goes through the surface x_2 times in total we have x_1x_2 effect on the Milnor's triple linking number.

We use the same method for the case when the fifth band goes through the surface. We will tube along the $\gamma_{1,2}$ as before (see Figure 17). We will let φ_4, ψ_4 be the circles described in Figure 17. $[\varphi_4]$ has only one exponent sum of $[\mu_{1,2}]$, so for $[\psi_4]$ we only need to calculate exponent sum of $[\mu_{1,3}]$. We can think of ψ_4 as positive push off of a circle on the Seifert surface Σ which takes $a_1 - b_1 + b_3$ value in $H_1(\Sigma)$ hence ψ_4 has y_1 exponent sum of $[\mu_{1,3}]$ by the following calculations :

$$\begin{aligned} \text{lk}(\psi_3, \gamma_{1,2}) &= (0 \ 0 \ 0 \ 0 \ 0 \ 1) \cdot M \cdot (1 \ -1 \ 0 \ 0 \ 0 \ 1)^T \\ &= y_1 \end{aligned}$$

Then again by Proposition 2.3, in total we have y_1 exponent sum of $[[\mu_{1,2}], [\mu_{1,3}]]$ in $[\varphi_4, \psi_4] \in \pi_2/\pi_3$. Since the third band goes through the surface y_2 times in total we have y_1y_2 effect on the Milnor's triple linking number.

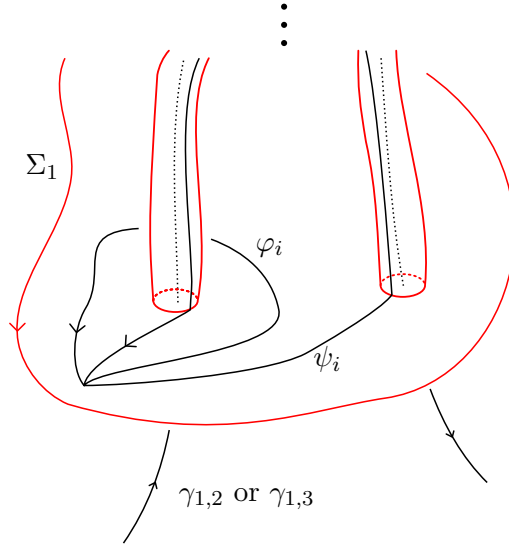

FIGURE 17. ψ_i and φ_i for $i = 3, 4$

In addition, we have φ_5, ψ_5 , which is the core of the two bands of Σ_1 before the modifications (see Figure 14). We have pushed the surface Σ_1 towards the negative directions hence we can think of φ_5 as negative push off of a circle on the Seifert surface Σ which takes $a_2 + b_2$ value in $H_1(\Sigma)$ and we can think of ψ_5 as negative push off of a circle on the Seifert surface Σ which takes $-b_2 - a_3$ value in $H_1(\Sigma)$. Then φ_5 has b exponent sum of $[\mu_{1,2}]$ and z_1 exponent sum of $[\mu_{1,3}]$, and ψ_5 has $-z_2$ exponent sum of $[\mu_{1,2}]$ and $-c$ exponent sum of

$[\mu_{1,3}]$ by the following calculations :

$$\begin{aligned} \text{lk}(\varphi_5, \gamma_{1,2}) &= (0 \ 0 \ 1 \ 1 \ 0 \ 0) \cdot M \cdot (0 \ 0 \ 0 \ 1 \ 0 \ 0)^T \\ &= b \\ \text{lk}(\varphi_5, \gamma_{1,3}) &= (0 \ 0 \ 1 \ 1 \ 0 \ 0) \cdot M \cdot (0 \ 0 \ 0 \ 0 \ 0 \ 1)^T \\ &= z_1 \\ \text{lk}(\psi_5, \gamma_{1,2}) &= (0 \ 0 \ 0 \ -1 \ -1 \ 0) \cdot M \cdot (0 \ 0 \ 0 \ 1 \ 0 \ 0)^T \\ &= -z_2 \\ \text{lk}(\psi_5, \gamma_{1,3}) &= (0 \ 0 \ 0 \ -1 \ -1 \ 0) \cdot M \cdot (0 \ 0 \ 0 \ 0 \ 0 \ 1)^T \\ &= -c. \end{aligned}$$

Using Proposition 2.3, in total we have $-bc + z_1z_2$ exponent sum of $[[\mu_{1,2}], [\mu_{1,3}]]$ in $[\varphi_5, \psi_5] \in \pi_2/\pi_3$. If we total all the effects we get $(a-1)(-c-1) - b + x_1x_2 + y_1y_2 - bc + z_1z_2 = (a-1)(b-1)(c-1) - abc + x_1x_2 + y_1y_2 + z_1z_2$ as desired.

Now for integer n greater than 1, we will produce a link L_n which is a derivative associated with H such that $\bar{\mu}_{L_n}(123) = n \cdot ((a-1)(b-1)(c-1) - abc + x_1x_2 + y_1y_2 + z_1z_2)$. First we will describe $\widetilde{\Sigma}_n$ and $\gamma_{n,1}, \gamma_{n,2}, \gamma_{n,3}$ embedding of circles on $\widetilde{\Sigma}_n$. In order to do so we will start with $\gamma_{1,1}, \gamma_{1,2}, \gamma_{1,3}$ embedded in $\widetilde{\Sigma}_1$ and we will make some modifications to it. We will use Figure 22, 23, and 24 to describe the modifications. Let $\widetilde{\Sigma}_n$ be the same surface as $\widetilde{\Sigma}_1$. For Figure 22, and Figure 24 we will take n parallel copies of green curves without changing anything else. For Figure 23 we will alter the core of the bands which bound $\gamma_{1,1}$. The cores will wrap around the third and the fourth band of $\widetilde{\Sigma}_n$ as described in Figure 18. Further inside the red band we will make some alterations as in Figure 19. We will denote red circle, green circle, and blue circle on $\widetilde{\Sigma}_n$ as $\gamma_{n,1}, \gamma_{n,2}$, and $\gamma_{n,3}$ respectively. Also, we will denote $\gamma'_{n,i}$ as the intersection dual of $\gamma_{n,i}$, for $i = 1, 2, 3$. For the convenience of readers we have presented $\gamma_{2,1}, \gamma_{2,2}, \gamma_{2,3}$ in Figure 25, 26, and 27 at the end of this paper. As before let $\phi_n : \widetilde{\Sigma}_n \rightarrow \Sigma$ be the obvious map which sends the core of i th band of $\widetilde{\Sigma}_n$ to the core of the i th band of Σ . By abusing notation we will denote image of $\gamma_{n,i}$ under ϕ_n as $\gamma_{n,i}$ and image of $\gamma'_{n,i}$ under ϕ_n as $\gamma'_{n,i}$ for $i = 1, 2, 3$. Then it is easy to check that for $i = 1, 2, 3$, $[\gamma'_{n,i}] = a_i$ and $[\gamma_{n,i}] = b_i$ in $H_1(\Sigma)$ and $\{\gamma_{n,1}, \gamma_{n,2}, \gamma_{n,3}\}$ is a derivative of K associated with H . As before we will let L_n be the link $\{\gamma_{n,1}, \gamma_{n,2}, \gamma_{n,3}\} \subset S^3$ on the Seifert surface Σ . We will denote the obvious surface that $\gamma_{n,1}$ bounds by Σ_n .

For the calculation of $\bar{\mu}_{L_n}(123)$ we will omit some of the details since they are very similar to the case when $n = 1$. We will modify Σ_n so that it does not intersect $\gamma_{n,1}, \gamma_{n,2}$, and $\gamma_{n,3}$. As before we will not worry about the case when Σ_n intersects $\gamma_{n,1}$. When the first band goes through Σ_n , since we have taken n parallel copies of green curves the total effect by green curves on Milnor's triple linking number should be multiplied by n . Also since the blue curve, which we denote it by $\psi_{n,2}$ (which was ψ_2 for the case when $n = 1$), represents $b_1 + n \cdot a_2 + b_2 + b_3$ in $H_1(\Sigma)$, we have the following calculation:

$$\begin{aligned} \text{lk}(\psi_{n,2}, \gamma_{1,2}) &= (0 \ 1 \ n \ 1 \ 0 \ 1) \cdot M \cdot (0 \ 0 \ 0 \ 1 \ 0 \ 0)^T \\ &= n \cdot b. \end{aligned}$$

This tells us that the total effect by the blue curve on Milnor's triple linking number should be multiplied by n also. Hence in total we have $n \cdot (a-1)(-c-1) - b$ effect on the

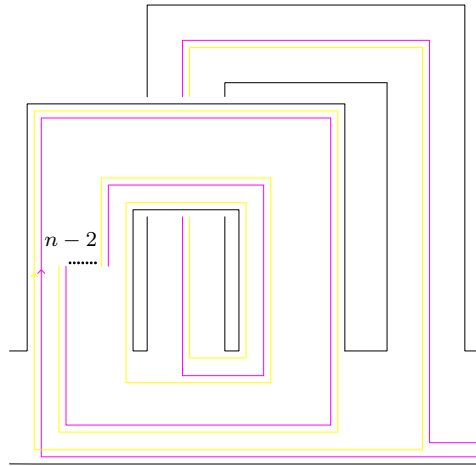

FIGURE 18. The yellow curve represents core of the first band φ_{n,k_n} and the purple curve represents core of the second band ψ_{n,k_n} .

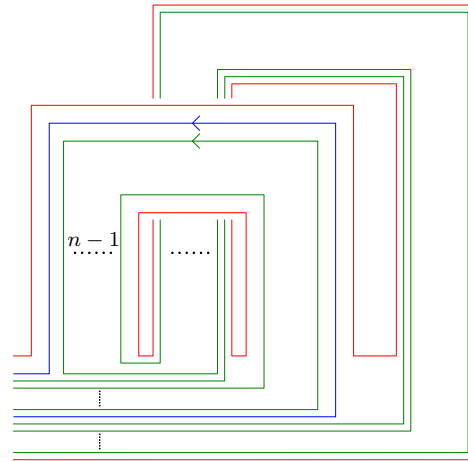

FIGURE 19. The green curves represents $\gamma_{n,2}$ and the blue curve represents $\gamma_{n,3}$ inside two bands which bounds $\gamma_{n,1}$.

Milnor's triple linking number. It is easy to see that the effect of the third band and the fifth band going through the surface Σ_n also needs to be multiplied by n , hence we have $n \cdot x_1x_2 + n \cdot y_1y_2$.

Lastly we have two more bands of Σ_n before any modifications, φ_{n,k_n} and ψ_{n,k_n} where k_n is genus of Σ_n . Again, we can think of φ_{n,k_n} as negative push off of a circle on the Seifert surface Σ which takes $n \cdot a_2 + b_2$ value in $H_1(\Sigma)$ and we can think of ψ_{n,k_n} as negative push off of a circle on the Seifert surface Σ which takes $-(n - 1) \cdot a_2 - b_2 - a_3$ value in $H_1(\Sigma)$. Hence we have, φ_{n,k_n} has $n \cdot b$ exponent sum of $[\mu_{1,2}]$ and $n \cdot z_1$ exponent sum of $[\mu_{1,3}]$, and ψ_{n,k_n} has $-(n - 1) \cdot b - z_2$ exponent sum of $[\mu_{1,2}]$ and $-(n - 1) \cdot z_1 - c$ exponent sum of

$[\mu_{1,3}]$ by the following calculations :

$$\begin{aligned} \text{lk}(\varphi_{n,k_n}, \gamma_{1,2}) &= (0 \ 0 \ n \ 1 \ 0 \ 0) \cdot M \cdot (0 \ 0 \ 0 \ 1 \ 0 \ 0)^T \\ &= n \cdot b \\ \text{lk}(\varphi_{n,k_n}, \gamma_{1,3}) &= (0 \ 0 \ n \ 1 \ 0 \ 0) \cdot M \cdot (0 \ 0 \ 0 \ 0 \ 0 \ 1)^T \\ &= n \cdot z_1 \\ \text{lk}(\psi_{n,k_n}, \gamma_{1,2}) &= (0 \ 0 \ -(n-1) \ -1 \ -1 \ 0) \cdot M \cdot (0 \ 0 \ 0 \ 1 \ 0 \ 0)^T \\ &= -(n-1) \cdot b - z_2 \\ \text{lk}(\psi_{n,k_n}, \gamma_{1,3}) &= (0 \ 0 \ -(n-1) \ -1 \ -1 \ 0) \cdot M \cdot (0 \ 0 \ 0 \ 0 \ 0 \ 1)^T \\ &= -(n-1) \cdot z_1 - c. \end{aligned}$$

In total, we have $n \cdot (-bc + z_1 z_2)$ exponent sum of $[[\mu_{1,2}], [\mu_{1,3}]]$ in $[\varphi_{n,k_n}, \psi_{n,k_n}] \in \pi_2/\pi_3$, by Proposition 2.3. If we total all the effects, we get $n \cdot ((a-1)(b-1)(c-1) - abc + x_1 x_2 + y_1 y_2 + z_1 z_2)$ as desired.

Even though we have not covered the case when n is a negative integer, this can be easily handled. On Σ imagine we are sliding the third and the fourth band to the right so they pass the fifth and the sixth band. Then imagine mapping Σ_n to it so that now the green circle represents b_3 in $H_1(\Sigma)$ and the blue circle represents b_2 in $H_1(\Sigma)$. Then we can follow the same calculations but since the roles of the green circle and the blue circle have been switched, we get the desired equation for negative integers. \square

Remark 4.4. Notice that once we fix a metabolizer H of a knot, the set $\{n \cdot ((a-1)(b-1)(c-1) - abc + x_1 x_2 + y_1 y_2 + z_1 z_2) | n \in \mathbb{Z}\}$ does not depend on the choice of a basis of H and the choice of a symplectic basis for $H_1(F)$ which extends that basis of H . This can be easily seen by considering a Seifert matrix $M' = \begin{pmatrix} A & B \\ B^\top - Id & 0 \end{pmatrix}$ with respect to the basis $\{a_1, a_2, a_3, b_1, b_2, b_3\}$. Then notice that $(a-1)(b-1)(c-1) - abc + x_1 x_2 + y_1 y_2 + z_1 z_2 = \det(B^\top - Id) - \det(B)$. If we pick a different basis, $\{\tilde{b}_1, \tilde{b}_2, \tilde{b}_3\}$, for H and extend it to a symplectic basis, $\{\tilde{a}_1, \tilde{a}_2, \tilde{a}_3, \tilde{b}_1, \tilde{b}_2, \tilde{b}_3\}$, for $H_1(F)$, then we get the Seifert matrix $\tilde{M}' = \begin{pmatrix} \tilde{A} & P_2^\top B P_1 \\ P_1^\top (B^\top - Id) P_2 & 0 \end{pmatrix}$ with respect to the basis $\{\tilde{a}_1, \tilde{a}_2, \tilde{a}_3, \tilde{b}_1, \tilde{b}_2, \tilde{b}_3\}$, where P_1 and P_2 are change of basis matrices. Hence, we have $\det(P_1^\top (B^\top - Id) P_2) - \det(P_2^\top B P_1) = \pm \det(B^\top - Id) - \det(B)$, so we can conclude that the choice of a basis does not have an effect on the set $\{n \cdot ((a-1)(b-1)(c-1) - abc + x_1 x_2 + y_1 y_2 + z_1 z_2) | n \in \mathbb{Z}\}$.

From this main theorem we have the first corollary which immediately follows from Theorem 4.3. This corollary tells us that even the derivatives of the unknot have complicated Milnor's triple linking number.

Corollary 4.5. *Let U be the unknot with a Seifert surface F given in Figure 20. For $i = 1, 2, 3$, let α_i be the core of the $(2i-1)$ th band and β_i be the core of the $(2i)$ th band. Let $H := \text{span}([\beta_1], [\beta_2], [\beta_3])$, then $S_{U,H} = \mathbb{Z}$.*

Proof. Let $a_i = [\alpha_i] \in H_1(F)$ and $b_i = [\beta_i] \in H_1(F)$ for $i = 1, 2, 3$. Then we have

$$M = \begin{pmatrix} 0 & 1 & 0 & 0 & 0 & 0 \\ 0 & 0 & 0 & 0 & 0 & 0 \\ 0 & 0 & 0 & 1 & 0 & 0 \\ 0 & 0 & 0 & 0 & 0 & 0 \\ 0 & 0 & 0 & 0 & 0 & 1 \\ 0 & 0 & 0 & 0 & 0 & 0 \end{pmatrix}$$

a Seifert matrix with respect to the basis $\{a_1, b_1, a_2, b_2, a_3, b_3\}$ and $H = \text{span}(b_1, b_2, b_3)$ is a metabolizer. By Theorem 4.3 we have $S_{U,H} \supseteq \{n \cdot (0 \cdot 0 \cdot 0 - 1 \cdot 1 \cdot 1) | n \in \mathbb{Z} = \mathbb{Z}\} = \mathbb{Z}$ as desired. \square

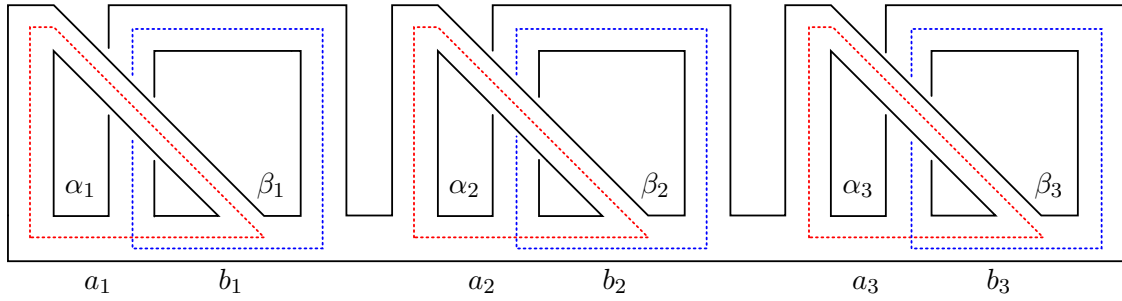

FIGURE 20. Disk-band form of Seifert surface F for the unknot U

We have one more immediate corollary from Theorem 4.3 which tells us that when there is a knot which is the connected sum of three genus one algebraically slice knots, it has at least one derivative which has non-zero Milnor's triple linking number.

Corollary 4.6. *Let K_1, K_2, K_3 be algebraically slice knots with genus one Seifert surfaces. Then $K = K_1 \# K_2 \# K_3$ has a derivative $\{\gamma_1, \gamma_2, \gamma_3\}$ where $\bar{\mu}_{\{\gamma_1, \gamma_2, \gamma_3\}}(123) \neq 0$.*

Proof. It is enough to show that there exist a metabolizer H such that $S_{K,H} \supseteq m \cdot \mathbb{Z}$ where $m \neq 0$.

Let F_1, F_2 , and F_3 be genus one Seifert surfaces for K_1, K_2 , and K_3 respectively. For $i = 1, 2, 3$, let $M_i = \begin{pmatrix} d_i & e_i \\ e_i - 1 & 0 \end{pmatrix}$ be a Seifert matrix with respect to a symplectic basis $\{a_i, b_i\}$ of $H_1(F_i)$, so that $H_i := \text{span}(b_i)$ is a metabolizer for K_i . For $i = 1, 2, 3$, let $n_i = \text{gcd}(2e_i - 1, -d_i)$, $x_i = \frac{2e_i - 1}{n_i}$, and $y_i = \frac{-d_i}{n_i}$, then since $\text{gcd}(x_i, y_i) = 1$, there exist a pair of integers (z_i, w_i) such that $-x_i w_i + z_i y_i = 1$ (i.e. $-(2e_i - 1)w_i - d_i z_i = n_i$).

Then for $i = 1, 2, 3$, we have the following calculations :

$$\begin{aligned}
(z_i \ w_i) \cdot \begin{pmatrix} d_i & e_i \\ e_i - 1 & 0 \end{pmatrix} \cdot \begin{pmatrix} x_i \\ y_i \end{pmatrix} &= \frac{1}{n_i} \cdot (z_i \ w_i) \cdot \begin{pmatrix} d_i(2e_i - 1) - e_i d_i \\ (e_i - 1)(2e_i - 1) \end{pmatrix} \\
&= \frac{1}{n_i} \cdot (d_i(2e_i - 1)z_i - e_i d_i z_i + (e_i - 1)(2e_i - 1)w_i) \\
&= \frac{1}{n_i} \cdot (-d_i z_i - (2e_i - 1)w_i + e_i(d_i z_i + (2e_i - 1)w_i)) \\
&= \frac{1}{n_i} \cdot (n_i - n_i e_i) \\
&= 1 - e_i \\
(x_i \ y_i) \cdot \begin{pmatrix} d_i & e_i \\ e_i - 1 & 0 \end{pmatrix} \cdot \begin{pmatrix} z_i \\ w_i \end{pmatrix} &= \frac{1}{n_i} \cdot (2e_i - 1 \ -d_i) \cdot \begin{pmatrix} d_i z_i + e_i w_i \\ (e_i - 1)z_i \end{pmatrix} \\
&= \frac{1}{n_i} \cdot (d_i z_i(2e_i - 1) + e_i w_i(2e_i - 1) - (e_i - 1)z_i d_i) \\
&= \frac{1}{n_i} \cdot (e_i(d_i z_i + w_i(2e_i - 1))) \\
&= \frac{1}{n_i} \cdot (-n_i e_i) \\
&= -e_i \\
(x_i \ y_i) \cdot \begin{pmatrix} d_i & e_i \\ e_i - 1 & 0 \end{pmatrix} \cdot \begin{pmatrix} x_i \\ x_i \end{pmatrix} &= \frac{1}{n_i^2} \cdot (2e_i - 1 \ -d_i) \cdot \begin{pmatrix} d_i(2e_i - 1) - e_i d_i \\ (e_i - 1)(2e_i - 1) \end{pmatrix} \\
&= \frac{1}{n_i^2} \cdot (d_i(2e_i - 1)^2 - e_i(2e_i - 1)d_i - d_i(e_i - 1)(2e_i - 1)) \\
&= \frac{d}{n_i} \cdot (4e_i^2 - 4e_i + 1 - 2e_i^2 + e_i - 2e_i^2 + 3e_i - 1) \\
&= \frac{1}{n_i} \cdot (0) \\
&= 0.
\end{aligned}$$

Therefore, for $i = 1, 2, 3$, $\widetilde{H}_i := \text{span}(x_i a_i + y_i b_i)$ is also a metabolizer for K_i and we have a Seifert matrix $\widetilde{M}_i = \begin{pmatrix} * & -e_i + 1 \\ -e_i & 0 \end{pmatrix}$ for K_i with respect to a symplectic basis $\{z_i a_i + w_i b_i, x_i a_i + y_i b_i\}$. Hence we can change basis so that the Seifert matrix takes value of either $\begin{pmatrix} * & e_i \\ e_i - 1 & 0 \end{pmatrix}$ or $\begin{pmatrix} * & -e_i + 1 \\ -e_i & 0 \end{pmatrix}$ for $i = 1, 2, 3$. Therefore we can assume $|e_i| > |e_i - 1|$ for each $i = 1, 2, 3$, which implies that $|e_1| \cdot |e_2| \cdot |e_3| > |e_1 - 1| \cdot |e_2 - 1| \cdot |e_3 - 1|$.

Now, let $F = F_1 \natural F_2 \natural F_3$ be a Seifert surface for K and it has Seifert matrix

$$M = \begin{pmatrix} * & e_1 & 0 & 0 & 0 & 0 \\ e_1 - 1 & 0 & 0 & 0 & 0 & 0 \\ 0 & 0 & * & e_2 & 0 & 0 \\ 0 & 0 & e_2 - 1 & 0 & 0 & 0 \\ 0 & 0 & 0 & 0 & * & e_3 \\ 0 & 0 & 0 & 0 & e_3 - 1 & 0 \end{pmatrix}.$$

Then by Theorem 4.3 we have $S_{K,H} \supseteq ((e_1 - 1)(e_2 - 1)(e_3 - 1) - e_1 e_2 e_3) \cdot \mathbb{Z}$ where $((e_1 - 1)(e_2 - 1)(e_3 - 1) - e_1 e_2 e_3) \neq 0$ as desired. \square

We will end this paper with few remarks.

Remark 4.7.

- (1) Notice that Corollary 4.5 is a special case of Corollary 4.6, where K_1, K_2, K_3 are unknots.
- (2) For the proof of corollary 4.6 we only needed the assumption that K has the same Seifert matrix as the connected sum of three genus one algebraically slice knots.

REFERENCES

- [CD15] Tim D. Cochran and Christopher William Davis. Counterexamples to Kauffman's conjectures on slice knots. *Adv. Math.*, 274:263–284, 2015.
- [CFT09] Tim Cochran, Stefan Friedl, and Peter Teichner. New constructions of slice links. *Comment. Math. Helv.*, 84(3):617–638, 2009.
- [CHL10] Tim D. Cochran, Shelly Harvey, and Constance Leidy. Derivatives of knots and second-order signatures. *Algebr. Geom. Topol.*, 10(2):739–787, 2010.
- [Coc90] Tim D. Cochran. Derivatives of links: Milnor's concordance invariants and Massey's products. *Mem. Amer. Math. Soc.*, 84(427):x+73, 1990.
- [COT04] Tim D. Cochran, Kent E. Orr, and Peter Teichner. Structure in the classical knot concordance group. *Comment. Math. Helv.*, 79(1):105–123, 2004.
- [Gil83] Patrick M. Gilmer. Slice knots in S^3 . *Quart. J. Math. Oxford Ser. (2)*, 34(135):305–322, 1983.
- [Gil93] Patrick Gilmer. Classical knot and link concordance. *Comment. Math. Helv.*, 68(1):1–19, 1993.
- [GL92a] P. Gilmer and C. Livingston. The Casson-Gordon invariant and link concordance. *Topology*, 31(3):475–492, 1992.
- [GL92b] Patrick Gilmer and Charles Livingston. Discriminants of Casson-Gordon invariants. *Math. Proc. Cambridge Philos. Soc.*, 112(1):127–139, 1992.
- [GL13] Patrick M. Gilmer and Charles Livingston. On surgery curves for genus-one slice knots. *Pacific J. Math.*, 265(2):405–425, 2013.
- [Hal50] Marshall Hall, Jr. A basis for free Lie rings and higher commutators in free groups. *Proc. Amer. Math. Soc.*, 1:575–581, 1950.
- [JKP14] Hye Jin Jang, Min Hoon Kim, and Mark Powell. Smooth slice boundary links whose derivative links have nonvanishing Milnor invariants. *Michigan Math. J.*, 63(2):423–446, 2014.
- [Lev69] J. Levine. Knot cobordism groups in codimension two. *Comment. Math. Helv.*, 44:229–244, 1969.
- [Lit84] R. A. Litherland. Cobordism of satellite knots. In *Four-manifold theory (Durham, N.H., 1982)*, volume 35 of *Contemp. Math.*, pages 327–362. Amer. Math. Soc., Providence, RI, 1984.
- [Mar15] Taylor E. Martin. Classification of links up to 0-solvability. <http://arxiv.org/abs/1511.00156>, 2015.
- [Mil54] John Milnor. Link groups. *Ann. of Math. (2)*, 59:177–195, 1954.
- [Mil57] John Milnor. Isotopy of links. Algebraic geometry and topology. In *A symposium in honor of S. Lefschetz*, pages 280–306. Princeton University Press, Princeton, N. J., 1957.
- [MKS04] Wilhelm Magnus, Abraham Karrass, and Donald Solitar. *Combinatorial group theory*. Dover Publications, Inc., Mineola, NY, second edition, 2004. Presentations of groups in terms of generators and relations.
- [NS03] Swatee Naik and Theodore Stanford. A move on diagrams that generates S -equivalence of knots. *J. Knot Theory Ramifications*, 12(5):717–724, 2003.
- [Orr89] Kent E. Orr. Homotopy invariants of links. *Invent. Math.*, 95(2):379–394, 1989.
- [Par15] JungHwan Park. A construction of slice knots via annulus modifications. Preprint: <http://arxiv.org/abs/1512.00401>, 2015.

DEPARTMENT OF MATHEMATICS, RICE UNIVERSITY MS-136, 6100 MAIN ST. P.O. BOX 1892, HOUSTON, TX 77251-1892

E-mail address: jp35@rice.edu

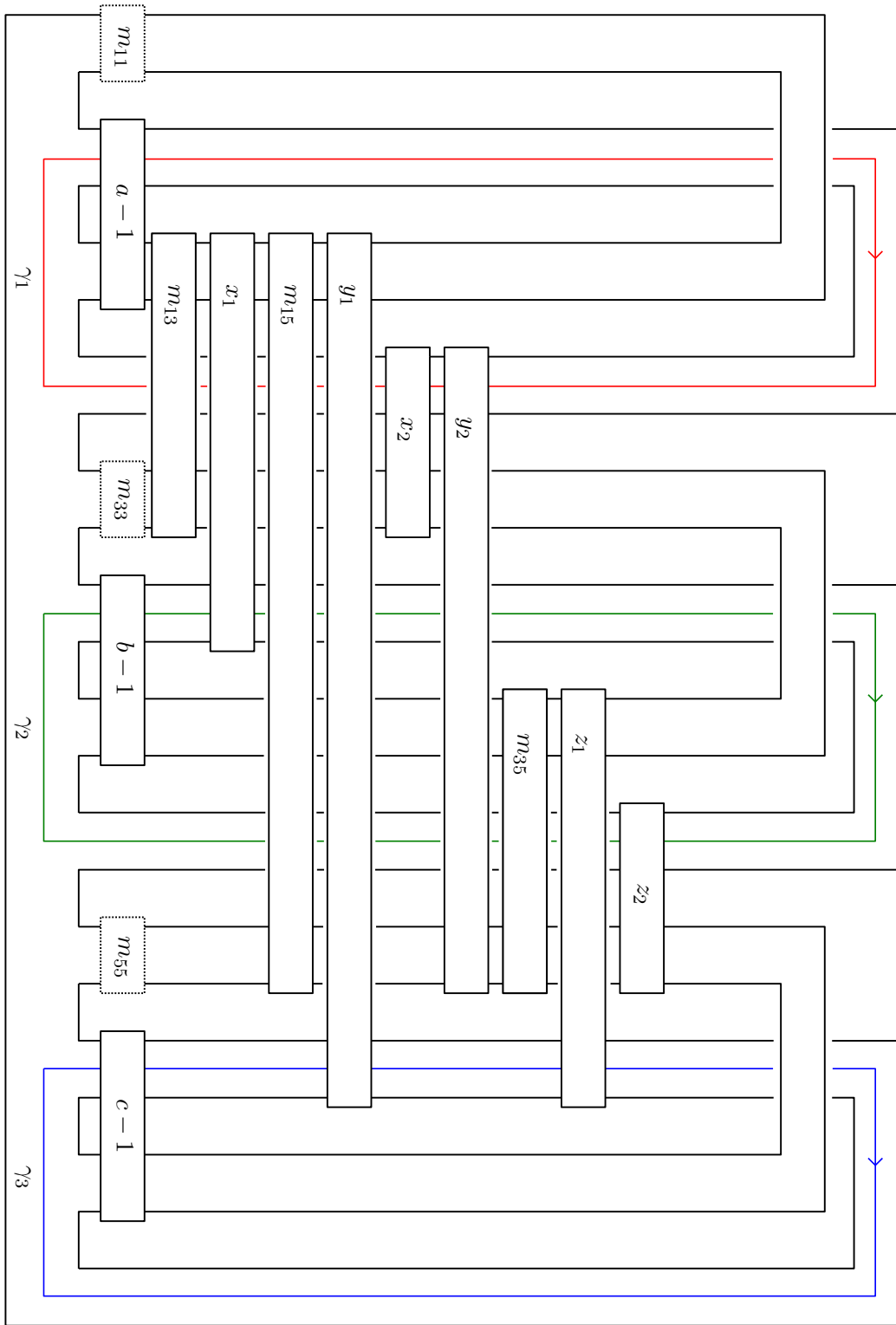

FIGURE 21. Knot K with the simplest Seifert surface and the derivative $\{\gamma_1, \gamma_2, \gamma_3\}$ associated with H . (Dotted box represents full twists and solid box represents full twists between two bands with no twist on each bands.)

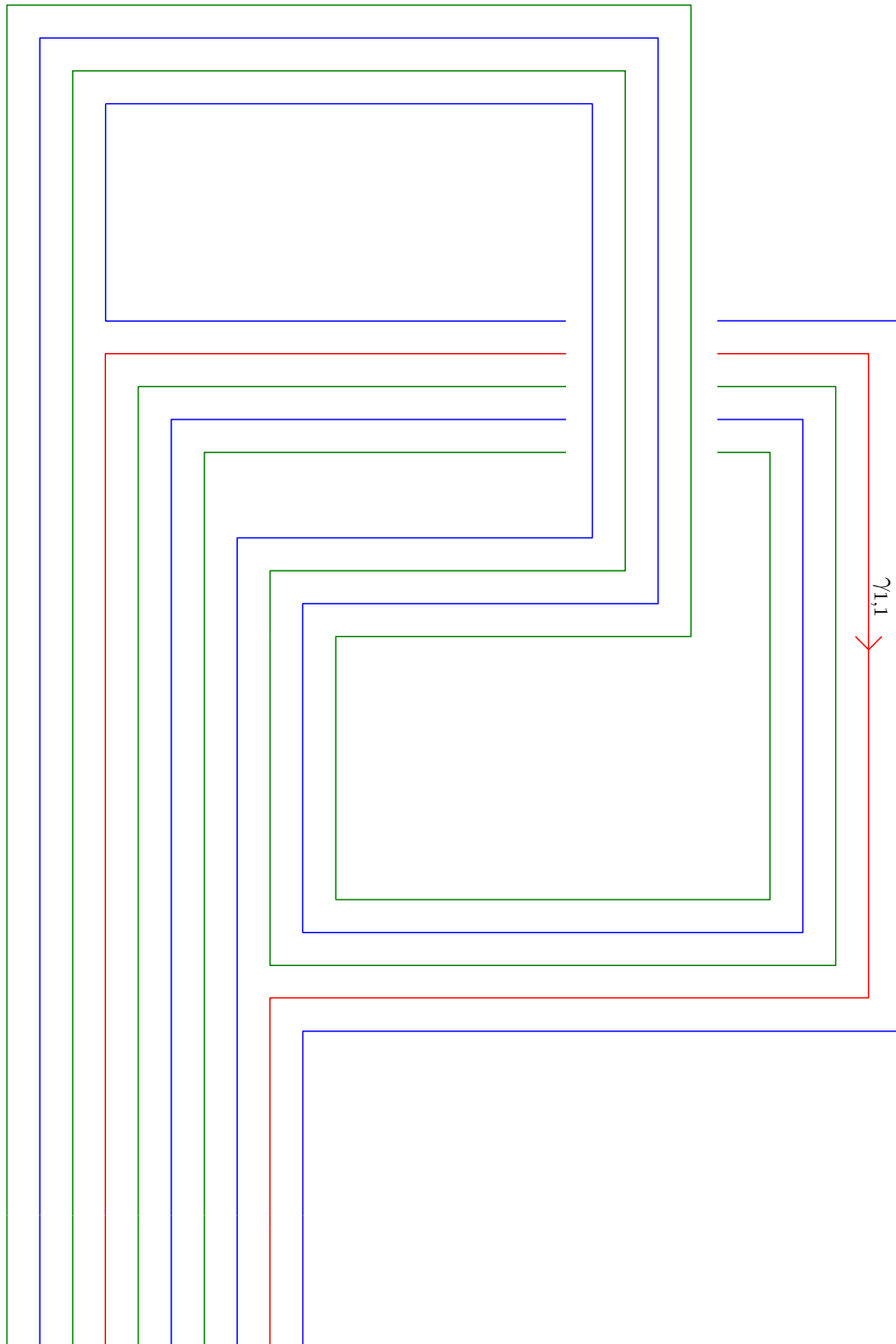

FIGURE 22. Link $L_1 = \{\gamma_{1,1}, \gamma_{1,2}, \gamma_{1,3}\}$ embedded in $\widetilde{\Sigma}_1$. (Obvious $\widetilde{\Sigma}_1$ is omitted for simplicity.)

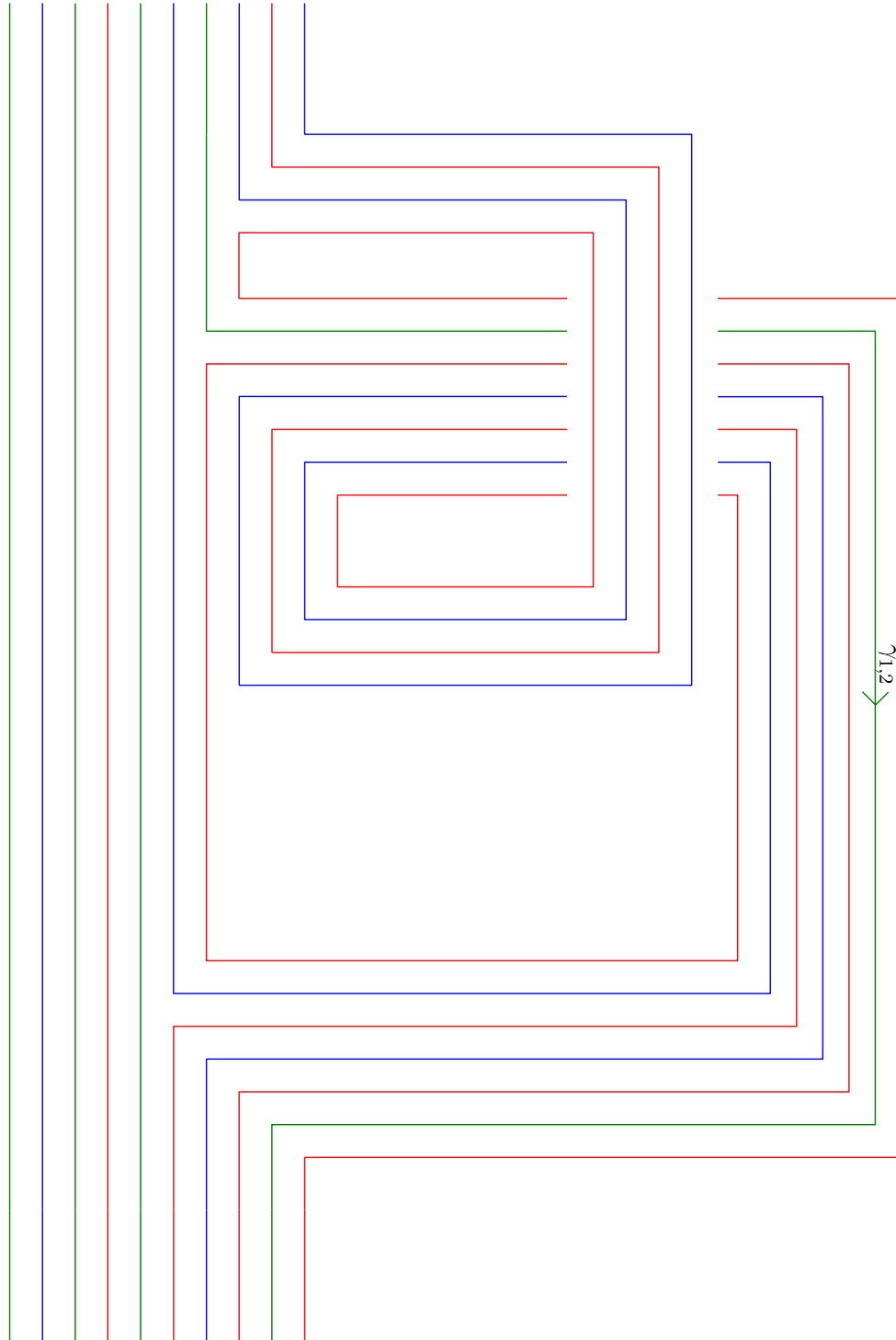

FIGURE 23. Link $L_1 = \{\gamma_{1,1}, \gamma_{1,2}, \gamma_{1,3}\}$ embedded in $\widetilde{\Sigma}_1$. (Obvious $\widetilde{\Sigma}_1$ is omitted for simplicity.)

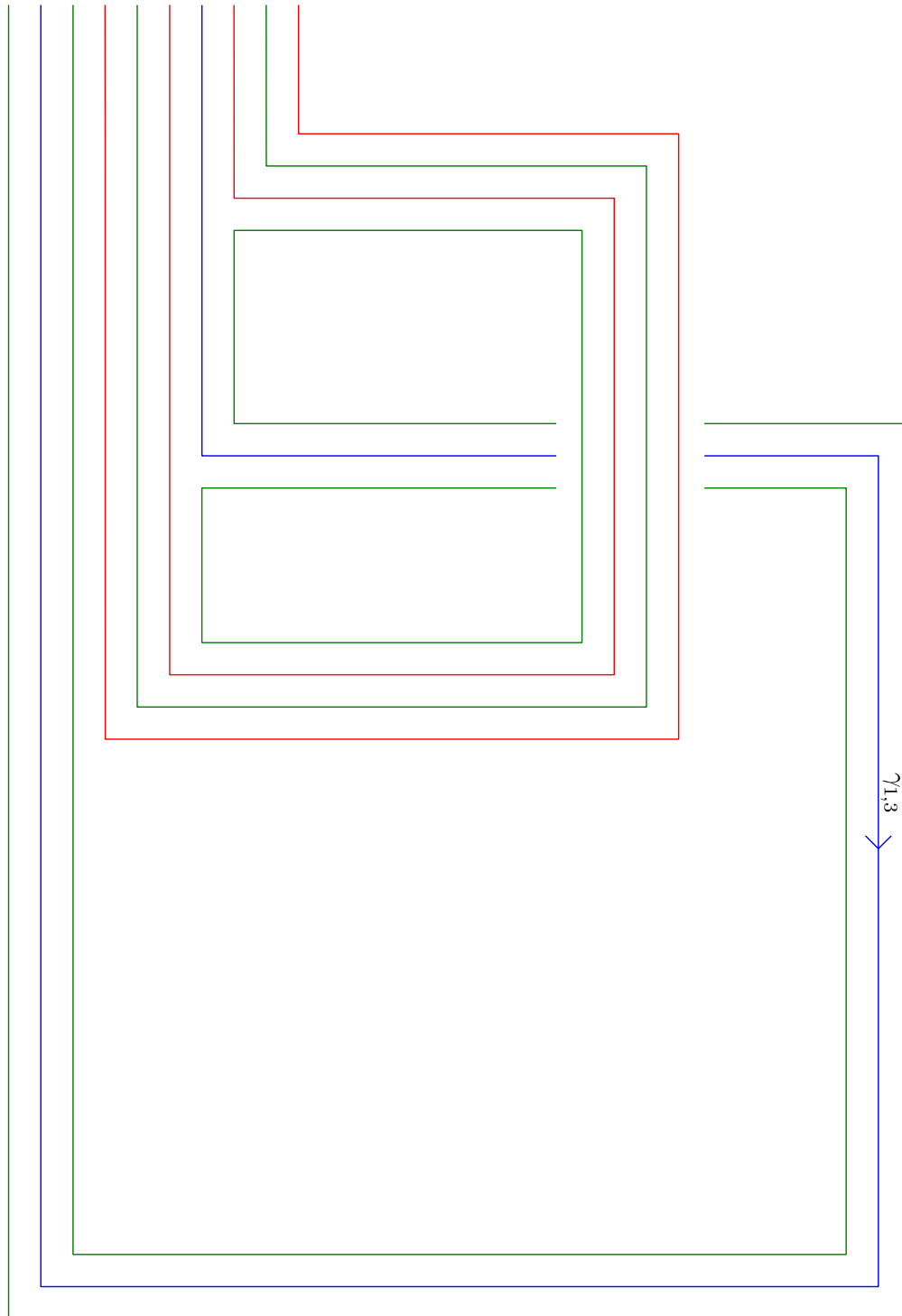

FIGURE 24. Link $L_1 = \{\gamma_{1,1}, \gamma_{1,2}, \gamma_{1,3}\}$ embedded in $\widetilde{\Sigma}_1$. (Obvious $\widetilde{\Sigma}_1$ is omitted for simplicity.)

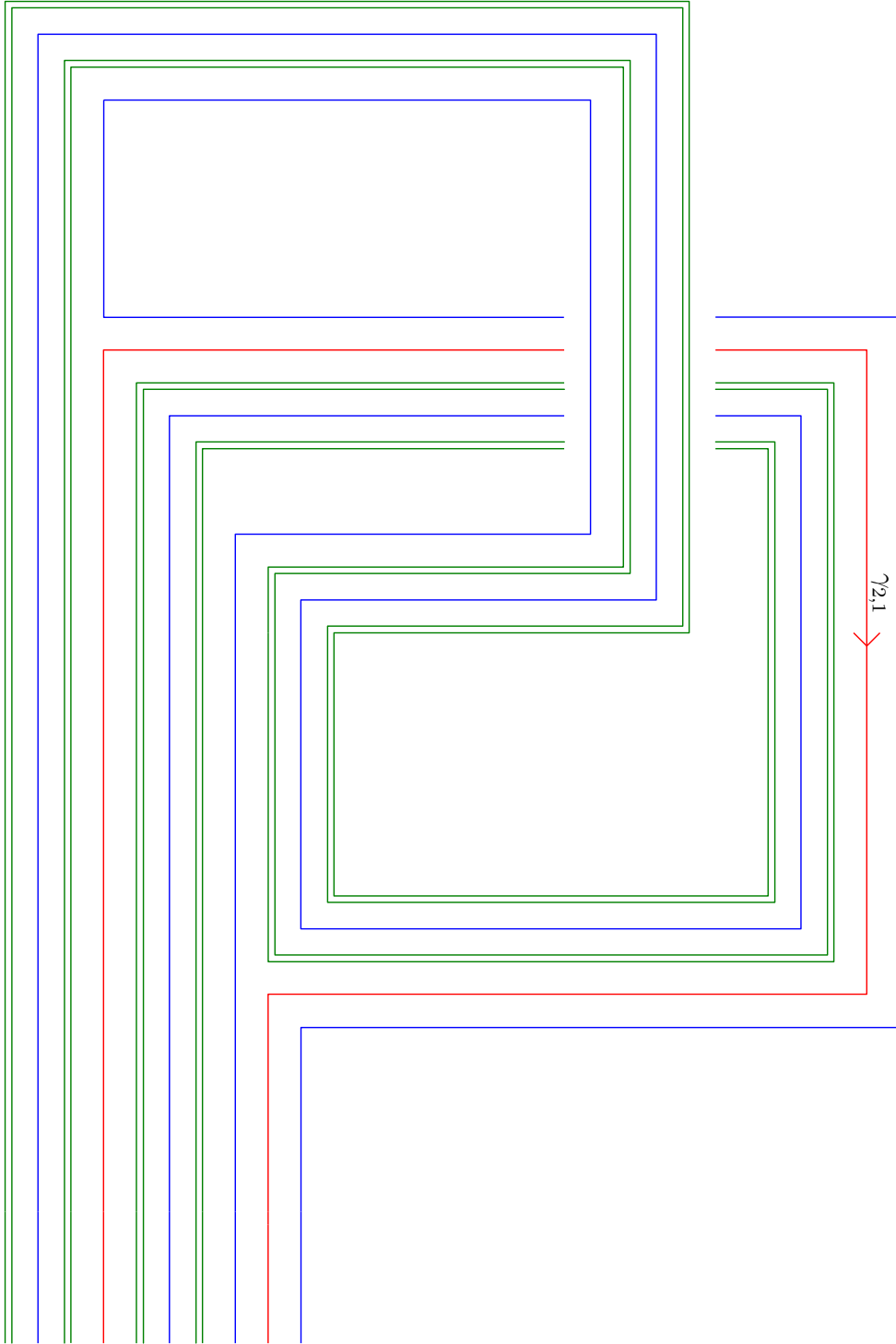

FIGURE 25. Link $L_2 = \{\gamma_{2,1}, \gamma_{2,2}, \gamma_{2,3}\}$ embedded in $\widetilde{\Sigma}_2$. (Obvious $\widetilde{\Sigma}_2$ is omitted for simplicity.)

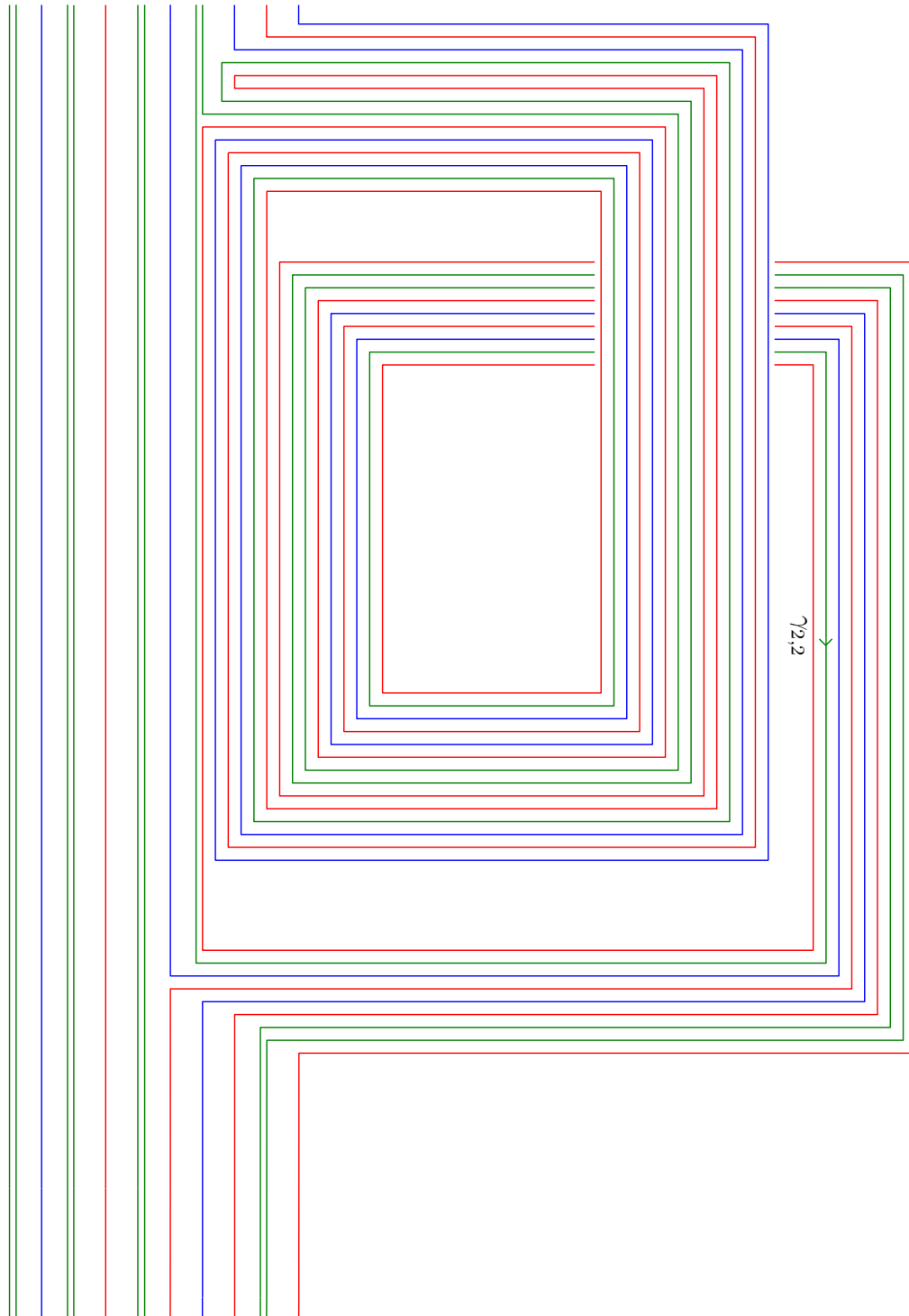

FIGURE 26. Link $L_2 = \{\gamma_{2,1}, \gamma_{2,2}, \gamma_{2,3}\}$ embedded in $\widetilde{\Sigma}_2$. (Obvious $\widetilde{\Sigma}_2$ is omitted for simplicity.)

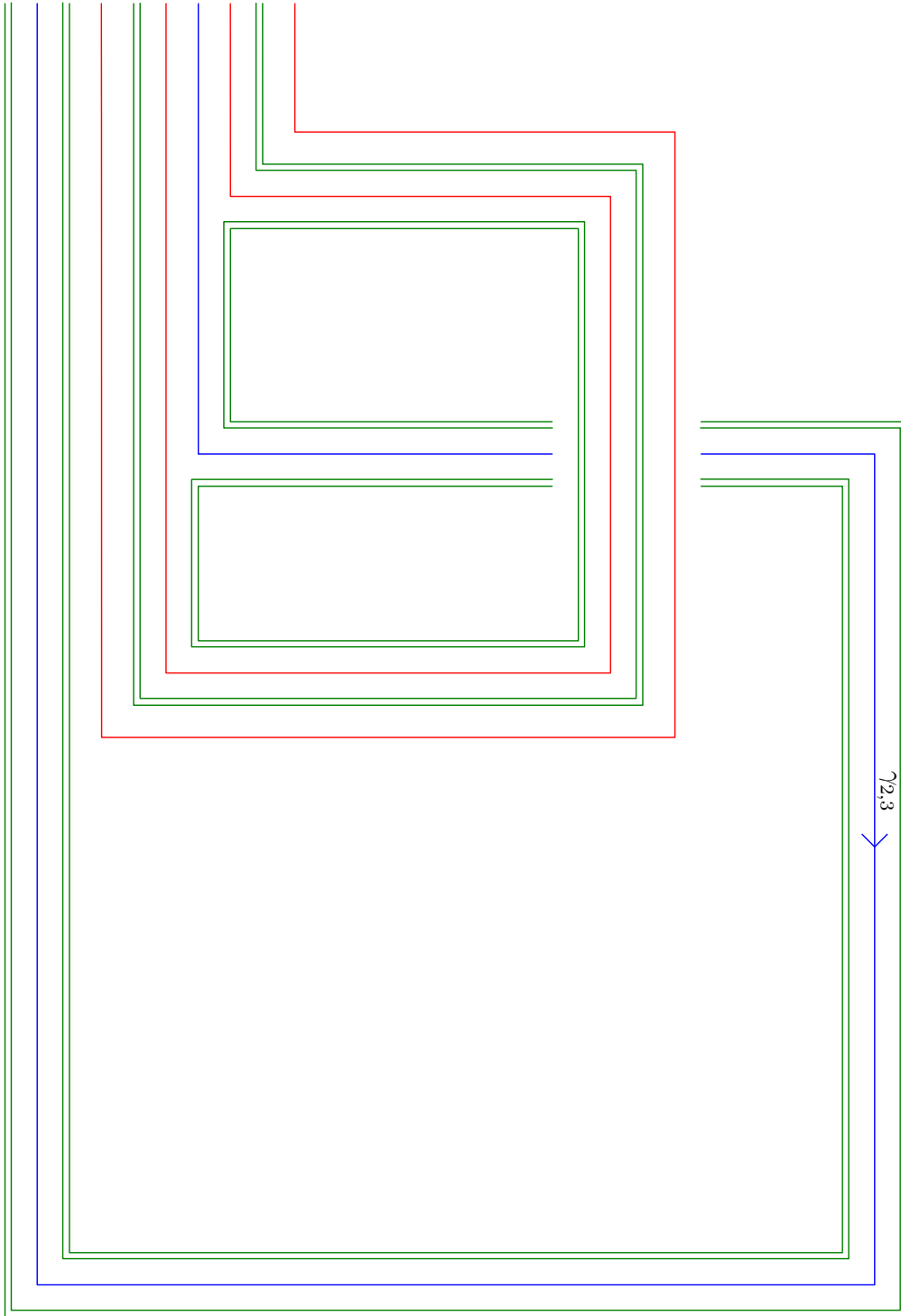

FIGURE 27. Link $L_2 = \{\gamma_{2,1}, \gamma_{2,2}, \gamma_{2,3}\}$ embedded in $\widetilde{\Sigma}_2$. (Obvious $\widetilde{\Sigma}_2$ is omitted for simplicity.)