

# On the Partition Dimension and the Twin Number of a Graph \*

C. Hernando<sup>†</sup>      M. Mora<sup>‡</sup>      I. M. Pelayo<sup>§</sup>

October 14, 2018

## Abstract

A partition  $\Pi$  of the vertex set of a connected graph  $G$  is a *locating partition* of  $G$  if every vertex is uniquely determined by its vector of distances to the elements of  $\Pi$ . The *partition dimension* of  $G$  is the minimum cardinality of a locating partition of  $G$ . A pair of vertices  $u, v$  of a graph  $G$  are called *twins* if they have exactly the same set of neighbors other than  $u$  and  $v$ . A *twin class* is a maximal set of pairwise twin vertices. The *twin number* of a graph  $G$  is the maximum cardinality of a twin class of  $G$ .

In this paper we undertake the study of the partition dimension of a graph by also considering its twin number. This approach allows us to obtain the set of connected graphs of order  $n \geq 9$  having partition dimension  $n - 2$ . This set is formed by exactly 15 graphs, instead of 23, as was wrongly stated in the paper "Discrepancies between metric dimension and partition dimension of a connected graph" (Disc. Math. 308 (2008) 5026–5031).

*Key words:* locating set; locating partition; metric dimension; partition dimension; twin number

## 1 Introduction

All the graphs considered are undirected, simple, finite and connected. The vertex set and edge set of a graph  $G$  are denoted by  $V(G)$  and  $E(G)$ . Let  $v$  be a vertex of  $G$ . The *open neighborhood* of  $v$  is  $N_G(v) = \{w \in V : vw \in E\}$ , and the *closed neighborhood* of  $v$  is  $N_G[v] = N_G(v) \cup \{v\}$ . The *degree* of  $v$  is  $\deg_G(v) = |N_G(v)|$ . If  $N_G[v] = V(G)$

---

\*Research partially supported by grants MINECO MTM2015-63791-R, Gen. Cat. DGR 2014SGR46 and MTM2014-60127-P.

<sup>†</sup>Universitat Politècnica de Catalunya, Barcelona, Spain, carmen.hernando@upc.edu

<sup>‡</sup>Universitat Politècnica de Catalunya, Barcelona, Spain, merce.mora@upc.edu

<sup>§</sup>*Corresponding author:* Departament de Matemàtiques, ESAB, Avinguda del Canal Olímpic, s/n 08860 Castelldefels, Spain.ignacio.m.pelayo@upc.edu

(resp.  $\deg_G(v) = 1$ ), then  $v$  is called *universal* (resp. a *leaf*). Let  $W$  be a subset of vertices of a graph  $G$ . The open neighborhood of  $W$  is  $N_G(W) = \cup_{v \in W} N_G(v)$ , and the closed neighborhood of  $W$  is  $N_G[W] = N_G(W) \cup W$ . The subgraph of  $G$  induced by  $W$ , denoted by  $G[W]$ , has as vertex set  $W$  and  $E(G[W]) = \{vw \in E(G) : v \in W, w \in W\}$ . The *complement* of  $G$ , denoted by  $\overline{G}$ , is the graph on the same vertices as  $G$  such that two vertices are adjacent in  $\overline{G}$  if and only if they are not adjacent in  $G$ . Let  $G_1, G_2$  be two graphs having disjoint vertex sets. The (disjoint) *union*  $G = G_1 + G_2$  is the graph such that  $V(G) = V(G_1) \cup V(G_2)$  and  $E(G) = E(G_1) \cup E(G_2)$ . The *join*  $G = G_1 \vee G_2$  is the graph such that  $V(G) = V(G_1) \cup V(G_2)$  and  $E(G) = E(G_1) \cup E(G_2) \cup \{uv : u \in V(G_1), v \in V(G_2)\}$ .

The distance between vertices  $v, w \in V(G)$  is denoted by  $d_G(v, w)$ , or  $d(v, w)$  if the graph  $G$  is clear from the context. The diameter of  $G$  is  $\text{diam}(G) = \max\{d(v, w) : v, w \in V(G)\}$ . The distance between a vertex  $v \in V(G)$  and a set of vertices  $S \subseteq V(G)$ , denoted by  $d(v, S)$  is the minimum of the distances between  $v$  and the vertices of  $S$ , that is to say,  $d(v, S) = \min\{d(v, w) : w \in S\}$ . Undefined terminology can be found in [4].

A vertex  $x \in V(G)$  *resolves* a pair of vertices  $v, w \in V(G)$  if  $d(v, x) \neq d(w, x)$ . A set of vertices  $S \subseteq V(G)$  is a *locating set* of  $G$ , if every pair of distinct vertices of  $G$  are resolved by some vertex in  $S$ . The *metric dimension*  $\beta(G)$  of  $G$  is the minimum cardinality of a locating set. Locating sets were first defined by [11] and [16], and they have since been widely investigated (see [2, 12] and their references).

Let  $G = (V, E)$  be a graph of order  $n$ . If  $\Pi = \{S_1, \dots, S_k\}$  is a partition of  $V$ , we denote by  $r(u|\Pi)$  the vector of distances between a vertex  $u \in V$  and the elements of  $\Pi$ , that is,  $r(u, \Pi) = (d(u, S_1), \dots, d(u, S_k))$ . The partition  $\Pi$  is called a *locating partition* of  $G$  if, for any pair of distinct vertices  $u, v \in V$ ,  $r(u, \Pi) \neq r(v, \Pi)$ . Observe that to prove that a given partition is locating, it is enough to check that the vectors of distances of every pair of vertices belonging to the same part are different. The *partition dimension*  $\beta_p(G)$  of  $G$  is the minimum cardinality of a locating partition of  $G$ . Locating partitions were introduced in [5], and further studied in [1, 3, 6, 7, 8, 9, 10, 14, 15, 17, 18, 19]. Next, some known results involving the partition dimension are shown.

**Theorem 1** ([5]). *Let  $G$  be a graph of order  $n \geq 3$  and diameter  $\text{diam}(G) = d$*

1.  $\beta_p(G) \leq \beta(G) + 1$ .
2.  $\beta_p(G) \leq n - d + 1$ . *Moreover, this bound is sharp.*
3.  $\beta_p(G) = n - 1$  *if and only if  $G$  is isomorphic to either the star  $K_{1, n-1}$ , or the complete split graph  $K_{n-2} \vee \overline{K_2}$ , or the graph  $K_1 \vee (K_1 + K_{n-2})$ .*

In [17], its author approached the characterization of the set of graphs of order  $n \geq 9$  having partition dimension  $n - 2$ , presenting a collection of 23 graphs (as a matter fact there are 22, as the so-called graphs  $G_4$  and  $G_6$  are isomorphic). Although employing a different notation (see Table 1), the characterization given in this paper is the following.

**Theorem 2** ([17]). *Let  $G = (V, E)$  be a graph of order  $n \geq 9$ . Then  $\beta_p(G) = n - 2$  if and only if it belongs either to the family  $\{H_i\}_{i=1}^{15}$ , except  $H_7$ , (see Figure 7) or to the family  $\{F_i\}_{i=1}^8$  (see Figure 1).*

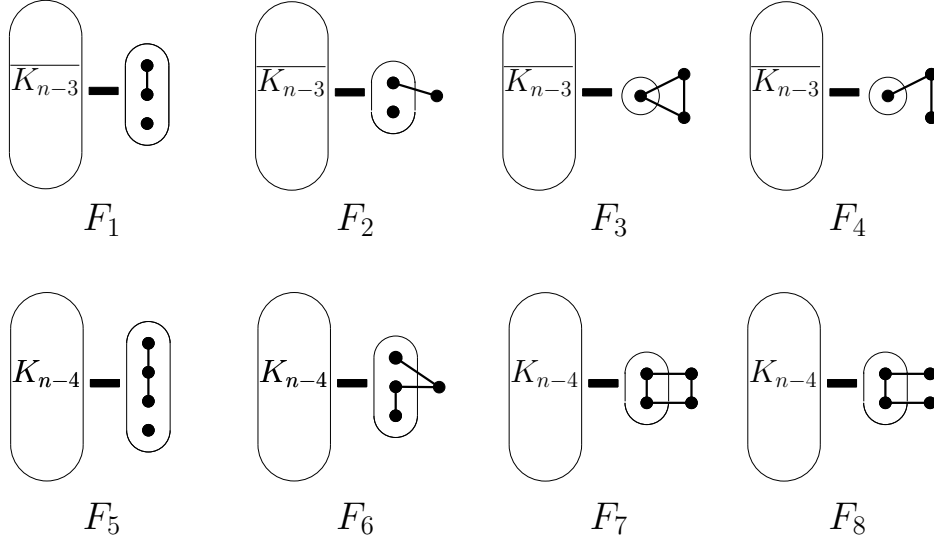

Figure 1: The thick horizontal segment means the join operation  $\vee$ . For example:  $F_1 \cong \overline{K_{n-3}} \vee (K_2 + K_1)$ ,  $F_3 \cong K_1 \vee (\overline{K_{n-3}} + K_2)$  and  $F_5 \cong \overline{K_{n-4}} \vee (P_3 + K_1)$ .

Figure 1	$F_1$	$F_2$	$F_3$	$F_4$	$F_5$	$F_6$	$F_7$	$F_8$
Paper [17]	$G_5$	$K_{2,n-2} - e$	$K_{1,n-1} + e$	$G_{11}$	$K_n - E(K_{1,3} + e)$	$G_3$	$G_7$	$G_{12}$

Table 1: The second row contains the names used in [17] for the graphs shown in Figure 1.

Thus, in particular, and according to [17], for every  $n \geq 9$ , all the graphs  $G$  displayed in Figure 1 satisfy  $\beta_p(G) = n - 2$ . However, for all of them, it holds that  $\beta_p(G) = n - 3$ , as we will prove in this paper (see Corollaries 3, 5 and 6). As a matter of example, we show next that  $\beta_p(F_1) \leq n - 3$ , for every  $n \geq 7$ . First, notice that  $F_1 \cong \overline{K_{n-3}} \vee (K_2 + K_1)$ . Next, if  $V(\overline{K_{n-3}}) = \{v_1, \dots, v_{n-3}\}$ ,  $V(K_2) = \{v_{n-2}, v_{n-1}\}$  and  $V(K_1) = \{v_n\}$ , then consider the partition  $\Pi = \{\{v_1, v_{n-2}\}, \{v_2, v_{n-1}\}, \{v_3, v_n\}, \{v_4\}, \dots, \{v_{n-3}\}\}$ . Finally, observe that  $\Pi$  is a locating partition of  $F_1$  since  $2 = d(v_i, v_4) \neq d(v_{n+i-3}, v_4) = 1$ , for every  $i \in \{1, 2, 3\}$ .

The main contribution of this work is, after showing that the theorem of characterization presented in [17] is far from being true, finding the correct answer to this problem. Motivated by this objective, we introduce the so-called *twin number*  $\tau(G)$  of a connected graph  $G$ , and present a list of basic properties, some of them directly related to the partition dimension  $\beta_p(G)$ .

The rest of the paper is organized as follows. Section 2 is devoted to introduce the notions of twin class and twin number, and to show some basic properties. In Section 3, subdivided in three subsections, a number of results involving both the twin number and the partition dimension of a graph are obtained. Finally, Section 4 includes a theorem of characterization presenting, for every  $n \geq 9$ , which graphs  $G$  of order  $n$  satisfy  $\beta_p(G) = n - 2$ .

## 2 Twin number

A pair of vertices  $u, v \in V$  of a graph  $G = (V, E)$  are called *twins* if they have exactly the same set of neighbors other than  $u$  and  $v$ . A *twin set* of  $G$  is any set of pairwise twin vertices of  $G$ . If  $uv \in E$ , then they are called *true twins*, and otherwise *false twins*. It is easy to verify that the so-called *twin relation* is an equivalence relation on  $V$ , and that every equivalence class is either a clique or a stable set. An equivalence class of the twin relation is referred to as a *twin class*.

**Definition 1.** The *twin number* of a graph  $G$ , denoted by  $\tau(G)$ , is the maximum cardinality of a twin class of  $G$ . Every twin set of cardinality  $\tau(G)$  will be referred to as a  $\tau$ -set.

As a direct consequence of these definitions, the following list of properties hold.

**Proposition 1.** Let  $G = (V, E)$  be a graph of order  $n$ . Let  $W$  be a twin set of  $G$ . Then

- (1) If  $w_1, w_2 \in W$ , then  $d(w_1, z) = d(w_2, z)$ , for every vertex  $z \in V \setminus \{w_1, w_2\}$ .
- (2) No two vertices of  $W$  can belong to the same part of any locating partition.
- (3)  $W$  induces either a complete graph or an empty graph.
- (4) Every vertex not in  $W$  is either adjacent to all the vertices of  $W$  or non-adjacent to any vertex of  $W$ .
- (5)  $W$  is a twin set of  $\overline{G}$ .
- (6)  $\tau(G) = \tau(\overline{G})$ .
- (7)  $\tau(G) \leq \beta_p(G)$ .
- (8)  $\tau(G) = \beta_p(G) = n$  if and only if  $G$  is the complete graph  $K_n$ .
- (9)  $\tau(G) = n - 1$  if and only if  $G$  is the star  $K_{1, n-1}$ .

It is a routine exercise to check all the results showed in Table 2 (see also [5] and the references given in [2]).

We conclude this section by characterizing the set of graphs  $G$  such that  $\tau(G) = n - 2$ .

$G$	$P_n$	$C_n$	$K_{1,n-1}$	$K_{k,k}$	$K_{k,n-k}$	$K_n$
order $n$	$n \geq 4$	$n \geq 5$	$n \geq 3$	$4 \leq n = 2k$	$2 \leq k < n - k$	$n \geq 2$
$\beta(G)$	1	2	$n - 2$	$n - 2$	$n - 2$	$n - 1$
$\tau(G)$	1	1	$n - 1$	$k$	$n - k$	$n$
$\beta_p(G)$	2	3	$n - 1$	$k + 1$	$n - k$	$n$

Table 2: Metric dimension  $\beta$ , twin number  $\tau$  and partition dimension  $\beta_p$  of paths, cycles, stars, bicliques and cliques.

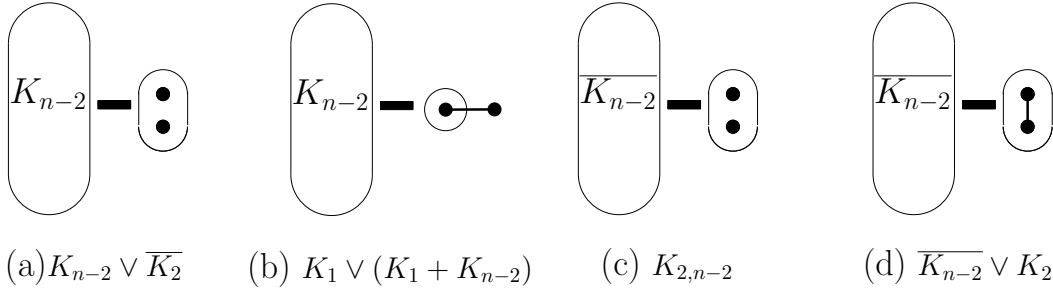

Figure 2: Graphs of order  $n \geq 4$  such that  $\tau(G) = n - 2$ .

**Proposition 2.** *Let  $G = (V, E)$  be a graph of order  $n \geq 4$ . Then,  $\tau(G) = n - 2$  if and only if  $G$  is one of the following graphs (see Figure 2):*

- (a) *the complete split graph  $K_{n-2} \vee \overline{K_2}$ , obtained by removing an edge from the complete graph  $K_n$ ;*
- (b) *the graph  $K_1 \vee (K_1 + K_{n-2})$ , obtained by attaching a leaf to the complete graph  $K_{n-1}$ ;*
- (c) *the complete bipartite graph  $K_{2,n-2}$ ;*
- (d) *the complete split graph  $\overline{K_{n-2}} \vee K_2$ .*

*Proof.* It is straightforward to check that the twin number of the four graphs displayed in Figure 2 is  $n - 2$ . Conversely, suppose that  $G$  is a graph such that  $\tau(G) = n - 2$ . Let  $x, y \in V$  such that  $W = V \setminus \{x, y\}$  is the  $\tau$ -set of  $G$ . Since  $G$  is connected, we may suppose without loss of generality that  $W \subseteq N(x)$ . We distinguish two cases.

**Case 1:**  $G[W] \cong K_{n-2}$ . If  $xy \notin E$ , then  $N(y) = W$ , and thus  $G \cong \overline{K_2} \vee K_{n-2}$ . If  $xy \in E$ , then  $N(y) = \{x\}$ , as otherwise  $G \cong K_n$ , a contradiction. Thus,  $G \cong K_1 \vee (K_{n-2} + K_1)$ .

**Case 2:**  $G[W] \cong \overline{K_{n-2}}$ . If  $xy \notin E$ , then  $N(y) = W$ , and thus  $G \cong K_{2,n-2}$ . If  $xy \in E$ , then  $N(y) = W$ , as otherwise  $G \cong K_{1,n-1}$ , a contradiction. Hence,  $G \cong \overline{K_{n-2}} \vee K_2$ .  $\square$

### 3 Twin number versus partition dimension

This section, consisting of 3 subsections, is devoted to obtain relations between the partition dimension  $\beta_p(G)$  and the twin number  $\tau(G)$  of a graph  $G$ . In the first subsection, a realization theorem involving both parameters is presented, without any further restriction than the inequality  $\tau(G) \leq \beta_p(G)$ . The second subsection is devoted to study the parameter  $\beta_p(G)$ , when  $G$  is a graph of order  $n$  with "few" twin vertices, to be more precise, such that  $\tau(G) \leq \frac{n}{2}$ . Finally, the last subsection examines  $\beta_p(G)$ , whenever  $G$  is a graph for which  $\tau(G) > \frac{n}{2}$ .

#### 3.1 Realization Theorem for trees

A complete  $k$ -ary tree of height  $h$  is a rooted tree whose internal vertices have  $k$  children and whose leaves are at distance  $h$  from the root. Let  $T(k, 2)$  denote the complete  $k$ -ary tree of height 2. Suppose that  $x$  is the root,  $x_1, \dots, x_k$  are the children of  $x$ , and  $x_{i1}, \dots, x_{ik}$  are the children of  $x_i$  for any  $i \in \{1, \dots, k\}$  (see Figure 3(a)).

**Proposition 3.** *For any integer  $k \geq 2$ ,  $\tau(T(k, 2)) = k$  and  $\beta_p(T(k, 2)) = k + 1$ .*

*Proof.* Certainly,  $\tau(T(k, 2)) = k$ , and thus  $\beta_p(T(k, 2)) \geq k$ . Suppose that  $\beta_p(T(k, 2)) = k$  and  $\Pi = \{S_1, \dots, S_k\}$  is a locating partition of size  $k$ . In such a case, for every  $i \in \{1, \dots, k\}$  the vertices  $x_{i1}, \dots, x_{ik}$  are twins, and thus each one belongs to a distinct part of  $\Pi$ . So, if  $x_r, x_s \in S_i$  for some pair  $r, s \in \{1, \dots, k\}$ , with  $r \neq s$ , then  $r(x_r|\Pi) = r(x_s|\Pi) = (1, \dots, 1, 0, 1, \dots, 1)$ , which is a contradiction. Hence, the vertices  $x_1, \dots, x_k$  must belong to distinct parts of  $\Pi$ . We may assume that  $x_i \in S_i$ , for every  $i \in \{1, \dots, k\}$ . Thus, if  $x$  belongs to the part  $S_i$ , then  $r(x|\Pi) = r(x_i|\Pi) = (1, \dots, 1, 0, 1, \dots, 1)$ , which is a contradiction. Hence,  $\beta_p(T(k, 2)) \geq k + 1$ . Finally, consider the partition  $\Pi = \{S_1, \dots, S_k, S_{k+1}\}$  such that  $S_{k+1} = \{x\}$  and, for any  $i \in \{1, \dots, k\}$ ,  $S_i = \{x_i, x_{1i}, x_{2i}, \dots, x_{ki}\}$ . Then, for every  $u \in V(T(k, 2))$  and for every  $i, j, h \in \{1, \dots, k\}$  such that  $j < i < h$ :

$$r(u|\Pi) = \begin{cases} (2, \dots, 2, \overset{j}{1}, 2, \dots, 2, \overset{i}{0}, 2, \dots, 2, \overset{h}{2}, 2, \dots, 2, 2) & \text{if } u = x_{ij} \\ (2, \dots, 2, 2, 2, \dots, 2, 0, 2, \dots, 2, 2, 2, \dots, 2, 2) & \text{if } u = x_{ii} \\ (2, \dots, 2, 2, 2, \dots, 2, 0, 2, \dots, 2, 1, 2, \dots, 2, 2) & \text{if } u = x_{ih} \\ (1, \dots, 1, 1, 1, \dots, 1, 0, 1, \dots, 1, 1, 1, \dots, 1, 1) & \text{if } u = x_i \end{cases}$$

Therefore,  $\Pi$  is a locating partition, implying that  $\beta_p(T(k, 2)) = k + 1$ . □

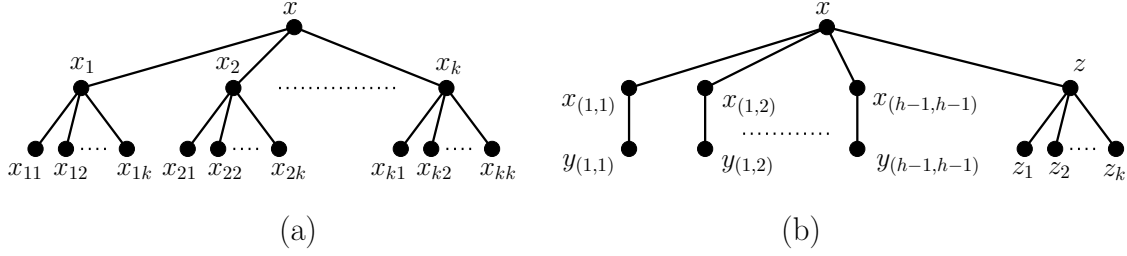
 Figure 3: The trees (a)  $T(k, 2)$  and (b)  $T^*(k, h)$ .

For any  $k \geq 1$  and  $h \geq 1$ , let  $T^*(k, h)$  denote the tree of order  $k + 2 + 2(h - 1)^2$  defined as follows (see Figure 3(b)):

$$V(T^*(k, h)) = \{x, z\} \cup \{z_1, \dots, z_k\} \cup \{x_{(i,j)} : 1 \leq i, j \leq h - 1\} \cup \{y_{(i,j)} : 1 \leq i, j \leq h - 1\},$$

$$E(T^*(k, h)) = \{xx_{(i,j)} : 1 \leq i, j \leq h - 1\} \cup \{x_{(i,j)}y_{(i,j)} : 1 \leq i, j \leq h - 1\} \cup \{xz, zz_1, \dots, zz_k\}.$$

**Proposition 4.** *Let  $k, h$  be integers such that  $k \geq 1$  and  $h \geq k + 2$ . Then,  $\tau(T^*(k, h)) = k$  and  $\beta_p(T^*(k, h)) = h$ .*

*Proof.* Certainly,  $\tau(T^*(k, h)) = k$ . Let  $\beta_p(T^*(k, h)) = t$ .

Next, we show that  $t \geq h$ . Let  $\Pi = \{S_1, \dots, S_t\}$  be a locating partition of  $T^*(k, h)$ . If there exist two distinct pairs  $(i, j)$  and  $(i', j')$  such that the vertices  $x_{(i,j)}, x_{(i',j')}$  are in the same part of  $\Pi$  and  $y_{(i,j)}, y_{(i',j')}$  are in the same part, then  $r(x_{(i,j)}|\Pi) = r(x_{(i',j')}|\Pi)$ , which is a contradiction. Notice that this tree contains  $(h - 1)^2$  pairs of vertices of the type  $(x_{(i,j)}, y_{(i,j)})$  and if  $t \leq h - 2$ , we achieve at most  $(h - 2)^2$  such pairs avoiding the preceding condition. Thus,  $t \geq h - 1$ . Moreover, if  $t = h - 1$ , then for every pair  $(m, n) \in \{1, \dots, h - 1\}^2$ , there exists a pair  $(i, j) \in \{1, \dots, h - 1\}^2$  such that  $x_{(i,j)} \in S_m$  and  $y_{(i,j)} \in S_n$ . So, by symmetry, we may assume without loss of generality that  $x \in S_1$ . Consider the vertices  $x_{(i,j)}, y_{(i,j)}, x_{(i',j')}, y_{(i',j')}$  such that  $x_{(i,j)} \in S_2, y_{(i,j)} \in S_1$  and  $x_{(i',j')} \in S_2, y_{(i',j')} \in S_2$ . Then  $r(x_{(i,j)}|\Pi) = r(x_{(i',j')}|\Pi) = (1, 0, 2, \dots, 2)$ , which is a contradiction. Hence,  $t \geq h$ .

To prove the equality  $t = h$ , consider the partition  $\Pi = \{S_1, \dots, S_h\}$  such that:

$$\begin{aligned} S_i &= \{x_{(i,m)} : 1 \leq m \leq h - 1\} \cup \{y_{(n,i)} : 1 \leq n \leq h - 1\} \cup \{z_i\}, & \text{if } 1 \leq i \leq k \\ S_i &= \{x_{(i,m)} : 1 \leq m \leq h - 1\} \cup \{y_{(n,i)} : 1 \leq n \leq h - 1\}, & \text{if } k < i \leq h - 1 \\ S_h &= \{x, z\}. \end{aligned}$$

Let  $i \in \{1, \dots, h - 1\}$ . Then, for every  $m, n \in \{1, \dots, h - 1\}$ ,  $m, n \neq i$ :

$$r(u|\Pi) = \begin{cases} (2, \dots, 2, \overset{i}{0}, 2, \dots, 2, \overset{m}{1}, 2, \dots, 2, 1) & \text{if } u = x_{(i,m)} \\ (2, \dots, 2, 0, 2, \dots, 2, 2, 2, \dots, 2, 1) & \text{if } u = x_{(i,i)} \end{cases}$$

$$r(u|\Pi) = \begin{cases} (3, \dots, 3, 0, 3, \dots, 3, 1, 3, \dots, 3, 2) & \text{if } u = y_{(n,i)} \\ (3, \dots, 3, 0, 3, \dots, 3, 3, 3, \dots, 3, 2) & \text{if } u = y_{(i,i)} \end{cases}$$

Therefore,  $r(u, |\Pi) \neq r(v|\Pi)$  if  $u, v \in \{x_{(i,m)} : 1 \leq m \leq h-1\} \cup \{y_{(n,i)} : 1 \leq n \leq h-1\}$  and  $u \neq v$ . Moreover, it is straightforward to check that, if  $i \in \{1, \dots, k\}$ , then for every  $u \in S_i$ ,  $u \neq z_i$ , we have

$$r(z_i|\Pi) = (2, \dots, 2, 0, 2, \dots, 2, 3, \dots, 3, 1) \neq r(u|\Pi).$$

Finally, for  $x, z \in S_h$ , we have

$$r(x|\Pi) = (1, \dots, 1, 1, \dots, 1, 0) \neq (1, \dots, 1, 2, \dots, 2, 0) = r(z|\Pi).$$

Therefore,  $\Pi$  is a locating partition, implying that  $\beta_p(T^*(k, h)) = h$ .  $\square$

**Theorem 3.** *Let  $a, b$  be integers such that  $1 \leq a \leq b$ . Then, there exists a tree  $T$  such that  $\tau(T) = a$  and  $\beta_p(T) = b$ .*

*Proof.* For  $a = b = 1$ , the trivial graph  $P_1$  satisfies  $\tau(P_1) = \beta_p(P_1) = 1$ . For  $a = b \geq 2$ , consider the star  $K_{1,a}$ . For  $a = 1$  and  $b = 2$ , take the path  $P_4$ . If  $2 \leq a$  and  $b = a + 1$ , consider the tree  $T(a, 2)$  studied in Proposition 3. Finally, if  $a \geq 1$  and  $b \geq a + 2$ , take the tree  $T^*(a, b)$  analyzed in Proposition 4.  $\square$

### 3.2 Twin number at most half the order

In this subsection, we approach the case when  $G$  is a graph of order  $n$  such that  $\tau(G) = \tau \leq \frac{n}{2}$ . Concretely, we prove that, in such a case,  $\beta_p(G) \leq n - 3$ .

**Lemma 1.** *Let  $D$  be a subset of vertices of size  $k \geq 3$  of a graph  $G$  such that  $G[D]$  is neither complete nor empty. Then, there exist at least three different vertices  $u, v, w \in D$  such that  $uv \in E(G)$  and  $uw \notin E(G)$*

*Proof.* If  $G[D]$  is neither complete nor empty, then there is at least one vertex  $u$  such that  $1 \leq \deg_{G[D]}(u) \leq k - 2$ . Let  $v$  (resp.  $w$ ) be a vertex adjacent (resp. non-adjacent) to  $u$ . Then,  $u, v, w$  satisfy the desired condition.  $\square$

**Lemma 2.** *If  $G$  is a nontrivial graph of order  $n$  with a vertex  $u$  of degree  $k$ , then  $\beta_p(G) \leq n - \min\{k, n - 1 - k\}$ .*

*Proof.* Let  $N(v) = \{x_1, \dots, x_k\}$  and  $V(G) \setminus N(v) = \{y_1, \dots, y_{n-1-k}\}$  and  $m = \min\{k, n - 1 - k\}$ . Take the partition  $\Pi = \{S_1, \dots, S_m\} \cup \{\{z\} : z \notin S_1 \cup \dots \cup S_m\}$ , where  $S_i = \{x_i, y_i\}$  for  $i = 1, \dots, m$ . Observe that  $\{v\}$  resolves the vertices of  $S_i = \{x_i, y_i\}$  for  $i = 1, \dots, m$ . Therefore,  $\Pi$  is a locating partition of  $G$ , implying that  $\beta_p(G) \leq |\Pi| = n - m = n - \min\{k, n - 1 - k\}$ .  $\square$



**Corollary 1.** *If  $G$  is a graph of order  $n \geq 7$  with at least one vertex  $u$  satisfying  $3 \leq \deg(u) \leq n - 4$ , then  $\beta_p(G) \leq n - 3$ .*

As a direct consequence of Theorem 1, we know that if  $G$  is a graph such that  $\text{diam}(G) \geq 4$ , then  $\beta_p(G) \leq n - 3$ . Next, we study the cases  $\text{diam}(G) = 3$  and  $\text{diam}(G) = 2$ .

**Proposition 5.** *Let  $G$  be a graph of order  $n \geq 9$ . If  $\tau(G) \leq \frac{n}{2}$  and  $\text{diam}(G) = 3$ , then  $\beta_p(G) \leq n - 3$ .*

*Proof.* By Corollary 1, and having also in mind that  $G$  has no universal vertex, since its diameter is 3, we may suppose that, for every vertex  $w$ ,  $\deg(w) \in \{1, 2, n - 3, n - 2\}$ . Let  $u$  be a vertex of eccentricity 3. Consider the nonempty subsets  $D_i = \{v : d(u, v) = i\}$  for  $i = 1, 2, 3$ . If at most one of these three subsets has exactly one vertex, then there exist five distinct vertices  $x_1, x_2, x_3, y_1, y_2$  such that, for  $i = 1, 2, 3$ ,  $x_i \in D_i$  and vertices  $y_1$  and  $y_2$  do not belong to the same set  $D_i$ . Consider the partition  $\Pi = \{S_1, S_2\} \cup \{\{z\} : z \notin S_1 \cup S_2\}$ , where  $S_1 = \{x_1, x_2, x_3\}$  and  $S_2 = \{y_1, y_2\}$ . Then,  $\{u\}$  resolves every pair of vertices in  $S_1$  and the vertices in  $S_2$ . Therefore,  $\Pi$  is a locating partition, implying that  $\beta_p(G) \leq n - 3$ .

Next, suppose that  $|D_{i_0}| = n - 3$  for exactly one value  $i_0 \in \{1, 2, 3\}$  and  $|D_i| = 1$  for  $i \neq i_0$ . We distinguish two cases.

- (1)  $G[D_{i_0}]$  is neither complete nor empty. Then by Lemma 1, there exist vertices  $r, s, t \in D_{i_0}$  such that  $rs \in E(G)$  and  $rt \notin E(G)$ . Consider the sets  $S_1 = \{s, t\}$  and  $S_2 = \{x_1, x_2, x_3\}$ , where  $x_i \in D_i$  for  $i = 1, 2, 3$ , with the additional condition  $S_2 \cap \{r, s, t\} = \emptyset$ , which is possible since  $|D_{i_0}| \geq 4$ . Take the partition  $\Pi = \{S_1, S_2\} \cup \{\{z\} : z \notin S_1 \cup S_2\}$ . Observe that  $\{r\}$  resolves the vertices in  $S_1$  and  $\{u\}$  resolves every pair of vertices in  $S_2$ . Therefore,  $\Pi$  is a locating partition, implying that  $\beta_p(G) \leq n - 3$ .
- (2)  $G[D_{i_0}]$  is either complete or empty. We distinguish three cases, depending on for which  $i_0 \in \{1, 2, 3\}$ ,  $|D_{i_0}| = n - 3$ .
  - (a)  $|D_3| = n - 3$ . Then,  $D_3$  is a twin set with  $n - 3$  vertices, a contradiction as  $n \geq 9$ .
  - (b)  $|D_1| = n - 3$ . Let  $v$  be the (unique) vertex of  $D_2$ . Then  $D_1 \cap N(v)$  and  $D_1 \cap \overline{N(v)}$  are twin sets. If  $\deg(v) = 2$ , then  $|D_1 \cap \overline{N(v)}| = n - 4$ , a contradiction. If  $n - 3 \leq \deg(v) \leq n - 2$ , then  $|D_1 \cap N(v)| \geq n - 4$ , again a contradiction.
  - (c)  $|D_2| = n - 3$ . Let  $v$  be the (unique) vertex of  $D_3$ . Then, both  $N(v)$  and  $D_2 \setminus N(v)$  are twin sets. Notice that  $\deg(v) \in \{1, 2, n - 3\}$ . We distinguish cases.
    - (c.i) If  $\deg(v) = 1$  (resp.  $\deg(v) = n - 3$ ), then  $|D_2 \setminus N(v)| = n - 4$  (resp.  $|N(v)| = n - 3$ ), a contradiction.
    - (c.ii) If  $\deg(v) = 2$ , then  $|D_2 \setminus N(v)| = n - 5$ . Let  $N(v) = \{a_1, a_2\}$ ,  $D_2 \setminus N(v) = \{b_1, \dots, b_{n-5}\}$ ,  $D_1 = \{x\}$ . Take the partition  $\Pi = \{S_1, S_2, S_3\} \cup \{\{z\} : z \notin S_1 \cup S_2 \cup S_3\}$ , where  $S_1 = \{a_1, b_1\}$ ,  $S_2 = \{a_2, b_2\}$  and  $S_3 = \{x, b_3\}$ .

Observe that  $\{v\}$  resolves the vertices in  $S_1$  and  $S_2$  and  $\{u\}$  resolves the vertices in  $S_3$ . Therefore,  $\Pi$  is a locating partition, implying that  $\beta_p(G) \leq n - 3$ .  $\square$

**Proposition 6.** *Let  $G$  be a graph of order  $n \geq 9$ . If  $\tau(G) \leq \frac{n}{2}$  and  $\text{diam}(G) = 2$ , then  $\beta_p(G) \leq n - 3$ .*

*Proof.* By Corollary 1, we may suppose that, for every vertex  $w \in V(G)$ ,  $\deg(w) \in \{1, 2, n - 3, n - 2, n - 1\}$ . We distinguish three cases.

- (i) *There exists a vertex  $u$  of degree 2.* Consider the subsets  $D_1 = N(u) = \{x_1, x_2\}$  and  $D_2 = \{v : d(u, v) = 2\}$ . We distinguish two cases.
- (1)  $G[D_2]$  is neither complete nor empty. Then, Lemma 1, there exist three different vertices  $r, s, t \in D_2$  such that  $rs \in E(G)$  and  $rt \notin E(G)$ . Consider two different vertices  $y_1, y_2 \in D_2 \setminus \{r, s, t\}$  and let  $S_1 = \{x_1, y_1\}$ ,  $S_2 = \{x_2, y_2\}$ ,  $S_3 = \{s, t\}$ . Then,  $\{u\}$  resolves the vertices in  $S_1$  and in  $S_2$ , and  $\{r\}$  resolves the vertices in  $S_3$ . Hence,  $\Pi = \{S_1, S_2, S_3\} \cup \{\{z\} : z \notin S_1 \cup S_2 \cup S_3\}$  is a locating partition of  $G$ .
- (2)  $G[D_2]$  is either complete or empty. Then the subsets of  $D_2$ ,  $A = N(x_1) \cap N(x_2) \cap D_2$ ,  $B = N(x_1) \cap N(x_2) \cap D_2$  and  $C = \overline{N(x_1)} \cap N(x_2) \cap D_2$  are twin sets. We distinguish cases.
- (a) If either  $\deg(x_1) \leq 2$  or  $\deg(x_2) \leq 2$ , then either  $|C| \geq n - 4$  or  $|A| \geq n - 4$ , in both cases a contradiction as  $n \geq 9$ .
- (b) If both  $x_1$  and  $x_2$  have degree at least  $n - 3$ , then  $0 \leq |A| \leq 2$ ,  $0 \leq |C| \leq 2$  and  $n - 7 \leq |B| \leq n - 3$ . We distinguish cases, depending on the size of  $B$ .
- (b.1)  $|B| \geq n - 4$ . Then,  $\tau(G) \geq n - 4$ , a contradiction as  $n \geq 9$ .
- (b.2)  $|B| = n - 5 \geq 4$ . If  $D_2 \cong \overline{K_{n-3}}$ , then  $\tau(G) = n - 4$ , as  $B \cup \{u\}$  is a (maximum) twin set of  $G$ . Suppose that  $D_2 \cong K_{n-3}$ . Let  $A \cup C = \{y_1, y_2\}$ ,  $\{b_1, b_2, b_3, b_4\} \subseteq B$ . Consider the partition  $\Pi = \{S_1, S_2, S_3\} \cup \{\{z\} : z \notin S_1 \cup S_2 \cup S_3\}$ , where  $S_1 = \{b_1, y_1\}$ ,  $S_2 = \{b_2, y_2\}$  and  $S_3 = \{b_3, u\}$ . Observe that either  $\{x_1\}$  or  $\{x_2\}$  resolves the vertices of  $S_1$  and  $S_2$ . Notice also that  $\{b_4\}$  resolves the vertices in  $S_3$ . Hence,  $\Pi$  is a locating partition of  $G$ .
- (b.3)  $2 \leq n - 7 \leq |B| \leq n - 6$ . We may assume without loss of generality that  $|A| = 2$  and  $1 \leq |C| \leq 2$ . Let  $A = \{a_1, a_2\}$ ,  $\{b_1, b_2\} \subseteq B$ ,  $\{c_1\} \subseteq C$ . Consider the partition  $\Pi = \{S_1, S_2, S_3\} \cup \{\{z\} : z \notin S_1 \cup S_2 \cup S_3\}$ , where  $S_1 = \{a_1, b_1\}$ ,  $S_2 = \{a_2, b_2\}$  and  $S_3 = \{x, c_1\}$ . Observe that  $\{x_2\}$  resolves the vertices of  $S_1$  and  $S_2$ . Notice also that  $\{u\}$  resolves the vertices in  $S_3$ . Hence,  $\Pi$  is a locating partition of  $G$ .

- (ii) *There exists at least one vertex  $u$  of degree 1 and there is no vertex of degree 2.* In this case, the neighbor  $u$  of  $v$  is a universal vertex  $v$ . Let  $\Omega$  be the set of vertices different from  $v$  that are not leaves. Notice that there are at most two vertices of degree 1 in  $G$ , as otherwise all vertices in  $\Omega$  would have degree between 3 and  $n-4$ , contradicting the assumption made at the beginning of the proof.

If there are exactly two vertices of degree 1, then  $|\Omega| = n-3$ . In such a case,  $\Omega$  induces a complete graph in  $G$ , as otherwise the non-universal vertices in  $G[\Omega]$  would have degree at most  $n-4$ . So,  $\Omega$  is a twin set, implying that  $\tau(G) = n-3 > \frac{n}{2}$ , a contradiction.

Suppose thus that  $u$  is the only vertex of degree 1, which means that  $\Omega$  contains  $n-2$  vertices, all of them of degree  $n-3$  or  $n-2$ . Consider the graph  $H = \overline{G}[\Omega]$ . Certainly,  $H$  has  $n-2$  vertices, all of them of degree 0 or 1. Let  $H_i$  denote the set of vertices of degree  $i$  of  $H$ , for  $i = 0, 1$ . Observe that  $|H_0| \leq \frac{n}{2}$ , since  $H_0$  is a twin set in  $G$ . Hence,  $|H_1| \geq 4$ , as  $n \geq 9$  and the size of  $H_1$  must be even. We distinguish two cases, depending on the size of  $H_1$ .

- (a)  $|H_1| = 4$ . Notice that  $|H_0| \geq 3$ . Let  $\{y_1, y_2, y_3\} \subseteq H_0$  and  $H_1 = \{x_1, x_2, x_3, x_4\}$  such that  $\{x_1x_2, x_3x_4\} \subseteq E(H_1)$ . Consider the partition  $\Pi = \{S_1, S_2, S_3\} \cup \{\{z\} : z \notin S_1 \cup S_2 \cup S_3\}$ , where  $S_1 = \{x_1, y_1\}$ ,  $S_2 = \{x_2, y_2\}$  and  $S_3 = \{u, v\}$ . Observe that  $d_G(x_2, x_1) = 2 \neq 1 = d_G(x_2, y_1)$ ,  $d_G(x_4, x_3) = 2 \neq 1 = d_G(x_4, y_3)$ ,  $d_G(y_2, u) = 2 \neq 1 = d_G(y_2, v)$ . Hence,  $\{x_2\}$  resolves the vertices in  $S_1$ ,  $\{x_4\}$  resolves the vertices in  $S_2$  and  $\{y_2\}$  resolves the vertices in  $S_3$ . Therefore,  $\Pi$  is a locating partition of  $G$ , implying that  $\beta_p(G) \leq n-3$ .
- (b)  $|H_1| \geq 6$ . Let  $\{x_1, x_2, x_3, x_4, x_5, x_6\} \subseteq H_1$  such that  $\{x_1x_2, x_3x_4, x_5x_6\} \subseteq E(H_1)$ . Consider the partition  $\Pi = \{S_1, S_2, S_3\} \cup \{\{z\} : z \notin S_1 \cup S_2 \cup S_3\}$ , where  $S_1 = \{u, v\}$ ,  $S_2 = \{x_2, x_4\}$  and  $S_3 = \{x_3, x_5\}$ . Observe that  $d_G(u, x_1) = 2 \neq 1 = d_G(v, x_1)$ ,  $d_G(x_4, x_1) = 2 \neq 1 = d_G(x_2, x_1)$ ,  $d_G(x_3, x_6) = 2 \neq 1 = d_G(x_5, x_6)$ . Hence,  $\{x_1\}$  resolves the vertices in  $S_1$  and in  $S_2$ , and  $\{x_6\}$  resolves the vertices in  $S_3$ . Therefore,  $\Pi$  is a locating partition of  $G$ , implying that  $\beta_p(G) \leq n-3$ .
- (iii) *There are no vertices of degree at most 2.* In this case, all the vertices of  $G$  have degree  $n-3$ ,  $n-2$  or  $n-1$ , that is to say, all the vertices of  $\overline{G}$  have degree 0, 1 or 2. Since  $G$  has at most  $\frac{n}{2}$  pairwise twin vertices, there are at most  $\frac{n}{2}$  vertices of degree 0 in  $\overline{G}$ . Let  $H_i$  denote the set of vertices of degree  $i$  of  $\overline{G}$ , for  $i = 0, 1, 2$ . Let  $\Gamma = H_1 \cup H_2$  and  $H = \overline{G}[\Gamma]$ . We distinguish cases, depending on the size of  $\Gamma$ , showing in each of them a collection of three 2-subsets  $S_1, S_2, S_3$  such that the corresponding partition  $\Pi = \{S_1, S_2, S_3\} \cup \{\{z\} : z \notin S_1 \cup S_2 \cup S_3\}$  is a locating partition for  $G$ , implying thus that  $\beta_p(G) \leq n-3$ .
- (a)  $|\Gamma| \in \{5, 6\}$ . Then,  $|H_0| \geq 3$ . Let  $\{y_1, y_2, y_3\} \subseteq H_0$ . It is easy to check that in both cases  $H$  contains at least three edges either of the form (i)  $x_1x_2, x_3x_4, x_4x_5$  or of the form (ii)  $x_1x_2, x_3x_4, x_5x_6$ . Take  $S_1 = \{x_1, y_1\}$ ,  $S_2 = \{x_3, y_2\}$ ,

$S_3 = \{x_5, y_3\}$ . Notice that, in case (i),  $\{x_2\}$  resolves the vertices in  $S_1$  and  $\{x_4\}$  resolves the vertices in  $S_2$  and in  $S_3$ , and in case (ii),  $\{x_2\}$  resolves the vertices in  $S_1$ ,  $\{x_4\}$  resolves the vertices in  $S_2$  and  $\{x_6\}$  resolves the vertices in  $S_3$ .

- (b)  $|\Gamma| = 7$ . Then,  $|H_0| \geq 2$ . Let  $\Gamma = \{x_1, x_2, x_3, x_4, x_5, x_6, x_7\}$  such that  $\{x_1x_2, x_2x_3, x_4x_5, x_6x_7\} \subseteq E(\overline{G})$ ,  $x_4x_6 \notin E(\overline{G})$  and  $\{y_1, y_2\} \subseteq H_0$ . Take  $S_1 = \{x_1, y_1\}$ ,  $S_2 = \{x_3, y_2\}$  and  $S_3 = \{x_5, x_6\}$ . Observe that  $\{x_2\}$  resolves the vertices in  $S_1$  and in  $S_2$ , and  $\{x_4\}$  resolves the vertices in  $S_3$ .
- (c)  $|\Gamma| \geq 8$ . Then, all the connected components of  $H$  are isomorphic either to a path or to a cycle. We distinguish cases, depending on the number of components of  $\overline{G}[\Gamma]$ .
- (c.1) If  $H$  is connected, then  $H$  contains a path  $x_1x_2 \dots x_8$  of length 7. Take  $S_1 = \{x_1, x_2\}$ ,  $S_2 = \{x_4, x_5\}$  and  $S_3 = \{x_7, x_8\}$ . Then,  $\{x_3\}$  resolves the vertices in  $S_1$  and in  $S_2$ , and  $\{x_6\}$  resolves the vertices in  $S_3$ .
- (c.2) If  $H$  has 2 connected components, say  $C_1$  and  $C_2$ , let assume that  $|V(C_1)| \geq |V(C_2)| \geq 2$ . We distinguish two cases.
- (c.2.1) If one of the connected components has at most 3 vertices, then  $|V(C_1)| \geq 5$  and  $2 \leq |V(C_2)| \leq 3$ . If  $x_1x_2x_3x_4x_5$  and  $y_1y_2$  are paths contained in  $C_1$  and  $C_2$ , respectively, then consider  $S_1 = \{x_1, y_1\}$ ,  $S_2 = \{x_3, y_2\}$  and  $S_3 = \{x_5, t\}$ , where  $t$  is any vertex different from  $x_1, x_2, x_3, x_4, x_5, y_1, y_2$ . Then, it is easy to check that  $\{x_2\}$  resolves the vertices in  $S_1$  and in  $S_2$ , and  $\{x_4\}$  resolves the vertices in  $S_3$ .
- (c.2.2) If both connected components have at least 4 vertices, let  $x_1x_2x_3x_4$  and  $y_1y_2y_3y_4$  be paths contained in  $C_1$  and  $C_2$ , respectively. Take  $S_1 = \{x_1, y_1\}$ ,  $S_2 = \{x_3, y_2\}$  and  $S_3 = \{x_4, y_4\}$ . Then, it is easy to check that  $\{x_2\}$  resolves the vertices in  $S_1$  and in  $S_2$ , and  $\{y_3\}$  resolves the vertices in  $S_3$ .
- (c.3) If  $H$  has 3 connected components, say  $C_1$ ,  $C_2$  and  $C_3$ , then we may assume that  $|V(C_1)| \geq 3$  and  $|V(C_1)| \geq |V(C_2)| \geq |V(C_3)| \geq 2$ . Let  $x_1x_2x_3$ ,  $y_1y_2$  and  $z_1z_2$  be paths contained in  $C_1$ ,  $C_2$  and  $C_3$  respectively. Take  $S_1 = \{x_1, y_1\}$ ,  $S_2 = \{x_3, y_2\}$  and  $S_3 = \{z_2, t\}$ , where  $t$  is a vertex in  $C_1 \cup C_2$  different from  $x_1, x_2, x_3, y_1, y_2$  that exists because  $|\Gamma| \geq 8$ . Then, it is easy to check that  $\{x_2\}$  resolves the vertices in  $S_1$  and in  $S_2$ , and  $\{z_1\}$  resolves the vertices in  $S_3$ .
- (c.4) If  $H$  has at least 4 connected components, say  $C_1$ ,  $C_2$ ,  $C_3$  and  $C_4$ , then we may assume that  $|V(C_1)| \geq |V(C_2)| \geq |V(C_3)| \geq |V(C_4)| \geq 2$ . Let  $x_1x_2$ ,  $y_1y_2$ ,  $z_1z_2$  and  $t_1t_2$  be edges of  $C_1$ ,  $C_2$ ,  $C_3$  and  $C_4$  respectively. Take  $S_1 = \{x_1, y_1\}$ ,  $S_2 = \{y_2, z_2\}$  and  $S_3 = \{t_1, w\}$ , where  $w$  is a vertex in  $C_1 \cup (V \setminus \Gamma)$  different from  $x_1, x_2$ , that exists since  $G$  has order at least 9. Then, it is easy to check that  $\{x_2\}$  resolves the vertices in  $S_1$ ,  $\{z_1\}$  resolves the vertices in  $S_2$ , and  $\{t_2\}$  resolves the vertices in  $S_3$ .  $\square$

As a consequence of Theorem 1, Proposition 5 and Proposition 6, the following result is obtained.

**Theorem 4.** *Let  $G$  be a graph of order  $n \geq 9$ . If  $\tau(G) \leq \frac{n}{2}$ , then  $\beta_p(G) \leq n - 3$ .*

### 3.3 Twin number greater than half the order

In this subsection, we focus our attention on the case when  $G$  is a nontrivial graph of order  $n$  such that  $\tau(G) = \tau > \frac{n}{2}$ . Notice that, in these graphs there is a unique  $\tau$ -set  $W$ .

Among others, we prove that, in such a case,  $\tau(G) \leq \beta_p(G) \leq \frac{n + \tau(G)}{2}$ .

**Proposition 7.** *Let  $G$  be a graph of order  $n$ , other than  $K_n$ . If  $W$  is a  $\tau$ -set such that  $G[W] \cong K_\tau$ , then  $\beta_p(G) \geq \tau(G) + 1$ .*

*Proof.* Assume that  $\Pi = \{S_1, S_2, \dots, S_\tau\}$  is a locating partition of  $G$ . If  $W = \{w_1, w_2, \dots, w_\tau\}$ , then we can assume without loss of generality that, for every  $i \in \{1, \dots, \tau\}$ ,  $w_i \in S_i$ . Let  $v$  be a vertex of  $N(W) \setminus W$ . Take  $j \in \{1, \dots, \tau\}$  such that  $\{w_j, v\} \subseteq S_j$ . Certainly,  $r(v|\Pi) = (1, \dots, 1, 0, 1, \dots, 1) = r(w_j|\Pi)$ , a contradiction.  $\square$

**Theorem 5.** *Let  $G = (V, E)$  be a graph of order  $n$  such that  $\frac{n}{2} < \tau(G) = \tau = n - k$  and let  $W$  be its  $\tau$ -set. If  $G[W] \cong K_\tau$ , then  $\beta_p(G) \leq n - k/2$ .*

*Proof.* Let  $W = \{w_1, \dots, w_\tau\}$ ,  $W_1 = N(W) \setminus W = \{x \in V(G) : d(x, W) = 1\}$  and  $W_2 = V \setminus N[W] = \{x \in V(G) : d(x, W) \geq 2\}$ , and denote  $r = |W_1|$ ,  $t = |W_2|$ . Observe that  $\{W, W_1, W_2\}$  is a partition of  $V(G)$  and  $k = r + t$ . Since  $W$  is a set of twin vertices, we have that  $xy \in E(G)$  for all  $x \in W$  and  $y \in W_1$ .

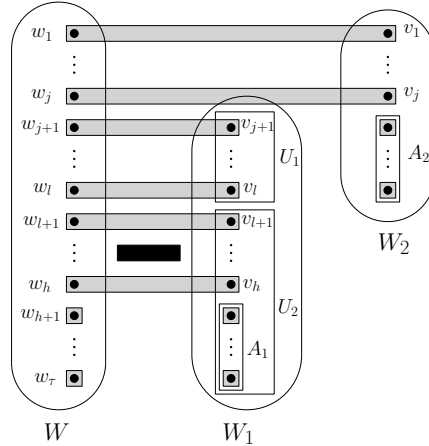

Figure 4: In this figure,  $W_1 = N(W) \setminus W$  and  $W_2 = V \setminus N[W]$ .

Consider the subsets  $U_1 = \{x \in W_1 : \deg_{G[W_1]}(x) = r - 1\}$  and  $U_2 = W_1 \setminus U_1$  of  $W_1$ . If  $x \in U_1$ , then there exists at least one vertex  $y \in W_2$  such that  $xy \in E(G)$ , otherwise  $x$  should be in  $W$ . Let us assign to each vertex  $x \in U_1$  one vertex  $y(x) \in W_2$  such that  $xy(x) \in E(G)$  and consider the set  $A_2 = \{y(x) : x \in U_1\} \subseteq W_2$ . Observe that for different vertices  $x, x' \in U_1$ , the vertices  $y(x), y(x')$  are not necessarily different. By construction,  $|A_2| \leq |U_1|$ .

Next, consider the subgraph  $G[U_2]$  induced by the vertices of  $U_2$ . If  $s = |U_2|$ , then by definition, this subgraph has maximum degree at most  $s - 2$ , and hence, the complement  $\overline{G[U_2]}$  has minimum degree at least 1. It is well known that every graph without isolated vertices contains a dominating set of cardinality at most half the order (see [13]). Let  $A_1$  be a dominating set of  $\overline{G[U_2]}$  with  $|A_1| \leq s/2$ .

If  $(W_1 \cup W_2) \setminus (A_1 \cup A_2) = \{v_1, \dots, v_h\}$ , we show that the partition  $\Pi$  defined as follows is a locating partition of  $G$  (see Figure 4):

$$\Pi = \{\{x\} : x \in A_1\} \cup \{\{y\} : y \in A_2\} \cup \{\{w_i, v_i\} : 1 \leq i \leq h\} \cup \{\{w_i\} : h + 1 \leq i \leq \tau\}.$$

Observe that  $\Pi$  is well defined since  $h < k < \frac{n}{2} \leq \tau$ . To prove this claim, it is sufficient to show that for every  $i \in \{1, \dots, h\}$  there exists a part of  $\Pi$  at different distance from  $w_i$  and  $v_i$ . We distinguish the following cases:

i) If  $v_i \in U_1$ , consider the vertex  $y(v_i) \in A_2$  such that  $v_i y(v_i) \in E(G)$ .

Then,  $d(w_i, \{y(v_i)\}) = 2 \neq 1 = d(v_i, \{y(v_i)\})$ .

ii) If  $v_i \in U_2 \setminus A_1$ , consider a vertex  $x \in A_1$  dominating  $v_i$  in  $\overline{G[U_2]}$ , i.e.,  $x v_i \notin E(G)$ .

Then,  $d(w_i, \{x\}) = 1 < d(v_i, \{x\})$ .

iii) If  $v_i \in W_2 \setminus A_2$ , then  $d(w_i, \{w_\tau\}) = 1 < 2 \leq d(v_i, \{w_\tau\})$ .

Observe that  $|A_2| \leq |U_1| = r - s$  and  $|A_2| \leq |W_2| = t$ , so we can deduce that  $|A_2| \leq (r - s + t)/2$ . Therefore, the partition dimension of  $G$  satisfies:

$$\beta_p(G) \leq |\Pi| = n - |(W_1 \cup W_2) \setminus (A_1 \cup A_2)| = n - [(r + t) - (|A_1| + |A_2|)] = n - k/2 \quad \square$$

**Proposition 8.** *Let  $G = (V, E)$  be a graph of order  $n$  such that  $\tau(G) = \tau > \frac{n}{2}$ . If its  $\tau$ -set  $W$  satisfies  $G[W] \cong \overline{K_\tau}$ , then  $\beta_p(G) = \tau$ .*

*Proof.* Let  $W = \{w_1, \dots, w_\tau\}$ ,  $V \setminus W = \{v_1, \dots, v_s\}$  and  $N(W) = \{v_1, \dots, v_r\}$ , where  $1 \leq r \leq s < \tau$ . By Proposition 1(7),  $\beta_p(G) \geq \tau$ . To prove the equality, consider the partition  $\Pi = \{S_1, \dots, S_\tau\}$ , where  $S_i = \{w_i, v_i\}$  if  $1 \leq i \leq s$ , and  $S_i = \{w_i\}$  if  $s < i \leq \tau$ . Observe that for any  $i, j \in \{1, \dots, \tau\}$  with  $i \neq j$ ,  $h \in \{1, \dots, r\}$  and  $k \in \{r + 1, \dots, s\}$ ,  $d(w_i, w_j) = 2$ ,  $d(v_h, w_j) = 1$  and  $d(v_k, w_j) = 2$ . To prove that  $\Pi$  is a locating partition of  $G$ , we distinguish cases.

**Case 1:**  $1 \leq i \leq r$ . Then,  $d(w_i, S_\tau) = d(w_i, w_\tau) = 2 \neq 1 = d(v_i, w_\tau) = d(v_i, S_\tau)$ .

**Case 2:**  $r < i \leq s$ . We distinguish two cases.

**Case 2.1:** For some  $k \in \{1, \dots, r\}$ ,  $v_i v_k \notin E(G)$ . Consider the part  $S_k = \{w_k, v_k\}$ . On the one hand,  $d(w_i, S_k) = 1$  since  $d(w_i, v_k) = 1$ . On the other hand,  $d(v_i, S_k) \geq 2$  since  $d(v_i, w_k) \geq 2$  and  $d(v_i, v_k) \geq 2$ . Therefore,  $d(w_i, S_k) \neq d(v_i, S_k)$  (see Figure 5(a)).

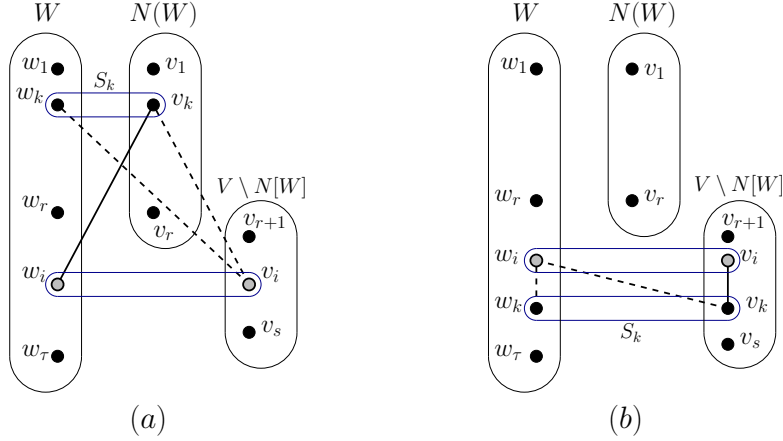

Figure 5: In both cases, the part  $S_k$  resolves the pair  $w_i, v_i$ . Solid lines hold for adjacent vertices and dashed lines, for non-adjacent vertices.

**Case 2.2:** Vertex  $v_i$  is adjacent to all vertices in  $\{v_1, \dots, v_r\}$ . As  $v_i \notin W$ ,  $v_i v_k \in E(G)$  for some  $k \in \{r+1, \dots, s\}$ . Consider the part  $S_k = \{w_k, v_k\}$ . On the one hand,  $d(w_i, S_k) = 2$  since  $d(w_i, w_k) = 2$  and  $d(w_i, v_k) \geq 2$ . On the other hand,  $d(v_i, S_k) = 1$  since  $d(v_i, v_k) = 1$ . Therefore,  $d(w_i, S_k) \neq d(v_i, S_k)$  (see Figure 5(b)).  $\square$

As a direct consequence of Proposition 7, Theorem 5 and Proposition 8, the following result is derived.

**Theorem 6.** *Let  $G$  be a graph of order  $n$ , other than  $K_n$ , such that  $\tau(G) = \tau > \frac{n}{2}$ . Then,  $\tau \leq \beta_p(G) \leq \frac{n+\tau}{2}$ . Moreover, if  $W$  is its  $\tau$ -set, then*

1.  $\beta_p(G) = \tau$  if and only if  $G[W] \cong \overline{K_\tau}$ .
2.  $\tau < \beta_p(G) \leq \frac{n+\tau}{2}$  if and only if  $G[W] \cong K_\tau$ .

**Corollary 2.** *Let  $G$  be a nontrivial graph of order  $n$ , other than  $K_n$ , such that  $\beta_p(G) = n - h$  and  $\tau(G) = \tau > \frac{n}{2}$ . Let  $W$  be its  $\tau$ -set. Then,  $n - 2h \leq \tau \leq n - h - 1$  if and only if  $G[W] \cong K_\tau$ .*

**Corollary 3.** *For every  $n \geq 7$ , the graphs  $F_1, F_2, F_3$  and  $F_4$ , displayed in Figure 1, satisfy  $\beta(F_i) = n - 3$ .*

## 4 Partition dimension almost the order

Our aim in this section is to completely characterize the set of all graphs of order  $n \geq 9$  such that  $\beta_p(G) = n - 2$ . This issue was already approached in [17], but, as remarked in our introductory section, the list of 23 graphs presented for every order  $n \geq 9$  turned out to be wrong.

As was shown in Proposition 1(8), it is clear that the only graphs whose partition dimension equals its order, are the complete graphs. The next result, along with Proposition 1(9) and Proposition 2, allows us to characterize, in a pretty simple way, all connected graphs of order  $n$  with partition dimension  $n - 1$ , a result already proved in [5] for  $n \geq 3$ . for the case  $\beta_p(G) = n - 1$ ,

**Proposition 9.** *Let  $G$  be a graph of order  $n \geq 9$  and twin number  $\tau$ , and let  $W$  be a  $\tau$ -set. Then,  $\beta_p(G) = n - 1$  if and only if  $G$  satisfies one of the following conditions:*

- (i)  $\tau = n - 1$ .
- (ii)  $\tau = n - 2$  and  $G[W] \cong K_{n-2}$ .

*Proof.* Suppose that  $\beta_p(G) = n - 1$ . Then, by Theorem 4,  $\tau > \frac{n}{2}$ . Thus, by Theorem 6 and Corollary 2,  $n - 2 \leq \tau \leq n - 1$  and if  $\tau = n - 2$ , then  $G[W] \cong K_{n-2}$ .

If  $\tau = n - 1$ , i.e., if  $G \cong K_{1,n-1}$ , then  $\beta_p(G) = n - 1$ . If  $\tau = n - 2$  and  $G[W] \cong K_{n-2}$  then, according to Proposition 7,  $\beta_p(G) \geq \tau + 1 = n - 1$ , which means that  $\beta_p(G) = n - 1$ , as  $G$  is not the complete graph.  $\square$

**Corollary 4.** *([5]) Let  $G$  be a graph of order  $n \geq 9$ . Then,  $\beta_p(G) = n - 1$  if and only if  $G$  is one of the following graphs:*

1. the star  $K_{1,n-1}$ .
2. the complete split graph  $K_{n-2} \vee \overline{K_2}$  obtained by removing an edge  $e$  from the complete graph  $K_n$  (see Figure 2(a)).
3. the graph  $K_1 \vee (K_1 + K_{n-2})$  obtained by attaching a leaf to the complete graph  $K_{n-1}$  (see Figure 2(b)).

Next, we approach the case  $\beta_p(G) = n - 2$ .

**Definition 2.** Let  $G = (V, E)$  a graph such that  $\tau(G) = \tau$ . Let  $W$  be a  $\tau$ -set of  $G$  such that  $G[W] \cong K_\tau$ . A vertex  $v \in V \setminus W$  is said to be a  $W$ -distinguishing vertex of  $G$  if and only if, for every vertex  $z \in N(W) \setminus W$ ,  $d(v, z) \neq d(v, W)$ .

**Lemma 3.** *Let  $G = (V, E)$  be a nontrivial graph of order  $n$  such that  $\tau(G) = \tau > \frac{n}{2}$ . Suppose that its  $\tau$ -set  $W$  satisfies  $G[W] \cong K_\tau$ . Then, the following statements hold:*



- (a) If  $G$  contains a  $W$ -distinguishing vertex, then  $\beta_p(G) = \tau + 1$ .
- (b) If  $G[N(W) \setminus W]$  contains an isolated vertex, then  $\beta_p(G) = \tau + 1$ .
- (c) If  $|N(W) \setminus W| = 1$ , then  $\beta_p(G) = \tau + 1$ .
- (d) If  $G[N(W) \setminus W]$  contains a universal vertex  $v$ , then  $v$  is adjacent to at least one vertex of  $V \setminus N[W]$ .

*Proof.* (a) Let  $v$  be a  $W$ -distinguishing vertex. Set  $W = \{w_1, w_2, \dots, w_\tau\}$  and  $V \setminus W = \{v, z_1, \dots, z_r\}$ , where  $r = n - \tau - 1 < \tau$ . Take the partition  $\Pi = \{S_1, \dots, S_{\tau+1}\}$ , where:  $S_1 = \{w_1, z_1\}, \dots, S_r = \{w_r, z_r\}, S_{r+1} = \{w_{r+1}, \dots, S_\tau = \{w_\tau\}, S_{\tau+1} = \{v\}$ . Notice that if  $z_i \in N(W) \setminus W$ , then

$$d(z_i, S_{\tau+1}) = d(z_i, v) \neq d(v, W) = d(v, w_i) = d(w_i, S_{\tau+1}),$$

and if  $z_i \notin N(W)$ , then for any  $j \in \{1, \dots, \tau\}$  such that  $i \neq j$  we have

$$d(z_i, S_j) = d(z_i, w_j) > 1 = d(w_i, w_j) = d(w_i, S_j).$$

Thus,  $r(w_i|\Pi) \neq r(z_i|\Pi)$  for every  $i \in \{1, \dots, r\}$ , and consequently  $\Pi$  is a locating partition of  $G$ .

- (b) If  $v$  is an isolated vertex in  $G[N(W) \setminus W]$ , then for every vertex  $z \in N(W) \setminus W$ ,  $d(v, z) = 2 \neq 1 = d(v, W)$ . Hence,  $v$  is a  $W$ -distinguishing vertex of  $G$ , and, according to item (a),  $\beta_p(G) = \tau + 1$ .
- (c) In this case, the only vertex in  $N(W) \setminus W$  is isolated in  $G[N(W) \setminus W]$  and, according to item (b),  $\beta_p(G) = \tau + 1$ .
- (d) Notice that if  $v$  is universal in  $G[N(W) \setminus W]$  and has no neighbor in  $V \setminus N[W]$ , then  $v$  would be a twin of any vertex in  $W$ , which is a contradiction.  $\square$

As a straightforward consequence of item (b) of the previous lemma, the following holds.

**Corollary 5.** *For every  $n \geq 9$ , the graphs  $F_5$  and  $F_6$ , displayed in Figure 1, satisfy  $\beta(F_i) = n - 3$ .*

**Lemma 4.** *Let  $G = (V, E)$  be a graph of order  $n \geq 9$  such that  $\tau(G) = \tau = n - 4$  and its  $\tau$ -set  $W$  satisfies  $G[W] \cong K_\tau$ . If  $|N(W) \setminus W| = 2$ , then  $\beta_p(G) = n - 3$ .*

*Proof.* Let  $W = \{w_1, \dots, w_{n-4}\}$ ,  $V \setminus W = \{z_1, z_2, z_3, z_4\}$  and  $N(W) \setminus W = \{z_1, z_2\}$ .

If  $z_1 z_2 \notin E$ , then both  $z_1$  and  $z_2$  are isolated vertices in  $G[N(W) \setminus W]$ . Hence, by Lemma 3(b),  $\beta_p(G) = \tau(G) + 1 = n - 3$ .

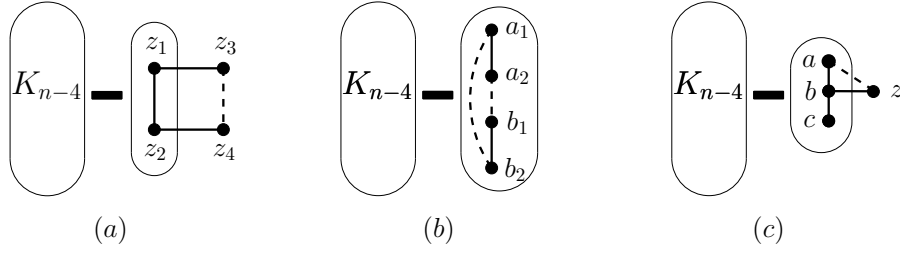

Figure 6: In the three cases,  $\tau = n - 4$  and  $G[W] \cong K_{n-4}$ . Solid lines hold for adjacent vertices meanwhile dashed lines are optional.

Suppose that  $z_1 z_2 \in E$ . According to Lemma 3(b), both  $z_1$  and  $z_2$  are adjacent to at least one vertex of  $V \setminus N(W) = \{z_3, z_4\}$ . If, for some  $i \in \{3, 4\}$ , either  $\{z_1 z_i, z_2 z_i\} \subset E$ , then  $z_i$  is a  $W$ -distinguishing vertex, i.e.,  $\beta_p(G) = \tau + 1 = n - 3$ .

Assume thus that  $\{z_1 z_3, z_2 z_4\} \subset E$  and  $\{z_1 z_4, z_2 z_3\} \cap E = \emptyset$  (see Figure 6(a)). Notice that none of the vertices of  $V \setminus W$  is  $W$ -distinguishing. Take the partition  $\Pi = \{S_1, \dots, S_{n-3}\}$ , where

$$S_1 = \{w_1, z_1\}, S_2 = \{w_2, z_2\}, S_3 = \{z_3, z_4\}, S_4 = \{w_3\}, \dots, S_{n-3} = \{w_{n-4}\}.$$

Clearly,  $\Pi$  is a locating partition of  $G$ , since  $d(w_1|S_3) = 2 \neq 1 = d(z_1, S_3)$ ,  $d(w_2|S_3) = 2 \neq 1 = d(z_2|S_3)$  and  $d(z_3|S_1) = 1 \neq 2 = d(z_4|S_1)$ . Finally, from Proposition 7, we derive that  $\beta_p(G) = n - 3$ .  $\square$

As a straightforward consequence of this lemma, the following holds.

**Corollary 6.** *For every  $n \geq 9$ , the graphs  $F_7$  and  $F_8$ , displayed in Figure 1, satisfy  $\beta(F_i) = n - 3$ .*

**Theorem 7.** *Let  $G$  be a graph of order  $n \geq 9$ . Then,  $\beta_p(G) = n - 2$  if and only if  $G$  belongs to the following family  $\{H_i\}_{i=1}^{15}$  (see Figure 7):*

$$\begin{array}{lll} H_1 \cong K_{2,n-2} & H_2 \cong \overline{K_{n-2}} \vee K_2 & H_3 \cong K_{n-3} \vee (K_2 + K_1) \\ H_4 \cong K_{n-3} \vee \overline{K_3} & H_5 \cong (K_{n-3} + K_1) \vee K_2 & H_6 \cong (K_{n-3} + K_1) \vee \overline{K_2} \\ H_7 \cong H_6 - e_1 & H_8 \cong (K_{n-3} + K_2) \vee K_1 & H_9 \cong H_8 - e_2 \\ H_{10} \cong (K_{n-3} + \overline{K_2}) \vee K_1 & H_{11} \cong K_{n-4} \vee C_4 & H_{12} \cong K_{n-4} \vee P_4 \\ H_{13} \cong K_{n-4} \vee 2K_2 & H_{14} \cong (K_{n-4} + K_1) \vee P_3 - e' & H_{15} \cong H_{14} - e_3 \end{array}$$

where  $e'$  is an edge joining the vertex of  $K_1$  with an endpoint of  $P_3$  in  $(K_{n-4} + K_1)$  and  $e_1$  is an edge joining the vertex of  $K_1$  with a vertex of  $\overline{K_2}$  in  $H_6$ ;  $e_2$  is an edge joining the vertex of  $K_1$  with a vertex of  $K_2$  in  $H_8$ ;  $e_3$  is an edge joining the vertex of  $K_1$  with an endpoint of  $P_3$  in  $H_{14}$ .

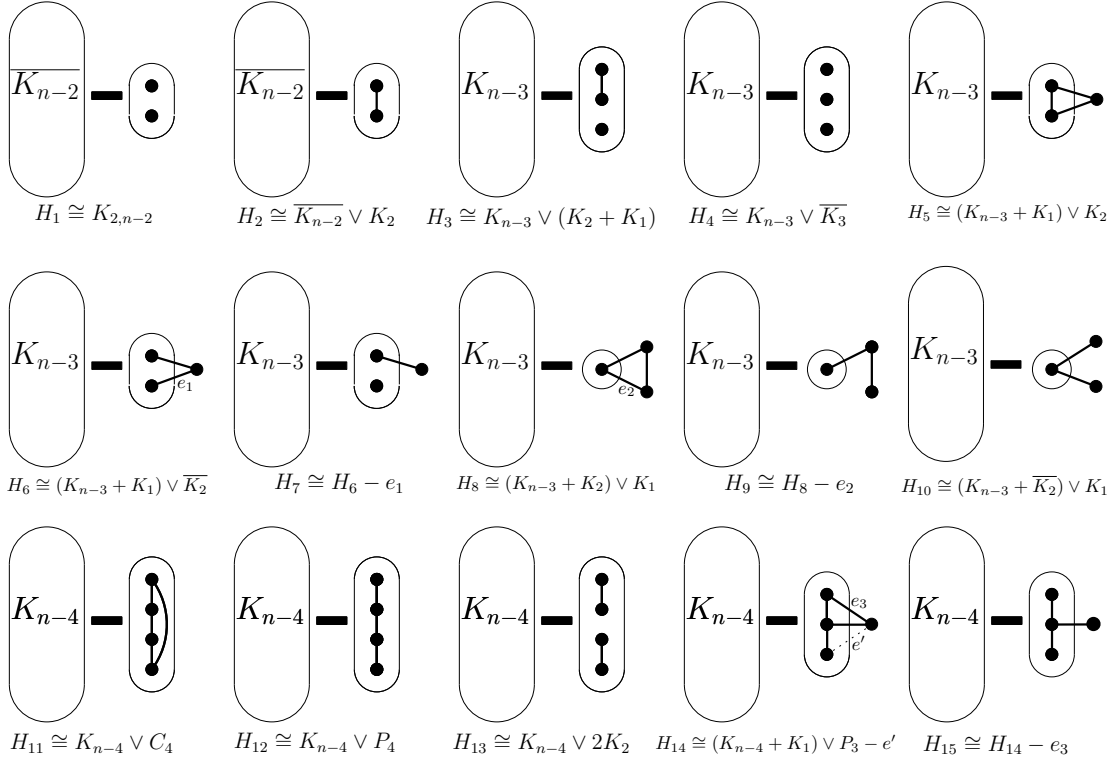

Figure 7: These are all graph families such that  $\beta_p(G) = n - 2$ . If  $i \in \{1, 2\}$ , then  $\tau(H_i) = n - 2$ . If  $i \in \{3, \dots, 10\}$ , then  $\tau(H_i) = n - 3$ . If  $i \in \{11, \dots, 15\}$ , then  $\tau(H_i) = n - 4$ .

*Proof.* ( $\Leftarrow$ ) First suppose that  $G$  is a graph belonging to the family  $\{H_i\}_{i=1}^{15}$ . We distinguish three cases.

**Case 1:**  $G \in \{H_1, H_2\}$ . Hence,  $\tau(G) = n - 2$  and its  $\tau$ -set  $W$  satisfies  $G[W] \cong \overline{K_{n-2}}$ . Thus, according to Proposition 8,  $\beta_p(G) = n - 2$ .

**Case 2:**  $G \in \{H_i\}_{i=3}^{10}$ . Hence,  $\tau(G) = n - 3$  and its  $\tau$ -set  $W$  satisfies  $G[W] \cong K_{n-3}$ . Thus, according to Proposition 7,  $\beta_p(G) \geq \tau(G) + 1 = n - 2$ . Furthermore, from Proposition 9 we deduce that  $\beta_p(G) = n - 2$ .

**Case 3:**  $G \in \{H_i\}_{i=11}^{15}$ . Clearly, for all these graphs  $\text{diam}(G) = 2$ ,  $\tau(G) = n - 4$  and its  $\tau$ -set  $W$  satisfies  $G[W] \cong K_{n-4}$ . According to Proposition 7 and Theorem 4,  $n - 3 \leq \beta_p(G) \leq n - 2$ . Suppose that there exists a locating partition  $\Pi = \{S_1, \dots, S_{n-3}\}$  of cardinality  $n - 3$ . If  $W = \{w_1, \dots, w_{n-4}\}$ , assume that, for every  $i \in \{1, \dots, n - 4\}$ ,  $w_i \in S_i$ . We distinguish two cases.

**Case 3.1:**  $G \in \{H_{11}, H_{12}, H_{13}\}$ . Note that  $N(W) = V(G)$  and in all cases there is a labelling  $V(G) \setminus W = \{a_1, a_2, b_1, b_2\}$  such that  $d(a_1, a_2) = 1$ ,  $d(b_1, b_2) = 1$ ,  $d(a_1, b_1) = 2$

and  $d(a_2, b_2) = 2$  (see Figure 6(b)).

Observe that  $|S_{n-3}| = 1$ , since  $r(z, \Pi) = (1, \dots, 1, 0)$  for every  $z \in \{a_1, a_2, b_1, b_2\} \cap S_{n-3}$ . Notice also that  $|S_i| \leq 2$  for  $i \in \{1, \dots, n-4\}$ , as for every  $x \in S_i$ , we have  $r(x, \Pi) = (1, \dots, 1, \overset{i}{0}, 1, \dots, 1, h)$ , with  $h \in \{1, 2\}$ . Hence, there are exactly three sets of  $\Pi$  of cardinality 2. We can suppose without loss of generality that  $S_1 = \{w_1, x\}$ ,  $S_2 = \{w_2, y\}$ ,  $S_3 = \{w_3, z\}$  and  $S_{n-3} = \{t\}$ , where  $\{x, y, z, t\} = \{a_1, a_2, b_1, b_2\}$ . Hence,  $d(t, x) = d(t, y) = d(t, z) = 2$ , a contradiction.

**Case 3.2:**  $G \in \{H_{14}, H_{15}\}$ . Note that  $|N(W) \setminus W| = 3$  and that there is a labelling  $V(G) \setminus W = \{a, b, c, z\}$  such that  $N(W) \setminus W = \{a, b, c\}$ ,  $d(a, b) = d(b, c) = d(b, z) = 1$ ,  $d(c, a) = d(c, z) = 2$  and  $d(a, z) \in \{1, 2\}$  (see Figure 6(c)).

Notice that  $|S_{n-3}| \leq 2$ , since for every  $x \in \{a, b, c\} \cap S_{n-3}$ ,  $r(x, \Pi) = (1, \dots, 1, 0)$ . Moreover,  $b \notin S_{n-3}$ , otherwise  $a$  and  $c$  do not belong to  $S_{n-3}$  and we would have  $r(a, \Pi) = r(c, \Pi) = (1, \dots, 1, 1)$ . So, we can assume without loss of generality that  $\{w_1, b\} \subseteq S_1$ . If  $\{a, c\} \cap S_{n-3} \neq \emptyset$ , then  $r(w_1, \Pi) = r(b, \Pi) = (1, \dots, 1, 1)$ . Consequently,  $r(w_i, \Pi) = r(c, \Pi) = (1, \dots, 1, 2)$  for every  $i \in \{1, \dots, n-4\}$ , a contradiction.

( $\implies$ ) Now assume that  $G$  is a graph such that  $\beta_p(G) = n-2$ . By Theorem 4,  $\tau(G) > \frac{n}{2}$ , and according to Corollary 2, we have  $n-4 \leq \tau(G) \leq n-2$ . We distinguish three cases, depending on the cardinality of  $\tau(G)$ .

**Case 1:**  $\tau(G) = n-2$ . Thus, according to Proposition 2 and Theorem 4,  $G \in \{H_1, H_2\}$ .

**Case 2:**  $\tau(G) = n-3$ . In this case, from Proposition 8 we deduce that its  $\tau$ -set  $W$  satisfies  $G[W] \cong K_{n-3}$ . We distinguish three cases, depending on the cardinality of  $N(W) \setminus W$ .

**Case 2.1:**  $|N(W) \setminus W| = 3$ . In this case,  $G[N(W) \setminus W] \in \{K_3, P_3, K_2 + K_1, \overline{K_3}\}$ . If  $G[N(W) \setminus W]$  is  $K_3$  or  $P_3$ , then  $\tau(G) \geq n-2$ , a contradiction. If  $G[N(W) \setminus W] \cong K_2 + K_1$ , then  $G \cong H_3$ , and if  $G[N(W) \setminus W] \cong \overline{K_3}$ , then  $G \cong H_4$ .

**Case 2.2:**  $|N(W) \setminus W| = 2$ . In this case,  $G[N(W) \setminus W] \in \{K_2, \overline{K_2}\}$  and  $|V \setminus N(W)| = 1$ . Let  $z$  be the vertex in  $V \setminus N(W)$ . If  $G[N(W) \setminus W] \cong K_2$  and  $\deg(z) = 1$ , then  $\tau(G) = n-2$ , a contradiction. If  $G[N(W) \setminus W] \cong K_2$  and  $\deg(z) = 2$ , then  $G \cong H_5$ . If  $G[N(W) \setminus W] \cong \overline{K_2}$  and  $\deg(z) = 2$ , then  $G \cong H_6$ . Finally, if  $G[N(W) \setminus W] \cong \overline{K_2}$  and  $\deg(z) = 1$ , then  $G \cong H_7$ .

**Case 2.3:**  $|N(W) \setminus W| = 1$ . Let  $N(W) \setminus W = \{x\}$  and  $V \setminus N(W) = \{y, z\}$ . If  $\deg(y) = \deg(z) = 2$ , then  $G \cong H_8$ . If  $\{\deg(y), \deg(z)\} = \{1, 2\}$ , then  $G \cong H_9$ . If  $\deg(y) = \deg(z) = 1$ , then  $G \cong H_{10}$ .

**Case 3:**  $\tau(G) = n-4$ . Let  $W$  be its  $\tau$ -set. In this case, from Proposition 8 we deduce that its  $\tau$ -set  $W$  satisfies  $G[W] \cong K_{n-4}$ . Moreover, from Lemmas 3 and 4, we deduce that  $G$  does not contain any  $W$ -distinguishing vertex and  $|N(W) \setminus W| \geq 3$ . Hence,  $3 \leq |N(W) \setminus W| \leq 4$ . We distinguish two cases, depending on the cardinality of

$N(W) \setminus W$ .

**Case 3.1:**  $|N(W) \setminus W| = 4$ . According to Lemma 3, all vertices of  $G[N(W) \setminus W]$  have degree either 1 or 2. Thus,  $G[N(W) \setminus W]$  is isomorphic to either  $C_4$  or  $P_4$  or  $2K_2$ . Hence,  $G$  is isomorphic to either  $H_{11}$  or  $H_{12}$  or  $H_{13}$ .

**Case 3.2:**  $|N(W) \setminus W| = 3$ . According to Lemma 3,  $G[N(W) \setminus W]$  is either  $C_3$  or a  $P_3$ . Suppose that  $G[N(W) \setminus W]$  is  $C_3$ . Then, by Lemma 3(d), every vertex of  $N(W) \setminus W$  is adjacent to the unique vertex  $z$  of  $V \setminus N(W)$ , a contradiction since in this case  $z$  would be a  $W$ -distinguishing vertex. Thus,  $G[N(W) \setminus W]$  is  $P_3$ . According to Lemma 3(d), the central vertex  $w$  of  $P_3$  is adjacent to the unique vertex  $z$  of  $V \setminus N(W)$ . Observe also that one of the remaining two vertices of this path may be adjacent to vertex  $z$ , but not both, since in this case  $z$  would be a  $W$ -distinguishing vertex. Hence,  $G$  is isomorphic to either  $H_{14}$  or  $H_{15}$ .  $\square$

## Acknowledgements

Research partially supported by grants MINECO MTM2015-63791-R, Gen. Cat. DGR 2014SGR46 and MTM2014-60127-P.

## References

- [1] E. T. Baskoro and Darmaji, The partition dimension of the corona product of two graphs, *Far East J. Math. Sci.* **66** (2) (2012), 181–196.
- [2] J. Cáceres, C. Hernando, M. Mora, I. M. Pelayo, M. L. Puertas, C. Seara and D. R. Wood, On the metric dimension of Cartesian products of graphs, *SIAM J. Discrete Math.* **21** (2) (2007), 423–441.
- [3] G. G. Chappell, J. Gimbel and C. Hartman, Bounds on the metric and partition dimensions of a graph, *Ars Combinatoria.* **88** (2008), 349–366.
- [4] G. Chartrand, L. Lesniak, P. Zhang, *Graphs and Digraphs*, fifth edition, CRC Press, Boca Raton (FL), (2011).
- [5] G. Chartrand, E. Salehi and P. Zhang, The partition dimension of a graph, *Aequationes Mathematicae*, **59** (2000), 45–54.
- [6] M. Fehr, S. Gosselin, and O. R. Oellermann, The partition dimension of Cayley digraphs, *Aequationes Math.* **71** (1-2) (2006), 1–18.
- [7] H. Fernau, J. A. Rodríguez-Velázquez and I. González-Yero, On the partition dimension of unicyclic graphs, *Bull. Math. Soc. Sci. Math. Roumanie* **57(105)** (4) (2014), 381–391.

- [8] I. González Yero and J.A. Rodríguez-Velázquez, A note on the partition dimension of Cartesian product graphs, *Applied Mathematics and Computation*, **217** (7) (2010), 3571–3574.
- [9] I. González Yero, M. Jakovac, D. Kuziak and A. Taranenko, The partition dimension of strong product graphs and Cartesian product graphs, *Discrete Math.* **331** (2014), 43–52.
- [10] C. Grigorious, S. Stephen, B. Rajan, M. Miller and A. William, On the partition dimension of a class of circulant graphs, *Information Processing Letters*, **114** (2014), 353–356.
- [11] F. Harary and R. Melter, On the metric dimension of a graph, *Ars Combinatoria* **2** (1976), 191195.
- [12] C. Hernando, M. Mora, I. M. Pelayo, C. Seara and D. R. Wood, Extremal graph theory for metric dimension and diameter, *Electron. J. Combin.* **17** (1) (2010), R30, 28pp.
- [13] O. Ore, Theory of graphs, *Amer. Math. Soc. Colloq. Pub.* **XXXVIII**, Providence (RI), (1962).
- [14] J. A. Rodríguez-Velázquez, I. González Yero and D. Kuziak, Partition dimension of corona product graphs, *Ars Combin.*, to appear.
- [15] J. A. Rodríguez-Velázquez, I. González Yero and M. Lemanska, On the partition dimension of trees, *Discrete Appl. Math.*, **166** (2014), 204–209.
- [16] P. J. Slater, Leaves of trees, *Proc. 6th Southeastern Conf. on Combinatorics, Graph Theory, and Computing, Congr. Numer.* **14** (1975), 549–559.
- [17] I. Tomescu, Discrepancies between metric dimension and partition dimension of a connected graph, *Discrete Mathematics*, **308** (2008), 5026–5031.
- [18] I. Tomescu and M. Imran, On metric and partition dimensions of some infinite regular graphs, *Bull. Math. Soc. Sci. Math. Roumanie (N.S.)*, **52** (100) (4) (2009), 461–472.
- [19] I. Tomescu, I. Javaid and Slamin, On the partition dimension and connected partition dimension of wheels, *Ars Combin.*, **84** (2007), 311–317.