



Hamiltonian Paths in C -shaped Grid Graphs

Fatemeh Keshavarz-Kohjerdi and Alireza Bagheri

Department of Computer Engineering & IT, Amirkabir University of Technology, Tehran, Iran

fatemeh.keshavarz@aut.ac.ir

Corresponding author: ar_bagheri@aut.ac.ir

Abstract

We study the Hamiltonian path problem in C -shaped grid graphs, and present the necessary and sufficient conditions for the existence of a Hamiltonian path between two given vertices in these graphs. We also give a linear-time algorithm for finding a Hamiltonian path between two given vertices of a C -shaped grid graph, if it exists.

© 2011 Published by Elsevier Ltd.

Keywords: Grid graph, Hamiltonian path, C -shaped grid graph, NP-complete.

1. Introduction

One of the well-known NP-complete problems in graph theory is the Hamiltonian path problem; i.e., finding a simple path in the graph such that every vertex visits exactly once [5]. The two-dimensional integer grid G^∞ is an infinite undirected graph in which vertices are all points of the plane with integer coordinates and two vertices are connected by an edge if and only if the Euclidean distance between them is equal to 1. A grid graph G_g is a finite vertex-induced subgraph of the two-dimensional integer grid G^∞ . A solid grid graph is a grid graph without holes. A rectangular grid graph $R(m, n)$ is the subgraph of G^∞ (the infinite grid graph) induced by $V(R) = \{v \mid 1 \leq v_x \leq m, 1 \leq v_y \leq n\}$, where v_x and v_y are x and y coordinates of v , respectively. A C -shaped grid graph $C(m, n, k, l)$ is a rectangular grid graph $R(m, n)$ such that a rectangular subgraph $R(k, l)$ is removed from it while $R(m, n)$ and $R(k, l)$ have exactly one border side in common, where $k, l \geq 1$ and $m, n > 1$ (see Fig. 1(c)). In this paper, we only focus on the results on grid graphs. There are some results on Hamiltonian path for other classes of graphs which we do not mention here, see [3, 16] for more details.

In [10], Itai *et al.* proved that the Hamiltonian path problem for general grid graphs, with or without specified endpoints, is NP-complete. They showed that the problem for rectangular grid graphs can be solved in linear time. Chen *et al.* [2] gave a parallel algorithm for the problem in mesh architecture. Lenhart and Umans [15] gave a polynomial-time algorithm for finding Hamiltonian cycles in solid grid graphs. Their algorithm runs in $O(n^4)$ time. Also, Salman [17] introduced a family of grid graphs, that is, alphabet grid graphs, and determined classes of alphabet grid graphs that contain Hamiltonian cycles. In [11], the authors proposed a linear-time algorithm for the Hamiltonian path problem for some small classes of grid graphs, namely L -alphabet, C -alphabet, E -alphabet, and F -alphabet grid graphs. In [14], necessary and sufficient conditions for the existence of a Hamiltonian path in L -shaped grid graphs have been studied. L -alphabet and C -alphabet grid graphs considered in [11] are special cases of L -shaped

and C -shaped grid graphs, respectively. Some other results about grid graphs are investigated in [1, 6, 9, 12, 13, 18, 19, 20].

In this paper, we obtain necessary and sufficient conditions for the existence of a Hamiltonian path between two given vertices in C -shaped grid graphs, which are a special type of solid grid graphs. Also, we show that a Hamiltonian path in this graph can be found in linear time. Since the Hamiltonian path problem for solid grid graphs is open, thus solving the problem for special cases can be considered as the first attempts to solve the problem in solid grid graphs. Moreover, this problem has many applications such as

1. In the problem of embedding a graph in a given grid [4], the first step is to recognize if there are enough rooms in the host grid for the guest graph. If the guest graph is a path, then the problem makes relation to the well-known longest path and Hamiltonian path problems. If we would like to see if a given solid grid graph has a Hamiltonian path we may reach to the problem of finding a Hamiltonian path between two given vertices.
2. In the offline exploration problem [8], a mobile robot with limited sensor should visit every cell in a known cellular room without obstacles in order to explore it and return to start point such that the number of multiple cell visits is small. In this problem, let the vertices correspond to the center of each cell and edges connect adjacent cells, then we have a grid graph with a given start and end points. Finding a Hamiltonian cycle in the grid graph corresponds to visiting each cell exactly once (i.e., a cycle containing all the vertices of the grid graph).
3. In the picturesque maze generation problem [7], we are given a rectangular black-and-white raster image and want to randomly generate a maze in which the solution path fills up the black pixels. The solution path is a Hamiltonian path of a subgraph induced by the vertices that correspond to the black cells.

The rest of the paper is organized as follows. Section 2 gives the preliminaries. Necessary conditions for the existence of a Hamiltonian path in C -shaped grid graphs are given in Section 3. In Section 4, we show how to obtain a Hamiltonian path for C -shaped grid graphs (sufficient conditions). The conclusion is given in Section 5.

2. Preliminaries

In this section, we quote some definitions and results which we need in the following sections. Some of the definitions are given here are previously defined in [2, 10, 12, 13, 14].

The *two-dimensional integer grid* is an undirected graph in which vertices are all points of the plane with integer coordinates and two vertices are connected by an edge if and only if the Euclidean distance between them is equal to 1. For a vertex v of this graph, let v_x and v_y denote x and y coordinates of its corresponding point, respectively (sometimes we use (v_x, v_y) instead of v). We color the vertices of the two-dimensional integer grid as black and white. A vertex v is colored *white* if $v_x + v_y$ is even, otherwise it is colored *black*.

A *grid graph* G_g is a finite vertex-induced subgraph of the two-dimensional integer grid G^∞ . In a grid graph G_g , each vertex has degree at most four. Clearly, there is no edge between any two vertices of the same color. Therefore, G_g is a bipartite graph. Note that any cycle or path in a bipartite graph alternates between black and white vertices. Assume $G = (V(G), E(G))$ is a graph with vertex set $V(G)$ and edge set $E(G)$. Assume $v \in V(G)$. The number of edges incident at v in G is called degree of the vertex v in G and is denoted by $degree(v)$.

A *rectangular grid graph*, denoted by $R(m, n)$ (or R for short), is a grid graph whose vertex set is $V(R) = \{v \mid 1 \leq v_x \leq m, 1 \leq v_y \leq n\}$. The graph $R(9, 5)$ is illustrated in Fig. 1(a). The size of $R(m, n)$ is defined to be $m \times n$. $R(m, n)$ is called *odd-sized* if $m \times n$ is odd, otherwise it is called *even-sized*. $R(m, n)$ is called a k -rectangle if $k = m$ or n .

A *L-shaped grid graph* (resp. *C-shaped grid graph*), denoted by $L(m, n, k, l)$ (resp. $C(m, n, k, l)$) (or L (resp. C) for short), is a rectangular grid graph $R(m, n)$ such that a rectangular subgraph $R(k, l)$ is removed from it while $R(m, n)$ and $R(k, l)$ have exactly two (resp. one) border side in common, where $k, l \geq 1$ and $m, n > 1$. Fig. 1(b) and 1(c) show a L -shaped grid graph with $m = 9$, $n = 7$, $k = 5$, and $l = 2$, and a C -shaped grid graph, with $m = 11$, $n = 8$, $k = 3$, and $l = 4$, respectively. In this paper, we consider C -shaped grid graph $C(m, n, k, l)$ shown in Fig. 1(c) with any values of d, c, k, l, m , and n . Let $G(m, n, k, l)$ be a L -shaped or C -shaped grid graph. The size of $G(m, n, k, l)$ is $m \times n - k \times l$. $G(m, n, k, l)$ is called *even-sized* if $m \times n - k \times l$ is even, otherwise it is called *odd-sized*.

We will refer to a grid graph $G(m, n)$ with two specified distinct vertices s and t as $(G(m, n, s, t))$. We say that $(G(m, n, s, t))$ is Hamiltonian if there is a Hamiltonian path between s and t in G . In the following by Hamiltonian

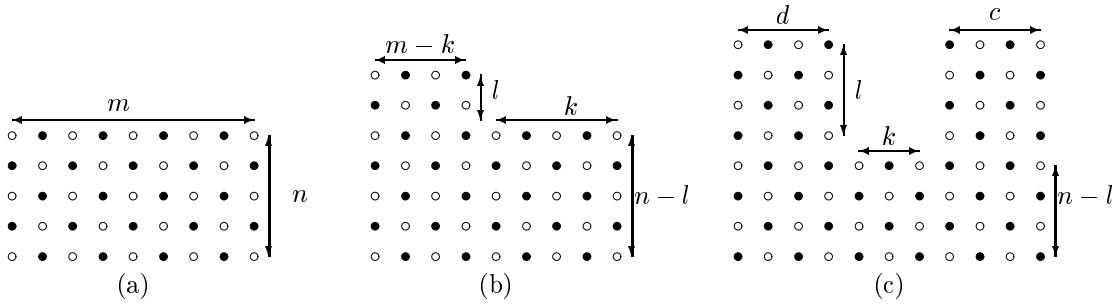

Figure 1. (a) $R(9, 5)$, (b) $L(9, 7, 5, 2)$, and (c) $C(11, 8, 3, 4)$

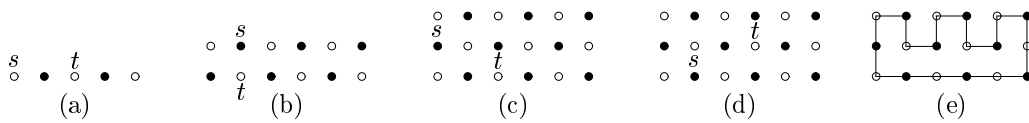

Figure 2. The rectangular grid graphs in which there is no Hamiltonian (s, t) -path, and a Hamiltonian cycle in $R(6, 3)$.

(s, t) -path we mean a Hamiltonian path between s and t . Throughout this paper in the figures, $(1, 1)$ is the coordinates of the vertex in the upper left corner, except we explicitly change this assumption. Without loss of generality, we assume that $s_x \leq t_x$.

Definition 2.1. Suppose that $G(V_1 \cup V_2, E)$ is a bipartite graph such that $|V_1| \geq |V_2|$ and the vertices of G colored by two colors, black and white. All the vertices of V_1 will be colored by one color, the majority color, and the vertices of V_2 by the minority color. The Hamilton path problem (G, s, t) is *color-compatible* if

1. s and t have different colors and G is even-sized ($|V_1| = |V_2|$), or
2. s and t have the majority color and G is odd-sized ($|V_1| = |V_2| + 1$)

Definition 2.2. Let G be a connected graph and V_1 be a subset of the vertex set $V(G)$. V_1 is a *vertex cut* of G if $G - V_1$ is disconnected. A vertex v of G is a *cut vertex* of G if $\{v\}$ is a vertex cut of G . For an example, in Fig. 2(a) t is a cut vertex and in Fig. 2(b) $\{s, t\}$ is a vertex cut.

In an odd-sized grid graph the number of vertices with the minority color is one less than the number of vertices with the majority color. Therefore, the two end-vertices of any Hamiltonian path in such a graph must have the majority color. Similarly, in an even-sized grid graph the number of black vertices is equal to the number of white vertices. Thus, the two end-vertices of any Hamiltonian path in the graph must have different colors. Hence, we conclude that the color-compatibility of s and t is a necessary condition for a grid graph to be Hamiltonian.

Additionally, Itai *et al.* [10] showed that if one of the following conditions holds, then $(R(m, n), s, t)$ is not Hamiltonian:

(F1) s or t is a cut vertex or $\{s, t\}$ is a vertex cut (Fig. 2(a) and 2(b)). Notice that, here, s or t is a cut vertex if $R(m, n)$ is a 1-rectangle and either s or t is not a corner vertex, and $\{s, t\}$ is a vertex cut if $R(m, n)$ is a 2-rectangle and $[(2 \leq s_x = t_x \leq m - 1 \text{ and } n = 2) \text{ or } (2 \leq s_y = t_y \leq n - 1 \text{ and } m = 2)]$.

(F2) All the cases that are isomorphic to the following cases:

1. m is even, $n = 3$,
2. s is black, t is white,
3. $s_y = 2$ and $s_x < t_x$ (Fig. 2(c)) or $s_y \neq 2$ and $s_x < t_x - 1$ (Fig. 2(d)).

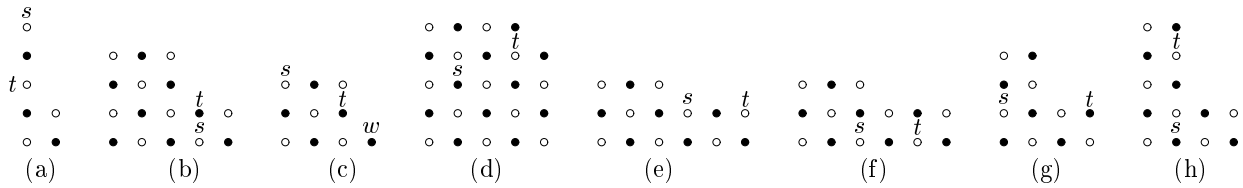

Figure 3. Some L -shaped grid graphs in which there is no Hamiltonian (s, t) -path.

Definition 2.3. [10] A rectangular Hamiltonian path problem $(R(m, n), s, t)$ is *acceptable* if it is color-compatible and $(R(m, n), s, t)$ does not satisfy any of conditions (F1) and (F2).

Theorem 2.1. [10] *There exists a Hamiltonian path between s and t in $R(m, n)$ if and only if $(R(m, n), s, t)$ is acceptable.*

Lemma 2.2. [2] *$R(m, n)$ has a Hamiltonian cycle if and only if it is even-sized and $m, n > 1$.*

Fig. 2(e) shows a Hamiltonian cycle for an even-sized rectangular grid graph, according to Lemma 2.2. Every Hamiltonian cycle according to this pattern contains all the boundary edges on the three sides of the rectangular grid graph. This means that for an even-sized rectangular grid graph R , we can always find a Hamiltonian cycle, such that it contains all the boundary edges, except of exactly one side of R which contains an even number of vertices. We need this result in the following.

Definition 2.4. [14] A *separation* of a L -shaped grid graph $L(m, n, k, l)$ is a partition of $L(m, n, k, l)$ into two disjoint grid subgraphs G_1 and G_2 , i.e., $V(L(m, n, k, l)) = V(G_1) \cup V(G_2)$, and $V(G_1) \cap V(G_2) = \emptyset$. G_1 and G_2 may be rectangular or L -shaped grid graphs. Three types of separations, vertical, horizontal and L -shaped separations are shown in Fig. 4(c)-(f).

In [14], we show that in addition to condition (F1) (as shown in Fig. 3(a) and 3(b)) whenever one of the following conditions is satisfied then $(L(m, n, k, l), s, t)$ has no Hamiltonian (s, t) -path.

(F3) $w \in V(L(m, n, k, l))$, $degree(w) = 1$, $t \neq w$, and $s \neq w$ (Fig. 3(c)).

(F4) $L(m, n, 1, 1)$ is even-sized, $m - 1 = even > 2$, $n - 1 = even > 2$, $s = (m - 1, 2)$, and $t \neq (m - 1, 1)$ or $t \neq (m, 2)$ (here the role of s and t can be swapped; i.e., $t = (m - 1, 2)$ and $s \neq (m - 1, 1)$) (Fig. 3(d)).

(F5) $L(m, n, k, l)$ is odd-sized, $n - l = 2$, $m - k = odd \geq 3$, and
 (i) $s_x, t_x > m - k$ (Fig. 3(e)); or
 (ii) $s = (m - k, n)$ and $t_x > m - k$ (Fig. 3(f)).

(F6) $L(m, n, k, l)$ is even-sized, $n - l = 2$, $m - k = 2$, and
 (i) $s = (1, n - l)$ and $t_x > 2$ (Fig. 3(g)); or
 (ii) $s = (2, n)$ and $t_y < l$ (here the role of s and t can be swapped; i.e., $t = (2, n)$ and $s_y \leq l$) (Fig. 3(h)).

(F7) $L(m, n, k, l)$ is even-sized and
 (i) $n = 3$, $l = 1$, $m - k = even > 2$, $s = (m - k - 1, 1)$, and $t = (m - k, 3)$ (Fig. 4(a)); or
 (ii) $m = 3$, $k = 1$, and $n - l = even > 2$, $s = (1, l + 1)$, and $t = (m, l + 2)$ (Fig. 4(b)).

(F8) $L(m, n, k, l)$ is even-sized and $[(m - k = 2 \text{ and } n - l > 2) \text{ or } (n - l = 2 \text{ and } m - k > 2)]$. Let $\{G_1, G_2\}$ be a vertical (or horizontal) separation of $L(m, n, k, l)$ such that G_1 is a 3-rectangle grid graph, G_2 is a 2-rectangle grid graph, and exactly two vertices u and v are in G_1 that are connected to G_2 . Let $s' = s$ and $t' = t$, if s' (or t') $\notin G_1$ then $s' = u$ (or $t' = u$). And (G_1, s', t') satisfies condition (F2) (Fig. 4(c) and 4(d)).

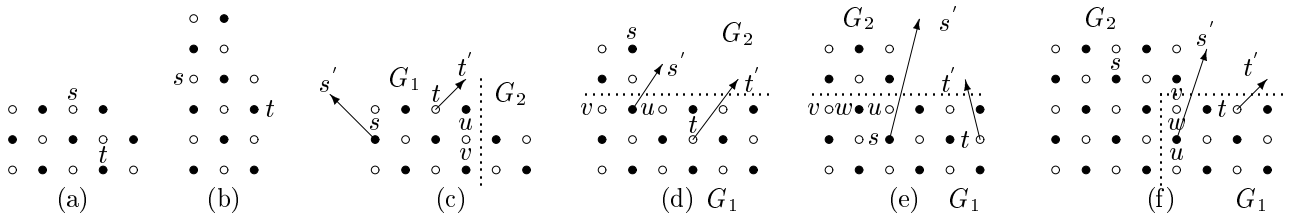

Figure 4. Some L -shaped grid graphs in which there is no Hamiltonian (s, t) -path, where dotted lines indicate the separations.

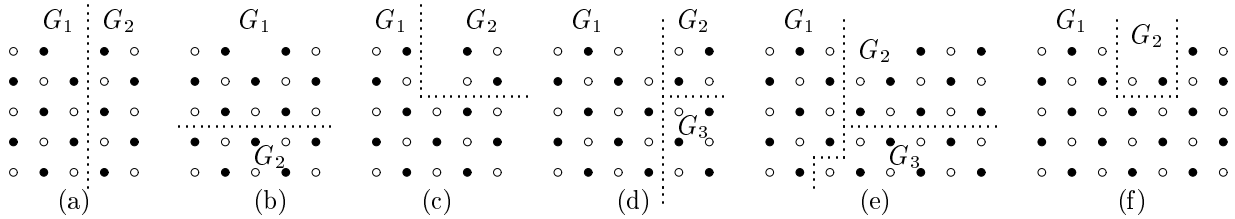

Figure 5. The four types of separations; (a) a vertical separation (b) a horizontal separation, (c) a L -shaped separation type I, (d) a L -shaped separation type II, (e) a L -shaped separation type III, and (f) a C -shaped separation type I, where dotted lines indicate the separations.

(F9) $L(m, n, k, l)$ is even-sized and $[(m - k = 3 \text{ and } n - l \geq 3) \text{ or } (m - k > 3 \text{ and } n - l = 3)]$. Let $\{G_1, G_2\}$ be a vertical (horizontal or L -shaped) separation of $L(m, n, k, l)$ such that G_1 and G_2 are even-sized, G_1 is a 3-rectangle grid graph, and G_2 is

(1) a rectangular grid graph (see Fig. 4(e)), or

(2) a L -shaped grid graph, where $m \times n = \text{even} \times \text{odd}$, $k \times l = \text{odd} \times \text{even}$, $n - l = 3$, and $m - k \geq 5$. Here, $V(G_1) = \{m - k \leq x \leq m \text{ and } l + 1 \leq y \leq n\}$ and $G_2 = L(m, n, k, l) \setminus G_1$ (see Fig. 4(f)).

Let exactly three vertices v, w and u be in G_1 that are connected to G_2 . Let $s' = s$ and $t' = t$, if s' (or t') $\notin G_1$ then $s' = w$ (or $t' = w$). And (G_1, s', t') satisfies condition (F2).

Definition 2.5. A L -shaped Hamiltonian path problem $(L(m, n, k, l), s, t)$ is *acceptable* if it is color compatible and $(L(m, n, k, l), s, t)$ does not satisfy any of conditions (F1) and (F3)-(F9).

Theorem 2.3. [14] $L(m, n, k, l)$ has a Hamiltonian (s, t) -path if and only if $(L(m, n, k, l), s, t)$ is acceptable.

Theorem 2.4. [14] In an acceptable $P(L(m, n, k, l), s, t)$, a Hamiltonian (s, t) -path can be found in linear time.

Lemma 2.5. [14] $L(m, n, k, l)$ has a Hamiltonian cycle if and only if it is even-sized, $m - k > 1$, and $n - l > 1$.

3. Necessary conditions

In this section, we are going to obtain necessary conditions for the existence of a Hamiltonian (s, t) -path in C -shaped grid graph $C(m, n, k, l)$.

Definition 3.1. A *separation* of a C -shaped grid graph $C(m, n, k, l)$ is a partition of $C(m, n, k, l)$ into at most five disjoint grid subgraphs G_1, G_2, G_3, G_4 , and G_5 that is, $V(C(m, n, k, l)) = V(G_1) \cup V(G_2) \cup V(G_3) \cup V(G_4) \cup V(G_5)$, and $V(G_1) \cap V(G_2) \cap V(G_3) \cap V(G_4) \cap V(G_5) = \emptyset$. G_1, G_2, G_3, G_4 , and G_5 may be rectangular, L -shaped, or C -shaped grid graph. We consider the four types of separation, vertical, horizontal, L -shaped, and C -shaped separations are shown in Fig. 5 and 6.

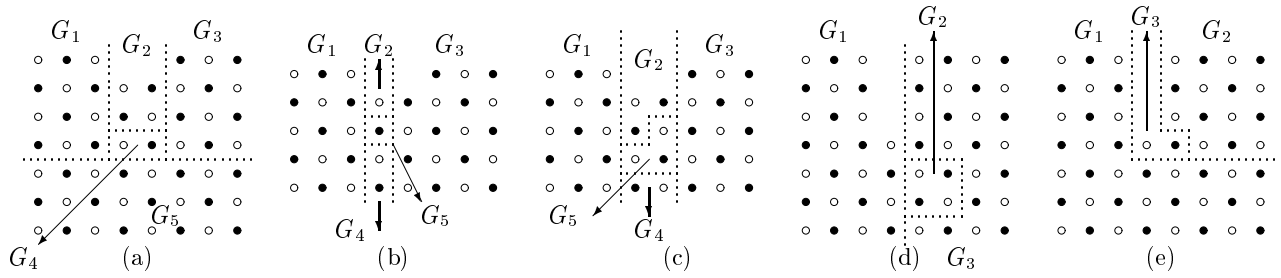

Figure 6. The four types of separations; (a) a C -shaped separation type II, (b) and (c) a C -shaped separation type III, (d) a C -shaped separation type IV, and (e) a C -shaped separation type V, where dotted lines indicate the separations.

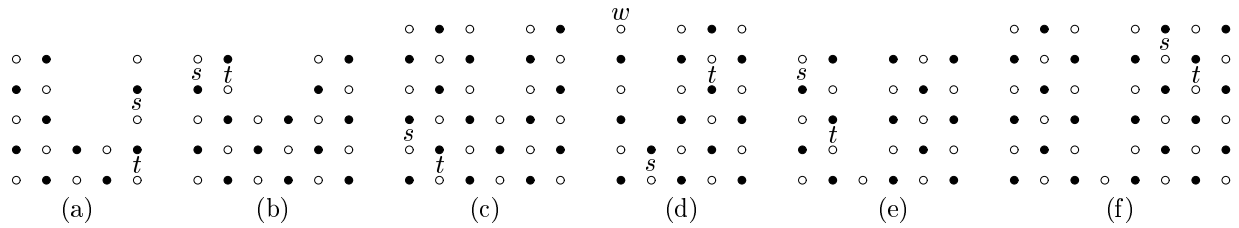

Figure 7. The C -shaped grid graphs in which there is no Hamiltonian (s, t) -path.

Lemma 3.1. [14] *Let G be any grid graph. Let s and t be two given vertices of G such that (G, s, t) is color-compatible. If we can partition (G, s, t) into n subgraphs $G_1, G_2, \dots, G_{n-1}, G_n$ such that $s, t \in G_n$ and in $V(G_1 \cup G_2 \cup \dots \cup G_{n-1})$ the number of white and black vertices are equal, then (G_n, s, t) is color-compatible.*

Because $C(m, n, k, l)$ is bipartite, colors of vertices of any path must alternate between black and white. Hence, the color-compatibility of s and t in $C(m, n, k, l)$ is a necessary condition for $(C(m, n, k, l), s, t)$ to be Hamiltonian. Besides, in addition to conditions (F1) and (F3) (as shown in Fig. 7(a)-(d)) whenever one of the following conditions holds then $(C(m, n, k, l), s, t)$ has no Hamiltonian (s, t) -path.

(F10) $n - l = 1, c, d > 1$, and

- (i) $s_x, t_x \leq d$ or $s_x, t_x > d + k$ (Fig. 7(e) and 7(f)); or
- (ii) Let $C(m, n, k, l)$ be even-sized, and let $\{G_1, G_2\}$ be a vertical separation of $C(m, n, k, l)$ such that $G_1 = L(m', n, k, l)$, where $m' = d + k$, $G_2 = R(m - m', n)$ (as shown Fig. 8(a)), and exactly a vertex w is in G_1 that is connected to G_2 . Let $z \in G_2$ such that w and z are adjacent. And $s \in G_1, t \in G_2$, and (G_1, s, w) or (G_2, z, t) is not acceptable (Fig. 8(a)).

(F11) $n - l > 1$ and $[(d = 1, c > 1, \text{ and } s = (1, 1)) \text{ or } (d > 1, c = 1, \text{ and } t = (m, 1))]$. Let $\{G_1, G_2\}$ be L -shaped separation (type I) of $C(m, n, k, l)$ such that $G_1 = R(m', l), G_2 = L(m, n, k', l), m' = d$ if $d = 1$; otherwise $m' = c$,

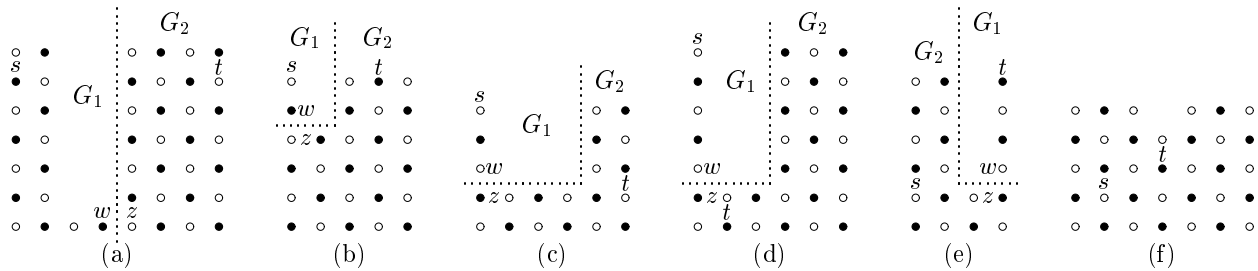

Figure 8. The C -shaped grid graphs in which there is no Hamiltonian (s, t) -path.

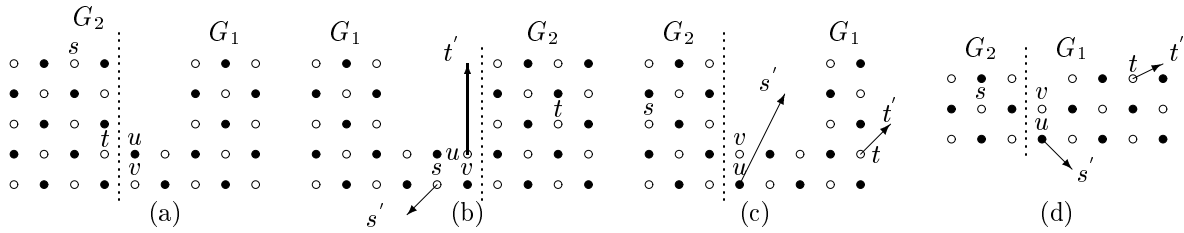

Figure 9. The C -shaped grid graphs in which there is no Hamiltonian (s, t) -path.

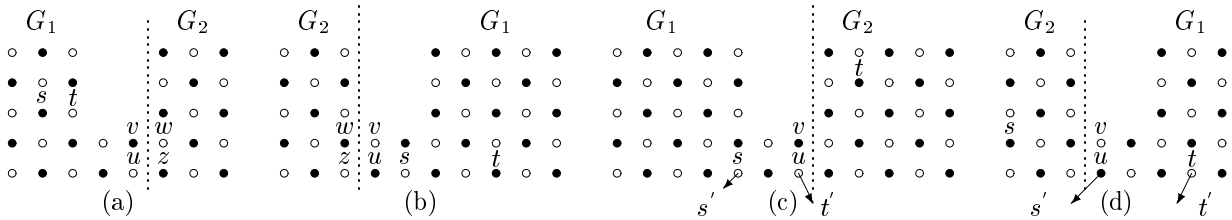

Figure 10. The C -shaped grid graphs in which there is no Hamiltonian (s, t) -path.

and $k' = k + m'$. Let exactly a vertex w be in G_1 that is connected to G_2 and let $z \in G_2$ such that w and z are adjacent. And one of the following cases occurs:

- (i) $d = 1, t \in G_2$, and (G_2, z, t) is not acceptable (Fig. 8(b)-(d)); or
- (ii) $c = 1, s \in G_2$, and (G_2, s, z) is not acceptable (Fig. 8(e)).

(F12) $R(m, n)$ is odd \times odd with white majority color and $R(k, l)$ is odd \times odd with black majority color (Fig. 8(f)).

(F13) $n = \text{odd}, n - l = 2$, and $d, c > 1$. Let $\{G_1, G_2\}$ be a vertical separation of $C(m, n, k, l)$ such that $G_1 = L(m', n, k, l)$, $G_2 = R(m - m', n)$, and $m' = d + k$ (or $G_1 = L(m - m', n, k, l)$, $G_2 = R(m', n)$, and $m' = d$). Let exactly two vertices u and v be in G_1 that are connected to G_2 . And one of the following cases occurs

- (a) $C(m, n, k, l)$ is odd-sized and
 - (a₁) G_1 is odd-sized, G_2 is even-sized, and
 - (a₁₁) $s, t \in G_2$ (see Fig. 9(a)); or
 - (a₁₂) $s \in G_1, t \in G_2, s' = s, t' = u$ (or $t \in G_1, s \in G_2, t' = t, s' = u$), and (G_1, s', t') satisfies condition (F1) (i.e., $\{s', t'\}$ is a vertex cut) (see Fig. 9(b)).
 - (a₂) m is even, G_1 is even-sized, G_2 is odd-sized, $s \in G_1, t \in G_2, s' = s, t' = u$ (or $t \in G_1, s \in G_2, t' = t, s' = u$), and (G_1, s', t') satisfies condition (F6) or (F8) (see Fig. 9(c) and 9(d)).
- (b) $C(m, n, k, l)$ is even-sized, $d = \text{odd}, c = \text{odd}$, and
 - (b₁) $s, t \in G_1$ (see Fig. 10(a) and 10(b)); or
 - (b₂) $s_x \leq d, t_x > d + k, s' = s, t' = u$ (or $s' = u, t' = t$), and (G_1, s', t') is not acceptable (see Fig. 10(c) and 10(d)).

(F14) $n = \text{odd}, n - l > 2$, [$(d = \text{odd} > 1$ and $c = 2)$ or $(d = 2$ and $c = \text{odd} > 1)$], and [$(C(m, n, k, l)$ is odd-sized) or $(m = \text{even}$ and $k \times l = \text{odd} \times \text{even})$]. Let $\{G_1, G_2\}$ be a L -shaped separation (type I) of $C(m, n, k, l)$ such that $G_1 = L(m, n, k', l)$, where $k' = m - d$ or $k' = m - c$, $G_2 = R(2, l)$ (see Fig. 11), and exactly two vertices u and v are in G_1 that are connected to G_2 . And one of the following cases occurs

- (a) $C(m, n, k, l)$ is odd-sized, [$(m = \text{even})$ or $(m = \text{odd}$ and $k = \text{even})$], and
 - (a₁) $s, t \in G_2$ (see Fig. 11(a)); or

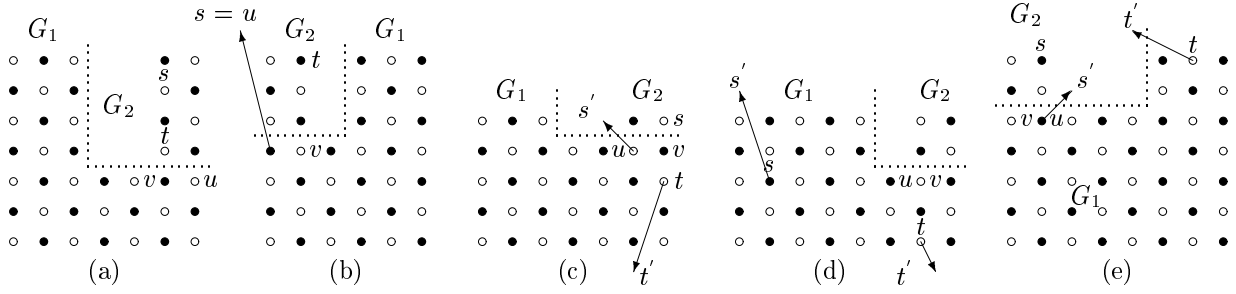

Figure 11. The C -shaped grid graphs in which there is no Hamiltonian (s, t) -path.

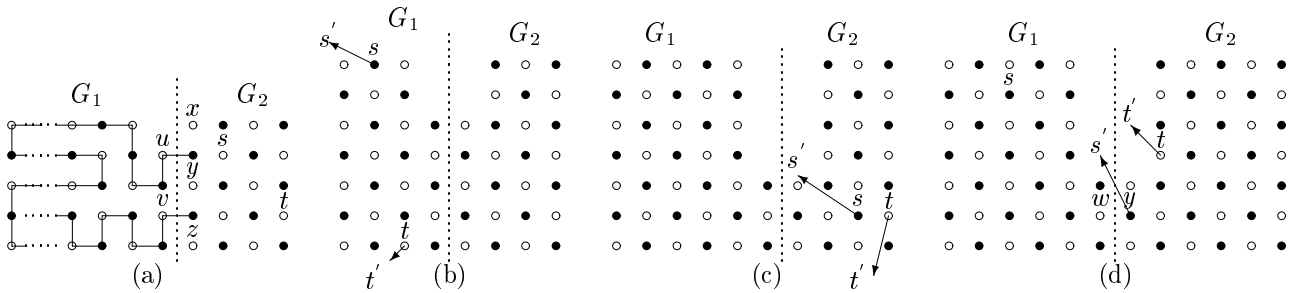

Figure 12. The C -shaped grid graphs in which there is no Hamiltonian (s, t) -path.

- (a₂) $s = u$ and $t \in G_2$ (or $s \in G_2$ and $t = u$) (see Fig. 11(b)); or
 - (a₃) $m = \text{odd}, l = \text{odd}, s \in G_1, t \in G_2, s' = s, t' = u$ (or $t \in G_1, s \in G_2, t' = t, s' = u$) and (G_1, s', t') satisfies condition (F1) (that is, $\{s', t'\}$ is a vertex cut) (see Fig. 11(c)),
 - (b) $C(m, n, k, l)$ is even-sized, $s' = s, t' = t$, if s' (or t') $\notin G_1$ then $s' = u$ (or $t' = u$), and (G_1, s', t') satisfies condition (F9) (see Fig. 11(d) and 11(e)).
- (F15) $C(m, n, k, l)$ is odd-sized, $m = \text{even}, n = \text{odd}, n - l = 4$, and
- (i) $d = \text{odd} > 1$, [$(l = 1$ and $c = \text{even} \geq 4)$ or $(s_y, t_y > l$ and $c = 2)$], and $s_x, t_x > d + k + 1$ (Fig. 12(a)); or
 - (ii) $c = \text{odd} > 1$, [$(l = 1$ and $d = \text{even} \geq 4)$ or $(s_y, t_y > l$ and $d = 2)$], and $s_x, t_x < d$.
- (F16) $C(m, n, k, l)$ is even-sized, $m \times n = \text{even} \times \text{odd}, c = \text{odd} > 1, d = \text{odd} > 1$, and $n - l = \text{odd} > 1$. Assume that $\{G_1, G_2\}$ is a vertical separation of $C(m, n, k, l)$ such that $G_1 = L(m', n, k', l)$, where $m' = d + 1$ and $k' = m' - d$, $G_2 = L(m - m', n, k'', l)$, where $k'' = k - k'$ (see Fig. 12(b)-(d)), and at least three vertices u, w and v are in G_1 that are connected to G_2 . Let $y \in G_2$ such that w and y are adjacent. And ($s' = s$ and $t' = w$, if $t \in G_1$ let $t' = t$) or ($s' = y$ and $t' = t$, if $s \in G_2$ let $s' = s$), and (G_1, s', t') or (G_2, s', t') satisfies condition (F9).
- (F17) $n - l \geq 2, d, c > 1$ and [$(C(m, n, k, l)$ is odd-sized and [$(n = \text{even})$ or $(n = \text{odd}$ and [$(m = \text{even})$ or $(m = \text{odd}$ and [$k \times l = \text{odd} \times \text{even}$ or $\text{even} \times \text{odd}$])])]) or $(C(m, n, k, l)$ is even-sized and [$(m \times n = \text{odd} \times \text{odd}), (n = \text{even}),$ or $(m \times n = \text{even} \times \text{odd}$ and [$(c$ and d are even), $(c = \text{even} \geq 4$ and $d = \text{odd})$, or $(c = \text{odd}$ and $d = \text{even} \geq 4)$])])]. Let $\{G_1, G_2\}$ be a vertical separation of $C(m, n, k, l)$ such that $G_1 = L(m', n, k, l), G_2 = R(m - m', n), m' = d + k$ (or $G_1 = L(m - m', n, k, l), G_2 = R(m', n), m' = d$), G_2 is even-sized, and at least two vertices v and u are in G_1 which are connected to G_2 . If $C(m, n, k, l)$ is even-sized, $k = 1$, and $n - l = \text{even} \geq 4$, then let $m' - k > 2$ (or $m - m' - k > 2$) in G_1 . And $s' = s, t' = t$, if s' (or t') $\notin G_1$ then $s' = u$ (or $t' = u$), and (G_1, s', t') satisfies one of the conditions (F5), (F6), (F7), (F8), or (F9) (Fig. 13, 14, and 15).
- (F18) $C(m, n, k, l)$ is even-sized, $n = \text{odd}, d = \text{odd} > 1, c = \text{odd} > 1, n - l = \text{even} \geq 4$, and one of the following cases occurs

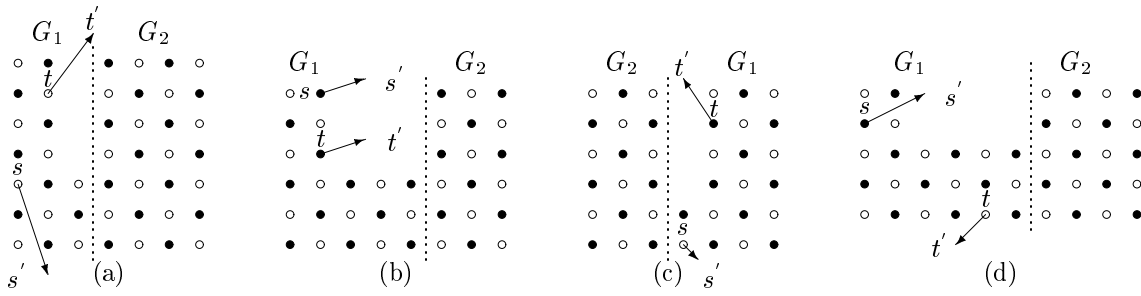

Figure 13. The C -shaped grid graphs in which there is no Hamiltonian (s, t) -path.

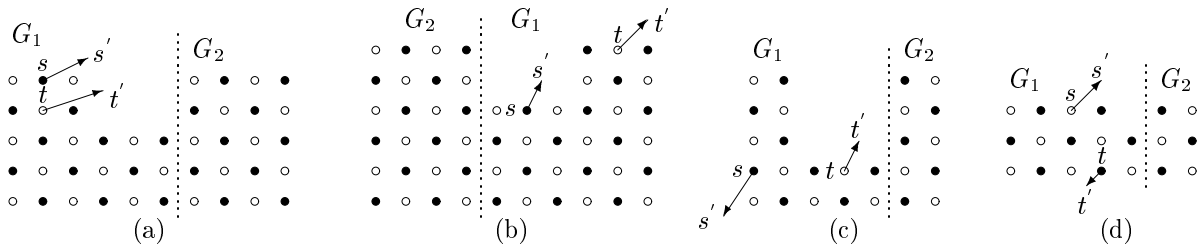

Figure 14. The C -shaped grid graphs in which there is no Hamiltonian (s, t) -path.

- (a) Let $\{G_1, G_2\}$ be a L -shaped separation (type I) of $C(m, n, k, l)$ such that G_1 is an even-sized rectangular grid subgraph with $V(G_1) = \{1 \leq x \leq d \text{ (or } d + k + 1 \leq x \leq m) \text{ and } 1 \leq y \leq l + 1\}$, G_2 is an even-sized solid grid subgraph (see Fig. 16(a) and 16(b)), and exactly three vertices v , w , and u are in G_1 that are connected to G_2 . And $s' = s, t' = t$, if s' (or t') $\notin G_1$ then $s' = w$ (or $t' = w$), and (G_1, s', t') satisfies condition (F2); or
- (b) $n - l = 4$ and
 - (b₁) $s_y, t_y > l + 1$ and $[(d = 3, s_x, t_x \leq d, s = (1, n - 1), \text{ and } t_x > s_x) \text{ or } (c = 3, s_x, t_x > d + k, s_x < t_x, \text{ and } t = (m, n - 1))]$ (Fig. 16(c), 16(d), and 17(a)); or
 - (b₂) s is black and $[(s_x \leq d \text{ and } t_x > d) \text{ or } (d + 1 \leq s_x \leq d + k \text{ and } t_x > d + k)]$ (Fig. 17(b) and 17(c)); or
 - (b₃) $d + 1 \leq s_x, t_x \leq d + k$ and $[(t_x > s_x \text{ and } s \text{ is black}) \text{ or } (s_x = t_x, s_y \text{ (or } t_y) = l + 2, \text{ and } t_y \text{ (or } s_y) = l + 3)]$ (Fig. 17(d) and 18).

The following results directly follows from conditions (F1), (F3), and (F10)-(F18).

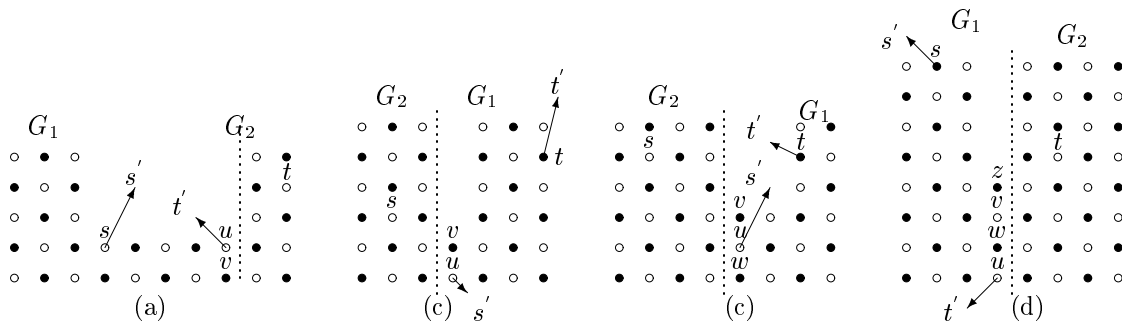

Figure 15. The C -shaped grid graphs in which there is no Hamiltonian (s, t) -path.

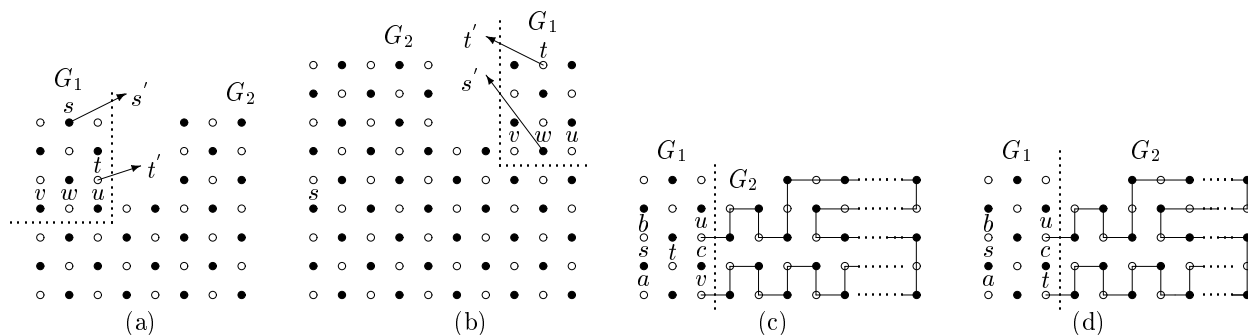

Figure 16. The C-shaped grid graphs in which there is no Hamiltonian (s, t) -path.

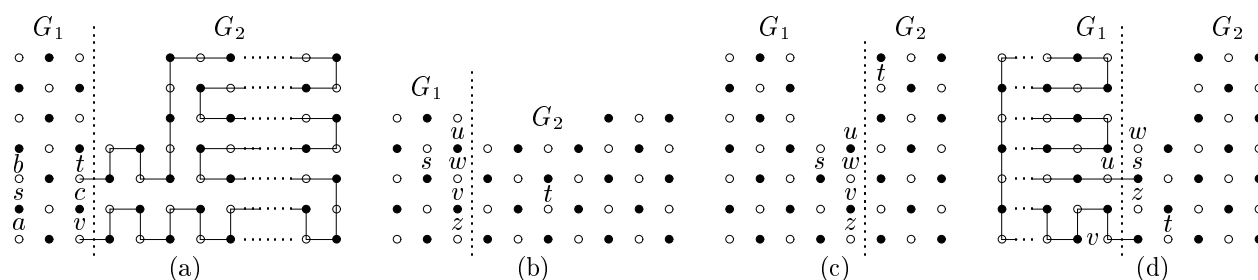

Figure 17. The C-shaped grid graphs in which there is no Hamiltonian (s, t) -path.

Corollary 3.2. Suppose that $C(m, n, k, l)$ is a C-shaped grid graph with two given vertices s and t . Let $\{G_1, G_2\}$ be a vertical (or L-shaped (type I)) separation of $C(m, n, k, l)$ such that G_1 is a L-shaped grid subgraph, G_2 is a rectangular grid subgraph, and $s, t \in G_1$. If $(C(m, n, k, l), s, t)$ is not acceptable, then (G_1, s, t) is not acceptable.

Definition 3.2. A C-shaped Hamiltonian path problem $(C(m, n, k, l), s, t)$ is acceptable if it is color-compatible and $(C(m, n, k, l), s, t)$ does not satisfy any of conditions (F1), (F3), and (F10)-(F18).

We define the length of a path in a grid graph be the number of vertices of the path. In any grid graph, the length of any path between two same-colored vertices is odd and the length of any path between two different-colored vertices is even.

Theorem 3.3. Let $C(m, n, k, l)$ be a C-shaped grid graph and s and t be two distinct vertices of it. If $(C(m, n, k, l), s, t)$ is Hamiltonian, then $(C(m, n, k, l), s, t)$ is acceptable.

Proof. Arguing by contrapositive, Suppose $(C(m, n, k, l), s, t)$ is not acceptable, then $(C(m, n, k, l), s, t)$ has no Hamiltonian (s, t) -path. Clearly, if $(C(m, n, k, l), s, t)$ is not color-compatible then $(C(m, n, k, l), s, t)$ has not Hamiltonian

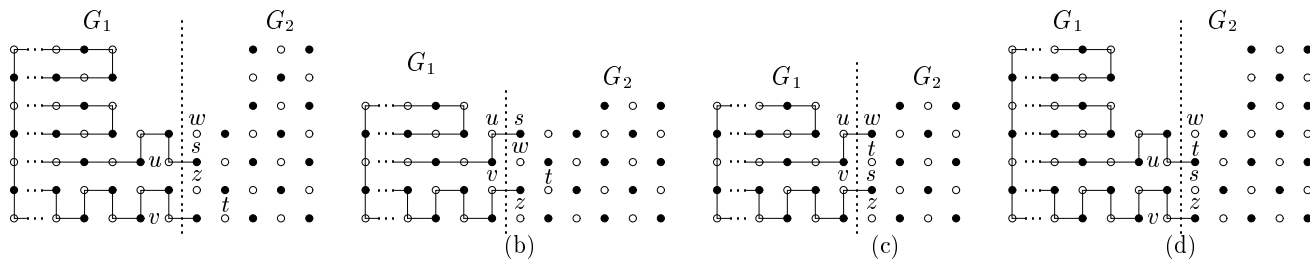

Figure 18. The C-shaped grid graphs in which there is no Hamiltonian (s, t) -path.

(s, t) –path. Thus, without loss of generality, suppose $(C(m, n, k, l), s, t)$ is color-compatible. In the following, we will show that if one of the conditions (F1), (F3), and (F10)–(F18) holds, then $(C(m, n, k, l), s, t)$ has no Hamiltonian (s, t) –path.

(F1) and (F3): See Fig. 7(a)–(d).

(F10): (i) Consider Fig. 7(e) and 7(f). Since $n - l = 1$, we can easily see that there is no Hamiltonian path in $C(m, n, k, l)$.

(ii) Consider Fig. 8(a). Since $n - l = 1$, then the Hamiltonian path P of $C(m, n, k, l)$ which starts from s must pass through all the vertices of G_1 , and leaves G_1 at w , then enter to G_2 at z , and end at t . Clearly, if (G_1, s, w) or (G_2, z, t) is not acceptable, then by Theorem 2.3 or 2.1, (G_1, s, w) or (G_2, z, t) has no Hamiltonian path, respectively, and hence $(C(m, n, k, l), s, t)$ has no Hamiltonian (s, t) –path.

(F11). The proof is a straightforward; see Fig. 8(b)–(e).

(F12): Consider Fig. 8(f). Notice that, here, $C(m, n, k, l)$ is even-sized and the number of vertices with white color is two more than the number of vertices with black color. Since $C(m, n, k, l)$ is even-sized and colors of vertices of any path must alternate between black and white, it is clear that two vertices with white color remain out of the path, and hence $C(m, n, k, l)$ has no Hamiltonian (s, t) –path.

(F13): (a₁₁) and (b₁) Consider Fig. 9(a), 10(a), and 10(b). Clearly, since $n - l = 2$, the Hamiltonian path P must enter to G_1 (resp. G_2 , where $C(m, n, k, l)$ is odd-sized) through one of the vertices u (or v) (resp. w (or z)) then the path P leaves G_1 (resp. G_2) after visiting the vertices of G_1 by v (or u) (resp. G_2 by z (or w)). It is clear that (G_1, v, u) (resp. (G_2, w, z)) is not acceptable, because G_1 (resp. G_2) is odd-sized and v and u (resp. w and z) have different colors. Thus by Theorem 2.3, (G_1, u, v) (resp. (G_2, w, z)) does not have any Hamiltonian (u, v) –path (resp. (w, z) –path). Hence, $(C(m, n, k, l), s, t)$ has no Hamiltonian (s, t) –path.

(a₁₂), (a₂), and (b₂) Consider Fig. 9(b)–(d), 10(c), and 10(d). Since $n - l = 2$, the Hamiltonian path P of $C(m, n, k, l)$ which starts from s must pass through all the vertices of G_1 (or G_2), leave G_1 at one of the vertices v or u (or leave G_2), then enter to G_2 (enter to G_1) and pass through all the vertices of G_2 (or G_1) and end at t . Clearly, if (G_1, s', t') is not acceptable then by Theorem 2.3 (G_1, s', t') has no Hamiltonian path, and hence $(C(m, n, k, l), s, t)$ has no Hamiltonian (s, t) –path.

(F14): (a) Like in the proof of condition (F13), we can obtain that $(C(m, n, k, l), s, t)$ has no Hamiltonian path (see Fig. 11(a)–(c)).

(b) Since G_2 is connected to G_1 by two vertices v and u , using the same argument as in the proof [[14], Theorem 3.2, condition (F8)], it can be proved that $C(m, n, k, l)$ does not have any Hamiltonian (s, t) –path (see Fig. 11(d) and 11(e)). Note that, here, G_1 is a L –shaped grid subgraph.

(F15): Suppose that $c = \text{even}$. Consider Fig. 12(a). Let $\{G_1, G_2\}$ be a vertical separation of $C(m, n, k, l)$ such that $G_1 = L(m', n, k, l)$, $G_2 = R(m - m', n)$, and $m' = d + k$. Since $c = \text{even}$, thus G_2 is even-sized. Moreover, since $C(m, n, k, l)$ is odd-sized, we conclude that G_1 is odd-sized. Since G_1 is odd-sized and $n - l = 4$, a Hamiltonian path P of $C(m, n, k, l)$ that starts from s must be enter to G_1 for the first time through one of the vertices u (or v) then pass through all the vertices of G_1 and leave G_1 at v (or u) and end at t . Clearly in this case, if $s_x, t_x > d + k + 1$, then one of the three vertices x, y , or z remains out of the path. By symmetry, the result follows, if $d = \text{even}$.

(F16): By condition (F9), the proof is Straightforward (as shown in Fig. 12(b)–(d)).

(F17): This follows immediately from conditions (F5)–(F9); see Fig. 13, 14, and 15.

(F18): (a) Since G_1 is connected to G_2 by three vertices v, w and u , in a similar manner as in the proof [[14], Theorem 3.2, condition (F9)], we derive $C(m, n, k, l)$ does not have any Hamiltonian (s, t) –path (see Fig. 16(a) and 16(b)).

(b₁) We shall only prove the first case ($s_x, t_x \leq d$). The other case ($s_x, t_x > d + k$) is similar. Consider Fig. 16(c), 16(d), and 17(a). Let $\{G_1, G_2\}$ be a vertical separation (type I) of $C(m, n, k, l)$ such that $G_1 = R(m', n)$, $G_2 = L(m - m', n, k, l)$, $m' = d$ and $s, t \in G_1$. Let $u = (d, l + 2)$ and $v = (d, n)$. Notice that, here, G_1 and G_2 are odd-sized. Since $n - l = 4$ and G_2 is odd-sized, thus the Hamiltonian path P of $C(m, n, k, l)$ which starts from s should pass through some vertices of G_1 , leaves G_1 at u (or v), then passes through all the vertices of G_2 and reenters to G_1 at v (or u), and passes through all the remaining vertices of G_1 and ends at t . A simple check shows that one of the three vertices a, b , and c remains out of path P .

(b₂) Consider Fig. 17(b) and 17(c). Let $\{G_1, G_2\}$ be a vertical separation of $C(m, n, k, l)$ such that $G_1 = R(m', n)$, $G_2 = L(m - m', n, k, l)$, where $m' = d$ and $s_x \leq d$, or $G_1 = L(m', n, k, l)$ and $G_2 = R(m - m', n)$, where $m' = d + k$ and

$d + 1 \leq s_x \leq d + k$, $s \in G_1$, and $t \in G_2$. Note that, in this case, G_1 is odd-sized with white majority color and G_2 is odd-sized with black majority color. The following cases may be considered.

Case 1. The Hamiltonian path P of $C(m, n, k, l)$ which starts from s should pass through all the vertices of G_1 , leaves G_1 at w (or z) (or v (or u)), enters G_2 , and passes through all the vertices of G_1 , and ends at t . This is impossible, (G_1, s, t') is not acceptable, where t' is w, z, v , or u .

Case 2. The Hamiltonian path P of $C(m, n, k, l)$ which starts from s should pass through some vertices of G_1 , leaves G_1 at w (or z) (or v (or u)), enters G_2 , then passes through some vertices of G_2 ,

1. reenters to G_1 at z (or w) (or u (or v)), passes through all the remaining vertices of it, leaves it at u (or v) (or w (or z)), and passes through all the remaining vertices of G_2 and finally ends at t . In this case, two subpaths of P which are in G_1 are called P_1 and P_2 , P_1 from s to w (or z) (or v (or u)) and P_2 from z (or w) (or u (or v)) to u (or v) (or w (or z)). This is impossible, because the size of P_1 is even (or odd) and the size of P_2 is even, then $|P_1 + P_2|$ is even (or odd with black majority color) while G_1 is odd-sized with white majority color.
2. reenters to G_1 at u (or v) (or w (or z)), passes through all the remaining vertices of it, leaves it at z (or w) (or u (or v)), and passes through all the remaining vertices of G_2 and finally ends at t . In this case, P_2 from u (or v) (or w (or z)) to z (or w) (or u (or v)). This is impossible, because the size of P_1 is even (or odd) and the size of P_2 is even, then $|P_1 + P_2|$ is even (or odd with black majority color) while G_1 is odd-sized with white majority color.
3. reenters to G_1 at u (or v) (or w (or z)), passes through all the remaining vertices of it, leaves it at v (or u) (or z (or w)), and passes through all the remaining vertices of G_2 and finally ends at t . In this case, P_2 from u to v (or v to u) (or w to z (or z to w)). This is impossible, because the size of P_1 is even (or odd) and the size of P_2 is odd, then $|P_1 + P_2|$ is odd with black majority color (or even) while G_1 is odd-sized with white majority color.

(b₃) Let $\{G_1, G_2\}$ be a vertical separation of $C(m, n, k, l)$ such that $G_1 = R(m', n)$ and $G_2 = L(m - m', n, k, l)$ (or $G_1 = L_1(m', n, k', l)$ and $G_2 = L_2(m - m', n, k'', l)$) $m' = s_x - 1$, $k' = m' - d$, $k'' = k - k'$, and $s, t \in G_2$. Let $u, v \in G_1$ such that $u_y, v_y > l$, $v_x = u_x = m' - 1$, $u_y, v_y = \text{odd}$ if $s_x = \text{even}$; otherwise $u_y, v_y = \text{even}$. Consider Fig. 17(d) and 18. Note that G_1 is an odd sized grid subgraph with white majority color. The Hamiltonian path P of $C(m, n, k, l)$ must enter to G_1 through one of the vertices v (or u), then the path P leaves G_1 after visiting all the vertices G_1 by u (or v), reenters to G_2 , and ends at t . One easily check that one of the vertices w or z remains out of path. \square

4. Sufficient conditions

Suppose $(C(m, n, k, l), s, t)$ is an acceptable Hamiltonian path problem. The purpose of this section is to prove that all acceptable C-shaped Hamiltonian path problems have solutions.

Definition 4.1. A separation is *acceptable* if all of its component are acceptable.

Definition 4.2. Two nonincident edges (u_1, v_1) and (u_2, v_2) are *parallel*, if u_1 (resp. v_1) is adjacent to u_2 and v_1 (resp. u_1) is adjacent to v_2 .

The following three lemmas discuss how to construct a Hamiltonian (s, t) -path for $C(m, n, k, l)$.

Lemma 4.1. Suppose that $(C(m, n, k, l), s, t)$ is an acceptable Hamiltonian path problem. Let $C(m, n, k, l)$ be even-sized. Then there is an acceptable separation for $(C(m, n, k, l), s, t)$ and it has a Hamiltonian path.

Proof. Here, s and t have different colors. Let $m = \text{even}$ (resp. $m = \text{odd}$) and $k = \text{even}$ (resp. $k = \text{odd}$), then d and c are even (or odd). Similarly let $m = \text{even}$ (resp. $m = \text{odd}$) and $k = \text{odd}$ (resp. $k = \text{even}$), then $d = \text{even}$ and $c = \text{odd}$ or $d = \text{odd}$ and $c = \text{even}$. Notice that, for $m \times n = \text{odd} \times \text{odd}$, since $(C(m, n, k, l), s, t)$ is acceptable, d and c must be even. We have the following five cases.

Case 1. $n - l > 1$, $[(c > 1 \text{ and } s_x, t_x \leq d + k) \text{ or } (d > 1 \text{ and } [(s_x, t_x > d + k) \text{ or } (d + 1 \leq s_x \leq d + k \text{ and } t_x > d + k))]$, and

(a) $n = \text{even}$ and $[(k = 1 \text{ and } [(n - l = 2) \text{ or } (n - l = \text{even} \geq 4 \text{ and } d' \neq 2)]] \text{ or } (k > 1)]$, where $d' = d$ if $s_x, t_x \leq d + k$; otherwise $d' = c$; or

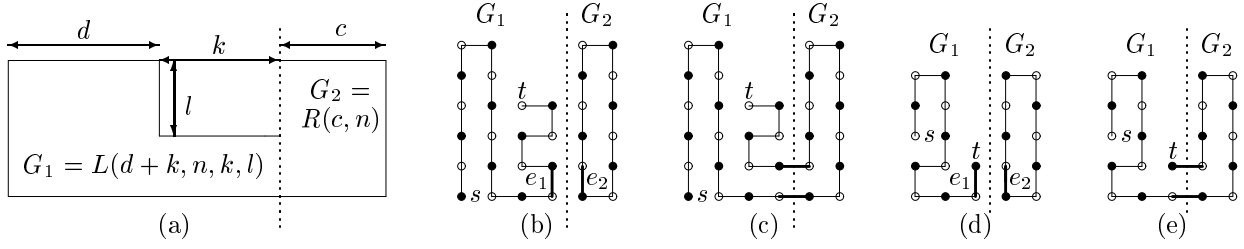
Figure 19. A vertical separation of $C(m, n, k, l)$ and a Hamiltonian path in $(C(m, n, k, l), s, t)$.

(b) $n = \text{odd}$ and $[(m = \text{odd} \text{ and } [(k = 1 \text{ and } n - l = 2) \text{ or } (k > 1)]) \text{ or } (m = \text{even}, d = \text{even}, \text{ and } c = \text{even})]$.

Let $s_x, t_x \leq d + k$. By symmetry, the result follows, if $(s_x, t_x > d + k)$ or $(d + 1 \leq s_x \leq d + k \text{ and } t_x > d + k)$. Let $\{G_1, G_2\}$ be a vertical separation of $C(m, n, k, l)$ such that $G_1 = L(m', n, k, l)$, $G_2 = R(m - m', n)$, $m' = d + k$, and $s, t \in G_1$ (Fig. 19(a)). First, we prove that (G_1, s, t) is acceptable. Since $n = \text{even}$ or $c = \text{even}$, it follows that G_2 is even-sized. Moreover, since $C(m, n, k, l)$ is even-sized, we conclude that G_1 is even-sized. By Lemma 3.1, (G_1, s, t) is color-compatible. In the following, we show that (G_1, s, t) is not in conditions (F1), (F3), (F4), and (F6)-(F9). The condition (F1) holds, if (i) $d = 1$ and $2 \leq s_y$ (or t_y) $\leq l + 1$; (ii) $d = 2$ and $2 \leq s_y = t_y \leq l + 1$; or (iii) $(n - l = 2$ or $n = 2)$ and $2 \leq s_x = t_x \leq d + k$, clearly if these cases occur, then $(C(m, n, k, l), s, t)$ is in condition (F1), a contradiction. Therefore, (G_1, s, t) is not in condition (F1). To satisfy condition (F3), d must be 1 and $s_y, t_y > l$. If this case holds, then $(C(m, n, k, l), s, t)$ satisfies condition (F3), a contradiction. Thus, it follows that (G_1, s, t) does not satisfy condition (F3). The condition (F4) holds, if $m \times n = \text{odd} \times \text{odd}$, $k \times l = 1$, $n - l > 2$, and $m' - k > 2$. Since $n - l = 2$, where $k = 1$, thus (G_1, s, t) does not satisfy condition (F4). If (G_1, s, t) satisfies condition (F6), (F8), or (F9), then $(C(m, n, k, l), s, t)$ satisfies condition (F17), a contradicting the assumption. Therefore, it follows that (G_1, s, t) is not in condition (F6), (F8), and (F9). The condition (F7) holds, if $k = 1$, $d = 2$, $n - l = \text{even} \geq 4$, $s = (1, l + 1)$, and $t = (d + k, l + 2)$. This is impossible, because of $n - l = 2$, and hence (G_1, s, t) is not in condition (F7). Therefore, (G_1, s, t) is acceptable.

Now, we show that $(C(m, n, k, l), s, t)$ has a Hamiltonian path. Since (G_1, s, t) is acceptable, by Theorem 2.3 it has a Hamiltonian (s, t) -path. Thus, we construct a Hamiltonian path in (G_1, s, t) by the algorithm in [14]. Furthermore, since G_2 is even-sized, it has a Hamiltonian cycle by Lemma 2.2. Then by combining Hamiltonian cycle and path using two parallel edges e_1 and e_2 (Fig. 19(b) and 19(d)), a Hamiltonian (s, t) -path for $(C(m, n, k, l), s, t)$ is obtained, as shown in Fig. 19(c) and 19(e). Now, we describe combining a Hamiltonian path in (G_1, s, t) with the constructed cycle in G_2 . Any Hamiltonian path P in G_1 contains all the vertices of G_1 . Therefore, P should contain a boundary edge of G_1 that has a parallel edge in G_2 . Moreover, since $n - l > 1$, it is easy to check that there is at least one edge for combining Hamiltonian cycle and path.

Case 2. $n - l = \text{even} \geq 4$, $k = 1$ and

(a) $c > 1$, $s_x, t_x \leq d + k$, and $[(n = \text{even} \text{ and } d = 2) \text{ or } (n = \text{odd} \text{ and } [(l = 1 \text{ and } c = 2) \text{ or } (l = \text{odd} > 1 \text{ and } c \geq 2)])]$; or

(b) $d > 1$, $[(s_x, t_x > d + k) \text{ or } (d + 1 \leq s_x \leq d + k \text{ and } t_x > d + k)]$, and $[(n = \text{even} \text{ and } c = 2) \text{ or } (n = \text{odd} \text{ and } [(l = 1 \text{ and } d = 2) \text{ or } (l = \text{odd} > 1 \text{ and } d \geq 2)])]$.

Assume that $s_x, t_x \leq d + k$. By symmetry, the result follows, if $(s_x, t_x > d + k)$ or $(d + 1 \leq s_x \leq d + k \text{ and } t_x > d + k)$. Let $\{G_1, G_2\}$ be a L -shaped separation (type I) of $C(m, n, k, l)$ such that $G_1 = L(m, n, k', l)$ and $G_2 = R(m', n')$, $k' = m - d$, $m' = k' - k$, $n' = l$, and $s, t \in G_1$ (see Fig. 20(a)). In the following, we show that (G_1, s, t) is acceptable. Since $l = \text{even}$, where $n = \text{even}$, or $c = \text{even}$, where $n = \text{odd}$, thus G_2 is even-sized, and since $C(m, n, k, l)$ is even-sized, we conclude that G_1 is even-sized. By Lemma 3.1, (G_1, s, t) is color-compatible. Since $m - k' = \text{even}$, $k = 1$, and $c > 1$, we have $m \geq 5$ and $k' > 1$. Moreover, since $m \geq 5$, $m - k' = \text{even}$, $n - l = \text{even} \geq 4$, and $k' > 1$, it is obvious that (G_1, s, t) is not in conditions (F3), (F4), and (F6)-(F9). (G_1, s, t) is not in condition (F1), the proof is the same as Case 1. Therefore, (G_1, s, t) is acceptable. Now, we show that $(C(m, n, k, l), s, t)$ has a Hamiltonian path. Let $l > 1$, then the Hamiltonian path in $(C(m, n, k, l), s, t)$ is obtained similar to Case 1. Notice that since $m' \geq 2$, there exists at least one edge for combining Hamiltonian cycle and path. Now, let $l = 1$. In this case, G_2 is a one-rectangle, where $|G_2| = 2$. Let two vertices $v_1, v_2 \in G_2$ (Fig. 20(b)) and P be a Hamiltonian path in G_1 . Using algorithm in [14], there exists an edge e_1 such that $e_1 \in P$ is on the boundary of G_1 facing G_2 , as shown in Fig. 20(b). Thus, by merging (v_1, v_2) to this

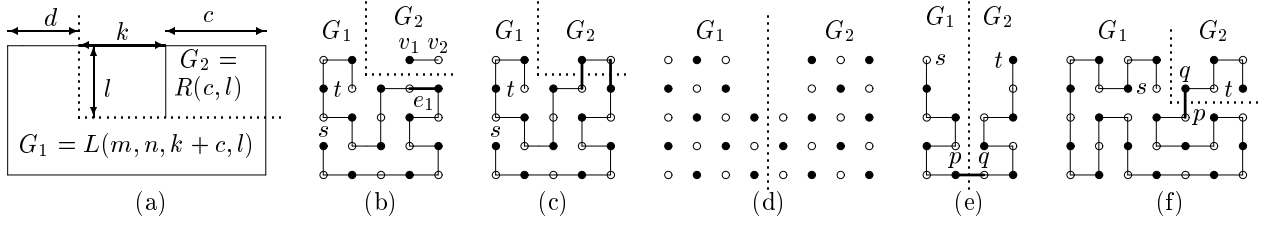

Figure 20. (a) A L -shaped separation of $C(m, n, k, l)$, (b) a Hamiltonian path in G_1 , (c) combine a Hamiltonian path in G_1 with edge (v_1, v_2) in G_2 , (d) a vertical separation of $C(m, n, k, l)$, (e) and (f) a Hamiltonian (s, t) -path in $C(m, n, k, l)$.

edge, we obtain a Hamiltonian path for $C(m, n, k, l)$ as shown in Fig. 20(c).

Case 3. $n = \text{odd}$, $m = \text{odd}$, $k \times l = 1$, $n - l = \text{even} \geq 4$, and $[(s_x, t_x \leq d + k \text{ and } c = \text{even} \geq 4) \text{ or } (d = \text{even} \geq 4 \text{ and } [(s_x, t_x > d + k) \text{ or } (d + 1 \leq s_x \leq d + k \text{ and } t_x > d + k)])]$. Suppose $s_x, t_x \leq d + k$. By symmetry, the result follows, if $(s_x, t_x > d + k) \text{ or } (d + 1 \leq s_x \leq d + k \text{ and } t_x > d + k)$. Let $\{G_1, G_2\}$ be a vertical separation of $C(m, n, k, l)$ such that $G_1 = C(m', n, k, l)$, $G_2 = R(m - m', n)$, $m' = d + k + 2$, and $s, t \in G_1$. We know that $d = \text{even}$ and $c = \text{even}$. Thus, $m - m' = \text{even}$, G_2 is even \times odd, and G_2 is even-sized. By Lemma 3.1, (G_1, s, t) is color-compatible. Since $n - l \geq 4$, $l = 1$, $d = \text{even}$, $k = 1$, and $c' = 2$ implies $m', n \geq 5$. Moreover, since $d = \text{even}$, $c' = 2$, $m', n \geq 5$, and $n - l \geq 4$, it suffices to prove (G_1, s, t) is not in condition (F1). A simple check shows that (G_1, s, t) is not in condition (F1). Now, we show that $(C(m, n, k, l), s, t)$ has a Hamiltonian path. In this case, (G_1, s, t) in Case 2. The Hamiltonian path in $(C(m, n, k, l), s, t)$ is obtained similar to Case 1. Notice that, since $n \geq 5$, there is at least one edge for combining Hamiltonian cycle and path.

Case 4. $n = \text{odd}$ and $[d = \text{odd} \text{ or } c = \text{odd}]$.

Subcase 4.1. $d = \text{odd}$, $c = \text{odd}$, and $n - l = \text{odd} > 1$.

Subcase 4.1.1. $(s_x, t_x \leq d + 1 \text{ and } c > 1) \text{ or } (s_x, t_x > d + 1 \text{ and } d > 1)$. This case is similar to Case 3, where $G_1 = L(m', n, k', l)$, $G_2 = L(m - m', n, k'', l)$, $m' = d + 1$, $k' = m' - d$, $k'' = k - k'$, and $[s, t \in G_1 \text{ or } s, t \in G_2]$. Consider Fig. 20(d). Clearly, G_1 and G_2 are even-sized. By Lemma 3.1, (G_1, s, t) (or (G_2, s, t)) is color-compatible. Note that, because of $n - l = \text{odd} > 1$ and $l = \text{even}$, we have $n > 3$. Moreover, since d, c , and $n - l$ are odd and $n > 3$, it suffices to prove (G_1, s, t) (or (G_2, s, t)) is not in conditions (F1), (F3), and (F9). (G_1, s, t) (or (G_2, s, t)) does not satisfy conditions (F1) and (F3), the proof is the same as Case 1. If (G_1, s, t) (or (G_2, s, t)) satisfies condition (F9), then $(C(m, n, k, l), s, t)$ satisfies condition (F16), we have a contradiction. Thus (G_1, s, t) (or (G_2, s, t)) does not satisfy condition (F9). Hence (G_1, s, t) (or (G_2, s, t)) is acceptable. The Hamiltonian path in $(C(m, n, k, l), s, t)$ is obtained similar to Case 1. In this case, G_2 (or G_1) is an even-sized L -shaped grid graph, thus it has a Hamiltonian cycle by Lemma 2.5.

Subcase 4.1.2. $s_x \leq d + 1$ and $t_x > d + 1$. This case is the same as Subcase 4.1.1, where $s, p \in G_1$, $q, t \in G_2$, p and q are adjacent, and $p = (m', n)$ if s is white; otherwise $p = (m', n - 1)$. Consider Fig. 20(d). A simple check shows that (G_1, s, p) and (G_2, q, t) are color-compatible. By the same argument as in the proof of Subcase 4.1.1, it is sufficient to show that (G_1, s, p) and (G_2, q, t) are not in conditions (F1), (F3), and (F9). The condition (F1) occurs, when $s_y, t_y \leq l + 1$ and $[(d = 1 \text{ and } s \neq (1, 1)) \text{ or } (c = 1 \text{ and } t \neq (m, 1))]$. If this case holds, then $(C(m, n, k, l), s, t)$ satisfies condition (F1), a contradiction. Thus, (G_1, s, p) is not in condition (F1). The condition (F3) holds, if $s_y, t_y > l$ and $[(d = 1) \text{ or } (c = 1)]$. It is obvious that if this case holds, then $(C(m, n, k, l), s, t)$ satisfies condition (F3), a contradiction. Therefore, (G_1, s, p) does not satisfy condition (F3). (G_1, s, p) and (G_2, q, t) do not satisfy condition (F9), the proof is similar to Subcase 4.1.1. Hence, (G_1, s, p) and (G_2, q, t) are acceptable. Now, we show that $(C(m, n, k, l), s, t)$ has a Hamiltonian. Since (G_1, s, p) and (G_2, q, t) are acceptable, by Theorem 2.3 have Hamiltonian paths. Thus, we construct Hamiltonian paths in (G_1, s, p) and (G_2, q, t) by the algorithm in [14]. Then the Hamiltonian path for $(C(m, n, k, l), s, t)$ can be obtained by connecting two vertices p and q as shown in Fig. 20(e).

Subcase 4.2. $n - l = \text{odd} > 1$, $[(d = \text{odd} \text{ and } c = \text{even}) \text{ or } (d = \text{even} \text{ and } c = \text{odd})]$, and $[(s_x, t_x \leq d + k \text{ and } c > 1) \text{ or } (d > 1 \text{ and } [(s_x, t_x > d + k) \text{ or } (d + 1 \leq s_x \leq d + k \text{ and } t_x > d + k)])]$. Since $l = \text{even}$ and $n - l = \text{odd} > 1$, we have $n \geq 5$. Let $d = \text{odd}$ and $c = \text{even}$. By symmetry, the result follows, if $d = \text{even}$ and $c = \text{odd}$. Consider the following subcases.

Subcase 4.2.1. $s_x, t_x \leq d + k$. This case is similar to Case 1.

Subcase 4.2.2. $(s_x, t_x > d + k)$ or $(d + 1 \leq s_x \leq d + k$ and $t_x > d + k)$. Since $d = \text{odd} > 1$, $c = \text{even}$, and $k \geq 1$, it follows that $m \geq 6$. This case is similar to Case 2. Since $l = \text{even}$, thus G_2 is even-sized. Moreover, since $C(m, n, k, l)$ is even-sized, we conclude that G_1 is even-sized. By Lemma 3.1, (G_1, s, t) is color-compatible. Since $m \geq 6$, $n \geq 5$, $c = \text{even}$, and $n - l = \text{odd} > 1$, it is enough to show that (G_1, s, t) is not in conditions (F1), (F8), and (F9). (G_1, s, t) is not in condition (F1), the proof is the same as Case 1. If (G_1, s, t) satisfies condition (F8), then $(C(m, n, k, l), s, t)$ satisfies condition (F14), a contradiction. Therefore, (G_1, s, t) is not in condition (F8). The condition (F9) holds, if $n - l = 3$, $c \geq 4$, s is black, and $s_x \leq d + k$. If this case occurs, then $(C(m, n, k, l), s, t)$ satisfies condition (F17), a contradiction. Thus, (G_1, s, t) does not satisfy condition (F9). Hence, (G_1, s, t) is acceptable. The Hamiltonian path in $(C(m, n, k, l), s, t)$ is obtained similar to Case 2.

Case 5. $s_x \leq d$, $t_x > d + k$, and

(a) $n = \text{even}$; or

(b) $n = \text{odd}$ and $[(m = \text{even and } [(d = \text{odd}, c = \text{odd}, \text{ and } n - l \leq 2), (d = \text{odd and } c = \text{even}), (d = \text{even and } c = \text{odd}), \text{ or } (c = \text{even and } d = \text{even})]) \text{ or } (m = \text{odd and } [(k > 1) \text{ or } (k = 1 \text{ and } [(c > 2) \text{ or } (c = 2, s \neq (d, l + 1), \text{ or } t \neq (m, l + 1))])])]$.

This case is similar to Case 1 such that $s, p \in G_1, q, t \in G_2$, p and q are adjacent, and

$$p = \begin{cases} (d + k, l + 1); & \text{if } w \text{ and } t \text{ have different colors, } n - l = \text{even, and } [(c = 2 \text{ and } t \neq (m, l + 1)) \text{ or } (c > 2)] \\ (d + k, l + 3); & \text{if } w \text{ and } t \text{ have different colors, } n - l = \text{even} > 2, c = 2, \text{ and } t = (m, l + 1) \\ (d + k, l + 2); & \text{if } w \text{ and } t \text{ have the same color, } n - l = \text{odd} > 1, \text{ and } [(c = 2 \text{ and } t \neq (m, l + 2)) \text{ or } (c > 2)] \\ (d + k, l + 4); & \text{if } w \text{ and } t \text{ have the same color, } n - l = \text{odd} > 3, \text{ and } t = (m, l + 2) \\ (d + k, n); & \text{otherwise} \end{cases}$$

where $w = (d + k + 1, l + 1)$. In the following, we prove that (G_1, s, p) and (G_2, q, t) are acceptable. There are the following two subcases for G_1 and G_2 .

Subcase 5.1. G_1 and G_2 are even-sized. A simple check shows that (G_1, s, p) and (G_2, q, t) are color-compatible. Consider (G_2, q, t) . In this case, G_2 is even \times even, even \times odd, or odd \times even. The condition (F1) holds, if (i) $c = 1$ and $[(t \neq (m, 1) \text{ or } q \neq (d + k + 1, n))]$. Since $(C(m, n, k, l), s, t)$ is acceptable, thus $t = (m, 1)$. Moreover, Since $q = (d + k + 1, n)$, clearly q and t are corner vertices in G_2 ; (ii) $c = 2$ and $2 \leq q_y = t_y \leq n - 1$. We can easily see that $q_y \neq t_y$ or $q_y = t_y = n$; or (iii) $n = 2$ and $d + k + 2 \leq q_x = t_x \leq m - 1$. This case can not occur, because of $q_x = d + k + 1$. Hence, (G_2, q, t) is not in condition (F1). The condition (F2) occurs, when (i) $c = 3$, $[(t \text{ and } w \text{ have different colors and } n - l = \text{odd}) \text{ or } (t \text{ and } w \text{ have the same color and } n - l = \text{even})]$, and $q_y < t_y - 1$. Since $q = (d + k + 1, n)$, thus (G_2, q, t) is not in condition (F2); or (ii) $n = 3$, $t_x > d + k + 1$, and t is black (when m is odd) or s is white (when m is even). Since $(C(m, n, k, l), s, t)$ is acceptable, the only case that occurs is $t = (d + k + 1, 1)$ or $t = (d + k + 1, n)$. In this case, $q = (d + k + 1, l + 1)$ and hence (G_2, q, t) is not in the condition (F2). So, (G_2, q, t) is acceptable.

Now, consider (G_1, s, p) . Since $p_x = d + k$ and $s_x \leq d$, a simple check shows that (G_1, s, p) is not in condition (F1) and (F3). The condition (F4) holds, if $k \times l = 1$, $m' - k > 2$, $n - l > 2$, $c = 2$, $s = (d, l + 1)$, and $t = (m, l + 1)$. By the assumption, this is impossible, and hence (G_1, s, p) is not in condition (F4). The condition (F7) occurs, when $d = 2$, $k = 1$, $n - l \geq 4$, $s = (1, l + 1)$, and $p = (d + k, l + 2)$. This is impossible, because of $p = (d + k, n)$. Hence, (G_1, s, p) does not satisfy conditions (F7). The condition (F8) holds, if (i) $n - l = 2$, $d = 3$ (or $n = 3$), and s is black; (ii) $n - l = 3$, $d = 2$, and s is white. If these cases hold, then $(C(m, n, k, l), s, t)$ satisfies condition (F17), a contradiction; (iii) $m' = 3$, $d = 2$, s is black, and $p_y < s_y - 1$, this is impossible, because of $p_y = n$; or (iv) $m' = 3$, $d = 2$, $c = 2$, $s = (d, l + 1)$, and $t = (m, l + 1)$, by the assumption, this case can not occur. So, (G_1, s, p) is not in conditions (F8). If (G_1, s, p) satisfies conditions (F6) and (F9), then $(C(m, n, k, l), s, t)$ satisfies condition (F17), a contradiction. Therefore, it follows that (G_1, s, p) does not satisfy conditions (F6) and (F9). Hence, (G_1, s, p) is acceptable. It remains to show that $(C(m, n, k, l), s, t)$ has a Hamiltonian path. In this case, the Hamiltonian path in $(C(m, n, k, l), s, t)$ is obtained similar to Subcase 4.1.2. Notice that, here, (G_2, q, t) is a rectangular grid graph and by Theorem 2.1 it has a Hamiltonian path. Thus, we construct a Hamiltonian path in (G_2, q, t) by the algorithm in [2].

Now, let $m = \text{odd}$, $n = \text{odd}$, $k = 1$, $c = 2$, $n - l > 2$, $s = (d, l + 1)$, and $t = (m, l + 1)$. Let $\{G_1, G_2\}$ be a L -shaped separation (type I) of $C(m, n, k, l)$ such that $G_1 = L(m, n, k', l')$, $G_2 = L(m', n', k, l)$, $k' = m - d$, $l' = l + 1$, $m' = k'$, $n' = l'$. Let $s, p \in G_1, q, t \in G_2$, q and p are adjacent, and $p = (d + 1, l + 2)$. Consider Fig. 20(f). One easily check that (G_1, s, p) and (G_2, q, t) are acceptable. The Hamiltonian path in $(C(m, n, k, l), s, t)$ is obtained similar to Subcase 4.1.2.

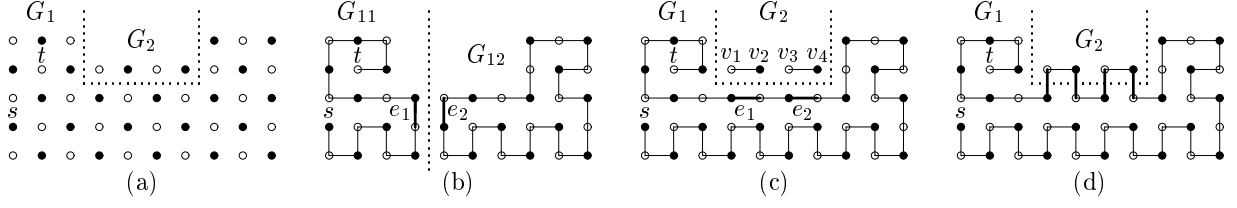

Figure 21. (a) A C -shaped separation of $C(m, n, k, l)$, (b) and (c) a Hamiltonian (s, t) -path in G_1 , and (d) a Hamiltonian (s, t) -path in $C(m, n, k, l)$.

Subcase 5.2. G_1 is odd-sized and G_2 is odd \times odd. We can easily see that (G_1, s, p) and (G_2, q, t) are color-compatible. Consider (G_2, q, t) . (G_2, q, t) is not in conditions (F1) and (F2), the proof is similar to Subcase 5.1. Thus, (G_2, q, t) is acceptable. Now, consider (G_1, s, p) . Since G_1 is odd-sized, it suffices to prove (G_1, s, p) is not in conditions (F1), (F3), and (F5). Since $s_x \leq d$ and $p_x = d + k$, a simple check that (G_1, s, p) is not in conditions (F1) and (F3). The condition (F5) holds, if $n - l = 2$ and $s = (d, n)$. If this case occurs, then (G_1, s, p) satisfies condition (F13) (case (b)), a contradiction. Therefore, (G_1, s, p) is not in condition (F5). Hence (G_1, s, p) is acceptable. The Hamiltonian path in $(C(m, n, k, l), s, t)$ is obtained similar to Subcase 5.1. Now, Lemma 4.1 completes the proof. \square

Lemma 4.2. Assume $(C(m, n, k, l), s, t)$ is an acceptable Hamiltonian path problem with $m \times n = \text{even} \times \text{odd}$, $c = \text{odd}$, $d = \text{odd}$, and $n - l = \text{even} \geq 4$. Then there is an acceptable separation for $(C(m, n, k, l), s, t)$ and it has a Hamiltonian path.

Proof. Note that, here, $C(m, n, k, l)$ is even-sized and s and t have different colors. For all the following cases, we prove that $(C(m, n, k, l), s, t)$ has an acceptable separation and show that it has a Hamiltonian path.

Case 1. $n - l \leq 6$ and $[(s_x, t_x \leq d \text{ and } c > 1) \text{ or } (s_x, t_x > d + k \text{ and } d > 1)]$. Assume $\{G_1, G_2\}$ is a C -shaped separation (type I) of $C(m, n, k, l)$ such that $G_1 = C(m, n, k, l')$, $G_2 = R(m', n')$, $l' = l + 1$, $m' = k$, $n' = 1$, and $s, t \in G_1$, as depicted in Fig. 21(a). Because of $k = \text{even}$, G_2 is even-sized. Also, since $C(m, n, k, l)$ is even-sized, we conclude that G_1 is even-sized. By Lemma 3.1, (G_1, s, t) is color-compatible. Since $n - l \leq 6$ and $l' = l + 1$, it follows that $n - l' = \text{odd} \leq 5$. Moreover, since $n - l' = \text{odd}$, $c = \text{odd}$, and $d = \text{odd}$, it suffices to prove (G_1, s, t) is not in conditions (F1), (F3), (F11), and (F16). Let $s_x, t_x \leq d$, for case $s_x, t_x > d + k$, the proof is similar. (G_1, s, t) is not in conditions (F1) and (F3), the proof is similar to Case 1 of Lemma 4.1. A simple check shows that (G_1, s, t) is not in condition (F11). The condition (F16) holds, if $d = 3$ and (i) $s_y \leq l$, $t_y > l$, and s is black (here the role of s and t can be swapped), (ii) $n - l = 4$, $s = (1, n - 1)$, and $t_x > s_x$, or (iii) s is black and $[(s_x = \text{odd}, t_y > s_y + 1) \text{ or } (s_x = \text{even} \text{ and } t_y > s_y)]$ (here the role of s and t can be swapped). It is obvious that if these cases hold, then (G_1, s, t) satisfies condition (F18), a contradiction. So, (G_1, s, t) is not in condition (F16), and hence it is acceptable. In this case, (G_1, s, t) is in Subcase 4.1.1 of Lemma 4.1.

The Hamiltonian (s, t) -path is constructed as follows. First by Subcase 4.1.1 of Lemma 4.1, G_1 partitions into two subgraphs G_{11} and G_{12} , and the Hamiltonian (s, t) -path in G_{11} and Hamiltonian cycle in G_{12} is constructed by the algorithm in [14] and Lemma 2.5, respectively. Notice that the pattern for constructing a Hamiltonian cycle in G_{12} is shown in Fig. 21(b). Then we combine the Hamiltonian path and cycle in G_1 using two parallel edges e_1 and e_2 as shown in Fig. 21(b). Let four vertices v_1, v_2, v_3 and v_4 be in G_2 and let P be a Hamiltonian path in G_1 . Consider Fig. 21(c). Clearly, there exist two edges e_1 and e_2 such that $e_1, e_2 \in P$ are on boundary of G_1 facing G_2 . By merging (v_1, v_2) and (v_3, v_4) to these edges, we obtain a Hamiltonian path for $(C(m, nk, l), s, t)$, as illustrated in Fig 21(d). When $k = 2$ or $k > 4$, a similar to the case $k = 4$, the result follows.

Case 2. $n - l = 4$ and $[(s_x \leq d \text{ and } t_x > d), (d + 1 \leq s_x \leq d + k \text{ and } t_x > d + k), \text{ or } (d + 1 \leq s_x, t_x \leq d + k)]$.

Subcase 2.1. $(s_x \leq d \text{ and } t_x > d)$ or $(d + 1 \leq s_x \leq d + k \text{ and } t_x > d + k)$. Let $s_x \leq d$ and $t_x > d$. By symmetry, the result follows, if $d + 1 \leq s_x \leq d + k$ and $t_x > d$. Consider the following subcases.

Subcase 2.1.1. $d = 1$, $c > 1$, and $s = (1, 1)$. This case is similar to Case 2 of Lemma 4.1, where $s, p \in G_2$, $q, t \in G_1$, p and q are adjacent, and $p = (1, l)$. If (G_2, s, p) is not acceptable, then $(C(m, n, k, l), s, t)$ satisfies condition (F11), a contradiction. Therefore, (G_2, s, p) is acceptable. Moreover, since $s = (1, 1)$ and $p = (1, l)$, a simple check shows that (G_1, q, t) is acceptable. The Hamiltonian path in $(C(m, n, k, l), s, t)$ is obtained similar to Case 5 of Lemma 4.1 (Fig. 22(a)).

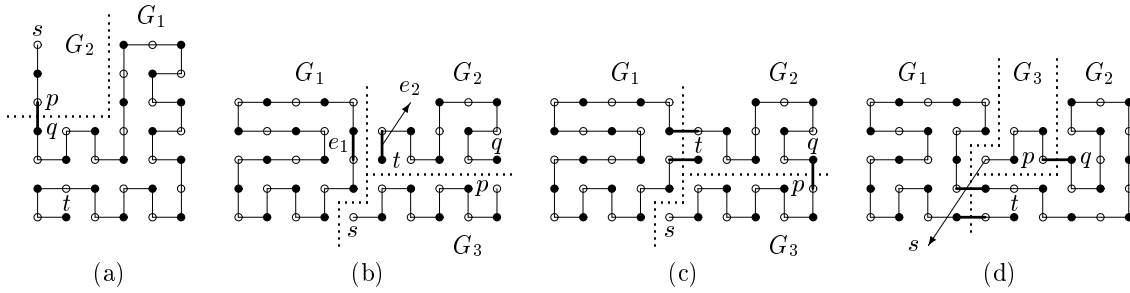

Figure 22. (a) A Hamiltonian (s, t) -path in $C(m, n, k, l)$, (b) a L -shaped separation of $C(m, n, k, l)$, and (c) and (d) a Hamiltonian (s, t) -path in $C(m, n, k, l)$.

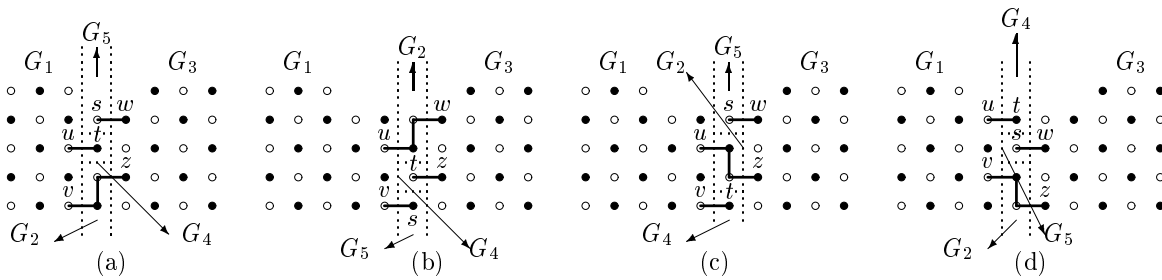

Figure 23. A Hamiltonian (s, t) -path in $C(m, n, k, l)$.

Subcase 2.1.2. $d, c > 1$,

Subcase 2.1.2.1. $s = (d, n)$, and $[t = (d + 1, l + 2)$ or $t = (d + 2, l + 1)]$. Let $\{G_1, G_2, G_3\}$ be a L -shaped separation (type III) of $C(m, n, k, l)$ such that $V(G_1) = \{1 \leq x \leq d, 1 \leq y \leq n - 1 \text{ and } 1 \leq x \leq d - 1, y = n\}$, $V(G_2) = \{d + 1 \leq x \leq m, 1 \leq y \leq n - 2\}$, $G_3 = C(m, n, k, l) \setminus (G_1 + G_2)$, $q, t \in G_2$, $s, p \in G_3$, p and q are adjacent, and $p = (m, n - 1)$. Consider Fig. 22(b). A simple check shows that (G_2, q, t) and (G_1, s, p) are acceptable. In order to build a Hamiltonian (s, t) -path in $C(m, n, k, l)$, first we construct Hamiltonian paths in (G_2, q, t) and (G_3, s, p) by the algorithm in [14]. Then we connect two vertices p and p . Moreover, since G_1 is even-sized, then it has a Hamiltonian cycle by Lemma 2.5. Finally, we combine Hamiltonian cycle in G_1 and Hamiltonian (s, t) -path by two parallel edges. The full construction of a Hamiltonian path in $(C(m, n, k, l), s, t)$ is illustrated in Fig. 22(c). The pattern for constructing a Hamiltonian cycle in G_1 is shown in Fig. 22(b). It is easy to see that there exists at least one edge for combining Hamiltonian cycle and path.

Subcase 2.1.2.2. $s = (d, l + 2)$, and $t = (d + 1, n)$. This case is similar to Subcase 2.1.2.1, where $V(G_1) = \{1 \leq x \leq d, 1 \leq y \leq l + 1 \text{ and } 1 \leq x \leq d - 1, l + 2 \leq y \leq n\}$, $V(G_2) = \{d \leq x \leq m, n - 1 \leq y \leq n \text{ and } d + k + 1 \leq x \leq m, 1 \leq y \leq n - 2\}$, $p = (d + k, n - 2)$, and $q = (d + k + 1, n - 2)$ (as shown Fig. 22(d)).

Subcase 2.1.3. $[(d, c > 1)$ or $(d = c = 1)]$ and $[(s \neq (d, n), t \neq (d + 1, l + 2)$ or $t \neq (d + 2, l + 1))$, $(s \neq (d, l + 2)$ or $t \neq (d + 1, n))]$. This case is similar to Case 5 of Lemma 4.1, where $G_1 = R(m', n)$, $G_2 = L(m - m', n, k, l)$, $m' = d$, and $p = (m', n)$ if $s \neq (m', n)$ or $t \neq (m' + 1, n)$; otherwise $p = (m', l + 2)$. Since $d = \text{odd}$ and $n = \text{odd}$, it follows that G_1 is odd \times odd with white majority color, G_2 is odd-sized with black majority color, and p is white. Clearly, (G_1, s, p) and (G_2, q, t) are color-compatible. Consider (G_1, s, p) . It is easy to check that (G_1, s, p) is not in conditions (F1) and (F2). Now, consider (G_2, q, t) . Since $n - l = 4$ and $c = \text{odd}$, it is enough to show that (G_2, q, t) is not in conditions (F1) and (F3). Since $q_x = d + 1$ and $t_x \geq d + 1$, a simple check shows that (G_2, q, t) is not in conditions (F1) and (F3). Hence (G_2, q, t) is acceptable. The Hamiltonian path in $(C(m, n, k, l), s, t)$ is obtained similar to Case 5 of Lemma 4.1.

Subcase 2.2. $d + 1 \leq s_x, t_x \leq d + k$ and $d, c > 1$.

Subcase 2.2.1. $s_x = t_x$. Let $\{G_1, G_2, G_3, G_4, G_5\}$ be a C -shaped separation (type III) of $C(m, n, k, l)$, as shown in Fig. 23, 24(a), and 24(b). The patterns in Fig. 23, 24(a), and 24(b) can be used for finding a Hamiltonian (s, t) -path for any values of d, c, l , and k . Notice that in Fig. 23(a)-(c) $s_x = \text{even}$, and in Fig. 23(d), 24(a), and 24(b) $s_x = \text{odd}$.

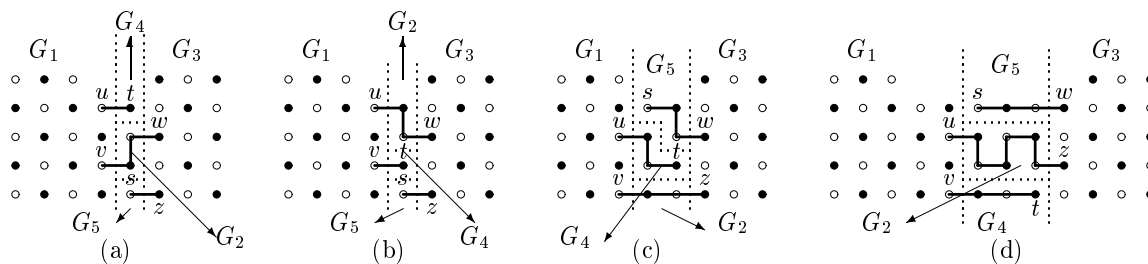

Figure 24. A Hamiltonian (s, t) -path in $C(m, n, k, l)$.

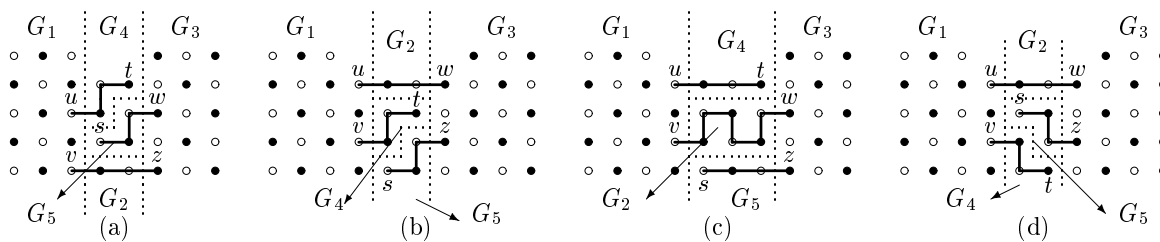

Figure 25. A Hamiltonian (s, t) -path in $C(m, n, k, l)$.

In this case, G_1 is a rectangular (or L -shaped) grid subgraph, where $s_x = d + 1$ (or $s_x > d + 1$) and also G_3 is a rectangular (or L -shaped) grid subgraph, where $s_x = d + k$ (or $s_x < d + k$). The Hamiltonian path in (G_1, u, v) and (G_2, w, z) constructed by algorithm in [2] or [14].

Subcase 2.2.2. $s_x \neq t_x$.

Subcase 2.2.2.1. ($s_x = \text{odd}$ and $[(s = (s_x, n)$ and $[t = (s_x + 1, l + 2)$ or $t = (s_x + 2, l + 1)]$) or $(s = (s_x, l + 2)$ and $t = (s_x + 1, n)]$) or $(s_x = \text{even}$ and $[(s = (s_x, l + 3)$ and $t = (s_x + 1, l + 1)$) or $(s = (s_x, l + 1)$ and $[(t = (s_x + 1, l + 3)$ or $t = (s_x + 2, n)]$)). This case is similar to Subcase 2.2.1. The patterns in Fig. 24(c), 24(d), and 25 can be used for finding a Hamiltonian (s, t) -path between for any values of d, c, l , and k .

Subcase 2.2.2.2. Other possible cases. This case is similar to Subcase 2.1.3, where $G_1 = L(m', n, k', l)$, $G_2 = L(m - m', n, k'', l)$, $m' = s_x$, $k' = m' - d$, and $k'' = k - k'$. Let $s_x = \text{even}$, then $p = (m', l + 1)$ if $s \neq (m', l + 1)$ or $t \neq (m' + 1, l + 1)$; otherwise $p = (m', l + 3)$. Now, let $s_x = \text{odd}$, then p is defined similar to Subcase 2.1.3; where $m' = s_x$.

Case 3. $n - l = 6$ and $[(s_x \leq d$ and $t_x > d)$, $(d + 1 \leq s_x \leq d + k, t_x > d + k, \text{ and } d > 1)$, or $(d + 1 \leq s_x, t_x \leq d + k$ and $c, d > 1)$]. Since $n - l = 6$ and $l \geq 1$, thus $n \geq 7$.

Subcase 3.1. $d, c > 1$ and $s_y, t_y > l + 3$. Since $d = \text{odd} > 1, c = \text{odd} > 1$, and $k = \text{even}$, we have $m \geq 8$.

Subcase 3.1.1. ($s_x = t_x$), (s is black, $s_y = \text{odd}$, and $t_x = s_x + 1$), or (s is white and $t_x > s_x$). Let $\{G_1, G_2\}$ be a horizontal separation of $C(m, n, k, l)$ such that $G_1 = C(m, n', k, l)$, $G_2 = R(m, n - n')$, $n' = l + 3$ and $s, t \in G_2$. Since n is odd, $n - l = 6$, and $n' = l + 3$, it follows that $n - n' = 3$ and $n' = \text{even}$. Moreover, since $m = \text{even}$, we conclude that

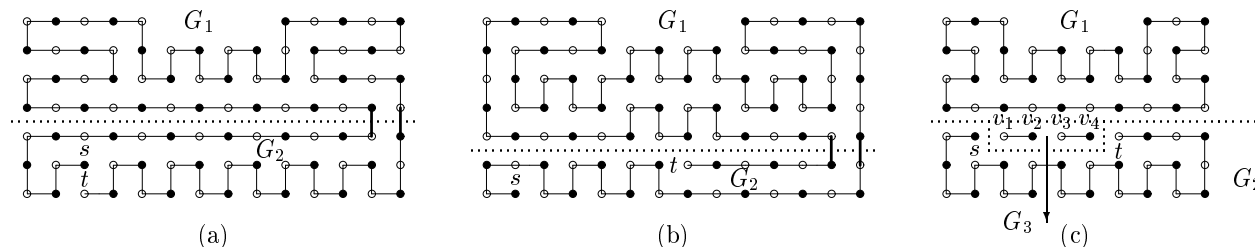

Figure 26. (a) and (b) A Hamiltonian (s, t) -path in $C(m, n, k, l)$, (c) a C -shaped separation type (IV) of $C(m, n, k, l)$.

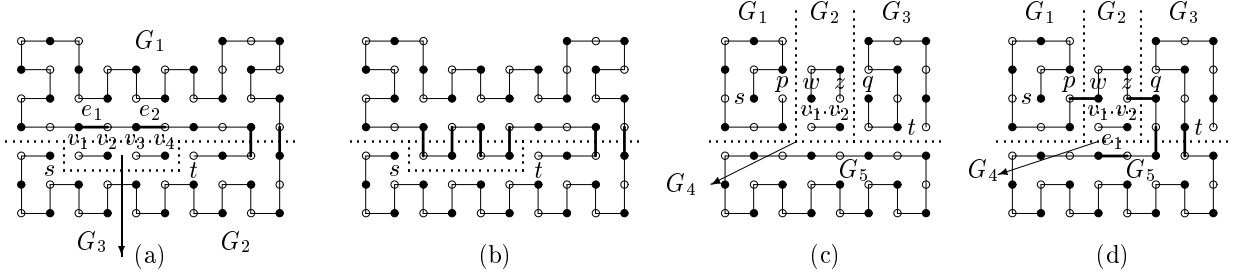

Figure 27. (a) and (b) Combining a Hamiltonian (s, t) -path in G_2 and a Hamiltonian cycle in G_1 , (b) a Hamiltonian (s, t) -path in $C(m, n, k, l)$, (c) C -shaped separation type (II) of $C(m, n, k, l)$, (d) combining Hamiltonian paths in G_1, G_2 , and G_3 and a Hamiltonian cycle in G_5 .

G_2 is even \times odd. By Lemma 3.1, (G_2, s, t) is color-compatible. Since $m \geq 8$ and $n - n' = 3$, it suffices to prove that (G_2, s, t) is not in condition (F2). The condition (F2) holds, if s is black and $t_x > s_x + 1$. This is impossible, because we assume that $t_x = s_x + 1$. Thus (G_2, s, t) is not in condition (F2), and hence (G_2, s, t) is acceptable. The Hamiltonian path in $(C(m, n, k, l), s, t)$ is obtained similar to Case 1 of Lemma 4.1. Since $m \geq 8$, thus there is at least one edge for combining Hamiltonian cycle and path. In this case, the pattern for constructing a Hamiltonian cycle in G_1 is shown in Fig. 26(a).

Subcase 3.1.2. $s_y, t_y > l + 4$, s is black, and $[(s_y = \text{even and } t_x > s_x) \text{ or } (s_y = \text{odd and } t_x > s_x + 1)]$. This case is similar to Subcase 3.1.1, where $n' = l + 4$. Since $n = \text{odd}$, $n - l = 6$, and $n' = l + 4$, it follows that $n - n' = 2$ and $n' = \text{odd}$. Clearly, G_1 is even-sized and G_2 is even \times even. By Lemma 3.1, (G_2, s, t) is color-compatible. Since $G_2 = \text{even}\times\text{even}$, it is enough to prove that (G_2, s, t) is not in condition (F1). The condition (F1) occurs, when $2 \leq s_x = t_x \leq m - 1$. Since $t_x > s_x$, thus $s_x \neq t_x$, and hence (G_2, s, t) is not in condition (F1). Therefore, (G_2, s, t) is acceptable. The Hamiltonian path in $(C(m, n, k, l), s, t)$ is obtained similar to Subcase 3.1.1. In this case, the pattern for constructing a Hamiltonian cycle in G_1 is shown in Fig. 26(b).

Subcase 3.1.3. $s_y = l + 4$, $t_y > l + 4$, $t_x > s_x + 1$, and s is black. This case is the same as Subcase 3.1.2, where $s, p \in G_1, q, t \in G_2$, p and q are adjacent, and $p = (1, n')$. From Subcase 3.1.2, we know that G_1 and G_2 is even-sized. Since $l = \text{odd}$, we have $n' = \text{odd}$. Moreover, since $p = (1, n')$, it is clear that p is white. Hence, (G_1, s, p) and (G_2, q, t) are color-compatible. (G_2, q, t) is not in conditions (F1) and (F2), the proof is similar to Subcase 3.1.2. Consider (G_1, s, p) . Since $n' - l = 4$ and $d, c \geq 3$, it suffices to prove that (G_2, s, p) is not in condition (F18). The condition (F18) holds, if $p_x < s_x$ and p is black. Since p is white, it is clear that (G_1, s, p) is not in condition (F18). Hence (G_1, s, p) is acceptable. In this case, (G_1, s, p) is in Case 1 or 2. The Hamiltonian path in $(C(m, n, k, l), s, t)$ is obtained similar to Case 5 of Lemma 4.1. Here, if $s_y > l + 4$ and $t_y = l + 4$, then the role of p and q can be swapped (that is, $s, p \in G_2$ and $q, t \in G_1$).

Subcase 3.1.4. $s_y = t_y = l + 4$, s is black, and $t_x > s_x + 1$. Let $\{G_1, G_2, G_3\}$ be a C -shaped separation (type IV) of $C(m, n, k, l)$ such that $G_1 = C(m, n', k, l)$, $G_2 = C(m, n - n', k', l')$, $G_3 = R(m', n'')$, $n' = l + 3$, $k' = t_x - s_x - 1$, $l' = 1$, $m' = k'$, $n'' = l'$, and $s, t \in G_2$. Consider Fig. 26(c). Since m is even, s is black, and t is white, thus $t_x = \text{odd}$ and $s_x = \text{even}$, and hence d', c' , and k' are even. Clearly, G_1, G_2 , and G_3 are even-sized. By Lemma 3.1, (G_1, s, t) is color-compatible. Since $n - n' - l' = 2$, $c', d' = \text{even}$, $s_x \leq d'$, and $t_x > d' + k'$, it suffices to prove (G_2, s, t) is not in condition (F17). The condition (F17) holds, if $s_y = l + 5$ or $t_y = l + 5$. Since $t_y = s_y = l + 4$, this is impossible, and hence (G_2, s, t) is acceptable. In this case, (G_2, s, t) is in Subcase 5.1 of Lemma 4.1. For constructing a Hamiltonian (s, t) -path, first combine a Hamiltonian path in G_2 and a Hamiltonian cycle in G_1 , this path is called P_1 , as shown in Fig 27(a). the pattern for constructing a Hamiltonian cycle in G_1 is shown in Fig. 26(c). Notice that since $m \geq 8$, thus there exists at least one edge for combining Hamiltonian cycle and path. Let four vertices v_1, v_2, v_3 and v_4 be in G_3 . Consider Fig. 27(a). Clearly, there exist two edges e_1 and e_2 such that $e_1, e_2 \in P_1$ are on boundary of G_1 facing G_3 . By merging (v_1, v_2) and (v_3, v_4) to these edges, we obtain a Hamiltonian path for $(C(m, nk, l), s, t)$, as illustrated in Fig 27(b). When $k = 2$ or $k > 4$, a similar to the case $k = 4$, the result follows.

Subcase 3.2. $s_y, t_y \leq l + 3$.

Subcase 3.2.1. s is white and $[(s_x \neq t_x) \text{ or } (d + 1 \leq s_x = t_x \leq d + k \text{ and } [(s_y \text{ (or } t_y) > l + 3) \text{ or } (s_y \text{ (or } t_y) < l + 2)])]$.

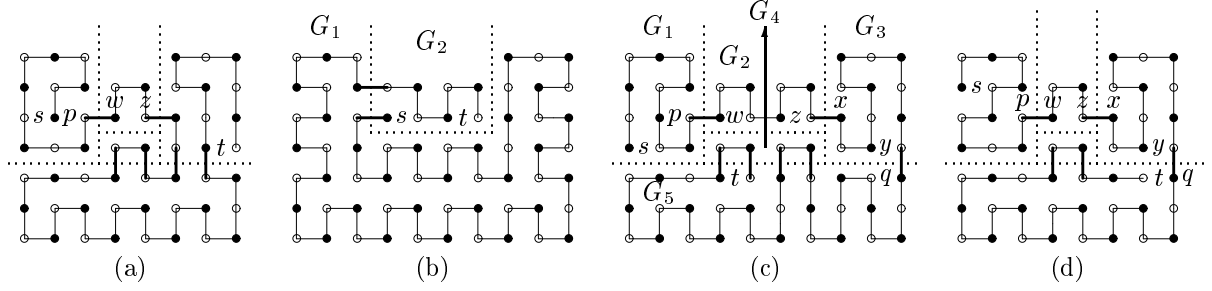
Figure 28. A Hamiltonian cycle in $(C(m, n, k, l), s, t)$.

Since $k = \text{even}$ and $d, c \geq 1$, we have $m \geq 4$. This case is similar to Subcase 3.1.2, where $s, t \in G_1$. Since $n - l = 6$ and $n' = l + 4$, it follows that $n' - l = 4$. Moreover, since d and c are odd and $n' - l = 4$, it suffices to prove (G_1, s, t) is not in condition (F1), (F3), (F11), and (F18). (G_1, s, t) is not in conditions (F1) and (F3), the proof is similar to Case 1. A simple check shows that (G_1, s, t) is not in conditions (F11) and (F18). Therefore, (G_1, s, t) is acceptable. In this case, (G_1, s, t) is in Case 2. The Hamiltonian path in $(C(m, n, k, l), s, t)$ is obtained similar to Case 1 of Lemma 4.1. Notice that, because of $m \geq 4$, there is at least one edge for combining Hamiltonian cycle and path.

Subcase 3.2.2. ($d + 1 \leq s_x = t_x \leq d + k$, and $[s_y \text{ (or } t_y) = l + 2 \text{ and } t_y \text{ (or } s_y) = l + 3]$), or (s is black, $s_y = \text{even}$, and $t_x = s_x + 1$). Note that, in this case, $d, c > 1$. This case is the same as Subcase 3.1.1, where $s, t \in G_1$. One can check that (G_1, s, t) is acceptable. In this case, (G_1, s, t) is in Case 1 of Lemma 4.1. The Hamiltonian path in $(C(m, n, k, l), s, t)$ is obtained similar to Subcase 3.1.1.

Subcase 3.2.3. $d, c > 1$, s is black, and $[(s_y = \text{even} \text{ and } t_x > s_x + 1) \text{ or } (s_y = \text{odd} \text{ and } t_x > s_x)]$.

Subcase 3.2.3.1. $s_x \leq d$ and $t_x > d + k$. Let $\{G_1, G_2, G_3, G_4, G_5\}$ be a C -shaped separation (type II) of $C(m, n, k, l)$ such that $G_1 = R(m', n')$, $G_2 = R(m'', n'')$, $G_3 = R(m - m' - m'', n')$, $G_4 = R(m'', 1)$, and $G_5 = C(m, n, k, l) \setminus (G_1 + G_2 + G_3 + G_4)$, where $V(G_1) = \{1 \leq x \leq x', 1 \leq y \leq l + 3\}$, $V(G_2) = \{x' + 1 \leq x \leq x'', 1 \leq y \leq l + 2\}$, $V(G_3) = \{x'' + 1 \leq x \leq m, 1 \leq y \leq l + 3\}$, $V(G_4) = \{x' + 1 \leq x \leq x'', y = l + 3\}$, $x' = d$, and $x'' = d + k$. Assume that $s, p \in G_1$, $w, z \in G_2$, $q, t \in G_3$ such that w and p , and q and z are adjacent, $p = (x', l + 2)$, and $q = (x'' + 1, l + 2)$. Consider Fig. 27(c). It is clear that (G_1, s, p) , (G_2, w, z) , and (G_3, q, t) are color-compatible. Consider (G_1, s, p) and (G_3, q, t) . Since $n' = l + 3$ and $l = \text{odd}$, it follows that $n' = \text{even} \geq 4$. Moreover, since $d, c = \text{odd} > 1$ and $n' \geq 4$, (G_1, s, p) and (G_3, q, t) are not in condition (F1). The condition (F2) holds, if $(d = 3 \text{ and } s_y \leq l)$ or $(c = 3 \text{ and } t_y \leq l)$. If this case holds, then $(C(m, n, k, l), s, t)$ satisfies condition (F18), a contradiction. So, (G_1, s, p) and (G_3, q, t) are acceptable. Consider (G_2, w, z) . Since k and n'' are even, it is clear that G_2 is even \times even and G_4 is even-sized. (G_2, w, z) is not in condition (F2). Moreover, since $w_x = x' + 1$ and $z_x = x''$, clearly (G_2, w, z) is not in condition (F1). Therefore, (G_2, w, z) is acceptable.

Because (G_1, s, p) , (G_2, w, z) , and (G_3, q, t) are acceptable, by Theorem 2.1 they have Hamiltonian paths. So, we construct a Hamiltonian path in (G_1, s, p) , (G_2, w, z) , and (G_3, q, t) by the algorithm in [2]. Then we connect vertices p, w, z , and q . Furthermore, since G_5 is even-sized rectangular grid subgraph, it has a Hamiltonian cycle by Lemma 2.2. Then combine Hamiltonian cycle and path using two parallel edges; see Fig. 27(d). Notice that, since $d, c > 1$, there exists at least one edge for combining Hamiltonian cycle and path. Let two vertices v_1 and v_2 be in G_4 and P be a Hamiltonian (s, t) -path. Obviously, there exists an edge e_1 such that $e_1 \in P$ are on boundary of G_5 facing G_4 . By merging (v_1, v_2) to this edge, we obtain a Hamiltonian path for $(C(m, n, k, l), s, t)$, as illustrated in Fig 28(a). When $|G_4| > 2$, a similar to the case $|G_4| = 2$, the result follows.

Subcase 3.2.3.2. $d + 1 \leq s_x, t_x \leq d + k$.

Subcase 3.2.3.2.1. $s_y, t_y \leq l + 2$. This case is the same as Case 1, where $l' = l + 2$, $m' = k$, $n' = l' - l$, and $s, t \in G_2$. Consider Fig. 28(b). A simple check shows that (G_2, s, t) is acceptable. The Hamiltonian path in $(C(m, n, k, l), s, t)$ is obtained similar to Case 1 of Lemma 4.1. In this case, the pattern for constructing a Hamiltonian cycle in G_1 is shown in Fig. 28(b). It is obvious that there is at least one edge for combining Hamiltonian cycle and path.

Subcase 3.2.3.2.2. s is black and $[(s_y \leq l + 2 \text{ and } t_y > l + 2) \text{ or } (t_y \leq l + 2 \text{ and } s_y > l + 2)]$.

Subcase 3.2.3.2.2.1. $s_y \leq l + 2$ and $t_y > l + 2$. This case is similar to Subcase 3.2.3.2.1, where $s, p \in G_2$, $q, t \in G_1$, $p = (d + k, l + 2)$, p and q are adjacent, and $q = (d + k, l + 3)$. Since $d + k = \text{odd}$ and $l + 2 = \text{odd}$, it follows that

$p = (d + k, l + 2)$ is white and q is black. Clearly, (G_2, s, p) and (G_1, q, t) are color-compatible. We can easily see that (G_2, s, p) is not in conditions (F1) and (F2). Consider (G_1, q, t) . Since $n - l = 6$ and $l' = l + 2$, it follows that $n - l' = 4$. So, it suffices to prove (G_1, q, t) is not in condition (F18). Since $t_x < q_x$ and t is white, (G_1, q, t) does not satisfy condition (F18), and hence (G_1, q, t) is acceptable. In this case, (G_1, q, t) is in Case 2. The Hamiltonian path in $(C(m, n, k, l), s, t)$ is obtained similar to Case 5 of Lemma 4.1.

Subcase 3.2.3.2.2. $s_y > l + 2$ and $t_y \leq l + 2$. This case is the same as Subcase 3.2.3.2.2.1, where $s, p \in G_1$, $q, t \in G_2$, $p = (d + 1, l + 3)$, and $q = (d + 1, l + 2)$. By the same argument as in proof Subcase 3.2.3.2.2.1, we obtain (G_1, s, p) and (G_2, q, t) are acceptable. The Hamiltonian path in $(C(m, n, k, l), s, t)$ is obtained similar to Case 1 of Lemma 4.1.

Subcase 3.2.3.2.3. $s_y, t_y = l + 3$. This case is similar to Subcase 3.2.3.1, where $x' = s_x$ and $x'' = t_x - 1$. We can easily see that (G_1, s, p) and (G_2, q, t) are acceptable. Notice that, in this case, G_1 and G_3 are L -shaped grid graphs. So, we construct a Hamiltonian path in (G_1, s, p) and (G_2, q, t) by the algorithm in [14].

Subcase 3.2.4. $(s_x \leq d$ and $d + 1 \leq t_x \leq d + k)$ or $(d + 1 \leq s_x \leq d + k$ and $t_x > d + k)$. Let $t_x > d + k$ and $d + 1 \leq s_x \leq d + k$. By symmetry, the result follows, if $s_x \leq d$ and $d + 1 \leq t_x \leq d + k$.

Subcase 3.2.4.1. $s_y \leq l + 2$. This case is similar to Subcase 3.2.3.2.2.1. Notice that, in this case, the condition (F18) holds, if $c = 3$ and $t_y \leq l$. If this case occurs, then $(C(m, n, k, l), s, t)$ satisfies condition (F18), a contradiction. So, (G_1, q, t) is acceptable.

Subcase 3.2.4.2. $s_y = l + 3$. This case is similar to Subcase 3.2.3.1, where $x' = s_x$ and $x'' = d + k$. Here, G_1 is a L -shaped grid subgraph, hence we construct a Hamiltonian path in (G_1, s, p) by the algorithm in [14]. Note that, in this case, if $s_x = d + k$, then $G_2 = \emptyset$ and $G_4 = \emptyset$.

Subcase 3.3. $s_y \leq l + 3$ and $t_y > l + 3$ (or $t_y \leq l + 3$ and $s_y > l + 3$).

Subcase 3.3.1. $t_y > l + 4$. This case is similar to Subcase 3.1.3, where $p = (1, n')$ if s is black; otherwise $p = (m, n')$. From Subcase 3.1.3, we know that G_1 is even-sized, G_2 is even \times even, and $n' = odd$. Since $n' = odd$ and $m = even$, we conclude that $p = (1, n')$ is white and $p = (m, n')$ is black. Thus, It is clear that (G_1, s, p) and (G_2, q, t) are color-compatible. (G_2, q, t) is not in conditions (F2), the proof is the same as Subcase 3.1.3. The condition (F1) occurs, when $2 \leq q_x = t_x \leq m - 1$. Since $q_x = 1$ or m , thus (G_2, q, t) is not in condition (F1). So, (G_2, q, t) is acceptable. Now, consider (G_1, s, p) . The condition (F1) holds, if $d = 1$ (resp. $c = 1$), $s_y \leq l + 1$, and $s \neq (1, 1)$ (resp. $t_y \leq l + 1$ and $t \neq (m, 1)$). Since $C(m, n, k, l), s, t)$ is acceptable, it follows that $s = (1, 1)$ (resp. $t = (m, 1)$). Therefore, (G_1, s, p) is not in condition (F1). The condition (F3) occurs, when $s_y > l$ and $(d = 1$ or $c = 1)$. Clearly, If this case holds, then $(C(m, n, k, l), s, t)$ satisfies condition (F3), a contradiction. Therefore, (G_1, s, p) is not in condition (F3). A simple check shows that (G_1, s, p) is not in condition (F11). The condition (F18) holds, if (i) $d = 3$, $s_y \leq l$, and s is black, (ii) $c = 3$, $s_y \leq l$, and s is white; if these cases occur, then $(C(m, n, k, l), s, t)$ satisfies condition (F18), a contradiction; or (iii) $s_y > l$, s is black, and $p_x > s_x$. We can easily check that this case can not occur. Thus (G_1, s, p) is not in condition (F18). Hence, (G_1, s, p) is acceptable. In this case, (G_1, s, p) is in Case 1 or 2. The Hamiltonian path in $(C(m, n, k, l), s, t)$ is obtained similar to Case 5 of Lemma 4.1. Notice that if $s_y > l + 4$ and $t_y < l + 4$, the the role of p and q can be swapped.

Subcase 3.3.2. $(t_y = l + 4, s_y \leq l + 3, s$ is black, and t is white) or $(s_y = l + 4, t_y \leq l + 3, s$ is black, and t is white). Notice that, in this case, $d, c > 1$. Let $t_y = l + 4$. By symmetry, the result follows, if $s_y = l + 4$.

Subcase 3.3.2.1. $t_x = s_x + 1$ or $t_x = s_x + 2$. This case is similar to Subcase 3.1.3, where $n' = l + 3$ and $p = (t_x - 1, n')$. We can easily check that (G_1, s, p) and (G_2, q, t) are acceptable. In this case, (G_1, s, p) is in Case 1 of Lemma 4.1. The Hamiltonian path in $(C(m, n, k, l), s, t)$ is obtained similar to Case 5 of Lemma 4.1.

Subcase 3.3.2.2. $t_x > s_x + 2$. This case is similar to Subcase 3.2.3.1, where $s, p \in G_1$, $w, z \in G_2$, $x, y \in G_3$, and $q, t \in G_4$. In this case, $x' = d$ if $s_x \leq d$; otherwise $x' = s_x$ and $x'' = d + k$. Let p and w, z and x , and q and y are adjacent such that $p = (x', l + 2)$, $x = (x'' + 1, l + 2)$, and $q = (m, l + 4)$. (G_1, s, p) , (G_2, w, z) , and (G_3, x, y) are acceptable, the proof is similar to Subcases 3.2.3.1 and 3.2.3.2.3. A simple check shows that (G_5, q, t) is acceptable. In this case, G_1 is a rectangular grid graph if $s_x \leq d$; otherwise G_1 is a L -shaped grid graph. The Hamiltonian path in $(C(mn, k, l), s, t)$ is obtained similar to Subcase 3.2.3.1 (as shown in Fig. 28(c) and 28(d)). Notice that, here, first we connect vertices p and w, z and x , and q and y . In this case, the patterns for constructing a Hamiltonian path in G_5 is shown in Fig. 28(c) and 28(d).

Subcase 3.3.3. $(t_y = l + 4, t$ is black and s is white) or $(s_y = l + 4, s$ is white and t is black). This case is similar to Subcase 3.2.1.

Case 4. $n - l > 6$.

Subcase 4.1. $s_y, t_y > l + 5$. This case is similar to Subcase 3.1.2. By the same argument as in proof Subcase 3.1.2, we drive (G_2, s, t) is acceptable. The Hamiltonian path in $(C(m, n, k, l), s, t)$ is obtained similar to Subcase 3.1.2.

Subcase 4.2. $s_y, t_y \leq l + 5$. This case is similar to Subcase 3.1.1, where $n' = l + 5$ and $s, t \in G_1$. Since m is even, it follows that G_2 is even-sized. Moreover, since $C(m, n, k, l)$ is even-sized, we conclude that G_1 is even-sized. By Lemma 3.1, (G_1, s, t) is color-compatible. Because of $l = \text{odd}$ and $n' = l + 5$, we have $n' = \text{even} \geq 6$ and $n' - l = \text{odd} \geq 5$. Furthermore, since $n' - l = \text{odd} \geq 5$ and $d, c \geq 1$, it suffices to prove (G_1, s, t) is not in conditions (F1), (F3), (F11), and (F17). (G_1, s, t) is not in conditions (F1) and (F3), the proof is the same as Case 1. Clearly, since $n' - l \geq 5$, a simple check shows that (G_1, s, t) is not in condition (F11). It is obvious that if (G_1, s, t) satisfies condition (F17), then $(C(m, n, k, l), s, t)$ satisfies condition (F18), a contradiction. Therefore, (G_1, s, t) is not in condition (F17). Hence, (G_1, s, t) is acceptable. In this case, (G_1, s, t) is in Case 1 or 2, or Subcase 5.1 of Lemma 4.1. The Hamiltonian path in $(C(m, n, k, l), s, t)$ is obtained similar to Subcase 3.2.1.

Subcase 4.3. $s_y \leq l + 5$, and $t_y > l + 5$. This case is similar to Subcase 4.2, where $s, p \in G_1, q, t \in G_2, p$ and q are adjacent, and $p = (1, n')$ if s is white; otherwise $p = (m, n')$. Since $n' = \text{even}$ and $m = \text{even}$, thus $p = (1, n')$ is black and $p = (m, n')$ is white. Hence, (G_1, s, p) and (G_2, q, t) are color-compatible. In this case, G_1 is even-sized and G_2 is even \times odd. (G_1, s, p) is not in conditions (F1), (F3), and (F11), the proof is the same as Subcase 3.3.1. (G_1, s, p) is not in condition (F17), the proof is like to Subcase 4.2. Hence (G_1, s, p) is acceptable. Now, consider (G_2, q, t) . Since $n - l > 6$ and $n' = l + 5$, it follows $n - n' \geq 3$. Moreover, since $m \geq 4, n - n' \geq 3$, it is sufficient to show that (G_2, q, t) is not in condition (F1). The condition (F2) holds, if $n - n' = 3$ and $[(t \text{ is white and } q_x < t_x - 1) \text{ or } (t \text{ is black and } q_x > t_x + 1)]$. Since $q_x = 1$, where t is black, or $q_x = m$, where t is white, it is clear that (G_2, q, t) is not in condition (F2). Therefore (G_2, q, t) is acceptable. In this case, (G_1, s, p) is in Case 1 or 2, or Subcase 5.1 of Lemma 4.1. The Hamiltonian path in $(C(m, n, k, l), s, t)$ is obtained similar to Case 5 of Lemma 4.1. Notice that if $s_y > l + 5$ and $t_y < l + 5$, then the role of p and q can be swapped (i.e., $s, p \in G_2$ and $q, t \in G_1$). This finishes the proof. \square

Lemma 4.3. *Suppose that $(C(m, n, k, l), s, t)$ is an acceptable Hamiltonian path problem. Assume $C(m, n, k, l)$ is odd-sized. Then there is an acceptable separation for $(C(m, n, k, l), s, t)$ and it has a Hamiltonian path.*

Proof. Let $m \times n = \text{odd} \times \text{odd}$, then $k \times l$ is even \times even, even \times odd, or odd \times even and two vertices s and t are white. Let $m = \text{even}$, then $k \times l = \text{odd} \times \text{odd}, d = \text{even}$ and $c = \text{odd}$ (or $d = \text{odd}$ and $c = \text{even}$), and two vertices s and t are black if $d = \text{even}$; otherwise s and t are white. Now, let $m \times n = \text{odd} \times \text{even}$, then $k \times l$ is odd \times odd, d and c are even (or odd), and two vertices s and t are black if d and c are even; otherwise s and t are white. Notice that, here for $n = \text{odd}, l = \text{odd}$, and $[(d = \text{even} \text{ and } c = \text{odd}) \text{ or } (d = \text{odd} \text{ and } c = \text{even})]$, we only consider the case $d = \text{odd}$, and $c = \text{even}$. By symmetry, the result follows, if $d = \text{even}$ and $c = \text{odd}$. Consider the following cases. We will show that there is an acceptable separation for $(C(m, n, k, l), s, t)$ and it has a Hamiltonian path.

Case 1. ($n = \text{odd}$ and $m = \text{odd}$) or ($n = \text{even}$).

Subcase 1.1. $n = \text{odd}, l = \text{even}, n - l > 1$, and $[(s_x, t_x \leq d + k \text{ and } c > 1) \text{ or } (d > 1 \text{ and } [(s_x, t_x > d + k) \text{ or } (d + 1 \leq s_x \leq d + k \text{ and } t_x > d + k)])]$. Let $s_x, t_x \leq d + k$. By symmetry, the result follows, if $(s_x, t_x > d + k)$ or $(d + 1 \leq s_x \leq d + k \text{ and } t_x > d + k)$. This case is similar to Case 2 of Lemma 4.1. Since l is even, thus G_2 is even-sized and $n - l = \text{odd}$. Moreover, since $C(m, n, k, l)$ is odd-sized, we conclude that G_1 is odd-sized. Hence by Lemma 3.1, (G_1, s, t) is color-compatible. Since G_1 is odd-sized and $n - l \geq 3$, it suffices to prove that (G_1, s, t) is not in conditions (F1), (F3), and (F5). The condition (F1) holds, if (i) $d = 1, s_y$ (or t_y) $\leq l + 1$ and s (or t) $\neq (1, 1)$; (ii) $d = 2, s_y, t_y \leq l + 1$, and $|t_y - s_y| = 1$; (iii) $n - l = 2, s_x, t_x \geq d, t_x - s_x = 1$. Clearly, if these cases hold, then $(C(m, n, k, l), s, t)$ satisfies condition (F1), a contradiction. Therefore, (G_1, s, t) is not in condition (F1). (G_1, s, t) is not in condition (F3), the proof is similar to Case 1 of Lemma 4.1. The condition (F5) holds, if $m - k' = 2$ and $[(s_y, t_y \leq l) \text{ or } (s_y \text{ (or } t_y) \leq l \text{ and } t \text{ (or } s) = (1, l + 1))]$. If this case holds, then $(C(m, n, k, l), s, t)$ satisfies condition (F14) or (F17), a contradiction. Therefore, it follows that (G_1, s, t) does not satisfy condition (F5), and hence it is acceptable. The Hamiltonian path in $(C(m, n, k, l), s, t)$ is obtained similar to Case 1 of Lemma 4.1.

Subcase 1.2. $n - l > 1$ and $[(n = \text{odd}, l = \text{odd}, d = \text{odd}, c = \text{even}, s_x, t_x \leq d + k, \text{ and } [(n - l = 2) \text{ or } (n - l \geq 4 \text{ and } s \neq (d + k - 1, l + 1) \text{ or } t \neq (d + k, l + 2))]) \text{ or } (n = \text{even} \text{ and } [(c > 1 \text{ and } s_x, t_x \leq d + k) \text{ or } (d > 1 \text{ and } [(s_x, t_x > d + k) \text{ or } (d + 1 \leq s_x \leq d + k \text{ and } t_x > d + k)])])]$. Notice that, in this case, $n - l = \text{odd}$ if $n = \text{even}$; otherwise $n - l = \text{even}$. Let $s_x, t_x \leq d + k$. By symmetry, the result follows, if $(s_x, t_x > d + k)$ or $(d + 1 \leq s_x \leq d + k \text{ and } t_x > d + k)$. This case is similar to Case 1 of Lemma 4.1. Since $n = \text{even}$ or $c = \text{even}$ implies G_2 is even-sized. Moreover, since $C(m, n, k, l)$ is odd-sized, we conclude that G_1 is odd-sized. By Lemma 3.1, (G_1, s, t) is color-compatible. In the following, we show

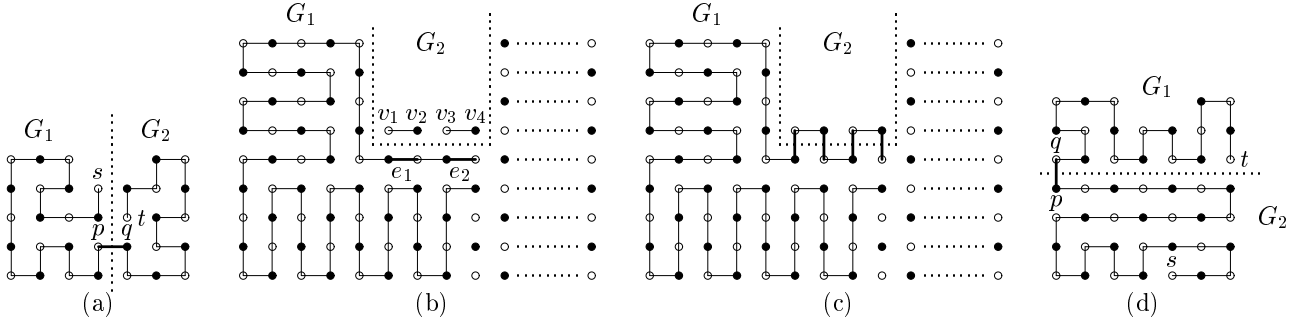
Figure 29. A Hamiltonian (s, t) -path in $C(m, n, k, l)$.

that (G_1, s, t) is not in conditions (F1), (F3), and (F5). (G_1, s, t) is not in condition (F3), the proof is the same as Case 1 of Lemma 4.1. The condition (F1) holds, if $n - l \geq 4$, $s = (d + k - 1, l + 1)$, and $t = (d + k, l + 2)$. This is impossible, because we assume that $s \neq (d + k - 1, l + 1)$ or $t \neq (d + k, l + 2)$. (G_1, s, t) is not in condition (F5), the proof is the same as Subcase 1.1. So, (G_1, s, t) is acceptable. The Hamiltonian path in $(C(m, n, k, l), s, t)$ is obtained similar to Case 1 of Lemma 4.1. Now, let $n = \text{odd}$, $n - l \geq 4$, $s = (d + k - 1, l + 1)$, and $t = (d + k, l + 2)$. This case is similar to Subcase 4.1.2 of Lemma 4.1, where $m' = s_x$ and $p = (m', n - 1)$; see Fig. 29(a). Clearly, (G_1, s, p) and (G_2, q, t) are acceptable. The Hamiltonian path in $(C(m, n, k, l), s, t)$ is obtained similar to Subcase 4.1.2 of Lemma 4.1.

Subcase 1.3. $n = \text{odd}$, $l = \text{odd}$, $n - l > 1$, $d = \text{odd} > 1$, $c = \text{even}$, and $s_x, t_x > d + k$. Notice that, in this case, $n - l = \text{even} \geq 4$. This case is the same as Case 1 of Lemma 4.2. By the same argument as in proof Case 1 of Lemma 4.2, G_2 is even-sized and (G_1, s, t) is color-compatible. Since $l' = l + 1$, $l = \text{odd}$, and $n - l = \text{even} \geq 4$, we have $n - l' = \text{odd} \geq 3$. Moreover, since $d > 1$, $n - l = \text{odd} \geq 3$, and $c = \text{even}$, it is enough to show that (G_1, s, t) is not in conditions (F1) and (F14). The condition (F1) or (F14) holds, if $c = 2$ and $s_y, t_y \leq l + 2$. Clearly, if this case occurs then $(C(m, n, k, l), s, t)$ satisfies condition (F1) or (F14), a contradiction. Thus, (G_1, s, t) is not in condition (F1) or (F14). Hence, (G_1, s, t) is acceptable. In this case, (G_1, s, t) is in Subcase 1.1. The Hamiltonian path in $(C(m, n, k, l), s, t)$ is obtained similar to Case 1 of Lemma 4.2. Notice that, in this case, we can always construct a Hamiltonian path P in G_1 that contains a subpath P_1 , as shown in Fig. 29(b). Let four vertices v_1, v_2, v_3 and v_4 be in G_2 . Consider Fig. 29(b). Clearly, there exist two edges e_1 and e_2 such that $e_1, e_2 \in P_1$ are on boundary of G_1 facing G_2 . By merging (v_1, v_2) and (v_3, v_4) to these edges, we obtain a Hamiltonian path for $(C(m, n, k, l), s, t)$, as illustrated in Fig 27(c). When $k = 2$ or $k > 4$, a similar to the case $k = 4$, the result follows.

Subcase 1.4. ($n = \text{even}$, $s_x \leq d$, and $t_x > d + k$) or ($n = \text{odd}$ and $[(l = \text{even}, s_x \leq d, \text{ and } t_x > d + k)$ or $(l = \text{odd}, s_x \leq d + k, \text{ and } t_x > d + k)]$). This case is similar to Case 5 of Lemma 4.1, where

$$p = \begin{cases} (d + k, n); & \text{if } (n = \text{even}) \text{ or } (n = \text{odd} \text{ and } [(l = \text{even}) \text{ or} \\ & (l = \text{odd} \text{ and } [(n - l = 2) \text{ or } (n - l > 2 \text{ and } s \neq (d + k, n))]]) \\ (d + k, l + 2); & \text{if } n = \text{odd}, l = \text{odd}, n - l > 2, s = (d + k, n), \text{ and } [(c > 2) \text{ or } (c = 2 \text{ and } t \neq (m, l + 2))] \end{cases}$$

Consider the following Subcases.

Subcase 1.4.1. G_1 is odd-sized and G_2 is even-sized. We can easily check that (G_1, s, p) and (G_2, q, t) are color-compatible. Consider (G_2, q, t) . (G_2, q, t) is not in condition (F1), the proof is the same as Subcase 5.1 of Lemma 4.1. The condition (F2) holds, if (i) $n = 3$ and t is black; this is impossible because t and s are white, or (ii) $c = 3$, $q_y < t_y - 1$, this case does not occur because of $q = (d + k + 1, n)$. Thus (G_2, q, t) is not in condition (F2). Hence, (G_2, q, t) is acceptable. Now, consider (G_1, s, p) . The condition (F1) holds, if (i) $d = 1$, $s_y \leq l + 1$, and $s \neq (1, 1)$, clearly this is impossible; (ii) $n - l = 1$ and $s_x \geq d$; (iii) $n - l = 2$ and $s = (d + k - 1, n - 1)$; if these cases occur, then $(C(m, n, k, l), s, t)$ satisfies condition (F1) or (F13), a contradiction; or (iv) $n - l > 2$, $s = (d + k - 1, l + 1)$, and $p = (d + k, l + 2)$, this is impossible because of in this case $p = (d + k, n)$. Hence, (G_1, s, p) is not in condition (F1). The condition (F3) holds, if $n - l = 1$ and $s_x, p_x \leq d$. By the assumption, this is impossible. The condition (F5) occurs, when $(d = 2$ and $s_y, p_y \leq l + 1)$ or $(n - l = 2, s_y, p_y \geq n - 1, \text{ and } s_x, p_x > d)$. It is obvious that if this case holds, then $(C(m, n, k, l), s, t)$ satisfies condition (F17), a contradiction. Therefore, (G_1, s, p) is not in condition (F5). Hence, (G_1, s, p) is acceptable. The Hamiltonian path in $(C(m, n, k, l), s, t)$ is obtained similar to Case 5 of Lemma 4.1.

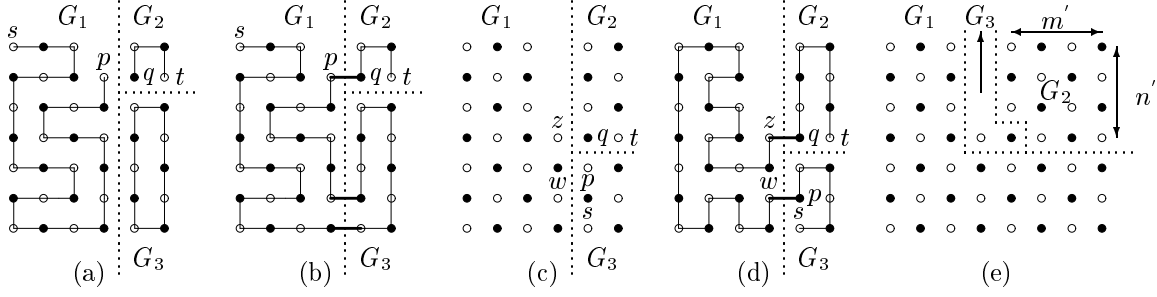

Figure 30. (a) A L -shaped separation of $C(m, n, k, l)$, (b) a Hamiltonian (s, t) -path in $C(m, n, k, l)$, (c) a L -shaped separation of $C(m, n, k, l)$, (d) a Hamiltonian (s, t) -path in $C(m, n, k, l)$, and (e) a C -shaped separation (type V) of $C(m, n, k, l)$.

Now, let $n = \text{odd}$, $n - l > 2$, $l = \text{odd}$, $c = 2$, $s = (d + k, n)$, and $t = (m, l + 2)$. This case is similar to Subcase 3.1.3 of Lemma 4.2, where $n' = l + 2$, $s, p \in G_2$, $q, t \in G_1$, and $p = (1, n' + 1)$. Consider Fig. 29(d). Clearly (G_1, q, t) and (G_2, s, p) are acceptable. In this case, (G_1, q, t) is in Subcase 1.4.1. The Hamiltonian path in $(C(m, n, k, l), s, t)$ is obtained similar to 3.1.3 of Lemma 4.2.

Subcase 1.4.2. G_1 is even-sized and G_2 is odd \times odd. A simple check shows that (G_1, s, p) and (G_2, q, t) are color-compatible. (G_2, q, t) is not in conditions (F1) and (F2), the proof is the same as Subcase 5.2 of Lemma 4.1. Now, consider (G_1, s, p) . (G_1, s, p) is not in conditions (F1) and (F3), the proof is similar to Subcase 1.4.1. The condition (F4) holds, if $k \times l = 1$. Since $k \times l > 1$, thus (G_1, s, p) is not in condition (F4). The conditions (F6), (F8), and (F9) hold, if t is black. This is impossible, because s and t are white. The condition (F7) holds, if $p_x = d$. Since $p_x = d + k$, thus (G_1, s, p) does not satisfy condition (F7). Therefore, (G_1, s, p) and (G_2, q, t) are acceptable. The Hamiltonian path in $(C(m, n, k, l), s, t)$ is obtained similar to Case 5 of Lemma 4.1.

Case 2. $n = \text{odd}$ and $m = \text{even}$. In this case, $n - l = \text{even}$.

Subcase 2.1. $[(s_x, t_x \leq d + k), (s_x, t_x > d + k, s_y, t_y > l, \text{ and } d > 1), \text{ or } (s_x \leq d + k, t_x > d + k, \text{ and } t_y > l)]$ and $[(c > 2 \text{ and } l > 1) \text{ or } (c = 2 \text{ and } t \neq (m, l + 1))]$. This case is the same as Case 2 of Lemma 4.1. Since $c = \text{even}$, thus G_2 is even-sized. Moreover, since $C(m, n, k, l)$ is odd-sized, then G_1 is odd-sized. By Lemma 3.1, (G_1, s, t) is color-compatible. Now, we show that (G_1, s, t) is not in conditions (F1), (F3), and (F5). (G_1, s, t) is not in condition (F1), the proof is the same as Subcase 1.1. (G_1, s, t) is not in condition (F3), the proof is the same as Case 1 of Lemma 4.1. The condition (F5) holds, if $n - l = 2$, $s_y, t_y \geq n - 1$, and $s_x, t_x > d$. If this case holds, then $(C(m, n, k, l), s, t)$ satisfies condition (F13) or (F17), a contradiction. Therefore, (G_1, s, t) is not in condition (F5). Hence, (G_1, s, t) is acceptable. The Hamiltonian path in $(C(m, n, k, l), s, t)$ is obtained similar to Case 2 of Lemma 4.1.

Subcase 2.2. $c = 2$ and t (or s) = $(m, l + 1)$. Let $t = (m, l + 1)$. Notice that, here, $n - l > 2$. Consider the following subcases.

Subcase 2.2.1. $s_x \leq d$ and $s \neq (d + k, l + 1)$. Let $\{G_1, G_2, G_3\}$ be a L -shaped separation (type II) of $C(m, n, k, l)$ such that $G_1 = L(m', n, k, l)$, $G_2 = R(m - m', n')$, $G_3 = R(m - m', n - n')$, $m' = d + k$, and $n' = l + 1$. Let $s, p \in G_1$, $q, t \in G_2$, q and p are adjacent, and $p = (d + k, l + 1)$. Consider Fig. 30(a). A simple check shows that (G_1, s, p) and (G_2, q, t) are acceptable. The Hamiltonian path in $(C(m, n, k, l), s, t)$ is obtained similar to Subcase 3.2.3.1 of Lemma 4.2, as shown in Fig. 30(b). Notice that, here, G_1 is a L -shaped grid graph, thus we construct a Hamiltonian path in (G_1, s, p) by the algorithm in [14]. Obviously, since $n - n' \geq 3$ there is at least one edge for combining Hamiltonian cycle and path.

Subcase 2.2.2. $s = (d + k, l + 1)$. This case is similar to Case 5 of Lemma 4.1, where $p = (d + k, n - 1)$. A simple check shows that (G_1, s, p) and (G_2, q, t) are acceptable. The Hamiltonian path in $(C(m, n, k, l), s, t)$ is obtained similar to Case 5 of Lemma 4.1.

Subcase 2.2.3. $s_x, t_x > d + k$. This case is similar to Subcase 2.2.1, where $s, p \in G_3$, $q, t \in G_2$, $w, z \in G_1$, $q = (m - 1, l + 1)$, and $p = (m - 1, n - 1)$ if $s \neq (m, n - 1)$; otherwise $(m - 1, n - 3)$. Assume that z and q , and w and p are adjacent. Consider Fig. 30(c). It is clear that (G_1, z, w) and (G_2, q, t) are acceptable. Consider (G_3, s, p) . Obviously, (G_3, s, p) is color-compatible. The condition (F1) holds, if $p_y = s_y = n - 1$. Since $s \neq (m, n - 1)$, thus (G_3, s, p) is not in condition (F1). The condition (F2) occurs, when $n - n' = 3$ and $s_y = p_y = n - 1$. If this case occurs, then, $(C(m, n, k, l), s, t)$ satisfies condition (F15), a contradiction. Therefore, (G_3, s, p) is not in condition (F2). Hence,

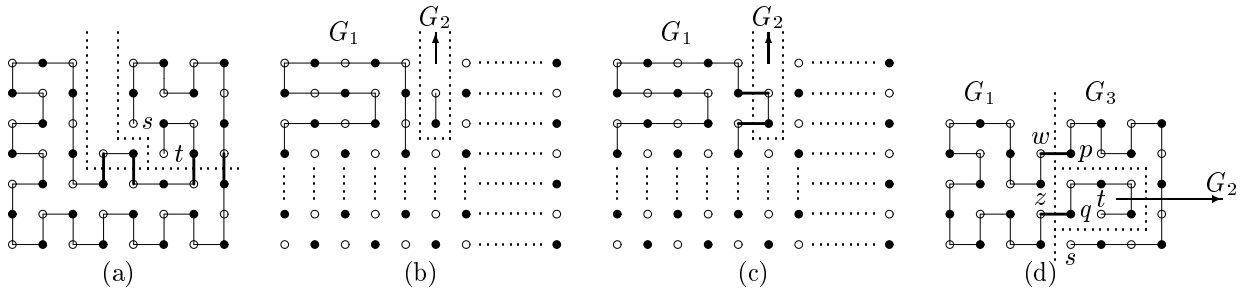
Figure 31. A Hamiltonian (s, t) -path in $C(m, n, k, l)$.

(G_1, s, p) is acceptable. The Hamiltonian path in $(C(m, n, k, l), s, t)$ is obtained similar to Subcase 3.2.3.1 of Lemma 4.2, as shown in Fig. 30(d). Notice that, here, G_1 is a L -shaped grid graph, thus we construct a Hamiltonian path in (G_1, s, p) by the algorithm in [14].

Subcase 2.3. $s_x, t_x > d + k$, $s_y, t_y \leq l + 1$, and $l > 1$. Notice that, in this case, $c \geq 4$. Let $\{G_1, G_2, G_3\}$ be a L -shaped separation (type V) of $C(m, n, k, l)$ such that $V(G_2) = \{d + k + 1 \leq x \leq m, 1 \leq y \leq l \text{ and } d + k + 2 \leq x \leq m, y = l + 1\}$, $V(G_3) = \{d + 1 \leq x \leq d + k + 1, y = l + 1\}$, $G_1 = L(m, n, k', l')$, $k' = m - d$, $l' = l + 1$, and $s, t \in G_2$. Consider Fig. 30(e). Clearly, G_2 is odd-sized and G_1 and G_3 are even-sized. Here, G_2 is a L -shaped grid subgraph $L(m', n', k', l')$, where $m' = m - d - k$, $n' = l + 1$, $k' = 1$, and $l' = 1$. By Lemma 3.1, (G_2, s, t) is color-compatible. Since $l > 1$ and $n' = l + 1$, we have that $n' \geq 4$. Also, since $m' - k' \geq 3$ and $n' - l' \geq 3$, it is clear that (G_1, s, t) is not in conditions (F1), (F3), and (F5), and hence (G_2, s, t) is acceptable. The Hamiltonian path in $(C(m, n, k, l), s, t)$ is obtained similar to Subcase 3.1.4 of Lemma 4.2; see Fig. 31(a). Note that, here, since G_1 is an even-sized L -shaped grid subgraph, and by Lemma 2.5 has a Hamiltonian cycle. The pattern for constructing a Hamiltonian cycle in G_1 is shown in Fig. 31(a). Moreover since $m' - k' \geq 3$, there is at least one edge for combining Hamiltonian cycle and path.

Subcase 2.4. $t_y \leq l$, $t_x > d + k$, and $[(s_x \leq d + k) \text{ or } (s_x > d + k \text{ and } s_y > l + 1)]$. This case is similar to Subcase 2.1, where $s, p \in G_1$, $q, t \in G_2$, q and p are adjacent, and $p = (m, l + 1)$. From Subcase 2.1, we know that G_1 is even-sized and G_2 is odd-sized. Since $m = \text{even}$ and $l + 1 = \text{even}$, it follows that p is white. Therefore, (G_1, s, p) and (G_2, q, t) are color-compatible. Consider (G_2, q, t) . The condition (F1) holds, if $c = 2$ and $t_y = q_y < l$. This is impossible, because of $q_y = l$. Thus, (G_2, q, t) is not in condition (F1). The condition (F2) occurs, when $l = 3$ and $q_x < t_x - 1$. Since $q_x = m$, thus (G_2, q, t) is not in condition (F2). So, (G_2, q, t) is acceptable. Consider (G_1, s, p) . The condition (F1) holds, if (i) $d = 1$ and $2 \leq s_y \leq l + 1$; (ii) $n - l = 2$ and $s = (m - 1, n)$, clearly if these condition hold, then $(C(m, n, k, l), s, t)$ satisfies condition (F1), a contradiction. Therefore, (G_1, s, p) is not in condition (F1). A simple check shows that (G_1, s, p) is not in condition (F3). (G_1, s, p) is not in condition (F5), the proof is the same as Subcase 2.1. Hence, (G_1, s, p) is acceptable. The Hamiltonian path in $(C(m, n, k, l), s, t)$ is obtained similar to Case 5 of Lemma 4.1. Here if $s_y \leq l$, $s_x, t_x > d + k$, and $t_y > l + 1$, then the role of p and q can be swapped.

Subcase 2.5. $l = 1$ and $c = \text{even} \geq 4$.

Subcase 2.5.1. $s_x, t_x \leq d + k$ and $[(n - l = 2) \text{ or } (n - l > 2 \text{ and } s \neq (d + k - 1, n) \text{ or } t \neq (d + k, n - 1))]$. This case is similar to Subcase 1.2. by the same argument as in proof Subcase 1.2, we obtain (G_1, s, t) is color-compatible and G_2 is even-sized. (G_1, s, t) is not in condition (F3) and (F5), the proof is similar to Subcase 1.2. The condition (F1) holds, if $n - l \geq 4$, $s = (d + k - 1, n)$, and $t = (d + k, n - 1)$. This is impossible, because we assume that $s \neq (d + k - 1, n)$ or $t \neq (d + k, n - 1)$. Therefore, (G_1, s, t) is acceptable. The Hamiltonian path in $(C(m, n, k, l), s, t)$ is obtained similar to Case 1 of Lemma 4.1. Now, let $n - l \geq 4$, $s = (d + k - 1, n)$, and $t = (d + k, n - 1)$. This case is similar to Subcase 4.1.2 of Lemma 4.1, where $m' = s_x$ and $p = (m', n - 2)$. It is easy to see that (G_1, s, p) and (G_2, q, t) are acceptable. The Hamiltonian path in $(C(m, n, k, l), s, t)$ is obtained similar to Subcase 4.1.2 of Lemma 4.1.

Subcase 2.5.2. $s_x, t_x > d + k$ and $d > 1$. Note that, in this case, $n - l > 2$.

Subcase 2.5.2.1. $n - l > 4$. This case is the same as Case 1 of Lemma 4.2, where $l' = l + 2$. Since $n' = l' - l = \text{even}$, it follows that G_2 is even-sized. Moreover, since $C(m, n, k, l)$ is odd-sized, we conclude that G_1 is odd-sized. By Lemma 3.1, (G_1, s, t) is color-compatible. Since $s_x, t_x > d + k$, $c \geq 4$, and $n - l \geq 4$, it is clear that (G_1, s, t) is not in conditions (F1), (F3), (F10)-(F15), and (F17). Therefore, (G_1, s, t) is acceptable. In this case, (G_1, s, t) is in Subcase 2.1 or 2.3. Now, we show that $(C(m, n, k, l), s, t)$ has a Hamiltonian path. Let $k > 1$, then the Hamiltonian path in

$(C(m, n, k, l), s, t)$ is obtained similar to Case 1 of Lemma 4.1. Note that since $k = \text{odd} \geq 3$, there is at least one edge for combining Hamiltonian cycle and path. Now, Let $k = 1$, then the Hamiltonian path in $(C(m, n, k, l), s, t)$ is obtained similar to Case 2 of Lemma 4.1. Notice that, in this case we can always construct a Hamiltonian path P in G_1 that contains a subpath P_1 , as shown Fig. 31(b). The pattern for constructing a Hamiltonian path in G_1 is shown in Fig. 31(c).

Subcase 2.5.2.2. $n - l = 4$. In this case, $s_x = d + k + 1$ or $t_x = d + k + 1$.

Subcase 2.5.2.2.1. $s_x, t_x \leq d + k + 2$ and $[(s \neq (d + k + 1, 1) \text{ or } t \neq (d + k + 2, l + 1)) \text{ or } (s \neq (d + k + 1, n) \text{ or } t \neq (d + k + 2, n - 1))]$. This case is the same as Case 3 of Lemma 4.1. A simple check shows that (G_1, s, t) is acceptable. In this case (G_1, s, t) is in Subcase 1.1 or 2.2.3. The Hamiltonian path in $(C(m, n, k, l), s, t)$ is obtained similar to Case 3 of Lemma 4.1. Notice that, since $n - l = 4$ and $l = 1$, we have $n = 5$.

Subcase 2.5.2.2.1.1. $s = (d + k + 1, 1)$ and $t = (d + k + 2, l + 1)$. This case is the same as Subcase 2.4.

Subcase 2.5.2.2.1.2. $s = (d + k + 1, n)$ and $t = (d + k + 2, n - 1)$. Let $\{G_1, G_2, G_3\}$ be a C -shaped separation (type IV) of $C(m, n, k, l)$ such that $G_1 = L(m', n, k, l)$, where $m' = d + k$, $G_2 = R_1(m'', n')$, where $V(G_2) = \{d + k + 1 \leq x \leq m - 1 \text{ and } l + 2 \leq y \leq l + 3\}$, and $G_3 = C(m, n, k, l) \setminus (G_1 + G_2)$. Let $s, p \in G_3$, $q, t \in G_2$, $w, z \in G_1$, w and p and q and z are adjacent, $p = (d + k + 1, l + 1)$, and $q = (d + k + 1, n - 1)$ (see Fig. 31(e)). It is known that (G_3, s, p) , (G_2, q, t) , and (G_1, w, z) are acceptable. In this case, (G_3, s, p) is in Subcase 5.1 of Lemma 4.1. The Hamiltonian path in $(C(m, n, k, l), s, t)$ is obtained similar to Subcase 2.2.3.

Subcase 2.5.2.2.2. $s_x = d + k + 1$ and $t_x > d + k + 2$. This case is the same as Subcase 2.5.2.2.1., where $s, p \in G_1$, $q, t \in G_2$, q and p are adjacent, and

$$p = \begin{cases} (d + k + 2, n - 1); & \text{if } [(m - m' > 2) \text{ or } (m - m' = 2 \text{ and } t \neq (m, n - 1))] \\ (d + k + 2, l + 1); & \text{if } m - m' = 2, t = (m, n - 1), \text{ and } s \neq (d + k + 1, 1) \end{cases}$$

Since $d + k + 2 = \text{even}$ and $l + 1 = \text{even}$ or $n - 1 = \text{even}$, clearly p is white. Thus, (G_1, s, p) and (G_2, q, t) are color-compatible. In this case, G_2 is even \times odd. Since $n = 5$, (G_2, q, t) is not in condition (F2). A simple check shows that (G_2, q, t) is not in condition (F1). Therefore, (G_2, q, t) is acceptable. Now, consider (G_1, s, p) . Since $d > 1$, $n - l = 4$, $c' = 2$, and $s_x, p_x > d + k$, it suffices to prove that (G_1, s, p) is not in condition (F1). The condition (F1) holds, if $s = (d + k + 1, 1)$ and $p = (d + k + 2, l + 1)$. By the assumption, this is impossible, and hence (G_1, s, p) is not condition (F1). So, (G_1, s, p) is acceptable. In this case, (G_1, s, p) is in Subcase 2.1 or 2.2.3. The Hamiltonian path in $(C(m, n, k, l), s, t)$ is obtained similar to Case 5 of Lemma 4.1. Now let $m - m' = 2$, $s = (d + k + 1, 1)$, and $t = (m, n - 1)$. This case is similar to Subcase 2.4.

Subcase 2.5.3. $s_x \leq d + k$ and $t_x > d + k$. This case is similar to Subcase 1.4.1, where $p = (d + k, l + 1)$ if $s \neq (d + k, l + 1)$; otherwise $p = (d + k, l + 3)$. \square

Theorem 4.4. *The cases that are mentioned in Lemmas 4.1–4.3 include all possible cases that may occur in $(C(m, n, k, l), s, t)$.*

Proof. Consider the following cases.

Case 1. $C(m, n, k, l)$ is even-sized.

Subcase 1.1. ($n = \text{even}$) or ($n = \text{odd}$ and $[(m = \text{odd}) \text{ or } (m = \text{even} \text{ and } c \text{ and } d \text{ are even})]$).

Subcase 1.1.1. ($s_x, t_x \leq d + k$), ($s_x, t_x > d + k$), or ($d + 1 \leq s_x \leq d + k$ and $t_x > d + k$).

Subcase 1.1.1.1. $n = \text{even}$. $(C(m, n, k, l), s, t)$ is in Case 1 or 2 of Lemma 4.1.

Subcase 1.1.1.2. $n = \text{odd}$.

Subcase 1.1.1.2.1. $m = \text{even}$. $(C(m, n, k, l), s, t)$ is in Case 1 of Lemma 4.1.

Subcase 1.1.1.2.2. $m = \text{odd}$. $(C(m, n, k, l), s, t)$ is in Case 1, 2, or 3 of Lemma 4.1.

Subcase 1.1.2. $s_x \leq d$ and $t_x > d + k$. $(C(m, n, k, l), s, t)$ is in Subcase 5.1 of Lemma 4.1.

Subcase 1.2. $n = \text{odd}$, $m = \text{even}$, and $[c = \text{odd} \text{ or } d = \text{odd}]$.

Subcase 1.2.1. c, d , and $n - l$ are odd.

Subcase 1.2.1.1. $s_x, t_x \leq d + 1$ or $s_x, t_x > d + 1$. $(C(m, n, k, l), s, t)$ is in Subcase 4.1.1 of Lemma 4.1.

Subcase 1.2.1.2. $s_x \leq d + 1$ or $t_x > d + 1$. $(C(m, n, k, l), s, t)$ is in Subcase 4.1.2 or 5.2 of Lemma 4.1.

Subcase 1.2.2. $n - l = \text{odd}$ and $[(d = \text{odd} \text{ and } c = \text{even}) \text{ or } (d = \text{even} \text{ and } c = \text{odd})]$.

Subcase 1.2.2.1. ($s_x, t_x \leq d + k$), ($s_x, t_x > d + k$), or ($d + 1 \leq s_x \leq d + k$ and $t_x > d + k$). $(C(m, n, k, l), s, t)$ is in Subcase 4.2 of Lemma 4.1.

Subcase 1.2.2.2. $s_x \leq d$ and $t_x > d + k$. $(C(m, n, k, l), s, t)$ is in Case 5 of Lemma 4.1.

Subcase 1.2.3. $c = \text{odd}$, $d = \text{odd}$, and $n - l = \text{even}$.

Subcase 1.2.3.1. $n - l = 2$.

Subcase 1.2.3.1.1. $(s_x, t_x \leq d + k)$, $(s_x, t_x > d + k)$, or $(d + 1 \leq s_x \leq d + k$ and $t_x > d + k)$. By Theorem 3.3, this case does not occur.

Subcase 1.2.3.1.2. $s_x \leq d$ or $t_x > d + k$. $(C(m, n, k, l), s, t)$ is in Subcase 5.2 of Lemma 4.1.

Subcase 1.2.3.2. $n - l = 4$ or $n - l = 6$.

Subcase 1.2.3.2.1. $s_x, t_x \leq d$ or $s_x, t_x > d + k$. $(C(m, n, k, l), s, t)$ is in Case 1 of Lemma 4.2.

Subcase 1.2.3.2.2. $(s_x \leq d$ and $t_x > d)$, $(d + 1 \leq s_x \leq d + k$ and $t_x > d + k)$, or $(d + 1 \leq s_x, t_x \leq d + k)$.

Subcase 1.2.3.2.2.1. $n - l = 4$. $(C(m, n, k, l), s, t)$ is in Case 2 of Lemma 4.2.

Subcase 1.2.3.2.2.2. $n - l = 6$. $(C(m, n, k, l), s, t)$ is in Case 3 of Lemma 4.2.

Subcase 1.2.3.3. $n - l > 6$.

Subcase 1.2.3.3.1. $s_y, t_y > l + 5$. $(C(m, n, k, l), s, t)$ is in Subcase 4.1 of Lemma 4.2.

Subcase 1.2.3.3.2. $s_y, t_y \leq l + 5$. $(C(m, n, k, l), s, t)$ is in Subcase 4.2 of Lemma 4.2.

Subcase 1.2.3.3.3. $s_y \leq l + 5$ and $t_y > l + 5$ (or $t_y \leq l + 5$ and $s_y > l + 5$). $(C(m, n, k, l), s, t)$ is in Subcase 4.3 of Lemma 4.2.

Case 2. $C(m, n, k, l)$ is odd-sized.

Subcase 2.1. $n = \text{even}$.

Subcase 2.1.1. $(s_x, t_x \leq d + k)$, $(s_x, t_x > d + k)$, or $(d + 1 \leq s_x \leq d + k$ and $t_x > d + k)$. $(C(m, n, k, l), s, t)$ is in Subcase 1.2 of Lemma 4.3.

Subcase 2.1.2. $s_x \leq d$ and $t_x > d + k$. $(C(m, n, k, l), s, t)$ is in Subcase 1.4 of Lemma 4.3.

Subcase 2.2. $n = \text{odd}$.

Subcase 2.2.1. $m = \text{odd}$.

Subcase 2.2.1.1. $l = \text{even}$.

Subcase 2.2.1.1.1. $(s_x, t_x \leq d + k)$, $(s_x, t_x > d + k)$, or $(d + 1 \leq s_x \leq d + k$ and $t_x > d + k)$. $(C(m, n, k, l), s, t)$ is in Subcase 1.1 of Lemma 4.3.

Subcase 2.2.1.1.2. $s_x \leq d$ and $t_x > d + k$. $(C(m, n, k, l), s, t)$ is in Subcase 1.4 of Lemma 4.3.

Subcase 2.2.1.2. $l = \text{odd}$. Notice that, in this case, $d = \text{odd}$ and $c = \text{even}$. By symmetry, the case $d = \text{even}$ and $c = \text{odd}$ has been removed.

Subcase 2.2.1.2.1. $s_x, t_x \leq d + k$. $(C(m, n, k, l), s, t)$ is in Subcase 1.2 of Lemma 4.3.

Subcase 2.2.1.2.2. $s_x, t_x > d + k$. $(C(m, n, k, l), s, t)$ is in Subcase 1.3 of Lemma 4.3.

Subcase 2.2.1.2.3. $s_x \leq d + k$ and $t_x > d + k$. $(C(m, n, k, l), s, t)$ is in Subcase 1.4 of Lemma 4.3.

Subcase 2.2.2. $m = \text{even}$. Notice that, in this case, $d = \text{odd}$ and $c = \text{even}$. By symmetry, the case $d = \text{even}$ and $c = \text{odd}$ has been removed.

Subcase 2.2.2.1. $(l > 1$ and $c > 2)$ or $(c \geq 2)$.

Subcase 2.2.2.1.1. $(s_x, t_x \leq d + k)$, $(s_x, t_x > d + k$ and $s_y, t_y > l)$ or $(s_x \leq d + k, t_x > d + k,$ and $t_y > l)$. $(C(m, n, k, l), s, t)$ is in Subcase 2.1 or 2.2 of Lemma 4.3.

Subcase 2.2.2.1.2. $s_x, t_x > d + k$ and $s_y, t_y \leq l + 1$. $(C(m, n, k, l), s, t)$ is in Subcase 2.3 of Lemma 4.3.

Subcase 2.2.2.1.3. $(t_x > d + k, t_y \leq l,$ and $[(s_x \leq d + k)$ or $(s_x > d + k$ and $s_y > l + 1)])$ or $(s_x, t_x > d + k, s_y \leq l,$ and $t_y > l)$. $(C(m, n, k, l), s, t)$ is in Subcase 2.4 of Lemma 4.3.

Subcase 2.2.2.2. $l = 1$ and $c > 2$.

Subcase 2.2.2.2.1. $s_x, t_x \leq d + k$. $(C(m, n, k, l), s, t)$ is in Subcase 2.5.1 of Lemma 4.3.

Subcase 2.2.2.2.2. $s_x, t_x > d + k$. $(C(m, n, k, l), s, t)$ is in Subcase 2.5.2 of Lemma 4.3.

Subcase 2.2.2.2.3. $s_x \leq d + k$ and $t_x > d + k$. $(C(m, n, k, l), s, t)$ is in Subcase 2.5.3 of Lemma 4.3.

All possible cases are exhausted, and the proof of Theorem 4.4 is completed. \square

By Theorem 3.3 and Lemmas 4.1– 4.3, we have the following result:

Theorem 4.5. $C(m, n, k, l)$ has a Hamiltonian (s, t) -path if and only if $(C(m, n, k, l), s, t)$ is acceptable.

In the following theorem, we state the main result of this paper:

Theorem 4.6. In an acceptable $(L(m, n, k, l), s, t)$, a Hamiltonian (s, t) -path can be found in linear time.

Proof. The algorithm construct a Hamiltonian (s, t) -path in $C(m, n, k, l)$ via the following three steps.

Step 1 : It divides $C(m, n, k, l)$ into some grid subgraphs, by Lemmas 4.1–4.3, in $O(1)$ time.

Step 2 : It finds a Hamiltonian path or cycle in these grid subgraphs by algorithm [2] or [14]. This step takes linear time.

Step 3 : It combines Hamiltonian paths and cycles for constructing a Hamiltonian (s, t) -path, by Lemmas 4.1–4.3, in $O(1)$ time.

Thus, the algorithm has a linear-time complexity. \square

5. Conclusion

We gave necessary and sufficient conditions for the existence of a Hamiltonian path in C -shaped grid graphs between two given vertices, which are a special type of solid grid graphs. The Hamiltonian path problem is NP-complete in general grid graphs [10], it remains open if the problem is polynomially solvable in solid grid graphs. Further study can be done on the Hamiltonian path problem in other special classes of graphs, in order to find way to solve the problem for solid grid graphs.

References

- [1] F.N. Afrati, The Hamilton circuit problem on grids, *Theoretical Informatics and Applications* 28 (6) (1994) 567-582.
- [2] S.D. Chen, H. Shen, and R. Topor, An efficient algorithm for constructing Hamiltonian paths in meshes, *Parallel Computing* 28 (9) (2002) 1293-1305.
- [3] L. Du, A polynomial time algorithm for Hamiltonian cycle (path), in: *Proceedings of the International MultiConference of Engineers and Computer Scientists, IMECS, (I) 2010*, pp. 17-19.
- [4] S. Felsner, G. Liotta, and S. Wismath, Straight-line drawings on restricted integer grids in two and three dimensions, *Journal of Graph Algorithms and Applications* 7 (4) (2003) 363-398.
- [5] M.R. Garey and D.S. Johnson, *Computers and intractability: a guide to the theory of NP-completeness*, Freeman, San Francisco, CA, 1979.
- [6] V.S. Gordon, Y.L. Orlovich, and F. Werner, Hamiltonian properties of triangular grid graphs, *Discrete Mathematics* 308 (24) (2008) 6166-6188.
- [7] K. Hamada, A picturesque maze generation algorithm with any given endpoints, *Journal of Information Processing* 21 (3) (2013) 393-397.
- [8] C. Icking, T. Kamphans, R. Klein, and E. Langetepe, Exploring simple grid polygons, in: *Proceedings of 11th Annual International Computing and Combinatorics Conference, COCOON, 2005*, pp. 524-533.
- [9] K. Islam, H. Meijer, Y.N. Rodriguez, D. Rappaport, and H. Xiao, Hamiltonian circuits in hexagonal grid graphs, in: *Proceedings of 19th Canadian Conference of Computational Geometry, CCCG'97, 2007*, pp. 85-88.
- [10] A. Itai, C.H. Papadimitriou, and J.L. Szwarcfiter, Hamiltonian paths in grid graphs, *SIAM Journal on Computing* 11 (4) (1982) 676-686.
- [11] F. Keshavarz-Kohjerdi and A. Bagheri, Hamiltonian paths in some classes of grid graphs, *Journal of Applied Mathematics* (2012) 475087.
- [12] F. Keshavarz-Kohjerdi, A. Bagheri, and A. Asgharian-Sardroud, A linear-time algorithm for the longest path problem in rectangular grid graphs, *Discrete Applied Mathematics* 160 (3) (2012) 210-217.
- [13] F. Keshavarz-Kohjerdi and A. Bagheri, A parallel algorithm for the longest path problem in rectangular grid graphs, *The Journal of Supercomputing* 65 (2013) 723-741.
- [14] F. Keshavarz-Kohjerdi and A. Bagheri, Hamiltonian paths in L -shaped grid graphs, *Theoretical Computer Science* 621 (2016) 37-56.
- [15] W. Lenhart and C. Umans, Hamiltonian cycles in solid grid graphs, in: *Proceedings of 38th Annual Symposium on Foundations of Computer Science, FOCS '97, 1997*, pp. 496-505.
- [16] M.S. Rahman and M. Kaykobad, On Hamiltonian cycles and Hamiltonian paths, *Information Processing Letters* 94 (1) (2005) 37-41.
- [17] A.N.M. Salman, H.J. Broersma, and E.T. Baskoro, Spanning 2-connected subgraphs in alphabet graphs, special classes of grid graphs, *Journal of Automata, Languages and Combinatorics* 8 (4) (2003) 675 - 681.
- [18] A.S.R. Srinivasa Rao, F. Tomleyc, and D. Blakec, Understanding chicken walks on $n \times n$ grid: Hamiltonian paths, discrete dynamics, and rectifiable paths, *Mathematical Methods in the Applied Sciences* 38 (15) (2015) 3346-3358.
- [19] C. Zamfirescu and T. Zamfirescu, Hamiltonian properties of grid graphs, *SIAM Journal Discrete Mathematics* 5 (4) (1992) 564-570.
- [20] W.Q. Zhang and Y.J. Liu, Approximating the longest paths in grid graphs, *Theoretical Computer Science* 412 (39) (2011) 5340-5350.