

# On the Capacity of the Dirty Paper Channel with Fast Fading and Discrete Channel States

Stefano Rini \* and Shlomo Shamai (Shitz) †

\* National Chiao-Tung University, Hsinchu, Taiwan

E-mail: stefano@nctu.edu.tw

† Technion-Israel Institute of Technology, Haifa, Israel

E-mail: sshlomo@ee.technion.ac.il

**Abstract**—The “writing dirty paper” capacity result crucially depends on the perfect channel knowledge at the transmitter as the presence of even a small uncertainty in the channel realization gravely hampers the ability of the transmitter to pre-code its transmission against the channel state. This is particularly disappointing as it implies that interference pre-coding in practical systems is effective only when the channel estimates at the users have very high precision, a condition which is generally unattainable in wireless environments. In this paper we show that substantial improvements are possible when the state sequence is drawn from a discrete distribution, such as a constrained input constellation, for which state decoding can be approximatively optimal. We consider the “writing on dirty paper” channel in which the state sequence is multiplied by a fast fading process and derive conditions on the fading and state distributions for which state decoding closely approaches capacity. These conditions intuitively relate to the ability of the receiver to correctly identify both the input and the state realization despite of the uncertainty introduced by fading.

**Index Terms**—Gel’fand-Pinsker Problem; Carbon Copying onto Dirty Paper; Costa Pre-Coding;

## INTRODUCTION

Although interference pre-cancellation is well understood in information theoretical settings, practical implementations of this coding strategy have yet to find widespread adoption in practical communication systems. Currently, interference pre-coding can be found only in a few communication standards, usually in its incarnation as Tomlinson-Harashima pre-coding [1], [2]. The performance of this implementation is rather low, as compared to the very elegant solution using LDPC codes and or trellis-coded quantization [3]. One is then bound to wonder as of why high-performing interference pre-cancellation strategies have yet to have a significant impact on communication systems. The the answer to this question possibly lays in the intrinsic fragility of this coding technique which relies on the specific way in which the desired signal combines with the interference and is thus heavily affected by channel uncertainty. Many communication systems, instead, utilize interference decoding, which is intuitively a more robust interference management strategy when lacking adequate channel knowledge. This technique also takes full advantage of the inherent structure of the interference signal, which is

often drawn from a finite-rate codebook, as investigated in [4], and/or transmitted using a fixed constellation. In this correspondence we focus on the latter case and derive the conditions under which interference decoding is provably close to optimal in the presence of fading and partial channel knowledge.

**Literature Review:** The Gel’fand-Pinsker (GP) channel [5] is a very comprehensive model which, generally speaking, can accommodate for variations of the “Writing on Dirty Paper” (WDP) channel to include channel uncertainty and partial side-information. Unfortunately the capacity of the GP channel is expressed as non-convex maximization and a closed-form expression of capacity is available only for a handful of models. For this reason, determining the capacity of variations of Costa’s original setup is a challenging task. In [6], the authors study the WDP in which the input and the state sequences are multiplied by the same fading coefficient. Here in is shown that the rate loss from full state pre-cancellation is vanishing, since state and input still combine in a predictable manner. In [7], we derived the approximate capacity for the WDP channel in which the state is multiplied by uniform binomial fading by further develop bounding techniques originally developed in [8]. The results in [7] are further extended in [9] to include more general fading distribution, although restricted to the case of discrete support.

**Contributions:** We investigate the capacity of the “Writing of Fast Fading Dirt” (WFFD) channel, a variation of the WDP channel in which the state sequence is multiplied by a fast fading process. The state realization is assumed to be drawn from a discrete set of values and thus the receiver can attempt to decode both the state and the input realization. For both models we derive conditions on the support of the fading and state distribution for which state decoding is approximatively optimal. The main contribution is the development of an outer bound which provides sufficient conditions under which state decoding is close to optimal. We consider both the case of *No Channel Side Information* (NCSI) in which fading is not know at either the transmitter or the receiver and the case of *Receiver Channel Side Information* (RCSI) in which fading is known an the receiver only.

**Organization:** The remainder of the paper is organized as follows: Sec. I introduces the channel model while Sec. II presents relevant results available in the literature. Sec. III considers the case of no fading knowledge at either the

The work of S. Rini was funded by the Ministry Of Science and Technology (MOST) under the grant 103-2218-E-009-014-MY2. The work of S. Shamai was supported by the Israel Science Foundation (ISF).

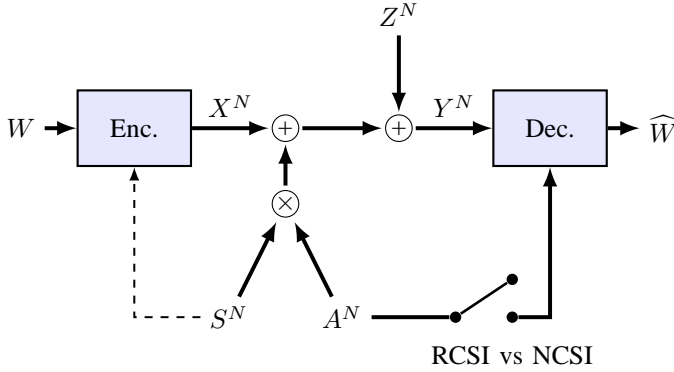

Fig. 1: “Writing on Fast Fading Dirt with No Channel Side-Information” (WFFD-NCSI) and the “Writing on Fast Fading Dirt with Receiver Channel Side-Information” (WFFD-RCSI).

transmitter or the receiver while Sec. IV focuses on the case in which only the receiver has knowledge of the fading realization. Finally, Sec. V concludes the paper.

Only sketches of the proofs are provided in the main text: the full proofs can be found in appendix.

## I. CHANNEL MODEL

The “Writing on Writing on Fast Fading Dirt” (WFFD) channel is defined as the channel in which the output is obtained as

$$Y^N = X^N + cA^N S^N + Z^N, \quad (1)$$

where the Random Variables (RV)  $S^N, A^N$  and  $Z^N$  are obtained through iid draws from the distribution  $P_S, P_A$  and  $\mathcal{N}(0, 1)$  and support  $\mathcal{S}, \mathcal{A}$  and  $\mathbb{R}$  respectively. The sequence  $S^N$  is provided non-causally to the transmitter and the channel input  $X^N$  is subject to the constraint  $\sum_i^N \mathbb{E}[X_i^2] \leq NP$ . Without loss of generality we assume that  $\text{Var}[A] = \text{Var}[S] = 1$  and  $\mu_S = 0$  so that the variance of the fading-times-state term  $cA_i S_i$  is  $c^2 \mu_A^2$ .

We further classify the WFFD channel in (1) with respect to the available channel side-information:

• **WFFD with No Channel Side-Information (WFFD-NCSI):** the fading sequence  $A^N$  is not known at either the transmitter or the receiver.

• **WFFD with Receiver Channel Side-Information (WFFD-RCSI):** the fading sequence  $A^N$  is known only at the receiver.

The WFFD-RCSI is obtained from the WFFD-NCSI by providing the sequence  $A^N$  as an additional channel output, that is

$$Y_{\text{RCSI}}^N = [Y_{\text{NCSI}}^N \ A^N], \quad (2)$$

for  $Y$  in (1). A graphical representation of these two channel models is provided in Fig. 1: the switch on the noiseless channel between  $A^N$  and the receiver indicates whether the fading side-information is available to the receiver or not. The dotted line between  $S^N$  and the transmitter represents the anti-causal channel knowledge at the transmitter. Standard definitions of rate, code, achievable rate, capacity and approximate capacity are assumed.

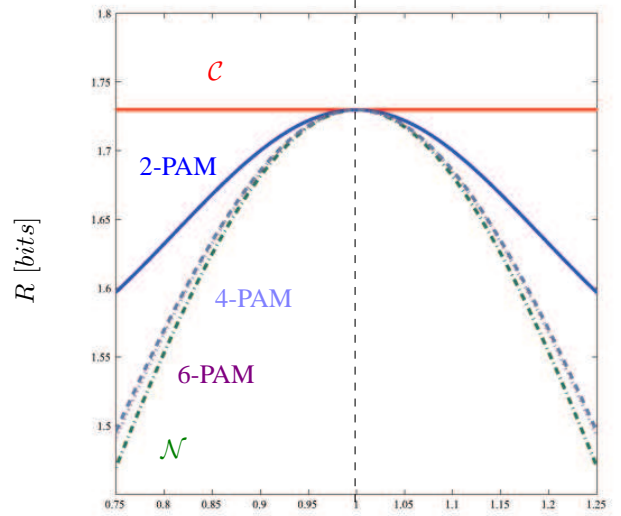

Fig. 2: The mismatch loss for  $P = 10$  and  $c = 5$  and when  $S$  is an equiprobable PAM signal (2,4 and 6-PAM) or a Gaussian sequence ( $\mathcal{N}$ ).

In the following we consider the case in which  $\mathcal{S}$  is a discrete set: a recurring example is the case in which  $S^N$  is uniformly distributed over the PAM input constellation

$$S_{m\text{-PAM}} = \begin{cases} 2i\Delta_m, & i \in [\frac{1-m}{2} \dots \frac{m-1}{2}] & m \text{ even} \\ (2i+1)\Delta_m, & i \in [-\frac{m}{2} \dots \frac{m}{2} - 1] & m \text{ odd} \end{cases} \quad (3)$$

for  $\Delta_m = \sqrt{3/(m^2-1)}$  which guarantees  $\text{Var}[S] = 1$  and  $\mu_S = 0$  as by assumption.

## II. RELATED RESULTS

• **“Gelfand-Pinsker” (GP) channel:** The capacity of the GP channel [5] is a classic result and is expressed as

$$C = \max_{P_{U,X|S}} (I(Y;U) - I(U;S)). \quad (4)$$

The capacity of both the WFFD-NCSI and the WFFD-RCSI can be evaluated through (4). Unfortunately the expression in (4) is convex in  $P_{X|S,U}$  for a fixed  $P_{U|S}$  but neither convex nor concave in  $P_{U|S}$  for a fixed  $P_{X|S,U}$ : consequently this expression cannot be easily obtained in a closed-form or numerically approximated.

• **“Writing on Dirty Paper” (WDP) channel:** Consider a WDP channel and assume that, given the imperfect channel knowledge at the transmitter, the encoder believes the state sequence to be  $ckS^N$  instead of  $cS^N$ . The rate loss due to the imperfect channel estimation can be readily evaluated as in Fig. 2. The largest rate loss corresponds to the case in which  $S$  is Gaussian distributed, in which case

$$C - R^{\text{DPC } \mathcal{N}}(k) = \frac{1}{2} \log \left( 1 + \frac{Pa^2}{P + a^2 + 1} (k-1)^2 \right), \quad (5)$$

and is obtained from the expression in (4) by letting  $U = [X \ S]$  while the rate loss is increasing with  $m$  when  $S$  is an equiprobable m-PAM.

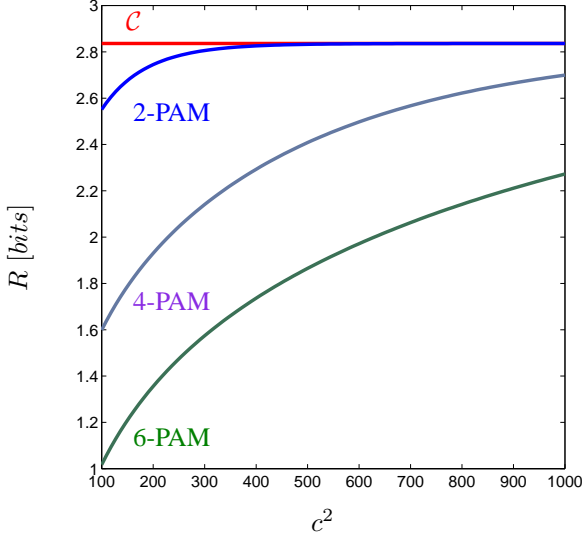

Fig. 3: The state amplification performance for transmit  $P = 100$  and state power  $c^2 \in [10^2 \dots 10^3]$  for the case in which the state has is PAM constellation (2,4 and 6-PAM).

• **GP channel with state amplification:** The GP channel in the case in which the transmitter is required to decode both the transmitted message and the channel state is known as GP with “state amplification” [10]. The largest transmission rate  $R$  that can be attained in this channel

$$R^{\text{IN-SA}} = \max_{P_{X|S}} I(Y; X, S) - H(S), \quad (6)$$

and corresponds to the expression in (4) for the choice  $U = [X \ S]$ , that is the decoded message corresponds to both the channel input and the state. This is the attainable rate in a point-to-point channel in which two codewords,  $X^N$  at rate  $R$  and  $S^N$  at rate  $H(S)$ , are transmitted over the channel.

### III. WFFD-NCSI CHANNEL

In the WFFD-NCSI neither the transmitter nor the receiver have knowledge of the exact way in which the channel input collides with the fading-times-state term  $cA^N S^N$ . For this reason, pre-coding as in the WDP channel is effective only when the overall variance of the term  $cA^N S^N$  is small, in which case the users still incur in a loss similar to the one in (5). An alternative strategy is for the receiver to decode both the state realization, along with the transmitted message. To facilitate this, the transmitter can restrict its input to a finite constellation such that the receiver can decode both  $X^N$  and  $S^N$  from the channel output, as shown in Fig. 4. This figure conceptually represent how the fading affects the channel output: the random effect of  $A$  is to “spread” the value  $cAS$  in an interval around the values  $c\mu_A S$ . By restricting the channel input to be discrete and sufficiently spaced apart, the support of  $X + cAS$  is composed of non-overlapping sets for different  $X$  and  $S$ , regardless of the realization of  $A$ . When the minimum distance between these sets is sufficiently large,

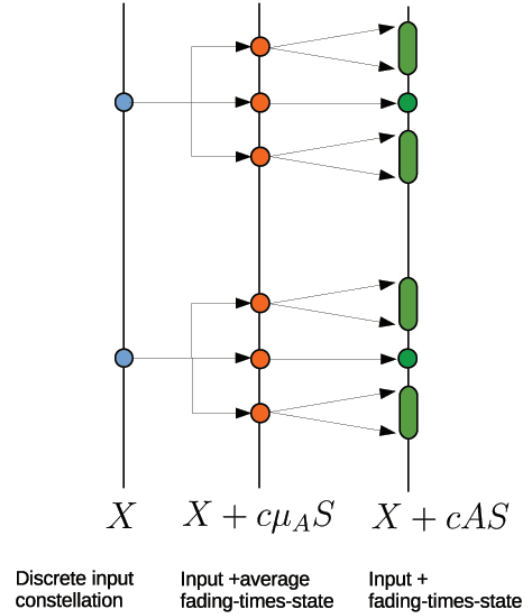

Fig. 4: A representation of the output space in the WRDP-NCSI channel with discrete state.

the receiver can decode both  $X$  and  $S$  from  $Y$  with high probability. This intuition is formalized in the next theorem.

#### Theorem III.1. Outer bound and approximate capacity for the WFFD-NCSI with discrete state.

Consider the WFFD-NCSI in Fig. 1 with  $P, c^2 > 1$  and for  $S$  and  $\mathcal{A}$  such that

$$s, \tilde{s} \in \mathcal{S}, s > \tilde{s}, a, \tilde{a} \in \mathcal{A} \quad |i - cas - \tilde{a}\tilde{s}| > \frac{1}{2}, \quad (7)$$

$$i \in [-2\lceil\sqrt{P}\rceil \dots + 2\lceil\sqrt{P}\rceil]$$

then capacity  $\mathcal{C}$  is upper bounded as

$$\mathcal{C} \leq R^{\text{OUT}} = \max_{P_{X|S}} I(Y; X, S) - H(S) + 4, \quad (8)$$

and the exact capacity is to within 15 bpcu from the outer bound in (8).

*Proof:* See App. VI. ■

The conditions in (7) indeed reflect the interpretation in Fig. 4: this term is the smallest distance between two contiguous regions in  $X + cAS$  when  $X$  is restricted to be an integer number in  $[-\lceil\sqrt{P}\rceil \dots + \lceil\sqrt{P}\rceil]$ . This follows from the fact that restricting the input to this interval has a small effect on capacity, both from the inner and the outer bound perspective.

The main challenge in proving Th. III.1 is in the bounding thorough a closed-form expression of the capacity of WFFD-NCSI as obtained from the capacity of the GP channel in (4). Note that

$$I(U; Y) - I(U; S) = I(X, S; Y) - H(S) + H(S|Y, U), \quad (9)$$

so that the state amplification lower bound in (6) is close to capacity when  $H(S|Y, U)$  is close to zero. Determining

the optimality of state decoding therefore entails showing that the entropy of  $H(S|Y, U)$  is small for the optimal choice of  $P_{XU|S}$  in (4). To prove this we build upon an outer bounding technique originally introduced in [11] which itself stems from the earlier work of [12] on the deterministic approximation of AWGN multi-terminal channels.

As an example of the conditions in (7) consider the case in which  $S$  is a  $m$ -PAM sequence (assume  $m$  even for convenience) while  $A$  has a continuous uniform distribution: by restricting the channel input to an integer constellation, the term  $X + cAS$  has support  $\bigcup_{ij} \mathcal{R}_{ij}$  for

$$\mathcal{R}_{ij} = [i + 2j\Delta_m c(\mu_A - \sqrt{3}), i + 2j\Delta_m c(\mu_A + \sqrt{3})j], \quad (10)$$

with  $j \in [-\lfloor \sqrt{P} \rfloor \dots \lfloor \sqrt{P} \rfloor]$  and  $i \in [\frac{1-m}{2} \dots \frac{m-1}{2}]$ . Any value of  $c$  and  $\mu_A$  which guarantees that the above regions are separated of more than one half, satisfies the condition in (7). A less general result can be obtained by requiring the specific order in which the subsets in (10). For instance we could require that  $\mathcal{R}_{ij} < \mathcal{R}_{i(j+1)} < \mathcal{R}_{(i+1)1}$  or equivalently  $i + cAs \leq i + cA(s + 2\Delta_m) \leq (i + 1) + cA(1 - m)\Delta_m$  for all values of  $A$ . For this ordering of the sets  $\mathcal{R}_{ij}$ , the minimum distance between two contiguous sets  $\mathcal{R}_{ij}$  is

$$\min \left\{ 2\Delta_m c(\mu_A - (2i - 1)\sqrt{3}), 1 - 4\Delta_m c(m - 1)\mu_A \right\}, \quad (11)$$

and the result in Th. III.1 applies when  $D > 1/2$ .

#### IV. WFFD-RCSI CHANNEL

In the WFFD-RCSI the receiver fading knowledge reduces the uncertainty on the way in which the input and state combine to produce the channel output. Unfortunately state pre-coding as in the WDP channel appears to still not be feasible as no known distributed strategy can produce a signal in which the input and the channel state sum in away which is predictable for the transmitter [13]. On the other hand, when the state is drawn from a discrete support, state decoding remains a natural transmission strategy to be considered. In this model, given the additional fading knowledge, the receiver knows which linear combination of the input and state it observes in the channel output, although both the input and the channel states remain unknown. This is conceptually represented in presented in Fig. 5: as for the WFFD-NCSI, the effect of fading is to spread the value  $c\mu_A S$  in the interval  $cAS$ . While the transmitter has no knowledge of this random effect, the receiver knows which linear combination of input and state is present in the output. When the input is restricted to a finite constellation, the sum of state and input can be decoded with high probability whenever the support of  $X + aS$  is composed of sufficiently separated elements for all possible  $a \in \mathcal{A}$ . The difference between state decoding in the WFFD-NCSI and WFFD-RCSI can be visualized by comparing Fig. 4 and Fig. 5: since the receiver in the WFFD-RCSI has knowledge of  $A$ , it does not need to account for the ‘‘spread’’ of the value  $cAS$  but instead has to know that these values are distinguishable for all possible realizations  $A = a$ . As for Th. III.1, the next theorem formalizes this intuition.

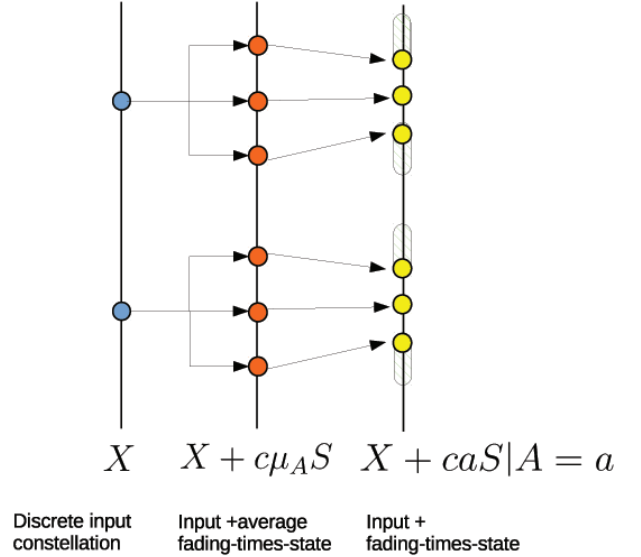

Fig. 5: A representation of the output space in the WRDP-RCSI channel with discrete state.

#### Theorem IV.1. Outer bound and approximate capacity for some discrete state distributions.

Consider the WFFD-RCSI in Fig. 1 with  $P, c^2 > 1$  and for  $S$  and  $A$  such that

$$\min_{s, a, i \in [-2\lfloor \sqrt{P} \rfloor \dots + 2\lfloor \sqrt{P} \rfloor]} |i - ca(s - \tilde{s})| > \frac{1}{2}, \quad (12)$$

then capacity  $\mathcal{C}$  is upper bounded as

$$\mathcal{C} \leq R^{\text{OUT}} = \max_{P_{X|S}} I(Y; X, S|A) - H(S) + 6, \quad (13)$$

and the exact capacity is to within 6 bpcu from the outer bound in (13).

*Proof:* See App. VII. ■

Th. IV.1 is the analog of Th. III.1 for the WFFD-RCSI and again the main contribution is the developing an outer bound to the capacity expression in (4) which matches the state decoding inner bound. The difference in the conditions of Th. IV.1 and those in Th. III.1 also reflects the difference between Fig. 5 and Fig. 4: since the receiver knows the realization  $A = a$ , the elements that must be distinguished are the terms in  $X + caS$  instead of the interval  $X + cAS$ .

It is interesting to compare the performance of the WFFD-RCSI with the performance of the same model but where the transmitter does not have anti-causal knowledge of the state sequence.

#### Lemma IV.2. Performance without transmitter state knowledge.

If the transmitter does not possess state anti-causal knowledge of  $S^N$ , then the capacity of the WFFD-RCSI can be outer bounded as

$$\mathcal{C} = \max_{P_X} I(Y; X|A). \quad (14)$$

The result in Lem. IV.2 follows naturally from the point-to-

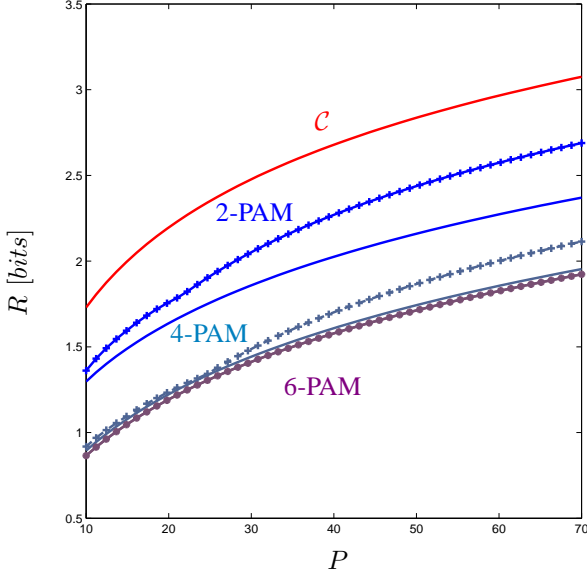

Fig. 6: Attainable rates with Gaussian signaling for the case of no transmitter state information knowledge (plain lines) versus the case of transmitter state knowledge (dotted lines) for  $c = 2$ ,  $A \sim \mathcal{N}(0, 1)$  and  $P \in [10, 70]$ .

point capacity result. The RHS of (12) can be rewritten as

$$I(Y; X, S|A) - H(S) = I(Y; X|A) - H(S|X, A, Y), \quad (15)$$

and, by comparing (15) to (13), one would be tempted to conclude that channel knowledge does not provide much rate advantages. It must be noted that the maximization in (13) and (14) are performed over two different set of distributions: the first maximization is over  $P_{X|S}$  while the latter is over  $P_X$ . In general, it is not easy to determine the rate improvement provided by this enlarged optimization set, especially because linear strategies are usually not optimal. To illustrate this point, we can again return to the example where  $S$  is a 2-PAM sequence while  $A$  is uniformly distributed with mean  $\mu_A$ : when state knowledge is available at the transmitter, it can use part of its power to remove the effect of the mean of the fading realization by choosing

$$\tilde{X} \sim \mathcal{N}(0, 1) \quad (16a)$$

$$X = \alpha \tilde{X} - \sqrt{1 - \alpha^2} K, \quad (16b)$$

for some RV  $K$  with zero mean and unit variance so that

$$Y|A = \alpha X + SA + K\sqrt{1 - \alpha^2} + Z. \quad (17)$$

For example the choice

$$K = \begin{cases} -1 & S = +1 \\ +1 & S = -1 \end{cases} \quad (18)$$

can be used to increase the entropy of  $Y|A$  when  $S$  is a 2-PAM sequence. The rate improvements provided by this strategy with respect to the case of no channel state information and Gaussian signaling are presented in Fig. 6 for the case in which the state sequence is an equiprobable m-PAM sequence.

## V. CONCLUSIONS

In this paper we have identified cases where interference decoding aided by an interference cognitive transmitter, which happens to be the more common practice, is close to capacity in a number of scenarios which also include fading. More specifically, we study the capacity of the “writing on fast fading dirt” channel, a variation of the classical “writing on dirty paper” channel in which the channel state is multiplied by a fast fading sequence. The channel state is also assumed to have a discrete support, modelling an interference signal from a constrained constellation. We consider two scenarios: (i) the case in which neither the transmitter nor receiver have side-information and (ii) the case in which only the receiver has knowledge of the fading process. In both cases we derive conditions on the support of the fading and state distribution so that state decoding is to within few bits from capacity. These conditions intuitively relate to the ability of the decoder to distinguish both the channel input and the state realization from the channel output, regardless of the noise realization. These models are a special case of the Gelfand-Pinsker channel for which capacity is known but expressed as the solution of a non-convex optimization problem. For this reason, our approximate capacity result entails a careful bounding of the capacity expression to yield a closed-form outer bound.

## REFERENCES

- [1] H. Harashima and H. Miyakawa, “Matched-transmission technique for channels with intersymbol interference,” *Communications, IEEE Transactions on*, vol. 20, no. 4, pp. 774–780, 1972.
- [2] M. Tomlinson, “New automatic equaliser employing modulo arithmetic,” *Electronics letters*, vol. 7, no. 5, pp. 138–139, 1971.
- [3] Y. Sun, Y. Yang, A. D. Liveris, V. Stanković, and Z. Xiong, “Near-capacity dirty-paper code design: A source-channel coding approach,” *Information Theory, IEEE Transactions on*, vol. 55, no. 7, pp. 3013–3031, 2009.
- [4] O. Simeone, E. Erkip, and S. Shamai, “On exploiting the interference structure for reliable communications,” in *Information Sciences and Systems (CISS), 2010 44th Annual Conference on*. IEEE, 2010, pp. 1–6.
- [5] S. Gel’fand and M. Pinsker, “Coding for channel with random parameters,” *Probl. Contr. Inform. Theory*, vol. 9, no. 1, pp. 19–31, 1980.
- [6] W. Zhang, S. Kotagiri, and J. N. Laneman, “Writing on dirty paper with resizing and its application to quasi-static fading broadcast channels,” in *Information Theory, 2007. ISIT 2007. IEEE International Symposium on*. IEEE, 2007, pp. 381–385.
- [7] S. Rini and S. Shamai, “The impact of phase fading on the dirty paper channel,” *arXiv preprint arXiv:1401.4236*, 2014.
- [8] A. Khisti, U. Erez, A. Lapidoth, and G. Wornell, “Carbon copying onto dirty paper,” *IEEE Trans. Inf. Theory*, vol. 53, no. 5, pp. 1814–1827, May 2007.
- [9] S. Rini and S. Shamai, “On capacity of the dirty paper channel with fading dirt in the strong fading regime,” in *Information Theory Workshop (ITW), 2014 IEEE*. IEEE, 2014, pp. 561–565.
- [10] Y.-H. Kim, A. Sutivong, and T. M. Cover, “State amplification,” *Information Theory, IEEE Transactions on*, vol. 54, no. 5, pp. 1850–1859, 2008.
- [11] A. G. Davoodi and S. A. Jafar, “Aligned image sets under channel uncertainty: Settling a conjecture by lapidoth, shamai and wigger on the collapse of degrees of freedom under finite precision CSIT,” *CoRR*, vol. abs/1403.1541, 2014. [Online]. Available: <http://arxiv.org/abs/1403.1541>
- [12] G. Bresler and D. Tse, “The two-user Gaussian interference channel: a deterministic view,” *Draft of version in Euro. Trans. Telecomm., Volume 19, Issue 4*, pp. 333–354, June 2008, 2008.
- [13] R. Zamir, “Anti-structure problems,” in *International Zurich Seminar on Communications*, 2012, p. 91.

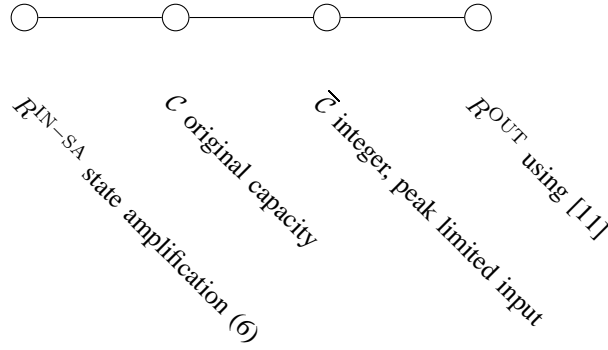

Fig. 7: A conceptual representation of the proof in Th. III.1.

## VI. PROOF OF TH. III.1.

The proof is shown by proving the outer bound in (8), since the achievability follows trivially from (6). This outer bound follows the derivation in [11] in which a similar procedure is employed to investigate the degrees of freedom of the broadcast channel with finite precision CSIT. The main difference is in that we retain the additive noise in the channel with integer, peak-limited input: this makes it possible to express the outer bound as a maximization over the same class of distribution as the inner bound in (6).

These steps are conceptually presented in Fig. 7, where

- $C$  is the actual capacity, which can be obtained through the result in (4), this value is to within small gap from  $\bar{C}$ .
- $\bar{C}$  is the capacity of the channel in which the input is restricted to integer, peak limited values. The capacity of this channel is also obtained through the result in (4) but it can be further upper bounded through  $R^{\text{OUT}}$ .
- $R^{\text{OUT}}$  is the upper bound in  $\bar{C}$  obtained through the “aligned message set” approach in [11] and which is expressed only as maximization over all the distributions  $P_{X|S}$ .
- $R^{\text{IN-SA}}$  is the state amplification inner bound in (6) and it has the same expression as  $R^{\text{OUT}}$  but for an additive term.

• **Integer, peak-limited channel:** The first step in the proof is to show that the capacity of the noiseless channel in which the inputs are restricted to be integers and peak-limited at  $\sqrt{P}$  is close in capacity to the channel of the original channel. Let

$$\bar{Y}^N = \lfloor X^N \rfloor + cA^N S^N + \bar{Z}^N \quad (19a)$$

$$E^N = Y^N - \bar{Y}^N = X^N - \lfloor X^N \rfloor - Z^N + \bar{Z}^N, \quad (19b)$$

where  $\bar{Z}^N$  has the same distribution of  $Z^N$  but is independent from it. that is,  $\bar{Y}^N$  is the WFFD-NCSI in which the input is restricted to be integer-valued and power constrained; we then have

$$N(R - \epsilon) \leq I(Y^N; W) \quad (20a)$$

$$\leq I(Y^N, E^N; W) \quad (20b)$$

$$\leq I(\bar{Y}^N, E^N; W) \quad (20c)$$

$$\leq I(\bar{Y}^N; W) + I(E^N; W | \bar{Y}^N) \quad (20d)$$

$$\leq I(\bar{Y}^N; W) + H(E^N) - H(E^N | W, X^N, \bar{Y}^N) \quad (20e)$$

$$\leq I(\bar{Y}^N; W) + \frac{N}{2} \log(2\pi e (\text{Var}(X^N - \lfloor X^N \rfloor) + 2)) - H(\bar{Z}^N - Z^N | Z^N) \quad (20f)$$

$$\leq I(\bar{Y}^N; W) + \frac{N}{2} \log(2\pi e 3) - \frac{N}{2} \log(2\pi e) \quad (20g)$$

$$\leq I(\bar{Y}^N; W) + \frac{N}{2} \log 3 \quad (20h)$$

where (20c) follows from the fact that the transformation of variables has unitary Jacobian and (20f) follows from the fact that the variance of a random variable bounded in  $[a, b]$  is upper bounded by the variance of discrete random variable that takes values  $a$  and  $b$  with equal probability.

The inequality in (20h) establishes that the capacity of the integer-valued channel is at most 0.8 bpcu larger than the capacity of the original channel. Note that  $\bar{Y}^N$  is equal to  $Y^N$  but for the additive noise but  $Z^N$  is replaced with the identical, independent noise  $\bar{Z}^N$ .



We now wish to further restrict the channel to have a peak power constraint instead of an average power constraint. To do so we define

$$\overline{\overline{X}}^N = \lfloor X^N \rfloor \bmod \lceil \sqrt{P} \rceil, \quad (21a)$$

$$\tilde{X}^N = \lfloor X^N \rfloor - \overline{\overline{X}}^N, \quad (21b)$$

$$\overline{\overline{Y}}^N = \overline{\overline{X}}^N + A^N S^N + \overline{\overline{Z}}^N, \quad (21c)$$

and once again we use Fano's inequality to write

$$I(\overline{\overline{Y}}^N; W) \leq I(\overline{\overline{Y}}^N, \tilde{X}; W) \quad (22a)$$

$$\leq I(\overline{\overline{Y}}^N, \tilde{X}; W) \quad (22b)$$

$$\leq I(\overline{\overline{Y}}^N; W) + I(\tilde{X}^N; W | \overline{\overline{Y}}^N) \quad (22c)$$

$$\leq I(\overline{\overline{Y}}^N; W) + H(\tilde{X}^N) - H(\tilde{X}^N | W, \overline{\overline{Y}}^N) \quad (22d)$$

$$\leq I(\overline{\overline{Y}}^N; W) + H(\tilde{X}^N) \quad (22e)$$

$$\leq I(\overline{\overline{Y}}^N; W) + N \max_j H(\tilde{X}_j), \quad (22f)$$

where follows from the fact that this transformation has unitary Jacobian and from the fact that  $\tilde{X}$  is a discrete random variable with positive defined entropy. We are now left with the task of bounding the term  $H(\tilde{X}_j)$  which can be done as in [11, (156)-(158)].

Using the bound in [11, (156)-(158)] and in (22) we can conclude that the capacity of WFFD-NCSI where the inputs are integer and peak-limited is to within a constant gap from the capacity of the general WFFD-NCSI. This is because the proof in [5] is developed from Fano's inequality which is tight in this model. Next we derive an upper bound to the capacity of the WFFD-NCSI with integer, peak-limited channel inputs.

• **Capacity outer bound:** The capacity of the WFFD-NCSI is determined by the result in (4): this expression can be further manipulated as

$$I(\overline{\overline{Y}}; U) - I(S; U) = I(\overline{\overline{Y}}; S, \overline{\overline{X}}) - H(S) + H(S | \overline{\overline{Y}}, U), \quad (23)$$

where we have used the fact that  $\overline{\overline{X}}$  can be taken to be a deterministic function of  $S$  and  $U$  and the Markov chain  $U - S - \overline{\overline{X}} - \overline{\overline{Y}}$ . Additionally the term  $H(S | \overline{\overline{Y}}, U)$  can be rewritten as

$$H(S | U, \overline{\overline{Y}}) \quad (24a)$$

$$\leq H(S, [Z] | U, \overline{\overline{Y}}) \quad (24b)$$

$$= H([Z]) + H(S | U, X + AS + Z - [Z]). \quad (24c)$$

Let's now bound  $H(S | U, \overline{\overline{Y}})$  as:

$$H(S | U, \overline{\overline{Y}}) \quad (25a)$$

$$\leq H(S, [Z] | U, \overline{\overline{Y}}) \quad (25b)$$

$$= H([2Z]/2) + H(S | U, X + AS + Z - [2Z]/2) \quad (25c)$$

$$= H([2Z]/2) + H(S | U, X + AS + \hat{Z}) \quad (25d)$$

$$= H([2Z]/2) + H(S | U, \hat{Y}), \quad (25e)$$

where  $[Z]$  indicates the integer part of  $Z$ , that is

$$[Z] = \begin{cases} \lfloor Z \rfloor & Z \geq 0 \\ \lceil Z \rceil & Z < 0 \end{cases} \quad (26)$$

while  $\hat{Z} = Z - [2Z]/2$  is noise bounded in the interval  $[-1/4, +1/4]$  and  $\hat{Y}$  is the output corresponding to the channel where the channel noise is  $\hat{Z}$ . The RV  $Z - \hat{Z} = [2Z]/2$  is a discrete random variable with a finite positive entropy which we can bound as

$$H([2Z]/2) = \mathbb{P} \left[ Z \in \left( -\frac{1}{4}, +\frac{1}{4} \right) \right] - \sum_{i \in \mathbb{N}} 2\rho_z \log(\rho_z). \quad (27a)$$

for

$$\rho_z = P \left[ Z \in \left( \frac{i}{2} - \frac{1}{4}, \frac{i}{2} + \frac{1}{4} \right) \right]. \quad (28)$$

For  $|i| > 1$  we have

$$\rho_z < 0.1747 \leq e^{-1} \approx 0.3679 \quad (29)$$

and therefore the terms  $-\rho_z \log \rho_z$  in the RHS of (27a) are decreasing in  $\rho_z$ ; consequently we can use usual inner and lower on the  $Q$  function to write:

$$\begin{aligned} \rho_z &\leq \frac{1}{2} e^{-\frac{(i/2-1/4)^2}{2}} - \frac{1}{\sqrt{2\pi}(i+1/2)} \left( 1 - \frac{1}{(i/2+1/4)^2} \right) e^{-\frac{(i/2+1/4)^2}{2}} \\ &= e^{-\frac{(i-1/2)^2}{8}} \left( \frac{1}{2} - \frac{1}{\sqrt{2\pi}(i+1/2)} \left( 1 - \frac{1}{(i+1/2)^2} \right) e^{-\frac{i}{4}} \right) \\ &\leq \frac{1}{2} e^{-\frac{(i-1/2)^2}{8}}. \end{aligned}$$

The function  $\exp\{-\frac{(i-1/2)^2}{8}\}$  is monotonically decreasing for  $i \geq 4$ , so that

$$\begin{aligned} &\sum_{i=4}^{\infty} -\rho_z \log \rho_z \\ &= \sum_{i=4}^{\infty} \frac{(i-1/2)^2}{8} e^{-\frac{(i-1/2)^2}{8}} \\ &\geq \int_{i=4}^{\infty} \frac{(i-3/2)^2}{8} e^{-\frac{(i-3/2)^2}{8}} \\ &= 1.21, \end{aligned}$$

so that now we can write

$$\begin{aligned} H([Z]) &\leq 0.54 + \sum_{i=1}^3 -\rho_z \log \rho_z + 1.21 \\ &= 0.54 + 2.14 + 1.21 \leq 4. \end{aligned} \quad (30)$$

Using (30), we can further bound (25e) as

$$\begin{aligned} H(S|U, \overline{Y}) &= H(S|U, \widehat{Y}) + 4 \\ &\leq H(S|\widehat{Y}) + 4 \\ &\leq \log(Q_S(\widehat{Y})) + 4. \end{aligned}$$

And where  $Q_S(\widehat{Y})$  is the set of  $\tilde{s} \in \mathcal{S}$  for which there exist  $\tilde{a} \in \mathcal{A}$  and  $\tilde{u} \in \mathcal{U}$  and  $\tilde{z} \in [-1/4, +1/4]$  such that

$$\overline{X}(\tilde{s}, \tilde{u}) + c\tilde{a}\tilde{s} + \tilde{z} = \widehat{y}, \quad (31a)$$

that is, it is the set of all possible  $S = \tilde{s}$  that could have produced the output  $\widehat{Y} = \widehat{y}$ . We next want to find the conditions under which the cardinality of  $Q_S(\widehat{Y})$  is always one. This can be done assured when the images of the output under a noise bounded by between 0 and 1 which is granted when

$$\min_{u, \tilde{s}, s, \tilde{u}} |\overline{X}(s, u) + csa - (\overline{X}(\tilde{s}, \tilde{u}) + c\tilde{a}\tilde{s})| > \frac{1}{2}, \quad (32)$$

since  $\overline{X}$  only takes values over the integers, we have

$$\min_{\tilde{s}, s, i \in -\sqrt{P} \dots +\sqrt{P}} |i + c(sa - \tilde{a}\tilde{s})| > \frac{1}{2}, \quad (33)$$

Finally we obtain that, when condition (7) we have that  $\mathcal{C}$  is to within 14 bpcu from the outer bound

$$\begin{aligned} &\max_{P_{\overline{X}|S}} I(\overline{Y}; U) - I(S; U) \\ &\leq \max_{P_{\overline{X}|S}} I(\overline{Y}; S, \overline{X}) - H(S) + 4. \end{aligned}$$



On the other hand, by enlarging the class of input distribution for the channel, we have

$$R^{\text{OUT}} = \max_{P_{X|S}} I(\overline{\overline{Y}}; S, \overline{\overline{X}}) - H(S) + 4, \quad (34)$$

which corresponds to the outer bound in (8).

## VII. PROOF OF TH. IV.1.

The state amplification inner bound in (6) for the channel output in (2) yields the attainable rate

$$R^{\text{IN-SA}} = \max_{P_{X|S}} I(Y; X, S|A) - H(S) \quad (35a)$$

and thus, as for the proof of Th. III.1, the theorem is shown by deriving the outer bound in (13).

As for the proof of Th. III.1 in App. VI, we rely on the fact that the capacity of the WFFD-RCSI to a deterministic, integer, peak-limited channel. The derivation is substantially the same as in App. VI, since the WFFD-RCSI differs from the WFFD-NCSI in that it has  $A$  as an extra output. It can be verified that this difference does not affect the derivation in App. VI.

Given that the capacity of the WFFD-RCSI is to within 5 bits from the capacity of the version with integer, peak-limited channel, we can now manipulate the capacity expression as

$$C = \max_{P_{\overline{\overline{X}}, U|S}} I(\overline{\overline{Y}}; U|A) - I(S; U) \quad (36a)$$

$$= \max_{P_{\overline{\overline{X}}, U|S}} I(\overline{\overline{Y}}; X, S|A) - H(S) + H(S|\widehat{Y}, U, A) \quad (36b)$$

$$\leq \max_{P_{\overline{\overline{X}}, U|S}} I(\overline{\overline{Y}}; X, S|A) - H(S) + H(S|\widehat{Y}, A), \quad (36c)$$

where (36c) follows from the fact that  $\overline{\overline{X}} = \overline{\overline{X}}(U, S)$ , that is  $\overline{\overline{X}}$  can be taken to be a deterministic function of  $S$  and  $U$ . The term  $H(S|\widehat{Y}, U, A)$  can be bound analogously as in the proof of III.1 in App. VI and it can be easily verified that the condition for which  $Q_S(\widehat{Y})$  has cardinality zero corresponds to the condition in (12).