

Lifetime-Based Memory Management for Distributed Data Processing Systems

Lu Lu[†], Xuanhua Shi[†], Yongluan Zhou[‡], Xiong Zhang[†], Hai Jin[†], Cheng Pei[†], Ligang He[§], Yuanzhen Geng[†]

[†]SCTS/CGCL, Huazhong University of Science and Technology, Wuhan, China

[‡]University of Southern Denmark, Denmark

[§]University of Warwick, UK

[†]{llu,xhshi,hjin,wxzhang,cpei,yzeng}@hust.edu.cn, [‡]zhou@imada.sdu.dk, [§]liganghe@dcs.warwick.ac.uk

ABSTRACT

In-memory caching of intermediate data and eager combining of data in shuffle buffers have been shown to be very effective in minimizing the re-computation and I/O cost in distributed data processing systems like Spark and Flink. However, it has also been widely reported that these techniques would create a large amount of long-living data objects in the heap, which may quickly saturate the garbage collector, especially when handling a large dataset, and hence would limit the scalability of the system. To eliminate this problem, we propose a lifetime-based memory management framework, which, by automatically analyzing the user-defined functions and data types, obtains the expected lifetime of the data objects, and then allocates and releases memory space accordingly to minimize the garbage collection overhead. In particular, we present Deca, a concrete implementation of our proposal on top of Spark, which transparently decomposes and groups objects with similar lifetimes into byte arrays and releases their space altogether when their lifetimes come to an end. An extensive experimental study using both synthetic and real datasets shows that, in comparing to Spark, Deca is able to 1) reduce the garbage collection time by up to 99.9%, 2) to achieve up to 22.7x speed up in terms of execution time in cases without data spilling and 41.6x speedup in cases with data spilling, and 3) to consume up to 46.6% less memory.

1. INTRODUCTION

Distributed data processing systems, such as Spark [38], process huge volumes of data in a scale-out fashion. Unlike traditional database systems using declarative query languages and relational (or multidimensional) data models, these systems allow users to implement application logics through *User Defined Functions* (UDFs) and *User Defined Types* (UDTs) using high-level imperative languages (such as Java, Scala and C# etc.), which can then be automatically parallelized onto a large-scale cluster.

Existing researches in these systems mostly focus on scalability and fault-tolerance issues in a distributed environment [36, 37, 19, 10]. However some recent studies [11, 25] suggest that the execution efficiency of individual tasks in these systems is low. A major reason is that both the execution frameworks and user programs of these systems are implemented using high-level imperative languages running in managed runtime platforms (such as JVM, .NET CLR, etc.). These managed runtime platforms commonly have built-in automatic memory management, which brings significant memory and CPU overheads. For example, the modern tracing-based garbage collectors (GC) may consume a large amount of CPU cycles to trace living objects in the heap [20, 15, 4].

Furthermore, to improve the performance of multi-stage and iterative computations, recently developed systems support caching of intermediate data in the main memory [29, 32, 38, 39] and exploit eager combining and aggregating of data in the shuffling phases [22, 31]. These techniques would generate massive *long-living* data objects in the heap, which usually stay in the memory for a significant portion of the job execution time. However, the unnecessary continuous tracing and marking of such large amount of long-living objects by the GC would consume significant CPU cycles.

In this paper, we argue that distributed data processing systems like Spark, should employ a lifetime-based memory manager, which allocates and releases memory according to the lifetimes of the data objects rather than relying on a conventional tracing-based GC. To verify this concept, we present Deca, an automatic Spark optimizer, which adopts a lifetime-based memory management scheme for efficiently reclaiming memory space. Deca automatically analyzes the lifetimes of objects in different data containers in Spark, such as UDF variables, cached data blocks and shuffle buffers, and then transparently decomposes and stores a massive number of objects with similar lifetimes into a few number of byte arrays. In this way, the massive objects essentially bypass the continuous tracing of the GC and their space can be released by the destruction of the byte arrays.

Last but not the least, Deca automatically transforms the user programs so that the new memory layout is transparent to the users. By using the aforementioned techniques, Deca significantly optimizes the efficiency of Spark's memory management and at the same time keeps the generality and expressibility provided in Spark's programming model. In summary, the main contributions of this paper include:

- We propose a lifetime-based memory management scheme for distributed data processing systems and im-

plement a prototype on top of Spark, which is able to minimize the GC overhead and eliminate the memory bloat problems in Spark.

- We design a method that changes the in-memory representation of the object graph of each data item by discarding all the reference values. The raw data of the fields of primitive types in the object graph will be compactly stored as a byte sequence.
- We propose techniques to group byte sequences of data items with the same lifetime into a few byte arrays, thereby simplifying space reclamation. Deca automatically validates the memory safety of data accessing based on analysis of memory usage of UDT objects.
- We conduct extensive evaluation on various Spark programs using both synthetic and real datasets. The experimental results demonstrate the superiority of our approach by comparing with existing methods.

2. OVERVIEW OF DECA

2.1 Java GC

In typical JVM implementations, a garbage collector (GC) attempts to reclaim memory occupied by objects that will no longer be used. A tracing GC traces which objects are reachable by a sequence of references from some root objects. The unreachable ones, which are called garbages, can be reclaimed. Oracle’s Hotspot JVM implements three GC algorithms. The default Parallel Scavenge (PS) algorithm suspends the application and spawns several parallel GC threads to achieve high throughput. The other two algorithms, namely Concurrent Mark-Sweep (CMS) and Garbage-First (G1), attempt to reduce GC latency by spawning concurrent GC threads that run simultaneously with the application thread.

All the above collectors segregate objects into multiple generations: young generation containing recently-allocated objects, old generation containing older objects, and permanent generation containing class metadata. Based on the assumption that most objects would soon become garbages, a minor GC, which only attempts to reclaim garbages in the young generation, can be run to reclaim enough memory space. However, if there are too many old objects, then a full (or major) GC would be run to reclaim space occupied by the old objects. Usually, a full GC is much more expensive than a minor GC.

2.2 Motivating Example

A major concept of Spark is *Resilient Distributed Dataset* (RDD), which is a fault-tolerant dataset that can be processed in parallel by a set of UDF operations.

We use *Logistic Regression* (LR) as an example to motivate and illustrate the optimization techniques adopted in Deca. It is a classifier that attempts to find an optimal hyperplane that separates the data points in a multi-dimensional feature space into two sets. Figure 1 shows the code of LR in Spark. The raw dataset is a text file with each line containing one data point. Hence the first UDF is a `map` function, which extracts the data points and store them into a set of `DenseVector` objects and (lines 12–16). An additional `LabeledPoint` object is created for each data point to package its feature vector and label value together.

```

1 class DenseVector[V](val data: Array[V],
2   val offset: Int,
3   val stride: Int,
4   val length: Int) extends Vector[V] {
5   def this(data: Array[V]) =
6     this(data, 0, 1, data.length)
7   ...
8 }
9 class LabeledPoint(var label: Double,
10  var features: Vector[Double])
11
12 val lines = sparkContext.textFile(inputPath)
13 val points = lines.map(line => {
14   val features = new Array[Double](D)
15   ...
16   new LabeledPoint(new DenseVector(features), label)
17 }).cache()
18 var weights =
19   DenseVector.fill(D){2 * rand.nextDouble - 1}
20 for (i <- 1 to ITERATIONS) {
21   val gradient = points.map { p =>
22     p.features * (1 / (1 +
23       exp(-p.label * weights.dot(p.features))) -
24     1) * p.label
25   }.reduce(_ + _)
26   weights -= gradient
27 }

```

Figure 1: Demo Spark program of Scala LR.

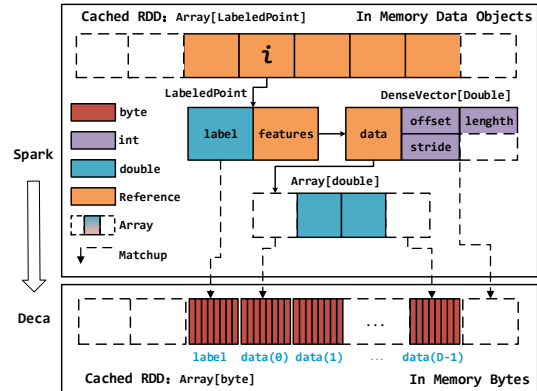

Figure 2: The LR cached RDD data layout.

To eliminate disk I/O for the subsequent iterative computation, LR uses the `cache` operation to cache the resulting `LabeledPoint` objects in the memory. For a large input dataset, this cache may contain a massive number of objects.

After generating a random separating plane (lines 18-19), it iteratively runs another `map` function and a `reduce` function to calculate a new gradient (lines 20–26). Here each call of this `map` function will create a new `DenseVector` object. These intermediate objects will not be used any more after executing the `reduce` function. Therefore, if the aforementioned cached data leaves little space in the memory, then GC will be frequently run to reclaim the space occupied by the intermediate objects and make space for newly generated ones. Note that, after running a number of minor GCs, JVM would run a full GC to reclaim spaces occupied by the old objects. However, such highly expensive full GCs would be nearly useless because most cached data objects should not be removed from the memory.

2.3 Life-time based Memory Management

We implement the prototype of Deca based on Spark. In Deca, objects are stored in three types of data containers:

UDF variables, cached RDDs and Shuffle buffers. In each data container, Deca allocates a number of fixed-sized byte arrays. By using the *points-to* analysis [21], we map the UDT objects with their appropriate containers. UDT objects are then stored in the byte arrays after eliminating the unnecessary object headers and object references. This compact layout would not only minimize the memory consumption of data objects but also dramatically reduce the overhead of GC, because GC only needs to trace a few byte arrays instead of a huge number of UDT objects. One can see that the size of each byte array should not be too small or too large, otherwise it would incur high GC overheads or large unused memory spaces.

As an example, the `LabeledPoint` objects in the LR program can be transformed into byte arrays as shown in Figure 2. Here, all the reference variables (in orange color, such as `features` and `data`), as well as the headers of all the objects are eliminated. All the cached `LabeledPoint` objects are stored into byte arrays.

The challenge of employing such a compact layout is that the space allocated to each object is fixed. Therefore, we have to ensure that the size of an object would not exceed its allocated space during execution so that it will not damage the data layout. This is easy for some types of fields, such as primitive types, but less obvious for others. Code analysis is necessary to identify the change patterns of the objects’ sizes. Such an analysis may have a global scope. For example, a global code analysis may identify that the `features` arrays of all the `LabeledPoint` objects (created in line 14 in Figure 1) actually have the same fixed size `D`, which is a global constant. Furthermore, the `features` field of a `LabeledPoint` object is only assigned in the `LabeledPoint` constructor. Therefore, all the `LabeledPoint` objects actually have the same fixed size. Another interesting pattern is that in Spark applications, objects in cached RDDs or shuffle buffers are often generated sequentially and their sizes will not be changed once they are completely generated. Identifying such useful patterns by a sophisticated code analysis is necessary to ensure the safety of decomposing UDT objects and storing them compactly into byte arrays.

As mentioned earlier, during the execution of programs in a system like Spark, the lifetimes of data containers created by the framework can be pre-determined explicitly. For example, the lifetimes of objects in a cached RDD is determined by the invocations of `cache()` and `unpersist()` in the program. Recall that the UDT objects stored in the compact byte arrays would bypass the GC. We put the UDT objects with the same lifetime into the same container. For example, the cached `LabeledPoint` objects in LR have the same lifetime, so they are stored in the same container. When a container’s lifetime comes to an end, we simply release all the references of the byte arrays in the container, then the GC can reclaim the whole space occupied by the massive amount of objects.

Lastly, Deca modifies the application code by replacing the codes of object creation, field access and UDT methods with new codes that directly write and read the byte arrays.

3. UDT CLASSIFICATION ANALYSIS

3.1 Data-size and Size-type of Objects

To allocate enough memory space for objects, we have to estimate the object sizes and their change patterns during

runtime. Due to the complexity of object models, to accurately estimate the size of a UDT, we have to dynamically traverse the runtime object reference graph of each target object and compute the total memory consumption. Such a dynamic analysis is too costly at runtime, especially with a large number of objects. Therefore we opt for static analysis which only uses static object reference graphs and would not incur any runtime overhead. We define the *data-size* of an object to be the sum of the sizes of the primitive-type fields in its static object reference graph. An object’s *data-size* is only an upper bound of the actual memory consumption of its raw data, if one considers the cases with object sharing.

To see if UDT objects can be safely decomposed into byte sequences, we should examine how their data-sizes change during runtime. There are two types of UDTs that can meet the safety requirement: 1) the data-sizes of all the instances of the UDT are identical and do not change during runtime; or 2) the data-sizes of all the instances of the UDT do not change during runtime. We call these two kinds of UDTs as **Static Fixed-Sized Type (SFST)** and **Runtime Fixed-Sized Type (RFST)** respectively.

In addition, we call UDTs that have type-dependency cycles in their type definition graphs as **Recursively-Defined Type**. Even without object sharing, the instances of these types can have reference cycles in their object graphs. Therefore, they cannot be safely decomposed. Furthermore, any UDT that does not belong to any of the aforementioned types is called a **Variable-Sized Type (VST)**. Once a VST object is constructed, its data-size may change due to field assignments and method invocations during runtime.

The objective of the UDT classification analysis is to generate the **Size-Type** of each target UDT according to the above definitions. As demonstrated in Figure 2, Deca decomposes a set of objects into primitive values and store them contiguously into compact byte sequences in a byte array. A safe decomposition requires that the original UDT objects are either of an SFST or an RFST. Otherwise the operations that expand the byte sequences occupied by an object may overwrite the data of the subsequent objects in the same byte array. Furthermore, as we will discuss later, an SFST can be safely decomposed in more cases than an RFST. On the other hand, objects that do not belong to an SFST or an RFST will not be decomposed into byte sequences in Deca. Apparently, to maximize the effect of our approach, we should avoid overestimating the variability of the data-size of the UDTs, which is the design goal of our following algorithms.

3.2 Local Classification Analysis

The local classification algorithm analyzes an UDT by recursively traversing its type dependency graph. For example, Figure 3 illustrates the type dependency graph of `LabeledPoint`. The size-type of `LabeledPoint` can be determined based on the size-type of each of its fields.

Algorithm 1 shows the procedure of the local classification analysis. The input of the algorithm is an *annotated type* that contains the information of fields and methods of the target UDT. Because the objects referenced by a field can be of any subtype of its declared type, we use a *type-set* to store all the possible runtime types of each field. The type-set of each field is obtained in a pre-processing phase of Deca by using the *points-to* analysis [21] (see Section 5).

In lines 1–2, the algorithm first determines whether the

Algorithm 1: Local classification analysis.

```
Input : The top-level annotated type  $T$ ;  
Output: The size-type of  $T$ ;  
1 build the type dependency graph  $G$  for  $T$ ;  
2 if  $G$  contains the circle path then return RecurDef;  
3 else return AnalyzeType( $T$ );  
4 Function AnalyzeType( $t_{arg}$ )  
5   if  $t_{arg}$  is a primitive type then return StaticFixed;  
6   else if  $t_{arg}$  is an array type then  
7      $f_e \leftarrow$  array element field of  $t_{arg}$ ;  
8     if AnalyzeField( $f_e$ ) = StaticFixed then  
9       return RuntimeFixed;  
10    else return Variable;  
11  else  
12     $result \leftarrow$  StaticFixed;  
13    foreach field  $f$  of type  $t_{arg}$  do  
14       $tmp \leftarrow$  AnalyzeField( $f$ );  
15      if  $tmp =$  Variable then return Variable;  
16      else if  $tmp =$  RuntimeFixed then  
17         $result \leftarrow$  RuntimeFixed;  
18      end  
19    end  
20    return  $result$ ;  
21  end  
22 end  
23 Function AnalyzeField( $f_{arg}$ )  
24    $result \leftarrow$  StaticFixed;  
25   foreach runtime type  $t$  in  $f_{arg}.getTypeSet$  do  
26      $tmp \leftarrow$  AnalyzeType( $t$ );  
27     if  $tmp =$  Variable then return Variable;  
28     else if  $tmp =$  RuntimeFixed then  
29       if  $f_{arg}$  is not final then return Variable;  
30       else  $result \leftarrow$  RuntimeFixed;  
31     end  
32   end  
33   return  $result$ ;  
34 end
```

target UDT is a recursively-defined type. It builds the type dependent graph and searches for cycles in the graph. If a cycle is found, the algorithm immediately returns recursively-defined type as the final result.

Two indirect-recursive functions, `AnalyzeType` (lines 4–22) and `AnalyzeField` (lines 23–34), are used to further determine the size-type of the target UDT. The stop condition of the recursion is when the current type is a primitive type (line 5). We treat each array type as having a length field and an element field. Since different instances of an array type can have different lengths, arrays with static fixed-sized elements will be considered as an RFST (lines 8–9).

We define a total ordering of the variability of the size-types (except the recursively-defined type) as follows: $SFST < RFST < VST$. Based on this order, the size-type of each UDT is determined by its field that has the highest variability (lines 12–20). Furthermore, each field’s final size-type is determined by the type with the highest variability in its type-set. But a non-final field of an RFST will be finally classified as VST, because the same field can possibly point to objects with different data-sizes (lines 28–29). Consider that whenever we find a VST field, the top-level UDT must also be classified as a VST. In this case, the function can immediately return without further traversing the graph.

We take the type `LabeledPoint` in Figure 1 as a running example. In Figure 3, every field has a type-set with a single element and the declared type of each field is equal

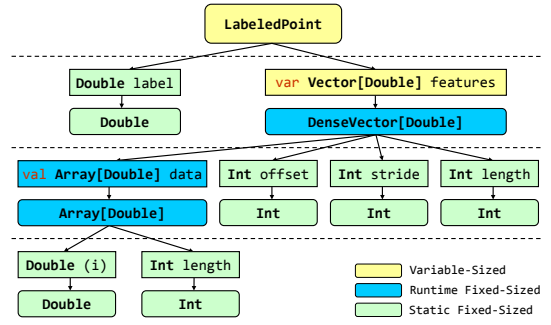

Figure 3: An example of the local classification.

to its corresponding runtime type except that the `features` field has a declared type (`Vector`), while its runtime type is `DenseVector`. Moreover, for a more sophisticated implementation of logistic regression with high-dimensional data sets, the `features` field can have both `DenseVector` and `SparseVector` in its type-set.

Since there is no cycle in the type dependency graph, `LabeledPoint` is not a recursively-defined type. As shown in Figure 3, `LabeledPoint` contains a primitive field (i.e. `label`) and a field of the `Vector` type (i.e. `features`). Therefore, the size-type of `LabeledPoint` is determined by the size-type of `features`, i.e. the size-type of `DenseVector`. It contains four fields: one of the array type and other three of the primitive type. The `data` field will be classified as an RFST but not a VST due to its `final` modifier (`val` in Scala). Furthermore, the `DenseVector` objects assigned to `features` can have different `data-size` values because they may contain different arrays. Therefore, both `features` and `LabeledPoint` belong to VST.

3.3 Global Classification Analysis

The local classification algorithm is easy to implement and has negligible computational overhead. But it is conservative and often overestimates the variability of the target UDT. For example, the local classifier conservatively assumes that the `features` field of a `LabeledPoint` object may be assigned with `DenseVector` objects with different `data-size` values. Therefore it mistakenly classifies it as a VST, which can not be safely decomposed.

Furthermore, the local classifier assumes that the `DenseVector` objects contain arrays (`features.data`) with different lengths. Even if we change the modifier of `features` from `var` to `val`, i.e. only allowing it to be assigned once, the local classifier still considers it as an RFST rather than an SFST.

For UDTs that are categorized as RFST or VST, we further propose an algorithm to refine the classification results via global code analysis on the relevant methods of the UDTs. To break the assumptions of the local classifier, the global one uses code analysis to identify *init-only fields* and *fixed-length array type* according to the following definitions.

Init-only field. A field of a non-primitive type T is *init-only*, if, for each object, this field will only be assigned once during the program execution.¹

¹We always treat the array element fields as non init-only, otherwise the analysis needs to trace the element index value

Algorithm 2: Global classification analysis.

Input : The top-level non-primitive type T ; The locally-classified size-type S_{local} ; Call graph of the current analysis scope G_{call} ;
Output: The refined size-type of T ;
1 **if** $SRefine(T, G_{call})$ **then** **return** `StaticFixed`;
2 **else if** $S_{local} = \text{RuntimeFixed}$ **or** $RRefine(T, G_{call})$ **then**
3 | **return** `RuntimeFixed`;
4 **else** **return** `Variable`;

Fixed-length array types. An array type A contained in the type-set of field f is a *fixed-length* array type w.r.t. f if all the A objects assigned to f are constructed with identical length values within a well-defined scope, such as a single Spark job stage or a specific cached RDD. An example of symbolized constant propagation is shown in Figure 4. Here, `array` is constructed with the same length for whatever `foo()` returns. The fixed-length array types with its element fields being SFST (or RFST) can be refined to SFST (or RFST).

```
1 val a = input.readString().toInt() // a == Symbol(1)
2 val b = 2 + a - 1 // b == Symbol(1) + 1
3 val c = a + 1 // c == Symbol(1) + 1
4 if (foo()) array = new Array[Int](b)
5 else array = new Array[Int](c)
6 // array.length == Symbol(1) + 1
```

Figure 4: Symbolized constant propagation.

In Figure 1, the `features` field is only assigned in the constructor of `LabeledPoint` (lines 1–8), and the length of `features.data` is a global constant value D (lines 14–16). Thus, the size-class of `LabeledPoint` can be refined to SFST.

Algorithm 2 shows the procedure of the global classification. The input of the algorithm is the target UDT and the call graph of the current analysis scope. The refinement is done based on the following lemmas.

LEMMA 1 (SFST REFINEMENT). *An array type that is an RFST or a VST can be refined to an SFST if and only if for every array type in the type dependent graph, the followings are true:*

1. it is a fixed-length array type; and
2. every type in the type-set of its element field is an SFST.

LEMMA 2 (RFST REFINEMENT). *An array type that is a VST can be refined to an RFST if and only if:*

1. every type in the type-sets of its fields is either an SFST or an RFST; and
2. each field with an RFST in its type-set is init-only.

The call graph used for the analysis is built in the pre-processing phase (Section 5). The entry node of the call graph is the main method of the current analysis scope, usually a Spark job stage, while all the reachable methods from the entry node as well as their corresponding calling sequences are stored in the graph.

In line 7 of Algorithm 3, we use the following steps to identify the fixed-length array types. (1) Perform the copy/constant propagation in the call graph. The values passed in each assignment statement, which is not feasible in static code analysis.

Algorithm 3: Static fixed-sized type refinement:

$SRefine(t_{arg}, g_{arg})$

```
1 Function  $SRefine(t_{arg}, g_{arg})$ 
   Input : A non-primitive type  $t_{arg}$ ; A call graph  $g_{arg}$ ;
   Output: true or false that  $t_{arg}$ 's size-type can be
           refined to StaticFixed;
2 foreach field  $f$  of type  $t_{arg}$  do
3 |   foreach runtime type  $t$  in  $f.getTypeSet$  do
4 | |   if  $t$  is not a primitive type and not
          $SRefine(t, g_{arg})$  then return false;
5 |   end
6 end
7 if  $t_{arg}$  is an array type and  $t_{arg}$  is not Fixed-Length
   in call graph  $g_{arg}$  then return false ;
8 else return true;
9 end
```

Algorithm 4: Runtime fixed-sized type refinement:

$RRefine(t_{arg}, g_{arg})$

```
1 Function  $RRefine(t_{arg}, g_{arg})$ 
   Input : A non-primitive type  $t_{arg}$ ; A call graph  $g_{arg}$ ;
   Output: true or false that  $t_{arg}$ 's size-type can be
           refined to RuntimeFixed;
2 foreach field  $f$  of type  $t_{arg}$  do
3 |    $analyze\_field \leftarrow$  false;
4 |   foreach runtime type  $t$  in  $f.getTypeSet$  do
5 | |   if  $t$  is not a primitive type and not
          $SRefine(t, g_{arg})$  then
6 | | |   if  $RRefine(t, g_{arg})$  then
7 | | | |    $analyze\_field \leftarrow$  true;
8 | | |   else return false;
9 | |   end
10 |   end
11 |   if  $analyze\_field$  and  $f$  is not Init-Only in call
       graph  $g_{arg}$  then return false;
12 end
13 return true;
14 end
```

from the outside of the call graph or returned by the I/O operations will be represented by symbols considered as constant values. (2) For a field f and an array type A , find all the allocation sites of the A objects that are assigned to f (i.e. the methods where these objects are created). If all the length values used in all these allocation sites are equivalent, A is of fixed-length w.r.t. f .

In line 11 of Algorithm 4, we use the following rules to identify init-only or non-init-only fields: 1) a final field is init-only; 2) an array element field is not init-only; 3) in addition, a field is init-only if it will not be assigned in any method in the call graph other than the constructors of its containing type, and it will only be assigned once in any constructor calling sequence.

3.4 Phased Refinement

In a typical data parallel programming framework, such as Spark, each job can be divided into one or more execution phases, each consisting of three steps: (1) reading data from materialized (on-disk or in-memory) data collectors, such as cached RDD, (2) applying an UDF on each data object, and (3) emitting the resulting data into a new materialized data collector. Figure 5 shows the framework of a job in Spark. It consists one or more top-level computation loops, each reads data object from its source, and writes the results

```

1 // The first loop is the input loop.
2 var source = stage.getInput()
3 var sink = stage.nextCollection()
4 while (source.hasNext()) {
5     val dataIn = source.next()
6     ...
7     val dataOut = ...
8     sink.write(dataOut)
9 }
10 // Optional inner loops
11 source = sink
12 sink = stage.nextCollection()
13 while (source.hasNext()) {...}
14 ...
15 // The last loop is the output loop
16 source = sink
17 sink = stage.getOutput()
18 while (source.hasNext()) {...}

```

Figure 5: A code template of the Spark job stage.

into the sink. Every two successive loops are bridged by a data collector, such as an RDD or a shuffle buffer.

We observe that the data-sizes of object types may have different levels of variability at different phases. For example, in an early phase, data would be grouped together by their keys and their values would be concatenated into an array whose type is a VST at this phase. However, once the resulting objects are emitted to a data collector, e.g. a cached RDD, the subsequent phases might not reassign the array fields of these objects. Therefore, the array types can be considered as RFSTs in the subsequent phases. We exploit this phenomenon to refine a data type’s size-class in each particular phase of a job, which is called *phased refinement*. This can be achieved by running the global classification algorithm for the VSTs on each phase of the job.

4. LIFETIME-BASED MEMORY MANAGEMENT

4.1 The Spark Programming Framework

Spark provides a functional programming API, through which users can process Resilient Distributed Datasets (RDDs), the logical data collections partitioned across a cluster. An important feature is that RDDs can be explicitly cached in the memory to avoid re-computation or disk I/O overhead.

While Spark supports many operators, the ones most relevant for memory management are some *key-based* operators, including `reduceByKey`, `groupByKey`, `join` and `sortByKey` (analogues of GroupBy-Aggregation, GroupBy, Inner-Join and OrderBy in SQL). These operators process data in the form of *Key-Value* pairs. For example, `reduceByKey` and `groupByKey` are used for: 1) aggregating all *Values* with the same *Key* into a single *Value*; 2) building a complete *Value* list for each *Key* for further processing.

Furthermore, these operators are implemented using data shuffling. The shuffle buffer stores the combined value of each *Key*. For example, for the case of `reduceByKey`, it stores a partial aggregate value for each *Key*, and for the case of `groupByKey`, it stores a partial list of *Value* objects for each *Key*. When a new *Key-Value* pair is put into the shuffle buffer, eager combining is performed to merge the new *Value* with the combined value.

For each Spark application, a driver program negotiates with the cluster resource manager (e.g. YARN [34]), which

launches executors (each with fixed amount of CPU and memory resource) on worker machines. An application can submit multiple jobs. Each job has several *stages* separated by data shuffles and each stage consists of a set of tasks that perform the same computation. Each executor occupies a JVM process and executes the allocated tasks concurrently in a number of threads.

4.2 Lifetimes of Data Containers in Spark

In Spark, all objects are allocated in the running executors’ JVM heaps, and their references are stored in three kinds of *data containers* described below. A key challenge for Deca is deciding when and how to reclaim the allocated space. In the *lifetime* analysis, we focus on the end points of the lifetime of the object references. The lifetime of an object ends once all its references are dead.

UDF variables. Each task creates function objects according to its task descriptor. UDF variables include objects assigned to the fields of the function objects and the local variables of their methods. The lifetimes of the function object end when the running tasks complete. In addition, as long-living objects are recommended to be stored in cached RDDs, in most applications, local variables are dead after each method invocation. Therefore, we treat all the data objects referenced only by the local variables as short-living temporal objects.

Cache blocks. In Spark, each RDD has an object that records its data source and the computation function. Only the cached RDDs will be materialized and retained in memory. A cached RDD consists of a number of cache blocks, each being an array of objects. The lifetimes of cached RDDs are explicitly determined by the invocations of `cache()` and `unpersist()` in the applications. Whenever a cached RDD has been “unpersisted”, all of its cache blocks will be released immediately. For non-cached RDDs, the objects only appear as local variables of the corresponding computation functions and hence are also short-living.

Shuffle buffers. A shuffle buffer is accessed by two successive phases in a job: one creates the shuffle buffer and puts data objects into it, while the other reads out the data for further processing. Once the second phase is completed, the shuffle buffer will be released.

With regard to the lifetimes of the object references stored in a shuffle buffer, there are three situations. (1) In a sort-based shuffle buffer, objects are stored in an in-place sorting buffer sorted by the *Key*. Once object references are put into the buffer, they will not be removed by the subsequent sorting operations. Therefore, their lifetimes end when the shuffle buffer is released. (2) In a hash-based shuffle buffer with a `reduceByKey` operator, the *Key-Value* pairs are stored in an open hash table with the *Key* object as the hash key. Each aggregate operation will create a new *Value* object while keeping the *Key* objects intact. Therefore a *Value* object reference dies upon an aggregate operation over its corresponding *Key*. (3) In a hash-based shuffle buffer with a `groupByKey` operator, a hash table stores a set of *Key* objects and an array of *Value* objects for each *Key*. The combining function will only append *Value* objects to the corresponding array and will not remove any object reference. Hence, the references will die at the same time as the shuffle buffer. Note that these situations cover all the key-based operators in Spark. For example, `aggregateByKey` and `join` are similar

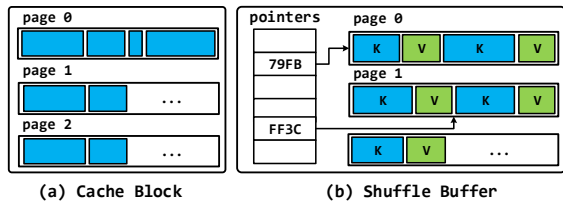

Figure 6: Memory layouts of data containers.

to `reduceByKey` and `groupByKey` respectively. Other key-based operators are just extensions of the above basic operators and hence can be handled accordingly.

4.3 Data Containers in Deca

As discussed above, object references’ lifetimes can be bound with the lifetimes of their containers. Deca builds a data dependent graph for each job stage by points-to analysis [21] to produce the mapping relationships between all the objects and their containers. Objects are identified by either their creation statements if they are created in the current stage, or their source cached blocks if they are read from cached blocks created by the previous stage.

However, an object can be assigned to multiple data containers. For example, if objects are copies between two different cached RDDs, then they can be bound to the cached blocks of both RDDs. In such cases, we assign a sole *primary container* as the owner of each data object. Other containers are treated as *secondary containers*. The object ownership is determined based on the following rules:

1. Cached RDDs and shuffle buffers have higher priority of data ownership than UDF variables, simply due to their longer expected lifetimes.
2. If there are objects assigned to multiple high-priority containers in the same job stage, the container created first in the stage execution will own these objects.

In the rest of this subsection, we present how data are organized within the primary and secondary containers under various situations.

4.3.1 Memory Pages in Deca

Deca uses unified byte arrays with a common fixed size as logical memory pages to store the decomposed data objects. A page can be logically split into consecutive byte segments, one for each top-layer object. Each of such segment can be further split into multiple segments, one for each lower-layer object, and so on. The page size is chosen to ensure that there is only a moderate number of pages in each executor’s JVM heap so that the GC overhead is negligible. On the other hand, the page size should not be too large either, so that there would not be a significant unused space in the last page of a container.

For each data container, a group of pages are allocated to store the objects it owns. Deca uses a *page-info* structure to maintain the metadata of each page group. The page-info of each page graph contains: 1) *pages*, a page array storing the references of all the allocated pages of this page group; 2) *endOffset*, an integer storing the start offset of the unused part of the last page in this group; 3) *curPage* and *curOffset*, two integer values that store the progress of sequentially scanning, or appending to, this page group.

4.3.2 Primary Container

The way how Deca stores objects in their primary container depends on the type of the container:

UDF variables. Deca does not decompose objects owned by UDF variables. These objects do not incur significant GC overheads, because: (1) the objects only referenced by local variables are short-living objects and they belong to the young generation, which will be reclaimed by the cheap minor GCs; (2) the objects referenced by the function object fields may be promoted to the part of old generation, but the total number of these objects in a task is relatively small in comparing to the big input dataset.

Cache blocks. Deca always decomposes the SFST or RFST objects and stores their raw data bytes in the page group of a cache block, while keeps the VST objects intact. Figure 6(a) shows the structure of a cache block of a cached RDD, which contains decomposed objects.

A task can read objects from a decomposed cache block created in a previous phase. If this task changes the data-sizes of these objects, Deca has to re-construct the objects and release the original page group. To avoid thrashing, when such re-construction happens, Deca will not re-decompose these objects again even if they can be safely decomposed in the subsequent phases.

Shuffle buffers. Figure 6(b) shows the structure of a shuffle buffer. Similar to cache blocks, data of an RFST or an SFST in a shuffle buffer will be decomposed into the shuffle buffer’s page group. However, unlike cached RDD, where data are accessed in a sequential manner, data in a shuffle buffer will be randomly accessed to perform sorting or hashing operations. Therefore, as illustrated on the left-hand side of Figure 6(b), we use an array to store the pointers to the keys and values within a page. The hashing and sorting operations are performed on the pointer arrays. However, the pointer array can be avoided for a hash-based shuffle buffer with both the *Key* and the *Value* being of primitive types or SFSTs. This is because we can deduce the offsets of the data within the page statically.

As we discussed in Section 4.2, for a hash-based shuffle buffer with a GroupBy-Aggregation computation, a combining operation would kill the old *Value* object and create a new one. Therefore, *Value* objects are not long-living and frequent GC of these objects are generally unavoidable. However, if the *Value* object is of an SFST, then we can still decompose it and whenever a new object is generated by the combining operation, we can just reuse the page segment occupied by the old object, because the old and the new objects are of the same size. Doing this would save the frequent GC caused by these temporary *Value* objects.

For brevity, we omit swapping data between memory and disks here. It is straightforward to adapt to the cases with disk swapping for data caching and shuffling (see Appendix C for details).

4.3.3 Secondary Container

There are common patterns of multiple data containers sharing the same data objects in Spark programs, such as: 1) manipulating data objects in cache blocks or shuffle buffers through UDF variables; 2) copying objects between cached RDDs; 3) immediately caching the output objects of shuffling; 4) immediately shuffling the objects of a cached RDD.

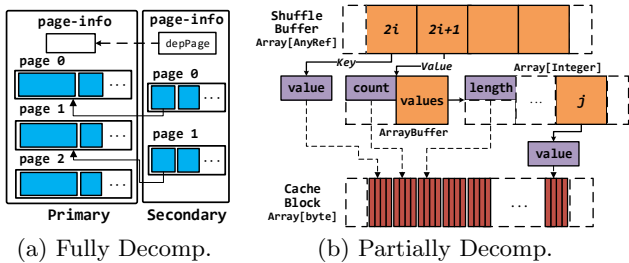

Figure 7: Examples of data layout in Deca.

If a secondary container is UDF variables, it will be assigned pointers to page segments in the page group of the objects’ primary container. Otherwise, Deca stores data in the secondary container according to the following two different scenarios: (i) fully decomposable, where the objects can be safely decomposed in all the containers, and (ii) partially decomposable, where the objects cannot be decomposed in one or more containers.

Fully decomposable. This scenario is illustrated in Figure 7(a). To avoid copy-by-value, a secondary container only stores the pointers to the page group owned by the primary, one for each object. Furthermore, we add an extra field, *depPages*, to the page-info of the secondary container to store the page-info(s) of the primary container(s).

Deca further performs optimizations for a special case, where a secondary container stores the same set of objects as the primary and does not require a specific data ordering. In such a case, Deca only generates a copy of the page-info of the page group owned by the primary container, and stores it in the secondary container. In this way, both containers actually share the same page group. The memory manager uses a reference-counting method to reclaim memory space. Creating a new page-info of a page group increments its reference counter by one, while destroying a container (and its page-info) does the opposite. Once the reference counter becomes zero, the space of the page group can be reclaimed.

Partially decomposable. In general, if the objects cannot be safely decomposed in one of the containers, then we cannot decompose them into a common page group shared by all the containers. However, if the objects are immutable or the modifications of objects in one container does not need to be propagated to the others, then we can decompose the objects in some containers and store the data in their object form in the non-decomposable containers. This is beneficial if the decomposable containers have long lifetimes.

Figure 7(b) depicts a representative example, where the output of a `groupByKey` operator, implemented via a hash-based shuffle buffer, is immediately cached in a RDD. Here, `groupByKey` creates an array of *Value* objects in the hash-based shuffle buffer (see the middle of Figure 7(b)), and then the output is copied to the cache blocks. The *Value* array is of a VST and hence cannot be decomposed in the shuffle buffer. However, in this case, the shuffle buffers would die after the data are copied to the cache blocks, and the subsequent modifications of the objects in the cache blocks do not need to be propagated back to the shuffle buffers. Therefore, as shown in Figure 7(b), we can safely decompose the data in the cache blocks, which have a long lifetime, and hence significantly reduce the GC overhead.

5. IMPLEMENTATION

We implement Deca based on Spark in roughly 6700 lines of Scala code. It consists of an optimizer used in the driver, and a memory manager used in every executor. The memory manager allocates and reclaims memory pages. It works together with the Spark cache manager and shuffle manager, which manage the un-decomposed data objects. The optimizer analyzes and transforms the code of each job when it is submitted in the driver (see Appendix A for details). The transformed code will use the API provided by the memory manager to create pages and access the stored bytes.

The Deca optimizer uses the Soot framework [6] to analyze and manipulate the Java bytecode. The Soot framework provides a rich set of utilities, which implements classical program analysis and optimization methods. The optimization consists of three phases: pre-processing, analysis and transformation.

In the pre-processing phase, Deca uses *iterator fusion* [27] to bundle the iterative and isolated invocations of UDFs into larger, hopefully optimizable code regions to avoid complex and costly inter-procedural analysis. The per-stage call graphs and per-field type-sets are also built using Soot in this phase. Building per-phase call graphs will be delayed to the analysis phase if a phased refinement is necessary. In the analysis phase, Deca uses methods described in Section 3 and Section 4 to determine whether and how to decompose particular data objects in their containers. Based on the obtained decomposability information, new class files with transformed code will be generated and distributed to all executors in the transformation phase. In general, the accessing of primitive fields of decomposed data objects in the original code will be transformed to accessing the corresponding page segments (see Appendix B for details).

6. EVALUATION

We use five nodes in the experiments, with one node as the master and the rest as workers. Each node is equipped with two eight-core Xeon-2670 CPUs, 64GB memory and one SAS disk, running RedHat Enterprise Linux 5 (kernel 2.6.18) and JDK 1.7.0 (with default GC parameters). We compare the performance of Deca with Spark 1.6. For serializing cached data in Spark, we use Kryo, which is a very efficient serialization framework.

Five typical benchmark applications in Spark are evaluated in these experiments: *WordCount* (WC), *LogisticRegression* (LR), *KMeans*, *PageRank* (PR), *ConnectedComponent* (CC). As shown in Table 1 they exhibit different characteristics and hence can verify the system’s performance in various different situations. For WC, we use the datasets produced by Hadoop *RandomWriter* with different unique key numbers (1M and 100M) and sizes (50GB, 100GB and 150GB). LR and KMeans use: 4096-dimension feature vectors (40GB and 80GB) extracted from Amazon image dataset [24], and randomly generated 10-dimension vectors (ranging from 40GB to 200GB). For PR and CC, we use three real graphs: LiveJournal social network [13] (2GB), webbase-2001 [14] (30GB) and a 60GB graph generated by HiBench [3]. The maximum JVM heap size of each executor is set to be 30GB for the applications with only data caching or data shuffling, and 20GB for those with both caching and shuffling.

6.1 Impact of Shuffling

Application	Stages	Jobs	Cache	Shuffle
WC	two	single	non	aggregated
LR	single	multiple	static	non
KMeans	two	multiple	static	aggregated
PR	multiple	multiple	static	grouped
CC				aggregated

Table 1: Applications used in the experiments

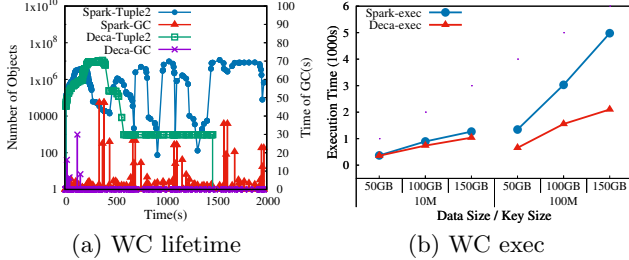

Figure 8: Results of shuffling-only WC

WC is a two-stage MapReduce application with data shuffling between the “map” and “reduce” stages. We examine the lifetimes of data objects in the shuffle buffers with the smallest dataset. We periodically record the alive number of objects and the GC time with JProfiler 9.0. The result is shown in Figure 8(a). WC uses a hash-based shuffle buffer to perform eager aggregation, which is implemented in `Tuple2`. The number of `Tuple2` objects, which fluctuates during the execution, can indicate the number of objects in shuffle buffers. While the number of `Tuple2` are also large in “map” stage but decrease in shuffle in Deca. GCs are triggered frequently to release the space occupied by the temporary objects in the shuffle buffers.

To avoid such frequent GC operations, Deca reuses the space occupied by the partially-aggregated *Value* for each *Key* in the shuffle buffer. Figure 8(b) compare the execution times of Deca and Spark. In all cases, Deca can reduce the execution time by 10%–58%. One could also see that the performance improvement increases with more number of keys. This is because the size of a hash-based shuffle buffer with eager aggregation mainly depends on the number of keys. The reduction of GC overhead would become more prominent with a larger number of keys. Furthermore, since Deca stores the objects in the shuffle buffer as byte arrays, it also saves the cost of data (de-)serialization by directly outputting the raw bytes.

6.2 Impact of Caching

LR and KMeans are representative machine learning applications that perform iterative computations. Both of them first load and cache the training dataset into memory, then iteratively update the model until the pre-defined convergence condition is met. In our experiments, we only run 30 iterations. We do not account for the time to load the training dataset, because the iterative computation dominates the execution time, especially consider that these applications can run up to hundreds of iterations in a production environment. We set 90% of the available memory to be used for data caching.

We first examine the lifetimes of data objects in cache RDDs for LogisticRegression (LR) using the 40GB dataset.

The result is shown in Figure 9(a). We find that the number of objects is rather stable throughout the execution in Spark, but full GCs have been triggered several times in vain (the peaks of the GC time curve). This is because most objects are long-living and hence their space cannot be reclaimed. While these objects are less in Deca because they are transformed to bytes after being read from the HDFS. Some objects still live in old generation of JVM heap because no full gc is active.

By grouping massive objects with the same lifetime into a few byte arrays, Deca can effectively eliminate the GC problem of repeatedly scanning alive data objects for their liveness. Figure 9(b) and Figure 9(c) show the execution times of LR and KMeans for both Deca and Spark. Here we also examine the cases using Kryo to serialize the cached data in Spark, which is denoted as “SparkSer” in the figures.

For the 40GB and 60GB datasets, the improvement is moderate and can be mainly attributed to the elimination of object creation and minor GCs. In these cases, the memory is sufficient to store the temporary objects, and hence full GC is rarely triggered. Furthermore, serializing the cached data also helps reducing the GC time. Therefore, with the 40GB dataset, SparkSer outperforms Spark by reducing the GC overhead. However, for larger datasets, the overhead of data (de-)serialization cannot pay off the reduced GC overhead. Therefore, simply serializing the cached data is not a robust solution.

For the three larger datasets the improvement is more significant. The speedups of Deca are ranging from 16x to 41.6x. In these datasets, the long-living objects consume almost all available memory space, and therefore full GCs are frequently triggered, which just repeatedly and unavailingly trace the cached data objects in the old generation of the JVM heap. With the 100GB and 200GB datasets, the additional disk I/O costs of cache swapping also prolong the execution times of Spark. Deca keeps a smaller memory footprint of cached data and swap smaller portion of data to the disks.

We also conduct the experiments on a real dataset, Amazon image dataset with 4096 dimensions. Figure 9(d) shows the speedups achieved by Deca are ranging from 1.2x to 5.3x. With such a high dimensional dataset, the size of object headers becomes negligible and therefore, the sizes of the cached data of Spark and Deca are nearly identical.

6.3 Impact of Mixed Shuffling and Caching

Graph	LiveJournal (LJ)	WebBase (WB)	HiBench (HB)
Vertices	4.8M	118M	602M
Edges	68M	1B	2B
Data Size	2GB	30GB	60GB

Table 2: Graph datasets used in PR and CC.

PageRank (PR) and ConnectedComponent (CC) are representative iterative graph computations. Both of them use `groupByKey` to transform the edge list to the adjacency lists, and then cache the resulting data. We use three datasets with different edge numbers and vertex numbers as shown in Table 2. We set 40% and 100% of the available heap space for caching and shuffling respectively. Edges will be cached during all iterations, and shuffling is used in every iteration to aggregate messages for each target vertex. We run 10 iterations in all the experiments.

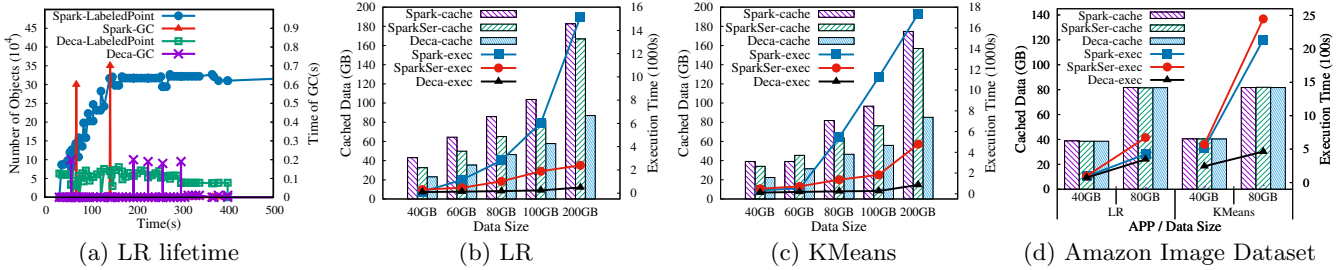

Figure 9: Results of caching-only LR/KMeans

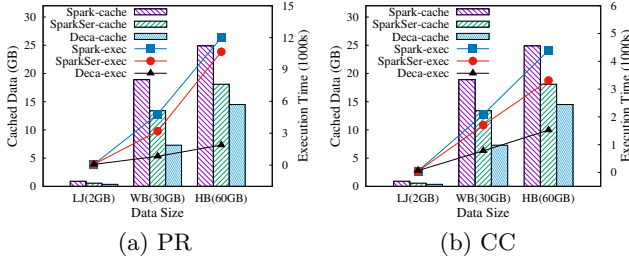

Figure 10: Results of PR and CC

App	Spark			Deca	
	exec.	gc	ratio	gc	reduction
WC: 150GB	4980s	2016s	40.5%	12.2s	99.4%
LR: 80GB	2820s	2069.9s	73.4%	2.5s	99.9%
KMeans: 80GB	5443s	4294.8s	78.9%	7.2s	99.8%
PR: 30GB	5544s	3588.6s	64.7%	21.7s	99.4%
CC: 30GB	2088s	1443.9s	69.2%	36s	97.5%

Table 3: GC time reduction.

Figure 10(a) and Figure 10(b) show the execution times of PR and CC for both Spark and Deca. The speedups of Deca are ranging from 1.1x to 6.4x, which again can be attributed to the reduction of GC overhead and shuffle serialization overhead. However, it is less dramatic than the previous experiment. This is because each iteration of these applications creates new shuffle buffers and releases the old ones. Then GC may be triggered to reclaim the memory occupied by the shuffle buffers that are no longer in use. This reduces the memory stress of Spark. We also see that SparkSer, which simply serialize the cache in Spark, has little impact on the performance. The additional (de-)serialization overhead offsets the reduction of GC overhead.

6.4 GC improvement

Table 3 shows the times to run GC and the ratios of GC time to the whole job execution time for the seven applications. For each application, we only present the case with the largest input dataset that does not have data swapping or spilling, to avoid the disk I/O affecting the execution time. For each case, the GC time is an average of the values on all executors. The result demonstrates the effect of GC elimination by Deca, and how it improves the entire application performance.

As shown in the result, the GC running time of LR and KMeans occupies the largest portion of the total execution time among all cases, which are 73.4% and 78.9% respec-

App	Storage Fraction			GC algorithm		
	frac.	exec.	gc	algo.	exec.	gc
LR: 80GB	0.8:0.2	2466s	1918s	PS	3102s	2367s
	0.6:0.4	450s	30s	CMS	423s	52s
Deca:152s/ 1.6s	0.4:0.6	606s	19s	G1	332s	22s
	0.4:1.0	5544s	3588s	PS	5544s	3588s
PR:30GB	0.1:1.0	3720s	1532s	CMS	6480s	3506s
	0.0:1.0	3804s	1426s	G1	7440s	1966s

Table 4: GC tuning

tively. With the 80GB input dataset, the cached data objects almost consume all the memory space of the old generation of the JVM heap. Deca reduces GC running time in two ways: 1) smaller cache datasets trigger much less full GCs; 2) once a full GC is triggered, the overhead of tracing objects is significantly reduced.

Since all the other applications have shuffle phases in their executions, the disk and network I/O account for a significant portion of the total execution time. Furthermore, reserving memory spaces for shuffle buffers makes that the long-living cached objects occupy no more than 60% of the total available memory. Therefore, in these cases the GC running time ranges from 64.7% to 69.2%. This explains the different improvement ratios for different types of applications reported above.

We then compare Deca with GC tuning methods. The Spark document [7] states that adjusting the fractions of memory allocated to cache blocks and to shuffle blocks is an effective GC tuning method. Furthermore, we also compare with two GC algorithms available in Hotspot JVM: namely CMS and G1. Table 4 shows the results. LR is very sensitive to GC tuning. By setting fractions of cache and shuffle buffer to 0.6 and 0.4 (the optimal based on our experiments), respectively, or replacing PS with CMS or G1 with tuned parameters, we can significantly improve the performance of LR. However, PR is much less sensitive to GC tunings, which is consistent with the previously reported experiments [9]. However, we cannot achieve the same performance gain by setting a higher number of concurrent GC threads in G1 as reported in [9]. We conjectures that it is because of the difference of the configuration of the machines, which is not stated in [9]. This experiment indicates that GC tuning is an effective way to improve GC performance in some applications, however it is a cumbersome process and is highly dependent on the applications and the system environment.

6.5 Microbenchmark

To make a closer comparison, we attempt to break down

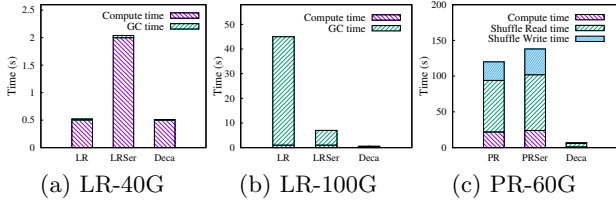

Figure 11: Breakdown of the task execution time.

App	JVM heap	Time	Spark	Deca	SparkSer
LR	1.1GB	exec.	161.4s	9.4s	83.4s
		gc	139.7s	0.1s	6.0s
	20GB	exec.	10.9s	9.5s	44.6s
		gc	0.02s	0.18s	0.04s
PR	2GB	exec.	355.1s	26.5s	809.1s
		gc	100.8s	0.18s	505.1s
	30GB	exec.	237.7s	22.8s	259.4s
		gc	13.5s	0.04s	2.2s
Avg. time to serialize one object			-	3.7ms	3.9ms
Avg. time to de-serialize one object			-	-	27ms

Table 5: Result of Microbenchmarks.

the running time of a single task in LR and PR in Figure 11. We use the optimized memory fractions obtained in the previous subsection. Note that tasks run concurrently in the system and we present the slowest tasks in the respective approaches, which somehow indicate the system bottleneck. In the LR-40G job, there is minimum GC overhead for all approaches, but the deserialization overhead of SparkSer is obvious. For the LR-100G job, SparkSer can also minimize GC overhead, but it needs to deserialize data into temporary objects and hence still have some GC overhead. This shows the advantage of Deca’s code modification over serialization. Furthermore, for PR-60G, there is high shuffling overhead in both Spark and SparkSer. This is because the disk swapping of the input cached RDD slows down the shuffle I/O. Due to the smaller footprint, Deca does not suffer from this problem. Note that GC and shuffle I/O can run in parallel and shuffling is the bottleneck in this setup.

To further analyze the CPU overhead, we run LR and PR within a controlled environment to eliminate the impact of memory footprint and other non-CPU factors, such as the Spark’s task scheduling delay and shuffling I/O. This is done by using a multi-threaded Java program in a single machine to emulate the workflow of Spark without task scheduling and shuffling I/O.

In the LR job, we use 8 million randomly-generated 10-dimensional labeled feature vectors as the input dataset. The input is first partitioned and cached in object arrays (Spark) or byte arrays (SparkSer and Deca). The cached partitions are then evenly dispatched to computing threads. The number of iterations is set to 50. The results in Table 5 show that, when the heap is large enough (20 GB) and hence there is negligible GC overheads, Deca is almost identical to Spark but SparkSer has a poor performance due to the high deserialization overhead. Furthermore, when the JVM heap size is relatively small (1.1 GB), Spark suffers from high GC overheads while both SparkSer and Deca can keep the GC overheads low. Again, Deca outperforms SparkSer because it does not require de-serialization and has a lower GC overhead. We also measure the average time for Deca and Kryo to serialize and de-serialize each object. The results are re-

ported at the bottom of Table 5. We can see that Deca has a similar serialization cost as Kryo, while Deca does not involve a significant de-serialization overhead as Kryo does.

A similar experiment is done on PR, which uses both cache and shuffle buffers. The Pokec graph [5] with 1.6M vertices and 30M edges is used as the input. Note that Spark does not support in-memory serialization for shuffle buffers, so SparkSer only serializes the cached data. As shown in Table 5, when the GC overhead is negligible with a large heap, SparkSer again suffers from high de-serialization overhead, while Deca runs significantly faster than Spark. This is because Spark needs to access auto-boxed objects in generic-type containers in the shuffle buffers, while Deca directly operates on the primitive values (note that this is not the case for LR, because LR does not involve shuffling.). When the GC overhead is high with a smaller heap, SparkSer works worse than Spark because of the join operation in PR. During the join operation, SparkSer de-serializes the cached data and stores the resulting objects in the shuffle buffers. On the other hand, Spark just stores references of the cached objects in the shuffle buffers. Thus, SparkSer suffers from even higher GC overheads than Spark does. Here, Deca’s superiority is attributed to its ability to decompose not only cache blocks but also shuffle buffers.

In summary, Deca has lower GC overhead, smaller footprint, no data deserialization, and no data boxing and unboxing. All these factors can be important to job execution time, and their significance depends on the actual scenarios.

6.6 Comparing with Spark SQL

In this experiment, we compare Deca with Spark SQL, which is optimized for SQL-like queries. Spark SQL uses a serialized column-oriented format to store in-memory tables, and, with the project Tungsten, the shuffled data of certain (built-in or user-defined) aggregation functions, such as AVG and SUM, are also stored in memory with a serialized form. The serialization can be either auto-generated or manually written by users. We use a dataset sampled from the Common Crawl document corpus, where *rankings* is 6.6GB and *uservisits* is 44GB. We use the table schemas and the two SQL queries provided in Spark’s benchmark [1]. For each query, a semantic-identical hand-written Spark program (with RDDs) are used for Spark and Deca. The input tables are entirely cached in memory before being queried. We disable the in-memory compression of Spark SQL.

The first query is a simple filtering:

```
SELECT pageURL, pageRank FROM rankings
WHERE pageRank > 100;
```

The second one is a typical GroupBy aggregate query:

```
SELECT SUBSTR(sourceIP, 1, 5), SUM(adRevenue)
FROM uservisits
GROUP BY SUBSTR(sourceIP, 1, 5);
```

The results are shown in Table 6. All three systems perform equally well for the simple filtering query with small input table. Although the GC running time in Spark is higher than that in the other two systems, it only accounts for a negligible portion of the total execution time. For the second query with a larger table, the GC overhead is significant for Spark. We can see that, similar to Spark SQL, Deca can reduce more than 50% of the execution time in comparing to Spark, while keeping the generality of Spark’s programming framework.

	App	exec.	gc	cache
Query1	Spark	23s	2.23s	18.6GB
	Spark SQL	22s	0.49s	5.6GB
	Deca	22s	0.26s	6.3GB
Query2	Spark	396s	192.4s	97.9GB(23.1GB)
	Spark SQL	180s	3.0s	47.1GB
	Deca	192s	4.2s	55.6GB

Table 6: Execution times of two exploratory SQL query in Spark, Spark SQL and Deca. In Query2, the size of swapped cache data in Spark is 23.1GB.

7. RELATED WORK

The inefficiency of memory management in managed runtime platforms for big data processing systems has been widely acknowledged. The existing efforts can be categorized into the following directions.

GC tuning. Most traditional GC tuning techniques are proposed for long-running latency sensitive web servers. Some open source distributed NoSQL systems, such as Cassandra [2] and HBase [8], use these latency-centric methods to avoid long GC pauses by replacing the Parallel GC with, e.g. CMS or G1 and tuning their parameters.

GC algorithms. Implementing better GC algorithms is another line of work. Maas et al. [23] propose a holistic runtime system for distributed data processing that coordinates the GC executions on all workers to improve the overall job performance. Gidra et al. [17] propose a NUMA-aware garbage collector for data processing running on machines with a large memory space. These approaches’ requirements of modifying JVMs prevent them being adopted on production environments. On the other hand, Deca employs a non-intrusive approach and requires no JVM modification.

Object serialization. Many distributed data processing systems, such as Hadoop, Spark and Flink, support serializing in-memory data objects into byte arrays. However, object serialization has long been acknowledged as having a high overhead [16, 35, 26]. Deca transforms the program code to directly access the raw data stored in byte arrays and avoids such overheads.

Region-based memory management (RBMM). In RBMM [33], all objects are grouped into a set of hierarchical regions, which are the basic units for space reclamation. The reclamation of a region automatically triggers the recursive reclamation of its sub-regions. This approach requires the developers to explicitly define the mapping from objects to regions, as well as the hierarchical structures of regions. Gog et al. [18] report the early work on using RBMM for distributed data processing that runs on .NET CLR. However, the evaluation is conducted using task emulation with manually implemented operators, while the details about how to transparently integrate RBMM with user codes remain unclear. Nguyen et al. [28] propose an approach that stores all alive objects of user-annotated types in a single region managed by a simplified version of RBMM, thereby bypassing the garbage collection. The occupied space of data objects will be reclaimed at once at a user-annotated reclamation point. This method is unsuitable for systems that create data objects with diverse lifetimes such as Spark. Deca can be regarded as a variant of RBMM, which automatically maps objects with similar lifetimes to the same region.

Domain specific systems. Some domain-specific data-

parallel systems make use of its specific computation structure to realize more complex memory management. Since the early adoption of JVM in implementing SQL-based data-intensive systems [30], efforts have been devoted to making use of the well-defined semantics of SQL query operators to improve the memory management performance in managed runtime platforms. Spark SQL [12] transforms relational tables to serialized bytes in a main-memory columnar storage. Tungsten [4], a Spark sub-project, enables the serialization of hash-based shuffle buffers for certain Spark SQL operators. Deca has a similar performance as Spark SQL for structured data processing, meanwhile it provides more flexible computation and data models, which eases the implementation of advanced iterative applications such as machine learning and graph mining algorithms.

8. CONCLUSION

In this paper, we identify that GC overhead in distributed data processing systems is unnecessarily high, especially with a large input dataset. By presenting Deca’s techniques of analyzing the variability of object sizes and safely decomposing objects in different containers, we show that it is possible to develop a general and efficient lifetime-based memory manager for distributed data processing systems to largely eliminate the high GC overhead. The experiment results show that Deca can significantly reduce Spark’s application running time for various cases without losing the generality of its programming framework. Finally, to take advantage of Deca’s optimization, a user is recommended to not creating a massive number of long-living objects of a VST, which cannot be safely decomposed.

9. ACKNOWLEDGMENTS

We want to thank Beng Chin Ooi of the NUS, Xipeng Shen of the NCSU, and Bingsheng He of the NTU for their valuable comments.

10. REFERENCES

- [1] Big data benchmark. <http://tinyurl.com/qg93r43>.
- [2] Cassandra garbage collection tuning. <http://tinyurl.com/5u58mzc>.
- [3] HiBench suite. <http://tinyurl.com/cns79vt>.
- [4] Project Tungsten. <http://tinyurl.com/mzw7hew>.
- [5] Snap dataset collection. <https://snap.stanford.edu/data/index.html>.
- [6] Soot framework. <http://sable.github.io/soot/>.
- [7] Spark garbage collection tuning. <http://tinyurl.com/hzf3gqm>.
- [8] Tuning Java garbage collection for HBase. <http://tinyurl.com/j5h3d3x>.
- [9] Tuning Java garbage collection for Spark applications. <http://tinyurl.com/pd8kkau>.
- [10] G. Anantharayanan and et al. Reining in the outliers in MapReduce clusters using Mantri. In *OSDI*, 2010.
- [11] E. Anderson and J. Tucek. Efficiency matters! In *HotStorage*, 2009.
- [12] M. Armbrust and et al. Spark SQL: Relational data processing in spark. In *SIGMOD*, 2015.
- [13] L. Backstrom and et al. Group formation in large social networks: Membership, growth, and evolution. In *KDD*, 2006.

- [14] P. Boldi and S. Vigna. The WebGraph framework I: Compression techniques. In *WWW*, 2004.
- [15] Y. Bu and et al. A bloat-aware design for big data applications. In *ISMM*, 2013.
- [16] B. Carpenter and et al. Object serialization for marshalling data in a java interface to mpi. In *JAVA*, 1999.
- [17] L. Gidra and et al. NumaGiC: a garbage collector for big data on big numa machines. In *ASPLOS*, 2015.
- [18] I. Gog and et al. Broom: sweeping out garbage collection from big data systems. In *HotOS*, 2015.
- [19] M. Isard and et al. Quincy: Fair scheduling for distributed computing clusters. In *SOSP*, 2009.
- [20] R. Jones, A. Hosking, and E. Moss. *The garbage collection handbook: the art of automatic memory management*. Chapman and Hall/CRC, 2011.
- [21] O. Lhoták and L. Hendren. Scaling Java points-to analysis using Spark. In *CC*, 2003.
- [22] B. Li and et al. A platform for scalable one-pass analytics using mapreduce. In *SIGMOD*, 2011.
- [23] M. Maas and et al. Trash day: Coordinating garbage collection in distributed systems. In *HotOS*, 2015.
- [24] J. McAuley and et al. Image-based recommendations on styles and substitutes. In *SIGIR*, 2015.
- [25] F. McSherry, M. Isard, and D. G. Murray. Scalability! but at what cost? In *HotOS*, 2015.
- [26] H. Miller and et al. Instant pickles: Generating object-oriented pickler combinators for fast and extensible serialization. In *OOPSLA*, 2013.
- [27] D. G. Murray, M. Isard, and Y. Yu. Steno: Automatic optimization of declarative queries. In *PLDI*, 2011.
- [28] K. Nguyen and et al. FACADE: A compiler and runtime for (almost) object-bounded big data applications. In *ASPLOS*, 2015.
- [29] R. Power and J. Li. Piccolo: Building fast, distributed programs with partitioned tables. In *OSDI*, 2010.
- [30] M. A. Shah, M. J. Franklin, S. Madden, and J. M. Hellerstein. Java support for data-intensive systems: Experiences building the telegraph dataflow system. *ACM Sigmod Record*, 2001.
- [31] J. Shi and et al. Clash of the titans: MapReduce vs. Spark for large scale data analytics. In *VLDB*, 2015.
- [32] A. Shinnar and et al. M3R: Increased performance for in-memory Hadoop jobs. In *PVLDB*, 2012.
- [33] M. Tofte and J.-P. Talpin. Region-based memory management. *Information and Computation*, pages 109–176, 1997.
- [34] V. K. Vavilapalli and et al. Apache Hadoop YARN: Yet another resource negotiator. In *SoCC*, 2013.
- [35] M. Welsh and D. Culler. Jaguar: enabling efficient communication and I/O in Java. *Concurrency - Practice and Experience*, pages 519–538, 1999.
- [36] M. Zaharia and et al. Improving MapReduce performance in heterogeneous environments. In *OSDI*, 2008.
- [37] M. Zaharia and et al. Delay scheduling: A simple technique for achieving locality and fairness in cluster scheduling. In *EuroSys*, 2010.
- [38] M. Zaharia and et al. Resilient distributed datasets: A fault-tolerant abstraction for in-memory cluster computing. In *NSDI*, 2012.
- [39] H. Zhang and et al. In-memory big data management and processing: A survey. *IEEE Transactions on Knowledge and Data Engineering*, 2015.

APPENDIX

A. HYBRID OPTIMIZATION

Intuitively, Deca can be implemented as a standalone tool that transforms the compiled jar files of a Spark program before its execution. However, a Spark driver program may execute many jobs, each consisting of several stages separated by shuffles. The job submission will be implicitly triggered by an *action*, such as `reduce`, which returns a value to the driver after running a UDF on a dataset. According to the results returned by the current job, the driver decides how to submit the next job.

A driver program can freely use the control statements (if/for/while) to control the computation. Therefore, it may submit different jobs with different input datasets and configuration parameters. A static optimization has to enumerate and processes all the possible jobs by exhaustively exploring a large number of possible execution paths of the program, which is the well-known *path explosion* problem. This is even infeasible if the program has loop structures, which render the number of execution paths unbounded.

To address these challenges, we implement Deca in a hybrid way, which contains a static analyzer and a runtime optimizer. The static analyzer extracts priori knowledge about the UDFs and UDTs of the target programs, which can be used to reduce the runtime optimization overheads. The runtime optimizer intercepts the submitted jobs at runtime, and optimizes each job before actually submitting it to the Spark platform. With this approach, Deca only optimizes the actually submitted jobs, and thereby completely eliminates the need for exploring all the execution paths.

B. CODE TRANSFORMATION

In each stage, for the data objects of the UDT that can be safely decomposed, Deca transforms the corresponding code and leaves the unoptimizable part unchanged. The transformation phase can be further split into three sub-phases, which are described below.

Decomposition. In this sub-phase, Deca generates a synthesized class for each UDT (called **SUDT**) to access the decomposed raw data. Logically, the `this` reference of a decomposed UDT object will be transformed to the start offset (index of the first byte of its raw data) of its containing byte array. Every field accessing bytecode of this object will be transformed to the array accessing code based on the absolute field offset (`object_start_offset + relative_field_offset`). The offset computation depends on the raw data size of each UDT instance. In each SUDT, Deca synthesizes `static` fields or methods to offer data-size values of all the UDT fields. The data sizes of the primitive type fields are already defined in the official JVM specification, while the sizes of non-primitive type fields can be recursively got from the SUDTs of these fields. If a field data-size value can be determined, then it is stored as a global constant value in a `static` field in the corresponding SUDT. Otherwise, Deca synthesizes a `static` method of the SUDT to compute the data size during data processing. Similarly, for each UDT, Deca synthesizes `static` fields or methods to offer relative offset values of all

```

1  def computeGradient() = {
2    val result = new Array[Double](D)
3    var offset = 0
4    while(offset < block.size) {
5      var factor = 0.0
6      val label = block.readDouble(offset)
7      offset += 8
8      for (i <- 0 to D) {
9        val feature = block.readDouble(offset)
10       factor += weights(i) * feature
11       offset += 8
12     }
13     factor = (1 / (1 + exp(-label * factor)) - 1) * label
14     offset -= 8 * D
15     for (i <- 0 to D) {
16       val value = block.readDouble(offset)
17       result(i) = result(i) + feature * factor
18       offset += 8
19     }
20   }
21   result
22 }

```

Figure 12: The transformed code of Logistic Regression.

UDT fields in the SUDT. The relative offsets can be computed based on the field data sizes and the field order in the UDT definition. As an optimization technique, we can reorder the UDT fields by putting the fields with determinable sizes in the front. This method makes more field offset values can be determined by Deca. Once all the field offsets can be computed, Deca transforms every methods of the UDT into its SUDT. During the transformation, all the field accessing code are replaced with the array accessing code.

Linking. Deca only transforms the code of UDTs in the decomposition sub-phase. In this sub-phase, Deca processes the code of UDFs and the main method for each stage. Deca memory manager allocates byte arrays rather than object arrays for data caching and shuffling. In Spark, every task processes data objects sequentially in each UDT object array in a loop. Because the array type is changed, the array index values in the loop must be computed based on the raw data sizes of each object in the optimized code. In fact, the array index variable stores the value of the start offset of the current processing data object. Base on the new array index values, Deca changes the code of UDFs and the main method in the following ways: 1) removes the invocations of UDT object constructors and directly write the initial values in the constructor parameters into the byte arrays based on the absolute field offset; 2) replaces all the field accessing code with the array accessing code; 3) replaces

each invocation of a UDT method with the corresponding SUDT method, and adds the byte array and the object start offset as the additional parameters of the invocation.

Optimization. After decomposition and linking, the Deca optimizer further performs classical program optimizations, such as constant/copy propagation, method inlining and loop fusion. Most JVM JIT compilers prefer smaller methods, but we use method inlining aggressively in the pre-processing and transformation phases. If we produce giant methods that have sizes exceeding a threshold value, we split each giant method into several smaller ones using program slicing techniques.

While the code produced by Deca are JVM bytecode, in Figure 12, we provide the equivalent Scala code to illustrate the logic of the transformed LR code. The illustrated part is corresponding to the gradient computation of the original code in line 21-24 of Figure 1.

C. DISK SWAPPING/SPILLING

When the working set size is larger than the available memory space of an executor, Spark moves part of its data out of the memory. For cached RDDs, Spark uses the LRU strategy to select the cache blocks for eviction. The evicted data will be directly discarded or swapped to the local disk according to the user-specified *storage-level*. For shuffles, Spark always spills the partial data into temporary files, and merges them into final files at the end of task executions.

For cached RDDs, Deca modifies the original LRU strategy to evict page groups rather than cache blocks. Accessing in-page data through either page-infos or pointers will refresh the corresponding page group’s recently-used counter. Spark serializes cache block data before write them into disk files, or transfer them through network for non-local accesses. In Deca, the decomposed data bytes can be directly used for disk and network I/O.

For shuffles, like Spark, Deca sorts the pointers before spilling, and writes the spilled data into files according to the order of the pointers. If a shuffle buffer has only pointers that reference page segments, Deca does not spill these pointers because normally they only occupy a small memory space. It pauses the shuffling and triggers the cache block eviction to make enough room. Deca uses a small memory space (normally only one page) to merge sorted spilled files. Once the merging space is fully filled, the merged data will be flushed to the final output file.