

Towards Integrated Glance To Restructuring in Combinatorial Optimization

Mark Sh. Levin ^{a *}^a Inst. for Information Transmission Problems, Russian Academy of Sciences
19 Bolshoj Karetny Lane, Moscow 127994, Russia

The paper focuses on a new class of combinatorial problems which consists in restructuring of solutions (as sets/structures) in combinatorial optimization. Two main features of the restructuring process are examined: (i) a cost of the restructuring, (ii) a closeness to a goal solution. Three types of the restructuring problems are under study: (a) one-stage structuring, (b) multi-stage structuring, and (c) structuring over changed element set. One-criterion and multicriteria problem formulations can be considered. The restructuring problems correspond to redesign (improvement, upgrade) of modular systems or solutions. The restructuring approach is described and illustrated (problem statements, solving schemes, examples) for the following combinatorial optimization problems: knapsack problem, multiple choice problem, assignment problem, spanning tree problems, clustering problem, multicriteria ranking (sorting) problem, morphological clique problem. Numerical examples illustrate the restructuring problems and solving schemes.

Keywords: Combinatorial optimization, restructuring, multicriteria decision making, framework, heuristics, artificial intelligence, knapsack problem, multiple choice problem, assignment problem, spanning trees, clustering, sorting problem, clique, applications.

Contents

1	Introduction	2
2	Modification problems types in combinatorial optimization	3
3	Basic Assessment Scales	7
4	Restructuring Problems	9
4.1	One-stage restructuring	9
4.2	Multi-stage restructuring	10
4.3	Restructuring over changed element set	11
5	Restructuring in Combinatorial Optimization Problems	12
5.1	Knapsack problem	12
5.2	Multiple choice problem	14
5.3	Assignment problem	15
5.4	Morphological clique problem	18
5.5	Restructuring in clustering	21
5.6	Restructuring in sorting	23
5.7	Spanning trees problems	24
6	Conclusion	25
7	Acknowledgments	25

*E-mail address: mslevin@acm.org

1. Introduction

In recent decades, the following basic development directions for basic combinatorial optimization formulations have been studied (Fig. 1): (i) multicriteria problem formulations (e.g., [38,44,47,129,130]), (ii) problems under uncertainty (fuzzy combinatorial optimization problems, etc.) (e.g., [86,96,111,140,142]), (iii) problems in dynamic environments (e.g., [25,106,140,141]), and online problems (e.g., [3,4,28,64]). Evidently, the above-mentioned problem development directions can have intersections (e.g., multicriteria online problem under uncertainty).

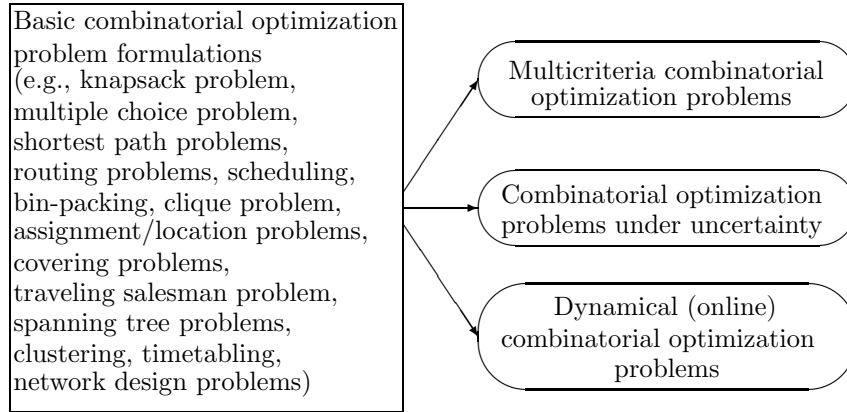

Fig. 1. Basic development directions for problem formulations

In this paper, combinatorial optimization problems with modifications of problem solutions are examined as a special new problem class. Generally, the following basic approaches for changing some solutions in combinatorial optimization problems are considered (Table 1): (1) modification of solution(s) as relinking, reassignment/relocation, rescheduling, repositioning, etc. (including editing problems, network modification/restructuring); (2) reoptimization (modification of a solution by a set of small change operations to improve of the solution objective function(s)); (3) augmentation-type problems (addition/correction of solution components to obtain required solution properties); (4) restructuring (modification of a solution by set of change operations while taking into account two objectives/constraints: cost of the change operations and proximity to an optimal solution at the next time stage); (5) dynamic combinatorial optimization problems (including online problems, problems with changing requests); and (6) design of multistage dynamic restructuring trajectories for problem solution(s).

Table 1. Basic types of reoptimization/restructuring approaches in combinatorial optimization

No.	Direction	Source
1.	Modification of solution/structure (reassignment, relinking, rescheduling, repositioning, editing, recoloring, etc.)	[2,17,29,66,105,119,134,145]
2.	Reoptimization (small correction of solution to improve its quality as improvement of the solution objective function(s)):	[9,14,19,27,49]
3.	Augmentation-type problems (addition/correction of solution components to obtain required solution properties)	[24,42,45,50,62,63,98]
4.	Restructuring problems (modification of solution while taking into account two criteria: minimum modification cost, minimum proximity to a next solution at the next time stage)	[81,87]
5.	Dynamic combinatorial optimization problems (including online problems, problems with changing requests)	[1,51,71,121,138]
6.	Design of multistage dynamic restructuring trajectories for problem solution(s)	[87]

This paper addresses a class of restructuring combinatorial problems. The examined restructuring problems correspond to redesign/reconfiguration (improvement, upgrade) of modular systems and the situations can be faced in many applied domains (e.g., complex software, algorithm systems, communication networks, computer networks, information systems, manufacturing systems, control systems,

constructions) (e.g., [8,18,26,78,79,80,89,92,93,107,115,116]). In basic (one-stage) restructuring problem, an optimization problem is solved for two time moments: τ_0 and τ_1 to obtain corresponding solutions S^0 and S^1 . The problem consists in a “cheap” transformation (change) of solution S^0 to a solution S^* that is very close to S^1 . Generally, the following restructuring problem types are examined: (i) basic one-stage restructuring problem, (ii) multi-stage restructuring problem, (iii) restructuring over changed element set. The restructuring approach is described and illustrated for the following combinatorial optimization problems (e.g., [57,79]): knapsack problem, multiple choice problem, assignment problem, spanning trees problems, clustering, sorting problem, morphological clique problem.

Here, the following restructuring problem statement classification parameters are considered: (1) time-based problem type: (a) one-stage problems, (b) multi-stage problem; (2) types of criteria and/or estimates: (i) basic type, (ii) multicriteria problem, (iii) ordinal (or multiset-based) estimates. Numerical examples illustrate the restructuring processes. Some preliminary materials for the article were published in [81,86,87].

2. Modification problems types in combinatorial optimization

Modification of problem solutions is a well-known traditional technique for improvement/modification and is widely used in various heuristics, e.g., local optimization) (e.g., [2,17,29,66,105,119,134,145]).

In recent years, several combinatorial optimization problems have been examined under the reoptimization process (Fig. 2), for example: (i) travelling salesman problem ([9]), (ii) scheduling [124], (iii) knapsack problem [10], (iv) shortest common superstring problems [21], (v) weighted graph and covering problems [20], (vi) spanning tree problems [116], and (vii) Steiner tree problems [49].

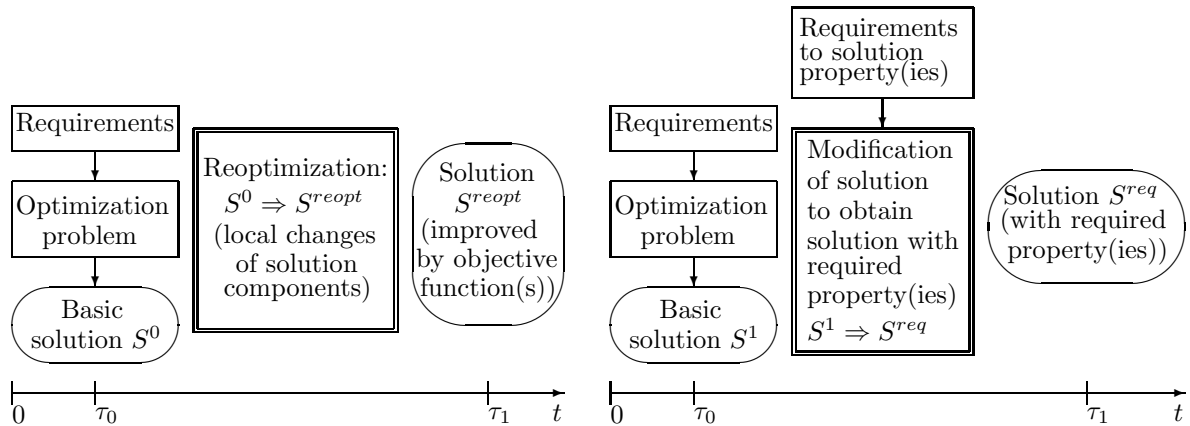

Fig. 2. Framework for reoptimization process

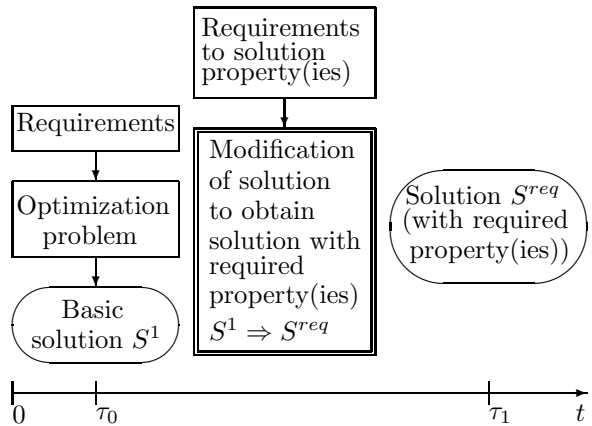

Fig. 3. Framework for augmentation problem

The reoptimization problem describes the following scenario (Fig. 2):

Given an instance of an optimization problem together with an optimal solution for it, we want to find a good solution for a locally modified instance (addition or removing links, etc.) (e.g., [21]).

Thus, reoptimization problems above are targeted to an improvement (“post-optimization”) of an obtained solution. Usually, the reoptimization problems are NP-hard [22]. In some simplified versions of reoptimization problems polynomial approximation schemes (PTAS) have been designed (e.g., [20]). Evidently, the reoptimization approach is a contemporary step in the study of the problem solution modification processes.

Augmentation problems are targeted to obtaining solution(s) with some required properties (Fig. 3), for example: (a) a required level of network connectivity in network topology design (e.g., bi-connected network, k -connected network [24,42,45,50,62,63,98]); (b) a required structure type for the obtained graph/network (e.g., a set of cliques/quasi-cliques [24,42,45,50,62,63,98], a tree/hierarchy with required property(ies)).

Reload cost problems (and close changeover cost problems) are targeted to find a new structure (e.g., paths, spanning trees, schedules, networks) with respect to reload costs [6,56,60,137].

Restructuring combinatorial problems are targeted to restructuring of an initial solution (e.g., a set of elements, a structure) in combinatorial optimization to obtain a new solution that is very close to a goal solution while taking into account a “cheap” modification of the initial solution. Here, our problem statement is described for basic one-criterion and multicriteria problem formulations which are significant for real applications in dynamical environments. Two main features of the restructuring process are examined: (i) a cost of the initial problem solution restructuring, (ii) a closeness of the obtained restructured solution to a goal solution (the cost of restructuring and/or closeness to the goal solution may be used as vector-like functions). Illustrations for one-stage restructuring problem are depicted in Fig. 4 and Fig. 5.

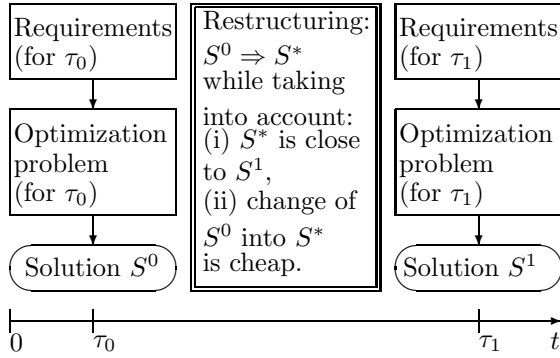

Fig. 4. Framework for one-stage restructuring

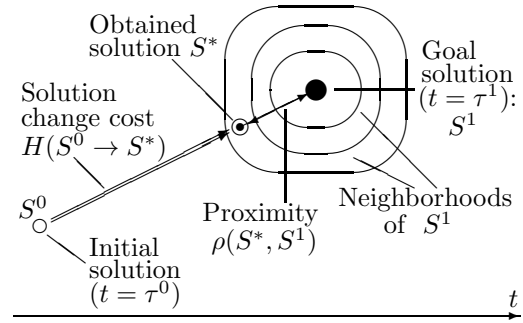

Fig. 5. One-stage restructuring problem

A brief description of a formal statement for the restructuring problem is the following. Let P be a combinatorial optimization problem with a solution as structure S (i.e., subset, graph), Ω be initial data (elements, element parameters, etc.), $f(P)$ be objective function(s). Thus, $S(\Omega)$ be a solution for initial data Ω , $f(S(\Omega))$ be the corresponding objective function. Let Ω^0 be initial data at an initial stage, $f(S(\Omega^0))$ be the corresponding objective function. Ω^1 be initial data at next stage, $f(S(\Omega^1))$ be the corresponding objective function. As a result, the following solutions can be considered:

- (a) $S^0 = S(\Omega^0)$ with $f(S(\Omega^0))$ and (b) $S^1 = S(\Omega^1)$ with $f(S(\Omega^1))$.

In addition it is reasonable to examine a cost of changing a solution into another one: $H(S^\alpha \rightarrow S^\beta)$. Let $\rho(S^\alpha, S^\beta)$ be a proximity between solutions S^α and S^β , for example, $\rho(S^\alpha, S^\beta) = |f(S^\alpha) - f(S^\beta)|$. Note function $f(S)$ is often a vector function. Finally, the restructuring problem can be examine as follows (a basic version):

- Find a solution S^* while taking into account the following:
 (i) $H(S^0 \rightarrow S^*) \rightarrow \min$, (ii) $\rho(S^*, S^1) \rightarrow \min$ (or constraint).

Dynamic problems (including online problems, problems with changing requests) (i.e., while taking into account dynamically changing environment) are illustrated in Fig. 6. Here new requirements are obtaining in online mode and it is necessary to resolve the problem at each time moment (e.g., [1,51,71,121,138]). In Fig. 6, the resultant solution trajectory is: $\hat{S} = \langle S^0 \rightarrow S^1 \rightarrow S^2 \rightarrow \dots \rangle$.

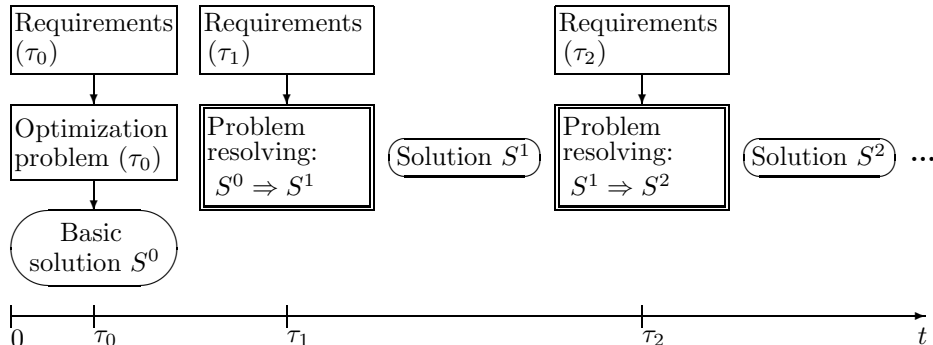

Fig. 6. Illustration for dynamic (online) problem solving processes

Fig. 7 illustrates a simplified general version of dynamic clustering (the scheme is similar to case-based reasoning) (e.g., [69]).

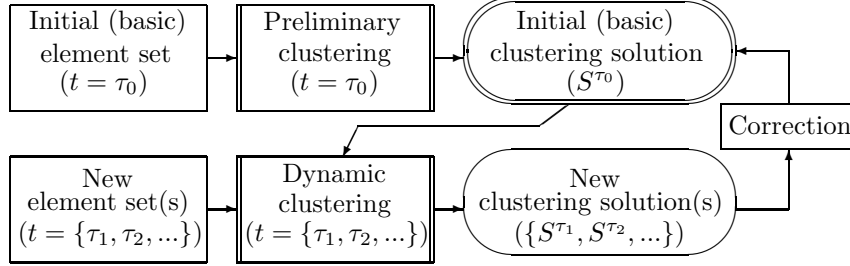

Fig. 7. Scheme of dynamic clustering process

In multi-stage restructuring problems, a solution trajectory is designed (Fig. 8, Fig. 9). Thus, two trajectories are examined:

- (a) n -stage trajectory of optimal solutions: $\bar{S}^{opt} = \langle S^0 \rightarrow S^1 \rightarrow S^2 \rightarrow \dots \rightarrow S^n \rangle$,
- (b) n -stage trajectory of restructured solutions: $\bar{S}^{rest} = \langle S^0 \rightarrow S^{1*} \rightarrow S^{2*} \rightarrow \dots \rightarrow S^{n*} \rangle$.

Here, the restructuring problem can be examine as follows (a basic version):

Find a solution \bar{S}^{rest} while taking into account the following:

- (i) $\bar{H}(\bar{S}^{rest} \rightarrow \bar{S}^{opt}) \rightarrow \min$, (ii) $\bar{\rho}(\bar{S}^{rest}, \bar{S}^{opt}) \rightarrow \min$ (or constraint),

where

$$\bar{H}(\bar{S}^{rest} \rightarrow \bar{S}^{opt}) = (H(S^0 \rightarrow S^{1*}), H(S^{1*} \rightarrow S^{2*}), \dots, H(S^{(n-1)*} \rightarrow S^{n*})),$$

$$\bar{\rho}(\bar{S}^{rest}, \bar{S}^{opt}) = (\rho(S^{1*}, S^1), \rho(S^{2*}, S^2), \dots, \rho(S^{n*}, S^n)).$$

Note, minimization (maximization) of a vector function corresponds to searching for Pareto-efficient solutions. The corresponding optimization model can be examined as the following:

$$\min \bar{\rho}(\bar{S}^{rest}, \bar{S}^{opt}) \quad s.t. \quad \bar{H}(\bar{S}^{rest} \rightarrow \bar{S}^{opt}) \leq \hat{h},$$

where $\hat{h} = (\hat{h}_1, \hat{h}_2, \dots, \hat{h}_n)$ is a set (vector) of constraints for costs of the solution changes (i.e., a vector component corresponds to each stage).

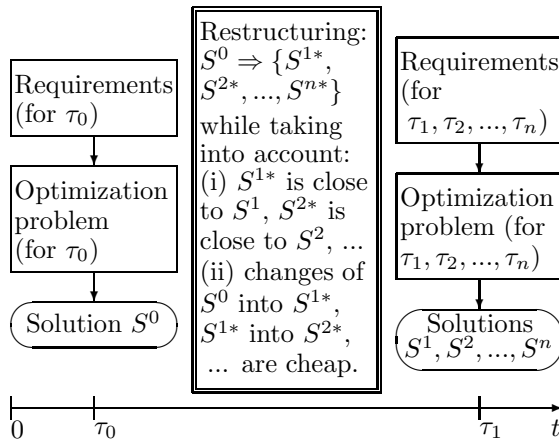

Fig. 8. Framework for n -stage restructuring

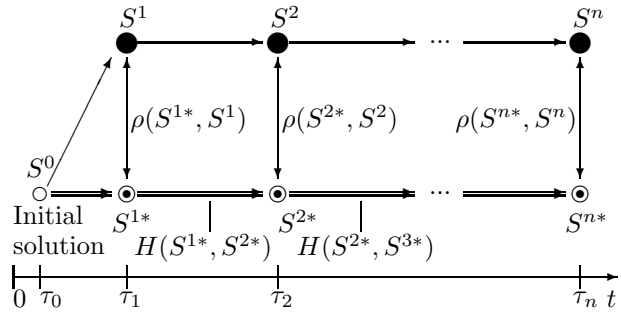

Fig. 9. Multi-stage restructuring problem

Clearly, the multi-stage restructuring problems are very complicated. The problems consist of a combination of NP-hard combinatorial problems. Thus, it is necessary to use composite heuristic solving schemes for the multi-stage restructuring problems.

Table 2 contains an integrated list on basic research directions on the considered six types of modification problems in combinatorial optimization.

Table 2. Basic research reoptimization/restructuring directions in combinatorial optimization

No.	Direction	Source
1.	Modification of solution/structure (reassignment, relinking, rescheduling, repositioning, editing, recoloring, etc.):	
1.1.	Reassignment/relocation/repositioning	[17,30,40,66,76,99,101,134,135,136]
1.2.	Rescheduling	[37,68,94,118,133,147]
1.3.	Path relinking: routing, TSP, orienteering, network design (multi-layer optimization, load balancing, topology control)	[2,5,52,58,59,65,75,102,104,113]
1.4.	Reconnecting network partitions	[46]
1.5.	Hotlink assignment problems (addition of direct links into hierarchical/tree-like information structure)	[29,41,54,83,86]
1.6.	Recoloring of graphs (e.g., paths, strings, trees)	[79,95,105]
1.7.	Vehicle relocation problem	[125]
1.8.	Block relocation problem (container relocation problem)	[31,32,33,70,72,114,144,145]
2.	Reoptimization (small correction of solution to improve its quality as the objective function(s)):	
2.1.	Minimum spanning tree problem	[27]
2.2.	Traveling salesman problems (TSP), postman problem, etc.	[9,11,14]
2.3.	Steiner tree problems	[19,49]
2.4.	Covering problems	[20]
2.5.	Shortest common superstring problem	[21]
3.	Augmentation-type problems (addition/correction of solution components to obtain required solution properties):	
3.1.	Augmentation network problems (addition of links to obtain required network properties (e.g., connectivity level))	[50]
3.2.	Social network restructuring (node/link addition/deletion)	[62]
3.3.	Cluster editing problem (edge addition/deletion in graph to obtain a disjoint union of cliques)	[23,24,42,45,63,98] [117,126]
4.	Reload cost problems, changeover cost problems:	
4.1.	Reload cost spanning trees, networks	[56,60,137]
4.2.	Reload cost paths, tours, flows	[6]
4.3.	Spectrum switching scheduling	[61]
5.	Restructuring problems (modification of solution with two criteria: minimum modification cost, minimum proximity to a next solution at the next time stage):	
5.1.	Knapsack problem	[81,86]
5.2.	Multiple choice problem	[81]
5.3.	Spanning tree problems	[81]
5.4.	Clustering problem	[87]
5.5.	Assignment/location problems	this paper
6.	Dynamic combinatorial optimization problems:	
6.1.	Dynamic knapsack problem	[73,74,121]
6.2.	Dynamic clustering	[34,36,43,69,100,108,110,143]
6.3.	Dynamic scheduling (e.g., rescheduling strategies)	[1,7,15,16,39,51,97,109,133]
6.4.	Online bin-packing	[13,55]
6.5.	Dynamic routing (e.g., VRP with changing requests)	[12,35,71,123]
6.6.	Dynamic path replanning for UAVs	[138]
7.	Multistage dynamic restructuring problems	
7.1.	Knapsack problem	this paper
7.2.	Classification, clustering, sorting	[87], this paper
7.3.	Morphological clique problem	this paper

3. Basic Assessment Scales

The list of basic considered assessment scales (for system parts/ components, for final system) involves the following (e.g., [82,86]): (i) quantitative scale, (ii) ordinal scale, (iii) multicriteria description or vector estimate, (iv) poset-like scales (based on ordinal vectors, based on multiset estimates). The descriptions for the scales is presented in [82,86]. Some illustrations for the scales above are shown in Fig. 10, Fig. 11, Fig. 12. Let us consider illustrations for the above-mentioned basic assessment scales.

In the case of vector scales, domination is illustrated in Fig. 10c: $\alpha_2 \succ \beta_2$, $\alpha_2 \succ \beta_3$, $\alpha_2 \succ \beta_4$. In the case of domination by Pareto-rule (e.g., [103,112]), the basic domination binary relation is extended by cases as $\alpha_2 \succ^P \beta_1$. Here, the following ordered layers of quality can be considered (as a special system ordinal scale D , by illustration in Fig. 10c): (i) the ideal point (the best point) α^I , (ii) a layer of Pareto-efficient points (e.g., points: $\{\alpha_1, \alpha_2, \alpha_3, \alpha_4\}$), (iii) near Pareto-efficient points (the points are close to the Pareto-layer, e.g., points: $\{\beta_1, \beta_2, \beta_3, \beta_4, \beta_5\}$), (iv) a next layer of quality (i.e. between near Pareto-efficient points and the worst point, e.g., points: $\{\gamma_1, \gamma_2\}$), and (v) the worst point.

The description of poset-like scales (or lattices) for quality of composite (modular) systems (based on ordinal estimates of DAs and their compatibility) was suggested within framework of HMMD approach (e.g., [77,78,86]) Here, two cases have to be examined: (1) scale for system quality based on system components ordinal estimates ($\iota = \overline{1, l}$; 1 corresponds to the best one); (2) scale for system quality while taking into account system components ordinal estimates and ordinal compatibility estimates between the system components ($w = \overline{1, \nu}$; ν corresponds to the best level).

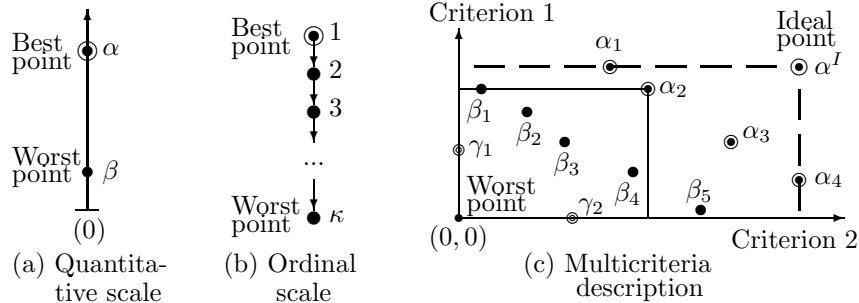

Fig. 10. Quantitative scale, ordinal scale, multicriteria description [82,86]

For the system consisting of m parts/components, a discrete space (poset, lattice) of the system quality (excellence) on the basis of the following vector is used: $N(S) = (w(S); n(S))$, where $w(S)$ is the minimum of pairwise compatibility between DAs which correspond to different system components (i.e., $\forall P_{j_1}$ and P_{j_2} , $1 \leq j_1 \neq j_2 \leq m$) in S , $n(S) = (\eta_1, \dots, \eta_r, \dots, \eta_k)$, where η_r is the number of DAs of the r th quality in S ($\sum_{r=1}^k n_r = m$).

An example of the three-component system $S = X \star Y \star Z$ is considered. The following ordinal scales are used: (a) ordinal scale for elements (priorities) is $[1, 2, 3]$, (b) ordinal scale for compatibility is $[0, 1, 2, 3]$. For this case, Fig. 11a depicts the poset of system quality by components and Fig. 11b depicts an integrated poset with compatibility (each triangle corresponds to the poset from Fig. 11a). Generally, the following layers of system excellence can be considered (Fig. 11, this corresponds to the resultant system scale D in Fig. 11b):

1. The ideal point $N(S^I)$ (S^I is the ideal system solution).

2. A layer of Pareto-efficient solutions: $\{S_1^p, S_2^p, S_3^p\}$; estimates are: $N(S_1^p) = (2; 3, 0, 0)$, $N(S_2^p) = (3; 1, 1, 1)$, and $N(S_3^p) = (3; 0, 3, 0)$.

3. A next layer of quality (e.g., neighborhood of Pareto-efficient solutions layer): $\{S_1', S_2', S_3'\}$; estimates are: $N(S_1') = (1; 3, 0, 0)$, $N(S_2') = (2; 1, 1, 1)$, and $N(S_3') = (3; 0, 2, 1)$; a composite solution of this set can be transformed into a Pareto-efficient solution on the basis of a simple improvement action(s) (e.g., as modification of the only one element).

4. A next layer of quality S'' ; estimate is: $N(S'') = (1; 0, 3, 0)$.

5. The worst point S_0 ; estimate is: $N(S_0) = (1; 0, 0, 3)$.

Note, the compatibility component of vector $N(S)$ can be considered on the basis of a poset-like scale too (as $n(S)$) [78]. In this case, the discrete space of system excellence will be an analogical lattice.

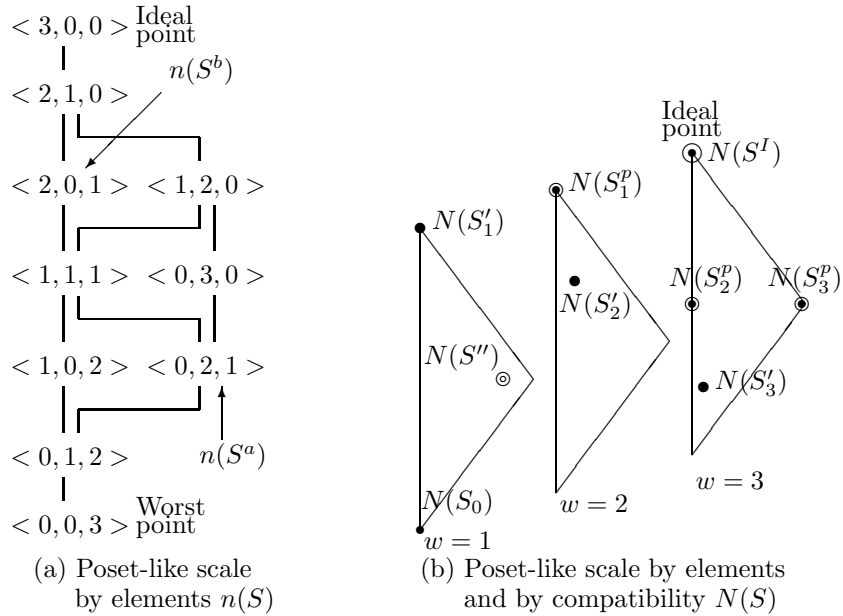

Fig. 11. Poset-like scale based on ordinal estimates (based on [86])

The poset-like scales based on interval multiset estimates have been suggested in [82,86]. Analogically, two cases have to be considered: (i) system estimate by components, (ii) system estimate by components and by component compatibility. Fig. 12a illustrates the scale-poset and estimates for problem $P_{3,3}$ (assessment over scale $[1, 3]$ with three elements, estimates $(2, 0, 2)$ and $(1, 0, 2)$ are not used) [82,86]. Evidently, the above-mentioned resultant special system ordinal scale D can be used here as well. For evaluation of multi-component system, multi-component poset-like scale (as in Fig. 11b) composed from several poset-like scale (as in Fig. 12) may be used [82,86]. Fig. 12b depicts the integrated poset-like scale for tree-component system (compatibility scale is $[0, 1, 2, 3]$).

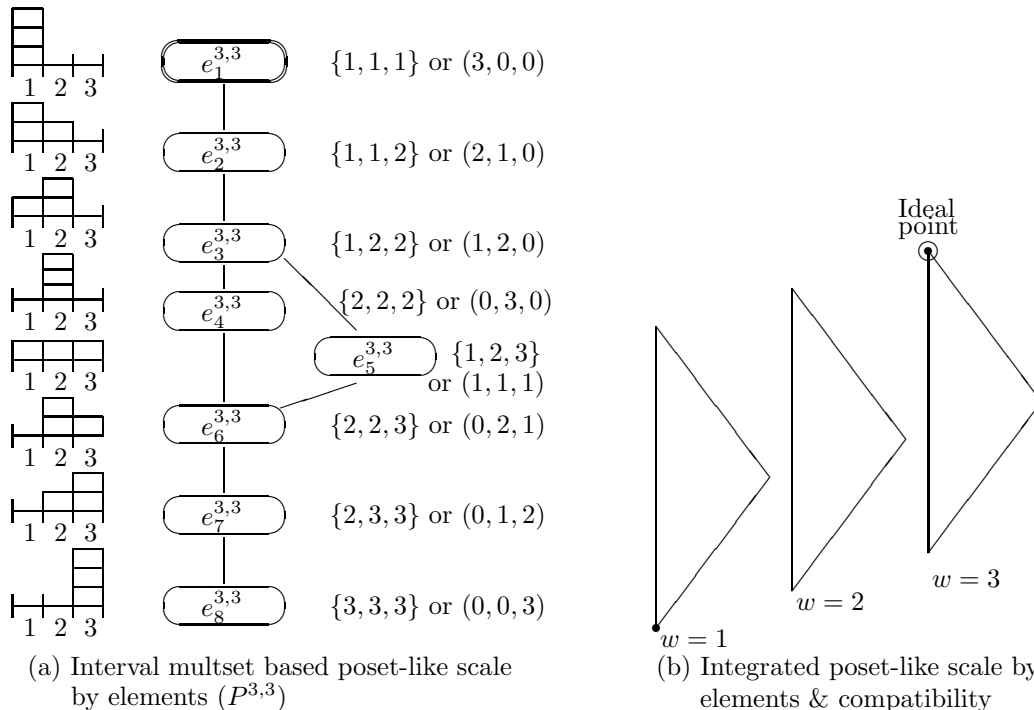

Fig. 12. Multiset based scale, estimates (based on [82,86])

4. Restructuring Problems

4.1. One-stage restructuring

The basic one-stage restructuring problem was illustrated in Fig. 4 and Fig. 5. Let P be a combinatorial optimization problem with a solution as structure S (i.e., subset, graph), Ω be initial data (elements, element parameters, etc.), $f(P)$ be objective function(s). Thus, $S(\Omega)$ be a solution for initial data Ω , $f(S(\Omega))$ be the corresponding objective function. Let Ω^1 be initial data at an initial stage, $f(S(\Omega^1))$ be the corresponding objective function. Ω^2 be initial data at next stage, $f(S(\Omega^2))$ be the corresponding objective function. As a result, the following solutions can be considered: (a) $S^1 = S(\Omega^1)$ with $f(S(\Omega^1))$ and (b) $S^2 = S(\Omega^2)$ with $f(S(\Omega^2))$.

In addition it is reasonable to examine a cost of changing a solution into another one: $H(S^\alpha \rightarrow S^\beta)$. Let $\rho(S^\alpha, S^\beta)$ be a proximity between solutions S^α and S^β , for example, $\rho(S^\alpha, S^\beta) = |f(S^\alpha) - f(S^\beta)|$. Note function $f(S)$ is often a vector function. Finally, the restructuring problem can be examine as follows (a basic version):

Find a solution S^* while taking into account the following:

- (i) $H(S^1 \rightarrow S^*) \rightarrow \min$, (ii) $\rho(S^*, S^2) \rightarrow \min$ (or constraint).

The corresponding basic optimization model is: $\min \rho(S^*, S^2) \quad s.t. \quad H(S^1 \rightarrow S^*) \leq \hat{h}$, where \hat{h} is a constraint for cost of the solution change. In a simple case, this problem can be formulated as knapsack problem for selection of a subset of change operations [81,86]:

$$\max \sum_{i=1}^n c_i^1 x_i \quad s.t. \quad \sum_{i=1}^n a_i^1 x_i \leq b^1, \quad x_i \in \{0, 1\}.$$

In the case of interconnections between change operations, it is reasonable to consider combinatorial synthesis problem (i.e., while taking into account compatibility between the operations).

Now let us consider multicriteria restructuring problems.

First, the initial combinatorial optimization problem can be by a multicriteria one. As a result, a set of Pareto-efficient solutions have to be considered.

Second, the proximity function $\rho(S^*, S^2)$ (or $\rho(S^{*j}, \{S^{21}, S^{22}, S^{23}\})$) can be examined as a vector function as well (analogically for the solution change cost).

The situation will lead to a multicriteria restructuring problem (and to searching for Pareto-efficient solution(s)) (Fig. 13):

Find a solution S^* while taking into account the following:

- (i) $\bar{H}(S^1 \rightarrow S^*) \rightarrow \min$, (ii) $\bar{\rho}(S^*, S^2) \rightarrow \min$ (or constraint).

The corresponding multicriteria optimization is: $\min \bar{\rho}(S^*, S^2) \quad s.t. \quad \bar{H}(S^1 \rightarrow S^*) \leq \hat{h}$, where vector \hat{h} is a vector constraint for cost of the solution change. In a simple case of the multicriteria restructuring, problem can be formulated as a multicriteria knapsack problem for selection of a subset of change operations:

$$\max \sum_{i=1}^n \bar{c}_i^1 x_i \quad s.t. \quad \sum_{i=1}^n \bar{a}_i^1 x_i \leq \bar{b}^1, \quad x_i \in \{0, 1\}.$$

In the case of interconnections between change operations, it is reasonable to consider combinatorial synthesis problem (i.e., while taking into account compatibility between the operations).

In the case of ordinal estimates and/or multiset estimates, restructuring problems (i.e., searching for Pareto-efficient solution(s) at posets for \bar{H} and for $\bar{\rho}$ based on ordinal scale and/or multiset scale; as in Fig. 11, Fig. 12) are:

Find a solution S^* while taking into account the following:

- (i) $\tilde{H}(S^1 \rightarrow S^*) \rightarrow \min$, (ii) $\tilde{\rho}(S^*, S^2) \rightarrow \min$ (or constraint),

where estimates of $\tilde{H}(S^1)$ and $\tilde{\rho}$ are based on ordinal and/or multiset scale (as in Fig. 11, Fig. 12).

The kinds of optimization problems are described in [81,86].

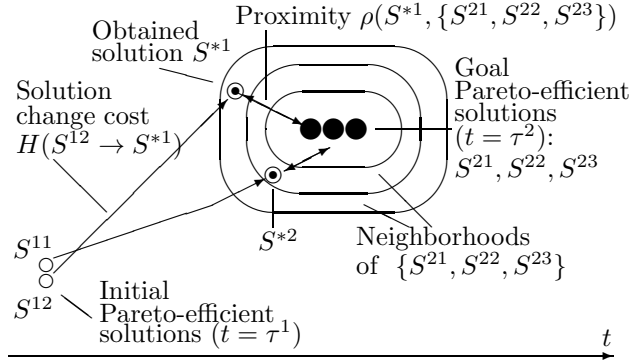

Fig. 13. Multicriteria restructuring [81,86]

4.2. Multi-stage restructuring

In multi-stage restructuring problems were illustrated in Fig. 7 and Fig. 8. Two basic trajectories are:

- (a) n -stage trajectory of optimal solutions: $\bar{S}^{opt} = \langle S^0 \rightarrow S^1 \rightarrow S^2 \rightarrow \dots \rightarrow S^n \rangle$,
- (b) n -stage trajectory of restructured solutions: $\bar{S}^{rest} = \langle S^0 \rightarrow S^{1*} \rightarrow S^{2*} \rightarrow \dots \rightarrow S^{n*} \rangle$.

As a result, the problem is:

Find Pareto-efficient solution(s) \bar{S}^{rest} while taking into account the following:

- (i) $\bar{H}(\bar{S}^{rest} \rightarrow \bar{S}^{opt}) \rightarrow \min$, (ii) $\bar{\rho}(\bar{S}^{rest}, \bar{S}^{opt}) \rightarrow \min$ (or constraint),
- where $\bar{H}(\bar{S}^{rest} \rightarrow \bar{S}^{opt}) = (H(S^0 \rightarrow S^{1*}), H(S^{1*} \rightarrow S^{2*}), \dots, H(S^{(n-1)*} \rightarrow S^{n*}))$,
 $\bar{\rho}(\bar{S}^{rest}, \bar{S}^{opt}) = (\rho(S^{1*}, S^1), \rho(S^{2*}, S^{2*}), \dots, \rho(S^{n*}, S^n))$.

Here, two corresponding simplified optimization models can be examined as the following:

- (a) $\min \bar{\rho}(\bar{S}^{rest}, \bar{S}^{opt}) \quad s.t. \quad \bar{H}(\bar{S}^{rest} \rightarrow \bar{S}^{opt}) \leq \hat{h}$,
- (b) $\min \bar{\rho}(\bar{S}^{rest}, \bar{S}^{opt}) \quad s.t. \quad \bar{\rho}(\bar{S}^{rest}, \bar{S}^{opt}) \leq \hat{\rho}$,

where $\hat{h} = (\hat{h}_1, \hat{h}_2, \dots, \hat{h}_n)$ is a set (vector) of constraints for costs of the solution changes (i.e., a vector component corresponds to each stage), $\hat{\rho} = (\hat{\rho}_1, \hat{\rho}_2, \dots, \hat{\rho}_n)$ is a set (vector) of constraints for proximities of the solutions (i.e., a vector component corresponds to each stage).

The following heuristic solving schemes (frameworks) can be considered:

Scheme 1 (series solving process):

Step 1. Solving the optimization problem at each stage 1 (i.e., τ_1):

- (1.1.) Finding the optimization solution S^1 (basic optimization).
- (1.2.) Finding the restructuring solution S^{1*} (i.e., $S^0 \rightarrow S^{1*}$).

Step 2. Solving the optimization problem at each stage 2 (i.e., τ_2):

- (a) Finding the optimization solution S^2 (basic optimization).
- (b) Finding the restructuring solution S^{2*} (i.e., $S^{1*} \rightarrow S^{2*}$).

...

Step n. Solving the optimization problem at each stage 2 (i.e., τ_n):

- (a) Finding the optimization solution S^n (basic optimization).
- (b) Finding the restructuring solution S^{n*} (i.e., $S^{(n-1)*} \rightarrow S^{n*}$).

Scheme 2 ("composition" solving process):

Step 1. Solving the optimization problems:

- (1.1.) Finding the optimization solution S^1 (basic optimization at stage 1) (i.e., τ_1).
- (1.2.) Finding the optimization solution S^2 (basic optimization at stage 2) (i.e., τ_2).

...

- (1.n.) Finding the optimization solution S^n (basic optimization at stage n) (i.e., τ_n).

Step 2. Solving the one-stage restructuring problems for each stage to obtain several “good” solutions:

(2.1.) Finding the “good” solutions at stage 1: $S^0 \rightarrow \{S_1^{1*}, S_2^{1*}, \dots, S_{q_1}^{1*}\}$.

(2.2.) Finding the “good” solutions at stage 2: $\{S_1^{1*}, S_2^{1*}, \dots, S_{q_1}^{1*}\} \rightarrow \{S_1^{2*}, S_2^{2*}, \dots, S_{q_2}^{2*}\}$.

...

(2.n.) Finding the “good” solutions at stage n : $\{S_1^{(n-1)*}, S_2^{(n-1)*}, \dots, S_{q_{n-1}}^{(n-1)*}\} \rightarrow \{S_1^{n*}, S_2^{n*}, \dots, S_{q_n}^{n*}\}$.

Step 3. Composition of multi-stage restructuring solution trajectory (i.e., selection of a restructuring solution at each stage for solving the multi-stage restructuring problem above) (Fig. 14) (the initial point of the trajectory corresponds to S^0): $\overline{S}^{rest} = \langle S^0 \rightarrow S_{\xi_1}^{1*} \rightarrow S_{\xi_2}^{2*} \rightarrow \dots \rightarrow S_{\xi_n}^{n*} \rangle$, where $\xi_1 \in \{1, \dots, q_1\}$, $\xi_2 \in \{1, \dots, q_2\}, \dots, \xi_n \in \{1, \dots, q_n\}$.

The solving scheme 3 extends scheme 2 by finding several good solution trajectories and selection of the best final solution trajectory:

Scheme 3 (“composition&selection” solving process):

Step 1. Solving the optimization problems:

(1.1.) Finding the optimization solution S^1 (basic optimization at stage 1) (i.e., τ_1).

(1.2.) Finding the optimization solution S^2 (basic optimization at stage 2) (i.e., τ_2).

...

(1.n.) Finding the optimization solution S^n (basic optimization at stage n) (i.e., τ_n).

Step 2. Solving the one-stage restructuring problems for each stage to obtain several “good” solutions (as in Scheme 2).

Step 3. Composition of k ($k > 1$) multi-stage restructuring solution trajectories: (e.g., selection of a restructuring solution at each stage for solving the multi-stage restructuring problem above) (Fig. 14) (the initial point of each trajectory corresponds to S^0):

(3.1.) $\overline{S}_1^{rest} = \langle S^0 \rightarrow S_{\xi_1^1}^{1*} \rightarrow S_{\xi_2^1}^{2*} \rightarrow \dots \rightarrow S_{\xi_n^1}^{n*} \rangle$,

where $\xi_1^1 \in \{1, \dots, q_1\}, \xi_2^1 \in \{1, \dots, q_2\}, \dots, \xi_n^1 \in \{1, \dots, q_n\}$;

(3.2.) $\overline{S}_2^{rest} = \langle S^0 \rightarrow S_{\xi_1^2}^{1*} \rightarrow S_{\xi_2^2}^{2*} \rightarrow \dots \rightarrow S_{\xi_n^2}^{n*} \rangle$,

where $\xi_1^2 \in \{1, \dots, q_1\}, \xi_2^2 \in \{1, \dots, q_2\}, \dots, \xi_n^2 \in \{1, \dots, q_n\}$;

...

(3.k.) $\overline{S}_k^{rest} = \langle S^0 \rightarrow S_{\xi_1^k}^{1*} \rightarrow S_{\xi_2^k}^{2*} \rightarrow \dots \rightarrow S_{\xi_n^k}^{n*} \rangle$,

where $\xi_1^k \in \{1, \dots, q_1\}, \xi_2^k \in \{1, \dots, q_2\}, \dots, \xi_n^k \in \{1, \dots, q_n\}$.

Step 4. Selection of the best restructuring trajectory \overline{S}_*^{rest} (Fig. 15): $\{\overline{S}_1^{rest}, \overline{S}_2^{rest}, \dots, \overline{S}_k^{rest}\} \Rightarrow \overline{S}_*^{rest}$

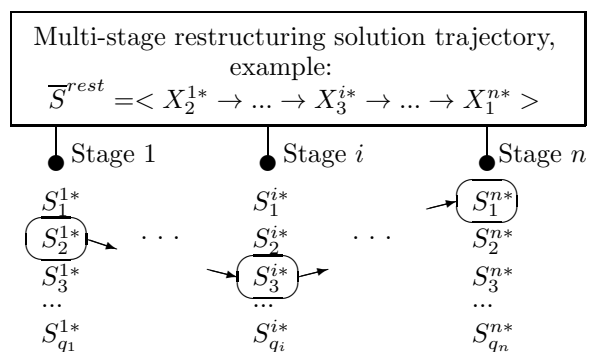

Fig. 14. Composition of restructuring trajectory

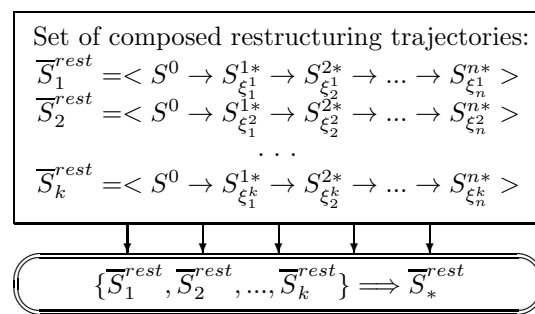

Fig. 15. Selection of the best trajectory

4.3. Restructuring over changed element set

Let us consider restructuring over changed element set for knapsack problem (i.e., combinatorial optimization problem over one element set). The following element sets are examined (Fig. 16): (i) initial set A_0 , (ii) new set A_1 , (iii) added (new) set A^+ , (iv) deleted set $A^- = A_0 \setminus \{A_0 \cap A_1\}$, and (v) fixed (non-changed) element set $\hat{A} = \{A_0 \cap A_1\}$.

Here, the restructuring problem is considered as a one-stage restructuring (Fig. 17):

- Find a solution S^* while taking into account the following:
- (i) $H(S^1 \rightarrow S^*) \rightarrow \min$, (ii) $\rho(S^*, S^2) \rightarrow \min$ (or constraint),
- where cost $\rho(S^*, S^2)$ involves the following components:
- (a) cost of deletion of elements $A^- = A_0 \setminus \{A_0 \cap A_1\}$,
 - (b) cost of processing fixed elements $\hat{A} = \{A_0 \cap A_1\}$,
 - (c) cost for processing new elements A^+ .

Thus, the correction problem (as a basic correction problem) is solved over elements $\hat{A} \cup A^+$ while taking into account cost of deletion of elements A^- . The problem can be extended for multi-stage case.

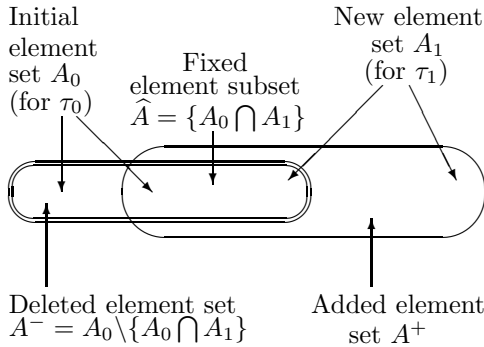

Fig. 16. Illustration of changing sets

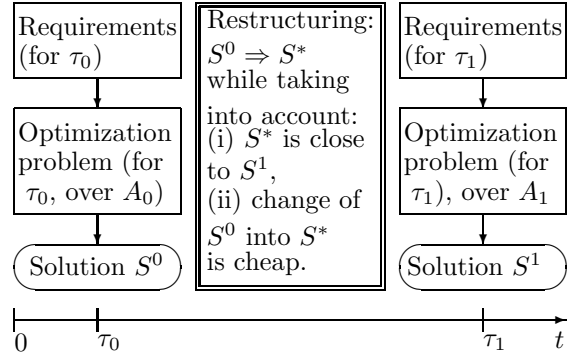

Fig. 17. Restructuring over changed element set

5. Restructuring in Combinatorial Optimization Problems

5.1. Knapsack problem

Let us present the restructuring approach for basic knapsack problem from [81]. Let $A = \{1, \dots, i, \dots, n\}$ be a basic initial set of elements. Knapsack problem is considered for two time moments τ_0 and τ_1 (for τ_1 parameters $\{c_i^1\}$, $\{a_i^1\}$, and b^1 are used):

$$\max \sum_{i=1}^n c_i^0 x_i \quad s.t. \quad \sum_{i=1}^n a_i^0 x_i \leq b^0, \quad x_i \in \{0, 1\}.$$

The corresponding solutions are: $S^0 \subseteq A$ ($t = \tau_0$) and $S^1 \subseteq A$ ($t = \tau_1$) ($S^0 \neq S^1$).

Illustrative numerical example is: $A = \{1, 2, 3, 4, 5, 6, 7\}$, $S^0 = \{1, 3, 4, 5\}$, $S^1 = \{2, 3, 5, 7\}$, $S^* = \{2, 3, 4, 6\}$. The change (restructuring) process (i.e., $S^0 \Rightarrow S^*$) is based on the following (Fig. 18): (a) deleted elements: $S^{*-} = S^0 \setminus S^* = \{1, 5\}$, (b) added elements: $S^{*+} = S^* \setminus S^0 = \{2, 6\}$.

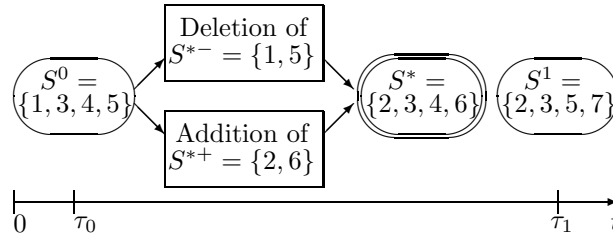

Fig. 18. Example for restructuring

Note the following exists at the start stage of the solving process: $S^{*-} = S^0$ and $S^{*+} = A \setminus S^0$. The restructuring problem can be considered as the following:

$$\min \rho(S^*, S^1) \quad s.t. \quad H(S^0 \Rightarrow S^*) = \left(\sum_{i \in S^{*-}} h_i^- + \sum_{i \in S^{*+}} h_i^+ \right) \leq \hat{h}, \quad \sum_{i \in S^*} a_i^2 \leq b^2,$$

where \hat{h} is a constraint for the change cost, $h^-(i)$ is a cost of deletion of element $i \in A$, and $h^+(i)$ is a cost of addition of element $i \in A$. On the other hand, an equivalent problem can be examined:

$$\max \sum_{i \in S^*} x_i c_i^1 \quad s.t. \quad H(S^0 \Rightarrow S^*) = \left(\sum_{i \in S^{*-}} h_i^- + \sum_{i \in S^{*+}} h_i^+ \right) \leq \hat{h}, \quad \sum_{i \in S^*} a_i^1 \leq b^1,$$

because $\max \sum_{i \in S^*} x_i c_i^1 \leq \max \sum_{i \in S^2} x_i c_i^1$ while taking into account constraint: $\sum_{i \in S^*} a_i^1 \leq b^1$. The obtained problem is a modified knapsack-like problem as well. At the same time, it is possible to use a simplified solving scheme (by analysis of *change elements* for addition/deletion): (a) generation of candidate elements for deletion (i.e., selection of S^{*-} from S^0), (b) generation of candidate elements for addition (i.e., selection of S^{*+} from $A \setminus S^0$). The selection processes may be based on multicriteria ranking. As a result, a problem with sufficiently decreased dimension will be obtained.

In the case of multicriteria knapsack problem, the restructuring process is the same (i.e., selection of deletion and addition operations). Thus, the restructuring problem can be examined as multicriteria knapsack problem. Analogical situation exists in the case of ordinal or multiset estimates [82,86].

Applied three-stage example for three-stage restructuring ($t \in \{\tau_0, \tau_1, \tau_2\}$) of modular educational course is considered (Table 3, educational topics/items are $A = \{1, \dots, i, \dots, 13\}$).

Table 3. Components of modular course on combinatorial optimization, their parameters

i	Topic (item)	τ_0 :	c_i^0	a_i^0	τ_1 :	c_i^1	a_i^1	h_i^{1-}	h_i^{1+}	τ_2 :	c_i^2	a_i^2	h_i^{2-}	h_i^{2+}
1.	Complexity, algorithms		4.0	1.5		5.0	2.0	0.5	1.0		5.0	2.0	0.5	1.0
2.	Knapsack		4.0	3.0		5.0	4.0	0.6	1.5		5.0	4.0	0.6	1.5
3.	Routing		1.0	3.5		5.0	4.0	0.8	1.4		6.0	5.0	0.8	1.4
4.	Assignment/ allocation		4.0	2.5		5.0	3.0	0.7	1.5		5.0	3.0	0.7	1.5
5.	Scheduling		1.5	5.0		2.0	4.0	0.4	1.5		3.0	5.0	0.4	1.5
6.	Packing		1.0	3.0		3.0	3.0	0.3	1.0		3.5	4.0	0.3	1.0
7.	Covering		1.0	1.5		2.5	2.0	0.4	1.0		3.0	3.5	0.4	1.0
8.	Spanning trees		3.0	2.0		4.0	2.5	1.0	1.5		5.0	3.5	1.0	1.5
9.	Clique-based		1.0	1.5		1.5	2.0	0.3	0.8		2.0	2.0	0.3	0.8
10.	Graph coloring		1.0	1.5		2.0	1.7	0.2	0.7		2.5	2.0	0.2	0.7
11.	Clustering, sorting		4.0	2.0		5.0	2.5	1.0	1.7		5.5	2.5	1.0	1.7
12.	Alignment		1.0	0.8		0.9	1.0	0.2	0.3		0.9	1.0	0.2	0.3
13.	Satisfiability		2.0	2.0		1.5	2.0	0.2	0.3		1.0	2.0	0.2	0.3

The following parameters of each item i are examined (γ is the number of stage, $\gamma = 0, 1, 2$): (a) profit (utility) c_i^γ , (b) required resource a_i^γ , (c) cost of deletion for item i $h_i^{\gamma-}$, (d) cost of addition $h_i^{\gamma+}$.

First, knapsack problems for each stage ($\gamma = 0, 1, 2$) are considered ($b^0 = 14$, $b^1 = 20$, $b^2 = 23$):

$$\max \sum_{i=1}^{13} c_i^\gamma x_i^\gamma \quad s.t. \quad \sum_{i=1}^{13} a_i^\gamma \leq b^\gamma$$

The obtained solutions are: $S^0 = \{1, 2, 4, 8, 11, 12, 13\}$, $c(S^0) = 22.0$, $b(S^0) = 13.8$; $S^1 = \{1, 2, 4, 8, 10, 11\}$, $c(S^1) = 31.0$, $b(S^1) = 19.7$; $S^2 = \{1, 2, 3, 4, 7, 8, 11\}$, $c(S^2) = 29.5$, $b(S^2) = 22.5$. Note, the assumption is: items $B = \{1, 2, 4, 8, 11\}$ are included in solutions at each stage. Thus, set $\hat{A} = \{3, 5, 6, 7, 9, 10, 12, 13\}$ is under change process. Further, two series restructuring problems (as deletion/addition knapsack problems) are examined (as in *Scheme 1*): $S^0 \rightarrow S^{*1}$ and $S^{*1} \rightarrow S^{*2}$. The local restructuring problem for τ_1 is ($\rho(S^{*1}, S^1) = |c(S^{*1}) - c(S^1)|$), $D^1 = 1.6$ is constraint for total change cost):

$$\min \rho(S^{*1}, S^1) \quad s.t. \quad \left(\sum_{i \in (\hat{A} \cap S^0)} h_i^{1-} + \sum_{i \in (\hat{A} \setminus (\hat{A} \cap S^0))} h_i^{1+} \right) \leq D^1, \quad \sum_{i \in (B \cup (\hat{A} \setminus (\hat{A} \cap S^0)))} a_i \leq b^1.$$

The examined restructuring solutions are (problem for τ_2 is analogical, $D^2 = 1.6$):

$$S^{*1} = \{1, 2, 3, 4, 8, 11\}, c(S^{*1}) = 29.0, b(S^{*1}) = 19.0;$$

$$S^{*2} = \{1, 2, 3, 4, 8, 11\}, c(S^{*2}) = 29.5, b(S^{*2}) = 22.5 \text{ (here, } S^{*2} = S^2).$$

The final trajectory is: $\overline{S}^{rest} = \langle S^0, S^{*1}, S^{*2} \rangle$.

5.2. Multiple choice problem

The description of restructuring for multiple choice problem is based on [81] ($t = \{\tau_1, \tau_2\}$). Basic multiple choice problem is for $t = \tau_1$ (for $t = \tau_2$ parameters $\{c_{ij}^2\}$, $\{a_{ij}^2\}$, and b^2 are used):

$$\max \sum_{i=1}^m \sum_{j=1}^{q_i} c_{ij}^1 x_{ij} \quad s.t. \quad \sum_{i=1}^m \sum_{j=1}^{q_i} a_{ij}^1 x_{ij} \leq b^1, \quad \sum_{j=1}^{q_i} x_{ij} \leq 1 \quad \forall i = \overline{1, m}, \quad x_{ij} \in \{0, 1\}.$$

Here initial element set A is divided into m subsets (without intersection): $A = \bigcup_{i=1}^m A_i$, where $A_i = \{1, \dots, j, \dots, q_i\}$ ($i = \overline{1, m}$). Thus, each element is denoted by (i, j) . An equivalent problem is:

$$\max \sum_{(i,j) \in S^1} c_{ij}^1 \quad s.t. \quad \sum_{(i,j) \in S^1} a_{ij}^1 \leq b^1, \quad |S^1 \cap A_i| \leq 1 \quad \forall i = \overline{1, m}.$$

For $t = \tau_2$ the problem is the same.

Illustrative numerical example: $A = \{1, 2, 3, 4, 5, 6, 7, 8, 9, 10, 11, 12, 13\}$, $A_1 = \{1, 3, 5, 12\}$, $A_2 = \{2, 7, 9\}$, $A_3 = \{4, 8, 13\}$, $A_4 = \{6, 10, 11\}$, $S^1 = \{1, 7, 8, 11\}$, $S^2 = \{3, 7, 8, 10\}$, $S^* = \{1, 2, 8, 6\}$. The change (restructuring) process (i.e., $S^1 \Rightarrow S^*$) is based on the following (Fig. 6): (a) deleted elements: $S^{1*-} = S^1 \setminus S^* = \{7, 11\}$, (b) added elements: $S^{1*+} = S^* \setminus S^1 = \{2, 6\}$.

Further, the restructuring problem can be considered as the following:

$$\min \rho(S^*, S^2)$$

$$s.t. \quad H(S^1 \Rightarrow S^*) = \left(\sum_{(i,j) \in S^{1*-}} h_{ij}^- + \sum_{(i,j) \in S^{1*+}} h_{ij}^+ \right) \leq \hat{h}, \quad \sum_{(i,j) \in S^*} a_{ij}^2 \leq b^2, \quad |S^* \cap A_i| \leq 1 \quad \forall i = \overline{1, m}.$$

where \hat{h} is a constraint for the change cost, $h^-(ij)$ is a cost of deletion of element $(i, j) \in A$, and $h^+(ij)$ is a cost of addition of element $(i, j) \in A$. An equivalent problem is:

$$\max \sum_{(i,j) \in S^*} c_{ij}^2$$

$$s.t. \quad H(S^1 \Rightarrow S^*) = \left(\sum_{(i,j) \in S^{1*-}} h_{ij}^- + \sum_{(i,j) \in S^{1*+}} h_{ij}^+ \right) \leq \hat{h}, \quad \sum_{(i,j) \in S^*} a_{ij}^2 \leq b^2, \quad |S^* \cap A_i| \leq 12 \quad \forall i = \overline{1, m}.$$

In the case of multicriteria multiple choice problem, the restructuring process is the same (i.e., selection of deletion and addition operations). Thus, the restructuring problem can be examined as multicriteria multiple choice problem. Analogical situation exists in the case of the usage of ordinal or multiset-based estimates. Here, the corresponding restructuring multiple choice problem is based on multi-sate estimates (as in [82,86]).

Further, a realistic applied example for configuration of modular system is examined (from [81]).

Applied example. Reconfiguration of “microelectronic components part” in wireless sensor (multiple choice problem) $M = R \star P \star D \star Q$ [90]:

1. Radio R : 10 mw 916 MHz Radio $R_1(3)$, 1 mw 916 MHz Radio $R_2(2)$, 10 mw 600 MHz Radio $R_3(2)$, 1 mw 600 MHz Radio $R_4(1)$.

2. Microprocessor P : MAXQ 2000 $P_1(1)$, AVR with embedded DAC/ ADC $P_2(2)$, MSP $P_3(3)$.

3. DAC/ADC D : Motorola $D_1(2)$, AVR embedded DAC/ADC $D_2(1)$, Analog Devices 1407 $D_3(2)$.

4. Memory Q : 512 byte RAM $Q_1(3)$, 512 byte EEPROM $Q_2(3)$, 8 KByte Flash $Q_3(2)$, 1 MByte Flash $Q_4(1)$.

Here it is assumed that solutions are based on multiple choice problem (in [90] the solving process was based on morphological clique problem while taking into account compatibility of selected DAs). Thus, two solutions M^1 (for $t = \tau_1$, Fig. 19) and M^2 (for $t = \tau_2$, Fig. 20) are examined (in [90] the solutions correspond to trajectory design: stage 1 and stage 3). Table 4 contains estimates of DAs (expert judgment). Estimates of cost (Table 4) and priorities (Fig. 19, Fig. 20, in parentheses) correspond to examples in [90]. Here $c_{ij} = 4 - p_{ij}$. Two possible change operations can be considered ($M^1 \Rightarrow M^*$, M^* is close to M^2):

(a) $R_4 \rightarrow R_2$, $h_a^- = 2$, $h_a^+ = 1$ (corresponding Boolean variable $x_a \in \{0, 1\}$),

(b) $Q_4 \rightarrow Q_1$, $h_b^- = 1$, $h_b^+ = 1$ (corresponding Boolean variable $x_b \in \{0, 1\}$).

As a result, the following simplified knapsack problem can be used:

$$\max ((c^2(R_2) - c^2(R_4)) x_a + (c^2(Q_1) - c^2(Q_4)) x_b)$$

$$s.t. H(M^* \rightarrow M^2) = (h^-(R_4 \rightarrow R_2) + h^+(R_4 \rightarrow R_2)) x_a + (h^-(Q_4 \rightarrow Q_1) + h^+(Q_4 \rightarrow Q_1)) x_b \leq \hat{h}.$$

Finally, the restructuring solutions are: (i) $\hat{h} = 2$: $M^{*1} = R_4 \star P_2 \star D_2 \star Q_1$, (ii) $\hat{h} = 3$: $M^{*2} = R_2 \star P_2 \star D_2 \star Q_4$, (iii) $\hat{h} = 5$: $M^{*3} = M^2 = R_2 \star P_2 \star D_2 \star Q_1$. Evidently, real restructuring problems can be more complicated.

Table 4. Estimates of DAs

DAs	Cost (a_{ij})	Change costs: \bar{h}_{ij} \underline{h}_{ij}		Priorities: c_{ij}^1 c_{ij}^2
R_1	6	2	2	1 1
R_2	5	1	1	2 3
R_3	3	2	1	2 1
R_4	2	2	2	3 2
P_1	5	2	3	3 2
P_2	10	2	2	2 3
P_3	30	3	2	1 2
D_1	2	2	3	2 3
D_2	1	2	2	3 2
D_3	2	1	1	2 1
Q_1	3	2	1	1 3
Q_2	2	2	2	1 3
Q_3	3	1	2	2 2
Q_4	3	1	1	3 2

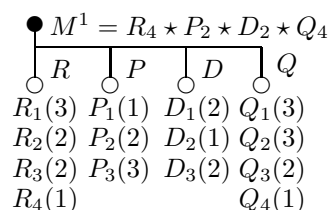

Fig. 19. Structure of M^1

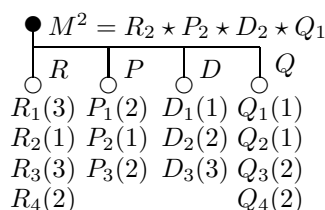

Fig. 20. Structure of M^2

5.3. Assignment problem

The description of restructuring for assignment problem is based on [81] ($t = \{\tau_1, \tau_2\}$). The simplest version of algebraic assignment problem is:

$$\max \sum_{i=1}^m \sum_{j=1}^n c_{i,j}^1 x_{i,j} \quad s.t. \sum_{i=1}^m x_{i,j} \leq 1, j = \overline{1, n}; \sum_{j=1}^n x_{i,j} \leq 1, i = \overline{1, m}; x_{i,j} \in \{0, 1\}.$$

This problem is polynomially solvable. Let us consider $n = m$. In this case, a solution can be considered as a permutation of elements $A = \{1, \dots, i, \dots, n\}$: $S = \langle s[1], \dots, s[i], \dots, s[n] \rangle$, where $s[i]$ defines the position of element i in the resultant permutation S . Let $c(i, s[i]) \geq 0$ ($i = \overline{1, n}$) be a “profit” of assignment of element i into position $s[i]$ (i.e., $\|c(i, s[i])\|$ is a “profit” matrix).

The combinatorial formulation of assignment problem is:

$$\text{Find permutation } S \text{ such that } \sum_{i=1}^n c(i, s[i]) \rightarrow \max.$$

Now let us consider three solutions (permutations):

- (a) $S^1 = \langle s^1[1], \dots, s^1[i], \dots, s^1[n] \rangle$ for $t = \tau_1$,
- (b) $S^2 = \langle s^2[1], \dots, s^2[i], \dots, s^2[n] \rangle$ for $t = \tau_2$, and
- (c) $S^* = \langle s^*[1], \dots, s^*[i], \dots, s^*[n] \rangle$ (the restructured solution).

Illustrative numerical example: $A = \{1, 2, 3, 4, 5, 6, 7\}$,
 $S^1 = \{2, 4, 5, 1, 3, 7, 6\}$, $S^2 = \{4, 1, 3, 7, 5, 2, 6\}$, $S^* = \{2, 4, 3, 1, 5, 7, 6\}$.

Here the following changes are made in S^1 : $5 \rightarrow 3$, $3 \rightarrow 5$. Clearly, the changes can be based on typical exchange operations: *2-exchange*, *3-exchange*, etc.

Further, let us consider a vector of structural difference (by components) for two permutations S^α and S^β : $\{s^\alpha[i] - s^\beta[i], i = \overline{1, n}\}$ and a change cost matrix $\|d(i, j)\|$ ($i = \overline{1, n}, j = \overline{1, n}$). Here $d(i, i) = 0 \quad \forall i = \overline{1, n}$. Evidently, the cost for restructuring solution S^1 into solution S^* is: $H(S^1 \rightarrow S^*) = \sum_{i=1}^n h(s^1[i], s^*[i])$. Proximity (by ‘‘profit’’) for two permutations S^α and S^β may be considered as follows: $\rho(S^\alpha, S^\beta) = |\sum_{i=1}^n c^\alpha(i, s^\alpha[i]) - \sum_{i=1}^n c^\beta(i, s^\beta[i])|$. Finally, the restructuring of assignment is (a simple version):

$$\min \rho(S^*, S^2) \quad s.t. \quad H(S^1 \rightarrow S^*) = \sum_{i=1}^n h(s^1[i], s^*[i]) \leq \hat{h}.$$

In the case of multicriteria assignment problem, the restructuring process is the same. Thus, the presented restructuring of assignment can be examined as well (multicriteria case).

Example of reassignment of users to access points [80,81,91]. Here the initial multicriteria assignment problem involves 21 users and 6 access points. Table 5 and Table 6 contain some parameters for users (A) (coordinates (x_i, y_i, z_i) , required frequency spectrum f_j , required level of reliability r_j , etc.) and some parameters for 6 access points ($B = \{j\} = \{1, 2, 3, 4, 5, 6\}$) (coordinates (x_j, y_j, z_j) , frequency spectrum f_j , number of connections n_j , level of reliability r_j) ([80], [91]).

Table 5. Access points

j	x_j	y_j	z_j	f_j	n_j	r_j
1	50	157	10	30	4	10
2	72	102	10	42	6	10
3	45	52	10	45	10	10
4	150	165	10	30	5	15
5	140	112	10	32	5	8
6	147	47	10	30	5	15

Table 6. Users

i	x_i	y_i	z_i	f_j	r_j
1	30	165	5	10	5
2	58	174	5	5	9
3	95	156	0	6	6
4	52	134	5	6	8
5	85	134	3	6	7
6	27	109	7	8	5
7	55	105	2	7	10
8	98	89	3	10	10
9	25	65	2	7	5
10	52	81	1	10	8
11	65	25	7	6	9
12	93	39	1	10	10
13	172	26	2	10	7
14	110	169	5	7	5
15	145	181	3	5	4
16	150	150	5	7	4
17	120	140	6	4	6
18	150	136	3	6	7
19	135	59	4	13	4
20	147	79	5	7	16
21	127	95	5	7	5

A simplified version of assignment problem from [80] is considered. Two regions are examined: an initial region and an additional region (Fig. 21). In [80] the problem was solved for two cases: (i) separated assignment S^1 (Fig. 21), (ii) joint assignment S^2 (Fig. 22).

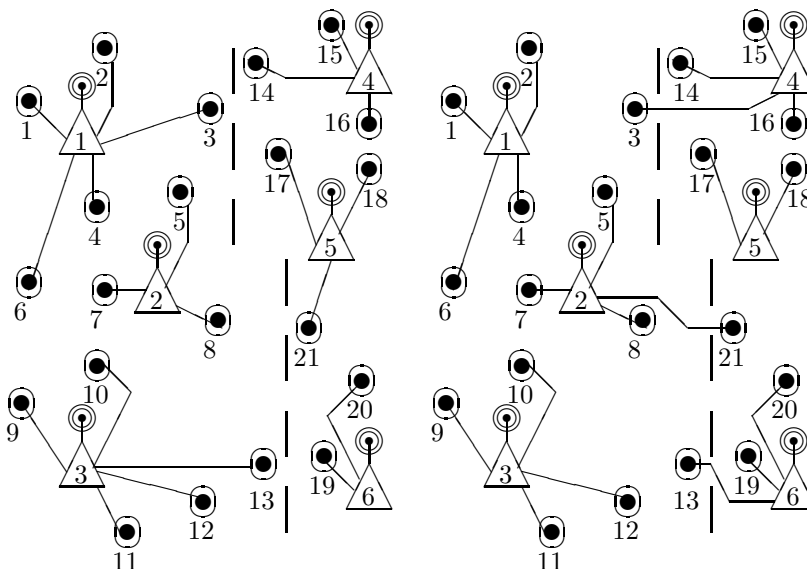
Fig. 21. Separated assignment S^1 Fig. 22. Joint assignment S^2

The restructured problem is considered as a modification (change) of S^1 into S^* . To reduce the problem it is reasonable to select a subset of users (a “change zone” near borders between regions): $\tilde{A} = \{i\} = \{3, 5, 8, 12, 13, 14, 17, 19, 21\}$. Thus, it is necessary to assign each element of \tilde{A} into an access point of B .

The considered simplified restructuring problem is based on set of change operations: (1) user 3, change of connection: $1 \rightarrow 4$ (Boolean variable x_1), (2) user 13, change of connection: $3 \rightarrow 6$ (Boolean variable x_2), (3) user 21, change of connection: $5 \rightarrow 2$ (Boolean variable x_3). Table 7 contains estimates of change costs (expert judgment) and “integrated profits” of correspondence between users and access points from ([80,91]).

The problem is:

$$\max (c_{3,4} x_1 + c_{13,6} x_2 + c_{21,2} x_3)$$

$$s.t. ((h_{3,1}^- + h_{3,4}^+) x_1 + (h_{13,3}^- + h_{13,6}^+) x_2 + (h_{21,5}^- + h_{21,2}^+) x_3) \leq \hat{h}.$$

The reassignment S^* is depicted in Fig. 23 (i.e., $x_1 = 0, x_2 = 1, x_3 = 1, \hat{h} = 5$).

Table 7. User i - access points j : $h_{ij}^-, h_{ij}^+, c_{ij}$,

i	Access point j :	1	2	3	4	5	6
3		3, 2, 2	2, 1, 3	1, 0, 3	3, 1, 3	2, 1, 0	1, 1, 0
5		2, 1, 1	1, 3, 1	1, 2, 1	3, 2, 1	1, 1, 1	1, 1, 1
8		1, 1, 3	1, 1, 3	1, 1, 3	1, 1, 0	1, 1, 3	2, 2, 2
12		2, 2, 3	1, 2, 3	1, 2, 3	3, 1, 0	2, 1, 0	1, 1, 0
13		1, 1, 3	1, 1, 3	1, 1, 3	2, 1, 0	2, 2, 1	1, 1, 3
14		1, 1, 1	2, 2, 2	1, 2, 0	1, 1, 1	1, 1, 1	1, 1, 0
17		1, 1, 2	1, 1, 1	1, 0, 1	3, 1, 1	1, 1, 1	1, 1, 1
19		1, 1, 0	1, 1, 3	1, 2, 3	3, 2, 0	1, 1, 3	1, 1, 2
21		1, 1, 0	1, 2, 3	1, 1, 2	3, 1, 1	1, 1, 1	1, 1, 1

extended group of researchers (including applications in R&D and engineering, educational technology)
 $R_5 = R_1 \& R_2 \& R_3$;

1.3. Engineer-programmer E : none E_1 , engineer E_2 , group of engineers E_3 , extended group of engineers (including specialist in Web-design) E_4 ;

1.4. Specialist in marketing M : none M_1 , the 1st specialist M_2 . the 2nd specialist M_3 . group of specialists $M_4 = M_2 \& M_3$.

Initial system structure for τ_0 is depicted in Fig. 24 (including ordinal priorities of DAs), system structure for τ_1 is depicted in Fig. 25 (including ordinal priorities of DAs), ordinal compatibility estimates for τ_0 are shown in Table 8, ordinal compatibility estimates for τ_1 are shown in Table 9.

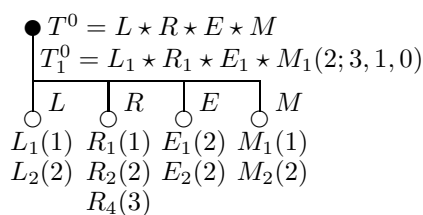

Fig. 24. Team structure (τ_0)

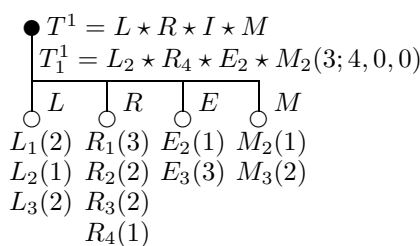

Fig. 25. Team structure (τ_1)

Optimal solutions are the following:

(a) for τ_0 : $T_1^0 = L_1 \star R_1 \star E_1 \star M_1$, $N(T_1^0) = (2; 3, 1, 0)$,

(b) for τ_1 : $T_1^1 = L_2 \star R_4 \star E_2 \star M_2$, $N(T_1^1) = (3; 4, 0, 0)$.

Here, the restructuring problem is considered as one-stage restructuring:

Find a solution T^* while taking into account the following:

(i) $H(T^0 \rightarrow T^*) \rightarrow \min$, (ii) $\rho(T^*, T^1) \rightarrow \min$.

It is assumed the following (for simplification):

(a) transformation cost $H(T^0 \rightarrow T^*)$ equals the number of change operations (by DAs);

(b) proximity $\rho(T^*, T^1)$ equals a two-component vector (ρ_1, ρ_2) (e.g., [77]): ρ_1 is the number of improvement steps by elements, ρ_2 is the number of improvement steps by compatibility.

Two restructuring solutions are considered (evaluation of solution quality $N(T)$ is calculated for τ_1):

(i) $T_1^{*1} = L_1 \star R_3 \star E_2 \star M_2$, $N(T_1^{*1}) = (1; 2, 2, 0)$, $H(T^0 \rightarrow T_1^{*1}) = 2$, $\rho(T_1^{*1}, T^1) = (2, 2)$;

(ii) $T_2^{*1} = L_1 \star R_1 \star E_2 \star M_2$, $N(T_2^{*1}) = (2; 2, 1, 1)$, $H(T^0 \rightarrow T_2^{*1}) = 2$, $\rho(T_2^{*1}, T^1) = (3, 1)$.

Further, additional stage is examined for τ_2 (Fig. 26, Table 10) and two-stage restructuring problem is considered for time moments: $\{\tau_0, \tau_1, \tau_2\}$. *Scheme 3* (composition & selection solving process) above is used for the designing the solution trajectory.

First, new combinatorial synthesis problem has to be solved for τ_2 (Fig. 26, Table 10).

The solution is (Fig. 26): $T_1^2 = L_3 \star R_5 \star E_4 \star M_4$, $N(T_1^2) = (3; 4, 0, 0)$.

Second, the restructuring problem is examined (the second stage) for two initial solutions (i.e., for τ_1): $T_1^{*1} = L_1 \star R_3 \star E_2 \star M_2$, and $T_2^{*1} = L_1 \star R_1 \star E_2 \star M_2$. This restructuring problem is considered as one-stage restructuring for the second stage (for two solutions T_1^{*1}, T_2^{*1}):

Find a solution T^{2*} while taking into account the following ($i = 1, 2$):

(i) $H(T_i^{*1} \rightarrow T_1^2) \rightarrow \min$, (ii) $\rho(T_1^2, T_i^{*1}) \rightarrow \min$.

As a result, the following restructuring solutions considered (for τ_2):

(i) for T_1^{*1} : $T_1^{*2} = L_3 \star R_3 \star E_2 \star M_4$, $N(T_1^{*2}) = (2; 2, 2, 0)$, $H(T_1^{*1} \rightarrow T_1^{*2}) = 2$, $\rho(T_1^{*2}, T^2) = (2, 1)$;

(ii) for T_2^{*1} : $T_2^{*2} = L_3 \star R_5 \star E_4 \star M_3$, $N(T_2^{*2}) = (1; 3, 1, 0)$, $H(T_2^{*1} \rightarrow T_2^{*2}) = 4$, $\rho(T_2^{*2}, T^2) = (1, 2)$.

Third, composition of solution trajectories. The alternative trajectories are: $S_1^{rest} = \langle T^0, T_1^{*1}, T_1^{*2} \rangle$ and $S_2^{rest} = \langle T^0, T_2^{*1}, T_2^{*2} \rangle$. Estimates (i.e., integrated estimate of proximity and integrated estimate of transformation cost) of the trajectories are:

- (a) $\tilde{H}(S_1^{rest}) = 4, \tilde{\rho}(S_1^{rest}) = (4, 3);$
 (b) $\tilde{H}(S_2^{rest}) = 6, \tilde{\rho}(S_2^{rest}) = (4, 3).$

Table 8. Compatibility estimates (τ_0)

	R_1	R_2	R_4	E_1	E_2	M_1	M_2
L_1	2	2	1	3	2	3	1
L_2	2	2	2	2	2	2	2
R_1				3	3	3	1
R_2				1	2	2	1
R_4				1	2	3	3
E_1						3	1
E_2						1	2

Table 9. Compatibility estimates (τ_1)

	R_1	R_2	R_3	R_4	E_2	E_3	M_2	M_3
L_1	3	2	2	2	2	3	2	2
L_2	1	3	2	3	3	3	3	2
L_3	2	2	2	2	2	2	2	2
R_1					3	2	2	2
R_2					3	2	3	2
R_3					1	3	3	3
R_4					3	3	3	3
E_2							3	2
E_3							2	2

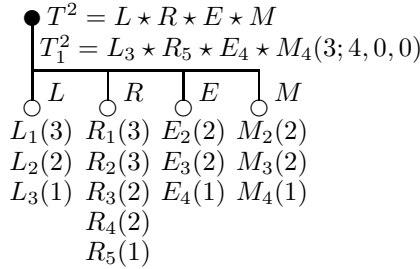
Fig. 26. Team structure (τ_2)**Table 10.** Compatibility estimates (τ_2)

	R_1	R_2	R_3	R_4	R_5	E_2	E_3	E_4	M_2	M_3	M_4
L_1	3	0	2	2	1	3	3	2	3	2	2
L_2	0	3	2	2	1	3	2	2	3	2	2
L_3	0	2	2	3	3	2	2	3	2	1	3
R_1						3	2	2	3	2	2
R_2						1	3	2	2	3	2
R_3						2	3	2	2	3	2
R_4						1	3	3	2	3	3
R_5						1	2	3	1	2	3
E_2									3	2	2
E_3									2	3	1
E_4									1	2	3

Fourth, the best solution restructuring trajectory is (selected by Pareto rule) (Fig. 27):

$$S_1^{rest} = \langle T_1^0, T_1^{*1}, T_1^{*2} \rangle.$$

Table 11 contains ordinal estimates of compatibility (expert judgment) between DAs for the composite system at time stages. The final Pareto-efficient system trajectory is (hierarchical combinatorial synthesis) (Fig. 27): $\alpha = \langle S_1^1, S_1^2, S_1^3 \rangle.$

Table 11. Local (one-stage) estimates

	S_1^2	S_2^2	S_1^3	S_2^3
S_1^1	3	0	3	0
S_1^2			3	2
S_2^2			3	3

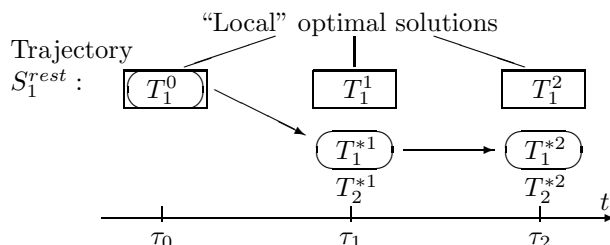

Fig. 27. Illustration of restructuring trajectory

5.5. Restructuring in clustering

Now, one-stage and multi-stage restructuring for clustering/classification is described (based on [87]). The one-stage restructuring process in clustering problem is depicted in Fig. 28.

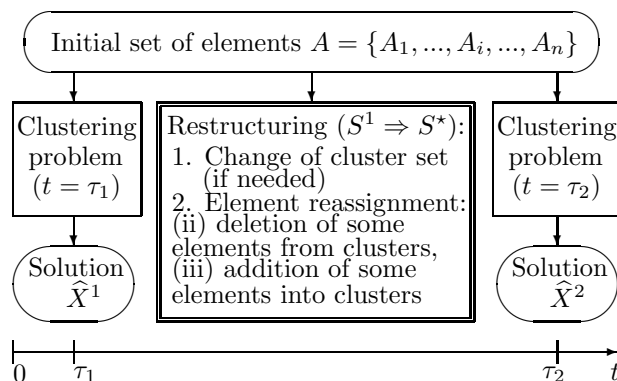

Fig. 28. Restructuring in clustering problem

Example for restructuring in clustering. Initial information involves the following:

- (i) set of elements $A = \{1, 2, 3, 4, 5, 6, 7, 8, 9\}$;
- (ii) initial solution 1 ($t = \tau_1$): $\hat{X}^1 = \{X_1^1, X_2^1, X_3^1\}$, clusters $X_1^1 = \{1, 3, 8\}$, $X_2^1 = \{2, 4, 7\}$, $X_3^1 = \{5, 6, 9\}$;
- (iii) solution 2 ($t = \tau_2$): $\hat{X}^2 = \{X_1^2, X_2^2, X_3^2\}$, clusters $X_1^2 = \{2, 3\}$, $X_2^2 = \{5, 7, 8\}$, $X_3^2 = \{1, 4, 6, 9\}$;
- (v) general set of considered possible change operations (each element can be replaced, the number of solution clusters is not changed):

O_{11} : none, O_{12} : deletion of element 1 from cluster X^1 , addition of element 1 into cluster X^2 , O_{13} : deletion of element 1 from cluster X^1 , addition of element 1 into cluster X^3 ;

O_{21} : none, O_{22} : deletion of element 2 from cluster X^2 , addition of element 2 into cluster X^1 , O_{23} : deletion of element 2 from cluster X^2 , addition of element 2 into cluster X^3 ;

O_{31} : none, O_{32} : deletion of element 3 from cluster X^1 , addition of element 3 into cluster X^2 ; O_{33} : deletion of element 3 from cluster X^1 , addition of element 3 into cluster X^3 ;

O_{41} : none, O_{42} : deletion of element 4 from cluster X^2 , addition of element 4 into cluster X^1 , O_{43} : deletion of element 4 from cluster X^2 , addition of element 4 into cluster X^3 ;

O_{51} : none, O_{52} : deletion of element 5 from cluster X^3 , addition of element 5 into cluster X^1 , O_{53} : deletion of element 5 from cluster X^3 , addition of element 5 into cluster X^2 ;

O_{61} : none, O_{62} : deletion of element 6 from cluster X^3 , addition of element 6 into cluster X^1 , O_{63} : deletion of element 6 from cluster X^3 , addition of element 6 into cluster X^2 ;

O_{71} : none, O_{72} : deletion of element 7 from cluster X^2 , addition of element 7 into cluster X^1 , O_{73} : deletion of element 7 from cluster X^2 , addition of element 7 into cluster X^3 ;

O_{81} : none, O_{82} : deletion of element 8 from cluster X^1 , addition of element 8 into cluster X^2 , O_{83} : deletion of element 8 from cluster X^1 , addition of element 8 into cluster X^3 ;

O_{91} : none, O_{92} : deletion of element 9 from cluster X^3 , addition of element 9 into cluster X^1 , O_{93} : deletion of element 9 from cluster X^3 , addition of element 9 into cluster X^2 .

In this case, optimization model (multiple choice problem) is:

$$\max \sum_{i=1}^n \sum_{j=1}^3 c(O_{ij})x_{ij} \quad s.t. \quad \sum_{i=1}^n \sum_{j=1}^3 a(O_{ij})x_{ij} \leq b, \quad x_{ij} \in \{0, 1\},$$

where $a(O_{ij})$ is the cost of operation O_{ij} , $c(O_{ij})$ is a ‘‘local’’ profit of operation O_{ij} as influence on closeness of obtained solution X^* to clustering solution X^2 . Generally, it is necessary to examine quality parameters of clustering solution as basis for objective function(s).

Evidently, the compressed set of change operations can be analyzed:

O_1 : deletion of element 1 from cluster X^1 , addition of element 1 into cluster X^3 ;

O_2 : deletion of element 2 from cluster X^2 , addition of element 2 into cluster X^1 ;

O_3 : deletion of element 4 from cluster X^2 , addition of element 4 into cluster X^3 ;

O_4 : deletion of element 5 from cluster X^3 , addition of element 5 into cluster X^2 ;

O_5 : deletion of element 8 from cluster X^1 , addition of element 8 into cluster X^2 .

In this case, optimization model is knapsack problem:

$$\max \sum_{j=1}^9 c(O_j)x_j \quad s.t. \quad \sum_{j=1}^9 a(O_j)x_j \leq b, \quad x_j \in \{0, 1\},$$

where $a(O_j)$ is the cost of operation O_j , $c(O_j)$ is a ‘‘local’’ profit of operation O_j as influence on closeness of obtained solution X^* to clustering solution X^2 .

Finally, let us point out an illustrative example of clustering solution (Fig. 29):

$\hat{X}^* \{X_1^*, X_2^*, X_3^*\}$, clusters $X_1^* = \{1, 2, 3\}$, $X_2^* = \{7, 8\}$, $X_3^* = \{4, 5, 6, 9\}$.

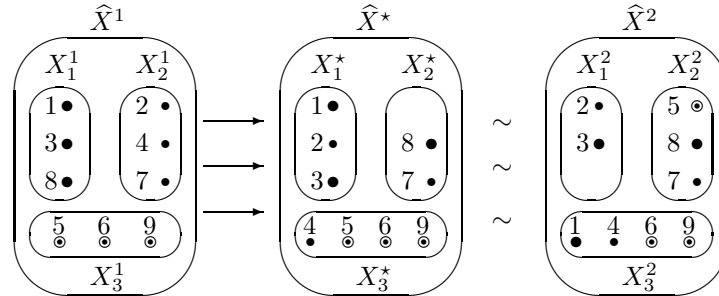

Fig. 29. Example: restructuring of clustering solution

Fig. 30 and Fig. 31 illustrate multistage classification and multistage clustering problems:

1. Multistage classification (Fig. 30): the same set of classes at each time stage (here: four classes L^1 , L^2 , L^3 , L^4), elements can belong to different classes at each stage. Here: elements 1, 2, 3; trajectory for element 1: $J(1) = \langle L^1, L^1, L^1 \rangle$, trajectory for element 2: $J(2) = \langle L^2, L^1, L^2 \rangle$, trajectory for element 3: $J(3) = \langle L^3, L^4, L^3 \rangle$.

2. Multistage clustering (Fig. 31): different set of clusters at each time stage can be examined, elements can belong to different clusters at each stage. Here: elements 1, 2, 3; trajectory for element 1: $J(1) = \langle L_1^1, L_2^1, L_3^1 \rangle$, trajectory for element 2: $J(2) = \langle L_1^2, L_2^1, L_3^2 \rangle$, trajectory for element 3: $J(3) = \langle L_1^3, L_2^4, L_3^5 \rangle$.

In this problem, it is necessary to examine a set of change trajectories for each element. As a result, multi-stage restructuring problem has to be based on multiple choice model. Generally, this problem is very prospective.

This kind of clustering (or classification) model/problem is close to multistage system design [53,67, 84,85,86].

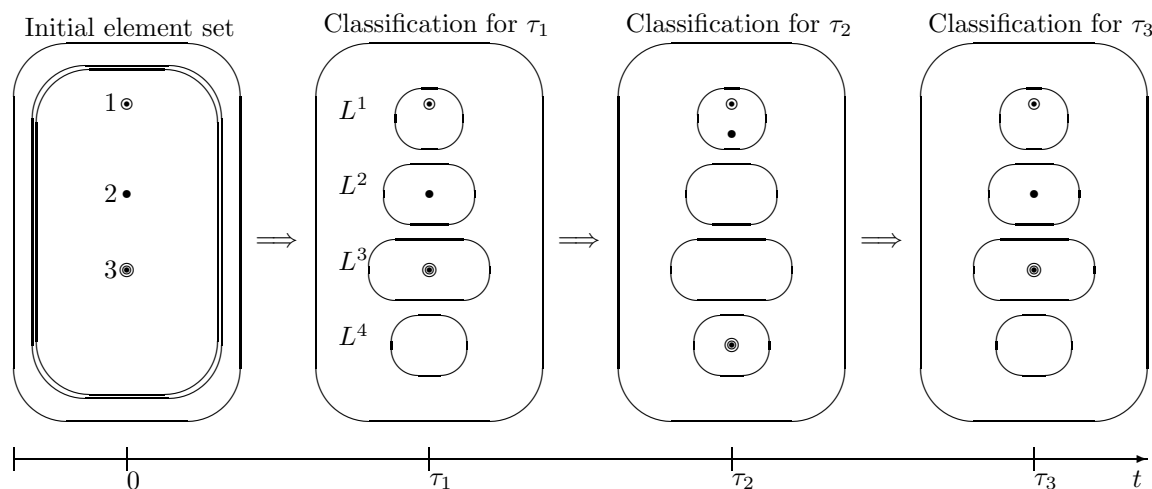

Fig. 30. Illustration of multistage classification

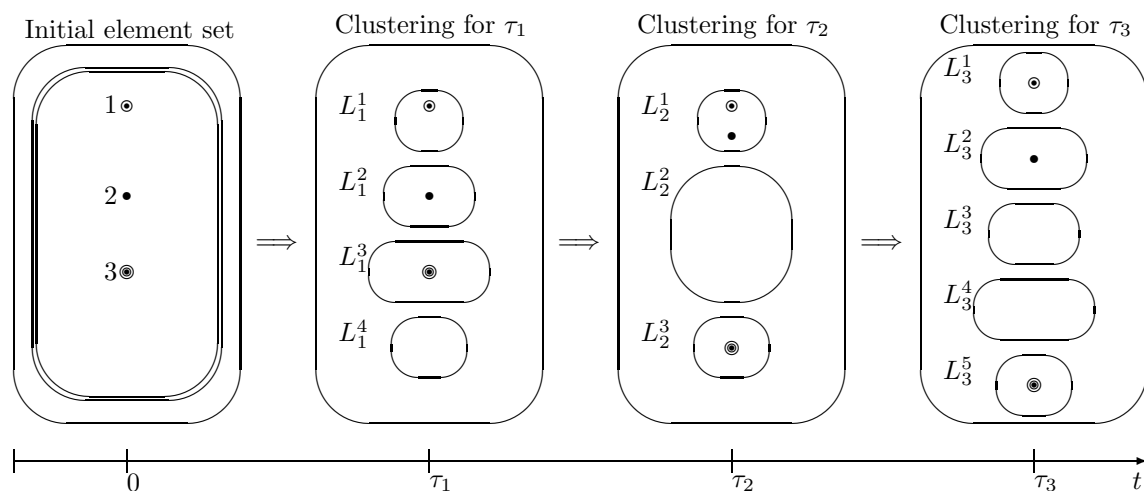

Fig. 31. Illustration of multistage clustering

5.6. Restructuring in sorting

One-stage restructuring for sorting problem can be considered as well. Let $A = \{A_1, \dots, A_i, \dots, A_n\}$ be an initial element set. Solution is a result of dividing set $\{A\}$ into k linear ordered subsets (ranking): $\widehat{R} = \{R_1, \dots, R_j, \dots, R_k\}$, $R_j \subseteq A \forall j = \overline{1, k}$, $|R_{j_1} \cap R_{j_2}| = 0 \forall j_1, j_2$. Linear order is: $R_1 \rightarrow \dots \rightarrow R_j \rightarrow \dots \rightarrow R_k$, $A_{i_1} \rightarrow A_{i_2}$ if $A_{i_1} \in R_{j_1}$, $A_{i_2} \in R_{j_2}$, $j_1 < j_2$.

Generally, the sorting problem (or multicriteria ranking) consists in transformation of set A into ranking R : $A \Rightarrow R$ while taking into account multicriteria estimates of elements and/or expert judgment (e.g., [122,146]). In Fig. 32, illustration for restructuring in sorting problem is depicted. The problem is:

$$\min \delta(\widehat{R}^2, \widehat{R}^*) \quad s.t. \quad a(\widehat{R}^1 \rightarrow \widehat{R}^*) < b,$$

where \widehat{R}^* is solution, \widehat{R}^1 is initial (the “first”) ranking, \widehat{R}^2 is the “second” ranking, $\delta(\widehat{R}^*, \widehat{R}^2)$ is proximity between solution \widehat{R}^* and the “second” ranking \widehat{R}^2 (e.g., structural proximity or proximity by quality parameters for rankings), $a(\widehat{R}^1 \rightarrow \widehat{R}^*)$ is the cost of transformation of the “first” ranking \widehat{R}^1 into solution \widehat{R}^* (e.g., editing “distance”), b is constraint for the transformation cost. Evidently, multi-stage restructuring problems (with change trajectories of elements) are prospective as well.

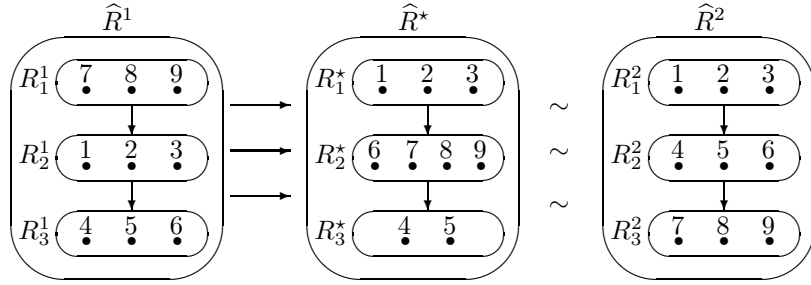

Fig. 32. Example: restructuring in sorting problem

5.7. Spanning trees problems

Let us present the restructuring approach for basic spanning trees problems from [81]. Restructuring problems for minimal spanning tree problem and for Steiner tree problem are described as follows (Fig. 33, Fig. 34). The following numerical examples are presented:

I. Initial graph (Fig. 33): $G = (A, E)$, where $A = \{1, 2, 3, 4, 5, 6, 7\}$,
 $E = \{(1, 2), (1, 4), (1, 5), (1, 6), (2, 3), (2, 6), (3, 6), (4, 5), (4, 6), (5, 6), (5, 7), (6, 7)\}$.

II. Spanning trees (Fig. 33):

(i) $T^1 = (A, E^1)$, where $E^1 = \{(1, 2), (1, 4), (1, 6), (3, 5), (5, 6), (6, 7)\}$,

(ii) $T^2 = (A, E^2)$, where $E^2 = \{(1, 2), (2, 3), (2, 6), (4, 6), (5, 6), (6, 7)\}$,

(iii) $T^* = (A, E^*)$, where $E^* = \{(1, 2), (1, 4), (2, 3), (2, 6), (3, 5), (6, 7)\}$.

Here the edge changes are ($T^1 \rightarrow T^*$ as $E^1 \rightarrow E^*$):

$E^{1*-} = \{(1, 6), (5, 6)\}$ and $E^{1*+} = \{(2, 3), (2, 6)\}$.

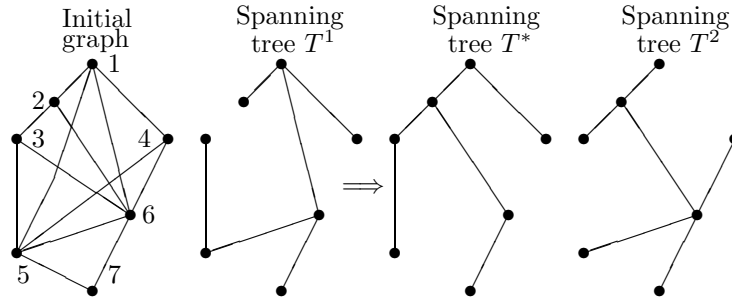

Fig. 33. Restructuring of spanning tree

III. Steiner trees (Fig. 34, set of possible Steiner vertices is $Z = \{a, b, c, d\}$):

(i) $S^1 = (A^1, E^1)$, where $A^1 = A \cup Z^1$, $Z^1 = \{a, b\}$,

$E^1 = \{(1, 2), (1, a), (a, 4), (a, 6), (3, 5), (b, 5), (b, 6), (b, 7)\}$,

(ii) $S^2 = (A^2, E^2)$, where $A^2 = A \cup Z^2$, $Z^2 = \{a, b, d\}$,

$E^2 = \{(3, 4), (1, d), (3, d), (a, d), (a, 4), (a, 6), (b, 6), (b, 5), (b, 7)\}$,

(iii) $S^* = (A^*, E^*)$, where $A^* = A \cup Z^*$, $Z^* = \{a, c\}$,

$E^* = \{(1, 2), (1, a), (a, 4), (a, 6), (c, 3), (c, 5), (c, 6), (6, 7)\}$.

Thus, the restructuring problem for spanning tree is (Fig. 33, a simple version):

$$\min \rho(T^*, T^2) \quad s.t. \quad H(S^1 \Rightarrow S^*) = \left(\sum_{i \in E^{1*-}} h_i^- + \sum_{i \in E^{1*+}} h_i^+ \right) \leq \hat{h},$$

where \hat{h} is a constraint for the change cost, $h^-(i)$ is a cost of deletion of element (i.e., edge) $i \in E^1$, and $h^+(i)$ is a cost of addition of element (i.e., edge) $i \in E \setminus E^1$.

The restructuring problem for Steiner tree is (Fig. 34, a simple version):

$$\min \rho(S^*, S^2)$$

$$s.t. \quad H(S^1 \Rightarrow S^*) = \left(\sum_{i \in E^{1*-}} h_i^- + \sum_{i \in E^{1*+}} h_i^+ \right) + \left(\sum_{i \in Z^{1*-}} w_i^- + \sum_{i \in Z^{1*+}} w_i^+ \right) \leq \hat{h},$$

where \widehat{h} is a constraint for the change cost, $h^-(i)$ is a cost of deletion of element (i.e., edge) $i \in E^1$, $h^+(i)$ is a cost of addition of element (i.e., edge) $i \in \widehat{E}^* \subseteq E \setminus E^1$, $w^-(j)$ is a cost of deletion of Steiner vertex $j \in Z^1$, $w^+(j)$ is a cost of addition of Steiner vertex $j \in \widehat{Z}^* \subseteq Z \setminus Z^1$.

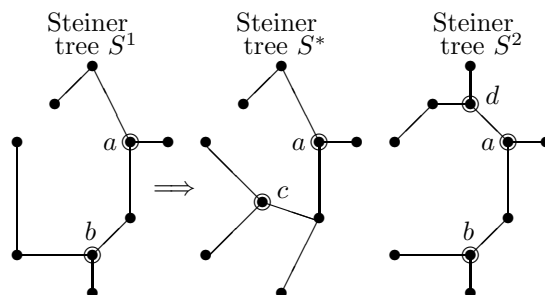

Fig. 34. Restructuring of Steiner tree

6. Conclusion

In the paper, a restructuring approach in combinatorial optimization is examined. The restructuring problems are formulated as the following: (i) one-stage problem formulation (one-criterion statements, multicriteria statements), (ii) multi-stage problem formulation (one-criterion statements, multicriteria statements). The suggested restructuring approach is applied for several combinatorial optimization problems (e.g., knapsack problem, multiple choice problem, assignment problem, minimum spanning tree, Steiner tree problem, clustering problem, sorting problem).

In the future, it may be prospective to consider the following research directions:

1. application of the suggested restructuring approach to other combinatorial optimization problems (e.g., covering, graph coloring);
2. examination of restructuring problems with changes of basic element sets (i.e., $A^1 \neq A^2$);
3. study and usage of various types of proximity between obtained solution(s) and goal solution(s) (i.e., $\rho(S^*, S^2)$);
4. examination of the restructuring problems under uncertainty (e.g., stochastic models, fuzzy sets based models, problems with multi-set based estimates);
5. further studies of dynamical restructuring problems including restructuring over changing set(s) (one-stage restructuring, multi-stage restructuring);
6. reformulation of restructuring problem(s) as satisfiability model(s);
7. analysis of restructuring problem(s) in case of changing the set of problem elements and/or their interconnection (i.e., while taking into account dynamical sets based methods, dynamical graph based methods);
8. usage of various AI techniques in solving procedures; and
9. application of the suggested restructuring approaches in engineering/CS/management education.

7. Acknowledgments

The research materials presented in the article were partially supported by The Russian Foundation for Basic Research, project 15-07-01241 “Reconfiguration of Solutions in Combinatorial Optimization” (principal investigator: Mark Sh. Levin).

REFERENCES

1. M.A. Adibi, M. Zandieh, M. Amiri, Multi-objective scheduling of dynamic job shop using variable neighborhood search. *ESwA* 37(1), 282–287, 2010.
2. R.M. Aiex, M.G.C. Resende, P.M. Pardalos, G. Toraldo, GRASP with path relinking for three-index assignment. *INFORMS J. on Computing* 17(2), 224–247, 2005.
3. S. Albers, Online algorithms: a survey. *Math. Program. Ser. B* 97(1-2), 3–26, 2003.
4. S. Albers, S. Leonardi, On-line algorithms. *ACM Comput. Surv.* 31(3es) (4), 1999.

5. R. Alvares-Valdes, F. Parreno, J.M. Tamarit, A GRASP/Path relinking algorithm for two- and three-dimensional bin-size bin packing problems. *Comp. and Oper. Res.* 49(12), 3081–3090, 2012.
6. E. Amaldi, G. Galbiati, F. Maffioli, On minimum reload cost paths, tours, and flows. *Networks* 57(3), 254–260, 2011.
7. P.R. Amestoy, I.S. Duff, J.Y. L'Excellent, J. Koster, A fully asynchronous multifrontal solver using distributed dynamic scheduling. *SIAM J. on Matrix Analysis and Applications* 23(1), 15–41, 2011.
8. F.M. Arain, IT-based approach for effective management of project changes: A change management system (CMS). *Advanced Engineering Informatics* 22(4), 457–472, 2008.
9. C. Archetti, L. Bertazzi, M.G. Speranza, Reoptimizing the traveling salesman problem. *Networks* 42(3), 154–159, 2003.
10. C. Archetti, L. Bertazzi, M.G. Speranza, Reoptimizing the 0-1 knapsack problem. Technical Report 267, University of Brescia, 2006.
11. C. Archetti, G. Guastaroba, M.G. Speranza, Reoptimizing the rural postman problem. *Comp. & Oper. Res.* 40(5), 1306–1313, 2013.
12. G.R. Ash, *Dynamic Routing in Telecommunications Networks*. McGraw-Hill Professional, 1997.
13. N. Ascheuer, M. Grottschel, S.O. Krumke, J. Rambau, Combinatorial online optimization. In: P. Kall, H.-J. Luthi (eds), *Operations Research Proceedings 1998*, Springer, 21–37, 1999.
14. G. Austello, B. Escoffer, J. Monnot, V. Paschos, Reoptimization of minimum and maximum traveling salesman's tours. *J. of Discr. Algorithms* 7(4), 453–463, 2009.
15. M.E. Aydin, E. Oztemel, Dynamic job-shop scheduling using reinforcement learning agents. *Robotics and Autonomous Systems* 33(2), 169–178, 2000.
16. H. Aytug, M.A. Lawley, K. McKay, S. Mohan, R. Uzsoy, Executing production schedules in the face of uncertainty: A review and some future directions. *EJOR* 161(1), 86–110, 2005.
17. O. Berman, Repositioning of distinguishable urban service units on networks. *Comp. & Oper. Res.* 8(2), 105–118, 1981.
18. Z.M. Bi, S. Lang, W. Shen, L. Wang, Reconfigurable manufacturing systems: the state of the art. *Int. J. of Production Res.* 46(4), 967–992, 2008.
19. D. Bilo, H.-J. Bockenhauer, J. Hromkovic, R. Kralovic, T. Momke, P. Widmayer, A. Zych, Reoptimization of Steiner trees. In: J. Gudmundsson (ed), *Proc. of Scandinavian Workshop on Algorithm Theory SWAT'08*, LNCS 5124, Springer, 258–269, 2008.
20. D. Bilo, P. Widmayer, A. Zych, Reoptimization of weighted graph and covering problems. In: E. Bampis, M. Skutella (eds), *Proc. of 6th Int. Workshop on Approximation and Online Algorithms WAOA'08*, LNCS 5426, Springer, 201–213, 2009.
21. D. Bilo, H.-J. Bockenhauer, D. Komm, R. Kralovic, T. Momke, S. Seibert, A. Zych, Reoptimization of the Shortest Common Superstring Problem. *Algorithmica* 61(2), 227–251, 2011.
22. H.-J. Bockenhauer, J. Hromkovic, T. Momke, P. Widmayer, On the hardness of reoptimization. In: *34th International Conf. on Current Trends in Theory and Practice of Computer Science SOFSEM*, 50–65, 2008.
23. S. Bocker, S. Briesemeister, Q.B.A. Bui, A. Truss, Going weighted: Parametrized algorithms for cluster editing. *Theor. Comp. Sci.* 410(52), 5467–5480, 2009.
24. S. Bocker, P. Damaschke, Even faster parameterized cluster deletion and cluster editing. *Information Processing Letters* 111(14), 717–721, 2011.
25. B. Bojduj, D. Taylor, F. Kurfess, Optimization of dynamic combinatorial optimization problems through truth maintenance. In: H.G. Okuno, M. Ali (eds), *New Trends in Applied Artificial Intelligence*, LNAI 4570, Springer, 984–991, 2007.
26. K. Bondalapati, V.K. Prasanna, Reconfigurable computing systems. *Proc. of the IEEE* 90(7), 1201–1217, 2002.
27. N. Boria, V.P. Paschos, Fast reoptimization for the minimum spanning tree problem. *J. of Discr. Algorithms* 8(3), 296–310, 2010.
28. A. Borodin, R. El-Yaniv, *Online Computation and Competitive Analysis*. Cambridge Univ. Press, New York, 1998.
29. P. Bose, J. Czyzowicz, L. Gasieniec, E. Kranakis, D. Krizanc, A. Pelc, M.V. Martin, Strategies for hotlink assignments. In: *Int. Symp. on Algorithms and Computation (ISAAC'00)*, LNCS 1969, Springer, 23–34, 2001.

30. L. Brot, G. Laporte, F. Semet, Ambulance location and relocation models. *EJOR* 147(3), 451–463, 2003.
31. M. Caserta, S. Schwarze, S. Voss, Container rehandling at maritime container terminals. In: J.W. Bose (ed), *Handbook of Terminal Planning*. Operations Research/Computer Science Interfaces Series 49, Springer, 247–269, 2010.
32. M. Caserta, S. Voss, M. Sniedovich Applying the corridor method to a blocks relocation problem. *OE Spektrum*, 33, 915–929, 2011.
33. M. Caserta, S. Schwarze, S. Voss, A mathematical formulation and complexity consideration for the blocks relocation problem. *EJOR* 219, 96–104, 2012.
34. B.B. Chaudhri, Dynamic clustering for time incremental data. *Pattern Recognition Letters* 13, 27–34, 1994.
35. H.-K. Chen, C.F. Hsueh, A model and an algorithm for the dynamic user-optimal route choice problem *Transportation Research Part B: Methodological* 32(3), 219–234, 1998.
36. W.P. Chen, J.C. Hou, L. Sha, Dynamic clustering for acoustic target tracking in wireless sensor networks. *IEEE Trans. on Mobile Computing* 3(3), 258–271, 2004.
37. L.K. Church, R. Uzsoy, Analysis of periodic and event-driven rescheduling policies in dynamic shops. *Int. J. of Computer-Integrated Manufacturing* 5(3), 153–163, 1992.
38. C. Coello Coello, G.B. Lamont, D.A. Van Veldhuizen, *Evolutionary Algorithms for Solving Multi-Objective Problems*. 2nd ed., Springer, 2007.
39. P. Cowling, M. Jojansson, Using real time information for effective dynamic scheduling. *EJOR* 139(2), 230–244, 2002.
40. D.C. Cox, D.O. Reudink, Increasing channel occupancy in large-scale mobile radio systems: Dynamic channel reassignment. *IEEE Trans. on Vehicular Technology* 22(4), 218–222, 1973.
41. J. Czyzowicz, E. Kranakis, D. Krizanc, A. Pelc, M.V. Martin, Evaluation of hotlink structure for improving web performance. *J. Web Eng.* 1(2), 93–127, 2003.
42. P. Damaschke, Fixed parameter enumerability of cluster editing and related problems. *Theory of Comput. Syst.* 46, 261–283, 2010.
43. F. De Carvalho, R. De Souza, M. Chavent, Y. Lechevallier, Adaptive Hausdorff distances and dynamic clustering of symbolic interval data. *Pattern Recog. Letters* 27(3), 167–179, 2006.
44. K. Deb, *Multi-Objective Optimization Using Evolutionary Algorithms*. Wiley, 2009.
45. F. Dehne, M.A. Langston, X. Luo, S. Pitre, P. Shaw, Y. Zhang, The cluster editing problem: implementations and experiments. In: H.L. Bodlaender, M.A. Langston (eds), *Proc. IWPEC 2006*, LNCS 4169, Springer, 13–24, 2006.
46. G. Dini, M. Pelagatti, I.M. Savino, An algorithm for reconnecting wireless sensor network partitions. In: *Proc. 5th Eur. Conf. on Wireless Sensor Networks EWSN 2008*, 253–267, 2008.
47. M. Ehrgott, *Multicriteria Optimization*. 2nd ed., Springer, 2010.
48. M. Ehrgott, X. Gandibleux, A survey and annotated bibliography of multiobjective combinatorial optimization. *OR-Spektrum* 22(4), 425–460, 2000.
49. B. Escoffier, M. Milanic, V.T. Paschos, Simple and fast reoptimizations for the Steiner tree problem. *Algorithmic Oper. Res.* 4(2), 86–94, 2009.
50. K.P. Eswaran, R.E. Tarjan, Augmentation problems. *SIAM J. on Computing* 5(4), 653–665, 1976.
51. C. Exposito-Izquierdo, E. Lalla-Ruiz, B. Melian-Batista, J.M. Moreno-Vega A study of rescheduling strategies for the quay crane scheduling problem under random disruptions. *Inteligencia Artificial* 17(54), 35–47, 2014.
52. H. Farria, Jr., S. Binato, M.G.C. Resende, D.M. Falcao, Power transmission network design by greedy randomized adaptive path relinking. *IEEE Trans. on Power Systems* 20(1), 43–49, 2005.
53. S. Fortunato, Community detection in graphs. Electronic preprint, 103 p., Jan. 25, 2010. <http://arxiv.org/abs/0906.0612v2> [physics.soc-ph]
54. S. Fuhrmann, S.O. Krumke, H.-C. Wirth, Multiple hotlink assignment. In: A. Brandstadt, V.B. Le (eds) *Proc. of WG 2001*, LNCS 2204, Springer, 189–200, 2001.
55. G. Galambos, G.J. Woeginger, On-line bin-packing - a restricted survey. *ZOR - Mathematical Methods of Operations Research* 42, 25–45, 1995.
56. I. Gamvros, L. Gouveira, S. Raghavan, Reload cost trees and network design. *Networks* 59(4), 365–379, 2012.

57. M.R. Garey, D.S. Johnson, *Computers and Intractability. The Guide to the Theory of NP-Completeness*. W.H. Freeman and Company, San Francisco, 1979.
58. I. Ghamlouche, T.G. Crainic, M. Gendreau, Path relinking, cycle-based neighbourhoods and capacitated multicommodity network design. *Annals of Oper. Res.* 131(1-4), 109–133, 2004.
59. F. Glover, M. Laguna, R. Marti, Fundamentals of scatter search and path relinking. *Control and Cybernetics* 39(3), 653–684, 2000.
60. D. Gozuppek, M. Shalom, A. Voloshin, S. Zaks, On the complexity of constructing minimum changeover cost arborescences. *Theoretical Computer Science* 540-541, 40–52, 2014.
61. D. Gozuppek, S. Buhari, F. Alogoz, A spectrum switching delay-aware scheduling algorithm for centralized cognitive radio networks. *IEEE Trans. Mob. Comput.* 12(7), 1270–1280, 2013.
62. C. Gunasekara, K. Mehrotra, C.K. Mohan, Multi-objective restructuring in social networks. In: *Proc. of The 2013 IEEE/ACM Int. Conf. on Advances in Social Network Analysis and Mining (ASONAM 2013)*, ACM, 277–281, 2013.
63. J. Guo, A more effective linear kernelization for cluster editing. *Theor. Comput. Sci.* 410(8-10), 718–726, 2009.
64. P. Van Hentenryck, R. Bent, *Online Stochastic Combinatorial Optimization*. The MIT Press, 2009.
65. S.C. Ho, M. Gendreau, Path relinking for the vehicle routing problem. *J. of Heuristics* 12, 55–72, 2006.
66. S.C. Ho, W.Y. Szeto, Solving a static repositioning problem in bike-sharing systems using iterated tabu search. *Transp. Res. Part E* 69, 180–198, 2014.
67. J. Hopcroft, O. Khan, B. Kulis, B. Selman, Tracking evolving communities in large linked networks. *PNAS* 101(Suppl 1), 5249–5353, 2004.
68. A.K. Jain, H.A. Elmaraghy, Production scheduling/rescheduling in flexible manufacturing. *Int. J. of Production Research* 35(1), 281–309, 1997.
69. J. Jayabharathy, S. Kanmani, Correlated concept based dynamic document clustering algorithms for newsgroups and scientific literature. *Decision Analytics* 1(3), 1-21, 2014.
70. R. Jovanovic, S. Voss, A chain heuristic for the blocks relocation problem. *Comp. and Ind. Eng.* 75, 79–86, 2014.
71. M.R. Khouadjia, B. Sarasola, E. Alba, L. Jourdan, E.G. Talbi, A comparative study between dynamic adapted pso and vns for the vehicle routing problem with dynamic requests. *Applied Soft Computing* 12(4), 1426–1439, 2012.
72. K.H. Kim, G.-P. Hong, A heuristic rule for relocating blocks. *Com. and Oper. Res.* 33, 940–954, 2005.
73. A.J. Kleywegt, J.D. Papastavrou, The dynamic and stochastic knapsack problem. *Operations Research* 46(1), 17–35, 1998.
74. A.J. Kleywegt, J.D. Papastavrou, The dynamic and stochastic knapsack problem with random sized items. *Operations Research* 49(1), 26–41, 2001.
75. M. Laguna, R. Marti, GRASP and path relinking for 2-layer straight line crossing minimization. *INFORMS J. on Computing* 11(1), 44–52, 1999.
76. J.-H. Lee, C.-D. Park, K.-Y. Chwa, An online relocation game on a graph. *J. of Graph Algorithms and Applications* 5(5), 3–16, 2001.
77. M.Sh. Levin, *Combinatorial Engineering of Decomposable Systems*. Kluwer Academic Publishers, Dordrecht, 1998.
78. M.Sh. Levin, *Composite Systems Decisions*. Springer, New York, 2006.
79. M.Sh. Levin, Combinatorial optimization in system configuration design. *Automation and Remote Control* 70(3), 519–561, 2009.
80. M.Sh. Levin, Towards communication network development (structural system issues, combinatorial models). In: *2010 IEEE Region 8 Int. Conf. SIBIRCON-2010*, vol. 1, 204–208, 2010.
81. M.Sh. Levin, Restructuring in combinatorial optimization. Electronic preprint, 11 p., Febr. 8, 2011. <http://arxiv.org/abs/1102.1745> [cs.DS]
82. M.Sh. Levin, Multiset estimates and combinatorial synthesis. Electronic preprint. 30 pp., May 9, 2012. <http://arxiv.org/abs/1205.2046> [cs.SY]
83. M.Sh. Levin, Towards design of system hierarchy (research survey). Electronic preprint. 36 p., Dec. 7, 2012. <http://arxiv.org/abs/1212.1735> [math.OC]

84. M.Sh. Levin, Clique-based fusion of graph streams in multi-function system testing. *Informatica* 23(3), 391–404, 2012.
85. M.Sh. Levin, Towards multistage design of modular systems. Electronic preprint, 13 p., June 19, 2013. <http://arxiv.org/abs/1306.4635> [cs.AI].
86. M.Sh. Levin, *Modular System Design and Evaluation*, Springer, 2015.
87. M.Sh. Levin, Towards combinatorial clustering: preliminary research survey. *Electr. prepr.*, 102 p., May 28, 2015. <http://arxiv.org/abs/1505.07872> [cs.AI]
88. M.Sh. Levin, Discrete route/trajectory decision making problems. *Electr. prepr.*, 25 p., Aug. 16, 2015. <http://arxiv.org/abs/1508.03863> [cs.AI]
89. M.Sh. Levin, M.A. Danieli, Hierarchical decision making framework for evaluation and improvement of composite systems (example for building). *Informatica (LI)* 16(2), 213–240, 2005.
90. M.Sh. Levin, A.V. Fimin, Configuration of alarm wireless sensor element. In: *Proc. of 2nd Int. Conf. on Ultra Modern Telecommunication ICUMT-2010*, Moscow, 924–928, 2010.
91. M.Sh. Levin, M. Petukhov, Multicriteria assignment problem (selection of access points). In: *Proc. of IEA/AIE 2010, LNCS 6097, part II*, Springer, Cordoba, Spain, 277–287, 2010.
92. M.Sh. Levin, A.V. Safonov, Improvement of regional telecommunications networks. *J. of Communications Technology and Electronics* 56(6), 770–778, 2011.
93. M.Sh. Levin, A. Andrushevich, A. Klapproth, Improvement of building automation system. In: *Proc. of 24th Int. Conf. IEA/AIE 2011, LNCS 6704, part II*, Springer, Heidelberg, 459–468, 2011.
94. R.-K. Li, Y.-T. Shyu, S. Adiga, A heuristic rescheduling algorithm for computer-based production scheduling systems. *Int. J. Prod. Res.* 31, 1815–1826, 1993.
95. K.R. Lima, Y. Wakabayashi, Convex recoloring of paths. *Electr. Notes in Disc. Math.* 37, 165–170, 2011.
96. W.A. Lodwick (ed), *Fuzzy Optimizaiton: Recent Advances and Applications*. Springer, 2010.
97. G. Manimaran, C. Murthy, An efficient dynamic scheduling algorithm for multiprocessor real-time systems. *IEEE Trans. on Parallel and Distributed Systems* 9(3), 312–319, 1998.
98. B. Manna, Cluster editing problem for points on the real line: A polynomial time algorithm. *Inform. Process. Lett.* 110(21), 961–965, 2010.
99. R. Masson, T. Vidal, J. Michallet, P.H.W. Penna, V. Petrucci, A. Subramanian, H. Dubedout, An iterated local search heuristic for multi-capacity bin-packing and machine reassignment. *ESWA* 40(13), 5266–5275, 2013.
100. A.B. McDonald, T.F. Znati, A mobility-based framework for adaptive clustering in wireless ad hoc network. *IEEE J. on Selected Areas in Communications* 17(8), 1466–1487, 1999.
101. E. Melachrinoudis and H. Min, The dynamic relocation and phase-out of a hybrid, two-eshelon plant / warehousing facility: A multiple objective approach. *EJOR* 123(1), 1–15, 2000.
102. M. Mestria, L.S. Ochi, S. de Lima Martins, GRASP with path relinking for the symmetric Euclidean clustered traveling salesman problem. *Comp. and Oper. Res.* 40(12), 3218–3229, 2012.
103. B.G. Mirkin, *Group choice*. Halsted Press, New York, 1979.
104. R.E.N. Moraes, C.C. Ribeiro, Power optimization in ad hoc wireless network topology control with biconnectivity requirements. *Comp. and Oper. Res.* 40(12), 3188–3196, 2012.
105. S. Moran, S. Snir, Convex recoloring of strings and trees: definitions, hardness results and algorithms. *J. Comput. System Sci.* 74(5), 850–869, 2008.
106. R.W. Morrison, *Designing Evolutionary Algorithms for Dynamic Environments*. Berlin, Springer, 2004.
107. H. Noltmeier, H.-C. Wirth, S.O. Krumke, Network design and improvement. *ACM Computing Surveys* 32(3es), Art. no. 2, 1999.
108. M.G. Omran, A. Salman, A.P. Engelbrecht, Dynamic clusterign using particle swarm optimizaiton with applicaiton in image segmentation. *Pattern Analysis and Applications* 8(4), 332–344, 2006.
109. D. Ouelhadj, S. Petrovic, A survey of dynamic scheduling in manufacturign systems. *J. of Scheduling* 12(4), 417–431, 2009.
110. A. Papadogiannis, D. Gesbeert, E. Hardouin, A dynamic clusterign approach in wireless networks with multi-cell cooperative processing. In: *IEEE Int. Conf. on Communicaitons ICC'08*, 4033–4037, 2008.
111. P.M. Pardalos, E.K. Aydogan, F. Gurbuz, O. Demirtas, B.B. Bakiri, Fuzzy combinatorial optimization

- problems. In: P.M. Pardalos, D.-Z. Du, R.L. Graham (eds), *Handbook of Combinatorial Optimization*, Springer, 1357–1413, 2013.
- 112.V. Pareto, *Manual of Political Economy*. (English translation), A. M. Kelley Publishers, New York, 1971.
- 113.O. Pedrola, M. Ruiz, L. Velasco, D. Careglio, O.G. de Dios, J. Comellas, A GRASP with path relinking heuristic for the IP/MPLS-over-WSN multi-layer network optimization problem. *Comp. and Oper. Res.* 40(12), 3174–3187, 2012.
- 114.M.E. Petering, M. Hussein, A new mixed integer program and extended look-ahead heuristic algorithm for the block relocation problem. *EJOR* 231, 120–130, 2013.
- 115.L.L. Pollock, M.L. Soffa, Incremental global reoptimization of programs. *ACM Trans. on Programming Languages and Systems* 14(2), 173–200, 1992.
- 116.J. Qiu, Y. Liu, G. Mohan, K.C. Chua, Fast spanning tree reconnection mechanism for resilient Metro Ethernet networks. *Computer Networks* 55(00), 2717–2729, 2011.
- 117.S. Rahmann, T. Wittkop, J. Baumbach, M. Martin, A. Truss, S. Bocker, Exact and heuristic algorithms for weighted cluster editing. In: *Proc. Comput. Syst. Bioinform. Conf.*, 6(1), 391–401, 2007.
- 118.R. Rangsaritratamee, W. Ferrell Jr., M. Kurz, Dynamic rescheduling that simultaneously considers efficiency and stability. *Computers and Industrial Engineering* 46(1), 1–15, 2004.
- 119.C.R. Reeves, T. Yamada, Genetic algorithms, path relinking, and flowshop sequencing problem. *Evolutionary Computation* 6(1), 45–60, 1998.
- 120.M.G.C. Resende, C.C. Ribeiro, GRASP with path relinking: Recent advances and applicaitons. In: *Metaheuristics: Progress as Real Problem Solvers*. Springer, 29–63, 2006.
- 121.P. Rohlfshagen, X. Yao, The dynamic knapsack problem revised: A new benchmark problem for dynamic combinatorial optimisation. In: *Applications of Evolutionary Computing*, LNCS 5484, Springer, 745–754, 2009.
- 122.B. Roy, *Multicriteria Methodology for Decision Aiding*. Kluwer, Dordrecht, 1996.
- 123.M. Savelsbergh, M. Sol, DRIVE: Dynamic routing of independent vehicles. *Operations Research* 46(4), 474–490, 1998.
- 124.M.W. Schaffter, Scheduling with forbidden sets. *Discrete Appl. Math.* 72(12), 155–166, 1997.
- 125.F. Schulte, S. Voss, Decision support for environmental-friendly vehicle relocations in free-floating car sharing systems: The case of car2go. *Procedia CIRP* 30, 275–280, 2015.
- 126.R. Shamir, R. Sharan, D. Tsur, Cluster graph modification problems. *Disc. Appl. Math.* 144(1-2), 173–182, 2004.
- 127.K. Sorensen, P. Schittekat, Statistical analysis of distance-based path relinking for the capacitated vehicle routing problem. *Comp. and Oper. Res.* 40(12), 3197–3205, 2012.
- 128.W. Souffriau, P. Vansteenwegen, G. Vanden Berghe, D. Van Oudheusden, A path relinking approach for the team orienteering problem. *Comp. and Oper. Res.* 37(11), 1853–1859, 2010.
- 129.E.-G. Talbi, *Metaheuristics: From Design to Implementation*. Wiley, 2009.
- 130.V. T’Kindt, J.-C. Billaut, Vincent T’Kindt, Jean-Charles Billaut, *Multicriteria Scheduling: Theory, Models and Algorithms*. 2nd ed., Springer, 2006.
- 131.F.L. Usberti, P.M. Franca, A.L.M. Franca, GRASP with evolutionary path-relinking for the capacitated arc routing problem. *Comp. and Oper. Res.* 40(12), 3206–3217, 2012.
- 132.E. Vallada, R. Ruiz, Genetic algothrothms with path relinking for the minimum tardness permutation flowshop problem. *Omega* 38(1), 57–67, 2010.
- 133.G.E. Viera, J.W. Herrmann, E. Lin, Rescheduling manufacturing systems: a framework of strategies, policies, and methods. *J. of Heuristics* 6, 39–62, 2003.
- 134.B. Vos, H. Akkermans, Capturing the dynamics of facility allocation. *Int. J. of Operations & Production Management* 16(11), 57–70, 1996.
- 135.G. Wang, G. Cao, T.L. Porta, W. Zang, Sensor reallocation in mobile sensor network. In: *Proc. IEEE 24th Annu. Conf. of the Comp. and Commun. Soc. INFOCOM 2005*, vol. 4, 2302–2312, 2005.
- 136.Z. Wang, Z. Lu, T. Ye, Multi-neighborhood local search optimization for machine reassignment problem. *Comp. and Oper. Res.* 68, 16–29, 2016.
- 137.H. Wirth, J. Steffan, Reload cost problems: Minimum diameter spanning trees. *Discr. Appl. Math.* 113(1), 73–85, 2001.
- 138.M. Wzorek, P. Doherty, Reconfigurable path planning for an autonomous unmanned aerial vehicle.

- In: Int. Conf. on Hybrid Information Technology ICHIT'06, vol. 2, 242–249, 2006.
- 139.M. Yagiura, T. Ibaraaki, F. Glover, A path relinking approach with ejection chains for the generalized assignment problem. *EJOR* 169(2), 548–569, 2006.
- 140.S. Yang, Y.-S. Ong, Y. Jin (eds), *Evolutionary Computation in Dynamic and Uncertain Environments*. Berlin, Springer, 2007.
- 141.S. Yang, Y. Jiang, T.T. Nguyen, Metaheuristics for dynamic combinatorial optimization problems. *IMA J. of Management Mathematics* 24, 451–480, 2013.
- 142.O.A. Yemets, A.A. Roskladka, Combinatorial optimization under uncertainty. *Cybernetics and Systems Analysis* 44(5), 655–663, 2008.
- 143.M. Yu, K.K. Leung, A. Malvankar, A dynamic clustering and energy efficient routing technique for sensor networks. *IEEE Trans. on Wireless Communications* 6(8), 3069–3079, 2007.
- 144.E. Zehendner, M. Caserta, D. Feillet, S. Schwarze, S. Voss, An improved mathematical formulation for the blocks relocation problem. *EJOR* 245, 415–422, 2015.
- 145.W. Zhu, H. Qin, A. Lim, H. Zhang, Iterative deeping A' algorithm for the container relocation problem. *IEEE Trans. on Automatic Science and Engineering* 9, 710–722, 2012.
- 146.C. Zopounidis, M. Doumpos, Multicriteria classification and sorting methods: a literature review. *EJOR* 138(2), 229–246, 2002.
- 147.M. Zweben, E. Davis, B. Daun, M.J. Deale, Scheduling and rescheduling with iterative repair. *IEEE Trans. SMC*, 23(6), 1588–1596, Dec. 1993.