



Feedback Enhances Simultaneous Wireless Information and Energy Transmission in Multiple Access Channels

Selma Belhadj Amor, Samir M. Perlaza, Ioannis Krikidis, and
H. Vincent Poor

**RESEARCH
REPORT**

N° 8804

November 2015

Project-Team Socrate



Feedback Enhances Simultaneous Wireless Information and Energy Transmission in Multiple Access Channels

Selma Belhadj Amor, Samir M. Perlaza, Ioannis Krikidis, and
H. Vincent Poor

Project-Team Socrate

Research Report n° 8804 — November 2015 — 44 pages

Selma Belhadj Amor is with Laboratoire CITI (Joint Lab between Université de Lyon, INRIA, and INSA de Lyon), Lyon, France (selma.belhadj-amor@inria.fr). Samir M. Perlaza is with Laboratoire CITI (Joint Lab between Université de Lyon, INRIA and INSA de Lyon), Lyon, France (samir.perlaza@inria.fr). He is also with the Department of Electrical Engineering at Princeton University, Princeton, NJ 08544, USA. Ioannis Krikidis is with the Department of Electrical and Computer Engineering at the University of Cyprus, Nicosia, Cyprus (krikidis@ucy.ac.cy). H. Vincent Poor is with the Department of Electrical Engineering at Princeton University, Princeton, NJ 08544, USA (poor@princeton.edu). Part of this work was presented in the Fifth International Conference on Communications and Networking (ComNet'2015), Hammamet, Tunisia, in November 2015 [1]. Part of this work was presented to the 2016 IEEE International Symposium on Information Theory (ISIT), Barcelona, Spain. This research is supported in part by the European Commission under Marie Skłodowska-Curie Individual Fellowship No. 659316, and in part by the U.S. National Science Foundation under Grants CNS-1456793 and ECCS-1343210.

**RESEARCH CENTRE
GRENOBLE – RHÔNE-ALPES**

Inovallée
655 avenue de l'Europe Montbonnot
38334 Saint Ismier Cedex

Abstract: In this report, the fundamental limits of simultaneous information and energy transmission in the two-user Gaussian multiple access channel (G-MAC) with and without feedback are fully characterized. More specifically, all the achievable information and energy transmission rates (in bits per channel use and energy-units per channel use, respectively) are identified. Furthermore, the fundamental limits on the individual and sum- rates given a minimum energy rate ensured at an energy harvester are also characterized. In the case without feedback, an achievability scheme based on power-splitting and successive interference cancellation is shown to be optimal. Alternatively, in the case with feedback (G-MAC-F), a simple yet optimal achievability scheme based on power-splitting and Ozarow's capacity achieving scheme is presented. Finally, the energy transmission enhancement induced by the use of feedback is quantified. Feedback can at most double the energy transmission rate at high SNRs when the information transmission sum-rate is kept fixed at the sum-capacity of the G-MAC, but it has no effect at very low SNRs.

Key-words: Feedback, Gaussian multiple access channel, simultaneous information and energy transmission, RF energy harvesting, information-energy capacity region.

L'utilisation de la voie de retour améliore la transmission simultanée d'information et d'énergie dans les canaux sans fils à accès multiple

Résumé : Dans le présent-rapport, les limites fondamentales de la transmission simultanée d'information et d'énergie dans le canal Gaussien à accès multiple (G-MAC) avec et sans voie de retour sont déterminées. L'ensemble des débits atteignables de transmission d'information et d'énergie (en bits par utilisation canal et en unités d'énergie par utilisation canal respectivement) est identifié. En outre, on caractérise les limites fondamentales sur les débits individuels et le débit-somme de transmission de l'information pour un débit d'énergie donné à l'entrée d'un collecteur d'énergie. Dans le cas sans voie de retour, on démontre qu'un schéma d'atteignabilité, basé sur la division de puissance et sur l'annulation successive de l'interférence, est optimal. En contrepartie, dans le cas avec voie de retour (G-MAC-F), un schéma d'atteignabilité, simple mais optimal, basé sur la division de puissance et sur le schéma d'Ozarow qui atteint la capacité, est présenté. Finalement, le gain en énergie induit par l'exploitation de la voie de retour est quantifié. La voie de retour peut au mieux doubler le débit d'énergie à fort rapport signal sur bruit (RSB) pour un débit-somme d'information égal à la capacité-somme. En revanche, l'utilisation de la voie de retour n'a aucun effet à très faibles RSBs.

Mots-clés : Voie de retour, canal Gaussien à accès multiple (G-MAC), transmission simultanée d'information et d'énergie, collecte d'énergie RF, région de capacité d'information-énergie.

Contents

1	Introduction	5
1.1	Contributions	6
1.2	Organization of the Report	7
2	Gaussian Multiple Access Channel With Feedback and Energy Harvester	7
2.1	Information Transmission	8
2.2	Energy Transmission	9
2.3	Simultaneous Energy and Information Transmission (SEIT)	10
3	Information-Energy Capacity Region	11
3.1	Case With Feedback	11
3.2	Case Without Feedback	11
3.3	Comments on the Achievability	12
3.4	Comments on the Converse	13
3.5	Example	14
4	Maximum Individual Rates Given a Minimum Energy Rate Constraint	14
4.1	Case With Feedback	14
4.2	Case Without Feedback	16
5	Maximum Information Sum-Rate Given a Minimum Energy Rate Constraint	16
5.1	Case With Feedback	16
5.2	Case Without Feedback	17
6	Comments on the Shape of the Information-Energy Capacity Region	18
6.1	Case With Feedback	18
6.2	Case Without Feedback	20
7	Energy Transmission Enhancement With Feedback	21
8	Conclusion and Extensions	24
A	Proof of Theorem 1	24
A.1	Proof of Achievability	25
A.2	Proof of Converse	30
B	Proof of Theorem 2	34
C	Proof of Proposition 1	35
D	Proof of Proposition 2	36
E	Proof of Proposition 3	37
F	Proof of Proposition 4	39
G	Proof of Theorem 3	41

1 Introduction

For decades, a traditional engineering perspective was to exclusively use radio frequency (RF) signals for information transmission. However, a variety of modern wireless systems suggest that RF signals can be simultaneously used for information and energy transmission [2]. Typical examples of communications technologies already exploiting this principle are reported in [3]. Beyond the existing applications, simultaneous information and energy transmission (SEIT) appears as a promising technology for a variety of emerging applications including low-power short-range communication systems, sensor networks, machine-to-machine networks and body-area networks, among others [4].

When a point-to-point communication involves sending energy along with information, it should be designed to simultaneously meet two goals: *(i)* To reliably transmit information to a receiver at a given rate with a sufficiently small probability of error; and *(ii)* To transmit energy to an energy harvester (EH) at a given rate with a sufficiently small probability of energy shortage. The EH might not necessarily be co-located with the information receiver. More specifically, the EH might possess a set of antennas (rectennas) dedicated to the energy harvesting task, which are independent of those dedicated to the information receiving task. In the special case in which the receiver and the EH are co-located, that is, they share the same antenna, a signal division via time-sharing or power-splitting must be implemented. In the former, a fraction of time the antenna is connected to the information receiver, whereas the remaining time it is connected to the EH. The latter implies a signal division in which part of the signal is sent to the information receiver and the remaining part is sent to the EH. This signal processing is out of the scope of this paper and the reader is referred to [4]. In the realm of information theory, the problem of point-to-point SEIT with a co-located EH is cast into a problem of information transmission subject to minimum energy constraints at the channel output [5, 6]. From this perspective, the case with a co-located EH is a special case of the non-co-located EH case in which the input signal to the receiver is identical to the signal input to the EH. In this paper, the analysis of SEIT is general and focuses on the case of non-co-located EHs. Information and energy transmission are often conflicting tasks, and thus subject to a trade-off between the information transmission rate (bits per channel use) and the energy transmission rate (energy-units per channel use). This trade-off is evidenced in finite constellation schemes, as highlighted in Popovski *et al.*'s [7]. Consider the noiseless transmission of a 4-PAM signal over a point-to-point channel with input alphabet $\{-2, -1, 1, 2\}$ and with a co-located EH. Given that the symbols -2 and 2 (resp. -1 and 1) deliver 4 (resp. 1) energy-units/ch.use, without any energy rate constraint, the system conveys a maximum of 2 bits/ch.use and $\frac{5}{2}$ energy-units/ch.use by choosing all available symbols with equal probability. However, if the received energy rate must be for instance at least 4 energy-units/ch.use, the maximum information rate is 1 bit/ch.use. This is mainly because the transmitter is forced to communicate using only the symbols capable of delivering the maximum energy rate. From this simple example, it is easy to see how additional energy rate constraints may hinder information transmission in a point-to-point scenario.

In a multi-user scenario, the information-energy rate trade-off is more involved. Usually, users must coordinate their transmission strategies and cooperate so as to achieve the energy rate requirement. Consider for instance a network in which one single transmitter simultaneously transmits energy to an EH and information to an information receiver. Assume that this transmitter is required to deliver an energy rate that is less than what it is able to deliver by only transmitting information. In this case, such a transmitter is able to fulfill the energy-transmission task independently of the behavior of the other transmitters. More importantly, it can use all its available power budget to maximize its information transmission rate while still being able of meeting the energy rate constraint. In this case, the minimum energy rate constraint does not

play a fundamental role. On the other hand, when the same transmitter is requested to deliver an energy rate that is higher than what it is able to deliver by only transmitting information, its behavior is totally dependent on the behavior of the other transmitters. Indeed, it depends on whether or not other transmitters are transmitting signals using an average power such that the energy rate is met. In this case, the minimum energy rate constraint drastically affects the way that the transmitters interact with each other. More critical scenarios are the cases in which the requested energy rate is less than what all transmitters are able to deliver by simultaneously transmitting information using all the available individual power budgets. In these cases, none of the transmitters can unilaterally ensure reliable energy transmission at the requested rate. Hence, transmitters must engage in a mechanism through which an energy rate that is higher than the energy delivered by exclusively transmitting information-carrying signals is ensured at the EH. This suggests, for instance, sending signals with correlation to increase the received energy rates. This correlation can result from the use of power splits in which the transmitted symbols are formed by an information-carrying and an energy-carrying component. The latter typically consists in signals that are known at all devices and can be constructed such that the energy captured at the EH is maximized.

Most of the existing studies of SEIT follow a signal-processing or networking approach and focus mainly on the feasibility aspects. For instance, optimization of beamforming strategies was considered for multi-antenna broadcast channels in [8, 9], and [10], and for multi-antenna interference channels in [11]. SEIT was also studied in the general realm of cellular systems in [12] as well as in multi-hop relaying systems in [6, 13, 14, 15, 16], and [17]. Other studies in the two-way channel are reported in [7] and in graphical unicast and multicast networks in [18].

From an information-theoretic viewpoint, the pioneering works by Varshney in [5] and [19], as well as Grover and Sahai in [20] provided the fundamental limits on SEIT in point-to-point channels with co-located EH. More specifically, the case of the single-link point-to-point channel was discussed in [5] while the case of parallel-links point-to-point channel was studied in [19] and [20]. Despite the vast existing literature on this subject, the fundamental limits of SEIT are still unknown in most multi-user channels. Multi-hop and multi-antenna wiretap channels under minimum received energy rate constraints were considered in [6] and [21], respectively. In the case of the discrete memoryless multiple access channel (DM-MAC), the trade-off between information rate and energy rate has been studied in [6]. Therein, Fouladgar *et al.* characterized the information-energy capacity region of the two-user DM-MAC when a minimum energy rate is required at the input of the receiver (the receiver and the EH are co-located). An extension of the work in [6] to the Gaussian multiple access channel (G-MAC) is far from trivial due to the fact that the information-energy capacity region involves an auxiliary random-variable that cannot be eliminated as in the case without energy constraints. Moreover, different energy rate constraints for the G-MAC have also been investigated. For instance, Gastpar [22] considered the G-MAC under a maximum received energy rate constraint. Under this assumption, channel-output feedback has been shown not to increase the information capacity region. More generally, the use of feedback in the K -user G-MAC, even without energy rate constraints, has been shown to be of limited impact in terms of information sum-rate improvement. This holds even in the case of perfect feedback. More specifically, feedback increases the information sum-capacity in the G-MAC by at most $\frac{\log_2(K)}{2}$ bits per channel use [23]. Hence, the use of feedback is difficult to justify from the point of view of exclusively transmitting information.

1.1 Contributions

This paper studies the fundamental limits of SEIT in the two-user G-MAC with an EH, with and without feedback. It shows that when the goal is to simultaneously transmit both information

and energy, feedback can significantly improve the global performance of the system in terms of both information and energy transmission rates. More specifically, the paper provides the first full characterization of the information-energy capacity region for the G-MAC with and without feedback, i.e., all the achievable information and energy transmission rates in bits per channel use and energy-units per channel use, respectively. Furthermore, the fundamental limits on the individual and sum- rates given a minimum energy rate ensured at the EH are also provided. In the case without feedback, an achievability scheme based on power-splitting and successive interference cancellation is shown to be optimal. Alternatively, in the case with feedback (G-MAC-F), a simple yet optimal achievability scheme that is based on power-splitting and Ozarow’s capacity achieving scheme is presented. Although the proofs of achievability and converse build upon standard information-theoretic techniques, extending these techniques to account for the energy constraint involves many challenges. For instance, to derive upper bounds on the achievable information-energy rate triplets, there are two parts to consider: one that is related to the information transmission for which Fano’s inequality is used, and another that is related to the energy transmission for which concentration inequalities are used to derive an upper bound on the energy rate. Finally, the enhancement of the energy transmission rate induced by the use of feedback is quantified. It is shown that feedback can at most double the energy transmission rate at high SNRs when the information transmission sum-rate is kept fixed at the sum-capacity of the G-MAC, but it has no effect at very low SNRs.

1.2 Organization of the Report

The remainder of the report is structured as follows. Sec. 2 formulates the problem of SEIT in the two-user G-MAC-F and G-MAC with a non-co-located EH. Secs. 3-7 show the main results of this paper for the G-MAC and the G-MAC-F with an EH. Namely, for both settings the following fundamental limits are derived: (a) the information-energy capacity region; and (b) the maximum information individual rates and sum-rates that can be achieved given a targeted energy rate. A global comparison of the fundamental limits in terms of information transmission rates is provided in Sec. 6. In Sec. 7, the maximum energy rate improvement that can be obtained at the input of the EH by using feedback given a targeted information rate is characterized as well as its low and high SNR asymptotics. Finally, Sec. 8 concludes the report and discusses possible extensions. The appendices expose the proofs of the main results.

2 Gaussian Multiple Access Channel With Feedback and Energy Harvester

Consider the two-user memoryless G-MAC with an EH with perfect channel-output-feedback (G-MAC-F) in Fig. 1 and without feedback in Fig. 2. In both channels, at each channel use $t \in \mathbb{N}$, $X_{1,t}$ and $X_{2,t}$ denote the real symbols sent by transmitters 1 and 2, respectively. Let $n \in \mathbb{N}$ denote the blocklength. The receiver observes the real channel output

$$Y_{1,t} = h_{11}X_{1,t} + h_{12}X_{2,t} + Z_t, \tag{1}$$

and the EH observes

$$Y_{2,t} = h_{21}X_{1,t} + h_{22}X_{2,t} + Q_t, \tag{2}$$

where h_{1i} and h_{2i} are the corresponding constant non-negative real channel coefficients from transmitter i to the receiver and the EH, respectively. The channel coefficients are assumed to satisfy the following \mathcal{L}_2 -norm condition:

$$\forall j \in \{1, 2\}, \quad \|\mathbf{h}_j\|^2 \leq 1, \tag{3}$$

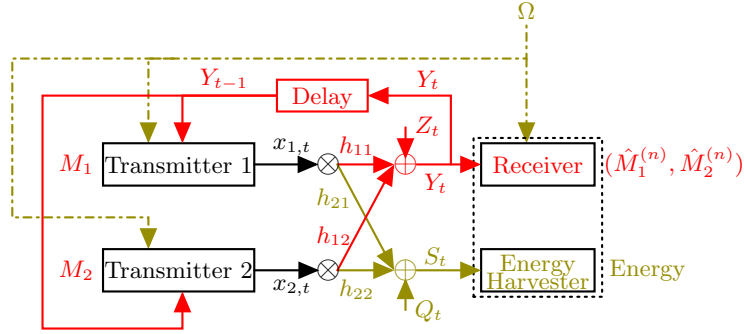

Figure 1: Two-user memoryless G-MAC-F with an EH.

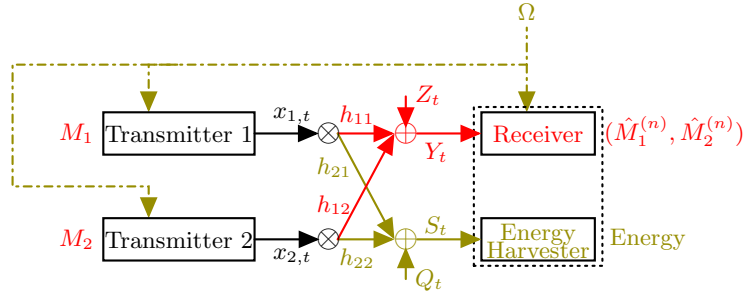

Figure 2: Two-user memoryless G-MAC with an EH.

with $\mathbf{h}_j \triangleq (h_{j1}, h_{j2})^\top$ to satisfy the principle of conservation of energy.

The noise terms Z_t and Q_t are realizations of two identically distributed zero-mean unit-variance real Gaussian random variables. In the following, there is no particular assumption on the joint distribution of Q_t and Z_t .

In the G-MAG-F with an EH, a perfect feedback link from the receiver to transmitter i allows at the end of each channel use t , the observation of the channel output Y_{t-d} at transmitter i , with $d \in \mathbb{N}$ the delay of the feedback channel. Without any loss of generality, the delay is assumed to be the same from the receiver to both transmitters and equivalent to one channel use, i.e., $d = 1$.

Within this context, two main tasks are to be simultaneously accomplished: information transmission and energy transmission.

2.1 Information Transmission

The goal of the communication is to convey the independent messages M_1 and M_2 from transmitters 1 and 2 to the common receiver. The messages M_1 and M_2 are independent of the noise terms $Z_1, \dots, Z_n, Q_1, \dots, Q_n$ and uniformly distributed over the sets $\mathcal{M}_1 \triangleq \{1, \dots, \lfloor 2^{nR_1} \rfloor\}$ and $\mathcal{M}_2 \triangleq \{1, \dots, \lfloor 2^{nR_2} \rfloor\}$, where R_1 and R_2 denote the information transmission rates and $n \in \mathbb{N}$ the blocklength.

In the G-MAC-F with an EH, at each time t , the existence of feedback links allows the t -th symbol of transmitter i to be dependent on all previous channel outputs Y_1, \dots, Y_{t-1} as well as its message index M_i and a randomly generated index $\Omega \in \{1, \dots, \lfloor 2^{nR_r} \rfloor\}$, with $R_r \geq 0$. The index Ω is independent of both M_1 and M_2 and assumed to be known by all transmitters and

the receiver. More specifically,

$$X_{i,1} = f_{i,1}^{(n)}(M_i, \Omega) \quad \text{and} \quad (4a)$$

$$X_{i,t} = f_{i,t}^{(n)}(M_i, \Omega, Y_{1,1}, \dots, Y_{1,t-1}), \quad t \in \{2, \dots, n\}, \quad (4b)$$

for some encoding functions

$$f_{i,1}^{(n)}: \mathcal{M}_i \times \mathbb{N} \rightarrow \mathbb{R} \quad \text{and} \quad (5)$$

$$f_{i,t}^{(n)}: \mathcal{M}_i \times \mathbb{N} \times \mathbb{R}^{t-1} \rightarrow \mathbb{R}. \quad (6)$$

In the G-MAC with an EH, at each time t , the t -th symbol of transmitter i is

$$X_{i,t} = g_{i,t}^{(n)}(M_i, \Omega), \quad t \in \{1, \dots, n\}, \quad (7a)$$

where $g_{i,t}^{(n)}: \mathcal{M}_i \times \mathbb{N} \rightarrow \mathbb{R}$ is the encoding function.

In the G-MAC-F and in the G-MAC with an EH, for all $i \in \{1, 2\}$, transmitter i 's channel inputs $X_{i,1}, \dots, X_{i,n}$ satisfy an expected average *input power constraint*

$$\frac{1}{n} \sum_{t=1}^n \mathbb{E}[X_{i,t}^2] \leq P_i, \quad (8)$$

where P_i denotes the average transmit power of transmitter i in energy-units per channel use and where the expectation is over the message indices, the random index, and the noise realizations prior to channel use t . The dependence of $X_{i,t}$ on $Y_{1,1}, \dots, Y_{1,t-1}$ (and thus on Z_1, \dots, Z_{t-1}) is shown by (4).

The G-MAC-F and G-MAC with an EH are fully described by the signal to noise ratios (SNRs): SNR_{ji} , with $\forall(i, j) \in \{1, 2\}^2$. These SNRs are defined as follows

$$\text{SNR}_{ji} \triangleq |h_{ji}|^2 P_i, \quad (9)$$

given the normalization over the noise powers.

The receiver produces an estimate $(\hat{M}_1^{(n)}, \hat{M}_2^{(n)}) = \Phi^{(n)}(Y_{1,1}, \dots, Y_{1,n}, \Omega)$ of the message-pair (M_1, M_2) via a decoding function $\Phi^{(n)}: \mathbb{R}^n \times \mathbb{N} \rightarrow \mathcal{M}_1 \times \mathcal{M}_2$, and the average probability of error is

$$P_{\text{error}}^{(n)}(R_1, R_2) \triangleq \Pr \left\{ (\hat{M}_1^{(n)}, \hat{M}_2^{(n)}) \neq (M_1, M_2) \right\}. \quad (10)$$

2.2 Energy Transmission

Let $b \geq 0$ denote the minimum energy rate that must be guaranteed at the input of the EH in the G-MAC-F. This rate b (in energy-units per channel use) must satisfy

$$0 \leq b \leq 1 + \text{SNR}_{21} + \text{SNR}_{22} + 2\sqrt{\text{SNR}_{21}\text{SNR}_{22}}, \quad (11)$$

for the problem to be feasible. In fact, $1 + \text{SNR}_{21} + \text{SNR}_{22} + 2\sqrt{\text{SNR}_{21}\text{SNR}_{22}}$ is the maximum energy rate that can be achieved at the input of the EH given the input power constraints in (8). This rate can be achieved when the transmitters use all their power budgets to send fully correlated channel inputs.

The empirical energy transmission rate (in energy-units per channel use) induced by the sequence $(Y_{2,1}, \dots, Y_{2,n})$ at the input of the EH is

$$B^{(n)} \triangleq \frac{1}{n} \sum_{t=1}^n Y_{2,t}^2. \quad (12)$$

The goal of the energy transmission is to guarantee that the empirical energy rate $B^{(n)}$ is not less than a given operational energy transmission rate B that must satisfy

$$b \leq B \leq 1 + \text{SNR}_{21} + \text{SNR}_{22} + 2\sqrt{\text{SNR}_{21}\text{SNR}_{22}}. \quad (13)$$

Hence, the probability of energy outage is defined as follows:

$$P_{\text{outage}}^{(n)}(B) \triangleq \Pr \left\{ B^{(n)} < B - \epsilon \right\}, \quad (14)$$

for some $\epsilon > 0$ arbitrarily small.

Note that b denotes the minimum tolerable energy rate, whereas B denotes the operating energy rate.

In the sequel, for ease of notation, the acronyms G-MAC-F(b) and G-MAC(b) refer to the G-MAC-F and the G-MAC with an EH depicted in Fig. 1 and Fig. 2, respectively, with fixed SNRs: SNR_{11} , SNR_{12} , SNR_{21} , and SNR_{22} , and minimum energy rate constraint b at the input of the EH.

2.3 Simultaneous Energy and Information Transmission (SEIT)

The G-MAC-F(b) (and G-MAC(b), respectively) is said to operate at the information-energy rate triplet $(R_1, R_2, B) \in [0, \infty) \times [0, \infty) \times [b, \infty)$ when both transmitters and the receiver use a transmit-receive configuration such that: (i) reliable communication at information rates R_1 and R_2 is ensured; and (ii) the empirical energy transmission rate in (12) at the input of the EH during the entire blocklength is not lower than B . A formal definition is given below.

Definition 1 (Achievable Rates). *The triplet $(R_1, R_2, B) \in [0, \infty) \times [0, \infty) \times [b, \infty)$ is achievable in the G-MAC-F(b) (and G-MAC(b), resp.) if there exists a sequence of encoding and decoding functions $\{\{f_{1,t}^{(n)}\}_{t=1}^n, \{f_{2,t}^{(n)}\}_{t=1}^n, \Phi^{(n)}\}_{n=1}^\infty$ (and $\{\{g_{1,t}^{(n)}\}_{t=1}^n, \{g_{2,t}^{(n)}\}_{t=1}^n, \Phi^{(n)}\}_{n=1}^\infty$, resp.) such that both the average error probability and the energy-outage probability tend to zero as the blocklength n tends to infinity. That is,*

$$\limsup_{n \rightarrow \infty} P_{\text{error}}^{(n)}(R_1, R_2) = 0, \quad (15)$$

$$\limsup_{n \rightarrow \infty} P_{\text{outage}}^{(n)}(B) = 0 \quad \text{for any } \epsilon > 0. \quad (16)$$

Often, increasing the energy transmission rate implies decreasing the information transmission rates and *vice-versa*. This trade-off is accurately captured by the notion of *information-energy capacity region*.

Definition 2 (Information-Energy Capacity Region). *The information-energy capacity region of the G-MAC-F(b) (and G-MAC(b), resp.), denoted by $\mathcal{E}_b^{\text{FB}}(\text{SNR}_{11}, \text{SNR}_{12}, \text{SNR}_{21}, \text{SNR}_{22})$ ($\mathcal{E}_b(\text{SNR}_{11}, \text{SNR}_{12}, \text{SNR}_{21}, \text{SNR}_{22})$, resp.) is the closure of all achievable information-energy rate triplets (R_1, R_2, B) .*

3 Information-Energy Capacity Region

For any non-negative SNRs: SNR_{11} , SNR_{12} , SNR_{21} , and SNR_{22} , and for any minimum energy rate constraint b satisfying (11), the main results presented in this report are provided in terms of the information-energy capacity region (Def. 2). The results for the G-MAC(b) are a particularization of the results for the G-MAC-F(b). The interest of presenting these results separately stems from the need for comparing both cases.

3.1 Case With Feedback

The information-energy capacity region of the G-MAC-F(b) is fully characterized by the following theorem.

Theorem 1 (Information-Energy Capacity Region of the G-MAC-F(b)). *The information-energy capacity region $\mathcal{E}_b^{\text{FB}}$ ($\text{SNR}_{11}, \text{SNR}_{12}, \text{SNR}_{21}, \text{SNR}_{22}$) of the G-MAC-F(b) is the set of information-energy rate triplets (R_1, R_2, B) that satisfy*

$$0 \leq R_1 \leq \frac{1}{2} \log_2 (1 + \beta_1 \text{SNR}_{11} (1 - \rho^2)), \quad (17a)$$

$$0 \leq R_2 \leq \frac{1}{2} \log_2 (1 + \beta_2 \text{SNR}_{12} (1 - \rho^2)), \quad (17b)$$

$$0 \leq R_1 + R_2 \leq \frac{1}{2} \log_2 (1 + \beta_1 \text{SNR}_{11} + \beta_2 \text{SNR}_{12} + 2\rho\sqrt{\beta_1 \text{SNR}_{11} \beta_2 \text{SNR}_{12}}), \quad (17c)$$

$$b \leq B \leq 1 + \text{SNR}_{21} + \text{SNR}_{22} + 2\rho\sqrt{\beta_1 \text{SNR}_{21} \beta_2 \text{SNR}_{22}} + 2\sqrt{(1 - \beta_1) \text{SNR}_{21} (1 - \beta_2) \text{SNR}_{22}}, \quad (17d)$$

with $(\rho, \beta_1, \beta_2) \in [0, 1]^3$.

Proof: The proof of Theorem 1 is presented in Appendix A. ■

3.2 Case Without Feedback

The information-energy capacity region of the G-MAC(b) is fully characterized by the following theorem.

Theorem 2 (Information-Energy Capacity Region of the G-MAC(b)). *The information-energy capacity region \mathcal{E}_b ($\text{SNR}_{11}, \text{SNR}_{12}, \text{SNR}_{21}, \text{SNR}_{22}$) of the G-MAC(b) is the set of all information-energy rate triplets (R_1, R_2, B) that satisfy*

$$0 \leq R_1 \leq \frac{1}{2} \log_2 (1 + \beta_1 \text{SNR}_{11}), \quad (18a)$$

$$0 \leq R_2 \leq \frac{1}{2} \log_2 (1 + \beta_2 \text{SNR}_{12}), \quad (18b)$$

$$0 \leq R_1 + R_2 \leq \frac{1}{2} \log_2 (1 + \beta_1 \text{SNR}_{11} + \beta_2 \text{SNR}_{12}), \quad (18c)$$

$$b \leq B \leq 1 + \text{SNR}_{21} + \text{SNR}_{22} + 2\sqrt{(1 - \beta_1) \text{SNR}_{21} (1 - \beta_2) \text{SNR}_{22}}, \quad (18d)$$

with $(\beta_1, \beta_2) \in [0, 1]^2$.

Proof: The proof of Theorem 2 is presented in Appendix B. ■

Remark 1. For any non-negative SNR_{11} , SNR_{12} , SNR_{21} , and SNR_{22} , and for any b satisfying (11), the information-energy capacity region of the G-MAC(b) is included in the information-energy capacity region of the G-MAC-F(b), i.e.,

$$\mathcal{E}_b(\text{SNR}_{11}, \text{SNR}_{12}, \text{SNR}_{21}, \text{SNR}_{22}) \subseteq \mathcal{E}_b^{\text{FB}}(\text{SNR}_{11}, \text{SNR}_{12}, \text{SNR}_{21}, \text{SNR}_{22}). \quad (19)$$

Note that this inclusion can be strict. For instance, any rate triplet (R_1, R_2, B) that is achievable in the G-MAC-F(b), for a given minimum energy constraint b , and for which $R_1 + R_2$ equals the perfect feedback sum-capacity cannot be achieved in the G-MAC(b). Note also that if $b = 1 + \text{SNR}_{21} + \text{SNR}_{22} + 2\sqrt{\text{SNR}_{21}\text{SNR}_{22}}$, then both information-energy capacity regions are equal as they only contain the point $(0, 0, b)$.

The remainder of this section highlights some important observations on the achievability and converse proofs of Theorem 1 and Theorem 2. The corresponding proofs are presented in Appendix A and Appendix B, respectively.

3.3 Comments on the Achievability

The achievability scheme in the proof of Theorem 1 is based on power-splitting and Ozarow's capacity-achieving scheme [24]. From an achievability standpoint, the parameters β_1 and β_2 in Theorem 1 might be interpreted as the fractions of average power that transmitters 1 and 2 allocate for information transmission. More specifically, transmitter i generates two signals: an information-carrying (IC) signal with average power $\beta_i P_i$ energy-units per channel use; and a no-information-carrying (NIC) signal with power $(1 - \beta_i)P_i$ energy-units per channel use. The IC signal is constructed using Ozarow's scheme [24]. The role of the NIC signal is to exclusively transmit energy from the transmitter to the EH. Conversely, the role of the IC signal is twofold: information transmission from the transmitter to the receiver and energy transmission from the transmitter to the EH.

The parameter ρ is the average Pearson correlation coefficient between the IC signals sent by both transmitters. This parameter plays a fundamental role in both information transmission and energy transmission. Note for instance that the upper-bounds on the information sum-rate (17c) and on the energy harvested per unit-time (17d) monotonically increase with ρ , whereas the upper-bounds on the individual rates (17a) and (17b) monotonically decrease with ρ . If $\beta_1 \neq 0$ and $\beta_2 \neq 0$, let $\rho^*(\beta_1, \beta_2)$ be the unique solution in $(0, 1)$ to the following equation in ρ :

$$\begin{aligned} & 1 + \beta_1 \text{SNR}_{11} + \beta_2 \text{SNR}_{12} + 2\rho\sqrt{\beta_1\text{SNR}_{11}\beta_2\text{SNR}_{12}} \\ & = (1 + \beta_1 \text{SNR}_{11}(1 - \rho^2))(1 + \beta_2 \text{SNR}_{12}(1 - \rho^2)), \end{aligned} \quad (20)$$

otherwise, let $\rho^*(\beta_1, \beta_2) = 0$. When $\rho = \rho^*(\beta_1, \beta_2)$, the sum of (17a) and (17b) is equal to (17c) giving the maximum information sum-rate which can be achieved when the transmitters are using powers $\beta_1 P_1$ and $\beta_2 P_2$ for transmitting information, i.e., $\rho^*(\beta_1, \beta_2)$ is the information sum-rate optimal correlation coefficient.

Existence and Uniqueness of $\rho^*(\beta_1, \beta_2)$: For a fixed power-splitting $(\beta_1, \beta_2) \in (0, 1]^2$, let the function $\varphi_{\beta_1, \beta_2} : [0, 1] \rightarrow \mathbb{R}$ denote the difference between the right-hand-side and the left-hand-side of (20), i.e.,

$$\begin{aligned} \varphi_{\beta_1, \beta_2}(\rho) & \triangleq 1 + \beta_1 \text{SNR}_{11} + \beta_2 \text{SNR}_{12} + 2\rho\sqrt{\beta_1\text{SNR}_{11}\beta_2\text{SNR}_{12}} \\ & - (1 + \beta_1 \text{SNR}_{11}(1 - \rho^2))(1 + \beta_2 \text{SNR}_{12}(1 - \rho^2)). \end{aligned} \quad (21)$$

The function $\varphi_{\beta_1, \beta_2}(\rho)$ is continuous in ρ on the closed interval $[0, 1]$ and is such that $\varphi_{\beta_1, \beta_2}(0) < 0$ and $\varphi_{\beta_1, \beta_2}(1) > 0$, and thus there exists at least one $\rho_0 \in (0, 1)$ such that $\varphi_{\beta_1, \beta_2}(\rho_0) = 0$ [25,

Bolzano's Intermediate Value Theorem (Theorem 5.2.1)]. Furthermore, this solution ρ_0 is unique because $\varphi_{\beta_1, \beta_2}(\rho)$ is strictly monotonic on $[0, 1]$. This unique solution is $\rho^*(\beta_1, \beta_2)$.

Note also that the Pearson correlation factor between the NIC signals of both transmitters does not appear in Theorem 1. This is mainly because maximum energy transmission occurs using NIC signals that are fully correlated, and thus the corresponding Pearson correlation coefficient is one. Similarly, the Pearson correlation factor between the NIC signal of transmitter i and the IC signal of transmitter j , with $j \in \{1, 2\}$ and $j \neq i$, does not appear in Theorem 1 either. This observation stems from the fact that, without loss of optimality, NIC signals can be chosen to be independent of the message indices and the noise terms. NIC signals can also be assumed to be known by both the receiver and the transmitters. Hence, the interference they create at the receiver can easily be eliminated using successive decoding. Under this assumption, a power-splitting $(\beta_1, \beta_2) \in [0, 1]^2$ guarantees the achievability of non-negative rate pairs (R_1, R_2) satisfying (17a)-(17c) by simply using Ozarow's capacity achieving scheme. At the EH, both the IC and NIC signals contribute to the total harvested energy (12). The IC signal is able to convey at most $\beta_1 \text{SNR}_{21} + \beta_2 \text{SNR}_{22} + 2\rho\sqrt{\beta_1 \text{SNR}_{21}\beta_2 \text{SNR}_{22}}$ energy-units per channel use, while the NIC signal is able to convey at most $(1-\beta_1)\text{SNR}_{21} + (1-\beta_2)\text{SNR}_{22} + 2\sqrt{(1-\beta_1)\text{SNR}_{21}(1-\beta_2)\text{SNR}_{22}}$ energy-units per channel use. The sum of these two contributions as well as the contribution of the noise at the EH justifies the upper-bound on the energy transmission rate in (17d).

The information-energy capacity region without feedback described by Theorem 2 is identical to the information-energy capacity region described by Theorem 1 in the case in which channel inputs are chosen to be mutually independent, i.e., $\rho = 0$. To prove the achievability of the region presented in Theorem 2, Ozarow's scheme is replaced by the scheme proposed independently by Cover [26] and Wyner [27], in which the channel inputs are independent Gaussian variables.

3.4 Comments on the Converse

The proof of the converse to Theorem 1 presented in Appendix A is in two steps. First, it is shown that any information-energy rate triplet $(R_1, R_2, B) \in \mathcal{E}_b^{\text{FB}}(\text{SNR}_{11}, \text{SNR}_{12}, \text{SNR}_{21}, \text{SNR}_{22})$ must satisfy

$$nR_1 \leq \sum_{t=1}^n I(X_{1,t}; Y_{1,t} | X_{2,t}) + \epsilon_1^{(n)}, \quad (22a)$$

$$nR_2 \leq \sum_{t=1}^n I(X_{2,t}; Y_{1,t} | X_{1,t}) + \epsilon_2^{(n)}, \quad (22b)$$

$$n(R_1 + R_2) \leq \sum_{t=1}^n I(X_{1,t} X_{2,t}; Y_{1,t}) + \epsilon_{12}^{(n)}, \quad (22c)$$

$$B \leq \mathbb{E}[B^{(n)}] + \delta^{(n)}, \quad (22d)$$

$$B \geq b, \quad (22e)$$

where $\frac{\epsilon_1^{(n)}}{n}$, $\frac{\epsilon_2^{(n)}}{n}$, $\frac{\epsilon_{12}^{(n)}}{n}$, and $\delta^{(n)}$ tend to zero as n tends to infinity. Second, these bounds are evaluated for a general choice of jointly distributed pair of inputs $(X_{1,t}, X_{2,t})$ such that $\mathbb{E}[X_{i,t}] = \mu_{i,t}$, $\text{Var}(X_{i,t}) = \sigma_{i,t}^2$, and $\text{Cov}[X_{1,t}, X_{2,t}] = \lambda_t$, $\forall i \in \{1, 2\}$ and $\forall t \in \{1, \dots, n\}$.

The converse to Theorem 2 follows the same lines as in the case with feedback, with the assumption that $X_{1,t}$ and $X_{2,t}$ are independent (i.e., $\forall t \in \{1, \dots, n\}$, $\lambda_t = 0$).

3.5 Example

Fig. 3 shows the information-energy capacity region of the G-MAC-F(b) and the G-MAC(b), respectively, with $\text{SNR}_{11} = \text{SNR}_{12} = \text{SNR}_{21} = \text{SNR}_{22} = 10$ and $b = 0$.

Therein, in each case, the figure in the center is a 3-D representation of the information-energy capacity region, whereas left and right figures represent a bi-dimensional view in the R_1 - R_2 and B - R_2 planes, respectively. The triplet Q_1 with the highest energy transmission rate is $Q_1 = (0, 0, 1 + \text{SNR}_{21} + \text{SNR}_{22} + 2\sqrt{\text{SNR}_{21}\text{SNR}_{22}})$. The triplets Q_2, Q'_2, Q_4 and Q_5 are coplanar and they satisfy $B = 1 + \text{SNR}_{21} + \text{SNR}_{22}$. More specifically, $Q_4 = (\frac{1}{2} \log_2(1 + \text{SNR}_{11}), 0, 1 + \text{SNR}_{21} + \text{SNR}_{22})$ and $Q_5 = (\frac{1}{2} \log_2(1 + \text{SNR}_{11}), \frac{1}{2} \log_2(1 + \frac{\text{SNR}_{11}}{1 + \text{SNR}_{12}}), 1 + \text{SNR}_{21} + \text{SNR}_{22})$ are achievable with and without feedback. In Fig. 3, the triplets Q_2, Q_3 and Q_6 guarantee information transmission at the perfect feedback sum-capacity, i.e., $R_1 + R_2 = \frac{1}{2} \log_2(1 + \text{SNR}_{11} + \text{SNR}_{12} + 2\rho^*(1, 1)\sqrt{\text{SNR}_{11}\text{SNR}_{12}})$. In the G-MAC(0), the triplets Q_2, Q_3 , and Q_5 guarantee information transmission at the sum-capacity without feedback, i.e., $R_1 + R_2 = \frac{1}{2} \log_2(1 + \text{SNR}_{11} + \text{SNR}_{12})$.

A global comparison of the shape of these two regions is provided in Sec. 6. This comparison is based on extreme information transmission points, i.e., maximum information individual and sum rates, given a minimum energy rate. The exact values of these extreme points are derived in Sec. 4 and Sec. 5.

4 Maximum Individual Rates Given a Minimum Energy Rate Constraint

In this section, for any fixed non-negative SNRs: $\text{SNR}_{11}, \text{SNR}_{12}, \text{SNR}_{21}$, and SNR_{22} , and for any energy rate constraint b at the input of the EH satisfying (11), the maximum individual information rates of transmitters 1 and 2 in the G-MAC-F(b) and G-MAC(b) are identified.

Let $\xi : \mathbb{R}_+ \rightarrow [0, 1]$ be defined as follows:

$$\xi(b) \triangleq \frac{(b - (1 + \text{SNR}_{21} + \text{SNR}_{22}))^+}{2\sqrt{\text{SNR}_{21}\text{SNR}_{22}}}. \quad (23)$$

Note that $\xi(b)$ is the minimum correlation of the channel inputs that is required to achieve the target energy rate b . That is, $\xi(b)$ is the solution in $[0, 1]$ to

$$b = 1 + \text{SNR}_{21} + \text{SNR}_{22} + 2x\sqrt{\text{SNR}_{21}\text{SNR}_{22}}. \quad (24)$$

4.1 Case With Feedback

The maximum individual information rate of transmitter i , with $i \in \{1, 2\}$, denoted by $R_i^{\text{FB}}(b)$, in the G-MAC-F(b) is the solution to an optimization problem of the form

$$R_i^{\text{FB}}(b) = \max_{(R_1, R_2, B) \in \mathcal{E}_b^{\text{FB}}(\text{SNR}_{11}, \text{SNR}_{12}, \text{SNR}_{21}, \text{SNR}_{22})} R_i. \quad (25)$$

The solution to (25) is given by the following proposition.

Proposition 1 (Maximum Individual Information Rates of the G-MAC-F(b)). *The maximum individual information rate of transmitter i in a G-MAC-F(b) is given by*

$$R_i^{\text{FB}}(b) = \frac{1}{2} \log_2(1 + (1 - \xi(b)^2) \text{SNR}_{1i}), \quad i \in \{1, 2\}, \quad (26)$$

with $\xi(b) \in [0, 1]$ defined in (23).

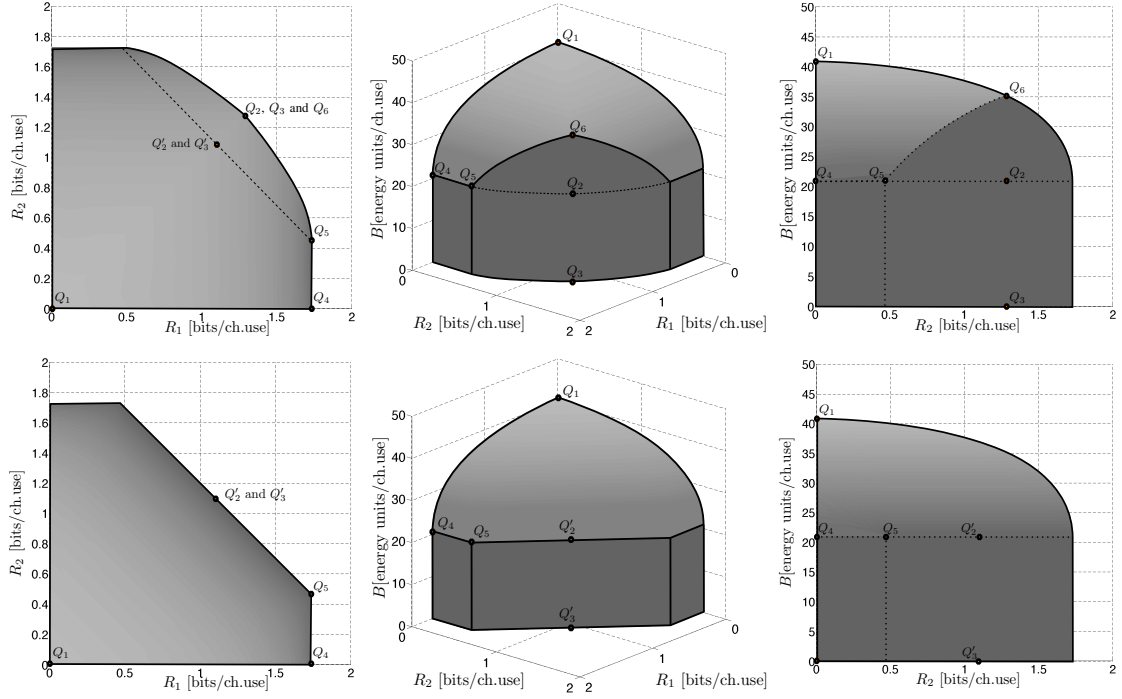

Figure 3: 3-D representation of the information-energy capacity region of the G-MAC-F(b) (top figures) and G-MAC(b) (bottom figures), $\mathcal{E}_0^{\text{FB}}(10, 10, 10, 10)$ and $\mathcal{E}_0(10, 10, 10, 10)$, respectively, with $b = 0$, in the coordinate system (R_1, R_2, B) . In each case, the figure in the center is a 3-D representation of the information-energy capacity region, whereas left and right figures represent a bi-dimensional view in the R_1 - R_2 and B - R_2 planes, respectively. Note that $Q_1 = (0, 0, 1 + \text{SNR}_{21} + \text{SNR}_{22} + 2\sqrt{\text{SNR}_{21}\text{SNR}_{22}})$. Points Q_1, Q_2, Q_3, Q_6, Q'_2 , and Q'_3 are coplanar and satisfy $R_1 = R_2$. Points Q'_2 and Q'_3 satisfy $R_1 = R_2 = \frac{1}{4} \log_2(1 + \text{SNR}_{11} + \text{SNR}_{12})$. Points Q_2, Q_3 , and Q_6 are collinear and satisfy $R_1 + R_2 = \frac{1}{2} \log_2(1 + \text{SNR}_{11} + \text{SNR}_{12} + 2\rho^*(1, 1)\sqrt{\text{SNR}_{11}\text{SNR}_{12}})$. The points Q_2, Q'_2, Q_4 , and Q_5 are coplanar and they satisfy $B = 1 + \text{SNR}_{21} + \text{SNR}_{22}$. In particular, $Q_4 = (\frac{1}{2} \log_2(1 + \text{SNR}_{11}), 0, 1 + \text{SNR}_{21} + \text{SNR}_{22})$ and $Q_5 = (\frac{1}{2} \log_2(1 + \text{SNR}_{11}), \frac{1}{2} \log_2(1 + \frac{\text{SNR}_{11}}{1 + \text{SNR}_{12}}), 1 + \text{SNR}_{21} + \text{SNR}_{22})$.

Proof: The proof of Proposition 1 is provided in Appendix C. ■

4.2 Case Without Feedback

The maximum individual information rate of transmitter i in the G-MAC(b), with $i \in \{1, 2\}$, denoted by $R_i^{\text{NF}}(b)$, is the solution to an optimization problem of the form

$$R_i^{\text{NF}}(b) = \max_{(R_1, R_2, B) \in \mathcal{E}_b(\text{SNR}_{11}, \text{SNR}_{12}, \text{SNR}_{21}, \text{SNR}_{22})} R_i. \quad (27)$$

The solution to (27) is given by the following proposition.

Proposition 2 (Maximum Individual Information Rates of the G-MAC(b)). *The maximum individual information rate of transmitter i in a G-MAC(b) is given by*

$$R_i^{\text{NF}}(b) = R_i^{\text{FB}}(b), \quad i \in \{1, 2\}. \quad (28)$$

Proof: The proof of Proposition 2 is presented in Appendix D. ■

That is, the maximum individual information rates in the G-MAC-F(b) and in the G-MAC(b) coincide.

5 Maximum Information Sum-Rate Given a Minimum Energy Rate Constraint

In this section, for any fixed non-negative SNR_{11} , SNR_{12} , SNR_{21} , and SNR_{22} , and for any b satisfying (11), the information sum-capacity (i.e., the maximum information sum-rate) is identified in the G-MAC-F(b) and in the G-MAC(b).

5.1 Case With Feedback

The perfect feedback information sum-capacity $R_{\text{sum}}^{\text{FB}}(b)$ of the G-MAC-F(b) is the solution to an optimization problem of the form

$$R_{\text{sum}}^{\text{FB}}(b) = \max_{(R_1, R_2, B) \in \mathcal{E}_b^{\text{FB}}(\text{SNR}_{11}, \text{SNR}_{12}, \text{SNR}_{21}, \text{SNR}_{22})} R_1 + R_2. \quad (29)$$

The solution to (29) is given by the following proposition.

Proposition 3 (Information Sum-Capacity of the G-MAC-F(b)). *The information sum-capacity of the G-MAC-F(b) is*

1. $\forall b \in [0, 1 + \text{SNR}_{21} + \text{SNR}_{22} + 2\rho^*(1, 1)\sqrt{\text{SNR}_{21}\text{SNR}_{22}}]$,

$$R_{\text{sum}}^{\text{FB}}(b) = \frac{1}{2} \log_2(1 + \text{SNR}_{11} + \text{SNR}_{12} + 2\rho^*(1, 1)\sqrt{\text{SNR}_{11}\text{SNR}_{12}}); \quad (30)$$

2. $\forall b \in (1 + \text{SNR}_{21} + \text{SNR}_{22} + 2\rho^*(1, 1)\sqrt{\text{SNR}_{21}\text{SNR}_{22}}, 1 + \text{SNR}_{21} + \text{SNR}_{22} + 2\sqrt{\text{SNR}_{21}\text{SNR}_{22}})$,

$$R_{\text{sum}}^{\text{FB}}(b) = \frac{1}{2} \log_2(1 + (1 - \xi(b)^2)\text{SNR}_{11}) + \frac{1}{2} \log_2(1 + (1 - \xi(b)^2)\text{SNR}_{12}); \quad (31)$$

$$3. \forall b \in [1 + \text{SNR}_{21} + \text{SNR}_{22} + 2\sqrt{\text{SNR}_{21}\text{SNR}_{22}}, \infty],$$

$$R_{\text{sum}}^{\text{FB}}(b) = 0, \quad (32)$$

where $\rho^*(1, 1)$ denotes the unique solution in $(0, 1)$ to (20) with $\beta_1 = \beta_2 = 1$ and the function $\xi(b)$ is defined in (23).

Proof: The proof of Proposition 3 is presented in Appendix E. ■

5.2 Case Without Feedback

The information sum-capacity $R_{\text{sum}}^{\text{NF}}(b)$ of the G-MAC(b) is the solution to an optimization problem of the form

$$R_{\text{sum}}^{\text{NF}}(b) = \max_{(R_1, R_2, B) \in \mathcal{E}_b(\text{SNR}_{11}, \text{SNR}_{12}, \text{SNR}_{21}, \text{SNR}_{22})} R_1 + R_2. \quad (33)$$

The solution to (33) is given by the following proposition.

Proposition 4 (Information Sum-Capacity of the G-MAC(b)). *The information sum-capacity of the G-MAC(b) is*

$$1. \forall b \in \left[0, 1 + \text{SNR}_{21} + \text{SNR}_{22} + 2\sqrt{\text{SNR}_{21}\text{SNR}_{22}} \min \left\{ \sqrt{\frac{\text{SNR}_{12}}{\text{SNR}_{11}}}, \sqrt{\frac{\text{SNR}_{11}}{\text{SNR}_{12}}} \right\} \right]$$

$$R_{\text{sum}}^{\text{NF}}(b) = \frac{1}{2} \log_2 \left(1 + \text{SNR}_{11} + \text{SNR}_{12} - 2\xi(b)\sqrt{\text{SNR}_{11}\text{SNR}_{12}} \right), \quad (34)$$

$$2. \forall b \in \left(1 + \text{SNR}_{21} + \text{SNR}_{22} + 2\sqrt{\text{SNR}_{21}\text{SNR}_{22}} \min \left\{ \sqrt{\frac{\text{SNR}_{12}}{\text{SNR}_{11}}}, \sqrt{\frac{\text{SNR}_{11}}{\text{SNR}_{12}}} \right\}, 1 + \text{SNR}_{21} + \text{SNR}_{22} + 2\sqrt{\text{SNR}_{21}\text{SNR}_{22}} \right]$$

$$R_{\text{sum}}^{\text{NF}}(b) = \frac{1}{2} \log_2 \left(1 + (1 - \xi(b)^2) \text{SNR}_{1i} \right), \quad (35)$$

with $i = \underset{k \in \{1, 2\}}{\text{argmax}} \text{SNR}_{1k}$,

$$3. \forall b \in [1 + \text{SNR}_{21} + \text{SNR}_{22} + 2\sqrt{\text{SNR}_{21}\text{SNR}_{22}}, \infty]$$

$$R_{\text{sum}}^{\text{NF}}(b) = 0, \quad (36)$$

with the function $\xi(b)$ defined in (23).

Proof: The proof is presented in Appendix F. ■

From Propositions 3 and 4, it can be seen that in the case with feedback, both users might transmit information and energy simultaneously as feedback creates signal correlation, which allows the system to meet the minimum energy rate. That is, the correlation induced by the use of the feedback is beneficial to both information transmission and energy transmission. Alternatively, in the case without feedback, artificial correlation via common randomness is required to meet the energy rate constraint. Such a correlation only benefits the energy transmission task and comes at the expense of the information transmission task as the information sum-rate is necessarily reduced. For instance, one way of achieving (35) is when the transmitter with the lowest SNR uses common randomness at its maximum power (transmits only energy), while the other transmitter transmits both energy and information.

Remark 2. *Optimally alternating transmission of energy and information does not always achieve information sum-capacity of the G-MAC(b) for a given minimum received energy rate constraint b .*

To verify Remark 2, consider the sum-rate optimization problem proposed in [6] in which both users alternate between information and energy transmission. Specifically, during a fraction of time $\lambda \in [0, 1]$, transmitter i sends an IC signal with power P'_i and during the remaining fraction of time it sends an NIC signal with power P''_i . Thus, the sum-rate optimal time-sharing parameter λ and power control vector $(P'_1, P'_2, P''_1, P''_2)$ are solutions to the optimization problem

$$\max_{(\lambda, P'_1, P''_1, P'_2, P''_2) \in [0, 1] \times \mathbb{R}_+^4} \frac{\lambda}{2} \log_2 (1 + h_{11}^2 P'_1 + h_{12}^2 P'_2) \quad (37a)$$

subject to :

$$\lambda P'_i + (1 - \lambda) P''_i \leq P_i, \quad i \in \{1, 2\} \quad (37b)$$

$$1 + \lambda(h_{21}^2 P'_1 + h_{22}^2 P'_2) + (1 - \lambda)(h_{21} \sqrt{P''_1} + h_{22} \sqrt{P''_2})^2 \geq b, \quad (37c)$$

where P_i is the total power budget of transmitter i .

For any feasible choice of $(\lambda, P'_1, P''_1, P'_2, P''_2)$, by the concavity of the logarithm, it follows that:

$$\frac{\lambda}{2} \log_2 (1 + h_{11}^2 P'_1 + h_{12}^2 P'_2) \leq \frac{1}{2} \log_2 (1 + \lambda(h_{11}^2 P'_1 + h_{12}^2 P'_2)). \quad (38)$$

Note that for $\lambda \neq 1$, the inequality in (38) is strict and the rate $\frac{1}{2} \log_2 (1 + \lambda(h_{11}^2 P'_1 + h_{12}^2 P'_2))$ is always achievable by a power-splitting scheme in which $\beta_i = \lambda \frac{P'_i}{P_i}$, with $i \in \{1, 2\}$, for any optimal tuple $(\lambda, P'_1, P''_1, P'_2, P''_2)$ in (37). This shows that the maximum information sum-rate achieved via alternating energy and information transmission is always bounded away from the information sum-capacity (Proposition 4). When $\lambda = 1$, exclusively transmitting information satisfies the energy rate constraint, i.e., $b \in [0, 1 + \text{SNR}_{21} + \text{SNR}_{22}]$.

6 Comments on the Shape of the Information-Energy Capacity Region

In this section, observations on the shape of the volumes $\mathcal{E}_0^{\text{FB}}(\text{SNR}_{11}, \text{SNR}_{12}, \text{SNR}_{21}, \text{SNR}_{22})$ and $\mathcal{E}_0(\text{SNR}_{11}, \text{SNR}_{12}, \text{SNR}_{21}, \text{SNR}_{22})$ are presented.

For a given $k \in \mathbb{N}$, let $\mathcal{B}(b_k) \subset \mathbb{R}_+^2$ be a two-dimensional set of the form

$$\mathcal{B}(b_k) = \left\{ (R_1, R_2) \in \mathbb{R}_+^2 : R_i \leq \frac{1}{2} \log_2 (1 + (1 - \xi(b_k))^2 \text{SNR}_{1i}), i \in \{1, 2\} \right\}. \quad (39)$$

6.1 Case With Feedback

Fig. 4 shows a general example of the intersection of the volume $\mathcal{E}_0^{\text{FB}}(\text{SNR}_{11}, \text{SNR}_{12}, \text{SNR}_{21}, \text{SNR}_{22})$, in the Cartesian coordinates (R_1, R_2, B) , with the planes $B = b_k$, with $k \in \{0, 1, 2, 3\}$, such that $b_0 \in [0, 1 + \text{SNR}_{21} + \text{SNR}_{22}]$, $b_1 \in [1 + \text{SNR}_{21} + \text{SNR}_{22}, 1 + \text{SNR}_{21} + \text{SNR}_{22} + 2\rho^*(1, 1)\sqrt{\text{SNR}_{21}\text{SNR}_{22}}]$, $b_2 = 1 + \text{SNR}_{21} + \text{SNR}_{22} + 2\rho^*(1, 1)\sqrt{\text{SNR}_{21}\text{SNR}_{22}}$, and $b_3 \in [1 + \text{SNR}_{21} + \text{SNR}_{22} + 2\rho^*(1, 1)\sqrt{\text{SNR}_{21}\text{SNR}_{22}}, 1 + \text{SNR}_{21} + \text{SNR}_{22} + 2\sqrt{\text{SNR}_{21}\text{SNR}_{22}}]$.

Case 1: $\mathbf{b}_0 \in [0, 1 + \text{SNR}_{21} + \text{SNR}_{22}]$. In this case, any intersection of the volume $\mathcal{E}_0^{\text{FB}}(\text{SNR}_{11}, \text{SNR}_{12}, \text{SNR}_{21}, \text{SNR}_{22})$, in the Cartesian coordinates (R_1, R_2, B) , with a plane $B = b_0$ corresponds to the set of triplets (R_1, R_2, b_0) , in which the corresponding pairs (R_1, R_2) form a set that is identical to the information capacity region of the G-MAC-F (without EH), denoted

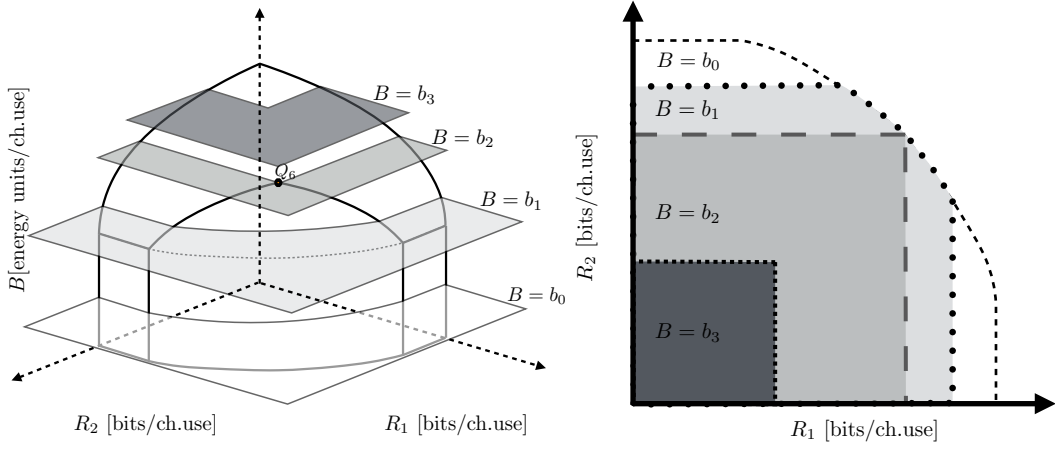

Figure 4: Intersection of the the information-energy capacity region of the G-MAC-F(O), $\mathcal{E}_0^{\text{FB}}(\text{SNR}_{11}, \text{SNR}_{12}, \text{SNR}_{21}, \text{SNR}_{22})$, with the planes $B = b_0$, $B = b_1$, $B = b_2$ and $B = b_3$ where $b_0 \in [0, 1 + \text{SNR}_{21} + \text{SNR}_{22}]$, $b_1 \in [1 + \text{SNR}_{21} + \text{SNR}_{22}, 1 + \text{SNR}_{21} + \text{SNR}_{22} + 2\rho^*(1, 1)\sqrt{\text{SNR}_{21}\text{SNR}_{22}}]$, $b_2 = 1 + \text{SNR}_{21} + \text{SNR}_{22} + 2\rho^*(1, 1)\sqrt{\text{SNR}_{21}\text{SNR}_{22}}$, and $b_3 \in [1 + \text{SNR}_{21} + \text{SNR}_{22} + 2\rho^*(1, 1)\sqrt{\text{SNR}_{21}\text{SNR}_{22}}, 1 + \text{SNR}_{21} + \text{SNR}_{22} + 2\sqrt{\text{SNR}_{21}\text{SNR}_{22}}]$.

by $\mathcal{C}_{\text{FB}}(\text{SNR}_{11}, \text{SNR}_{12})$. Note that this intersection is the base of the information-energy capacity region $\mathcal{E}_{b_0}^{\text{FB}}(\text{SNR}_{11}, \text{SNR}_{12}, \text{SNR}_{21}, \text{SNR}_{22})$ of the G-MAC-F(b_0). In this case, $\xi(b_0) = 0$, and thus from Proposition 1 and Proposition 3, the energy constraint does not add any additional bound on the individual rates and sum-rate other than (17a), (17b), and (17c). That is, the minimum energy transmission rate requirement can always be met by exclusively transmitting information.

Case 2: $b_1 \in [1 + \text{SNR}_{21} + \text{SNR}_{22}, 1 + \text{SNR}_{21} + \text{SNR}_{22} + 2\rho^*(1, 1)\sqrt{\text{SNR}_{21}\text{SNR}_{22}}]$. In this case, any intersection of the volume $\mathcal{E}_0^{\text{FB}}(\text{SNR}_{11}, \text{SNR}_{12}, \text{SNR}_{21}, \text{SNR}_{22})$ with a plane $B = b_1$ is a set of triplets (R_1, R_2, b_1) for which the corresponding pairs (R_1, R_2) satisfy $(R_1, R_2) \in \mathcal{B}(b_1) \cap \mathcal{C}_{\text{FB}}(\text{SNR}_{11}, \text{SNR}_{12})$, which forms a strict subset of $\mathcal{C}_{\text{FB}}(\text{SNR}_{11}, \text{SNR}_{12})$. This intersection coincides with the base of the information-energy capacity region $\mathcal{E}_{b_1}^{\text{FB}}(\text{SNR}_{11}, \text{SNR}_{12}, \text{SNR}_{21}, \text{SNR}_{22})$ of the G-MAC-F(b_1). Note that $\xi(b_1) > 0$, and thus from Proposition 1, the energy constraint limits the individual rates. That is, transmitter i 's individual information rate is bounded away from $\frac{1}{2} \log_2(1 + \text{SNR}_{1i})$. Nevertheless, it is important to highlight that in this case, $\xi(b_1) \leq \rho^*(1, 1)$, and thus the individual rates $R_1 = \frac{1}{2} \log_2\left(1 + \left(1 - (\rho^*(1, 1))^2\right) \text{SNR}_{11}\right)$ and $R_2 = \frac{1}{2} \log_2\left(1 + \left(1 - (\rho^*(1, 1))^2\right) \text{SNR}_{12}\right)$ are always achievable. Hence, this intersection always includes the triplet (R_1, R_2, b_1) , with $R_1 + R_2 = \frac{1}{2} \log_2(1 + \text{SNR}_{11} + \text{SNR}_{12} + 2\rho^*(1, 1)\sqrt{\text{SNR}_{11}\text{SNR}_{12}}) = R_{\text{sum}}^{\text{FB}}(b_1) = R_{\text{sum}}^{\text{FB}}(0)$. That is, the power-split $\beta_1 = \beta_2 = 1$ is always feasible. Note that the intersection of the volume $\mathcal{E}_0^{\text{FB}}(\text{SNR}_{11}, \text{SNR}_{12}, \text{SNR}_{21}, \text{SNR}_{22})$ with the plane $B = b_2$ is a particular case of this regime.

Case 3: $b_3 \in [1 + \text{SNR}_{21} + \text{SNR}_{22} + 2\rho^*(1, 1)\sqrt{\text{SNR}_{21}\text{SNR}_{22}}, 1 + \text{SNR}_{21} + \text{SNR}_{22} + 2\sqrt{\text{SNR}_{21}\text{SNR}_{22}}]$. In this case, any intersection of the volume $\mathcal{E}_0^{\text{FB}}(\text{SNR}_{11}, \text{SNR}_{12}, \text{SNR}_{21}, \text{SNR}_{22})$ with a plane $B = b_3$ is a set of triplets (R_1, R_2, b_3) for which the corresponding pairs (R_1, R_2) satisfy $(R_1, R_2) \in \mathcal{B}(b_3) = \mathcal{B}(b_3) \cap \mathcal{C}_{\text{FB}}(\text{SNR}_{11}, \text{SNR}_{12})$, which is a strict subset of $\mathcal{C}_{\text{FB}}(\text{SNR}_{11}, \text{SNR}_{12})$. This intersection coincides with the base of the information-energy capacity region

$\mathcal{E}_{b_3}^{\text{FB}}(\text{SNR}_{11}, \text{SNR}_{12}, \text{SNR}_{21}, \text{SNR}_{22})$ of the G-MAC-F(b_3). Note that $\rho^*(1, 1) < \xi(b_3) \leq 1$, and thus from Proposition 1, the individual information rates are limited by $R_i \leq \frac{1}{2} \log_2(1 + (1 - \xi(b_3)^2) \text{SNR}_{1i}) < \frac{1}{2} \log_2(1 + (1 - (\rho^*(1, 1))^2) \text{SNR}_{1i})$. For any $b_3 > 1 + \text{SNR}_{21} + \text{SNR}_{22} + 2\rho^*(1, 1)\sqrt{\text{SNR}_{21}\text{SNR}_{22}}$, the set $\mathcal{B}(b_3)$ monotonically shrinks with b_3 . Consequently, for these values of b_3 , there exists a loss of sum-rate and $R_{\text{sum}}^{\text{FB}}(0)$ is not achievable. Nonetheless, note that $R_{\text{sum}}^{\text{FB}}(b_3)$ is a continuous function in b_3 . When $b_3 = 1 + \text{SNR}_{21} + \text{SNR}_{22} + 2(\rho^*(1, 1) + \epsilon)\sqrt{\text{SNR}_{21}\text{SNR}_{22}}$, for some $\epsilon > 0$, it holds that $\xi(b_3) = \rho^*(1, 1) + \epsilon$. Substituting this into (31) and taking the limit when ϵ tends to 0, by the definition of $\rho^*(1, 1)$, the resulting value is given by (30). Clearly, the maximum energy rate is achieved when $\beta_1 = \beta_2 = 0$, which implies that no information is conveyed from the transmitters to the receiver.

6.2 Case Without Feedback

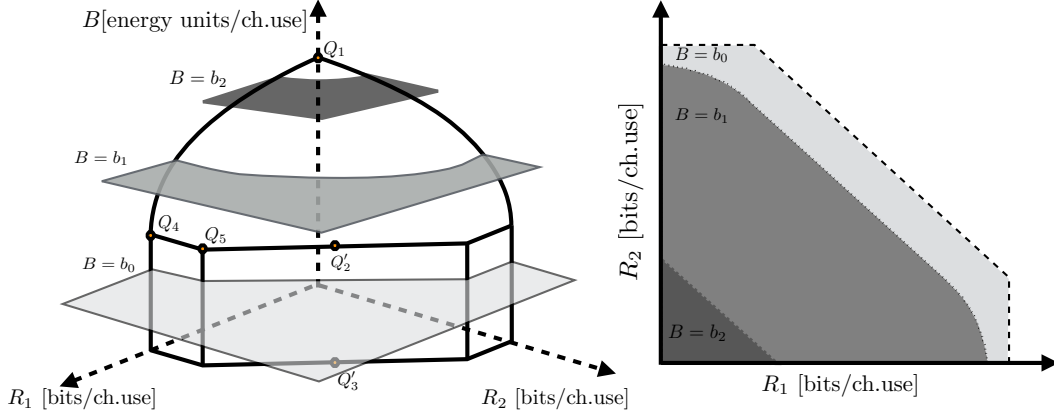

Figure 5: Intersection of the information-energy capacity region of the G-MAC(0), $\mathcal{E}_0(\text{SNR}_{11}, \text{SNR}_{12}, \text{SNR}_{21}, \text{SNR}_{22})$, with the planes $B = b_0$, $B = b_1$, and $B = b_2$, where $b_0 \in [0, 1 + \text{SNR}_{21} + \text{SNR}_{22}]$, $b_1 \in \left(1 + \text{SNR}_{21} + \text{SNR}_{22}, 1 + \text{SNR}_{21} + \text{SNR}_{22} + 2\sqrt{\text{SNR}_{21}\text{SNR}_{22}} \min\left\{\sqrt{\frac{\text{SNR}_{12}}{\text{SNR}_{11}}}, \sqrt{\frac{\text{SNR}_{11}}{\text{SNR}_{12}}}\right\}\right]$, and $b_2 \in \left(1 + \text{SNR}_{21} + \text{SNR}_{22} + 2\sqrt{\text{SNR}_{21}\text{SNR}_{22}} \min\left\{\sqrt{\frac{\text{SNR}_{12}}{\text{SNR}_{11}}}, \sqrt{\frac{\text{SNR}_{11}}{\text{SNR}_{12}}}\right\}, 1 + \text{SNR}_{21} + \text{SNR}_{22} + 2\sqrt{\text{SNR}_{21}\text{SNR}_{22}}\right]$.

Fig. 5 shows a general example of the intersection of the volume $\mathcal{E}_0(\text{SNR}_{11}, \text{SNR}_{12}, \text{SNR}_{21}, \text{SNR}_{22})$, in the Cartesian coordinates (R_1, R_2, B) , with the planes $B = b_k$, with $k \in \{0, 1, 2\}$, such that $b_0 \in [0, 1 + \text{SNR}_{21} + \text{SNR}_{22}]$, $b_1 \in \left(1 + \text{SNR}_{21} + \text{SNR}_{22}, 1 + \text{SNR}_{21} + \text{SNR}_{22} + 2\sqrt{\text{SNR}_{21}\text{SNR}_{22}} \min\left\{\sqrt{\frac{\text{SNR}_{12}}{\text{SNR}_{11}}}, \sqrt{\frac{\text{SNR}_{11}}{\text{SNR}_{12}}}\right\}\right]$, and $b_2 \in \left(1 + \text{SNR}_{21} + \text{SNR}_{22} + 2\sqrt{\text{SNR}_{21}\text{SNR}_{22}} \min\left\{\sqrt{\frac{\text{SNR}_{12}}{\text{SNR}_{11}}}, \sqrt{\frac{\text{SNR}_{11}}{\text{SNR}_{12}}}\right\}, 1 + \text{SNR}_{21} + \text{SNR}_{22} + 2\sqrt{\text{SNR}_{21}\text{SNR}_{22}}\right]$.

Case 1: $b_0 \in [0, 1 + \text{SNR}_{21} + \text{SNR}_{22}]$. In this case, any intersection of the volume $\mathcal{E}_0(\text{SNR}_{11}, \text{SNR}_{12}, \text{SNR}_{21}, \text{SNR}_{22})$, in the Cartesian coordinates (R_1, R_2, B) , with a plane $B = b_0$ corresponds to the set of triplets (R_1, R_2, b_0) , in which the corresponding pairs (R_1, R_2) form a set that is identical to the information capacity region of the G-MAC (without EH), denoted by $\mathcal{C}(\text{SNR}_{11}, \text{SNR}_{12})$. This intersection is the base of the information-energy capacity region

$\mathcal{E}_{b_0}(\text{SNR}_{11}, \text{SNR}_{12}, \text{SNR}_{21}, \text{SNR}_{22})$ of the G-MAC(b_0). Note that $\xi(b_0) = 0$, and thus from Proposition 2 and Proposition 4, it holds that $R_i^{\text{NF}}(b_0) = \frac{1}{2} \log_2(1 + \text{SNR}_{1i})$, for $i \in \{1, 2\}$, and $R_{\text{sum}}^{\text{NF}}(b_0) = \frac{1}{2} \log_2(1 + \text{SNR}_{11} + \text{SNR}_{12})$. Hence, exclusively transmitting information is enough for satisfying the energy rate constraint b_0 .

Case 2: $\mathbf{b}_1 \in \left(\mathbf{1} + \text{SNR}_{21} + \text{SNR}_{22} + 2\sqrt{\text{SNR}_{21}\text{SNR}_{22}} \min\left\{ \sqrt{\frac{\text{SNR}_{12}}{\text{SNR}_{11}}}, \sqrt{\frac{\text{SNR}_{11}}{\text{SNR}_{12}}} \right\} \right]$.

In this case, any intersection of the volume $\mathcal{E}_0(\text{SNR}_{11}, \text{SNR}_{12}, \text{SNR}_{21}, \text{SNR}_{22})$, in the Cartesian coordinates (R_1, R_2, B) , with a plane $B = b_1$ corresponds to the set of triplets (R_1, R_2, b_1) in which the corresponding pairs (R_1, R_2) form a set that is equivalent to a strict subset of the information capacity region of the G-MAC $\mathcal{C}(\text{SNR}_{11}, \text{SNR}_{12})$. This intersection is the base of the information-energy capacity region $\mathcal{E}_{b_1}(\text{SNR}_{11}, \text{SNR}_{12}, \text{SNR}_{21}, \text{SNR}_{22})$ of the G-MAC(b_1). Note that $\xi(b_1) > 0$, and thus from Proposition 2 and Proposition 4, $R_i^{\text{NF}}(b_1)$ and $R_{\text{sum}}^{\text{NF}}(b_1)$ decrease with b_1 . This is mainly due to the fact that part of each transmitter's power budget is dedicated to the transmission of energy. Furthermore, the information sum-rate optimal strategy involves information transmission at both users since the sum-capacity is strictly larger than the maximum individual rate of the user with the highest SNR.

Case 3: $\mathbf{b}_2 \in \left(\mathbf{1} + \text{SNR}_{21} + \text{SNR}_{22} + 2\sqrt{\text{SNR}_{21}\text{SNR}_{22}} \min\left\{ \sqrt{\frac{\text{SNR}_{12}}{\text{SNR}_{11}}}, \sqrt{\frac{\text{SNR}_{11}}{\text{SNR}_{12}}} \right\}, \mathbf{1} + \text{SNR}_{21} + \text{SNR}_{22} + 2\sqrt{\text{SNR}_{21}\text{SNR}_{22}} \right]$.

In this case, any intersection of the volume $\mathcal{E}_0(\text{SNR}_{11}, \text{SNR}_{12}, \text{SNR}_{21}, \text{SNR}_{22})$, in the Cartesian coordinates (R_1, R_2, B) , with a plane $B = b_2$ corresponds to the set of triplets (R_1, R_2, b_2) in which the corresponding pairs (R_1, R_2) form a set that is equivalent to a strict subset of the information capacity region of the G-MAC, $\mathcal{C}(\text{SNR}_{11}, \text{SNR}_{12})$. This intersection is the base of the information-energy capacity $\mathcal{E}_{b_2}(\text{SNR}_{11}, \text{SNR}_{12}, \text{SNR}_{21}, \text{SNR}_{22})$ region of the G-MAC(b_2). The information sum-capacity corresponds to the maximum individual rate (Proposition 2) of the transmitter with the highest SNR. That is, in order to maximize the information sum-rate, it is optimal to have information transmission exclusively at the stronger user with the highest SNR. The transmitter with the weakest SNR uses all its power budget to exclusively transmit energy. Note that when the receiver and the EH are co-located and when the channel is symmetric, this is not observed.

7 Energy Transmission Enhancement With Feedback

In this section, the enhancement on the energy transmission rate due to the use of feedback is quantified when the information sum-rate is $R_{\text{sum}}^{\text{NF}}(0)$ (see the blue triangles and orange squares in Fig. 6).

Denote by $B_{\text{NF}} = 1 + \text{SNR}_{21} + \text{SNR}_{22}$ the maximum energy rate that can be guaranteed at the EH in the G-MAC(0) when the information sum-rate is $R_{\text{sum}}^{\text{NF}}(0)$. Denote also by B_{FB} the maximum energy rate that can be guaranteed at the EH in the G-MAC-F(0) when the information sum-rate is $R_{\text{sum}}^{\text{NF}}(0)$. The exact value of B_{FB} is the solution to an optimization problem of the form

$$\begin{aligned} B_{\text{FB}} &= \max B \\ \text{subject to: } & R_{\text{sum}}^{\text{FB}}(B) = R_{\text{sum}}^{\text{NF}}(0). \end{aligned} \quad (40)$$

The solution to (40) is given by the following theorem.

Theorem 3. *The maximum energy rate B_{FB} that can be guaranteed at the EH in the G-MAC-F(0) when the information sum-rate is $R_{\text{sum}}^{\text{NF}}(0)$ is*

$$B_{\text{FB}} = 1 + \text{SNR}_{21} + \text{SNR}_{22} + 2\sqrt{(1 - \gamma)\text{SNR}_{21}\text{SNR}_{22}}, \quad (41)$$

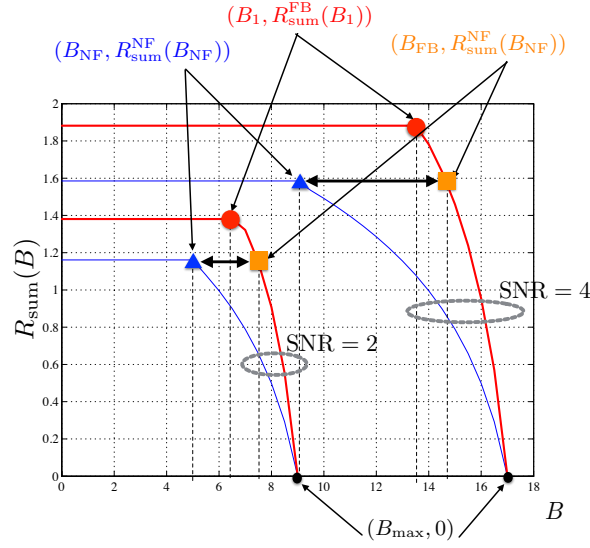

Figure 6: Information sum-capacity of the symmetric two-user memoryless G-MAC-F(0) (thick red line) and G-MAC(0) (thin blue line), with co-located receiver and EH, with $\text{SNR}_{11} = \text{SNR}_{12} = \text{SNR}_{21} = \text{SNR}_{22} = \text{SNR}$, as a function of B . Red (big) circles represent the pairs $(B_1, R_{\text{sum}}^{\text{FB}}(B_1))$ in which $R_{\text{sum}}^{\text{FB}}(B_1)$ is the information sum-capacity with feedback when only information transmission is performed and $B_1 \triangleq 1 + 2(1 + \rho^*(1, 1))\text{SNR}$ represents the corresponding maximum energy rate that can be guaranteed at the EH. Blue triangles represent the pairs $(B_{\text{NF}}, R_{\text{sum}}^{\text{NF}}(B_{\text{NF}}))$ in which $R_{\text{sum}}^{\text{NF}}(B_{\text{NF}})$ is the information sum-capacity without feedback and $B_{\text{NF}} \triangleq 1 + 2\text{SNR}$ is the corresponding maximum energy rate that can be guaranteed at the EH without feedback. Orange squares represent the pairs $(B_{\text{FB}}, R_{\text{sum}}^{\text{NF}}(B_{\text{FB}}))$ in which B_{FB} is the corresponding maximum energy rate that can be guaranteed at the EH with feedback. Black (small) circles represent the pairs $(B_{\text{max}}, 0)$ in which $B_{\text{max}} \triangleq 1 + 4\text{SNR}$ is the maximum energy rate at the EH.

with $\gamma \in (0, 1)$ defined as follows:

$$\gamma \triangleq \frac{\text{SNR}_{11} + \text{SNR}_{12}}{2\text{SNR}_{11}\text{SNR}_{12}} \left[\sqrt{1 + \frac{4\text{SNR}_{11}\text{SNR}_{12}}{\text{SNR}_{11} + \text{SNR}_{12}}} - 1 \right]. \quad (42)$$

Proof: The proof of Theorem 3 is presented in Appendix G. \blacksquare

To quantify the energy rate enhancement induced by feedback, it is of interest to consider the ratio $\frac{B_{\text{FB}}}{B_{\text{NF}}}$ given by

$$\frac{B_{\text{FB}}}{B_{\text{NF}}} = 1 + \frac{2\sqrt{(1 - \gamma)\text{SNR}_{21}\text{SNR}_{22}}}{1 + \text{SNR}_{21} + \text{SNR}_{22}}. \quad (43)$$

Note that the impact of the SNRs in the information transmission branch (SNR_{11} and SNR_{12}) are captured by γ .

Let $\nu_i \triangleq \frac{\text{SNR}_{1i}}{\text{SNR}_{1j}} \in \mathbb{R}_+$ and $\eta_i \triangleq \frac{\text{SNR}_{2i}}{\text{SNR}_{2j}} \in \mathbb{R}_+$, with $(i, j) \in \{1, 2\}^2$ and $i \neq j$ measure the asymmetry in the channel from the transmitters to the receiver and to the EH, respectively. Let also $\psi_i \triangleq \frac{\text{SNR}_{2i}}{\text{SNR}_{1i}} \in \mathbb{R}_+$ capture the strength ratio between the information and the energy channels of transmitter i .

With these parameters, γ in (42) can be rewritten as

$$\gamma = \frac{1 + \nu_i}{2\nu_i \text{SNR}_{1j}} \left[\sqrt{1 + \frac{4\nu_i \text{SNR}_{1j}}{1 + \nu_i}} - 1 \right], \quad (44)$$

with $(i, j) \in \{1, 2\}^2$ and $i \neq j$.

Note that, for all $(i, j) \in \{1, 2\}^2$ with $i \neq j$, when $\text{SNR}_{1j} \rightarrow 0$ while the ratio ν_i remains constant, from (44), it follows that

$$\lim_{\text{SNR}_{1j} \rightarrow 0} \gamma = 1. \quad (45)$$

Thus, when the SNRs in the information branch (SNR_{11} and SNR_{12}) are very low, the improvement on the energy transmission rate due to feedback is inexistent. This observation is independent of the SNRs in the EH branch (SNR_{21} and SNR_{22}).

Alternatively, when $\text{SNR}_{1j} \rightarrow \infty$ while the ratio ν_i remains constant, it follows that

$$\lim_{\text{SNR}_{1j} \rightarrow \infty} \gamma = 0. \quad (46)$$

Thus, when the SNRs in the information branch (SNR_{11} and SNR_{12}) are very high, the improvement on the energy transmission rate due to feedback is given by

$$\lim_{\text{SNR}_{1j} \rightarrow \infty} \frac{B_{\text{FB}}}{B_{\text{NF}}} = 1 + \frac{2\sqrt{\text{SNR}_{21}\text{SNR}_{22}}}{1 + \text{SNR}_{21} + \text{SNR}_{22}}. \quad (47)$$

More generally, using the above parameters, the ratio $\frac{B_{\text{FB}}}{B_{\text{NF}}}$ in (43) can be written as

$$\frac{B_{\text{FB}}}{B_{\text{NF}}} = 1 + \frac{2\psi_j \text{SNR}_{1j} \sqrt{\eta_i \left(1 - \left(\frac{1 + \nu_i}{2\nu_i \text{SNR}_{1j}} \left(\sqrt{1 + \frac{4\nu_i \text{SNR}_{1j}}{1 + \nu_i}} - 1 \right) \right) \right)}}{1 + (1 + \eta_i)\psi_j \text{SNR}_{1j}}. \quad (48)$$

Based on (48), the following corollary evaluates the very low SNR asymptotic energy enhancement with feedback.

Corollary 1. *For all $(i, j) \in \{1, 2\}^2$ with $i \neq j$, when $\text{SNR}_{1j} \rightarrow 0$ while the ratios ν_i, η_i , and ψ_i remain constant, it holds that*

$$\lim_{\text{SNR}_{1j} \rightarrow 0} \frac{B_{\text{FB}}}{B_{\text{NF}}} = 1, \quad (49)$$

and thus feedback does not enhance energy transmission at very low SNR.

In the very high SNR regime, the asymptotic energy enhancement with feedback is given by the following corollary that is also based on (48).

Corollary 2. *For all $(i, j) \in \{1, 2\}^2$ with $i \neq j$, when $\text{SNR}_{1j} \rightarrow \infty$ while the ratios ν_i, η_i , and ψ_i remain constant, the maximum energy rate improvement with feedback is given by*

$$\lim_{\text{SNR}_{1j} \rightarrow \infty} \frac{B_{\text{FB}}}{B_{\text{NF}}} = 1 + \frac{2\sqrt{\eta_i}}{1 + \eta_i}. \quad (50)$$

From Corollary 1 and Corollary 2, it holds that:

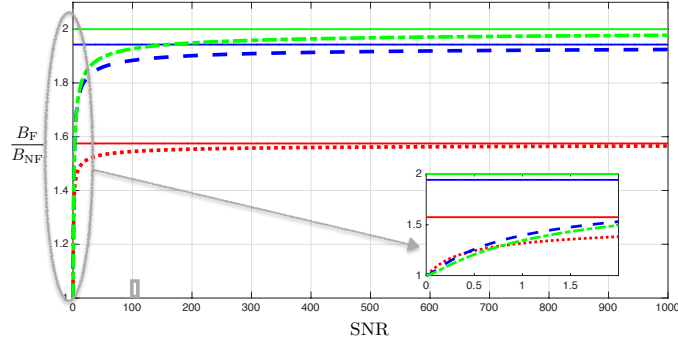

Figure 7: The ratio $\frac{B_{\text{FB}}}{B_{\text{NF}}}$ and its high-SNR limit as a function of SNR when the receiver and the EH are co-located and $\text{SNR}_{11} = \text{SNR}_{21} = \text{SNR}_1$ and $\text{SNR}_{12} = \text{SNR}_{22} = \text{SNR}_2$. The solid line is the high-SNR limit in (50); the dash-dotted line, the dashed line and the dotted line are the exact values of the ratio $\frac{B_{\text{FB}}}{B_{\text{NF}}}$ in (48) when $\text{SNR}_1 = \text{SNR}_2 = \text{SNR}$; $\frac{\text{SNR}_1}{2} = \text{SNR}_2 = \text{SNR}$; and $\frac{\text{SNR}_1}{10} = \text{SNR}_2 = \text{SNR}$, respectively.

Corollary 3. *Feedback can at most double the energy transmission rate:*

$$1 \leq \frac{B_{\text{FB}}}{B_{\text{NF}}} \leq 2, \quad (51)$$

where the upper-bound holds with equality when $\eta_i = 1$, i.e., $\text{SNR}_{21} = \text{SNR}_{22}$.

Fig. 7 compares the exact value of the ratio $\frac{B_{\text{FB}}}{B_{\text{NF}}}$ in (48) to the high-SNR limit in (50) as a function of the SNRs in the special case in which the receiver and the EH are co-located. This implies that the channel coefficients between the transmitters and the receiver are identical to those between the transmitters and the EH, i.e., $\text{SNR}_{11} = \text{SNR}_{21} = \text{SNR}_1$ and $\text{SNR}_{12} = \text{SNR}_{22} = \text{SNR}_2$. Note that in the symmetric case, i.e., $\text{SNR}_1 = \text{SNR}_2 = \text{SNR}$, the upper-bound in (50) is tight since the ratio $\frac{B_{\text{FB}}}{B_{\text{NF}}}$ becomes arbitrarily close to two as SNR tends to infinity. In the non-symmetric cases $\text{SNR}_1 \neq \text{SNR}_2$, this bound is loose.

8 Conclusion and Extensions

This report has characterized the information-energy capacity region of the two-user G-MAC with an EH, with and without feedback, and has determined the energy transmission enhancement induced by the use of feedback. An important conclusion of this work is that SEIT requires additional transmitter cooperation/coordination. From this viewpoint, any technique that allows transmitter cooperation (i.e., feedback, conferencing, etc.) is likely to provide performance gains in SEIT in general multi-user networks. The results on the energy transmission enhancement induced by feedback in the two-user G-MAC-F can be extended to the K -user G-MAC-F with EH for arbitrary $K \geq 3$.

A Proof of Theorem 1

The proof is divided into two parts: achievability and converse parts.

A.1 Proof of Achievability

The proof of achievability uses a very simple power-splitting technique in which a fraction $\beta_i \in [0, 1]$ of the power is used for information transmission and the remaining fraction $(1 - \beta_i)$ for energy transmission. The information transmission is made following Ozarow's perfect feedback capacity-achieving scheme in [24]. The energy transmission is accomplished by random symbols that are known at both transmitters and the receiver. Despite a great deal of similarity with the scheme in [24], the complete proof is fully described hereunder for the sake of completeness.

Codebook generation: At the beginning of the transmission, each message M_i is mapped into the real-valued message point

$$\Theta_i(M_i) \triangleq -(M_i - 1)\Delta_i + \sqrt{P_i}, \quad (52)$$

where

$$\Delta_i \triangleq \frac{2\sqrt{P_i}}{\lfloor 2^{nR_i} \rfloor}. \quad (53)$$

Encoding: The first three channel uses are part of an initialization procedure during which there is no energy transmission and the channel inputs are

$$t = -2 : X_{1,-2} = 0 \quad \text{and} \quad X_{2,-2} = \Theta_2(M_2), \quad (54a)$$

$$t = -1 : X_{1,-1} = \Theta_1(M_1) \quad \text{and} \quad X_{2,-1} = 0, \quad (54b)$$

$$t = 0 : X_{1,0} = 0 \quad \text{and} \quad X_{2,0} = 0. \quad (54c)$$

Through the feedback links, transmitter 1 observes (Z_{-1}, Z_0) and transmitter 2 observes (Z_{-2}, Z_0) . After the initialization phase, each transmitter $i \in \{1, 2\}$ can thus compute

$$\Xi_i \triangleq \sqrt{1 - \rho^*(\beta_1, \beta_2)} \cdot Z_{-i} + \sqrt{\rho^*(\beta_1, \beta_2)} \cdot Z_0, \quad (55)$$

where $\rho^*(\beta_1, \beta_2)$ is the unique solution in $(0, 1)$ to (20).

During the remaining channel uses $1, \dots, n$, for $i \in \{1, 2\}$, instead of repeating the message-point $\Theta_i(M_i)$, transmitter i simultaneously describes Ξ_i to the receiver and transmits energy to the EH. Let β_i , with $i \in \{1, 2\}$ be the power-splitting coefficient of transmitter i . More specifically, at each time $t \in \{1, \dots, n\}$, transmitter i sends

$$X_{i,t} = U_{i,t} + \sqrt{(1 - \beta_i)P_i}W_t, \quad i \in \{1, 2\}. \quad (56)$$

Here (W_1, \dots, W_n) is an independent and identically distributed (i.i.d.) sequence drawn according to a zero-mean unit-variance Gaussian distribution. This sequence is known non-causally to the transmitters and to the receiver and is independent of the messages and the noise sequences. The symbol $U_{i,t}$ is a zero-mean Gaussian random variable with variance $\beta_i P_i$ and is chosen as follows:

$$U_{i,1} = \sqrt{\beta_i P_i} \Xi_i, \quad (57a)$$

$$U_{i,t} = \gamma_{i,t} \left(\Xi_i - \hat{\Xi}_i^{(t-1)} \right), \quad t \in \{2, \dots, n\}, \quad (57b)$$

where the parameter $\gamma_{i,t}$ is chosen to satisfy $\mathbb{E}[U_{i,t}^2] = \beta_i P_i$ and $\hat{\Xi}_i^{(t-1)}$ is explained below.

For each $t \in \{1, \dots, n\}$, upon receiving the channel output $Y_{1,t}$, the receiver subtracts the signal induced by the common randomness to form the observation $Y'_{1,t}$ as follows:

$$Y'_{1,t} \triangleq Y_{1,t} - \left(h_{11}\sqrt{(1 - \beta_1)P_1} + h_{12}\sqrt{(1 - \beta_2)P_2} \right) W_t. \quad (58)$$

The receiver then calculates the minimum mean square error (MMSE) estimate $\hat{\Xi}_i^{(t-1)} = \mathbb{E}[\Xi_i | Y'_{1,1}, \dots, Y'_{1,t-1}]$ of Ξ_i given the prior observations $Y'_{1,1}, \dots, Y'_{1,t-1}$.

Remark 3. Note that by the orthogonality principle of MMSE estimation [28], $(U_{1,t}, U_{2,t}, Z_t)$ are independent of the observations $Y'_{1,1}, \dots, Y'_{1,t-1}$ and thus of $Y_{1,1}, \dots, Y_{1,t-1}$. Furthermore, since (W_1, \dots, W_n) are i.i.d., it holds that, for any $i \in \{1, 2\}$ and for any $t \in \{1, \dots, n\}$, $Y_{i,t}$ is independent of $Y_{i,1}, \dots, Y_{i,t-1}$.

Remark 4. Let ρ_t denote the correlation coefficient between $U_{1,t}$ and $U_{2,t}$, i.e., $\rho_t \triangleq \frac{\mathbb{E}[U_{1,t}U_{2,t}]}{\sqrt{\mathbb{E}[U_{1,t}^2]}\sqrt{\mathbb{E}[U_{2,t}^2]}}$. In [29, Lemma 17.1], it is proved that for all $t \in \{1, \dots, n\}$, $\rho_t = \rho^*(\beta_1, \beta_2)$, and thus $\rho^*(\beta_1, \beta_2)$ is the steady-state correlation coefficient.

After reception of the output symbols $Y_{1,-2}, \dots, Y_{1,n}$, the receiver forms $\hat{\Xi}_i^{(n)} \triangleq \mathbb{E}[\Xi_i | Y'_{1,1}, \dots, Y'_{1,n}]$, for $i \in \{1, 2\}$. Then, it forms an estimate $\hat{\Theta}_i^{(n)}$ of the message point $\Theta_i(M_i)$ as follows:

$$\begin{aligned} \hat{\Theta}_i^{(n)} &\triangleq \frac{1}{h_{1i}} \left(Y_{1,-i} + \sqrt{\frac{\rho^*(\beta_1, \beta_2)}{1 - \rho^*(\beta_1, \beta_2)}} Y_{1,0} - \frac{1}{\sqrt{1 - \rho^*(\beta_1, \beta_2)}} \hat{\Xi}_i^{(n)} \right) \\ &= \Theta_i(M_i) + \frac{1}{h_{1i}\sqrt{1 - \rho^*(\beta_1, \beta_2)}} \left(\Xi_i - \hat{\Xi}_i^{(n)} \right). \end{aligned} \quad (59)$$

Finally, the message index estimate M_i is obtained using nearest-neighbor decoding based on the value $\hat{\Theta}_i^{(n)}$, as follows:

$$\hat{M}_i^{(n)} = \underset{m_i \in \{1, \dots, \lfloor 2^{nR_i} \rfloor\}}{\operatorname{argmin}} |\Theta_i(m_i) - \hat{\Theta}_i^{(n)}|. \quad (60)$$

Analysis of the probability of error:

An error occurs whenever the receiver is not able to recover one of the messages, i.e., $(M_1, M_2) \neq (\hat{M}_1^{(n)}, \hat{M}_2^{(n)})$ or if the received energy rate is below the desired minimum rate $B^{(n)} < B$.

First, consider the probability of a decoding error. Note that for $i \in \{1, 2\}$, $\hat{M}_i^{(n)} = M_i$, if

$$|\Xi_i - \hat{\Xi}_i^{(n)}| \leq \frac{h_{1i}\sqrt{1 - \rho^*(\beta_1, \beta_2)}\Delta_i}{2}. \quad (61)$$

Since the difference $\Xi_i - \hat{\Xi}_i^{(n)}$ is a centered Gaussian random variable, by the definition of Δ_i in (53), the error probability $P_{e,i}^{(n)}$ while decoding message index M_i can be bounded as

$$P_{e,i}^{(n)} \leq 2\mathcal{Q} \left(\frac{\sqrt{\operatorname{SNR}_{1i}}\sqrt{1 - \rho^*(\beta_1, \beta_2)}}{\lfloor 2^{nR_i} \rfloor \sqrt{(\sigma_i^{(n)})^2}} \right), \quad (62)$$

where $\mathcal{Q}(x) = \frac{1}{\sqrt{2\pi}} \int_x^\infty \exp\left(-\frac{u^2}{2}\right) du$ is the tail of the unit Gaussian distribution evaluated at x and where

$$(\sigma_i^{(n)})^2 \triangleq \mathbb{E} \left[|\Xi_i - \hat{\Xi}_i^{(n)}|^2 \right], \quad i \in \{1, 2\}. \quad (63)$$

Note that

$$\begin{aligned} I(\Xi_i; \mathbf{Y}'_1) &= h(\Xi_i) - h(\Xi_i | \mathbf{Y}'_1) \\ &\stackrel{(a)}{=} h(\Xi_i) - h(\Xi_i - \hat{\Xi}_i^{(n)} | \mathbf{Y}'_1) \\ &\stackrel{(b)}{=} h(\Xi_i) - h(\Xi_i - \hat{\Xi}_i^{(n)}) \\ &= -\frac{1}{2} \log_2((\sigma_i^{(n)})^2), \end{aligned} \quad (64)$$

where (a) holds because by the joint Gaussianity of Ξ_i and \mathbf{Y}'_1 , the MMSE estimate $\hat{\Xi}_i^{(n)}$ is a linear function of \mathbf{Y}'_1 (see, e.g., [30]); (b) follows because by the orthogonality principle, the error $\Xi_i - \hat{\Xi}_i^{(n)}$ is independent of the observations \mathbf{Y}'_1 .

Equation (64) can equivalently be rewritten as

$$\sqrt{(\sigma_i^{(n)})^2} = 2^{-I(\Xi_i; \mathbf{Y}'_1)}. \quad (65)$$

Combining (62) with (65) yields that the probability of error of message M_i tends to 0 as $n \rightarrow \infty$, if the rate R_i satisfies

$$R_i \leq \liminf_{n \rightarrow \infty} \frac{1}{n} I(\Xi_i; \mathbf{Y}'_1), \quad i \in \{1, 2\}. \quad (66)$$

On the other hand, as proved in [29, Sec. 17.2.4],

$$I(\Xi_i; \mathbf{Y}'_1) = \sum_{t=1}^n I(U_{i,t}; Y'_{1,t}) \quad (67)$$

and irrespective of n and $t \in \{1, \dots, n\}$, it holds that

$$I(U_{i,t}; Y'_{1,t}) = \frac{1}{2} \log_2 \left(1 + \beta_i \text{SNR}_{1i} (1 - (\rho^*(\beta_1, \beta_2))^2) \right). \quad (68)$$

Hence, for $i \in \{1, 2\}$ it holds that

$$\liminf_{n \rightarrow \infty} \frac{1}{n} I(\Xi_i; \mathbf{Y}'_1) = \frac{1}{2} \log_2 \left(1 + \beta_i \text{SNR}_{1i} (1 - (\rho^*(\beta_1, \beta_2))^2) \right). \quad (69)$$

Combining (66) and (69) yields that when $n \rightarrow \infty$, this scheme can achieve all non-negative rate-pairs (R_1, R_2) that satisfy

$$R_1 \leq \frac{1}{2} \log_2 \left(1 + \beta_1 \text{SNR}_{11} (1 - \rho^*(\beta_1, \beta_2)^2) \right), \quad (70a)$$

$$R_2 \leq \frac{1}{2} \log_2 \left(1 + \beta_2 \text{SNR}_{12} (1 - \rho^*(\beta_1, \beta_2)^2) \right). \quad (70b)$$

Hence, combined with (20), it automatically yields

$$R_1 + R_2 \leq \frac{1}{2} \log_2 \left(1 + \beta_1 \text{SNR}_{11} + \beta_2 \text{SNR}_{12} + 2\rho^*(\beta_1, \beta_2) \sqrt{\beta_1 \text{SNR}_{11} \beta_2 \text{SNR}_{12}} \right). \quad (70c)$$

Furthermore, the total consumed power at transmitter i for $i \in \{1, 2\}$ over the $n+3$ channel uses is upper bounded by $(n+1)P_i$, hence, this scheme satisfies the input-power constraints.

Average received energy rate:

The average received energy rate is given by $B^{(n)} \triangleq \frac{1}{n} \sum_{t=1}^n Y_{2,t}^2$.

By the memoryless property of the channel and by the choice of the inputs, the sequence $Y_{2,1}, \dots, Y_{2,n}$ is i.i.d. and each $Y_{2,t}$ follows a zero-mean Gaussian distribution with variance \bar{B} given by

$$\begin{aligned} \bar{B} &\triangleq \mathbb{E}[Y_{2,t}^2] \\ &= 1 + \text{SNR}_{21} + \text{SNR}_{22} + 2\sqrt{\beta_1 \text{SNR}_{21} \beta_2 \text{SNR}_{22} \rho^*(\beta_1, \beta_2)} + 2\sqrt{(1 - \beta_1) \text{SNR}_{21} (1 - \beta_2) \text{SNR}_{22}}, \end{aligned} \quad (71)$$

where the correlation among the IC components is in the steady state.

By the weak law of large numbers, it holds that $\forall \epsilon > 0$,

$$\lim_{n \rightarrow \infty} \Pr \left(|B^{(n)} - \bar{B}| > \epsilon \right) = 0. \quad (72)$$

Consequently,

$$\lim_{n \rightarrow \infty} \Pr \left(B^{(n)} > \bar{B} + \epsilon \right) = 0, \quad \text{and} \quad (73a)$$

$$\lim_{n \rightarrow \infty} \Pr \left(B^{(n)} < \bar{B} - \epsilon \right) = 0. \quad (73b)$$

From (73b), it holds that for any energy rate B which satisfies $0 < B \leq \bar{B}$, it holds that

$$\lim_{n \rightarrow \infty} \Pr \left(B^{(n)} < B - \epsilon \right) = 0. \quad (74)$$

To sum up, any information-energy rate triplet (R_1, R_2, B) that satisfies

$$R_1 \leq \frac{1}{2} \log_2 \left(1 + \beta_1 \text{SNR}_{11} (1 - (\rho^*(\beta_1, \beta_2))^2) \right) \quad (75a)$$

$$R_2 \leq \frac{1}{2} \log_2 \left(1 + \beta_2 \text{SNR}_{12} (1 - (\rho^*(\beta_1, \beta_2))^2) \right) \quad (75b)$$

$$R_1 + R_2 \leq \frac{1}{2} \log_2 \left(1 + \beta_1 \text{SNR}_{11} + \beta_2 \text{SNR}_{12} + 2\rho^*(\beta_1, \beta_2) \sqrt{\beta_1 \text{SNR}_{11} \cdot \beta_2 \text{SNR}_{12}} \right) \quad (75c)$$

$$B \leq 1 + \text{SNR}_{21} + \text{SNR}_{22} + 2 \left(\sqrt{\beta_1 \beta_2} \rho^*(\beta_1, \beta_2) + \sqrt{(1 - \beta_1)(1 - \beta_2)} \right) \sqrt{\text{SNR}_{21} \text{SNR}_{22}} \quad (75d)$$

is achievable.

To achieve other points in the information-energy capacity region, transmitter 1 can split its message M_1 into two independent submessages $(M_{1,0}, M_{1,1}) \in \{1, \dots, \lfloor 2^{nR_{1,0}} \rfloor\} \times \{1, \dots, \lfloor 2^{nR_{1,1}} \rfloor\}$ such that $R_{1,0}, R_{1,1} \geq 0$ and $R_{1,0} + R_{1,1} = R_1$. It uses a power fraction $\alpha_1 \in [0, 1]$ of its available information-dedicated power $\beta_1 P_1$ to transmit $M_{1,0}$ using a non-feedback Gaussian random code and uses the remaining power $(1 - \alpha_1)\beta_1 P_1$ to send $M_{1,1}$ using the sum-capacity-achieving feedback scheme while treating $M_{1,0}$ as noise. Transmitter 2 sends its message M_2 using the sum-capacity-achieving feedback scheme.

Transmitter 1's IC-input is $U_{1,t} \triangleq U_{1,0,t} + U_{1,1,t}$ where $U_{1,1,t}$ is defined as in (57) but with reduced power $(1 - \alpha_1)\beta_1 P_1$, and $U_{1,0,t}$ is an independent zero-mean Gaussian random variable with variance $\alpha_1 \beta_1 P_1$. Transmitter 2's IC-input is defined as in (57).

The receiver first subtracts the common randomness and then decodes $(M_{1,1}, M_2)$ treating the signal encoding $M_{1,0}$ as noise. Successful decoding is possible if

$$R_{1,1} \leq \frac{1}{2} \log_2 \left(1 + \frac{(1 - \alpha_1)\beta_1 \text{SNR}_{11} (1 - \rho_{\alpha_1}(\beta_1, \beta_2)^2)}{1 + \alpha_1 \beta_1 \text{SNR}_{11}} \right) \quad (76a)$$

$$R_2 \leq \frac{1}{2} \log_2 \left(1 + \frac{\beta_2 \text{SNR}_{12} (1 - \rho_{\alpha_1}(\beta_1, \beta_2)^2)}{1 + \alpha_1 \beta_1 \text{SNR}_{11}} \right), \quad (76b)$$

where $\rho_{\alpha_1}(\beta_1, \beta_2)$ is defined as follows. When $\beta_1 \neq 0$, $\beta_2 \neq 0$, and $\alpha_1 \neq 1$, $\rho_{\alpha_1}(\beta_1, \beta_2)$ is the unique solution in $(0, 1)$ to the following equation in x :

$$\begin{aligned} & 1 + \frac{(1 - \alpha_1)\beta_1 \text{SNR}_{11} + \beta_2 \text{SNR}_{12} + 2x \sqrt{\beta_1 \beta_2 (1 - \alpha_1) \text{SNR}_{11} \text{SNR}_{12}}}{1 + \alpha_1 \beta_1 \text{SNR}_{11}} \\ & = \left(1 + \frac{(1 - \alpha_1)\beta_1 \text{SNR}_{11}}{1 + \alpha_1 \beta_1 \text{SNR}_{11}} (1 - x^2) \right) \left(1 + \frac{\beta_2 \text{SNR}_{12}}{1 + \alpha_1 \beta_1 \text{SNR}_{11}} (1 - x^2) \right), \end{aligned} \quad (77)$$

In this case, the existence and the uniqueness of $\rho_{\alpha_1}(\beta_1, \beta_2)$ follow a similar argument as the existence and uniqueness of a solution to (20). When $\alpha_1 = 1$, $\rho_{\alpha_1}(\beta_1, \beta_2) = \rho^*(\beta_1, \beta_2)$. When either $\beta_1 = 0$ or $\beta_2 = 0$, regardless of the value of α_1 , $\rho_{\alpha_1}(\beta_1, \beta_2) = 0$.

Then, using successive interference cancellation, the receiver recovers $M_{1,0}$ successfully if

$$R_{1,0} \leq \frac{1}{2} \log_2 (1 + \alpha_1 \beta_1 \text{SNR}_{11}). \quad (78)$$

By substituting $R_1 = R_{1,0} + R_{1,1}$, it can be seen that successful decoding of (M_1, M_2) is possible with arbitrarily small probability of error if the rates (R_1, R_2) satisfy

$$R_1 \leq \frac{1}{2} \log_2 \left(1 + \frac{(1 - \alpha_1) \beta_1 \text{SNR}_{11} (1 - (\rho_{\alpha_1}(\beta_1, \beta_2))^2)}{1 + \alpha_1 \beta_1 \text{SNR}_{11}} \right) + \frac{1}{2} \log_2 (1 + \alpha_1 \beta_1 \text{SNR}_{11}) \quad (79a)$$

$$R_2 \leq \frac{1}{2} \log_2 \left(1 + \frac{\beta_2 \text{SNR}_{12} (1 - (\rho_{\alpha_1}(\beta_1, \beta_2))^2)}{1 + \alpha_1 \beta_1 \text{SNR}_{11}} \right). \quad (79b)$$

Now, the average received energy rate of this scheme is analyzed. The sequence $Y_{2,1}, \dots, Y_{2,n}$ is i.i.d. and each $Y_{2,t}$ for $t \in \{1, \dots, n\}$ follows a zero-mean Gaussian distribution with variance B given by

$$B = \mathbb{E}[Y_{2,t}^2] = 1 + \text{SNR}_{21} + \text{SNR}_{22} + 2\sqrt{1 - \alpha_1} \rho_{\alpha_1}(\beta_1, \beta_2) \sqrt{\beta_1 \text{SNR}_{21} \beta_2 \text{SNR}_{22}} + 2\sqrt{(1 - \beta_1) \text{SNR}_{21} (1 - \beta_2) \text{SNR}_{22}}. \quad (80)$$

Here also the weak law of large numbers implies that

$$\lim_{n \rightarrow \infty} \Pr(B^{(n)} < b - \epsilon) = 0 \quad (81)$$

for any $b \in [0, B]$.

Now if ρ replaces $\sqrt{1 - \alpha_1} \rho_{\alpha_1}(\beta_1, \beta_2)$ with $\alpha_1 \in [0, 1]$ in constraints (79) and (80), then any non-negative information-energy rate triplet (R_1, R_2, B) satisfying

$$R_1 \leq \frac{1}{2} \log_2 (1 + \beta_1 \text{SNR}_{11} (1 - \rho^2)), \quad (82a)$$

$$R_2 \leq \frac{1}{2} \log_2 (1 + \beta_1 \text{SNR}_{11} + \beta_2 \text{SNR}_{12} + 2\rho \sqrt{\beta_1 \text{SNR}_{11} \beta_2 \text{SNR}_{12}}) - \frac{1}{2} \log_2 (1 + \beta_1 \text{SNR}_{11} (1 - \rho^2)), \quad (82b)$$

$$B \leq 1 + \text{SNR}_{21} + \text{SNR}_{22} + 2(\rho \sqrt{\beta_1 \beta_2} + \sqrt{(1 - \beta_1)(1 - \beta_2)}) \sqrt{\text{SNR}_{21} \text{SNR}_{22}}, \quad (82c)$$

where $\rho \in [0, \rho^*(\beta_1, \beta_2)]$ and $\rho^*(\beta_1, \beta_2)$ is the unique solution to (20), is achievable.

If the roles of transmitters 1 and 2 are reversed, it can be shown that any non-negative information-energy rate triplet (R_1, R_2, B) such that

$$R_1 \leq \frac{1}{2} \log_2 (1 + \beta_1 \text{SNR}_{11} + \beta_2 \text{SNR}_{12} + 2\rho \sqrt{\beta_1 \text{SNR}_{11} \beta_2 \text{SNR}_{12}}) - \frac{1}{2} \log_2 (1 + \beta_2 \text{SNR}_{12} (1 - \rho^2)), \quad (83a)$$

$$R_2 \leq \frac{1}{2} \log_2 (1 + \beta_2 \text{SNR}_{12} (1 - \rho^2)), \quad (83b)$$

$$B \leq 1 + \text{SNR}_{21} + \text{SNR}_{22} + 2\rho \sqrt{\beta_1 \text{SNR}_{21} \beta_2 \text{SNR}_{22}} + 2\sqrt{(1 - \beta_1) \text{SNR}_{21} (1 - \beta_2) \text{SNR}_{22}}, \quad (83c)$$

for any $\rho \in [0, \rho^*(\beta_1, \beta_2)]$, is achievable.

Time-sharing between all information-energy rate triplets in the union of the two regions described by the constraints (82) and (83) concludes the proof of achievability of the region. This yields

$$R_1 \leq \frac{1}{2} \log_2 (1 + \beta_1 \text{SNR}_{11} (1 - \rho^2)), \quad (84a)$$

$$R_2 \leq \frac{1}{2} \log_2 (1 + \beta_2 \text{SNR}_{12} (1 - \rho^2)), \quad (84b)$$

$$R_1 + R_2 \leq \frac{1}{2} \log_2 (1 + \beta_1 \text{SNR}_{11} + \beta_2 \text{SNR}_{12} + 2\rho \sqrt{\beta_1 \text{SNR}_{11} \beta_2 \text{SNR}_{12}}), \quad (84c)$$

$$B \leq 1 + \text{SNR}_{21} + \text{SNR}_{22} + 2\rho \sqrt{\beta_1 \text{SNR}_{21} \beta_2 \text{SNR}_{22}} + 2\sqrt{(1 - \beta_1) \text{SNR}_{21} (1 - \beta_2) \text{SNR}_{22}}, \quad (84d)$$

for any $\rho \in [0, \rho^*(\beta_1, \beta_2)]$.

Note that for any $\rho > \rho^*(\beta_1, \beta_2)$, the sum of (84a) and (84b) is strictly smaller than (84c). The resulting information region is a rectangle that is strictly contained in the rectangle obtained for $\rho = \rho^*(\beta_1, \beta_2)$. In other words, there is no gain in terms of information rates. In terms of energy rates, for any $\rho > \rho^*(\beta_1, \beta_2)$, there always exists a pair (β'_1, β'_2) such that

$$\rho = \sqrt{\beta'_1 \beta'_2} \rho^*(\beta'_1, \beta'_2) + \sqrt{(1 - \beta'_1)(1 - \beta'_2)}.$$

This choice achieves any information rate pair (R_1, R_2) satisfying

$$R_i \leq \frac{1}{2} \log_2 (1 + \beta'_i \text{SNR}_{1i} (1 - \rho^*(\beta'_1, \beta'_2)^2)). \quad (85)$$

In particular, it achieves

$$R_i \leq \frac{1}{2} \log_2 (1 + \beta'_i \text{SNR}_{1i} (1 - \rho^2)), \quad i \in \{1, 2\}, \quad (86)$$

since $\rho > \rho^*(1, 1) = \max_{(\beta_1, \beta_2) \in [0, 1]^2} \rho^*(\beta_1, \beta_2)$. This completes the proof of the achievability part of Theorem 1.

A.2 Proof of Converse

Fix an information-energy rate triplet $(R_1, R_2, B) \in \mathcal{E}_b^{\text{FB}}(\text{SNR}_{11}, \text{SNR}_{12}, \text{SNR}_{21}, \text{SNR}_{22})$. For this information-energy rate triplet and for each blocklength n , encoding and decoding functions are chosen such that

$$\limsup_{n \rightarrow \infty} P_{\text{error}}^{(n)} = 0, \quad (87a)$$

$$\limsup_{n \rightarrow \infty} P_{\text{outage}}^{(n)} = 0 \text{ for any } \epsilon > 0, \quad (87b)$$

$$B \geq b, \quad (87c)$$

subject to the input power constraint (8).

Using assumption (87a), applying Fano's inequality and following similar steps as in [24], it

can be shown that the rate-pair (R_1, R_2) must satisfy

$$nR_1 \leq \sum_{t=1}^n I(X_{1,t}; Y_{1,t} | X_{2,t}) + \epsilon_1^{(n)}, \quad (88a)$$

$$nR_2 \leq \sum_{t=1}^n I(X_{2,t}; Y_{1,t} | X_{1,t}) + \epsilon_2^{(n)}, \quad (88b)$$

$$n(R_1 + R_2) \leq \sum_{t=1}^n I(X_{1,t} X_{2,t}; Y_{1,t}) + \epsilon_{12}^{(n)}, \quad (88c)$$

where $\frac{\epsilon_1^{(n)}}{n}$, $\frac{\epsilon_2^{(n)}}{n}$, and $\frac{\epsilon_{12}^{(n)}}{n}$ tend to zero as n tends to infinity.

Using assumption (87b), for a given $\epsilon^{(n)} > 0$, for any $\eta > 0$ there exists $n_0(\eta)$ such that for any $n \geq n_0(\eta)$ it holds that

$$\Pr(B^{(n)} < B - \epsilon^{(n)}) < \eta. \quad (89)$$

Equivalently,

$$\Pr(B^{(n)} \geq B - \epsilon^{(n)}) \geq 1 - \eta \quad (90)$$

Using Markov's inequality [31], the probability in (90) can be upper-bounded as follows:

$$(B - \epsilon^{(n)}) \Pr(B^{(n)} \geq B - \epsilon^{(n)}) \leq \mathbb{E}[B^{(n)}]. \quad (91)$$

Combining (90) and (91) yields

$$(B - \epsilon^{(n)})(1 - \eta) \leq \mathbb{E}[B^{(n)}] \quad (92)$$

which can be written as

$$(B - \delta^{(n)}) \leq \mathbb{E}[B^{(n)}] \quad (93)$$

for some $\delta^{(n)} > \epsilon^{(n)}$ (for sufficiently large n). Hence, (88) and (93) are an upper-bound for any (R_1, R_2, B) satisfying (87a) and (87b).

In the following, the bounds in (88), (93), and (87c) are evaluated for the G-MAC-F(b). For this purpose, assume that $X_{1,t}$ and $X_{2,t}$ are arbitrary correlated random variables with

$$\mu_{i,t} \triangleq \mathbb{E}[X_{i,t}], \quad (94)$$

$$\sigma_{i,t}^2 \triangleq \text{Var}(X_{i,t}), \quad (95)$$

$$\lambda_t \triangleq \text{Cov}[X_{1,t}, X_{2,t}], \quad (96)$$

for $t \in \{1, \dots, n\}$ and for $i \in \{1, 2\}$.

The input sequence must satisfy the input power constraint (8) which can be written, for $i \in \{1, 2\}$, as

$$\frac{1}{n} \sum_{t=1}^n \mathbb{E}[X_{i,t}^2] = \left(\frac{1}{n} \sum_{t=1}^n \sigma_{i,t}^2 \right) + \left(\frac{1}{n} \sum_{t=1}^n \mu_{i,t}^2 \right) \leq P_i. \quad (97)$$

Note that from (1), for each $t \in \{1, \dots, n\}$, it holds that

$$h(Y_{1,t} | X_{1,t}, X_{2,t}) = h(Z_t) = \frac{1}{2} \log_2(2\pi e), \quad (98)$$

from the assumption that Z_t follows a zero-mean unit-variance Gaussian distribution. Note also that for any random variable X with variance σ_X^2 , it holds that $h(X) \leq \frac{1}{2} \log_2(2\pi e \sigma_X^2)$, with equality when X follows a Gaussian distribution [32]. Finally, it is useful to highlight that for any $a \in \mathbb{R}$, it holds that $h(X + a) = h(X)$. Using these elements, the right-hand side terms in (88) can be upper-bounded as follows:

$$\begin{aligned}
 I(X_{1,t}, X_{2,t}; Y_{1,t}) &= h(Y_{1,t}) - h(Z_t) \\
 &\leq \frac{1}{2} \log_2(2\pi e \text{Var}(Y_{1,t})) - \frac{1}{2} \log_2(2\pi e) \\
 &= \frac{1}{2} \log_2(h_{11}^2 \sigma_{1,t}^2 + h_{12}^2 \sigma_{2,t}^2 + 2h_{11}h_{12}\lambda_t + 1), \\
 I(X_{1,t}; Y_{1,t}|X_{2,t}) &= h(Y_{1,t}|X_{2,t}) - h(Y_{1,t}|X_{1,t}, X_{2,t}) \\
 &\leq \frac{1}{2} \log_2(2\pi e(\text{Var}(Y_{1,t}|X_{2,t}))) - \frac{1}{2} \log_2(2\pi e) \\
 &= \frac{1}{2} \log_2\left(1 + h_{11}^2 \sigma_{1,t}^2 \left(1 - \frac{\lambda_t^2}{\sigma_{1,t}^2 \sigma_{2,t}^2}\right)\right), \\
 I(X_{2,t}; Y_{1,t}|X_{1,t}) &= \frac{1}{2} \log_2\left(1 + h_{12}^2 \sigma_{2,t}^2 \left(1 - \frac{\lambda_t^2}{\sigma_{1,t}^2 \sigma_{2,t}^2}\right)\right).
 \end{aligned}$$

Finally, the bounds in (88) can be rewritten as follows:

$$nR_1 \leq \sum_{t=1}^n \frac{1}{2} \log_2\left(1 + h_{11}^2 \sigma_{1,t}^2 \left(1 - \frac{\lambda_t^2}{\sigma_{1,t}^2 \sigma_{2,t}^2}\right)\right) + \epsilon_1^{(n)}, \quad (99a)$$

$$nR_2 \leq \sum_{t=1}^n \frac{1}{2} \log_2\left(1 + h_{12}^2 \sigma_{2,t}^2 \left(1 - \frac{\lambda_t^2}{\sigma_{1,t}^2 \sigma_{2,t}^2}\right)\right) + \epsilon_2^{(n)}, \quad (99b)$$

$$n(R_1 + R_2) \leq \sum_{t=1}^n \frac{1}{2} \log_2(1 + h_{11}^2 \sigma_{1,t}^2 + h_{12}^2 \sigma_{2,t}^2 + 2h_{11}h_{12}\lambda_t) + \epsilon_{12}^{(n)}. \quad (99c)$$

The expectation of the average received energy rate is given by

$$\begin{aligned}
 \mathbb{E}[B^{(n)}] &= \mathbb{E}\left[\frac{1}{n} \sum_{t=1}^n Y_{2,t}^2\right] \\
 &= 1 + h_{21}^2 \left(\frac{1}{n} \sum_{t=1}^n (\sigma_{1,t}^2 + \mu_{1,t}^2)\right) + h_{22}^2 \left(\frac{1}{n} \sum_{t=1}^n (\sigma_{2,t}^2 + \mu_{2,t}^2)\right) \\
 &\quad + 2h_{21}h_{22} \left(\frac{1}{n} \sum_{t=1}^n (\lambda_t + \mu_{1,t}\mu_{2,t})\right).
 \end{aligned} \quad (100)$$

Using the Cauchy-Schwarz inequality, the energy rate in (100) can be upper-bounded as follows:

$$\begin{aligned}
 \mathbb{E}[B^{(n)}] &\leq 1 + h_{21}^2 \left(\frac{1}{n} \sum_{t=1}^n (\sigma_{1,t}^2 + \mu_{1,t}^2)\right) + h_{22}^2 \left(\frac{1}{n} \sum_{t=1}^n (\sigma_{2,t}^2 + \mu_{2,t}^2)\right) \\
 &\quad + 2h_{21}h_{22} \left(\frac{1}{n} \sum_{t=1}^n \lambda_t \left| \left(\frac{1}{n} \sum_{t=1}^n \mu_{1,t}^2\right)^{1/2} \left(\frac{1}{n} \sum_{t=1}^n \mu_{2,t}^2\right)^{1/2} \right.\right).
 \end{aligned} \quad (101)$$

Combining (93) and (101) yields the following upper-bound on the energy rate B :

$$B \leq 1 + h_{21}^2 \left(\frac{1}{n} \sum_{t=1}^n (\sigma_{1,t}^2 + \mu_{1,t}^2) \right) + h_{22}^2 \left(\frac{1}{n} \sum_{t=1}^n (\sigma_{2,t}^2 + \mu_{2,t}^2) \right) + 2h_{21}h_{22} \left(\left| \frac{1}{n} \sum_{t=1}^n \lambda_t \right| + \left(\frac{1}{n} \sum_{t=1}^n \mu_{1,t}^2 \right)^{1/2} \left(\frac{1}{n} \sum_{t=1}^n \mu_{2,t}^2 \right)^{1/2} \right) + \delta^{(n)}. \quad (102)$$

In order to obtain a single-letterization of the upper-bound given by constraints (99) and (102), define also

$$\mu_i^2 \triangleq \frac{1}{n} \sum_{t=1}^n \mu_{i,t}^2, \quad i \in \{1, 2\}, \quad (103)$$

$$\sigma_i^2 \triangleq \frac{1}{n} \sum_{t=1}^n \sigma_{i,t}^2, \quad i \in \{1, 2\}, \quad (104)$$

$$\rho \triangleq \left(\frac{1}{n} \sum_{t=1}^n \lambda_t \right) (|\sigma_1| |\sigma_2|)^{-1}. \quad (105)$$

With these notations, the input power constraint in (97) can be rewritten as

$$\sigma_i^2 + \mu_i^2 \leq P_i, \quad i \in \{1, 2\}. \quad (106)$$

By the concavity of the logarithm, applying Jensen's inequality [32] in the bounds (99) yields, in the limit when $n \rightarrow \infty$,

$$R_1 \leq \frac{1}{2} \log_2 (1 + h_{11}^2 \sigma_1^2 (1 - \rho^2)), \quad (107a)$$

$$R_2 \leq \frac{1}{2} \log_2 (1 + h_{12}^2 \sigma_2^2 (1 - \rho^2)), \quad (107b)$$

$$R_1 + R_2 \leq \frac{1}{2} \log_2 \left(1 + h_{11}^2 \sigma_1^2 + h_{12}^2 \sigma_2^2 + 2\sqrt{h_{11}^2 \sigma_1^2 h_{12}^2 \sigma_2^2 \rho} \right), \quad (107c)$$

and the upper-bound on the energy rate (102) yields

$$B \leq 1 + h_{21}^2 (\sigma_1^2 + \mu_1^2) + h_{22}^2 (\sigma_2^2 + \mu_2^2) + 2h_{21}h_{22} (|\rho| |\sigma_1| |\sigma_2| + |\mu_1| |\mu_2|). \quad (107d)$$

Let $\mathcal{R}_b(\sigma_1^2, \sigma_2^2, \mu_1, \mu_2, \rho)$ denote the set of information-energy rate triplets (R_1, R_2, B) satisfying:

$$R_1 \leq \frac{1}{2} \log_2 (1 + h_{11}^2 \sigma_1^2 (1 - \rho^2)), \quad (108a)$$

$$R_2 \leq \frac{1}{2} \log_2 (1 + h_{12}^2 \sigma_2^2 (1 - \rho^2)), \quad (108b)$$

$$R_1 + R_2 \leq \frac{1}{2} \log_2 \left(1 + h_{11}^2 \sigma_1^2 + h_{12}^2 \sigma_2^2 + 2\sqrt{h_{11}^2 h_{12}^2 \sigma_1^2 \sigma_2^2 \rho} \right), \quad (108c)$$

$$B \leq 1 + h_{21}^2 (\sigma_1^2 + \mu_1^2) + h_{22}^2 (\sigma_2^2 + \mu_2^2) + 2h_{21}h_{22} (|\rho| |\sigma_1| |\sigma_2| + |\mu_1| |\mu_2|), \quad (108d)$$

$$B \geq b, \quad (108e)$$

for some $\sigma_1^2, \sigma_2^2, \mu_1, \mu_2$ such that (106) is true and for some $\rho \in [-1, 1]$.

To sum up, it has been shown so far that, in the limit when n tends to infinity, any information-energy rate triplet $(R_1, R_2, B) \in \mathcal{E}_b^{\text{FB}}(\text{SNR}_{11}, \text{SNR}_{12}, \text{SNR}_{21}, \text{SNR}_{22})$ can be bounded by the constraints in (108) for some $\sigma_1^2, \sigma_2^2, \mu_1, \mu_2$ satisfying (106) and for some $\rho \in [-1, 1]$. Thus, it holds that

$$\mathcal{E}_b^{\text{FB}}(\text{SNR}_{11}, \text{SNR}_{12}, \text{SNR}_{21}, \text{SNR}_{22}) \subseteq \bigcup_{\substack{0 \leq \sigma_1^2 + \mu_1^2 \leq P_1 \\ 0 \leq \sigma_2^2 + \mu_2^2 \leq P_2 \\ -1 \leq \rho \leq 1}} \mathcal{R}_b(\sigma_1^2, \sigma_2^2, \mu_1, \mu_2, \rho). \quad (109)$$

In this union, it suffices to consider $0 \leq \rho \leq 1$ because for any $-1 \leq \rho \leq 1$, $\mathcal{R}_b(\sigma_1^2, \sigma_2^2, \mu_1^2, \mu_2^2, \rho) \subseteq \mathcal{R}_b(\sigma_1^2, \sigma_2^2, \mu_1^2, \mu_2^2, |\rho|)$. Furthermore, for $0 \leq \rho \leq 1$, it suffices to consider $\mu_1 \geq 0, \mu_2 \geq 0$, and $\sigma_1^2, \sigma_2^2, \mu_1^2$, and μ_2^2 that saturate the input power constraint (i.e., (106) holds with equality). Thus,

$$\begin{aligned} & \mathcal{E}_b^{\text{FB}}(\text{SNR}_{11}, \text{SNR}_{12}, \text{SNR}_{21}, \text{SNR}_{22}) \\ & \subseteq \bigcup_{\substack{0 \leq \sigma_1^2 + \mu_1^2 \leq P_1 \\ 0 \leq \sigma_2^2 + \mu_2^2 \leq P_2 \\ -1 \leq \rho \leq 1}} \mathcal{R}_b(\sigma_1^2, \sigma_2^2, \mu_1, \mu_2, \rho) \subseteq \bigcup_{\substack{\sigma_1^2 + \mu_1^2 = P_1 \\ \sigma_2^2 + \mu_2^2 = P_2 \\ 0 \leq \rho \leq 1}} \mathcal{R}_b(\sigma_1^2, \sigma_2^2, \mu_1, \mu_2, \rho). \end{aligned} \quad (110)$$

Let $\beta_i \in [0, 1]$ be defined as follows:

$$\beta_i \triangleq \frac{\sigma_i^2}{P_i} = \frac{P_i - \mu_i^2}{P_i}, \quad i \in \{1, 2\}. \quad (111)$$

With this notation, any region $\mathcal{R}_b(\sigma_1^2, \sigma_2^2, \mu_1, \mu_2, \rho)$ in the union over $\sigma_1^2 + \mu_1^2 = P_1, \sigma_2^2 + \mu_2^2 = P_2$ and $0 \leq \rho \leq 1$, can be rewritten as follows:

$$R_1 \leq \frac{1}{2} \log_2 (1 + h_{11}^2 \beta_1 P_1 (1 - \rho^2)), \quad (112a)$$

$$R_2 \leq \frac{1}{2} \log_2 (1 + h_{12}^2 \beta_2 P_2 (1 - \rho^2)), \quad (112b)$$

$$R_1 + R_2 \leq \frac{1}{2} \log_2 \left(1 + h_{11}^2 \beta_1 P_1 + h_{12}^2 \beta_2 P_2 + 2\sqrt{h_{11}^2 h_{12}^2 \beta_1 P_1 \beta_2 P_2 \rho} \right), \quad (112c)$$

$$B \leq 1 + h_{21}^2 P_1 + h_{22}^2 P_2 + 2h_{21} h_{22} (\rho \sqrt{\beta_1 P_1 \beta_2 P_2} + \sqrt{(1 - \beta_1) P_1 (1 - \beta_2) P_2}), \quad (112d)$$

$$B \geq b, \quad (112e)$$

for some $(\beta_1, \beta_2) \in [0, 1]^2$ and $\rho \in [0, 1]$. Hence, using (9), such a region contains all information-energy rate triplets (R_1, R_2, B) satisfying constraints (17) which completes the proof of the converse.

B Proof of Theorem 2

Consider that each transmitter i , with $i \in \{1, 2\}$, uses a fraction $\beta_i \in [0, 1]$ of its available power to transmit information and uses the remaining fraction of power $(1 - \beta_i)$ to transmit energy. Given a power-split $(\beta_1, \beta_2) \in [0, 1]^2$, the achievability of information rate pairs satisfying (18a)-(18c) follows by the coding scheme proposed independently by Cover [26] and Wyner [27] with powers $\beta_1 P_1$ and $\beta_2 P_2$. Additionally, in order to satisfy the received energy constraint (18d), transmitters send common randomness that is known to both transmitters and the receiver using all their remaining power. This common randomness does not carry any information and does

not produce any interference to the IC signals. More specifically, at each time t , transmitter i 's channel input can be written as:

$$X_{i,t} = \sqrt{(1 - \beta_i)P_i}W_t + U_{i,t}, \quad i \in \{1, 2\}, \quad (113)$$

for some independent zero-mean Gaussian IC symbols $U_{1,t}$ and $U_{2,t}$ with variances $\beta_1 P_1$ and $\beta_2 P_2$, respectively, and independent thereof W_t is a zero-mean unit-variance Gaussian NIC symbol known non-causally to all terminals.

The receiver subtracts the common randomness and then performs successive decoding to recover the messages M_1 and M_2 . Note that this strategy achieves the corner points of the information rate-region at a given energy rate. Time-sharing between the corner points and the points on the axes is needed to achieve the remaining points.

The converse and the analysis of the average received energy rate follow along the lines of the case with feedback described in Appendix A when the IC channel input components are assumed to be independent.

C Proof of Proposition 1

For a given energy transmission rate of b energy-units per channel use, a power-split (β_1, β_2) is feasible if there exists at least one $\rho \in [0, 1]$ that satisfies

$$g^{\text{FB}}(\beta_i, \beta_j, \rho) \geq b, \quad (114)$$

with

$$g^{\text{FB}}(\beta_i, \beta_j, \rho) \triangleq 1 + \text{SNR}_{2i} + \text{SNR}_{2j} + 2\sqrt{(1 - \beta_i)\text{SNR}_{2i}(1 - \beta_j)\text{SNR}_{2j}} + 2\rho\sqrt{\beta_i\text{SNR}_{2i}\beta_j\text{SNR}_{2j}}. \quad (115)$$

Using a Fourier-Motzkin elimination in the constraints (17a)-(17c) to eliminate R_j , it can be shown that transmitter i 's individual rate maximization problem (25) is equivalent to

$$R_i^{\text{FB}}(b) = \max_{(\beta_i, \beta_j, \rho) \in [0, 1]^3} f_i^{\text{FB}}(\beta_i, \beta_j, \rho), \quad (116a)$$

$$\text{subject to: } g^{\text{FB}}(\beta_i, \beta_j, \rho) \geq b, \quad (116b)$$

with

$$f_i^{\text{FB}}(\beta_i, \beta_j, \rho) \triangleq \min \left\{ \frac{1}{2} \log_2 (1 + \beta_i \text{SNR}_{1i} (1 - \rho^2)), \frac{1}{2} \log_2 (1 + \beta_i \text{SNR}_{1i} + \beta_j \text{SNR}_{1j} + 2\rho\sqrt{\beta_i \text{SNR}_{1i} \beta_j \text{SNR}_{1j}}) \right\}. \quad (117)$$

For a given triplet (β_i, β_j, ρ) , there are two cases: either it satisfies

$$-\rho^2 \beta_i \text{SNR}_{1i} > \beta_j \text{SNR}_{1j} + 2\rho\sqrt{\beta_i \text{SNR}_{1i} \beta_j \text{SNR}_{1j}}, \quad (118)$$

which implies that

$$f_i^{\text{FB}}(\beta_i, \beta_j, \rho) = \frac{1}{2} \log_2 (1 + \beta_i \text{SNR}_{1i} + \beta_j \text{SNR}_{1j} + 2\rho\sqrt{\beta_i \text{SNR}_{1i} \beta_j \text{SNR}_{1j}}); \quad (119)$$

or it satisfies

$$-\rho^2 \beta_i \text{SNR}_{1i} \leq \beta_j \text{SNR}_{1j} + 2\rho \sqrt{\beta_i \text{SNR}_{1i} \beta_j \text{SNR}_{1j}}, \quad (120)$$

and in this case

$$f_i^{\text{FB}}(\beta_i, \beta_j, \rho) = \frac{1}{2} \log_2 (1 + \beta_i \text{SNR}_{1i} (1 - \rho^2)). \quad (121)$$

In the first case, condition (118) cannot be true for any triplet $(\beta_i, \beta_j, \rho) \in [0, 1]^3$ and this case should be excluded.

In the second case, the function $f_i^{\text{FB}}(\beta_i, \beta_j, \rho)$ is decreasing in ρ and does not depend on β_j , thus, it holds that

$$f_i^{\text{FB}}(\beta_i, \beta_j, \rho) \leq f_i^{\text{FB}}(\beta_i, 0, 0), \quad (122)$$

and the triplet $(\beta_i, 0, 0)$ is feasible if and only if $g^{\text{FB}}(\beta_i, 0, 0) \geq b$. Under these assumptions, transmitter i is able to achieve its maximum individual rate if it uses a power-split in which the fraction β_i is maximized and its energy transmission is made at the minimum rate to meet the energy rate constraint. In this case, the maximization problem (116) reduces to the maximization problem in (128) in the proof of Proposition 2. Thus, it can be shown that the individual rates with feedback are limited by $R_i \leq \frac{1}{2} \log_2 (1 + (1 - \xi(b)^2) \text{SNR}_{1i})$ where $\xi(b)$ is given by (23).

D Proof of Proposition 2

From the assumptions of Proposition 2 it follows that an energy transmission rate of b energy-units per channel use must be guaranteed at the input of the EH. Then, the set of power-splits (β_i, β_j) that satisfy this constraint must satisfy

$$g_0(\beta_i, \beta_j) \geq b, \quad (123)$$

with

$$g_0(\beta_i, \beta_j) \triangleq 1 + \text{SNR}_{21} + \text{SNR}_{22} + 2\sqrt{(1 - \beta_i) \text{SNR}_{2i} (1 - \beta_j) \text{SNR}_{2j}}. \quad (124)$$

These power-splits are referred to as *feasible power-splits*.

Using a Fourier-Motzkin elimination in the constraints (18a)-(18c) to eliminate R_j , it can be shown that transmitter i 's individual rate maximization problem in (27) can be written as

$$R_i^{\text{NF}}(b) = \max_{(\beta_i, \beta_j) \in [0, 1]^2} f_i(\beta_i, \beta_j), \quad (125a)$$

$$\text{subject to: } g_0(\beta_i, \beta_j) \geq b, \quad (125b)$$

with

$$f_i(\beta_i, \beta_j) \triangleq \min \left\{ \frac{1}{2} \log_2 (1 + \beta_i \text{SNR}_{1i}), \frac{1}{2} \log_2 (1 + \beta_i \text{SNR}_{1i} + \beta_j \text{SNR}_{1j}) \right\} \quad (126)$$

and $g_0(\beta_1, \beta_2)$ is defined in (124).

For any feasible power-split (β_i, β_j) , it holds that

$$f_i(\beta_i, \beta_j) = \frac{1}{2} \log_2 (1 + \beta_i \text{SNR}_{1i}). \quad (127)$$

The target function $f_i(\beta_i, \beta_j)$ is increasing in β_i and is independent of β_j . Since the constraint function is monotonically decreasing in (β_i, β_j) , in order to maximize transmitter i 's individual rate, the optimal power-split should be a feasible power-split in which β_i is maximized while β_j is forced to 0. Thus, the maximization problem in (27) can be written as follows:

$$R_i^{\text{NF}}(b) = \max_{\beta_i \in [0,1]} \frac{1}{2} \log_2(1 + \beta_i \text{SNR}_{1i}), \quad (128a)$$

$$\text{subject to: } g_0(\beta_i, 0) \geq b. \quad (128b)$$

Transmitter i 's achievable information rate is increasing in β_i and the energy rate constraint is decreasing in β_i . Hence, transmitter i is able to achieve the maximum individual rate if the energy transmission of transmitter i is made at the minimum rate to meet the energy rate constraint, i.e., if there is equality in (123). In this configuration, transmitter i can use a power-split in which $\beta_i = 1 - \xi(b)^2$, with $\xi(b)$ defined in (23) which yields the maximum individual rate $R_i(b) = \frac{1}{2} \log_2(1 + (1 - \xi(b)^2) \text{SNR}_{1i})$.

E Proof of Proposition 3

For fixed SNR_{11} , SNR_{12} , SNR_{21} , and SNR_{22} and fixed minimum received energy rate $b \geq 0$ satisfying (11), the information sum-rate maximization problem in (29) can be written as

$$R_{\text{sum}}^{\text{FB}}(b) = \max_{(\beta_1, \beta_2, \rho) \in [0,1]^3} f(\beta_1, \beta_2, \rho) \quad (129a)$$

$$\text{subject to: } g(\beta_1, \beta_2, \rho) \geq b, \quad (129b)$$

where the functions f and g are defined as follows

$$f(\beta_1, \beta_2, \rho) \triangleq \min \left\{ \frac{1}{2} \log_2(1 + \beta_1 \text{SNR}_{11} + \beta_2 \text{SNR}_{12} + 2\rho \sqrt{\beta_1 \text{SNR}_{11} \beta_2 \text{SNR}_{12}}), \right. \\ \left. \frac{1}{2} \log_2((1 + \beta_1 \text{SNR}_{11}(1 - \rho^2))(1 + \beta_2 \text{SNR}_{12}(1 - \rho^2))) \right\}, \quad (130)$$

and

$$g(\beta_1, \beta_2, \rho) \triangleq 1 + \text{SNR}_{21} + \text{SNR}_{22} + 2 \left(\sqrt{\beta_1 \beta_2} \rho + \sqrt{(1 - \beta_1)(1 - \beta_2)} \right) \sqrt{\text{SNR}_{21} \text{SNR}_{22}}. \quad (131)$$

Let also

$$\rho_{\min}(\beta_1, \beta_2) \triangleq \min \left(1, \frac{\left(b - \left(1 + \text{SNR}_{21} + \text{SNR}_{22} + 2\sqrt{(1 - \beta_1)\text{SNR}_{21}(1 - \beta_2)\text{SNR}_{22}} \right) \right)^+}{2\sqrt{\beta_1 \text{SNR}_{21} \beta_2 \text{SNR}_{22}}} \right) \quad (132)$$

be the value of $\rho \in [0, 1]$ for which $g(\beta_1, \beta_2, \rho) = b$, with $\beta_1 \neq 0$ and $\beta_2 \neq 0$. Note that $\rho^*(\beta_1, \beta_2)$, initially defined in (20), can be alternatively defined as

$$\rho^*(\beta_1, \beta_2) \triangleq \underset{\rho \in [0,1]}{\text{argmax}} f(\beta_1, \beta_2, \rho). \quad (133)$$

when $\beta_1 \neq 0$ and $\beta_2 \neq 0$. When either $\beta_1 = 0$ or $\beta_2 = 0$ then $\rho^*(\beta_1, \beta_2) = 0$.

Using this notation, the proof of Proposition 3 is based on the following two lemmas.

Lemma 1. *Let $(\beta_1, \beta_2, \rho) \in [0, 1]^3$ be a solution to (129). Then,*

$$\rho = \max \{ \rho_{\min}(\beta_1, \beta_2), \rho^*(\beta_1, \beta_2) \}. \quad (134)$$

Proof:

Let $(\beta_1, \beta_2) \in (0, 1]^2$ be fixed. A necessary condition for (β_1, β_2, ρ) to be feasible, i.e., $g(\beta_1, \beta_2, \rho) \geq b$, is $\rho \in [\rho_{\min}(\beta_1, \beta_2), 1]$, with $\rho_{\min}(\beta_1, \beta_2)$ defined in (132).

Let $\bar{\rho}(\beta_1, \beta_2)$ be the solution to the following optimization problem:

$$\max_{\rho \in [\rho_{\min}(\beta_1, \beta_2), 1]} f(\beta_1, \beta_2, \rho). \quad (135)$$

Assume that

$$\rho_{\min}(\beta_1, \beta_2) \leq \rho^*(\beta_1, \beta_2). \quad (136)$$

In this case, it follows that $(\beta_1, \beta_2, \rho^*(\beta_1, \beta_2))$ is feasible.

From (133), it holds that $\forall \rho \in [\rho_{\min}(\beta_1, \beta_2), 1]$,

$$f(\beta_1, \beta_2, \rho) \leq f(\beta_1, \beta_2, \rho^*(\beta_1, \beta_2)). \quad (137)$$

Hence, under condition (136), $\bar{\rho}(\beta_1, \beta_2) = \rho^*(\beta_1, \beta_2)$.

Assume now that

$$\rho_{\min}(\beta_1, \beta_2) > \rho^*(\beta_1, \beta_2). \quad (138)$$

In this case, for any $\rho \in [\rho_{\min}(\beta_1, \beta_2), 1]$, it holds that

$$f(\beta_1, \beta_2, \rho) = \frac{1}{2} \log_2 (1 + \beta_1 \text{SNR}_{11} (1 - \rho^2)) + \frac{1}{2} \log_2 (1 + \beta_2 \text{SNR}_{12} (1 - \rho^2)). \quad (139)$$

Hence, f is monotonically decreasing in ρ , and thus $\bar{\rho}(\beta_1, \beta_2) = \rho_{\min}(\beta_1, \beta_2)$.

Given that the statements above hold for any pair (β_1, β_2) , then for any solution (β_1, β_2, ρ) to (129), it follows that $\rho = \bar{\rho}(\beta_1, \beta_2)$. This completes the proof. \blacksquare

Lemma 2. *The unique solution to (129) in $[0, 1]^3$ is $(1, 1, \bar{\rho})$ with*

$$\bar{\rho} \triangleq \max\{\rho_{\min}(1, 1), \rho^*(1, 1)\}. \quad (140)$$

Proof: Assume that there exists another solution $(\beta'_1, \beta'_2, \rho')$ to (129) different from $(1, 1, \bar{\rho})$. Thus, for any $(\beta_1, \beta_2, \rho) \in [0, 1]^3$ it holds that

$$f(\beta_1, \beta_2, \rho) \leq f(\beta'_1, \beta'_2, \rho'). \quad (141)$$

Note that for a fixed $\rho' \in [0, 1]$, $f(\beta_1, \beta_2, \rho')$ is strictly increasing in (β_1, β_2) . Hence, for any $(\beta_1, \beta_2) \in [0, 1]^2$,

$$f(\beta_1, \beta_2, \rho') < f(1, 1, \rho') \quad (142)$$

$$\leq f(1, 1, \bar{\rho}), \quad (143)$$

where the second inequality follows by Lemma 1. Moreover, since $\bar{\rho} \geq \rho_{\min}(1, 1)$, the following inequality also holds:

$$g(1, 1, \bar{\rho}) \geq b. \quad (144)$$

In particular, if $(\beta_1, \beta_2) = (\beta'_1, \beta'_2)$ in (142), it follows that

$$f(\beta'_1, \beta'_2, \rho') < f(1, 1, \bar{\rho}), \quad (145)$$

which contradicts the initial assumption that there exists a solution other than $(1, 1, \bar{\rho})$. This establishes a proof of Lemma 2. \blacksquare

Finally, the proof of Proposition 3 follows from the following equality:

$$R_{\text{sum}}^{\text{FB}}(b) = f(1, 1, \bar{\rho}). \quad (146)$$

Note that when $b \in [0, 1 + \text{SNR}_{21} + \text{SNR}_{22} + 2\rho^*(1, 1)\sqrt{\text{SNR}_{21}\text{SNR}_{22}}]$, $\bar{\rho} = \rho^*(1, 1)$ and

$$R_{\text{sum}}^{\text{FB}}(b) = \frac{1}{2} \log_2 \left(1 + \text{SNR}_{11} + \text{SNR}_{12} + 2\rho^*(1, 1)\sqrt{\text{SNR}_{11}\text{SNR}_{12}} \right). \quad (147)$$

When $b \in [1 + \text{SNR}_{21} + \text{SNR}_{22} + 2\rho^*(1, 1)\sqrt{\text{SNR}_{21}\text{SNR}_{22}}, 1 + \text{SNR}_{21} + \text{SNR}_{22} + 2\sqrt{\text{SNR}_{21}\text{SNR}_{22}}]$, $\bar{\rho} = \rho_{\min}(1, 1)$ and

$$R_{\text{sum}}^{\text{FB}}(b) = \frac{1}{2} \log_2(1 + (1 - \xi(b)^2)\text{SNR}_{11}) + \frac{1}{2} \log_2(1 + (1 - \xi(b)^2)\text{SNR}_{12}), \quad (148)$$

and this completes the proof.

F Proof of Proposition 4

The sum-rate maximization problem in (33) can be written as follows:

$$R_{\text{sum}}^{\text{NF}}(b) = \max_{(\beta_1, \beta_2) \in [0, 1]^2} f_0(\beta_1, \beta_2) \quad (149a)$$

$$\text{subject to: } g_0(\beta_1, \beta_2) \geq b, \quad (149b)$$

where the functions f_0 and g_0 are defined as

$$f_0(\beta_1, \beta_2) \triangleq \min \left\{ \frac{1}{2} \log_2(1 + \beta_1 \text{SNR}_{11} + \beta_2 \text{SNR}_{12}), \right. \\ \left. \frac{1}{2} \log_2(1 + \beta_1 \text{SNR}_{11}) + \frac{1}{2} \log_2(1 + \beta_2 \text{SNR}_{12}) \right\} \quad (150)$$

and $g_0(\beta_1, \beta_2)$ defined as in (124).

For any nonnegative β_1 and β_2 it can be shown that

$$f_0(\beta_1, \beta_2) = \frac{1}{2} \log_2(1 + \beta_1 \text{SNR}_{11} + \beta_2 \text{SNR}_{12}), \quad (151)$$

and thus the function f_0 is monotonically increasing in (β_1, β_2) . The function g_0 is monotonically decreasing in (β_1, β_2) .

Lemma 3. *A necessary condition for (β_1^*, β_2^*) to be a solution to the optimization problem in (149) is to satisfy*

$$g_0(\beta_1^*, \beta_2^*) = b, \quad (152)$$

when $1 + \text{SNR}_{21} + \text{SNR}_{22} < b \leq 1 + \text{SNR}_{21} + \text{SNR}_{22} + 2\sqrt{\text{SNR}_{21}\text{SNR}_{22}}$, and

$$\beta_1^* = \beta_2^* = 1 \quad (153)$$

when $0 \leq b \leq 1 + \text{SNR}_{21} + \text{SNR}_{22}$.

Proof: Let (β_1^*, β_2^*) be a solution to the optimization problem in (149).

Assume that $1 + \text{SNR}_{21} + \text{SNR}_{22} < b \leq 1 + \text{SNR}_{21} + \text{SNR}_{22} + 2\sqrt{\text{SNR}_{21}\text{SNR}_{22}}$ and $g_0(\beta_1^*, \beta_2^*) > b$. Without loss of generality, consider transmitter 1. Since g_0 is monotonically decreasing

in β_1 whereas f_0 is monotonically increasing in β_1 , there always exists a $\beta_1 > \beta_1^*$ such that $g_0(\beta_1, \beta_2^*) = b$ and $f_0(\beta_1, \beta_2^*) > f_0(\beta_1^*, \beta_2^*)$, which contradicts the assumption of the lemma.

Assume $0 \leq b \leq 1 + \text{SNR}_{21} + \text{SNR}_{22}$ and assume without loss of generality that transmitter 1 uses a power-split $\beta_1^* < 1$. From the initial assumption, the pair $(1, \beta_2^*)$ satisfies $g_0(1, \beta_2^*) \geq b$ and $f_0(1, \beta_2^*) \geq f_0(\beta_1^*, \beta_2^*)$ which contradicts the assumption of the lemma and completes the proof. \blacksquare

From Lemma 3, the optimization problem in (149) is equivalent to

$$R_{\text{sum}}^{\text{NF}}(b) = \max_{(\beta_1, \beta_2) \in [0, 1]^2} f_0(\beta_1, \beta_2) \quad (154a)$$

$$\text{subject to: } g_0(\beta_1, \beta_2) = b, \quad (154b)$$

Assume that $0 \leq b \leq 1 + \text{SNR}_{21} + \text{SNR}_{22}$. Then, from Lemma 3, it follows that the solution to the optimization problem in (149) is $\beta_1^* = \beta_2^* = 1$.

Assume now that

$$1 + \text{SNR}_{21} + \text{SNR}_{22} < b \leq 1 + \text{SNR}_{21} + \text{SNR}_{22} + 2\sqrt{\text{SNR}_{21}\text{SNR}_{22}} \min \left\{ \sqrt{\frac{\text{SNR}_{12}}{\text{SNR}_{11}}}, \sqrt{\frac{\text{SNR}_{11}}{\text{SNR}_{12}}} \right\}. \quad (155)$$

Note that for any energy rate constraint b satisfying (155), it holds that

$$0 < \xi(b) \leq \min \left\{ \sqrt{\frac{\text{SNR}_{11}}{\text{SNR}_{12}}}, \sqrt{\frac{\text{SNR}_{12}}{\text{SNR}_{11}}} \right\}. \quad (156)$$

Let (β_1^*, β_2^*) be a feasible pair, i.e., $g_0(\beta_1^*, \beta_2^*) = b$. This can be rewritten in terms of $\xi(b)$ as follows:

$$(1 - \beta_1^*)(1 - \beta_2^*) = \xi(b)^2, \quad (157)$$

with $\xi(b)$ defined in (23).

Note also that any solution to (157), must satisfy that $\beta_1 \leq 1 - \xi(b)^2$ and $\beta_2 \leq 1 - \xi(b)^2$. Hence, to obtain the solution of the optimization problem in (149), it suffices to perform the maximization over all $(\beta_1, \beta_2) \in [0, 1 - \xi(b)^2]$.

Let $\beta_2^* \in [0, 1 - \xi(b)^2]$ be fixed. Then, there is a unique feasible choice of β_1^* to satisfy (157), given by

$$\beta_1^* = 1 - \frac{\xi(b)^2}{1 - \beta_2^*}. \quad (158)$$

The corresponding sum-rate is given by

$$\kappa(\beta_2^*) \triangleq f_0(\beta_1^*, \beta_2^*) = \frac{1}{2} \log_2 \left(1 + \left(1 - \frac{\xi(b)^2}{1 - \beta_2^*} \right) \text{SNR}_{11} + \beta_2^* \text{SNR}_{12} \right), \quad (159)$$

which is a concave function of β_2^* . Hence, given a fixed β_1^* , the unique optimal β_2^* must be a solution to $\frac{d\kappa(\beta_2^*)}{d\beta_2^*} = 0$. That is,

$$(1 - \beta_2^*)^2 = \xi(b)^2 \frac{\text{SNR}_{11}}{\text{SNR}_{12}}. \quad (160)$$

The equality in (160) admits a solution in $[0, 1 - \xi(b)^2]$ if and only if (156) is satisfied. This unique solution is given by

$$\bar{\beta}_2^* = 1 - \xi(b) \sqrt{\frac{\text{SNR}_{11}}{\text{SNR}_{12}}} \quad (161)$$

and the corresponding $\bar{\beta}_1^*$ is given by

$$\bar{\beta}_1^* = 1 - \xi(b) \sqrt{\frac{\text{SNR}_{12}}{\text{SNR}_{11}}}. \quad (162)$$

In this case, the sum-rate is

$$\bar{R}_s = f_0(\bar{\beta}_1^*, \bar{\beta}_2^*) = \frac{1}{2} \log_2 \left(1 + \text{SNR}_{11} + \text{SNR}_{12} - 2\xi(b) \sqrt{\text{SNR}_{11} \text{SNR}_{12}} \right). \quad (163)$$

Assume now that

$$\begin{aligned} 1 + \text{SNR}_{21} + \text{SNR}_{22} + 2\sqrt{\text{SNR}_{21} \text{SNR}_{22}} \min \left\{ \sqrt{\frac{\text{SNR}_{12}}{\text{SNR}_{11}}}, \sqrt{\frac{\text{SNR}_{11}}{\text{SNR}_{12}}} \right\} \\ < b \leq 1 + \text{SNR}_{21} + \text{SNR}_{22} + 2\sqrt{\text{SNR}_{21} \text{SNR}_{22}}. \end{aligned} \quad (164)$$

This is equivalent to

$$\min \left\{ \sqrt{\frac{\text{SNR}_{12}}{\text{SNR}_{11}}}, \sqrt{\frac{\text{SNR}_{11}}{\text{SNR}_{12}}} \right\} \leq \xi(b) \leq 1. \quad (165)$$

Under this condition, the only feasible pairs, i.e., solutions to $g_0(\beta_1, \beta_2) = b$, are $(0, 1 - \xi(b)^2)$ and $(1 - \xi(b)^2, 0)$. Hence, for all $i \in \{1, 2\}$ satisfying $i = \underset{k \in \{1, 2\}}{\text{argmax}} \text{SNR}_{1,k}$ and $j \in \{1, 2\} \setminus \{i\}$, it follows that the solution to (149) is given by $\beta_i^* = 1 - \xi(b)^2$ and $\beta_j^* = 0$ and this completes the proof.

G Proof of Theorem 3

From Proposition 3, for any $B \in [0, 1 + \text{SNR}_{21} + \text{SNR}_{22} + 2\rho^*(1, 1)\sqrt{\text{SNR}_{21} \text{SNR}_{22}}]$, $R_{\text{sum}}^{\text{FB}}(B) > R_{\text{sum}}^{\text{NF}}(0)$, and thus any $B \in [0, 1 + \text{SNR}_{21} + \text{SNR}_{22} + 2\rho^*(1, 1)\sqrt{\text{SNR}_{21} \text{SNR}_{22}}]$ cannot be a solution to the optimization problem in (40). Hence, a necessary condition for B to be a solution to the optimization problem in (40) is to satisfy $B \in (1 + \text{SNR}_{21} + \text{SNR}_{22} + 2\rho^*(1, 1)\sqrt{\text{SNR}_{21} \text{SNR}_{22}}, 1 + \text{SNR}_{21} + \text{SNR}_{22} + 2\sqrt{\text{SNR}_{21} \text{SNR}_{22}}]$. Thus, from Proposition 3, the optimization problem in (40) can be rewritten as follows:

$$B_{\text{FB}} = \max_{B \in (b_1, b_2]} B$$

subject to :

$$\frac{1}{2} \log_2(1 + \text{SNR}_{11} + \text{SNR}_{12}) = \frac{1}{2} \log_2(1 + (1 - \xi(B)^2) \text{SNR}_{11}) + \frac{1}{2} \log_2(1 + (1 - \xi(B)^2) \text{SNR}_{12}). \quad (166)$$

where $b_1 = 1 + \text{SNR}_{21} + \text{SNR}_{22} + 2\rho^*(1, 1)\sqrt{\text{SNR}_{21} \text{SNR}_{22}}$ and $b_2 = 1 + \text{SNR}_{21} + \text{SNR}_{22} + 2\sqrt{\text{SNR}_{21} \text{SNR}_{22}}$. The constraint of the problem (166) induces a unique value for $(1 - \xi(B)^2)$ within $[0, 1]$ for each B , and thus, the optimization is vacuous. This implies that the unique solution B_{FB} satisfies

$$(1 - \xi(B_{\text{FB}})^2) = \frac{\text{SNR}_{11} + \text{SNR}_{12}}{2\text{SNR}_{11} \text{SNR}_{12}} \left[\sqrt{1 + \frac{4\text{SNR}_{11} \text{SNR}_{12}}{\text{SNR}_{11} + \text{SNR}_{12}}} - 1 \right]. \quad (167)$$

Following the definition of ξ in (23) and solving for B_{FB} in (167) yields (41). This completes the proof of Theorem 3.

Acknowledgments

The authors would like to thank Prof. Osvaldo Simeone for his insightful comments. The authors gratefully acknowledge the reviewers for their careful reading and their suggestions.

References

- [1] S. Belhadj Amor, S. M. Perlaza, and I. Krikidis, "Simultaneous energy and information transmission in Gaussian multiple access channels," in *Proc. 5th International Conference on Communications and Networking (ComNet)*, pp. 1–5, Hammamet, Tunisia, Nov. 2015.
- [2] S. Bi, C. K. Ho, and R. Zhang, "Wireless powered communication: opportunities and challenges," *IEEE Communications Magazine*, vol. 53, no. 4, pp. 117–125, Apr. 2015.
- [3] V. Talla, B. Kellogg, B. Ransford, S. Naderiparizi, S. Gollakota, and J. R. Smith, "Powering the next billion devices with Wi-Fi," *arXiv preprint arXiv:1505.06815*, 2015.
- [4] I. Krikidis, S. Timotheou, S. Nikolaou, G. Zheng, D. W. K. Ng, and R. Schober, "Simultaneous wireless information and power transfer in modern communication systems," *IEEE Communications Magazine*, vol. 52, no. 11, pp. 104–110, Nov. 2014.
- [5] L. R. Varshney, "Transporting information and energy simultaneously," in *Proc. IEEE International Symposium on Information Theory*, Toronto, ON, Canada, Jul. 2008, pp. 1612–1616.
- [6] A. M. Fouladgar and O. Simeone, "On the transfer of information and energy in multi-user systems," *IEEE Communications Letters*, vol. 16, no. 11, pp. 1733–1736, Nov. 2012.
- [7] P. Popovski, A. M. Fouladgar, and O. Simeone, "Interactive joint transfer of energy and information," *IEEE Transactions on Communications*, vol. 61, no. 5, pp. 2086–2097, May 2013.
- [8] K. Huang and E. Larsson, "Simultaneous information and power transfer for broadband wireless systems," *IEEE Transactions on Signal Processing*, vol. 61, no. 23, pp. 5972–5986, Dec. 2013.
- [9] Z. Xiang and M. Tao, "Robust beamforming for wireless information and power transmission," *IEEE Wireless Communications Letters*, vol. 1, no. 4, pp. 372–375, Aug. 2012.
- [10] R. Zhang and C. K. Ho, "MIMO broadcasting for simultaneous wireless information and power transfer," *IEEE Transactions on Wireless Communications*, vol. 12, no. 5, pp. 1989–2001, May 2013.
- [11] J. Park and B. Clerckx, "Joint wireless information and energy transfer in a two-user MIMO interference channel," *IEEE Transactions on Wireless Communications*, vol. 12, no. 8, pp. 4210–4221, Aug. 2013.
- [12] K. Huang and V. K. N. Lau, "Enabling wireless power transfer in cellular networks: Architecture, modeling and deployment," *IEEE Transactions on Wireless Communications*, vol. 13, no. 2, pp. 902–912, Feb. 2014.
- [13] Z. Ding, S. M. Perlaza, I. Esnaola, and H. V. Poor, "Power allocation strategies in energy harvesting wireless cooperative networks," *IEEE Transactions on Wireless Communications*, vol. 13, no. 2, pp. 846–860, Feb. 2014.

- [14] B. Gurakan, O. Ozel, J. Yang, and S. Ulukus, "Energy cooperation in energy harvesting wireless communications," in *Proc. IEEE International Symposium on Information Theory*, Cambridge, MA, USA, Jul. 2012, pp. 965–969.
- [15] K. Ishibashi, H. Ochiai, and V. Tarokh, "Energy harvesting cooperative communications," in *Proc. 2012 IEEE 23rd International Symposium on Personal Indoor and Mobile Radio Communications (PIMRC)*, Sydney, NSW, Australia, Sep. 2012, pp. 1819–1823.
- [16] Y. Luo, J. Zhang, and K. B. Letaief, "Optimal scheduling and power allocation for two-hop energy harvesting communication systems," *IEEE Transactions on Wireless Communications*, vol. 12, no. 9, pp. 4729–4741, Sep. 2013.
- [17] A. A. Nasir, X. Zhou, S. Durrani, and R. A. Kennedy, "Relaying protocols for wireless energy harvesting and information processing," *IEEE Transactions on Wireless Communications*, vol. 12, no. 7, pp. 3622–3636, Jul. 2013.
- [18] A. M. Fouladgar and O. Simeone, "Information and energy flows in graphical networks with energy transfer and reuse," *IEEE Wireless Communications Letters*, vol. 2, no. 4, pp. 371–374, Aug. 2013.
- [19] L. R. Varshney, "On energy/information cross-layer architectures," in *Proc. IEEE International Symposium on Information Theory*, Cambridge, MA, USA, Jul. 2012, pp. 1356–1360.
- [20] P. Grover and A. Sahai, "Shannon meets Tesla: Wireless information and power transfer," in *Proc. IEEE International Symposium on Information Theory*, Austin, TX, USA, Jun. 2010, pp. 2363–2367.
- [21] K. Banawan and S. Ulukus, "Gaussian MIMO wiretap channel under receiver side power constraints," in *Proc. 52nd Annual Allerton Conference on Communication, Control, and Computing*, Monticello, IL, USA, Sept. 2014, pp. 183–190.
- [22] M. Gastpar, "Gaussian multiple-access channels under received-power constraints," in *Proc. IEEE Information Theory Workshop*, San Antonio, TX, USA, Oct. 2004, pp. 452–457.
- [23] G. Kramer, "Feedback strategies for white Gaussian interference networks," *IEEE Transactions Information Theory*, vol. 48, no. 6, pp. 1423–1438, Jun. 2002.
- [24] L. H. Ozarow, "The capacity of the white Gaussian multiple access channel with feedback," *IEEE Transactions on Information Theory*, vol. 30, no. 4, pp. 623–629, Jul. 1984.
- [25] S. Pedersen, *From Calculus to Analysis*. Springer International Publishing, 2015.
- [26] T. M. Cover, "Some advances in broadcast channels," in *Advances in Communication Systems, Vol. 4, Theory and Applications*, A. Viterbi, Ed. New York: Academic Press, 1975, ch. 4.
- [27] A. D. Wyner, "Recent results in the Shannon theory," *IEEE Transactions on Information Theory*, vol. 20, no. 1, pp. 2–10, Jan. 1974.
- [28] T. Kailath, A. H. Sayed, and B. Hassibi, *Linear estimation*, ser. Prentice Hall information and system sciences series. Upper Saddle River, N.J. Prentice Hall, 2000.
- [29] A. El Gamal and Y. H. Kim, *Network Information Theory*. Cambridge, UK: Cambridge University Press, 2011.

- [30] A. Lapidoth, *A Foundation in Digital Communication*. New York: Cambridge University Press, 2009.
- [31] R. Durrett, *Probability Theory and Examples*. New York: Cambridge University Press, 2010.
- [32] T. M. Cover and J. A. Thomas, *Elements of Information Theory, 2nd Ed.* Hoboken, NJ: Wiley, 2006.



**RESEARCH CENTRE
GRENOBLE – RHÔNE-ALPES**

Inovallée
655 avenue de l'Europe Montbonnot
38334 Saint Ismier Cedex

Publisher
Inria
Domaine de Voluceau - Rocquencourt
BP 105 - 78153 Le Chesnay Cedex
inria.fr

ISSN 0249-6399