

Fundamental Limits of Repeaterless Quantum Communications

Stefano Pirandola,¹ Riccardo Laurenza,¹ Carlo Ottaviani,¹ and Leonardo Banchi²

¹*Computer Science and York Centre for Quantum Technologies,
University of York, York YO10 5GH, United Kingdom*

²*Department of Physics and Astronomy, University College London,
Gower Street, London WC1E 6BT, United Kingdom*

Quantum communications promises reliable transmission of quantum information, efficient distribution of entanglement and generation of completely secure keys. For all these tasks there is a crucial question to answer: What are their optimal rates without quantum repeaters? Our work solves this basic question for any two parties connected by a quantum channel, without any restriction on their classical communication, which can be unlimited and two-way. We design a method which reduces the most general protocol of quantum communication to the computation of a novel quantity, identified as the channel's relative entropy of entanglement. In this way, we bound the ultimate rates that are achievable over the most important bosonic and qubit channels, computing a number of exact formulas for their two-way capacities. In particular, we determine the fundamental rate-loss scaling which affects any quantum optical communication. By setting these limits, we establish the most general and correct benchmarks for testing the performance of quantum repeaters.

Quantum information is moving towards practical implementations, gradually evolving into next-generation quantum technologies with potentially superior performances. The development of completely secure quantum communications [1, 2] is an appealing alternative to the present and insecure classical infrastructure. The idea of a quantum Internet [3], which might lead to a worldwide architecture for distributed quantum processing, is attracting huge efforts from different fields, with hybrid solutions very promising in this direction [4–7].

But quantum information is more fragile than its classical counterpart. Exotic quantum features may be rapidly washed away by unwanted interactions with the environment, so that loss and noise may greatly degrade the ideal performance of quantum protocols. Such a limitation affects any quantum communication between two remote parties and this is the reason why, at some point, we need to resort to relays, known as quantum repeaters [8]. The crucial problem is to determine the maximum performance we can reach without these devices, so that we fully understand when they are actually needed and what benchmarks they need to surpass.

Our work solves this fundamental problem by computing the optimal rates which are achievable by repeaterless quantum communications in the most important practical scenarios. We consider two remote parties connected by a quantum channel who may exploit unlimited two-way classical communication (CC) and adaptive local operations (LOs), briefly called adaptive LOCCs. In this general scenario and considering the most fundamental channels, we determine the two-way capacities for transmitting quantum information (Q_2), distilling entanglement (D_2) and distributing secret keys (K).

To achieve our results we suitably combine the relative entropy of entanglement (REE) [9–11] with quantum teleportation [4, 12] in a novel reduction method which simplifies any quantum protocol based on adaptive LOCCs. First we show that the optimal rate of an adaptive protocol can always be bounded by a quantity

that we call the REE of the channel. Then, for a channel which suitably commutes with teleportation, we can decompose the output of the protocol in a tensor product of Choi matrices [13] (not necessarily of the same channel) and completely discard the adaptive LOCCs by using the monotonicity and subadditivity properties of the REE.

What is left is a remarkably simple upper bound. In fact, the channel's REE reduces to its one-shot expression and can always be computed as the REE of the channel's Choi matrix. We dub “entanglement flux” this latter quantity, since it represents the amount of entanglement which is distributed by a channel when it is fed by half of a maximally entangled state. Using the entanglement flux we can upperbound the two-way capacities of bosonic Gaussian channels [14], Pauli channels, erasure channels and amplitude damping channels [15].

By coincidence with suitable lower bounds we then prove strikingly simple formulas for the two-way quantum capacity Q_2 (equal to D_2) and the secret-key capacity K of several channels: For the erasure channel we show that $K = 1 - p$ where p is the erasure probability; for the dephasing channel we show that $Q_2 = K = 1 - H_2(p)$, where H_2 is the binary Shannon entropy and p is the dephasing probability (we also extend these results to arbitrary finite dimension). Then, for the bosonic quantum amplifier, we show that $Q_2 = K = \log_2[g/(g - 1)]$ where g is the gain. Most importantly, for the lossy channel, we show that $Q_2 = K = -\log_2(1 - \eta)$ where η is the transmissivity. Note that, before our work, only the Q_2 of the erasure channel was studied [16]. It took almost 20 years to find the other two-way capacities, which should give a clear idea of the novelty of our reduction method.

Note that the secret-key capacity of the lossy channel determines the maximum rate achievable in quantum key distribution (QKD). At high loss $\eta \simeq 0$ we find the optimal rate-loss scaling of $K \simeq 1.44\eta$ secret bits per channel use. This result completely characterizes the fundamental rate-loss law which restricts secure quantum optical communications, closing an investigation that started in

2009 with the best-known lower bound [17] and continued in 2014 with the first (but too large) upper bound [18]. We finally close the gap and exactly establish this rate-loss scaling that only quantum repeaters can surpass.

I. RESULTS

We first discuss how to reduce adaptive protocols and compute two-way capacities in any dimension. We then derive our results for bosonic and qubit communications. For proofs and full details the reader may refer to the Methods which summarizes the contents and the additional results given in the Supplementary Material.

A. Reduction of adaptive protocols

Our machinery builds on several tools but the key feature is the introduction of the channel's REE as general upper bound for the two-way capacities, and its suitable combination with quantum teleportation, that allows us to reduce the bound to a computable one-shot quantity. The dimension of the Hilbert space is arbitrary and may be infinite, i.e., we consider both discrete variable (DV) and continuous variable (CV) systems [14]. Our reduction method of adaptive protocols is completely new in the literature and goes well beyond the scope of this work.

Adaptive protocols and two-way capacities.— Let us start by describing adaptive protocols and defining two-way capacities. Suppose that Alice and Bob are separated by a quantum channel \mathcal{E} and want to implement the most general quantum protocol assisted by adaptive LOCCs. The protocol is stated in a general fashion but may be specified for distributing quantum information, distilling entanglement or secret correlations. We assume that Alice and Bob have countable sets of systems, denoted by \mathbf{a} and \mathbf{b} , respectively.

The first step is the preparation of the initial separable state of \mathbf{a} and \mathbf{b} by some LOCC Λ_0 . Next, Alice picks a system $a_1 \in \mathbf{a}$ which is sent through the channel \mathcal{E} . Once Bob gets the output b_1 , the parties apply another LOCC Λ_1 on all systems $\mathbf{a}b_1\mathbf{b}$. Let us update Bob's set by including the received system, i.e., $b_1\mathbf{b} \rightarrow \mathbf{b}$. In the second transmission, Alice sends another system $a_2 \in \mathbf{a}$ through \mathcal{E} with output b_2 for Bob. The parties apply a further LOCC Λ_2 to all systems $\mathbf{a}b_2\mathbf{b}$. Bob's set is updated and so on. After n transmissions, Alice and Bob share an output state $\rho_{\mathbf{a}\mathbf{b}}^n := \rho_{\mathbf{a}\mathbf{b}}(\mathcal{E}^{\otimes n})$ depending on the adaptive LOCCs $\mathcal{L} = \{\Lambda_0, \dots, \Lambda_n\}$ (see Fig. 1).

This adaptive protocol has rate R^n if $\|\rho_{\mathbf{a}\mathbf{b}}^n - \phi_n\| \leq \varepsilon$, where $\|\cdot\|$ is the trace norm and ϕ_n is a target state with nR^n bits. By taking the limit in n and optimizing over \mathcal{L} , we define the generic two-way capacity of the channel

$$\mathcal{C}(\mathcal{E}) := \sup_{\mathcal{L}} \lim_n R^n. \quad (1)$$

If the aim of the protocol is entanglement distillation, the target is a maximally entangled state and $\mathcal{C}(\mathcal{E}) =$

$D_2(\mathcal{E})$. Because an ebit can teleport a qubit and a qubit can distribute an ebit, $D_2(\mathcal{E})$ coincides with the two-way quantum capacity $Q_2(\mathcal{E})$. If the aim is to implement QKD, the target is a private state [19] and $\mathcal{C}(\mathcal{E}) = K(\mathcal{E})$, where the secret-key capacity satisfies $K(\mathcal{E}) \geq D_2(\mathcal{E})$, because ebits are specific types of secret bits. Thus, the generic two-way capacity \mathcal{C} can be any of D_2 , Q_2 , or K , and these capacities must satisfy $D_2 = Q_2 \leq K$.

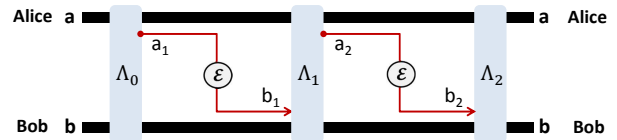

FIG. 1: Adaptive quantum protocol. Before and after each use of the quantum channel \mathcal{E} , Alice and Bob perform LOs assisted by unlimited two-way CCs, i.e., adaptive LOCCs Λ_k . For simplicity, we assume the following updates of the local ensembles $\mathbf{a} \rightarrow \mathbf{a}a_k$ (preparation) and $b_k\mathbf{b} \rightarrow \mathbf{b}$ (receipt).

Bounds for the two-way capacities.— Let us design suitable bounds for $\mathcal{C}(\mathcal{E})$. From below we know that we may use the coherent [20, 21] or reverse coherent [17, 22] information. Take a maximally entangled state of two systems A and B , i.e., an Einstein-Podolsky-Rosen (EPR) state Φ_{AB} . Propagating half of such a state through the channel defines its Choi matrix $\rho_{\mathcal{E}} := (\mathcal{I} \otimes \mathcal{E})\Phi_{AB}$. This allows us to introduce the coherent information of the channel $I_C(\mathcal{E})$ and its reverse counterpart $I_{RC}(\mathcal{E})$, defined as $I_{C(RC)}(\mathcal{E}) := S[\text{Tr}_{A(B)}(\rho_{\mathcal{E}})] - S(\rho_{\mathcal{E}})$, where $S(\cdot)$ is the von Neumann entropy. These quantities are easily computable and represent lower bounds for the entanglement that we can distill from the Choi matrix $\rho_{\mathcal{E}}$ by means of one-way CCs, denoted as $D_1(\rho_{\mathcal{E}})$. In other words, we can write the hashing inequality [23]

$$\max\{I_C(\mathcal{E}), I_{RC}(\mathcal{E})\} \leq D_1(\rho_{\mathcal{E}}) \leq \mathcal{C}(\mathcal{E}). \quad (2)$$

Because the EPR state is unbounded in CVs, so is the Choi matrix of a bosonic channel, and the hashing inequality needs to be suitably extended (see Methods).

As previously said, the completely novel and most important tool is the upper bound. We construct this bound by extending the notion of REE from a quantum state to a quantum channel. Recall that, for any bipartite state ρ , the REE is defined as $E_R(\rho) = \min_{\sigma} S(\rho||\sigma)$, where σ is an arbitrary separable state and $S(\rho||\sigma) := \text{Tr}[\rho(\log_2 \rho - \log_2 \sigma)]$ is the relative entropy [11]. Then, we may prove the following (see Methods for proof).

Theorem 1 (weak converse) *At any dimension, finite or infinite, the generic two-way capacity of an arbitrary quantum channel \mathcal{E} must satisfy the upper bound*

$$\mathcal{C}(\mathcal{E}) \leq E_R(\mathcal{E}) := \sup_{\mathcal{L}} \lim_{n \rightarrow \infty} \frac{E_R(\rho_{\mathbf{a}\mathbf{b}}^n)}{n}. \quad (3)$$

The bound $E_R(\mathcal{E})$ defines the REE of the channel: It provides the maximum entanglement (as measured by the REE) that can be distributed through the channel. Its computation is generally hard but, as we show below, it can be greatly simplified if the channel suitably commutes with quantum teleportation.

Teleportation stretching of an adaptive protocol.— Let us introduce a technique based on quantum teleportation [4, 12], that we call “teleportation stretching”. This technique exploits the tool of teleportation channel [24] to simplify an arbitrary adaptive protocol implemented over a wide family of quantum channels at any dimension, finite or infinite. For its generality, teleportation stretching supersedes Ref. [24] and any other approach in the literature (see Methods).

Call \mathcal{U}_d the set of teleportation unitaries in arbitrary dimension d . These are the unitaries which are generated by the teleportation process. For a qudit, \mathcal{U}_d is composed of generalized Pauli operators, i.e., the generators of the Weyl-Heisenberg group. For a CV system, the set \mathcal{U}_∞ is composed of displacement operators [4], spanning the infinite dimensional version of the previous group. By definition, a quantum channel \mathcal{E} is “stretchable” if, for any teleportation unitary $U \in \mathcal{U}_d$, we may write

$$\mathcal{E}(U\rho U^\dagger) = V\mathcal{E}(\rho)V^\dagger, \quad (4)$$

for some other unitary V . Typically, V is a teleportation unitary itself, so that the channel is covariant with the elements of the Weyl-Heisenberg group. This teleportation covariance is common to many channels, including Pauli channels and bosonic Gaussian channels.

The key property of a stretchable channel \mathcal{E} is that the teleportation unitaries can be pushed from the input to the output of the channel. For this reason, the transmission of a system through \mathcal{E} is equivalent to its teleportation over the Choi matrix $\rho_\mathcal{E}$. This is explained in Fig. 2. As a consequence, Alice’s Bell detection and Bob’s unitary corrections can be made part of the LOs while the Choi matrix is anticipated in time, i.e., stretched out of adaptive LOCCs. This is depicted in Fig. 3 for the generic k th use of the channel.

By iterating such a procedure for all transmissions, we stretch the entire protocol: This is reduced to a block protocol where channels are replaced by Choi matrices and the adaptive LOCCs are collapsed into a single trace-preserving LOCC $\bar{\Lambda}$. Thus, after n uses of a stretchable channel \mathcal{E} , Alice and Bob’s output state reads

$$\rho_{\text{ab}}^n = \bar{\Lambda}(\rho_\mathcal{E}^{\otimes n}). \quad (5)$$

Let us stress that the latter decomposition is valid for adaptive protocols whose task is completely generic and may also involve unbounded Choi matrices, which must be treated as a suitable limit. Afterwards, we relax Eq. (4) so that we can write generalized versions of Eq. (5), which are valid for families of quantum channels so wide which is difficult to find counter-examples.

Entanglement flux as computable upper bound.— It is clear that Eq. (5) alone is useless, but its combination

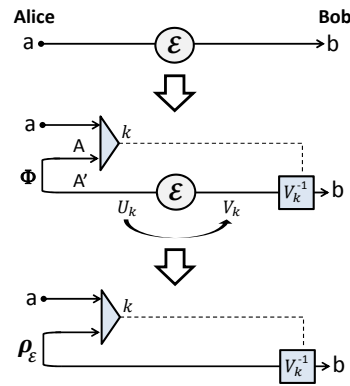

FIG. 2: Stretchable channel. (Top) Transmission through channel \mathcal{E} from input system a to output system b . (Middle) System a is perfectly teleported into the new input system A' by a teleportation circuit composed by an EPR state $\Phi_{AA'}$ plus a Bell detection acting on a and A (triangle). The outcome k of the measurement is classically communicated to Bob. Since the channel is stretchable the input teleportation unitary U_k is mapped into another output unitary V_k . This is corrected by Bob applying V_k^{-1} . (Bottom) The result is teleportation of the input system a over the Choi matrix $\rho_\mathcal{E}$.

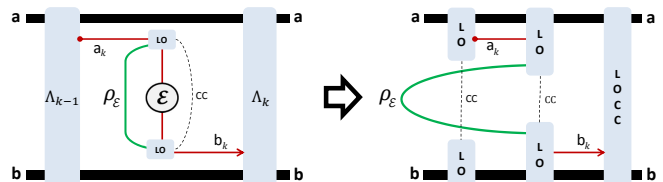

FIG. 3: Teleportation stretching of an adaptive quantum protocol. The generic k transmission $a_k \rightarrow b_k$ through a stretchable channel \mathcal{E} (red line) is replaced by the teleportation of the input system a_k by means of the Choi matrix $\rho_\mathcal{E}$. This means that a_k and the upper half of the Choi matrix are subject to a Bell detection (upper LO). The result is classically communicated to the lower half of the Choi matrix, where a correction unitary is applied (lower LO). Thus, we can replace \mathcal{E} with its Choi matrix $\rho_\mathcal{E}$, which is then stretched out of the adaptive LOCCs. The latter collapse into a single LOCC.

with Theorem 1 provides the insight of our method. In fact, let us compute the REE of the state ρ_{ab}^n . We find

$$E_R(\rho_{\text{ab}}^n) \stackrel{(1)}{\leq} E_R(\rho_\mathcal{E}^{\otimes n}) \stackrel{(2)}{\leq} nE_R(\rho_\mathcal{E}), \quad (6)$$

where we have used that (1) the REE is non-increasing under trace-preserving LOCCs and (2) it is subadditive under tensor products; two basic properties valid in any dimension [25]. This manipulation allows us to discard all the details of the complicated $\bar{\Lambda}$. Then, by replacing Eq. (6) into Eq. (3), we can also discard the upper limit and the supremum in the definition of $E_R(\mathcal{E})$, and we get the remarkably simple bound

$$E_R(\mathcal{E}) \leq E_R(\rho_\mathcal{E}). \quad (7)$$

More precisely, we can state the following main result.

Theorem 2 (additivity) *The REE of a stretchable channel is additive and equals the REE of its Choi matrix. In other words, we may write*

$$E_R(\mathcal{E}) = E_R^{(1)}(\mathcal{E}) := \sup_{\rho} E_R[(\mathcal{I} \otimes \mathcal{E})(\rho)] = E_R(\rho_{\mathcal{E}}), \quad (8)$$

where $E_R^{(1)}(\mathcal{E})$ is the one-shot REE of the channel.

Proof. The converse part has been proven in Eq. (7). For the achievability, we just realize that $E_R(\rho_{\mathcal{E}})$ is a specific distribution strategy where the output REE is obtained by sending half of an EPR state through a single use of the channel. Clearly, this is a one-shot strategy which means that $E_R(\mathcal{E})$ is additive on stretchable channels. ■

Thus, our upper bound has been reduced to compute the one-shot REE of the channel and, more precisely, the REE of its Choi matrix. The latter is defined as the “entanglement flux” of the channel, for which we use the short-hand notation $\Phi(\mathcal{E}) := E_R(\rho_{\mathcal{E}})$. According to Theorem 2, the entanglement flux is the maximum entanglement transmittable through a stretchable channel; according to Theorem 1, it provides our upper bound for evaluating the two-way capacities, i.e., $\mathcal{C}(\mathcal{E}) \leq \Phi(\mathcal{E})$. In total, we have automatically proven the following.

Corollary 3 *At any dimension, the generic two-way capacity $\mathcal{C}(\mathcal{E})$ of a stretchable channel \mathcal{E} must satisfy*

$$\max\{I_C(\mathcal{E}), I_{RC}(\mathcal{E})\} \leq D_1(\rho_{\mathcal{E}}) \leq \mathcal{C}(\mathcal{E}) \leq \Phi(\mathcal{E}). \quad (9)$$

Afterwards we show the existence of stretchable channels for which the previous bounds coincide, so that the maximum entanglement they distribute is one-way distillable $\Phi(\mathcal{E}) = D_1(\rho_{\mathcal{E}})$. For these “distillable channels” we establish all the two-way capacities as $\mathcal{C}(\mathcal{E}) = \Phi(\mathcal{E})$. This important class includes lossy channels, quantum-limited amplifiers, dephasing and erasure channels.

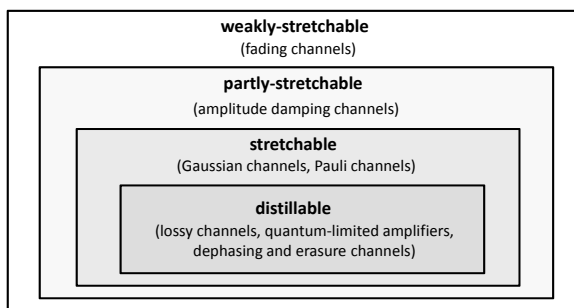

FIG. 4: Classification of channels in DVs and CVs for which we can apply teleportation stretching and reduce an adaptive protocol by means of our method. The examples shown in the brackets are all channels studied in this manuscript.

In general, we can relax the condition of Eq. (4) and allow for more general channels which are decomposable as $\mathcal{E} = \mathcal{E}'' \circ \tilde{\mathcal{E}} \circ \mathcal{E}'$, where \mathcal{E}' and \mathcal{E}'' are arbitrary, with $\tilde{\mathcal{E}}$ being stretchable. For these partly-stretchable channels

$$\rho_{\mathbf{ab}}^n = \bar{\Lambda}(\rho_{\tilde{\mathcal{E}}}^{\otimes n}), \quad \mathcal{C}(\mathcal{E}) \leq \Phi(\tilde{\mathcal{E}}). \quad (10)$$

This allows us to consider other error models, such as amplitude damping, and to handle extra decoherence. For instance, it explains why the secret key rate can be positive with trusted noise in local setups, \mathcal{E}' for Alice and \mathcal{E}'' for Bob, so that channel \mathcal{E} is entanglement-breaking. This is relevant for both thermal QKD [26–30] and measurement device independent (MDI) QKD [31–34].

In a further generalization, we may consider weakly-stretchable channels which are defined by the mixture

$$\mathcal{E} = \sum_{ijl} p_{ijl} \mathcal{E}_i'' \circ \tilde{\mathcal{E}}_j \circ \mathcal{E}_i', \quad (11)$$

where p_{ijl} is a probability distribution. In this case,

$$\rho_{\mathbf{ab}}^n = \bar{\Lambda} \left(\otimes_j \rho_{\tilde{\mathcal{E}}_j}^{\otimes n p_j} \right), \quad \mathcal{C}(\mathcal{E}) \leq \sum_j p_j \Phi(\tilde{\mathcal{E}}_j), \quad (12)$$

where p_j is the probability of the stretchable part $\tilde{\mathcal{E}}_j$. This is needed to study quantum and secure communications which are affected by strong statistical fluctuations, as those induced by atmospheric turbulence in the links between ground stations and satellites [35]. See Fig. 4 for a classification of the channels that can be stretched by teleportation and reduced by our method.

Quantum feedback and multiband communication.— Our method can also be generalized and extended to other communication scenarios, e.g., including the presence of quantum feedback. In this case, the most general adaptive protocol considers Alice and Bob sending systems to each other via the two channels, \mathcal{E} (forward) and \mathcal{E}' (feedback), and performing adaptive LOCCs before and after each transmission. One can define the generic capacity $\mathcal{C}(\mathcal{E}, \mathcal{E}')$ assisted by quantum feedback and unlimited two-way CCs. For stretchable channels, we find $\mathcal{C}(\mathcal{E}, \mathcal{E}') \leq \max\{\Phi(\mathcal{E}), \Phi(\mathcal{E}')\}$ which reduces to $\mathcal{C}(\mathcal{E}, \mathcal{E}') = \max\{\mathcal{C}(\mathcal{E}), \mathcal{C}(\mathcal{E}')\}$ if they are distillable. In the latter case, the optimal strategy is therefore reduced to the use of the channel with the maximum capacity.

Another important scenario is where the parties exploit a multiband quantum channel $\mathcal{E}_{\text{band}}$, as in broadband fibre communications. Here, Alice prepares m systems which are simultaneously sent through m independent channels $\{\mathcal{E}_i\}$, with adaptive LOCCs performed before and after each block transmission. In the case of stretchable channels $\{\mathcal{E}_i\}$, we easily show that the multiband capacity must satisfy $\mathcal{C}(\mathcal{E}_{\text{band}}) \leq \sum_i \Phi(\mathcal{E}_i)$, which reduces to $\mathcal{C}(\mathcal{E}_{\text{band}}) = \sum_i \mathcal{C}(\mathcal{E}_i)$ if the channels are distillable.

B. Ultimate limits of bosonic communications

We are now ready to derive the ultimate rates for quantum and secure communication over bosonic channels. For bosonic systems, the EPR state Φ has infinite energy, so that the Choi matrix $\rho_{\mathcal{E}}$ is unbounded. This means that the coherent information quantities and the entanglement flux of the channel must be computed as limits. To handle this we take a sequence of two-mode squeezed

vacuum states [14] Φ^μ whose variance μ is sent to infinite. This sequence converges in norm to the EPR state Φ and the corresponding channel output $\rho^\mu := (\mathcal{I} \otimes \mathcal{E})(\Phi^\mu)$ converges in norm to the Choi matrix $\rho_{\mathcal{E}}$.

Computing the coherent information quantities on ρ^μ and taking the limit we can derive $I_C(\mathcal{E})$ and $I_{RC}(\mathcal{E})$. To compute the entanglement flux, we first write $\Phi(\mathcal{E}) \leq S(\rho_{\mathcal{E}}|\tilde{\sigma})$ for a suboptimal separable state $\tilde{\sigma}$. We then build a sequence of separable states $\tilde{\sigma}^\mu$ converging to $\tilde{\sigma}$ in trace norm. This allows us to exploit the lower semi-continuity of the relative entropy [25] and write

$$\Phi(\mathcal{E}) \leq \liminf_{\mu \rightarrow +\infty} S(\rho^\mu|\tilde{\sigma}^\mu). \quad (13)$$

For Gaussian channels, the sequences in Eq. (13) are composed of Gaussian states, for which we can easily compute the relative entropy. In fact, for any two Gaussian states, ρ_1 and ρ_2 , we prove the formula $S(\rho_1|\rho_2) = \Sigma(V_1, V_2) - S(\rho_1)$, where Σ is a simple functional of their statistical moments (see Methods). Further algebraic manipulations allow us to bound (and determine) the two-way capacities of the most relevant Gaussian channels, starting from the most important, the lossy channel.

Rate-loss scaling in quantum optical communications.—Optical communications through free-space links or telecom fibres are inevitably lossy and the standard model to describe this scenario is the lossy channel. This is a bosonic Gaussian channel characterized by a transmissivity parameter η , which quantifies the fraction of input photons surviving the channel. It can be represented as a beam splitter mixing the incoming signals with an environment at zero temperature (background thermal noise is negligible at optical and telecom frequencies).

For a lossy channel \mathcal{E}_η with arbitrary transmissivity η we apply our reduction method and compute the entanglement flux $\Phi(\eta) \leq -\log_2(1 - \eta)$. This coincides with the reverse coherent information of this channel $I_{RC}(\eta)$, first derived in Ref. [17]. Thus, applying the sandwich relation of Eq. (9), we find that this channel is distillable and all its two-way capacities are given by

$$\mathcal{C}(\eta) = D_2(\eta) = Q_2(\eta) = K(\eta) = -\log_2(1 - \eta). \quad (14)$$

Interestingly this capacity coincides with the maximum discord [37] that can be distributed to the parties, since we may write [38] $I_{RC}(\eta) = D(B|A)$, where the latter is the discord of the Gaussian Choi matrix $\rho_{\mathcal{E}}$ [39]. Also note that we prove the strict separation $Q_2(\eta) > Q(\eta)$, where Q is the unassisted quantum capacity [20, 21].

Expanding our formula in Eq. (14) at high loss $\eta \simeq 0$, we find $\mathcal{C}(\eta) \simeq \eta/\ln 2 \simeq 1.44\eta$ bits per channel use, or about η nats per channel use. This completely characterizes the fundamental rate-loss scaling which rules all long-distance quantum optical communications in the absence of quantum repeaters. It is important to remark that our work also proves the achievability of this scaling. This represents a major advance with respect to previous literature, where other approaches based on the squashed

entanglement [18] provided an upper bound too large to be reached, twice of the actual scaling we discovered.

The capacity in Eq. (14) is also valid for two-way quantum communication with lossy channels, assuming that η is the maximum transmissivity between the forward and feedback channel. It can also be extended to a multi-band lossy channel, e.g., a broadband telecom fibre, for which we may write $\mathcal{C} = -\sum_i \log_2(1 - \eta_i)$ where η_i are the transmissivities of the various frequency components. In general, we may write $\mathcal{C}(\mathcal{E}) \leq -\log_2(1 - \eta)$ for any partly-stretchable channel which is decomposable as $\mathcal{E} = \mathcal{E}'' \circ \mathcal{E}_\eta \circ \mathcal{E}'$, where \mathcal{E}_η is a lossy component. This encompasses a wide range of situations. Depending on the choice of \mathcal{E}' and \mathcal{E}'' , we can generate Gaussian or non-Gaussian channels. In general, it allows us to include any form of manipulation or decoherence in the extra channels \mathcal{E}' and \mathcal{E}'' . This can be preparation noise as in thermal QKD [26–30] and MDI QKD [31–34].

Once determined the secret key capacity of the lossy channel, we can analyze the state of the art in high-rate QKD, by comparing this ultimate limit with the maximum rates achievable by practical protocols in the presence of loss. We assume infinitely long keys and ideal parameters. For CVs we assume: Unit detector efficiency, zero excess noise, large modulation and unit reconciliation efficiency. For DVs we assume: Unit detector efficiencies, zero dark count rates, zero intrinsic error, unit error correction efficiency, and no other internal loss. The corresponding maximum rates are compared with the secret-key capacity $K(\eta)$ in Fig. 5. From the figure we can appreciate how ideal implementations of CV protocols are not so far from the ultimate limit.

Finally, note that free-space satellite communications may be modelled as a mixture of lossy channels \mathcal{E}_j with transmissivities η_j and associated probabilities p_i [35]. For this fading channel $\mathcal{E} = \sum_j p_j \mathcal{E}_j$ we may write

$$\mathcal{C}(\mathcal{E}) \leq -\sum_j p_j \log_2(1 - \eta_j). \quad (15)$$

In general, fading is a random process affecting the attenuation of a channel due to many potential causes, such as the presence of multipath propagation, obstacles or atmospheric turbulence. The bound in Eq. (15) applies to any fading channel which can be modelled by a weakly-stretchable channel as in Eq. (11), where the stretchable components $\tilde{\mathcal{E}}_j$ are lossy channels while the extra channels \mathcal{E}'_i and \mathcal{E}''_i account for any other stochastic process.

Quantum communications with Gaussian noise.—As discussed above the fundamental limit of the lossy channel provides a general upper bound for the two-way capacities of Gaussian channels with lossy components. Here we consider Gaussian channels in more detail and we derive tailored upper bounds for each case. Let us start from the thermal-loss channel, which can be modelled as a beamsplitter with transmissivity η in a thermal background with \bar{n} mean photons. Its action on input quadratures $\hat{\mathbf{x}} = (\hat{q}, \hat{p})$ is given by $\hat{\mathbf{x}} \rightarrow \sqrt{\eta}\hat{\mathbf{x}} + \sqrt{1 - \eta}\hat{\mathbf{x}}_E$

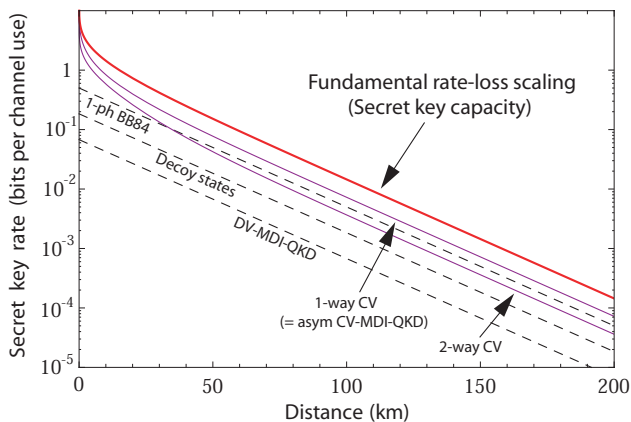

FIG. 5: Secret key rate (bits per channel use) versus Alice-Bob's distance (km) at the loss rate of 0.2 dB per km. The secret key capacity of the channel (red line) sets the fundamental rate limit for QKD. We show the maximum rates achievable by current protocols. For the CV protocols (purple lines), we consider: (i) One-way no-switching protocol [40], coinciding with CV-MDI-QKD [33, 34] in the most asymmetric configuration (relay approaching Alice [41]). For high loss ($\eta \simeq 0$), the rate scales as $\eta/\ln 4$, which is just 1/2 of the capacity. Same scaling for the one-way switching protocol of Ref. [42]; (ii) Two-way protocol with coherent states and homodyne detections [43, 44] which scales as $\simeq \eta/(4\ln 2)$ for high loss. For the DV protocols (dashed lines), we consider: BB84 with single-photon sources [1] with rate $\eta/2$; BB84 with weak coherent pulses and decoy states [45] with rate $\eta/(2e)$; and DV-MDI-QKD [31, 32] with rate $\eta/(2e^2)$.

with E being the thermal mode. This channel is central for quantum communications at the microwave regime but also important for CV QKD [36] at optical and telecom frequencies, where Gaussian eavesdropping via entangling cloners results into a thermal-loss channel [14].

For an arbitrary thermal-loss channel $\mathcal{E}_{\eta, \bar{n}}$ we apply our reduction method and compute the entanglement flux

$$\Phi(\eta, \bar{n}) \leq -\log_2 [(1 - \eta)\eta^{\bar{n}}] - h(\bar{n}), \quad (16)$$

for $\bar{n} < \eta/(1 - \eta)$, while zero otherwise. In the previous formula we have set $h(x) := (x + 1) \log_2(x + 1) - x \log_2 x$. Combining this result with the lower bound given by the reverse coherent information [17], we write the following inequalities for the two-way capacity of this channel

$$-\log_2(1 - \eta) - h(\bar{n}) \leq \mathcal{C}(\eta, \bar{n}) \leq \Phi(\eta, \bar{n}). \quad (17)$$

As shown in Fig. 6a, the two bounds tend to coincide at sufficiently high transmissivity. We clearly retrieve the previous result of the lossy channel for $\bar{n} = 0$.

Another important Gaussian channel in bosonic communications is the quantum amplifier. This is a crucial element in quantum cloning [48], therefore playing a non-trivial role in eavesdropping strategies against CV QKD. This channel $\mathcal{E}_{g, \bar{n}}$ is described by $\hat{\mathbf{x}} \rightarrow \sqrt{g}\hat{\mathbf{x}} + \sqrt{g-1}\hat{\mathbf{x}}_E$, where $g > 1$ is the gain and E is the thermal environment

with \bar{n} mean photons. We compute the entanglement flux

$$\Phi(g, \bar{n}) \leq \log_2 \left(\frac{g^{\bar{n}+1}}{g-1} \right) - h(\bar{n}), \quad (18)$$

for $\bar{n} < (g-1)^{-1}$, while zero otherwise. Combining this result with the coherent information [47], we get

$$\log_2 \left(\frac{g}{g-1} \right) - h(\bar{n}) \leq \mathcal{C}(g, \bar{n}) \leq \Phi(g, \bar{n}), \quad (19)$$

whose behavior is plotted in Fig. 6b. We note that the two bounds tend to coincide at low gains.

In the absence of thermal noise ($\bar{n} = 0$), the previous channel describes a quantum-limited amplifier \mathcal{E}_g , for which the bounds in Eq. (19) coincide. This channel is therefore distillable and its two-way capacities are

$$\mathcal{C}(g) = D_2(g) = Q_2(g) = K(g) = \log_2 \left(\frac{g}{g-1} \right). \quad (20)$$

In particular, this proves that $Q_2(g)$ coincides with the unassisted quantum capacity $Q(g)$ [47, 49]. The result of Eq. (20) sets the fundamental limit for quantum communication, entanglement distillation and secret-key generation using deterministic quantum optical amplifiers. We see that infinite amplification is useless. Then, for an amplifier with typical gain 2, the maximum achievable rate for quantum communication is just 1 qubit per use.

Finally, one of the simplest models of bosonic decoherence is the additive-noise Gaussian channel [14]. This is the direct extension of the classical model of a Gaussian channel to the quantum regime. It can be seen as the action of a random Gaussian displacement over incoming states. In terms of input-output transformations, it is described by $\hat{\mathbf{x}} \rightarrow \hat{\mathbf{x}} + (z, z)^T$ where z is a classical Gaussian variable with zero mean and variance $\xi \geq 0$. For this channel \mathcal{E}_ξ we find the entanglement flux

$$\Phi(\xi) \leq \frac{\xi - 1}{\ln 2} - \log_2 \xi, \quad (21)$$

for $\xi < 1$, while zero otherwise. Including the lower bound given by the coherent information [47], we get

$$-\frac{1}{\ln 2} - \log_2 \xi \leq \mathcal{C}(\xi) \leq \Phi(\xi). \quad (22)$$

In Fig. 6c, see its behavior and how the two bounds tend to rapidly coincide for small added noise.

It is interesting to note how quantum communication rapidly degrades when we compose quantum channels. For instance, a quantum-limited amplifier with gain 2 can transmit $Q_2 = 1$ qubit per use from Alice to Bob. This is the same amount which can be transmitted from Bob to Charlie, through a lossy channel with transmissivity 1/2. By using Bob as a quantum repeater, Alice can therefore transmit at least 1 qubit per use to Charlie. If we remove Bob, and we compose the two channels, we obtain an additive-noise Gaussian channel with variance $\xi = 1/2$, for which $Q_2 \lesssim 0.278$ qubits per use.

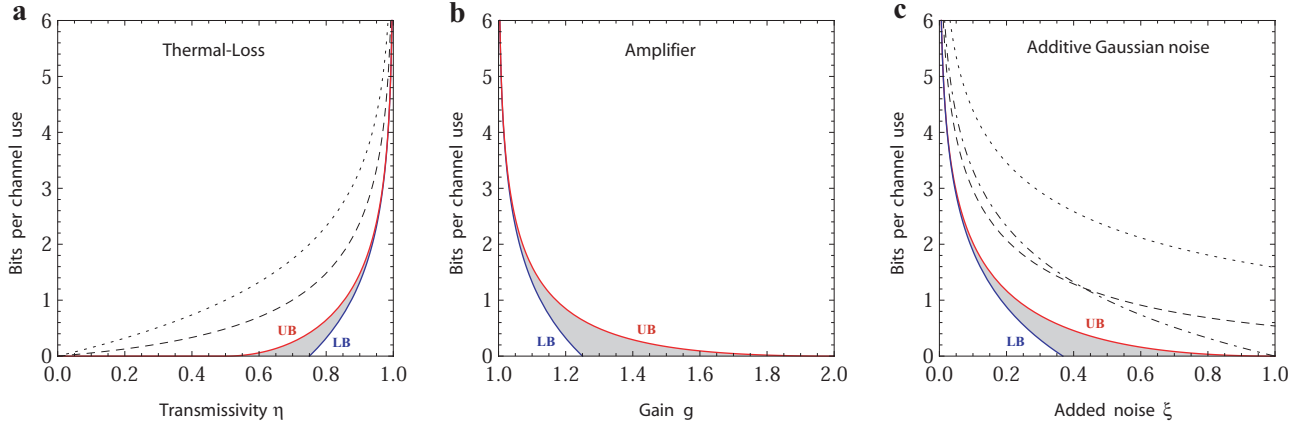

FIG. 6: Two-way capacities for Gaussian channels in terms of the relevant channel parameters. **a** Two-way capacity $\mathcal{C}(\eta, \bar{n})$ of the thermal-loss channel as a function of transmissivity η for $\bar{n} = 1$ thermal photon. It is contained in the shadowed area identified by the upper bound (UB) and lower bound (LB) of Eq. (17). Our upper bound is clearly tighter than those based on the squashed entanglement, computed in Ref [18] (dotted) and Ref. [46] (dashed). Note that $\mathcal{C}(\eta, \bar{n}) \simeq -\log_2(1 - \eta) - h(\bar{n})$ at high transmissivities. For $\bar{n} = 0$ (lossy channel) the shadowed region shrinks into a single line. **b** Two-way capacity $\mathcal{C}(g, \bar{n})$ of the amplifier channel as a function of the gain g for $\bar{n} = 1$ thermal photon. It is contained in the shadowed specified by the bounds in Eq. (19). For small gains, we have $\mathcal{C}(g, \bar{n}) \simeq \log_2[g/(g - 1)] - h(\bar{n})$. For $\bar{n} = 0$ (quantum-limited amplifier) the shadowed region shrinks into a single line. **c** Two-way capacity $\mathcal{C}(\xi)$ of the additive-noise Gaussian channel with added noise ξ . It is contained in the shadowed region specified by the bounds in Eq. (22). For small noise, we have $\mathcal{C}(\xi) \simeq -1/\ln 2 - \log_2 \xi$. Our upper bound is much tighter than those of Ref. [18] (dotted), Ref. [46] (dashed), and Ref. [47] (dot-dashed).

C. Ultimate limits in qubit communications

We now study the ultimate rates for quantum communication, entanglement distillation and secret key generation through the most important qubit channels. The quantum channels we are going to consider are present in a plethora of scenarios. For instance they may describe relaxation and dephasing effects in quantum memories, where communication is intended in time, from the storage to the retrieval of quantum information. They are the most common form of decoherence in quantum information processing. For instance, they can be found at the chip-scale level, e.g., in quantum computers based on trapped ions, atoms or superconducting qubits, but also in a model of distributed quantum computer or quantum Internet [3], which exploits elements as optical cavities.

Amplitude damping channel.— One of the most typical forms of decoherence in any two-level quantum system, such as a spin or an optical cavity, is energy dissipation or damping. The action of an amplitude damping channel over an input qubit is described by the Kraus decomposition $\mathcal{E}_{\text{damp}}(\rho) = \sum_{i=0,1} A_i \rho A_i^\dagger$, where

$$A_0 := |0\rangle\langle 0| + \sqrt{1-p}|1\rangle\langle 1|, \quad A_1 := \sqrt{p}|0\rangle\langle 1|, \quad (23)$$

and p is the probability of damping.

This channel is partly-stretchable, decomposable as

$$\mathcal{E}_{\text{damp}} = \mathcal{E}_{\text{CV} \rightarrow \text{DV}} \circ \mathcal{E}_{\eta(p)} \circ \mathcal{E}_{\text{DV} \rightarrow \text{CV}}, \quad (24)$$

where $\mathcal{E}_{\text{DV} \rightarrow \text{CV}}$ is an identity mapping from the original qubit to a single-rail qubit, which is the subspace of a

bosonic mode spanned by the vacuum and the single-photon states; then, $\mathcal{E}_{\eta(p)}$ is a lossy channel with transmissivity $\eta(p) := 1 - p$; finally, $\mathcal{E}_{\text{CV} \rightarrow \text{DV}}$ is an identity mapping from the single-rail qubit to the original qubit. The mappings can be realized via hybrid teleportation.

Using Eq. (10) of our reduction method, we may write

$$\rho_{\text{ab}}^n := \rho_{\text{ab}}(\mathcal{E}_{\text{damp}}^{\otimes n}) = \bar{\Lambda} \left(\rho_{\mathcal{E}_{\eta(p)}}^{\otimes n} \right), \quad (25)$$

and the corresponding upper bound

$$\mathcal{C}(\mathcal{E}_{\text{damp}}) \leq \Phi[\mathcal{E}_{\eta(p)}] = -\log_2 p. \quad (26)$$

The best lower bound is given by the reverse coherent information [22], so that we may write

$$\max_u \{H_2(u) - H_2(up)\} \leq \mathcal{C}(\mathcal{E}_{\text{damp}}) \leq -\log_2 p. \quad (27)$$

More precisely, we may refine the latter inequality by using $\max\{1, -\log_2 p\}$, since the input alphabet is restricted to one bit. The two-way capacity is analyzed in Fig. 7a, where we also see the separation from the unassisted quantum capacity Q , first noted in Ref. [22].

Qubit Pauli channels.— A general error model which describes both the manipulation and transmission of qubits is the Pauli channel. Specific examples are the depolarising channel, which uniformly shrinks the Bloch sphere, and the dephasing channel, which causes loss of quantum information without energy decay. In particular, phase damping describes processes such as spin-spin relaxation and the scattering of photonic qubits through waveguides. Phase damping is at the basis of the loss of coherence in many quantum systems, especially in circuit quantum electrodynamics [50].

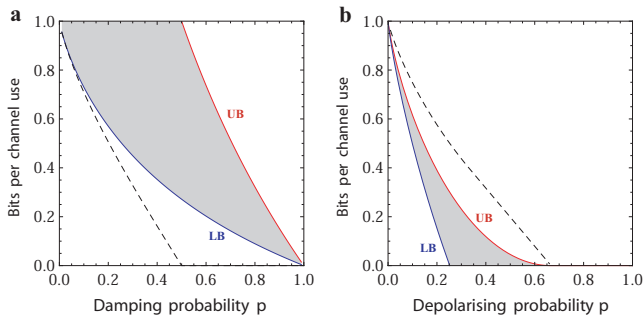

FIG. 7: Two-way capacities for basic qubit channels. **a** Two-way capacity of the amplitude damping channel $\mathcal{E}_{\text{damp}}$ with probability p . It is contained in the shadowed area identified by the upper bound (UB) and lower bound (LB) of Eq. (27). Note the separation from the Q of the channel (dashed). **b** Two-way capacity of the depolarising channel $\mathcal{P}_{\text{depol}}$ with probability p . It is contained in the shadowed specified by the bounds in Eq. (32). Our upper bound is tighter than the best known squashed-entanglement bound [46] (dashed).

In general, a qubit Pauli channel can be written as

$$\mathcal{P}(\rho) = p_0\rho + p_1X\rho X + p_2Y\rho Y + p_3Z\rho Z, \quad (28)$$

where X , Y , and Z are Pauli operators [15] and $\mathbf{p} := \{p_k\}$ is a probability distribution. It is easy to check that this channel is stretchable and its Choi matrix is Bell-diagonal. We compute the entanglement flux exactly as

$$\Phi(\mathcal{P}) = 1 - H_2(p_{\max}), \quad (29)$$

if $p_{\max} := \max\{p_k\} \geq 1/2$, while zero otherwise. Since the channel is unital, we have that $I_C(\mathcal{P}) = I_{RC}(\mathcal{P}) = 1 - H(\mathbf{p})$, where H is the Shannon entropy. Thus, the two-way capacity of a Pauli channel satisfies

$$1 - H(\mathbf{p}) \leq \mathcal{C}(\mathcal{P}) \leq \Phi(\mathcal{P}). \quad (30)$$

Let us specify the latter result to the case of a depolarising channel, which is defined by a particular choice of the probability distribution \mathbf{p} in such a way that the three Pauli operators are equiprobable. This is equivalent to say that the input state becomes a maximally mixed state with some probability p , i.e., we have

$$\mathcal{P}_{\text{depol}}(\rho) = (1 - p)\rho + pI/2. \quad (31)$$

Let us set $\kappa(p) := 1 - H_2(3p/4)$, then we may write

$$\kappa(p) - \frac{3p}{4} \log_2 3 \leq \mathcal{C}(\mathcal{P}_{\text{depol}}) \leq \kappa(p), \quad (32)$$

for $p \leq 2/3$, while 0 otherwise. The behavior of this two-way capacity is plotted in Fig. 7b.

Let us now consider the dephasing channel, which is a qubit Pauli channel where only the Z error is involved with some probability p . This channel can be written as

$$\mathcal{P}_{\text{deph}}(\rho) = (1 - p)\rho + pZ\rho Z. \quad (33)$$

From Eq. (30) we can easily check that the two bounds coincide, so that this channel is distillable and all its two-way capacities are determined

$$\begin{aligned} \mathcal{C}(\mathcal{P}_{\text{deph}}) &= D_2(\mathcal{P}_{\text{deph}}) = Q_2(\mathcal{P}_{\text{deph}}) \\ &= K(\mathcal{P}_{\text{deph}}) = 1 - H_2(p). \end{aligned} \quad (34)$$

In particular, we find $Q_2 = Q$ for this channel [51], so that feedback CCs do not increase the capacity.

Quantum erasure channel.— Finally, the simplest error model for a qubit is the erasure channel. This is not a Pauli channel and its action is simply described by

$$\mathcal{E}_{\text{erase}}(\rho) = (1 - p)\rho + p|e\rangle\langle e|, \quad (35)$$

where p is the probability that the input state is transformed into an orthogonal erasure state $|e\rangle$ (outside the state space of the input qubit). For this channel, we already know that $Q_2(\mathcal{E}_{\text{erase}}) = 1 - p$ [16]. We now extend this result to the secret key capacity.

Following Ref. [16], one shows that $D_1(\rho_{\mathcal{E}_{\text{erase}}}) \geq 1 - p$. In fact, suppose that Alice sends halves of EPR states to Bob. A fraction $1 - p$ will be perfectly distributed. These good cases can be identified by Bob applying the measurement $\{|e\rangle\langle e|, I - |e\rangle\langle e|\}$ on each output system, and communicating the results back to Alice in a single and final CC. Therefore, they distill at least $1 - p$ ebits per copy. It is then easy to check that this channel is stretchable and its entanglement flux is $\Phi(\rho_{\mathcal{E}_{\text{erase}}}) \leq 1 - p$. Thus, the erasure channel is distillable and we may write

$$\mathcal{C}(\mathcal{E}_{\text{erase}}) = K(\mathcal{E}_{\text{erase}}) = 1 - p. \quad (36)$$

D. Ultimate limits in arbitrary finite dimension

We can generalize our results to channels acting on a qudit of arbitrary dimension $d \geq 2$ and computational basis $\{|j\rangle\}$. Let us start with the generalized depolarising channel, which is defined as in Eq. (31) up to using the mixed state I/d . Setting $f := p(d^2 - 1)/d^2$ and $\kappa(d, p) := \log_2 d - H_2(f) - f \log_2(d - 1)$, we extend Eq. (32) into

$$\kappa(d, p) - f \log_2(d + 1) \leq \mathcal{C}(\mathcal{P}_{\text{depol}}) \leq \kappa(d, p). \quad (37)$$

Then, the generalized dephasing channel is defined as

$$\mathcal{P}_{\text{deph}}(\rho) = \sum_{i=0}^{d-1} P_i Z^i \rho (Z^\dagger)^i \quad (38)$$

where P_i is the probability of i phase flips, with a single flip being $Z|j\rangle = e^{ij2\pi/d}|j\rangle$. This channel is distillable and its two-way capacities are functionals of $\mathbf{P} = \{P_i\}$

$$\mathcal{C}(\mathcal{P}_{\text{deph}}) = \log_2 d - H(\mathbf{P}). \quad (39)$$

Finally, the generalized erasure channel is defined as in Eq. (35), where ρ is now the qudit input state and the erasure state $|e\rangle$ lives in the extra $d + 1$ dimension. We can easily generalize the previous derivations to find that this channel is distillable and

$$K(\mathcal{E}_{\text{erase}}) = (1 - p) \log_2 d. \quad (40)$$

II. DISCUSSION

Summary.— In this work we have established the fundamental limits of quantum communication, entanglement distillation and secret key generation in the absence of quantum repeaters. On the one hand, these limits tell us the optimal rates that direct point-to-point protocols can achieve; on the other, they provide the fundamental benchmarks that quantum repeaters must surpass in order to be effective devices. We have determined these limits at any dimension, from qubits to bosonic systems.

In order to achieve our results we have designed a powerful reduction method: This combines the relative entropy of entanglement, suitably extended to quantum channels, with a teleportation-based technique, dubbed teleportation stretching. This method reduces the most general adaptive protocol implemented over a wide family of quantum channels to the computation of a simple one-shot quantity, the entanglement flux. This is shown to be the tightest upper bound for the two-way capacities (Q_2 , D_2 and K) of the most important quantum channels in both discrete- and continuous-variable settings.

In fact, combining our upper bound with suitable lower bounds, we have established simple and coincident formulas for the various two-way capacities ($Q_2 = D_2 = K$) of the bosonic lossy channel, the quantum-limited amplifier, and the dephasing channel in arbitrary dimension, besides the secret-key capacity K of the erasure channel in arbitrary dimension. All these results have been obtained after about 20 years since the first studies [16, 24]. For the specific analysis of the bosonic channels, we have also extended the hashing inequality to CV systems and proven a simple formula for computing the relative entropy of two arbitrary Gaussian states.

Our result for the lossy channel completely characterizes the long-sought and fundamental rate-loss scaling which affects any quantum optical communication, setting the ultimate achievable rate for repeaterless QKD at $-\log_2(1 - \eta)$ bits per channel use, i.e., about 1.44η bits per use at high loss. This confirms a prediction from 2009 [17], which definitely inspired all these explorations. It also confirms the original intuition on the potentialities of the reverse reconciliation technique which dates back to the seminal 2003 experiment on high-rate QKD [42].

Other aspects.— Consider a time cost for the CCs, since these are ultimately restricted by the speed of light. On this basis, one may argue that unassisted or forward-assisted protocols might be faster than two-way assisted protocols in practical implementations. In fact, this could happen if CCs are needed for each use of the quantum channel. Our work shows that this practical caveat does not hold for distillable channels.

For distillable \mathcal{E} we have $\mathcal{C}(\mathcal{E}) = \Phi(\mathcal{E}) = D_1(\rho_{\mathcal{E}})$, which means that any adaptive protocol can be reduced to Alice and Bob distributing EPR pairs. At the end of this distribution, a single round of CCs (forward or backward) is sufficient for implementing entanglement distillation. Then, qubits can be teleported over the distilled pairs

using another single round of CCs, now forward from Alice to Bob. It is clear that the time cost associated with two rounds of CCs is negligible in the limit of many uses of the channel. However, also notice the using final LOCCs imply the availability of quantum memories.

Another aspect is the assumption of energy constraints at the input of bosonic channels. It is clear that these constraints are artificial since the two-way capacities D_2 , Q_2 and K are already bounded by quantum mechanics. Furthermore, constrained upper bounds cannot provide benchmarks for quantum repeaters (just use a more energetic protocol at the input). In any case, it is interesting to note that our bound for the lossy channel $-\log_2(1 - \eta)$ remains tight even if we constrain the input energy down to about one photon, beating any energy-constrained bound based on the squashed entanglement.

Immediate developments and future directions.— As previously said, our reduction method (‘REE plus teleportation’) is very general and can be used well beyond the scope of this work. Indeed it has been already used to extend the present results to the presence of quantum repeaters. More precisely, Ref. [52] has shown that the various two-way capacities here determined can be suitably extended to establish the repeater-assisted capacities in a chain of quantum repeaters and the end-to-end capacities between two remote points of a quantum network.

Our reduction method can immediately be used to determine the strong converse rates for secure quantum communication (see the remarks in the following note added). Other scenarios to consider, and to be solved in full generality, is the quantum broadcast channel, the quantum multiple-access channel and the all-in-all quantum communication. Finally, further efforts should be made to improve the bounds for some of the channels that we studied, in particular, the thermal-loss channel and the amplitude damping channel.

III. METHODS

In this Methods’ section we provide a summary of the contents of the Supplementary Material.

- Supplementary Section I: We give full details of the lower bound based on the coherent and reverse coherent information at any dimension. We show how to extend the hashing inequality to CV systems and unbounded Choi matrices of bosonic channels.

- Supplementary Section II: We prove our weak converse Theorem 1, which establishes the general upper bound based on the REE of the channel, valid at any dimension (finite or infinite).

- Supplementary Section III: We provide preliminary notions on quantum teleportation, including hybrid teleportation and mappings between DVs and CVs.

- Supplementary Section IV: We discuss the tool of teleportation channel and we introduce the notion of stretchable channels. Next, we provide full details of the

technique of teleportation stretching proving the various decompositions of the output state in terms of the Choi matrices, for stretchable, partly-stretchable and weakly-stretchable channels. Finally, we provide a detailed discussion on the relations between teleportation stretching and previous literature.

- Supplementary Section V: We show the results for the quantum feedback channel.
- Supplementary Section VI: We show the results for the multiband quantum channel.
- Supplementary Section VII: We provide the basic tools for proving the results for the bosonic Gaussian channels. After some basic notions, we prove our formula for the relative entropy between two arbitrary multimode Gaussian states, directly expressed in terms of their statistical moments.
- Supplementary Section VIII: We give the main derivations for the bosonic Gaussian channels. First we discuss the lower bound of the coherent and reverse coherent information, also including a discussion of the lower bound of Ref. [17]. Then, we compute the entanglement flux of the various Gaussian channels. We finish with a discussion of the potential use of energy constraints.
- Supplementary Section IX: We give the main derivations for the discrete-variable channels.
- Supplementary Section X: We provide details on the ideal rates of current QKD protocols.

IV. NOTE ADDED FOR THE ARXIV

This manuscript merges our previous arXiv submissions, Ref. [54] and Ref. [55], into a single theoretical paper. With respect to these previous works we have improved the bound for the depolarising channel, included the amplitude damping channel, extended some results to qudits, and included the multiband quantum channel. We have also performed a more extensive review of the literature and expressed teleportation stretching in a more general fashion. Let us provide here a schematic list of our key findings.

Summary of key findings

1. We have designed a **reduction method** which simplifies any quantum protocol for quantum communication, entanglement distillation and secret key generation which is based on the use of unlimited two-way CCs and adaptive local operations (adaptive LOCCs). This has been possible by combining two main ingredients:
 - 1.1) **Teleportation stretching.** This technique reduces the adaptive uses of a quantum channel into an ensemble of Choi matrices, not necessarily of the same channel, plus final LOCCs. Teleportation stretching achieves this goal for a completely

general adaptive protocol whose target is an arbitrary output state for the two parties. It considers any dimension (finite or infinite) and can be implemented over an extremely wide family of quantum channels, identified as those which commute or partially commute with teleportation. It non-trivially extends the tool of teleportation channel [24] into a general form which can be actively exploited for the study of any two-way adaptive protocol.

1.2) The other ingredient is the extension of the notion of the relative entropy of entanglement from states to channels. This allows one to bound the optimal rate of an arbitrary adaptive protocol. In combination with teleportation stretching we can completely discard all the adaptive LOCCs of the protocol and bound its performance with a computable one-shot quantity, the **entanglement flux**. This is the content of our Theorems 1 and 2. Thus, the key insight of the entire reduction method relies in the suitable combination of the ingredients from (1.1) and (1.2).

2. We have shown that the entanglement flux is the **tightest upper bound** ever designed for bounding the two-way capacities of the most important qubit, qudit and bosonic channels.
3. By using the same method, we have determined the **two-way capacities** (Q_2 , D_2 and K) of the bosonic lossy channel, the quantum-limited amplifier, the dephasing channel in arbitrary dimension, and the secret key capacity K of the erasure channel in arbitrary dimension. All these capacities have extremely simple formulas. For the specific case of the erasure channel, let us note that Ref. [55] has been the first paper to write down its secret key capacity. However, one can also independently derive this capacity from the results of Ref. [46].
4. We have finally characterized the **fundamental rate-loss tradeoff** affecting quantum optical communications, so that repeaterless QKD is restricted to 1.44η bits per channel use at long distances.
5. We have extended the **hashing inequality** to continuous variable systems and, in particular, to the unbounded Choi matrices of bosonic channels.
6. We have proven a computable **formula for the relative entropy** between two arbitrary Gaussian states. This formula does not involve residual symplectic decompositions being directly expressed in terms of the statistical moments of the Gaussian states, i.e., their mean values and covariance matrices. Therefore, it supersedes any previous implicit expression where the symplectic decompositions have still to be carried out, such as Ref. [56] which cannot be used for general analytical computations. Our formula is derived starting from a

Gibbs-exponential form for Gaussian states directly expressed in terms of the statistical moments [53].

Remarks on some recent uses of our reduction method ‘REE+teleportation’

We acknowledge that several authors have readily exploited our reduction method which **combines the relative entropy of entanglement with quantum teleportation** (fully described in Section IA and first introduced in Refs. [54, 55]). In particular:

- Ref. [57] has used exactly our reduction method to find the upper bound of the specific 1-to-2 lossy broadcast channel (cf abstract: “*We also evaluate an outer bound on the region by using the relative entropy of entanglement and a ‘reduction by teleportation’ technique*”). What they call ‘teleportation-covariant channels’ are the stretchable channels defined in Ref. [55]. What they call ‘reduction by teleportation’ is a particular case of teleportation stretching applied to secret key distribution with CVs. To ‘reduce by teleportation’ the CV broadcast protocol, these authors should explicitly handle the Hilbert space’s cut-off by using suitable sequences of states converging to the bosonic Choi matrices. Then they need to exploit the lower semi-continuity of the relative entropy and the continuity of the coherent information. These are clearly the contents of Refs. [54, 55], but only Section V of Ref. [24] is cited for this teleportation reduction.

- Then Ref. [58] has used our reduction method to find strong converse rates for private quantum communication (cf abstract: “*The meta-converse allows for proving that any quantum channel’s relative entropy of entanglement is a strong converse rate for private communication. For covariant channels, the meta-converse also leads to second-order expansions of relative entropy of entanglement bounds for private communication rates.*”). What they call ‘covariant channels’ or ‘teleportation-simulable

channels’ are again stretchable channels. In their derivations, they clearly exploit the more general formulation of teleportation stretching, since they deal with secret key rates in both DV and CV channels. They use the notion of channel’s relative entropy of entanglement, first introduced in Refs. [54, 55]. It is very good that these authors use all our two-way capacities (for the lossy channel, quantum limited amplifier, dephasing channel, and erasure channel) to achieve their interesting results, but we also find that Refs. [54, 55] have been often misquoted.

While we are delighted that our ideas have contributed to boost this recent research, we would also appreciate to receive explicit credit for the basic methodology we brought to the field, i.e., the introduction of the channel’s relative entropy of entanglement whose combination with quantum teleportation reduces the study of adaptive protocols. This ‘REE+teleportation’ method is an important legacy of Refs. [54, 55], at the very basis of Refs. [57, 58]. It is merit of our Section IA if former results based on the squashed entanglement, i.e., Refs. [59, 60], have been improved to Refs. [57, 58].

This was explicitly suggested in version 2 of our paper (page 6 of <http://arxiv.org/pdf/1510.08863v2.pdf>), where we wrote: “*This novel technique has application that goes well beyond this paper. For instance, it can be used to derive the capacity of the bosonic broadcast channel [arXiv:1503.08139v1 (2015)] and to improve the converse rates for quantum communication in the case of DV systems [arXiv:1406.2946v2 (2014)].*”

Acknowledgments. Authors would like to thank A. Winter, S. L. Braunstein, S. Mancini, F. Grosshans, G. Adesso, C. Lupo, L. Jiang, T. Cope, and K. Goodenough for discussions and comments. S.P., R.L. and C.O. thank support from the EPSRC via the ‘UK Quantum Communications Hub’ (EP/M013472/1). L.B. acknowledges financial support from the ERC (Starting Grant 308253 PACOMANEDIA).

-
- [1] Bennett, C. H. & Brassard, G. Quantum cryptography: Public key distribution and coin tossing. *Proc. IEEE International Conf. on Computers, Systems, and Signal Processing, Bangalore*, pp. 175–179 (1984).
- [2] Ekert, A. K. Quantum Cryptography based on Bell’s Theorem. *Phys. Rev. Lett.* **67**, 661–663 (1991).
- [3] Kimble, H. J. The quantum internet. *Nature* **453**, 1023 (2008).
- [4] Pirandola, S. *et al.* Advances in quantum teleportation. *Nature Photon.* **9**, 641–652 (2015).
- [5] Andersen, U. L., Neergaard-Nielsen, J. S., van Loock, P. & Furusawa, A. Hybrid discrete- and continuous-variable quantum information. *Nature Phys.* **11**, 713–719 (2015).
- [6] Xiang, Z.-L., Ashhab, S., You, J. Q. & Nori, F. Hybrid quantum circuits: Superconducting circuits interacting with other quantum systems. *Rev. Mod. Phys.* **85**, 623–653 (2013).
- [7] Kurizki, G. *et al.* Quantum technologies with hybrid systems. *Proc. Natl. Acad. Sci. USA* **112**, 3866–73 (2015).
- [8] Briegel, H.-J., Dür, W., Cirac, J. I. & Zoller, P. Quantum repeaters: The role of imperfect local operations in quantum communication. *Phys. Rev. Lett.* **81**, 5932–5935 (1998).
- [9] Vedral, V., Plenio, M. B., Rippin, M. A. & Knight, P. L. Quantifying Entanglement. *Phys. Rev. Lett.* **78**, 2275–2279 (1997).
- [10] Vedral, V. & Plenio, M. B. Entanglement measures and purification procedures. *Phys. Rev. A* **57**, 1619 (1998).
- [11] Vedral, V. The role of relative entropy in quantum information theory. *Rev. Mod. Phys.* **74**, 197 (2002).
- [12] Bennett, C. H., Brassard, G., Crépeau, C., Jozsa, R., Peres, A. & Wootters, W. K. Teleporting an unknown

- quantum state via dual classical and Einstein-Podolsky-Rosen channels. *Phys. Rev. Lett.* **70**, 1895 (1993).
- [13] Choi, C. Completely Positive Linear Maps on Complex matrices. *Linear Algebra Appl.* **10**, 285–290 (1975).
- [14] Weedbrook, C. *et al.* Gaussian quantum information. *Rev. Mod. Phys.* **84**, 621 (2012).
- [15] Nielsen, M. A. & Chuang, I. L. Quantum computation and quantum information (Cambridge University Press, Cambridge, 2000).
- [16] Bennett, C. H., DiVincenzo, D. P., & Smolin, J. A. Capacities of Quantum Erasure Channels. *Phys. Rev. Lett.* **78**, 3217-3220 (1997).
- [17] Pirandola, S., García-Patrón, R., Braunstein, S. L. & Lloyd, S. Direct and reverse secret-key capacities of a quantum channel. *Phys. Rev. Lett.* **102**, 050503 (2009).
- [18] Takeoka, M., Guha, S. & Wilde, M.M. Fundamental rate-loss tradeoff for optical quantum key distribution. *Nature Comms.* **5**, 5235 (2014).
- [19] Horodecki, K., Horodecki, M., Horodecki, P. & Oppenheim, J. Secure key from bound entanglement. *Phys. Rev. Lett.* **94**, 160502 (2005).
- [20] Schumacher, B. & Nielsen, M. A. Quantum data processing and error correction. *Phys. Rev. A* **54**, 2629 (1996).
- [21] Lloyd, S. Capacity of the noisy quantum channel. *Phys. Rev. A* **55**, 1613 (1997).
- [22] García-Patrón, R., Pirandola, S., Lloyd, S. & Shapiro, J. H. Reverse coherent information. *Phys. Rev. Lett.* **102**, 210501 (2009).
- [23] Devetak, I. & Winter, A. Relating quantum privacy and quantum coherence: an operational approach. *Phys. Rev. Lett.* **93**, 080501 (2004).
- [24] Bennett, C. H., DiVincenzo, D. P., Smolin, J. A. & Wootters, W. K. Mixed-state entanglement and quantum error correction. *Phys. Rev. A* **54**, 3824-3851 (1996).
- [25] Holevo, A. Quantum Systems, Channels, Information: A Mathematical Introduction (De Gruyter, Berlin-Boston, 2012).
- [26] Filip, R. Continuous-variable quantum key distribution with noisy coherent states. *Phys. Rev. A* **77**, 022310 (2008).
- [27] Usenko, V. C. & Filip, R. Feasibility of continuous-variable quantum key distribution with noisy coherent states. *Phys. Rev. A* **81**, 022318 (2010).
- [28] Weedbrook, C. *et al.* Quantum cryptography approaching the classical limit. *Phys. Rev. Lett.* **105**, 110501 (2010).
- [29] Weedbrook, C. *et al.* Continuous-variable quantum key distribution using thermal states. *Phys. Rev. A* **86**, 022318 (2012).
- [30] Weedbrook, C., Ottaviani, C. & Pirandola, S. Two-way quantum cryptography at different wavelengths. *Phys. Rev. A* **89**, 012309 (2014).
- [31] Braunstein, S. L. & Pirandola, S. Side-channel-free quantum key distribution. *Phys. Rev. Lett.* **108**, 130502 (2012).
- [32] Lo, H.-K., Curty, M. & Qi, B. Measurement-Device-Independent Quantum Key Distribution. *Phys. Rev. Lett.* **108**, 130503 (2012).
- [33] Pirandola, S. *et al.* High-rate measurement-device-independent quantum cryptography. *Nature Photon.* **9**, 397-402 (2015).
- [34] Ottaviani, C., Spedalieri, G., Braunstein, S.L. & Pirandola, S. Continuous-variable quantum cryptography with an untrusted relay: Detailed security analysis of the symmetric configuration. *Phys. Rev. A* **91**, 022320 (2015).
- [35] Hosseini-dehaj, N. & Malaney, R. Gaussian entanglement distribution via satellite. *Phys. Rev. A* **91**, 022304 (2015).
- [36] Diamanti, E & Leverrier, A. Distributing Secret Keys with Quantum Continuous Variables: Principle, Security and Implementations. *Entropy* **17**, 6072-6092 (2015).
- [37] Modi, K. *et al.* The classical-quantum boundary for correlations: Discord and related measures. *Rev. Mod. Phys.* **84**, 1655 (2012).
- [38] Pirandola, S. Quantum discord as a resource for quantum cryptography. *Sci. Rep.* **4**, 6956 (2014).
- [39] Pirandola, S., Spedalieri, G., Braunstein, S.L., Cerf, N. J. & Lloyd, S. Optimality of Gaussian discord. *Phys. Rev. Lett.* **113**, 140405 (2014).
- [40] Weedbrook, C. *et al.* Quantum cryptography without switching. *Phys. Rev. Lett.* **93**, 170504 (2004).
- [41] Spedalieri, G. *et al.* Quantum cryptography with an ideal local relay. *Proceedings of the SPIE Security + Defence 2015 conference on Quantum Information Science and Technology*, Toulouse, France (21-24 September 2015).
- [42] Grosshans, F. *et al.* Quantum key distribution using gaussian-modulated coherent states. *Nature* **421**, 238-241 (2003).
- [43] Pirandola, S., Mancini, S., Lloyd, S. & Braunstein, S. L. Continuous-variable quantum cryptography using two-way quantum communication. *Nature Phys.* **4**, 726 (2008).
- [44] Ottaviani, C. & Pirandola S. General immunity and superadditivity of two-way Gaussian quantum cryptography. *Sci. Rep.* **6**, 22225 (2016).
- [45] Scarani, V. *et al.* The security of practical quantum key distribution. *Rev. Mod. Phys.* **81**, 1301, (2009).
- [46] Goodenough, K., Elkouss, D. & Wehner, S. Assessing the performance of quantum repeaters for all phase-insensitive Gaussian bosonic channels. *Preprint arXiv:1511.08710v1* (2015).
- [47] Holevo, A. S. & Werner, R. F. Evaluating capacities of bosonic Gaussian channels. *Phys. Rev. A* **63**, 032312 (2001).
- [48] Braunstein, S. L., Cerf, N. J., Iblisdir, S., van Loock, P. & Massar, S. Optimal Cloning of Coherent States with a Linear Amplifier and Beam Splitters. *Phys. Rev. Lett.* **86**, 4938 (2001).
- [49] Wolf, M. M., Pérez-García, D. & Giedke, G. Quantum Capacities of Bosonic Channels. *Phys. Rev. Lett.* **98**, 130501 (2007).
- [50] Schoelkopf, R. J. & Girvin, S. M. Wiring up quantum systems. *Nature* **451**, 664-669 (2008).
- [51] Devetak, I. & Shor, P.W. The Capacity of a Quantum Channel for Simultaneous Transmission of Classical and Quantum Information, *Commun. Math. Phys.* **256**, 287–303 (2005).
- [52] Pirandola, S. Optimal Performance of a Quantum Network. *Preprint arXiv:1601.00966* (2016).
- [53] Banchi, L., Braunstein, S.L. & Pirandola, S. Quantum fidelity for arbitrary Gaussian states. *Phys. Rev. Lett.* **115**, 260501 (2015).
- [54] Pirandola, S. Laurenza, R., Ottaviani, C. & Banchi, L. *Preprint arXiv:1510.08863* (2015).
- [55] Pirandola, S. & Laurenza, R. General Benchmarks for Quantum Repeaters. *Preprint arXiv:1512.04945* (2015).
- [56] Chen, X.-y. Gaussian relative entropy of entanglement. *Phys. Rev. A* **71**, 062320 (2005).
- [57] Takeoka, M., Seshadreesan, K. P. & Wilde, M. M. Un-

constrained distillation capacities of a pure-loss bosonic broadcast channel. *Preprint arXiv:1601.05563v1* (2016).

- [58] Wilde, M. M., Tomamichel, M. & Berta, M. Converse bounds for private communication over quantum channels. *Preprint arXiv:1602.08898v1* (2016).
- [59] Seshadreesan, K. P. , Takeoka, M. & Wilde M. M. Bounds on entanglement distillation and secret key agreement for quantum broadcast channels. *Preprint arXiv:1503.08139* (2015).
- [60] Tomamichel, M., Wilde, M. M. & Winter, A. Strong converse rates for quantum communication. *Preprint arXiv:1406.2946* (2014).

Supplementary Material

I. LOWER BOUND AT ANY DIMENSION

A. Coherent and reverse coherent information of a quantum channel

Consider a quantum channel \mathcal{E} applied to some input state ρ_A of system A . Let us introduce the purification $|\psi\rangle_{RA}$ of ρ_A by means of an auxiliary system R . We can therefore consider the output $\rho_{RB} = (\mathcal{I} \otimes \mathcal{E})(|\psi\rangle_{RA}\langle\psi|)$. By definition, the coherent information is [S1, S2]

$$I_C(\mathcal{E}, \rho_A) = I(A\langle B)_{\rho_{RB}} = S(\rho_B) - S(\rho_{RB}) , \quad (\text{S1})$$

where $\rho_B := \text{Tr}_R(\rho_{RB})$ and $S(\rho) := -\text{Tr}(\rho \log_2 \rho)$ is the von Neumann entropy. Similarly, the reverse coherent information is given by [S3, S4]

$$I_{RC}(\mathcal{E}, \rho_A) = I(A\langle B)_{\rho_{RB}} = S(\rho_R) - S(\rho_{RB}) , \quad (\text{S2})$$

where $\rho_R := \text{Tr}_B(\rho_{RB})$.

When the input state ρ_A is a maximally-mixed state, its purification is a maximally-entangled state Φ_{RA} , so that ρ_{RB} is the Choi matrix of the channel, i.e., $\rho_{\mathcal{E}}$. We then define the coherent information of the channel as

$$I_C(\mathcal{E}) = I(A\langle B)_{\rho_{\mathcal{E}}} . \quad (\text{S3})$$

Similarly, its reverse coherent information is

$$I_{RC}(\mathcal{E}) = I(A\langle B)_{\rho_{\mathcal{E}}} . \quad (\text{S4})$$

Note that for unital channels, i.e., channels preserving the identity $\mathcal{E}(I) = I$, we have $I_C(\mathcal{E}) = I_{RC}(\mathcal{E})$. This is just a consequence of the fact that, the reduced states ρ_A and ρ_R of a maximally entangled state Φ_{RA} is a maximally-mixed state I/d , where d is the dimension of the Hilbert space (including the limit for $d \rightarrow +\infty$). If the channel is unital, also the reduced state $\rho_B = \mathcal{E}(\rho_A)$ is maximally-mixed. As a result, $S(\rho_B) = S(\rho_A) = S(\rho_R)$ and we may write $I_C(\mathcal{E}) = I_{RC}(\mathcal{E}) := I_{(R)C}(\mathcal{E})$.

In the specific case of discrete-variable systems ($d < +\infty$), we have $S(\rho_R) = \log_2 d$ and therefore

$$I_{(R)C}(\mathcal{E}) = \log_2 d - S(\rho_{\mathcal{E}}) . \quad (\text{S5})$$

In particular, for unital qubit channels ($d = 2$), one has

$$I_{(R)C}(\mathcal{E}) = 1 - S(\rho_{\mathcal{E}}) . \quad (\text{S6})$$

The latter two formulas will be exploited to compute the coherent information of discrete-variable channels.

The coherent information is an achievable rate for *forward* one-way entanglement distillation. Similarly, the reverse coherent information is an achievable rate for *backward* one-way entanglement distillation (i.e., assisted by a single and final CC from Bob to Alice). In fact, thanks to the hashing inequality [S5], we may write

$$\begin{aligned} \max\{I_C(\mathcal{E}), I_{RC}(\mathcal{E})\} = \\ \max\{I(A\langle B)_{\rho_{\mathcal{E}}}, I(A\langle B)_{\rho_{\mathcal{E}}}\} \leq D_1(\rho_{\mathcal{E}}). \end{aligned} \quad (\text{S7})$$

B. Hashing inequality in infinite dimension

The hashing inequality is known to be valid for finite-dimensional quantum systems. Here we show that it also applies to energy-constrained states in infinite dimension. In this case we can easily show the continuity of the (reverse) coherent information in the limit of infinite dimension, which allows us to extend the hashing inequality.

Consider a two-mode state ρ_{AB} where each mode has $\leq \bar{n}$ mean photons. We can always find a finite-dimensional projector \hat{P}_γ such that

$$\text{Tr} \left(\rho_{AB} \hat{P}_\gamma \right) \geq 1 - \gamma, \quad (\text{S8})$$

where $\gamma = 2\bar{n}/(D^2 + 1)$, with D being the dimension of the truncated Hilbert space \mathcal{H} of each mode (the proof is a trivial adaptation of that in Refs. [S6, S7]).

Let us consider the truncated state

$$\delta_{AB} = [\text{Tr}(\hat{P}_\gamma \rho_{AB})]^{-1} \hat{P}_\gamma \rho_{AB} \hat{P}_\gamma. \quad (\text{S9})$$

Using Eq. (S8), one can write the following inequality

$$\|\rho_{AB} - \delta_{AB}\| \leq 2\varepsilon, \quad (\text{S10})$$

$$\varepsilon := \sqrt{\gamma} + \frac{\gamma}{2(1-\gamma)} = O\left(\frac{\sqrt{\bar{n}}}{D}\right), \quad (\text{S11})$$

where $\|\cdot\|$ is the trace norm. The proof of is a simple modification of the one given by Ref. [S7].

Both ρ_{AB} and δ_{AB} have $\leq 2\bar{n}$ mean photons. The trace-distance condition $\|\rho_{AB} - \delta_{AB}\| \leq 2\varepsilon < 1/3$ implies

$$\begin{aligned} & |S(A|B)_\rho - S(A|B)_\sigma| \\ & \leq 16\varepsilon \log_2 \left[\frac{2e(\bar{n}+1)}{1-\varepsilon} \right] + 32H_2(3\varepsilon), \end{aligned} \quad (\text{S12})$$

where

$$H_2(p) := -p \log_2 p - (1-p) \log_2 (1-p) \quad (\text{S13})$$

is the binary Shannon entropy. This is just Lemma 17 of Ref. [S8] by setting $l = 2$ and $\alpha = 1/2$.

Thus, writing Eq. (S12) for the coherent information $I(A|B) = -S(A|B)$ and using Eq. (S11), we derive

$$\begin{aligned} & |I(A|B)_\rho - I(A|B)_\delta| \leq \\ & O\left(\frac{\sqrt{\bar{n}}}{D}\right) \log_2 \left[\frac{2e(\bar{n}+1)}{1 - O\left(\frac{\sqrt{\bar{n}}}{D}\right)} \right] + 32H_2 \left[O\left(\frac{\sqrt{\bar{n}}}{D}\right) \right] \\ & \rightarrow 0, \text{ for } D \rightarrow +\infty. \end{aligned} \quad (\text{S14})$$

A fully equivalent result holds for the reverse coherent information $I(A|B) = -S(B|A)$.

Thus for any \bar{n} , the (reverse) coherent information is continuous in the limit of infinite dimension. This means that the hashing inequality [S5] is automatically extended to CV systems with constrained energy. In other words, $I(A|B)_\rho$ ($I(A|B)_\rho$) represents an achievable rate for the one-way distillable entanglement of the bounded CV state ρ via forward (backward) CCs.

C. Extension to unbounded Choi matrices of bosonic channels

We can further extend the validity of the hashing inequality to suitably unbounded states. In fact, consider a sequence of two-mode states $\{\rho^\mu\}$ with finite energy μ which converges to an asymptotic unbounded state ρ^∞ , i.e., $\|\rho^\mu - \rho^\infty\| \rightarrow 0$ for $\mu \rightarrow +\infty$. In the same limit, assume that the coherent information $I(A|B)_\mu$ computed on ρ^μ smoothly converges to an asymptotic value $I(A|B)_\infty$. It is easy to conclude that $I(A|B)_\infty$ provides an achievable rate for one-way entanglement distillation over copies of ρ^∞ .

Such an argument is certainly valid for Choi matrices of bosonic channels. Consider the coherent information of a single-mode bosonic channel \mathcal{E} , i.e., $I_C(\mathcal{E}) = I(A|B)_{\rho_\mathcal{E}}$ where $\rho_\mathcal{E} = (\mathcal{I} \otimes \mathcal{E})(\Phi)$ is the Choi matrix computed on the unbounded EPR state Φ . This is a two-mode squeezed vacuum state Φ^μ where the energy $\mu = \bar{n} + 1/2$ is sent to infinite (here \bar{n} is the mean photon number in each mode). Let us process the sequence $\{\Phi^\mu\}$ through the channel, so that $\rho^\mu = (\mathcal{I} \otimes \mathcal{E})(\Phi^\mu)$. Then compute the trace-distance between ρ^μ and $\rho_\mathcal{E}$. We get

$$\|\rho^\mu - \rho_\mathcal{E}\| \stackrel{(1)}{\leq} \|\Phi^\mu - \Phi\| \stackrel{(2)}{=} \sqrt{1 - F(\Phi^\mu, \Phi)}, \quad (\text{S15})$$

where (1) uses the monotonicity of trace distance under CPTP maps, and (2) exploits the fact that Φ^μ and Φ are pure, so that the trace-distance reduces to compute their fidelity $F(\Phi^\mu, \Phi)$ [S9].

It is easy to check that for sufficiently large μ , we get

$$\|\rho^\mu - \rho_\mathcal{E}\| \leq 2\varepsilon = O(\bar{n}^{-1}). \quad (\text{S16})$$

We can use the latter bound in Eq. (S12), suitably written in terms of the coherent information and for large \bar{n} . This leads to

$$\begin{aligned} & |I(A|B)_{\rho^\mu} - I(A|B)_{\rho_\mathcal{E}}| \leq \\ & O(\bar{n}^{-1}) \log_2 \left[\frac{2e(\bar{n}+1)}{1 - O(\bar{n}^{-1})} \right] + 32H_2 [O(\bar{n}^{-1})] \\ & \rightarrow 0, \text{ for } \bar{n} \rightarrow +\infty. \end{aligned} \quad (\text{S17})$$

An equivalent result can be written for the reverse coherent information.

Thus, we have found that the (reverse) coherent information of a bosonic channel, computed on its unbounded Choi matrix, is the continuous limit of the (reverse) coherent information computed on a sequence of energy-bounded states, for which the hashing inequality holds. This automatically extends the hashing inequality to the limit, so that the (reverse) coherent information of a bosonic channel is an achievable rate for one-way entanglement distillation through this channel.

II. UPPER BOUND AT ANY DIMENSION (PROOF OF WEAK CONVERSE THEOREM)

Let us start by considering quantum systems with finite dimension d . For any two states $\rho_{\mathbf{ab}}^n$ and ϕ_n such that $\|\rho_{\mathbf{ab}}^n - \phi_n\| \leq \varepsilon$, we may write the Fannes-type inequality [S10]

$$E_R(\phi_n) \leq E_R(\rho_{\mathbf{ab}}^n) + c\varepsilon \log_2 d + f(\varepsilon), \quad (\text{S18})$$

where c is a constant and $f(\varepsilon) := -\varepsilon \log_2 \varepsilon$. Note that $E_R(\phi_n) \geq K_D(\phi_n) = nR_{\text{key}}^n$ where K_D is the distillable key of ϕ_n [S11]. Therefore, we may write

$$R_{\text{key}}^n \leq n^{-1}E_R(\rho_{\mathbf{ab}}^n) + n^{-1}c\varepsilon \log_2 d + n^{-1}f(\varepsilon). \quad (\text{S19})$$

For $a \geq 1$, let us set

$$\log_2 d = \alpha(nR_{\text{key}}^n). \quad (\text{S20})$$

Then the previous inequality becomes

$$R_{\text{key}}^n \leq \frac{n^{-1}E_R(\rho_{\mathbf{ab}}^n) + n^{-1}f(\varepsilon)}{1 - c\varepsilon\alpha}. \quad (\text{S21})$$

For $\varepsilon \rightarrow 0$, we have $f(\varepsilon) \rightarrow 0$ and $c\varepsilon\alpha \rightarrow 0$, so that

$$R_{\text{key}}^n \leq n^{-1}E_R(\rho_{\mathbf{ab}}^n). \quad (\text{S22})$$

Taking the limit for large n and optimizing over the adaptive protocols, we get $K(\mathcal{E}) \leq E_R(\mathcal{E})$.

When $\rho_{\mathbf{ab}}^n$ is a continuous variable state, we consider a trace-preserving LOCC Λ_n which maps the state into a discrete variable state $\delta_{\mathbf{ab}}^n = \Lambda_n(\rho_{\mathbf{ab}}^n)$ with support in a Fock space with a cut-off α . This CV-DV mapping can be realized by means of two local quantum channels (see next section for more details). We can then write Eq. (S21) for $\delta_{\mathbf{ab}}^n$. For any cut-off $\alpha > O(\varepsilon^{-1+\delta})$ with $\delta > 0$, we derive

$$\lim_n R_{\text{key}}^n \leq \lim_n n^{-1}E_R(\delta_{\mathbf{ab}}^n). \quad (\text{S23})$$

For any cut-off $\alpha < O(\varepsilon^{-1})$, we have $\max\{R_{\text{key}}^n, 0\} \rightarrow 0$. Thus, independently from the cut-off, we may write

$$\lim_n R_{\text{key}}^n \leq \limsup_{n \rightarrow +\infty} n^{-1}E_R(\delta_{\mathbf{ab}}^n). \quad (\text{S24})$$

The RHS in Eq. (S24) can be upper-bounded using $E_R(\delta_{\mathbf{ab}}^n) \leq E_R(\rho_{\mathbf{ab}}^n)$ which derives from the monotonicity of the relative entropy of entanglement under trace-preserving LOCCs. For clarity, we break down this in the following steps

$$\begin{aligned} E_R(\delta_{\mathbf{ab}}^n) &\stackrel{(1)}{=} S(\delta_{\mathbf{ab}}^n \| \tilde{\sigma}) \stackrel{(2)}{\leq} S(\delta_{\mathbf{ab}}^n \| \sigma_{\text{sep}}) \\ &\stackrel{(3)}{\leq} S(\rho_{\mathbf{ab}}^n \| \tilde{\rho}_{\text{sep}}) = E_R(\rho_{\mathbf{ab}}^n). \end{aligned} \quad (\text{S25})$$

In (1) we denote by $\tilde{\sigma}$ the optimal separable state closest to $\delta_{\mathbf{ab}}^n$ (in relative entropy); in (2) we introduce the non-optimal separable state $\sigma_{\text{sep}} = \Lambda_n(\tilde{\rho}_{\text{sep}})$, where $\tilde{\rho}_{\text{sep}}$

is the separable state closest to $\rho_{\mathbf{ab}}^n$ (note that Λ_n is a LOCC and therefore preserves the separability of the input states); in (3) we exploit the fact that the relative entropy cannot increase under a trace-preserving LOCC, property which holds in arbitrary dimension [S12, S13]. Thus, we may write

$$\lim_n R_{\text{key}}^n \leq \limsup_{n \rightarrow +\infty} n^{-1}E_R(\rho_{\mathbf{ab}}^n). \quad (\text{S26})$$

Optimizing over the adaptive protocols we get $K(\mathcal{E}) \leq E_R(\mathcal{E})$ where the latter quantity is defined on CVs.

III. NOTIONS ON QUANTUM TELEPORTATION

A. Ideal teleportation

Ideal teleportation is based on the use of an ideal EPR state Φ_{AB} of systems A (for Alice) and B (for Bob). For a qudit of arbitrary dimension d , this is a generalized Bell state, i.e., maximally entangled state of the form

$$\Phi_{AB} = d^{-1/2} \sum_{i=1}^d |i\rangle_A |i\rangle_B. \quad (\text{S27})$$

In particular, it is the usual Bell state $(|00\rangle + |11\rangle)/\sqrt{2}$ for a qubit. For CVs, one has to take the limit of $d \rightarrow +\infty$ in Eq. (S27); this is a two-mode squeezed vacuum state [S20] with infinite energy, i.e., realizing $\hat{q}_A = \hat{q}_B$ for position and $\hat{p}_A = -\hat{p}_B$ for momentum. Such unbounded state must always be considered in this limit.

To teleport, we need to apply an ideal Bell detection on an input system a and EPR system A (i.e., Alice's part of the EPR state). This detection corresponds to a projection on the Bell states Φ_{aA}^k where the outcome k takes 2^d possible values for qudits, while it is complex for CVs [S14]. More precisely, it is a positive-operator valued measure (POVM) with operators

$$\Phi_{aA}^k := (U_k^a \otimes I^A)^\dagger \Phi_{aA} (U_k^a \otimes I^A), \quad (\text{S28})$$

where Φ_{aA} is the Bell state as in Eq. (S27) and U_k is a teleportation unitary (this is characterized below).

For any state ρ on the input system a and any outcome k of the Bell detection, the other EPR system B (Bob's part) is projected onto $U_k \rho U_k^\dagger$. Once Alice has communicated the value of k to Bob (feed-forward), the latter applies the correction unitary U_k^{-1} to retrieve the original state ρ on its system B . Note that this process also teleports all correlations that the input system a may have with ancillary systems.

1. Teleportation unitaries

Let us characterize the set of teleportation unitaries $\mathcal{U}_d = \{U_k\}$ in arbitrary dimension d . For a qudit, the teleportation set is composed of d^2 generalized Pauli operators, i.e., $\mathcal{U}_d = \{X^a Z^b\}$ where $a, b \in \mathbb{Z}_d := \{0, \dots, d-1\}$.

In terms of the computational basis $\{|j\rangle\}$, these are defined by the following unitary (non-Hermitian) operators

$$X|j\rangle = |j \oplus 1\rangle, \quad Z|j\rangle = \omega^j |j\rangle, \quad (\text{S29})$$

where \oplus is the modulo d addition and $\omega := \exp(i2\pi/d)$. These operators satisfy the generalized commutation relation

$$Z^b X^a = \omega^{ab} X^a Z^b. \quad (\text{S30})$$

Note that any qudit unitary can be expanded in terms of these generalized Pauli operators. We may construct the set of finite-dimensional displacement operators $D(j, a, b) := \omega^j X^a Z^b$ with $j, a, b \in \mathbb{Z}_d$ which form the finite-dimensional Weyl-Heisenberg group (or Pauli group). For instance, for a qubit ($d = 2$), we have $\mathcal{U}_2 = \{I, X, XZ, Z\}$ and the group $\pm 1 \times \{I, X, XZ, Z\}$.

For a CV system ($d = +\infty$), the teleportation set is composed of infinite displacement operators, i.e., we have $\mathcal{U}_\infty = \{D(k)\}$ with k complex and $D(k)$ being a displacement operator [S20]. This set corresponds to the infinite-dimensional Weyl-Heisenberg group.

B. CV-DV mappings and hybrid teleportation

In this section, we describe CV-to-DV and DV-to-CV mappings which are performed by means of local quantum channels (CPTP maps). An easy way to construct a CV-to-DV map is first applying a Fock space truncation at some cut-off d by means of a dichotomic POVM

$$\Pi_0 = \sum_{n=0}^{d-1} |n\rangle \langle n|, \quad \Pi_1 = I - \Pi_0, \quad (\text{S31})$$

where $|n\rangle$ are number states. Then, the good outcome $k = 0$ is followed by an identity channel, while the bad outcome $k = 1$ is followed by a completely depolarising channel which outputs the vacuum state. For instance, this can be implemented by a lossy channel \mathcal{E}_k with conditional transmissivity τ_k , where $\tau_0 = 1$ and $\tau_1 = 0$. It is easy to check that the average quantum operation $\sum_k \mathcal{E}_k (\Pi_k \rho \Pi_k^\dagger)$ is a ‘‘pinching’’ CPTP map which only filters the subspace with support up to $d - 1$ photons.

DV-to-CV maps can be constructed using hybrid quantum teleportation [S14]. For instance, a polarization qubit $|\varphi\rangle_a = \alpha |\uparrow\rangle_a + \beta |\downarrow\rangle_a$ can be teleported into a single-rail qubit, which is the bosonic subspace spanned by the vacuum $|0\rangle_b$ and the single-photon state $|1\rangle_b$. It is sufficient to build a hyper-entangled Bell state $|\uparrow\rangle_{a'} |1\rangle_b + |\downarrow\rangle_{a'} |0\rangle_b$ and apply a discrete variable Bell detection on qubits a and a' . This teleports a onto the bosonic mode b , up to Pauli operators (which can be suitably re-written in terms of the ladder operators). As usual in teleportation, such unitaries can be cleaned from the output state.

Such procedure can be readily extended to teleport a qudit, with arbitrary dimension d , into a d -dimensional

subspace of the Fock space. One has to build a suitable hyper-entangled Bell state $\sum_{k=0}^{d-1} |k\rangle_{a'} |k\rangle_b$ which maps the qudit computational basis $\{|k\rangle_{a'}\}$ into the first $d - 1$ number states $\{|k\rangle_b\}$. Then, we just apply a qudit Bell detection on a and a' , which teleports a onto the bosonic mode b , up to d^2 generalized Pauli operators.

IV. TELEPORTATION STRETCHING

Teleportation stretching exploits and generalizes the tool of teleportation channel, introduced in Section V of Ref. [S15]. We first describe this basic tool and then the technique of teleportation stretching.

A. Teleportation channels

Consider an arbitrary bipartite state σ of two systems A and B . Its teleportation channel \mathcal{T}_σ is defined by a quantum teleportation which exploits this state as a resource instead of an EPR state [S15]. In more details (see also Fig. S1), Alice measures an input system a and system A by means of a Bell detection, with outcome k . This operation projects Bob’s system B into the target state up to a teleportation unitary T_k . Once the outcome k is communicated to Bob, he applies T_k^{-1} to system B thus retrieving the final state on the output system b . By averaging over all outcomes k , one can define the teleportation channel \mathcal{T}_σ as the CPTP map from the states of a to the states of b . In the case where σ is an EPR source Φ , the teleportation channel is an identity from a to b (ideal teleportation).

Now let us assume that the resource state σ is achieved sending half of an EPR state through another channel \mathcal{E}

$$\sigma = (I \otimes \mathcal{E})(\Phi_{AB}). \quad (\text{S32})$$

In other words, σ corresponds to the Choi matrix $\rho_\mathcal{E}$ of channel \mathcal{E} . An important case is when \mathcal{E} coincides with the teleportation channel of its Choi matrix, i.e.,

$$\mathcal{T}_{\rho_\mathcal{E}} = \mathcal{E}, \quad (\text{S33})$$

which means that one can replace channel \mathcal{E} with teleportation over $\rho_\mathcal{E}$. Note that this condition is equivalent to impose that the Choi matrix of the teleportation channel is equal to the resource state, i.e.,

$$\rho_{\mathcal{T}_\sigma} = \sigma. \quad (\text{S34})$$

When Eq. (S34) holds, Ref. [S15] proved $Q_1(\mathcal{E}) = D_1(\rho_\mathcal{E})$ and (implicitly) its two-way extension $Q_2(\mathcal{E}) = D_2(\rho_\mathcal{E})$. Ref. [S15] stated that this is true for ‘‘generalized depolarizing channels’’ which typically correspond to Bell diagonal states σ (therefore Pauli channels \mathcal{T}_σ).

It is important to note that Ref. [S15] did not discuss commutation or covariance properties of channels in connection with teleportation, therefore not identifying the

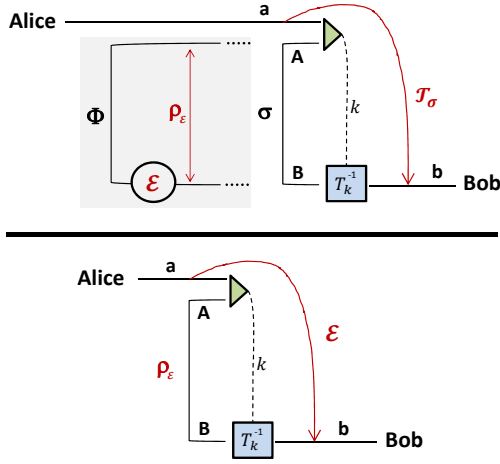

Figure S1: **Teleportation channel.** In the top panel, an input system a and system A of the resource state σ are subject to a Bell detection (green triangle) with outcome σ . This is communicated to Bob, who applies T_k^{-1} to system B . On average, this defines a teleportation channel \mathcal{T}_σ from a to b . We may consider the case where the resource state σ is the Choi matrix $\rho_\mathcal{E}$ of another channel \mathcal{E} (gray box), which corresponds to sending half of an EPR state Φ through \mathcal{E} . An important case is when, assuming $\sigma = \rho_\mathcal{E}$, we find $\mathcal{T}_\sigma = \mathcal{T}_{\rho_\mathcal{E}} = \mathcal{E}$, so that a channel \mathcal{E} from a to b can be replaced by teleportation on its Choi matrix $\rho_\mathcal{E}$ (see also bottom panel).

channels for which Eqs. (S33) and (S34) hold. We explicitly characterize this class in the next section. Also note that the implicit proof of $Q_2(\mathcal{E}) = D_2(\rho_\mathcal{E})$ given in Ref. [S15] does not imply the reduction of a completely general adaptive protocol. In fact, $Q_2(\mathcal{E}) = D_2(\rho_\mathcal{E})$ means that we can evaluate the quantum capacity of \mathcal{E} from entanglement distillation over $\rho_\mathcal{E}^{\otimes n}$; it *does not mean* that the output of an arbitrary protocol, e.g., for key distribution, can be written as $\rho_{\text{ab}}^n = \tilde{\Lambda}(\rho_\mathcal{E}^{\otimes n})$. Finally, it is also clear that Ref. [S15] did not consider CV channels.

All these limitations are surpassed by our technique which considers an arbitrary two-way adaptive protocol in DVs or CVs. Most importantly, we consider channels for which the conditions of Eqs. (S33) and (S34) are not necessarily true. Further discussion on the novelty of teleportation stretching is given in subsection IV C after we present more details on this technique.

B. Stretchable channels

First of all let us define quantum channels for which Eq. (S33) is true. These are channels which suitably commute with teleportation, here called “stretchable”. More precisely, a channel \mathcal{E} is stretchable if, for any teleportation unitary U_k , we may write

$$\mathcal{E}(U_k \rho U_k^\dagger) = V_k \mathcal{E}(\rho) V_k^\dagger, \quad (\text{S35})$$

for another generally-different unitary V_k . It is very easy to show the following.

Proposition 4 *The transmission of a system through a stretchable channel is equivalent to its teleportation over the Choi matrix of the channel. In other words, we have that Eq. (S35) implies Eq. (S33).*

Proof. Suppose that Alice sends a quantum system a through channel \mathcal{E} with output b , i.e., we have $\rho_b = \mathcal{E}(\rho_a)$. We can replace a with another input system A' by quantum teleportation. In fact, we can prepare an ideal EPR state $\Phi_{AA'}$ of systems A and A' , and perform a Bell detection on the original input system a and the EPR system A (see also Fig. S2).

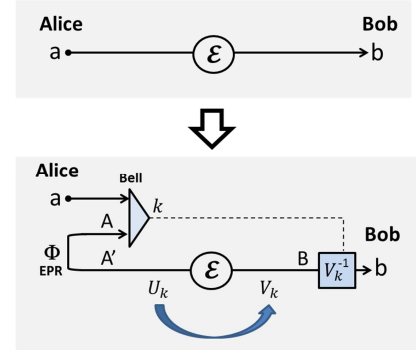

Figure S2: **Stretchable channel.** Time flows from left to right. (Top) Standard quantum communication through a stretchable channel \mathcal{E} from input system a to output system b . (Bottom) Input system a is perfectly teleported into the new input system A' by a teleportation circuit composed by an ideal EPR state and a Bell detection (triangle). The outcome k of the measurement is classically communicated to Bob. Since the channel is stretchable the teleportation unitary U_k is mapped into another output unitary V_k . This is corrected by Bob applying V_k^{-1} .

This leads to perfect teleportation of a onto A' , up to a random teleportation unitary, i.e., we have $\rho_{A'} = U_k \rho_a U_k^\dagger$. The unitary U_k could be erased by Alice before transmission. However, because \mathcal{E} is stretchable, U_k is mapped into an output unitary V_k that Bob can equivalently delete at the channel output, i.e.,

$$\rho_B = \mathcal{E}(\rho_{A'}) = \mathcal{E}(U_k \rho_a U_k^\dagger) = V_k \mathcal{E}(\rho_a) V_k^\dagger. \quad (\text{S36})$$

Therefore, Bob just needs to receive Alice’s CC about the outcome k and correspondingly apply V_k^{-1} to retrieve the transmitted state, i.e., $V_k(\rho_B)V_k^\dagger = \mathcal{E}(\rho_a)$. It is clear from Fig. S2 that what just realized is quantum teleportation over the Choi matrix $\rho_\mathcal{E}$. The procedure is also valid for CVs assuming the input EPR state defined in the limit of infinite energy (condition which can be suitably relaxed into a sequence of finite energy states in the following calculations with our method). ■

The condition of stretchability is certainly satisfied if the channel is covariant with respect to the Weyl-Heisenberg group, which describes the set of teleportation unitaries in both finite- and infinite-dimensional Hilbert spaces [in which case, we have $V_k = U_{k'}$ for some k' in previous Eq. (S35)]. For this reason, we may also call them “teleportation-covariant channels”. Note that, in general, we allow for V_k to be fully arbitrary. For instance, if we have a quantum channel which does not preserve the dimension, then V_k cannot belong to the group of the input unitaries U_k . A simple example is the erasure channel for which we need to consider augmented unitaries $V_k = U_k \oplus I$.

It is also important to note that, for a quantum channel in finite dimension, we may easily re-write Eq. (S35) in terms of an equivalent condition for the Choi matrix. In fact, by evaluating the equality in Eq. (S35) on the EPR state $\Phi = |\Phi\rangle\langle\Phi|$ and using the property that $U \otimes I |\Phi\rangle = I \otimes U^T |\Phi\rangle$, one finds

$$\rho_{\mathcal{E}} = (V_k^\dagger \otimes U_k^T) \rho_{\mathcal{E}} (V_k \otimes U_k^*). \quad (\text{S37})$$

Thus, a finite-dimensional channel \mathcal{E} is stretchable if and only if, for any teleportation unitary U_k , we may write

$$[\rho_{\mathcal{E}}, V_k \otimes U_k^*] = 0, \quad (\text{S38})$$

for another generally-different unitary V_k .

There are finite-dimensional channels which satisfy conditions stronger than Eq. (S38). For Pauli channels, we may write $[\rho_{\mathcal{E}}, U_k \otimes U_k^*] = 0$ for any k , i.e., the Choi matrix is invariant under twirling operations restricted to the generators of the Pauli group $\{U_k\}$. For depolarising channels, we may even write $[\rho_{\mathcal{E}}, U \otimes U^*] = 0$ for an arbitrary unitary U . This means that the Choi matrix of a depolarising channel is an isotropic state.

In general, we consider channels for which we may relax Eq. (S35) and impose weaker conditions. This is done by imposing Eq. (S35) to specific parts in the decompositions of these channels. Thus, we call “partly-stretchable” any channel which can be decomposed as

$$\mathcal{E} = \mathcal{E}'' \circ \tilde{\mathcal{E}} \circ \mathcal{E}', \quad (\text{S39})$$

where \mathcal{E}' and \mathcal{E}'' are arbitrary channels, and $\tilde{\mathcal{E}}$ is a stretchable channel or “stretchable part” of \mathcal{E} . Note that \mathcal{E}' and \mathcal{E}'' may account for arbitrary decoherence within Alice’s and Bob’s labs. For instance, these extra channels may describe trusted noise in the local devices (see discussions in the main text regarding trusted-noise QKD). The extra channels \mathcal{E}' and \mathcal{E}'' are very important because they may also represent DV-CV mappings at the input and output of the stretchable part $\tilde{\mathcal{E}}$. As we discuss afterwards and in the main text, this decomposition allows us to study the amplitude damping channel, which is one of the most basic error models for qubits.

More generally, we also consider “weakly-stretchable” channels, which are defined as those channels for which we may write the statistical mixture

$$\mathcal{E} = \sum_{ijl} p_{ijl} \mathcal{E}''_i \circ \tilde{\mathcal{E}}_j \circ \mathcal{E}'_i, \quad (\text{S40})$$

where p_{ijl} is a joint probability distribution, \mathcal{E}'_i and \mathcal{E}''_i are arbitrary channels, and $\tilde{\mathcal{E}}_j$ are stretchable parts. As also discussed in the main text, these mixtures of channels are needed to describe communications with non-negligible statistical fluctuations, as is the case of atmospheric turbulence and ground-to-satellite links. This decomposition is fundamental for the study of bosonic fading channels.

It is clear that partly- and weakly-stretchable channels do not satisfy Eqs. (S33) and (S34) apart from the specific case where they reduce to stretchable channels. In the most general case we can state the following.

Lemma 5 (Teleportation stretching) *Let us consider n uses of an adaptive quantum protocol over a weakly-stretchable channel \mathcal{E} as in Eq. (S40). Then, Alice and Bob’s output state reads*

$$\rho_{\text{ab}}^n := \rho_{\text{ab}}(\mathcal{E}^{\otimes n}) = \bar{\Lambda} \left(\otimes_j \rho_{\tilde{\mathcal{E}}_j}^{\otimes n p_j} \right), \quad (\text{S41})$$

where $\bar{\Lambda}$ is a trace-preserving LOCC, and $\rho_{\tilde{\mathcal{E}}_j}$ is the Choi matrix of the stretchable part $\tilde{\mathcal{E}}_j$ with marginal probability p_j . In particular, for a partly-stretchable channel as in Eq. (S39), we may write

$$\rho_{\text{ab}}(\mathcal{E}^{\otimes n}) = \bar{\Lambda} \left(\rho_{\tilde{\mathcal{E}}}^{\otimes n} \right). \quad (\text{S42})$$

Then, for a stretchable channel as in Eq. (S35), the decomposition of the output state further reduces to

$$\rho_{\text{ab}}(\mathcal{E}^{\otimes n}) = \bar{\Lambda} \left(\rho_{\tilde{\mathcal{E}}}^{\otimes n} \right). \quad (\text{S43})$$

Proof. To understand the proof, one can refer to Figs. S3-S6. Consider a generic (i, j, l) -instance of the protocol, occurring with probability p_{ijl} . For instance, this may happen at some m th transmission. As shown in Fig. S3, we decompose the channel into $\mathcal{E}''_i \circ \tilde{\mathcal{E}}_j \circ \mathcal{E}'_i$.

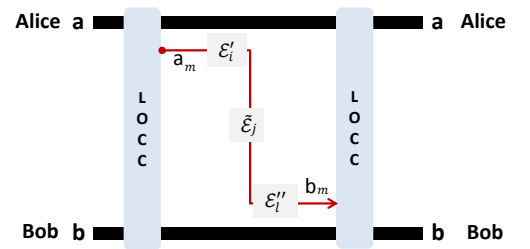

Figure S3: Generic (i, j, l) -instance of the protocol occurring at the m th transmission. Channel is decomposed as $\mathcal{E}''_i \circ \tilde{\mathcal{E}}_j \circ \mathcal{E}'_i$.

The next step is to replace the stretchable part $\tilde{\mathcal{E}}_j$ by a teleportation over its Choi matrix $\rho_{\tilde{\mathcal{E}}_j}$ (see Fig. S4). Next we treat channel \mathcal{E}'_i and the Bell detection as part of Alice’s LOs (these LOs are not applied by Alice in a real implementation of the protocol; it is only an equivalent representation). Similarly, we include \mathcal{E}''_i and the

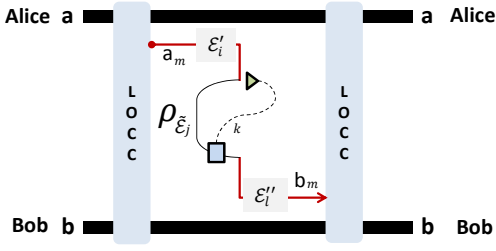

Figure S4: The stretchable part $\tilde{\mathcal{E}}_j$ is replaced by a teleportation over its Choi matrix $\rho_{\tilde{\mathcal{E}}_j}$. Green triangle is the Bell detection over the input system a_m and part of the Choi matrix. The blue square is the application of the correction unitary U_k^{-1} upon receipt of the outcome k of the detection.

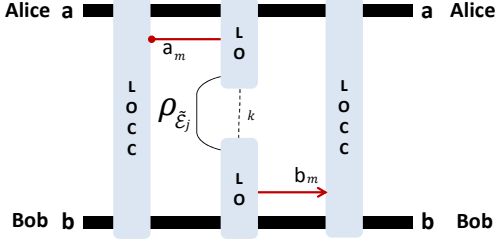

Figure S5: Channel \mathcal{E}'_i and the Bell detection become part of Alice's LO. Similarly, channel \mathcal{E}''_i and the correction unitary V_k^{-1} are included into Bob's LO. The result is an extended LOCC which is not performed by the parties but it provides an equivalent representation of the scheme.

correction unitary V_k^{-1} into Bob's LOs (see Fig. S5). The final step is the stretching of the Choi matrix $\rho_{\tilde{\mathcal{E}}_j}$ back in time, so that the subsequent adaptive LOCCs collapse into a single trace-preserving LOCC (see Fig. S6).

The previous procedure is repeated iteratively for all the (i, j, l) -instances of the protocol. The stretching of all the Choi matrices associated with each transmission leads to consider np_j copies of $\rho_{\tilde{\mathcal{E}}_j}$, where p_j is the marginal probability of $\tilde{\mathcal{E}}_j$ in the mixture of Eq. (S40). Thus, we can stretch the tensor product $\otimes_j \rho_{\tilde{\mathcal{E}}_j}^{np_j}$. This is then subject to a single and final trace-preserving LOCC $\bar{\Lambda}$, so that the output state ρ_{ab}^n of Alice and Bob can be written as in Eq. (S41). ■

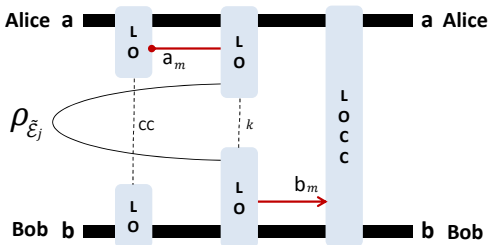

Figure S6: Choi matrix $\rho_{\tilde{\mathcal{E}}_j}$ is anticipated in time. As a result of this time-stretching, the adaptive LOCCs are collapsed into a single trace-preserving LOCC.

As discussed in the main text, teleportation stretching alone is not sufficient to provide a simple method for computing the two-way capacities. In fact, this tool has to be combined with our weak converse Theorem and the properties of the relative entropy of entanglement (REE). The reduction method discussed in our main text includes the following points:

1. Bound the generic two-way capacity $\mathcal{C}(\mathcal{E})$ with the REE of the channel (weak converse Theorem)

$$E_R(\mathcal{E}) := \sup_{\mathcal{L}} \limsup_{n \rightarrow +\infty} \frac{E_R(\rho_{\text{ab}}^n)}{n}. \quad (\text{S44})$$

2. Decompose the output (teleportation stretching)

$$\rho_{\text{ab}}^n = \bar{\Lambda} \left(\otimes_j \rho_{\tilde{\mathcal{E}}_j}^{\otimes np_j} \right). \quad (\text{S45})$$

3. Combine Eqs. (S44) and (S45), and exploit the properties of the REE to cancel $\bar{\Lambda}$ and simplify the tensor product. This allows us to ignore both the asymptotic limit \limsup and the difficult optimization $\sup_{\mathcal{L}}$.

The previous points lead to

$$\mathcal{C}(\mathcal{E}) \leq \sum_j p_j E_R(\tilde{\mathcal{E}}_j) = \sum_j p_j \Phi(\tilde{\mathcal{E}}_j), \quad (\text{S46})$$

where $\Phi(\tilde{\mathcal{E}}_j) := E_R(\tilde{\mathcal{E}}_j)$ is the entanglement flux of $\tilde{\mathcal{E}}_j$.

In the case of bosonic channels, the Choi matrices are unbounded, i.e., must be intended in the limit of infinite energy. The relaxation of this condition is performed by constructing sequences of finite-energy states which converge in norm to the ideal CV EPR state. As explained in the main text, this is possible by exploiting the lower semi-continuity of the relative entropy, which preserves the condition of upper bound in Eq. (S46). This is clearly a crucial step for the study of bosonic Gaussian channels.

C. Relations with previous literature

Teleportation stretching allows one to reduce the most general adaptive protocol into a block protocol, where channels are replaced by Choi matrices (non-necessarily of the same original channel) and the adaptive LOCCs are collapsed into a single trace-preserving LOCC. We remark that, despite Ref. [S15] introduced the notion of teleportation channel, our formulation generalizes that precursory idea in a number of non-trivial ways.

- First of all, teleportation stretching is generally designed for any task. For this reason, it can be used to compute not just the quantum capacity $Q_2(\mathcal{E})$ but also the secret-key capacity $K(\mathcal{E})$. Whatever is the task of the protocol, it allows us to decompose the output state ρ_{ab}^n into a tensor product of Choi matrices (not necessarily of the same channel).

- Second, our method applies to a large family of quantum channels, wider than what considered before [S15]. It is designed for both DV and CV channels. It explicitly allows us to handle decoherence in Alice’s and Bob’s labs, DV-CV mappings, compositions of channels, and random mixtures of channels. These important features are all absent in previous literature and are crucial in order to apply the technique to general scenarios. Teleportation stretching also applies to other types of communication, including the quantum feedback and multiband channels (see next sections).
- Third and most importantly, the crucial insight is the connection that we establish between teleportation stretching and the REE, which allows us to design our general method to compute the two-way capacities. This crucial insight has been missing since the 1996 paper [S15]. As recalled before, the 1996 paper performed an explicit analysis of one-way protocols to prove the equality $Q_1(\mathcal{E}) = D_1(\rho_{\mathcal{E}})$, implicitly extended to $Q_2(\mathcal{E}) = D_2(\rho_{\mathcal{E}})$. The latter equality, however, cannot be used because $D_2(\rho_{\mathcal{E}})$ is still hard to compute, apart from the very simple case of the erasure channel (reason why, before our work, the Q_2 of the erasure channel was the only two-way capacity to be known).

According to the previous points it is clear that teleportation stretching goes well beyond the precursory idea and the goal itself of Ref. [S15]. Our paper provides a full characterization of this technique, starting from the first and explicit definition of the types of channels that can be considered (in terms of their teleportation-covariance properties and progressively classified in stretchable, partly stretchable and weakly stretchable) and ending with giving the technique its most powerful application, thanks to the connection with the REE.

It is also important to note the basic differences between teleportation stretching and the programmable quantum gate arrays [S16]. In our case, we do not consider a universal set of unitaries but a fixed quantum channel which, in part and statistically, “commutes” with teleportation. Thus, instead of post-selecting the identity outcome (occurring with probability 2^{-d} for a qudit, and zero probability for a CV system), we can consider all the outcomes of the Bell detection which are then fed-forward in the final LOCC. Thus, our method departs from probabilistic (i.e., non trace-preserving) programmable quantum processors [S16] and their formulation in terms of port-based teleportation [S17]. In particular, the fact that our method provides an overall trace-preserving LOCC is absolutely crucial for the simplification of the adaptive protocols by means of the REE.

V. QUANTUM FEEDBACK CHANNEL

Our method can be extended to more complex forms of quantum communication. In fact, our weak converse Theorem can be applied to any scenario where two parties derives an output state from an adaptive protocol. All the details of the protocol are contained in the LOCCs \mathcal{L} which are collapsed into $\bar{\Lambda}$ by teleportation stretching and then discarded using the REE. The information about the communication scenario survives in the Choi matrices which may refer to multiple channels or multiple systems.

Consider the case where the parties also exploit a quantum feedback channel \mathcal{E}' , from Bob to Alice. In this case, Alice and Bob send systems to each other via two channels \mathcal{E} (forward) and \mathcal{E}' (backward), performing adaptive LOCC after each single transmission (see also Fig. S7). In general, they may agree an adaptive strategy where the feedback transmission occurs a fraction p of the rounds. The definition of the generic two-way capacity can suitably be extended to this type of protocol and must satisfy

$$\mathcal{C}(p, \mathcal{E}, \mathcal{E}') \geq \theta(p) := (1 - p)\mathcal{C}(\mathcal{E}) + p\mathcal{C}(\mathcal{E}') \quad (\text{S47})$$

where the achievable lower bound is a convex combination of the two-way capacities of the two single channels, used independently, i.e., with LOCCs which are independent between the forward and backward transmissions.

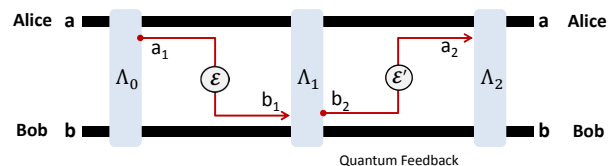

Figure S7: Adaptive protocol in the presence of a quantum feedback channel \mathcal{E}' . First two transmissions shown.

Assuming that \mathcal{E} and \mathcal{E}' are both stretchable, we can stretch all the two-way quantum communication and find the output state

$$\rho_{\mathbf{ab}}^n = \bar{\Lambda} \left(\rho_{\mathcal{E}}^{\otimes n(1-p)} \otimes \rho_{\mathcal{E}'}^{\otimes np} \right), \quad (\text{S48})$$

where the tensor exponents $n(1-p)$ and np of the two Choi-matrices are always integers for suitably large n . Now, using the monotonicity of the REE under trace-preserving LOCCs, we can relax the LOCC $\bar{\Lambda}$. Then, we use its subadditivity under tensor products. In other words, we may write

$$\begin{aligned} E_R(\rho_{\mathbf{ab}}^n) &\leq E_R[\rho_{\mathcal{E}}^{\otimes n(1-p)} \otimes \rho_{\mathcal{E}'}^{\otimes np}] \\ &\leq n(1-p)E_R(\rho_{\mathcal{E}}) + npE_R(\rho_{\mathcal{E}'}) \\ &= n(1-p)\Phi(\mathcal{E}) + np\Phi(\mathcal{E}'). \end{aligned} \quad (\text{S49})$$

It is easy to see that our weak converse Theorem can be applied to any type of adaptive protocol where two parties finally share a bipartite state $\rho_{\mathbf{ab}}^n$. The information

about the specific configuration and protocol considered is in fact contained in the adaptive LOCCs \mathcal{L} and in the Choi matrices after stretching. Thus, we may write

$$\begin{aligned} \mathcal{C}(p, \mathcal{E}, \mathcal{E}') &= \sup_{\mathcal{L}} \limsup_{n \rightarrow +\infty} \frac{E_R(\rho_{\mathbf{ab}}^n)}{n} \\ &\leq (1-p)\Phi(\mathcal{E}) + p\Phi(\mathcal{E}') . \end{aligned} \quad (\text{S50})$$

By combining Eqs. (S47) and (S50), we can derive the following bounds for the two-way capacity $\mathcal{C}(\mathcal{E}, \mathcal{E}')$ of the two-way quantum communication

$$\max\{\mathcal{C}(\mathcal{E}), \mathcal{C}(\mathcal{E}')\} \leq \mathcal{C}(\mathcal{E}, \mathcal{E}') \leq \max\{\Phi(\mathcal{E}), \Phi(\mathcal{E}')\}. \quad (\text{S51})$$

In the case of distillable channels, we have $\mathcal{C}(\mathcal{E}) = \Phi(\mathcal{E})$ and $\mathcal{C}(\mathcal{E}') = \Phi(\mathcal{E}')$, so that we can write

$$\mathcal{C}(\mathcal{E}, \mathcal{E}') = \max\{\mathcal{C}(\mathcal{E}), \mathcal{C}(\mathcal{E}')\} , \quad (\text{S52})$$

and the optimal distribution strategy (value of p) is that selecting the channel with the maximum capacity.

VI. MULTIBAND QUANTUM CHANNEL

Consider the communication scenario where Alice and Bob can exploit a multiband quantum channel, i.e., a quantum channel whose single use involves the simultaneous transmission of m distinct systems. In practice, this channel $\mathcal{E}_{\text{band}}$ is represented by a set of m independent channels $\{\mathcal{E}_1, \dots, \mathcal{E}_m\}$, e.g., they may be an ensemble of bosonic Gaussian channels associated with difference frequencies. In this case, the adaptive protocol is modified in such a way that Alice sends m quantum systems to Bob, with the two parties performing adaptive LOCCs before and after each block transmission, defining a LOCC sequence $\mathcal{L} = \{\Lambda_0, \dots, \Lambda_n\}$ after n transmissions. The definition of the generic two-way capacity can be easily extended and must satisfy

$$\mathcal{C}(\mathcal{E}_{\text{band}}) \geq \sum_{i=1}^m \mathcal{C}(\mathcal{E}_i) , \quad (\text{S53})$$

where the achievable lower bound is the sum of the two-way capacities of the single channels \mathcal{E}_i . This lower bound is achievable by using adaptive LOCCs which are independent between the channels \mathcal{E}_i and considering an output state of the form $\otimes_i \rho_{\mathbf{ab}}^{n,i}$ where $\rho_{\mathbf{ab}}^{n,i}$ is the output associated with \mathcal{E}_i .

Assuming that the channels \mathcal{E}_i are stretchable, we can then stretch all the multiband channel $\mathcal{E}_{\text{band}}$ and write the general output state

$$\rho_{\mathbf{ab}}^n = \bar{\Lambda} \left(\otimes_i \rho_{\mathcal{E}_i}^{\otimes n} \right) , \quad (\text{S54})$$

where $\rho_{\mathcal{E}_i}$ is the Choi matrix of \mathcal{E}_i . This leads to

$$E_R(\rho_{\mathbf{ab}}^n) \leq E_R[\otimes_i \rho_{\mathcal{E}_i}^{\otimes n}] \leq n \sum_{i=1}^m \Phi(\mathcal{E}_i). \quad (\text{S55})$$

Using our weak converse Theorem, we can then write

$$\begin{aligned} \mathcal{C}(\mathcal{E}_{\text{band}}) &= \sup_{\mathcal{L}} \limsup_{n \rightarrow +\infty} \frac{E_R(\rho_{\mathbf{ab}}^n)}{n} \\ &\leq \sum_{i=1}^m \Phi(\mathcal{E}_i) . \end{aligned} \quad (\text{S56})$$

Combining Eqs. (S53) and (S56) we may write the following relations for the two-way multiband capacity

$$\sum_{i=1}^m \mathcal{C}(\mathcal{E}_i) \leq \mathcal{C}(\mathcal{E}_{\text{band}}) \leq \sum_{i=1}^m \Phi(\mathcal{E}_i). \quad (\text{S57})$$

In the case of distillable channels, we have $\mathcal{C}(\mathcal{E}_i) = \Phi(\mathcal{E}_i)$, so that we find

$$\mathcal{C}(\mathcal{E}_{\text{band}}) = \sum_{i=1}^m \mathcal{C}(\mathcal{E}_i) . \quad (\text{S58})$$

VII. TOOLS FOR CONTINUOUS VARIABLES

A. Basic notions

Let us consider n bosonic modes with quadrature operators $\hat{x} = (\hat{q}_1, \dots, \hat{q}_n, \hat{p}_1, \dots, \hat{p}_n)^T$ and canonical commutation relations [S18]

$$[\hat{x}, \hat{x}^T] = i\Omega, \quad \Omega := \begin{pmatrix} 0 & 1 \\ -1 & 0 \end{pmatrix} \otimes I ,$$

with I being the $n \times n$ identity matrix. An arbitrary multimode Gaussian state $\rho(u, V)$, with mean value u and covariance matrix (CM) V , can be written as [S19]

$$\rho = \frac{\exp[-\frac{1}{2}(\hat{x} - u)^T G (\hat{x} - u)]}{\det(V + i\Omega/2)^{1/2}}, \quad (\text{S59})$$

where the Gibbs matrix G is specified by

$$G = 2i\Omega \coth^{-1}(2Vi\Omega). \quad (\text{S60})$$

The important feature of the Gibbs-exponential formula in Eq. (S59) is the direct formulation in terms of the statistical moments u and V , also thanks to the simple matrix relation between G and V , specified by Eq. (S60).

The CM of a Gaussian state can be decomposed using Williamson's theorem [S20]. This provides the symplectic spectrum $\{\nu_1, \dots, \nu_n\}$ which must satisfy the uncertainty principle $\nu_k \geq 1/2$. Similarly, we may write $\nu_k = \bar{n}_k + 1/2$ where \bar{n}_k are thermal numbers, i.e., mean number of photons in each mode. The von Neumann entropy of a Gaussian state can be easily computed as

$$S(\rho) = \sum_k s(\nu_k) = \sum_k h(\bar{n}_k), \quad (\text{S61})$$

where

$$\begin{cases} s(\nu) := (\nu + \frac{1}{2}) \log_2 (\nu + \frac{1}{2}) - (\nu - \frac{1}{2}) \log_2 (\nu - \frac{1}{2}), \\ h(\bar{n}) := (\bar{n} + 1) \log_2 (\bar{n} + 1) - \bar{n} \log_2 \bar{n}. \end{cases} \quad (\text{S62})$$

The most typical Gaussian state of two modes A and B is a two-mode thermal state. This has zero-mean and CM of the form

$$V = \begin{pmatrix} a & c \\ c & b \end{pmatrix} \oplus \begin{pmatrix} a & -c \\ -c & b \end{pmatrix}, \quad (\text{S63})$$

with arbitrary $a, b \geq 1/2$ and c satisfying the condition

$$c \leq c_{\max} := \min \left\{ \sqrt{(a - \frac{1}{2})(b + \frac{1}{2})}, \sqrt{(a + \frac{1}{2})(b - \frac{1}{2})} \right\}.$$

These bona-fide conditions can be checked using the tools in Refs. [S21, S22] adapted to our different notation. For a CM as in Eq. (S63), separability corresponds to

$$c \leq c_{\text{sep}} := \sqrt{(a - \frac{1}{2})(b - \frac{1}{2})}. \quad (\text{S64})$$

Thus, at any fixed a and b , the maximally-correlated but separable Gaussian state is given by imposing the boundary condition $c = c_{\text{sep}}$. It is easy to check that this state contains the maximum correlations among the separable states, e.g., as quantified by its (unrestricted, generally non-Gaussian) quantum discord [S23].

For $c_{\text{sep}} < c \leq c_{\max}$ in Eq. (S63), the Gaussian state is entangled. Note that a particular case is the two-mode squeezed vacuum state which represents the finite-energy version of the CV EPR state. This is a zero-mean Gaussian state Φ^μ with CM of the form

$$V^\mu = \begin{pmatrix} \mu & c \\ c & \mu \end{pmatrix} \oplus \begin{pmatrix} \mu & -c \\ -c & \mu \end{pmatrix}, \quad (\text{S65})$$

where $c := \sqrt{\mu^2 - 1/4}$ and $\mu \geq 1/2$. For $\mu \rightarrow \infty$, this state becomes an ideal EPR state Φ , realizing the conditions $\hat{q}_A = \hat{q}_B$ and $\hat{p}_A = -\hat{p}_B$.

A Gaussian channel is a CPTP map which transforms Gaussian states into Gaussian states. Single-mode Gaussian channels can be greatly simplified by means of input-output unitaries. In fact, these can always be put in canonical form [S20] whose general action on input quadratures $\hat{x} = (\hat{q}, \hat{p})^T$ is given by

$$\hat{x} \rightarrow T\hat{x} + N\hat{x}_E + z, \quad (\text{S66})$$

where T and N are diagonal matrices, E is an environmental mode with \bar{n} mean photons, and z is a classical Gaussian variable, with zero mean and CM ξI where $\xi \geq 0$. All Gaussian channels are stretchable. In fact, the effect of an ideal teleportation is the k -dependent displacement of the input $\hat{x} \rightarrow \hat{x} + d_k$, which is mapped into $d_k \rightarrow Td_k$.

Depending on the specific canonical form we have different expressions in Eq. (S66). We have:

- The thermal-loss channel $\mathcal{E}_{\text{loss}}(\eta, \bar{n})$ with transmissivity $0 \leq \eta \leq 1$ and \bar{n} thermal photons. This is described by

$$\hat{x} \rightarrow \sqrt{\eta}\hat{x} + \sqrt{1-\eta}\hat{x}_E. \quad (\text{S67})$$

For $\bar{n} = 0$, the channel $\mathcal{E}_{\text{loss}}(\eta) := \mathcal{E}_{\text{loss}}(\eta, 0)$ is called pure-loss channel or just ‘‘lossy channel’’.

- The amplifier channel $\mathcal{E}_{\text{amp}}(\eta, \bar{n})$ with gain $\eta > 1$ and \bar{n} thermal photons (in the main text we use the letter g for the gain). This corresponds to the transformation

$$\hat{x} \rightarrow \sqrt{\eta}\hat{x} + \sqrt{\eta-1}\hat{x}_E. \quad (\text{S68})$$

For $\bar{n} = 0$, the channel $\mathcal{E}_{\text{amp}}(\eta) := \mathcal{E}_{\text{amp}}(\eta, 0)$ is called quantum-limited amplifier.

- The additive-noise Gaussian channel $\mathcal{E}_{\text{add}}(\xi)$, which simply corresponds to

$$\hat{x} \rightarrow \hat{x} + z. \quad (\text{S69})$$

- Finally, there are other secondary forms. One is the conjugate of the amplifier, which is described by $\hat{x} \rightarrow \sqrt{-\eta}Z\hat{x} + \sqrt{1-\eta}\hat{x}_E$, where $\eta < 0$ and $Z = \text{diag}(1, -1)$ is the reflection matrix. Then, other pathological forms [S20]: The A_2 -form, which is a ‘half’ depolarising channel and corresponds to $\hat{x} \rightarrow (\hat{q}, 0)^T + \hat{x}_E$; and the B_1 -form, which is described by $\hat{x} \rightarrow \hat{x} + (0, \hat{p}_v)^T$ where v is the vacuum.

B. Formula for the relative entropy between arbitrary Gaussian states

We now provide a simple computable formula for the relative entropy between two arbitrary Gaussian states $\rho_1(u_1, V_1)$ and $\rho_2(u_2, V_2)$ directly in terms of their statistical moments, without the need of symplectic decompositions. Because of these features, our formula supersedes any previous proposed expression, such as the implicit one given in Ref. [S24] which leaves the symplectic decompositions to be carried out. The starting point is the use of the Gibbs-exponential form for Gaussian states [S19] which is given in Eq. (S59). By exploiting this form, we can show the following result.

Theorem 6 (Relative entropy of Gaussian states)

For two arbitrary multimode Gaussian states, $\rho_1(u_1, V_1)$ and $\rho_2(u_2, V_2)$, the entropic functional

$$\Sigma := -\text{Tr}(\rho_1 \log_2 \rho_2) \quad (\text{S70})$$

is given by

$$\Sigma(V_1, V_2, \delta) = \frac{\ln \det(V_2 + \frac{i\delta}{2}) + \text{Tr}(V_1 G_2) + \delta^T G_2 \delta}{2 \ln 2}, \quad (\text{S71})$$

where $\delta := u_1 - u_2$ and $G := g(V)$ as given in Eq. (S60). As a consequence, the von Neumann entropy of a Gaussian state $\rho(u, V)$ is equal to

$$S(\rho) := -\text{Tr}(\rho \log_2 \rho) = \Sigma(V, V, 0), \quad (\text{S72})$$

and the relative entropy of two Gaussian states $\rho_1(u_1, V_1)$ and $\rho_2(u_2, V_2)$ is given by

$$\begin{aligned} S(\rho_1 || \rho_2) &:= \text{Tr}[\rho_1(\log_2 \rho_1 - \log_2 \rho_2)] \\ &= -S(\rho_1) - \text{Tr}(\rho_1 \log_2 \rho_2) \\ &= -\Sigma(V_1, V_1, 0) + \Sigma(V_1, V_2, \delta). \end{aligned} \quad (\text{S73})$$

Proof. Start with zero-mean Gaussian states, which can be written as $\rho_i = Z_i^{-1} \exp[-\hat{x}^T G_i \hat{x}/2]$, where $G_i = g(V_i)$ is the Gibbs-matrix and $Z_i = \det(V_i + i\Omega/2)^{1/2}$ is the normalization factor (with $i = 1, 2$). Then, replacing into the definition of Σ given in Eq. (S70), we find

$$\begin{aligned} (2 \ln 2)\Sigma &= 2 \ln Z_2 + \text{Tr}(\rho_1 \hat{x}^T G_2 \hat{x}) \\ &= \ln \det(V_2 + i\Omega/2) \\ &\quad + \sum_{jk} \text{Tr}(\rho_1 \hat{x}_j \hat{x}_k) G_{2jk}. \end{aligned} \quad (\text{S74})$$

Using the commutator $\langle[\hat{x}_j, \hat{x}_k]\rangle = i\Omega_{jk}$ and the anticommutator $\langle\{\hat{x}_j, \hat{x}_k\}\rangle = 2V_{jk}$, we derive

$$\begin{aligned} \sum_{jk} \text{Tr}(\rho_1 \hat{x}_j \hat{x}_k) G_{2jk} &= \text{Tr}\left[\left(V_1 + \frac{i\Omega}{2}\right)^T G_2\right] \\ &= \text{Tr}(V_1 G_2), \end{aligned} \quad (\text{S75})$$

where we also exploit the fact that $\text{Tr}(\Omega G) = 0$, because Ω is antisymmetric and G is symmetric (as V).

Let us now extend the formula to non-zero mean values (with difference $\delta = u_1 - u_2$). This means to perform the replacement $\hat{x} \rightarrow \hat{x} - u_2$, so that

$$\begin{aligned} \text{Tr}(\rho_1 \hat{x}_j \hat{x}_k) &\rightarrow \text{Tr}[\rho_1(\hat{x}_j - u_{2j})(\hat{x}_k - u_{2k})] \\ &= \text{Tr}[\rho_1(\hat{x}_j - u_{1j} + \delta_j)(\hat{x}_k - u_{1k} + \delta_k)] \\ &= \text{Tr}[\rho_1(\hat{x}_j - u_{1j})(\hat{x}_k - u_{1k})] + \delta_j \delta_k. \end{aligned}$$

By replacing this expression in Eq. (S75), we get

$$\sum_{jk} \text{Tr}(\rho_1 \hat{x}_j \hat{x}_k) G_{2jk} \rightarrow \text{Tr}(V_1 G_2) + \delta^T G_2 \delta. \quad (\text{S76})$$

Thus, by combining Eqs. (S74) and (S76), we achieve the final formula in Eq. (S71). The other Eqs. (S72) and (S73) are immediate consequences. ■

As discussed in Ref. [S19], the Gibbs-matrix G becomes singular for a pure state or, more generally, for a mixed state containing vacuum contributions (i.e., with some of the symplectic eigenvalues equal to $1/2$). In this case the Gibbs-exponential form must be used carefully by making a suitable limit. Since Σ is basis independent, we can perform the calculations in the basis in which V_2 , and therefore G_2 , is diagonal. In this basis

$$\Sigma = \frac{1}{2} \sum_{k=1}^n \sum_{\pm} \alpha_k^{\pm} \log_2(v_{2k} \pm 1/2), \quad (\text{S77})$$

where $\{v_{2k}\}$ is the symplectic spectrum of V_2 , and

$$\alpha_k^{\pm} = 1 \pm [(V_1)_{k,k} + (V_1)_{k+n,k+n}]. \quad (\text{S78})$$

Now, if $v_{2k} = 1/2$ for some k , then its contribution to the sum in Eq. (S77) is either zero or infinity.

VIII. RESULTS FOR BOSONIC GAUSSIAN CHANNELS

A. Coherent and reverse coherent information of a Gaussian channel

Here we discuss the computation of the (reverse) coherent information for the most important single-mode Gaussian channels, i.e., the thermal-loss channel, the amplifier channel and the additive-noise Gaussian channel. Compactly, their action on input quadratures is given by

$$\hat{x} \rightarrow \sqrt{\eta} \hat{x} + \sqrt{|1-\eta|} \hat{x}_E + z, \quad (\text{S79})$$

where $\eta \geq 0$ is the transmission (or gain), \hat{x}_E is the environmental mode in a thermal state with \bar{n} mean photons, and z is a classical Gaussian variable with CM $\xi I \geq 0$. The Choi matrix $\rho_{\mathcal{E}}$ of this Gaussian channel $\mathcal{E} = \mathcal{E}(\eta, \bar{n}, \xi)$ is defined as an asymptotic limit.

At the input we consider a sequence of two-mode vacuum states Φ^{μ} with CM as in Eq. (S65). At the output we get a sequence of finite-energy Gaussian states

$$\rho^{\mu} := (\mathcal{I} \otimes \mathcal{E})(\Phi^{\mu}), \quad (\text{S80})$$

which have zero mean and CM

$$V^{\mu}(\eta, \bar{n}, \xi) = \begin{pmatrix} \mu & \gamma \\ \gamma & \beta \end{pmatrix} \oplus \begin{pmatrix} \mu & -\gamma \\ -\gamma & \beta \end{pmatrix}, \quad (\text{S81})$$

where

$$\beta := \eta\mu + |1-\eta| \left(\bar{n} + \frac{1}{2} \right) + \xi, \quad (\text{S82})$$

$$\gamma := \sqrt{\eta(\mu^2 - 1/4)}. \quad (\text{S83})$$

It is easy to check that $\|\rho^{\mu} - \rho_{\mathcal{E}}\| \rightarrow 0$ for $\mu \rightarrow +\infty$. In fact, this is a specific instance of Eq. (S16) which is valid for any single-mode bosonic channel.

According to the analysis of Sec. IC, the (reverse) coherent information of the unbounded Choi matrix $\rho_{\mathcal{E}}$ can be computed by taking the limit of the (reverse) coherent information computed over the sequence ρ^{μ} . The limit is continuous and extends the hashing inequality to the unbounded state $\rho_{\mathcal{E}}$, so that we can establish a lower bound for one-way entanglement distillation over $\rho_{\mathcal{E}}$ and, therefore, through channel \mathcal{E} .

Let us compute the symplectic eigenvalues of the output CM in Eq. (S81). We derive [S20]

$$\nu_{\pm} = \sqrt{\frac{\Delta \pm \sqrt{\Delta^2 - 4 \det V^{\mu}}}{2}}, \quad (\text{S84})$$

where $\Delta := \mu^2 + \beta^2 - 2\gamma^2$. Using the formula of the von Neumann entropy for Gaussian states [see Eq. (S61)] and the definitions of the coherent information I_C and reverse coherent information I_{RC} [see Sec. IA], we may write

$$I_C(\mathcal{E}, \Phi^\mu) = I(A\langle B\rangle_{\rho^\mu}) = s(\beta) - s(\nu_-) - s(\nu_+), \quad (\text{S85})$$

$$I_{RC}(\mathcal{E}, \Phi^\mu) = I(A\langle B\rangle_{\rho^\mu}) = s(\mu) - s(\nu_-) - s(\nu_+), \quad (\text{S86})$$

where function $s(\cdot)$ is given in Eq. (S62).

It is easy to see that these quantities are continuous and increasing in μ , for any fixed values of η , \bar{n} and ξ . For instance, for the lossy channel ($0 \leq \eta \leq 1$, $\bar{n} = \xi = 0$), we simply have

$$I(A\langle B\rangle_{\rho^\mu}) = s\left[\frac{1-\eta}{2} + \eta\mu\right] - s\left[\frac{\eta}{2} + (1-\eta)\mu\right], \quad (\text{S87})$$

$$I(A\langle B\rangle_{\rho^\mu}) = s(\mu) - s\left[\frac{\eta}{2} + (1-\eta)\mu\right]. \quad (\text{S88})$$

Taking the limit for $\mu \rightarrow +\infty$ in Eqs. (S85) and (S86), one derives the asymptotic and maximum expressions of these quantities, which correspond to the coherent and reverse coherent information of the channels

$$I_C(\mathcal{E}) := I(A\langle B\rangle_{\rho_{\mathcal{E}}}), \quad I_{RC}(\mathcal{E}) := I(A\langle B\rangle_{\rho_{\mathcal{E}}}). \quad (\text{S89})$$

For the thermal-loss channel, the best lower bound is given by the reverse coherent information, given by [S4]

$$I_{RC}(\eta, \bar{n}) = -\log_2(1-\eta) - h(\bar{n}), \quad (\text{S90})$$

where $h(\cdot)$ is the entropic function defined in Eq. (S62). In particular, for a lossy channel ($\bar{n} = 0$), one derives

$$I_{RC}(\eta) = -\log_2(1-\eta). \quad (\text{S91})$$

For the amplifier channel, the best lower bound is given by the coherent information, which is equal to [S4, S25]

$$I_C(\eta, \bar{n}) = \log_2\left(\frac{\eta}{\eta-1}\right) - h(\bar{n}), \quad (\text{S92})$$

which becomes

$$I_C(\eta) = \log_2\left(\frac{\eta}{\eta-1}\right), \quad (\text{S93})$$

for the quantum-limited amplifier ($\bar{n} = 0$). The coherent information and reverse coherent information of the additive-noise Gaussian channel coincide. The coherent information was computed in Ref. [S25] and is given by

$$I_C(\xi) = I_{RC}(\xi) = -\log_2 \xi - \frac{1}{\ln 2}. \quad (\text{S94})$$

It is clear that $I_C(\mathcal{E})$ and $I_{RC}(\mathcal{E})$ are achievable rates for QKD, just because an ebit is a particular type of secret bit. In particular Ref. [S4] proved that $I_{RC}(\mathcal{E})$ is an achievable lower bound for QKD without going through an entanglement distillation. In fact, $I_{RC}(\mathcal{E})$ can be computed as the asymptotic key rate of a coherent protocol where: (i) Alice prepares finite-energy EPR states

$\Phi_{AA'}^\mu$, sending A' to Bob; (ii) Bob heterodynes each output mode B and sends final CCs back to Alice; and (iii) Alice coherently measures all her modes A .

The achievable rate of this coherent protocol is given by a Devetak-Winter rate R_{DW} [S5]. Because Eve holds the entire purification of Alice and Bob's output state ρ^μ and Bob's detections are rank-1 measurements, this rate is equal to the reverse coherent information [S4] $R_{\text{DW}} = I(A\langle B\rangle_{\rho^\mu})$ computed on Alice and Bob's output. Then, by taking the limit of $\mu \rightarrow +\infty$, one obtains $K(\mathcal{E}) \geq I_{RC}(\mathcal{E})$.

B. Entanglement flux of a Gaussian channel

Let us provide full details on how to compute the entanglement flux of a single-mode Gaussian channel (canonical form). We give here the general recipe and then we go into details of the specific channels in the next subsections. First of all, we write

$$\Phi(\mathcal{E}) = E_R(\rho_{\mathcal{E}}) \leq S(\rho_{\mathcal{E}}||\tilde{\sigma}), \quad (\text{S95})$$

for some suboptimal separable Gaussian state $\tilde{\sigma}$. Then we consider two sequences of Gaussian states, ρ^μ and $\tilde{\sigma}^\mu$, converging in norm to the target states $\rho_{\mathcal{E}}$ and $\tilde{\sigma}$. This allows us to exploit the lower semicontinuity of the relative entropy in infinite dimension [S13] and write

$$\Phi(\mathcal{E}) \leq S(\rho_{\mathcal{E}}||\tilde{\sigma}) \leq \liminf_{\mu \rightarrow +\infty} S(\rho^\mu||\tilde{\sigma}^\mu). \quad (\text{S96})$$

As explained in the previous section, for the Choi matrix $\rho_{\mathcal{E}}$ we can choose the sequence of zero-mean Gaussian states ρ^μ specified by Eq. (S80) with CM as in Eq. (S81).

The suboptimal separable Gaussian state $\tilde{\sigma}$ is itself defined as the limit in trace norm of a suitable sequence of separable Gaussian states $\tilde{\sigma}^\mu$. For each fixed μ , we pick the separable Gaussian state having CM $\tilde{V}^\mu(\eta, \bar{n}, \xi)$ as in Eq. (S81) but with the replacement

$$\gamma \rightarrow \sqrt{(\mu-1/2)(\beta-1/2)}, \quad (\text{S97})$$

for the off-diagonal term. At fixed marginals μ and β , this is the most-correlated separable Gaussian state that we can build according to Eqs. (S63) and (S64); it has maximum (non-Gaussian) discord [S23] and minimizes the relative entropy $S(\rho^\mu||\tilde{\sigma}^\mu)$ as long as ρ^μ is an entangled state. In the specific case where the channel \mathcal{E} is entanglement-breaking (i.e., $\rho_{\mathcal{E}}$ is separable), then ρ^μ becomes separable, and we can trivially pick $\tilde{\sigma}^\mu = \rho^\mu$ so that $S(\rho^\mu||\tilde{\sigma}^\mu) = 0$.

In general, we are left with the analytical calculation of the relative entropy $S(\rho^\mu||\tilde{\sigma}^\mu)$ between two Gaussian states. This can be done in terms of their statistical moments according to the formula in Theorem 6. For $S(\rho^\mu||\tilde{\sigma}^\mu)$ we find regular expressions for which the limit is well-defined, i.e., we can put $\liminf_{\mu} = \lim_{\mu}$ in Eq. (S96). We provide full algebraic details below.

1. Entanglement flux of a thermal-loss channel

Consider a thermal-loss channel $\mathcal{E}_{\text{loss}}(\eta, \bar{n})$ with transmissivity $0 \leq \eta \leq 1$ and thermal number \bar{n} , so that thermal noise has variance $\omega = \bar{n} + 1/2$. For $\bar{n} \geq \eta(1 - \eta)^{-1}$, this channel is entanglement-breaking and we just have zero entanglement flux $\Phi(\eta, \bar{n}) = 0$. For $\bar{n} < \eta(1 - \eta)^{-1}$ we compute the relative entropy $S^\mu := S(\rho^\mu || \tilde{\sigma}^\mu)$ from the CMs $V^\mu(\eta \leq 1, \bar{n}, 0)$ and $\tilde{V}^\mu(\eta \leq 1, \bar{n}, 0)$ of the zero-mean Gaussian states ρ^μ and $\tilde{\sigma}^\mu$. Using the formula of Theorem 6, we get

$$S^\mu = -S_1 + \frac{\Delta}{2 \ln 2} + \frac{1}{2} \log_2 \left\{ \frac{2\mu - 1}{4} [2\omega - 1 + 2\eta(\mu - \omega)] \right\} \quad (\text{S98})$$

where S_1 is the contribution of the von Neumann entropy, while the other two terms come from the entropic functional $\Sigma(V^\mu, \tilde{V}^\mu, 0)$. Term Δ is analytical but its expression is too cumbersome to be reported here.

By expanding for large μ , we may write

$$\Delta \rightarrow 2 \left[1 - 2\omega \coth^{-1} \left(\frac{1 + \eta}{\eta - 1} \right) \right] + O(\mu^{-1})$$

$$S_1 \rightarrow h(\bar{n}) + \log_2 [e(1 - \eta)\mu] + O(\mu^{-1}) \quad (\text{S99})$$

and

$$\frac{1}{2} \log_2 \left\{ \frac{2\mu - 1}{4} [2\omega - 1 + 2\eta(\mu - \omega)] \right\} \rightarrow \log_2 \mu \sqrt{\eta} + O(\mu^{-1}). \quad (\text{S100})$$

Taking the limit $S^\infty = \liminf_\mu S^\mu = \lim_\mu S^\mu$, we get

$$S^\infty = -\log_2 [(1 - \eta)\eta^{\bar{n}}] - h(\bar{n}). \quad (\text{S101})$$

As a result, by replacing in Eq. (S96), we find that the entanglement flux Φ of a thermal-loss channel $\mathcal{E}_{\text{loss}}(\eta, \bar{n})$ satisfies

$$\Phi(\eta, \bar{n}) \leq \Phi_{\text{loss}}(\eta, \bar{n})$$

where

$$\Phi_{\text{loss}}(\eta, \bar{n}) := \begin{cases} -\log_2 [(1 - \eta)\eta^{\bar{n}}] - h(\bar{n}) & \text{for } \bar{n} < \frac{\eta}{1 - \eta}, \\ 0 & \text{otherwise.} \end{cases} \quad (\text{S102})$$

The thermal bound in Eq. (S102) is much tighter than other bounds based on the squashed entanglement, i.e., the previous Takeoka-Guha-Wilde (TGW) thermal bound [S26]

$$K_{\text{TGW}} = \log_2 \left[\frac{(1 - \eta)\bar{n} + 1 + \eta}{(1 - \eta)\bar{n} + 1 - \eta} \right], \quad (\text{S103})$$

and its improved version [S27]. However, Φ_{loss} does not generally coincide with the achievable lower-bound [S4]

given by the reverse coherent information of the channel [see Eq. (S90)]. Thus, the generic two-way capacity of the thermal-loss channel satisfies the sandwich relation

$$-\log_2(1 - \eta) - h(\bar{n}) \leq \mathcal{C}_{\text{loss}}(\eta, \bar{n}) \leq \Phi_{\text{loss}}(\eta, \bar{n}). \quad (\text{S104})$$

It is easy to check that, for a lossy channel ($\bar{n} = 0$), the bounds in the previous Eq. (S104) coincide, therefore establishing

$$\mathcal{C}_{\text{loss}}(\eta) = -\log_2(1 - \eta). \quad (\text{S105})$$

The result of Eq. (S105) sets the fundamental limit for secret-key generation, entanglement distillation and quantum communication in bosonic lossy channels. For high loss it provides the fundamental rate-loss scaling of 1.44 η bits per channel use. This also coincides with the maximum discord that can be distributed to the parties by means of a single use of the channel. In fact, we may always write [S28] $I(A(B)_{\rho_{\mathcal{E}}}) = D(B|A) - E_f(B, E)$, where $D(B|A)$ is the quantum discord [S29] of Alice and Bob's Choi matrix $\rho_{\mathcal{E}}$, while $E_f(B, E)$ is the entanglement of formation between Bob and Eve. Since a lossy channel is dilated into a beamsplitter with a vacuum environment, we have $E_f(B, E) = 0$. Thus, we may write

$$\mathcal{C}_{\text{loss}}(\eta) = D(B|A), \quad (\text{S106})$$

where $D(B|A)$ is the quantum discord of the Gaussian Choi matrix $\rho_{\mathcal{E}}$ [S23].

2. Full details for the lossy channel

For the sake of completeness, we provide the specific details of the computation of the relative entropy $S^\mu = S(\rho^\mu || \tilde{\sigma}^\mu)$ for the lossy channel. After some algebra, we achieve

$$S^\mu = \log_2 \left[\left(\mu - \frac{1}{2} \right) \sqrt{\eta} \right] - s \left[(1 - \eta)\mu + \frac{\eta}{2} \right] + \frac{\Delta}{2 \ln 2}, \quad (\text{S107})$$

where

$$\Delta := \frac{c - (2\mu - 1)(1 - \eta)a}{b} \coth^{-1} \left[\frac{(1 - \eta)(1 - 2\mu) - a}{2} \right] - \frac{c + (2\mu - 1)(1 - \eta)a}{b} \coth^{-1} \left[\frac{(1 - \eta)(1 - 2\mu) + a}{2} \right],$$

and

$$a := \sqrt{1 - (6 - \eta)\eta + 4\mu[1 + (4 - \eta)\eta + (1 - \eta)^2\mu]}$$

$$b := \sqrt{8\mu + (2\mu - 1)[4\eta + (2\mu - 1)(1 - \eta)^2]}$$

$$c := 2\eta(2\mu - 1) \left(2\sqrt{4\mu^2 - 1} - 1 - 2\mu \right) - \eta^2(2\mu - 1)^2 - (1 + 2\mu)^2.$$

We now insert the expression of Δ in Eq. (S107) and we take the limit for $\mu \rightarrow +\infty$. This limit is defined (i.e., $\liminf_{\mu} = \lim_{\mu}$) and we get

$$S^{\infty} = \lim_{\mu \rightarrow +\infty} S^{\mu} = -\log_2(1 - \eta). \quad (\text{S108})$$

We can show this limit step-by-step. First note that, for large ν , we have

$$s(\nu) \rightarrow \log_2 e\nu + O(\nu^{-1}). \quad (\text{S109})$$

Thus, in the limit of $\mu \rightarrow +\infty$, the first two terms in the RHS of Eq. (S107) become

$$\log_2 \left[\left(\mu - \frac{1}{2} \right) \sqrt{\eta} \right] \rightarrow \log_2(\mu\sqrt{\eta}) + O(\mu^{-1}), \quad (\text{S110})$$

$$-s \left[(1 - \eta)\mu + \frac{\eta}{2} \right] \rightarrow -\log_2[e(1 - \eta)\mu] + O(\mu^{-1}). \quad (\text{S111})$$

Then, it is easy to show that, for $\mu \rightarrow +\infty$, we have

$$\begin{aligned} \Delta &\rightarrow [-4(1 - \eta)\mu + O(\mu^0)] \coth^{-1} [-2(1 - \eta)\mu + O(\mu^0)] \\ &\quad - [-2 + O(\mu^{-1})] \coth^{-1} \left[\frac{1 + \eta}{1 - \eta} + O(\mu^{-1}) \right] \\ &\rightarrow 2 - \ln \eta + O(\mu^{-1}). \end{aligned} \quad (\text{S112})$$

In conclusion, by using Eqs. (S110), (S111) and (S112) into Eq. (S107), we obtain the final result in Eq. (S108).

3. Entanglement flux of the quantum amplifier

Consider an amplifier channel $\mathcal{E}_{\text{amp}}(\eta, \bar{n})$ with gain $\eta > 1$ and thermal number \bar{n} , so that thermal noise has variance $\omega = \bar{n} + 1/2$. For $\bar{n} \geq (\eta - 1)^{-1}$ this channel is entanglement breaking and therefore $\Phi(\eta, \bar{n}) = 0$. For $\bar{n} < (\eta - 1)^{-1}$ we compute the relative entropy $S^{\mu} := S(\rho^{\mu} || \tilde{\sigma}^{\mu})$ from the CMs $V^{\mu}(\eta > 1, \bar{n}, 0)$ and $\tilde{V}^{\mu}(\eta > 1, \bar{n}, 0)$ of the zero-mean Gaussian states ρ^{μ} and $\tilde{\sigma}^{\mu}$. Using Theorem 6 and up to terms $O(\mu^{-1})$, we get

$$S(\rho^{\mu}) \rightarrow h(\bar{n}) + \log_2 e(\eta - 1)\mu, \quad (\text{S113})$$

$$-\text{Tr}(\rho^{\mu} \log_2 \tilde{\sigma}^{\mu}) \rightarrow \frac{\ln(\eta\mu^2) + 2 + 4\omega \coth^{-1} \left(\frac{\eta+1}{\eta-1} \right)}{2 \ln 2}. \quad (\text{S114})$$

For large μ we therefore obtain

$$S^{\infty} = \log_2 \left(\frac{\eta^{\bar{n}+1}}{\eta - 1} \right) - h(\bar{n}). \quad (\text{S115})$$

Thus we find

$$\Phi(\eta, \bar{n}) \leq \Phi_{\text{amp}}(\eta, \bar{n}), \quad (\text{S116})$$

where

$$\Phi_{\text{amp}}(\eta, \bar{n}) := \begin{cases} \log_2 \left(\frac{\eta^{\bar{n}+1}}{\eta - 1} \right) - h(\bar{n}) & \text{for } \bar{n} < (\eta - 1)^{-1}, \\ 0 & \text{otherwise.} \end{cases} \quad (\text{S117})$$

In general, $\Phi_{\text{amp}}(\eta, \bar{n})$ does not coincide with the best known lower bound which is given by the coherent information of the channel in Eq. (S92). Thus, the two-way capacity of the amplifier channel satisfies

$$\log_2 \left(\frac{\eta}{\eta - 1} \right) - h(\bar{n}) \leq \mathcal{C}_{\text{amp}}(\eta, \bar{n}) \leq \Phi_{\text{amp}}(\eta, \bar{n}).$$

It is easy to check that, for the quantum-limited amplifier ($\bar{n} = 0$), the previous upper and lower bounds coincide, thus determining its two-way capacity

$$\mathcal{C}_{\text{amp}}(\eta) = \log_2 \left(\frac{\eta}{\eta - 1} \right). \quad (\text{S118})$$

Note that $\mathcal{C}_{\text{amp}}(\eta)$ turns out to coincide with the unassisted quantum capacity $Q_{\text{amp}}(\eta)$ [S25, S30]. The result of Eq. (S118) sets the fundamental limit for secret-key generation, entanglement distillation and quantum communication with amplifiers. A trivial consequence of the formula is that infinite amplification is useless for communication since $\mathcal{C}_{\text{amp}}(\infty) \rightarrow 0$. For an amplifier with typical gain 2, the maximum achievable rate for quantum communication is just 1 qubit per use.

4. Entanglement flux of the additive-noise Gaussian channel

Consider an additive-noise Gaussian channel $\mathcal{E}_{\text{add}}(\xi)$ with noise variance $\xi \geq 0$. For $\xi \geq 1$ this channel is entanglement breaking and therefore we have $\Phi(\xi) = 0$. For $\xi < 1$ we compute the relative entropy $S^{\mu} := S(\rho^{\mu} || \tilde{\sigma}^{\mu})$ from the CMs $V^{\mu}(1, 0, \xi)$ and $\tilde{V}^{\mu}(1, 0, \xi)$ of the zero-mean Gaussian states ρ^{μ} and $\tilde{\sigma}^{\mu}$. Using Theorem 6 and discarding terms $O(\mu^{-1})$, we get

$$S(\rho_{\mu}) \rightarrow \log_2(e^2 \xi \mu), \quad (\text{S119})$$

$$-\text{Tr}(\rho_{\mu} \log_2 \tilde{\sigma}_{\mu}) \rightarrow \frac{\ln \left[\frac{(2\mu-1)(2\xi+2\mu-1)}{4} \right] + 2(1 + \xi)}{2 \ln 2}. \quad (\text{S120})$$

which leads to

$$S^{\infty} = \liminf_{\mu} S^{\mu} = \lim_{\mu} S^{\mu} = \frac{\xi - 1}{\ln 2} - \log_2 \xi. \quad (\text{S121})$$

Thus we find

$$\Phi(\xi) \leq \Phi_{\text{add}}(\xi) := \begin{cases} \frac{\xi-1}{\ln 2} - \log_2 \xi & \text{for } \xi < 1, \\ 0 & \text{otherwise.} \end{cases} \quad (\text{S122})$$

The best lower bound is its coherent information $I_C(\xi)$ of Eq. (S94), so that the two-way capacity satisfies

$$-1/\ln 2 - \log_2 \xi \leq \mathcal{C}_{\text{add}}(\xi) \leq \Phi_{\text{add}}(\xi). \quad (\text{S123})$$

5. Secondary canonical forms

For the conjugate of the amplifier it is easy to check that this channel is always entanglement-breaking, so that it has zero flux and, therefore, zero two-way capacity $\mathcal{C} = 0$. The A_2 -form [S20], which is a ‘half’ depolarising channel, is also an entanglement-breaking channel, so that $\Phi = \mathcal{C} = 0$. Finally, for the B_1 -form [S20], we find the trivial bound $\Phi = +\infty$.

C. Discussion on potential energy constraints

It is important to remark that the two-way capacities that we computed for Gaussian channels are bounded quantities, i.e., they do not diverge even if the maximum is achieved in the limit of infinite input energy. In general, any correct definition (forward, backward, or two-way) of quantum capacity, entanglement-distillation capacity and secret-key capacity for a Gaussian channel does not need to impose any energy constraint at the input, because these ultimate quantities are naturally bounded by the laws of quantum mechanics (they are unbounded only in the trivial case of an identity channel). Clearly, the situation is completely different for the classical capacities (forward, backward, or two-way), which are known to diverge in the absence of energy constraints.

As a consequence, any upper bound of the two-way capacities, $Q_2(\mathcal{E})$, $D_2(\mathcal{E})$ and $K(\mathcal{E})$, *must not* depend on the input energy. This is indeed the case of the entanglement flux $\Phi(\mathcal{E})$ defined in our paper. $\Phi(\mathcal{E})$ is a universal bound which applies to the performance of any quantum protocol independently from its energy, therefore providing a common platform where we can compare all protocols simultaneously (e.g., both single-photon based and highly-modulated CV protocols). In other words, $\Phi(\mathcal{E})$ is a unique quantity associated with the quantum channel. This is indeed the only way in which we can define a real benchmark for quantum repeaters: We must not artificially restrict the performances of direct point-to-point protocols over the channel.

We now discuss why energy-constrained versions of the two-way capacities Q_2 , D_2 and K are not only artificial but also secondary for practical applications with bosonic channels. The best way to show this is considering our main result for the lossy channel with arbitrary transmissivity η , for which we have proven that

$$Q_2(\eta) = D_2(\eta) = K(\eta) = \Phi(\eta) = -\log_2(1 - \eta). \quad (\text{S124})$$

Even if we consider energy constraints at the input, it is easy to show that: (1) the unconstrained bound $\Phi(\eta)$ is still very tight, since it is rapidly approached from below (i.e., from the lower bound given by the reverse coherent information); and (2) the unconstrained bound $\Phi(\eta)$ remains tighter than other constrained bounds based on the squashed entanglement, even when the input energy is restricted down to one photon.

Let us start with point (1). From Eq. (S88), we see that the reverse coherent information associated with a lossy channel and a two-mode squeezed vacuum state is equal to

$$I_{RC}(\bar{m}, \eta) = h(\bar{m}) - h[(1 - \eta)\bar{m}], \quad (\text{S125})$$

where \bar{m} is the mean number of photons at the input. The previous expression is obtained by setting $\mu = \bar{m} + 1/2$ in Eq. (S88) and using the h function defined in Eq. (S62). In Fig. S8, we see that $I_{RC}(\bar{m}, \eta)$ rapidly approaches the unconstrained upper bound $\Phi(\eta)$ already for $\bar{m} \simeq 1 - 5$ photons.

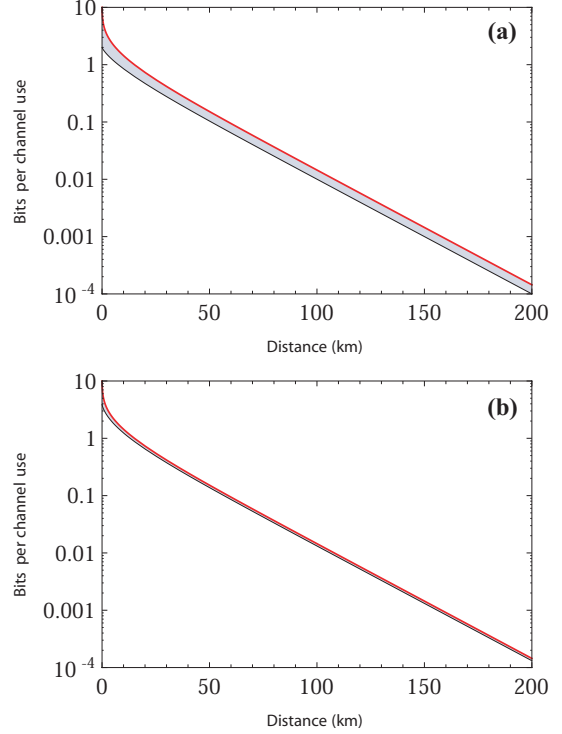

Figure S8: In panel (a) we plot the unconstrained upper bound $\Phi(\eta) = -\log_2(1 - \eta)$ (upper red line) and the constrained lower bound $I_{RC}(\bar{m}, \eta)$ (lower black line) given by the reverse coherent information in Eq. (S125) assuming $\bar{m} = 1$ photons at the input. Both are plotted in terms of the distance (km) assuming the standard loss rate of 0.2dB/km. The constrained two-way capacity of the lossy channel is in the middle dark area. Panel (b) as in (a) but with $\bar{m} = 5$ photons. We see how the unconstrained upper bound is rapidly reached already with a few photons.

Let us now consider point (2) and compare the unconstrained upper bound $\Phi(\eta)$ with the unconstrained TGW upper bound

$$K_{\text{TGW}}(\eta) = \log_2 \left(\frac{1 + \eta}{1 - \eta} \right), \quad (\text{S126})$$

and its energy-constrained version

$$K_{\text{TGW}}(\eta, \bar{m}) = h \left[\frac{(1 + \eta)\bar{m}}{2} \right] - h \left[\frac{(1 - \eta)\bar{m}}{2} \right]. \quad (\text{S127})$$

(Note that, in Ref. [S26] the latter was just a partial result used to derive the bound in Eq. (S126) in the limit for $\bar{m} \rightarrow +\infty$).

In Fig. S9 we clearly see that $\Phi(\eta)$ not only is much tighter than $K_{\text{TGW}}(\eta)$ but also outperforms the constrained version $K_{\text{TGW}}(\eta, \bar{m})$ for all input energies down to one photon in the most important regime for optical communications, i.e., for intermediate-long distances. At these distances, DV-QKD protocols have ideal performances at one mean photon per channel use (see Fig. 5 of the main text and Section X below). At short-intermediate distances, energy constraints do not really have so much practical value since we can use highly-modulated CV-QKD whose number of photons is high enough to approach the asymptotic infinite-energy behavior.

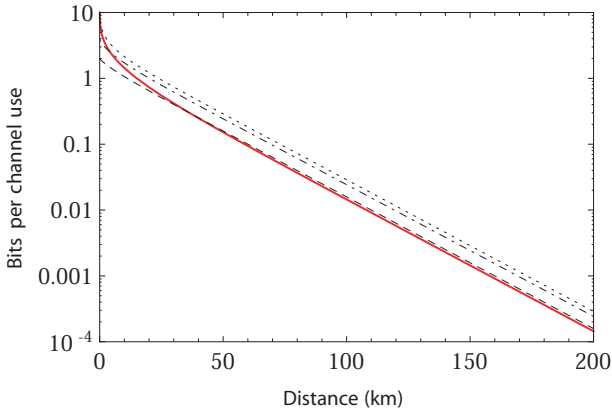

Figure S9: We show the unconstrained upper bound $\Phi(\eta) = -\log_2(1 - \eta)$ (solid red line) with respect to the unconstrained TGW bound (dotted), and the constrained TGW bound for $\bar{m} = 5$ photons (dashed-dotted) and $\bar{m} = 1$ photons (dashed line). Bounds are plotted in terms of distance (km) assuming the standard loss rate of 0.2dB/km. Note that $\Phi(\eta)$ remains the tighter upper bound even if we constrain the input energy down to one photon. This is true everywhere, except for short distances (where the energy constraint is not so interesting since we can use highly-modulated CV-QKD protocols).

That being said, the constrained bound $K_{\text{TGW}}(\eta, \bar{m})$ might have utility below one mean photon, but keeping in mind that this bound is non-tight, so that the lower bound provided by the reverse coherent information will probably give a better picture of the rates which are achievable at such low energies.

IX. RESULTS FOR DISCRETE-VARIABLE CHANNELS

Given a discrete-variable channel \mathcal{E} in d dimension, we can easily derive its Choi matrix $\rho_{\mathcal{E}} = (I \otimes \mathcal{E})(\Phi)$ from the maximally-entangled state

$$\Phi = \frac{1}{\sqrt{d}} \sum_{i=0}^{d-1} |ii\rangle, \quad (\text{S128})$$

where $\{|0\rangle, \dots, |i\rangle, \dots, |d-1\rangle\}$ is the computational basis of the qudit. We write the spectral decomposition

$$\rho_{\mathcal{E}} = \sum_k p_k |\varphi_k\rangle\langle\varphi_k|, \quad (\text{S129})$$

where $\mathbf{p} = \{p_k\}$ are the eigenvalues of the Choi matrix. The von Neumann entropy is simply equal to the Shannon entropy of the previous eigenvalues, i.e.,

$$S(\rho_{\mathcal{E}}) = H(\mathbf{p}) := -\sum_k p_k \log_2 p_k. \quad (\text{S130})$$

From the Choi matrix we may compute the coherent and reverse coherent information of the channel. In particular, for unital channels, these quantities coincide and are given by the simple formula in Eq. (S5), i.e.,

$$I_{(R)C}(\mathcal{E}) = \log_2 d - S(\rho_{\mathcal{E}}) = \log_2 d - H(\mathbf{p}). \quad (\text{S131})$$

To compute the entanglement flux of the channel (upper bound), recall that we have

$$\Phi(\mathcal{E}) := E_R(\rho_{\mathcal{E}}) \leq S(\rho_{\mathcal{E}} || \tilde{\sigma}), \quad (\text{S132})$$

for some suitable separable state $\tilde{\sigma}$. Let us write its spectral decomposition

$$\tilde{\sigma} = \sum_k s_k |\lambda_k\rangle\langle\lambda_k|, \quad (\text{S133})$$

where $|\lambda_k\rangle$ (s_k) are the orthogonal eigenstates (eigenvalues) of $\tilde{\sigma}$. We may then write

$$\begin{aligned} S(\rho_{\mathcal{E}} || \tilde{\sigma}) &= -S(\rho_{\mathcal{E}}) - \text{Tr}(\rho_{\mathcal{E}} \log_2 \tilde{\sigma}) \\ &= -H(\mathbf{p}) - \sum_k \langle\lambda_k | \rho_{\mathcal{E}} | \lambda_k\rangle \log_2 s_k. \end{aligned} \quad (\text{S134})$$

The separable state $\tilde{\sigma}$ may be constructed by applying the channel $I \otimes \mathcal{E}$ to the input separable state

$$\sigma = \frac{1}{d} \sum_{i=0}^{d-1} |ii\rangle\langle ii|, \quad (\text{S135})$$

so that we have the output

$$\tilde{\sigma} = \frac{1}{d} \sum_{i=0}^{d-1} |i\rangle\langle i| \otimes \mathcal{E}(|i\rangle\langle i|). \quad (\text{S136})$$

This specific choice will be optimal in some cases and suboptimal in others.

A. Erasure channel in arbitrary finite dimension

Consider a qudit in arbitrary dimension d with computational basis $\{|i\rangle\}$ (results can be easily specified to the case of a qubit $d = 2$). The erasure channel replaces an incoming qudit state ρ with an orthogonal erasure state

$|e\rangle := |d\rangle$ with some probability p . In other words, we have the action

$$\mathcal{E}_{\text{erase}}(\rho) = (1-p)\rho + p|e\rangle\langle e|. \quad (\text{S137})$$

The simplicity of this channel relies in the fact that the input states either are perfectly transmitted or they are lost (while in other quantum channels, the input states are all transmitted into generally-different outputs). This feature allows one to apply simple reasonings such as those in Ref. [S31] which determined the Q_2 of this channel (more precisely, the Q_2 of the qubit erasure channel, but the extension to arbitrary d is trivial).

It is easy to see that this channel is stretchable. In fact, any input unitary U applied to the state ρ is mapped into an output augmented unitary $U \oplus I$, i.e., we may write

$$\mathcal{E}_{\text{erase}}(U\rho U^\dagger) = (U \oplus I)\mathcal{E}_{\text{erase}}(\rho)(U \oplus I)^\dagger. \quad (\text{S138})$$

Let us write the Kraus decomposition of this channel

$$\mathcal{E}_{\text{erase}}(\rho) = A\rho A^\dagger + \sum_{i=0}^{d-1} A_i\rho A_i^\dagger, \quad (\text{S139})$$

where $A := \sqrt{1-p}I$ (with I being the $d \times d$ identity) and $A_i := \sqrt{p}|e\rangle\langle i|$. We then compute its Choi matrix

$$\rho_{\mathcal{E}_{\text{erase}}} = (1-p)\Phi + \frac{p}{d}(I \otimes |e\rangle\langle e|). \quad (\text{S140})$$

Note that $\text{Tr}[\Phi(I \otimes |e\rangle\langle e|)] = 0$, so that Eq. (S140) is the spectral decomposition of $\rho_{\mathcal{E}}$ over two orthogonal subspaces, where Φ has eigenvalue $1-p$, and $I \otimes |e\rangle\langle e|$ is degenerate with d eigenvalues equal to p/d . Therefore, it is easy to compute the von Neumann entropy, which is

$$S(\rho_{\mathcal{E}_{\text{erase}}}) = -(1-p)\log_2(1-p) - p\log_2\left(\frac{p}{d}\right). \quad (\text{S141})$$

To compute the entanglement flux of the channel, we consider the separable state $\tilde{\sigma}$ in Eq. (S136), which here becomes

$$\tilde{\sigma} = \frac{1}{d} \sum_{i=0}^{d-1} [(1-p)|ii\rangle\langle ii| + p|i, e\rangle\langle i, e|]. \quad (\text{S142})$$

We have now all the elements to be used in Eq. (S134), which provides

$$\Phi(\mathcal{E}_{\text{erase}}) \leq S(\rho_{\mathcal{E}_{\text{erase}}} || \tilde{\sigma}) = (1-p)\log_2 d. \quad (\text{S143})$$

For the lower bound, one can easily check that the coherent and reverse coherent information of this channel are not sufficient to reach the upper bound, since we get

$$I_C(\mathcal{E}_{\text{erase}}) = (1-2p)\log_2 d, \quad (\text{S144})$$

$$I_{RC}(\mathcal{E}_{\text{erase}}) = (1-p)\log_2 d - H_2(p). \quad (\text{S145})$$

In particular, the reverse coherent information has the extra term $H_2(p)$. Note that these quantities are achievable rates for one-way entanglement distillation but not

necessarily the optimal rates. Indeed it is easy to find a distillation strategy based on one-way backward CCs which reaches $(1-p)\log_2 d$. This follows the same reasoning of Ref. [S31].

Alice can send halves of EPR states to Bob in large n uses of the channel. A fraction $1-p$ will be perfectly distributed. The identification of these good cases can be done by Bob performing a dichotomic POVM $\{|e\rangle\langle e|, I - |e\rangle\langle e|\}$ on each received system and communicating to Alice which instances were perfectly transmitted. At that point Alice and Bob possess $n(1-p)$ EPR states with $\log_2 d$ ebits each. On average this gives a rate of $(1-p)\log_2 d$ ebits per channel use. Thus, one may write

$$D_1(\rho_{\mathcal{E}_{\text{erase}}}) \geq (1-p)\log_2 d, \quad (\text{S146})$$

whose combination with Eq. (S143) provides

$$\begin{aligned} \mathcal{C}(\mathcal{E}_{\text{erase}}) &= D_2(\mathcal{E}_{\text{erase}}) = Q_2(\mathcal{E}_{\text{erase}}) \\ &= K(\mathcal{E}_{\text{erase}}) = \Phi(\mathcal{E}_{\text{erase}}) = (1-p)\log_2 d. \end{aligned} \quad (\text{S147})$$

Since the two-way quantum capacity of the erasure channel is already known [S31], our novel result regards the determination of its secret key capacity

$$K(\mathcal{E}_{\text{erase}}) = (1-p)\log_2 d. \quad (\text{S148})$$

It is clear that, for qubits, we have $K(\mathcal{E}_{\text{erase}}) = 1-p$.

B. Qubit Pauli channels

Consider a Pauli channel \mathcal{P} acting on a qubit state ρ . The Kraus representation of this channel is

$$\begin{aligned} \mathcal{P}(\rho) &= \sum_{k=0}^3 p_k P_k \rho P_k^\dagger \\ &= p_0\rho + p_1 X\rho X + p_2 Y\rho Y + p_3 Z\rho Z, \end{aligned} \quad (\text{S149})$$

where $\mathbf{p} := \{p_k\}$ is a probability distribution and $P_k \in \{I, X, Y, Z\}$ are Pauli operators, with I the identity and

$$X := \begin{pmatrix} 0 & 1 \\ 1 & 0 \end{pmatrix}, \quad Y := \begin{pmatrix} 0 & -i \\ i & 0 \end{pmatrix}, \quad Z := \begin{pmatrix} 1 & 0 \\ 0 & -1 \end{pmatrix}. \quad (\text{S150})$$

It is easy to check that a Pauli channel is stretchable since Pauli operators (qubit teleportation unitaries) either commute or anticommute with the other Pauli operators (Kraus operators of the channel). For a Pauli channel we can write the stronger condition

$$[\rho_{\mathcal{P}}, P_k \otimes P_k^*] = 0 \quad \text{for any } k, \quad (\text{S151})$$

i.e., the Choi matrix is invariant under twirling operations restricted to the generators of the Pauli group. In fact, the Choi matrix of a Pauli channel is Bell-diagonal, i.e., it has spectral decomposition

$$\rho_{\mathcal{P}} = \sum_{k=0}^3 p_k \Phi_k, \quad (\text{S152})$$

where the eigenvalues p_k are the channel probabilities, and the eigenvectors Φ_k are the four Bell states

$$\left\{ \frac{|00\rangle \pm |11\rangle}{\sqrt{2}}, \frac{|10\rangle \pm |01\rangle}{\sqrt{2}} \right\}. \quad (\text{S153})$$

It is clear that $S(\rho_{\mathcal{P}}) = H(\mathbf{p})$. Then, using the separable state $\tilde{\sigma}$ as in Eq. (S136), we derive the following upper bound for the entanglement flux of this channel

$$\Phi(\mathcal{P}) \leq 1 - H(\mathbf{p}) + H_2(p_1 + p_2). \quad (\text{S154})$$

Since a Pauli channel is unital, its (reverse) coherent information is just given by $I_{(R)C}(\mathcal{P}) = 1 - H(\mathbf{p})$. Therefore, the two-way capacity of a Pauli channel with arbitrary distribution $\mathbf{p} := \{p_k\}$ must satisfy

$$1 - H(\mathbf{p}) \leq \mathcal{C}(\mathcal{P}) \leq 1 - H(\mathbf{p}) + H_2(p_1 + p_2). \quad (\text{S155})$$

Latter result can be made stronger by exploiting the fact that $\rho_{\mathcal{P}}$ is Bell-diagonal. For any such a state we can compute the REE by using the formula of Ref. [S32]. In fact, let us set $p_{\max} := \max\{p_k\}$, then we may write

$$E_R(\rho_{\mathcal{P}}) = \begin{cases} 1 - H_2(p_{\max}) & \text{if } p_{\max} \geq \frac{1}{2} \\ 0 & \text{otherwise.} \end{cases} \quad (\text{S156})$$

Thus, we have the tighter upper bound

$$1 - H(\mathbf{p}) \leq \mathcal{C}(\mathcal{P}) \leq \begin{cases} 1 - H_2(p_{\max}) & \text{if } p_{\max} \geq \frac{1}{2} \\ 0 & \text{otherwise.} \end{cases}. \quad (\text{S157})$$

In the following subsections, we specialize this result for the depolarising and dephasing channels.

1. Depolarising channel

This is a Pauli channel with probability distribution

$$\mathbf{p} = \left\{ 1 - \frac{3p}{4}, \frac{p}{4}, \frac{p}{4}, \frac{p}{4} \right\}, \quad (\text{S158})$$

so that we have

$$\begin{aligned} \mathcal{P}_{\text{depol}}(\rho) &= \left(1 - \frac{3p}{4}\right) \rho + \frac{p}{4}(X\rho X + Y\rho Y + Z\rho Z) \\ &= (1-p)\rho + p\frac{I}{2}. \end{aligned} \quad (\text{S159})$$

Let us set

$$\kappa(p) := 1 - H_2\left(\frac{3p}{4}\right). \quad (\text{S160})$$

Then, from Eq. (S157), we derive the following bounds for the two-way capacity of the depolarising channel

$$\kappa(p) - \frac{3p}{4} \log_2 3 \leq \mathcal{C}(\mathcal{P}_{\text{depol}}) \leq \kappa(p), \quad (\text{S161})$$

for $p \leq 2/3$, while $\mathcal{C}(\mathcal{P}_{\text{depol}}) = 0$ otherwise.

2. Dephasing channel

This is a Pauli channel with probability distribution $\mathbf{p} = \{1-p, 0, 0, p\}$, so that we have

$$\mathcal{P}_{\text{deph}}(\rho) = (1-p)\rho + pZ\rho Z. \quad (\text{S162})$$

It is easy to see that $H(\mathbf{p}) = H_2(p_{\max}) = H_2(p)$, so that Eq. (S157) leads to

$$\begin{aligned} \mathcal{C}(\mathcal{P}_{\text{deph}}) &= D_2(\mathcal{P}_{\text{deph}}) = Q_2(\mathcal{P}_{\text{deph}}) \\ &= K(\mathcal{P}_{\text{deph}}) = \Phi(\mathcal{P}_{\text{deph}}) = 1 - H_2(p), \end{aligned} \quad (\text{S163})$$

which also coincides with the unassisted quantum capacity of this channel $Q(\mathcal{P}_{\text{deph}})$ [S33].

C. Depolarising channel in arbitrary finite dimension

Consider a depolarising channel acting on a qudit with dimension $d \geq 2$. This channel can be written as

$$\begin{aligned} \mathcal{P}_{d\text{-depol}}(\rho) &= (1-p)\rho + p\frac{I}{d} \\ &= A\rho A^\dagger + \sum_{i,j=0}^{d-1} A_{ij}\rho A_{ij}^\dagger, \end{aligned} \quad (\text{S164})$$

where $A = \sqrt{1-p}I$ and $A_{ij} = \sqrt{p/d}|i\rangle\langle j|$. It is manifestly stretchable. Its Choi matrix is the isotropic state

$$\rho_{\mathcal{P}_{d\text{-depol}}} = (1-p)|\Phi\rangle\langle\Phi| + \frac{p}{d^2}I \otimes I, \quad (\text{S165})$$

satisfying the twirling condition

$$[\rho_{\mathcal{P}_{d\text{-depol}}}, U \otimes U^*] = 0, \quad (\text{S166})$$

for any qudit unitary U .

The REE of an isotropic state can be evaluated exactly by using the formula in Ref. [S34]. Thus we can exactly compute the entanglement flux of the d -dimensional depolarising channel. Let us set

$$f := \frac{d^2 - 1}{d^2} p, \quad (\text{S167})$$

$$\kappa(d, p) := \log_2 d - H_2(f) - f \log_2(d-1). \quad (\text{S168})$$

Then, we may write the following expression

$$\Phi(\mathcal{P}_{d\text{-depol}}) = E_R(\rho_{\mathcal{P}_{d\text{-depol}}}) = \begin{cases} \kappa(d, p) & \text{if } p < \frac{d}{d+1}, \\ 0 & \text{otherwise.} \end{cases} \quad (\text{S169})$$

Because the depolarising channel is unital, we may use Eq. (S131) to compute its (reverse) coherent information. We find

$$\begin{aligned} I_{(R)C}(\mathcal{P}_{d\text{-depol}}) &= \log_2 d - H_2(f) - f \log_2(d^2 - 1) \\ &= \kappa(d, p) - f \log_2(d+1). \end{aligned} \quad (\text{S170})$$

Thus, the two-way capacity of this channel must satisfy the bounds

$$\kappa(d, p) - f \log_2(d+1) \leq \mathcal{C}(\mathcal{P}_{d\text{-depol}}) \leq \kappa(d, p), \quad (\text{S171})$$

for $p < d/(d+1)$, while zero otherwise.

D. Dephasing channel in arbitrary finite dimension

Consider a generalized dephasing channel affecting a qudit in arbitrary dimension $d \geq 2$. This channel has Kraus representation [S35, S36]

$$\mathcal{P}_{d\text{-deph}}(\rho) = \sum_{i=0}^{d-1} A_i \rho A_i^\dagger, \quad (\text{S172})$$

where $A_i := \sqrt{P_i(p, d)} Z^i$, Z defined in Eq. (S29) and $P_i(p, d)$ is the probability of i phase flips, equal to

$$P_i(p, d) = \binom{d-1}{i} p^i (1-p)^{d-1-i}. \quad (\text{S173})$$

The channel is clearly stretchable. In fact, for any qudit teleportation unitary $T_{ab} := X^a Z^b$, we can write

$$Z^i (T_{ab} \rho T_{ab}^\dagger) Z^{\dagger i} = T_{ab} (Z^i \rho Z^{\dagger i}) T_{ab}^\dagger, \quad (\text{S174})$$

by using Eq. (S30).

The Choi matrix of the channel is given by

$$\rho_{\mathcal{P}_{d\text{-deph}}} = \sum_{m, i, j} \frac{P_m(p, d)}{d} \exp\left[\frac{2i\pi}{d}(i-j)m\right] |ii\rangle\langle jj|. \quad (\text{S175})$$

By diagonalizing, we find d non-zero eigenvalues $\mathbf{P} := \{P_0(p, d), \dots, P_{d-1}(p, d)\}$, so that the Von Neumann entropy is just given by

$$S(\rho_{\mathcal{P}_{d\text{-deph}}}) = H(\mathbf{P}). \quad (\text{S176})$$

The separable state $\tilde{\sigma}$ in Eq. (S136) turns out to be diagonal in the computational basis and takes the form

$$\tilde{\sigma} = \sum_{i=0}^{d-1} \frac{1}{d} |ii\rangle\langle ii|.$$

Thus, using Eq. (S134), we find

$$\Phi(\mathcal{P}_{d\text{-deph}}) \leq S(\rho_{\mathcal{P}_{d\text{-deph}}} || \tilde{\sigma}) = \log_2 d - H(\mathbf{P}). \quad (\text{S177})$$

Since this channel is unital, from Eq. (S131) we have that its (reverse) coherent information is $I_{(R)C}(\mathcal{P}_{d\text{-deph}}) = \log_2 d - H(\mathbf{P})$, so that lower and upper bounds coincide. This means that this channel is distillable and its two-way capacity is equal to

$$\begin{aligned} \mathcal{C}(\mathcal{P}_{d\text{-deph}}) &= D_2(\mathcal{P}_{d\text{-deph}}) = Q_2(\mathcal{P}_{d\text{-deph}}) \\ &= K(\mathcal{P}_{d\text{-deph}}) = \Phi(\mathcal{P}_{d\text{-deph}}) = \log_2 d - H(\mathbf{P}). \end{aligned} \quad (\text{S178})$$

E. Amplitude damping channel

The amplitude damping channel describes the process of energy dissipation through spontaneous emission in a two-level system. Its application to an input qubit state is defined by the Kraus representation

$$\mathcal{E}_{\text{damp}}(\rho) = \sum_{i=0,1} A_i \rho A_i^\dagger, \quad (\text{S179})$$

where

$$A_0 := |0\rangle\langle 0| + \sqrt{1-p}|1\rangle\langle 1|, \quad (\text{S180})$$

$$A_1 := \sqrt{p}|0\rangle\langle 1|. \quad (\text{S181})$$

and p is the probability of damping. This channel is clearly non-stretchable since we have $|0\rangle\langle 0| \rightarrow |0\rangle\langle 0|$ and $|1\rangle\langle 1| \rightarrow p|0\rangle\langle 0| + (1-p)|1\rangle\langle 1|$. Therefore, there is no unitary U able to realize $U \mathcal{E}_{\text{damp}}(|0\rangle\langle 0|) U^\dagger = \mathcal{E}_{\text{damp}}(X|0\rangle\langle 0|X)$ for Pauli operator X .

The amplitude damping channel is partly-stretchable. In fact, it can be decomposed as

$$\mathcal{E}_{\text{damp}} = \mathcal{E}_{\text{CV} \rightarrow \text{DV}} \circ \mathcal{E}_{\eta(p)} \circ \mathcal{E}_{\text{DV} \rightarrow \text{CV}}, \quad (\text{S182})$$

where $\mathcal{E}_{\text{DV} \rightarrow \text{CV}}$ is an identity mapping from the original qubit (e.g. a spin) to a single-rail qubit, which is the subspace of a bosonic mode spanned by the vacuum and the single photon states; then, $\mathcal{E}_{\eta(p)}$ is a lossy channel with transmissivity $\eta(p) := 1-p$; finally, $\mathcal{E}_{\text{CV} \rightarrow \text{DV}}$ is an identity mapping from the single-rail qubit to the original qubit. Note that the two mappings can be performed via perfect hybrid teleportation and the middle lossy channel preserves the 2-dimensional effective Hilbert space of the system.

Using teleportation stretching and Theorem 5, we may write the decomposition

$$\rho_{\text{ab}}(\mathcal{E}_{\text{damp}}^{\otimes n}) = \bar{\Lambda}\left(\rho_{\mathcal{E}_{\eta(p)}}^{\otimes n}\right). \quad (\text{S183})$$

Thus, our reduction method provides the upper bound

$$\mathcal{C}(\mathcal{E}_{\text{damp}}) \leq \Phi[\mathcal{E}_{\eta(p)}] = -\log_2 p. \quad (\text{S184})$$

The best lower bound is given by optimizing the reverse coherent information over the input states $\rho_u = \text{diag}(1-u, u)$ for $0 \leq u \leq 1$. In fact, we have [S3]

$$\begin{aligned} I_{RC}(p) &:= \max_u I_{RC}(\mathcal{E}_{\text{damp}}, \rho_u) \\ &= \max_u \{H_2(u) - H_2(up)\}. \end{aligned} \quad (\text{S185})$$

This is an achievable lower bound for one-way backward entanglement distillation. Thus, we can write

$$I_{RC}(p) \leq \mathcal{C}(\mathcal{E}_{\text{damp}}) \leq -\log_2 p. \quad (\text{S186})$$

This is strictly separated from the $Q_1 = Q$ of the channel, which is given by [S3]

$$Q_1(\mathcal{E}_{\text{damp}}) = \max_u \{H_2[u(1-p)] - H_2(up)\}. \quad (\text{S187})$$

X. MAXIMUM RATES ACHIEVABLE BY CURRENT QKD PROTOCOLS

We consider the state of the art in high-rate QKD, by analyzing the maximum rates which are achievable by current practical protocols in CVs and DVs. We assume the optimal asymptotic case of infinitely long keys, so that finite-size effects are negligible. We also assume ideal parameters. For CVs this means: Unit detector efficiency, zero excess noise, large modulation and unit reconciliation efficiency. For DVs this means: Unit detector efficiencies, zero dark count rates, zero intrinsic error, unit error correction efficiency, and no other internal loss in the devices. Note that all the following results are already present in the literature or are easily derivable from those in the literature. They are given to the reader for the sake of completeness.

A. Continuous-variable protocols

- No-switching protocol [S37]. This is the practical CV protocol with the highest secret key rate. It is based on coherent states and heterodyne detection. In reverse reconciliation (RR), its maximum secret key rate over a lossy channel with transmissivity η is equal to

$$R_{\text{no-switch}} = \log_2 \left[\frac{\eta}{e(1-\eta)} \right] + s \left(\frac{2-\eta}{2\eta} \right), \quad (\text{S188})$$

where $s(\cdot)$ is the entropic function given in Eq. (S62). For high loss ($\eta \simeq 0$), it scales as $\simeq \eta/2 \ln 2$, which is 1/2 of the secret key capacity.

- Switching protocol [S38, S39]. This was the first practical CV protocol. It is based on coherent states and homodyne detection (with switching between the two quadratures). In RR, it reaches the rate

$$R_{\text{switch}} = \frac{1}{2} \log_2 \left(\frac{1}{1-\eta} \right), \quad (\text{S189})$$

which is 1/2 of the the secret key capacity. For high loss, it clearly scales as the previous protocol.

- CV measurement-device-independent (MDI) protocol [S40, S41]. This is based on coherent states sent to an untrusted relay implementing a CV Bell detection. Alice-relay channel has transmissivity η_A and Bob-relay channel has transmissivity η_B , so that the total Alice-Bob channel transmissivity is $\eta = \eta_A \eta_B$. In the symmetric configuration with the relay perfectly in the middle ($\eta_A = \eta_B$) [S40, S42], it has maximum rate

$$R_{\text{CVMDI-sym}} = \log_2 \left[\frac{\eta}{e^2(1-\sqrt{\eta})} \right] + s \left(\frac{1}{\sqrt{\eta}} - \frac{1}{2} \right). \quad (\text{S190})$$

In the asymmetric configuration ($\eta_A \neq \eta_B$), it has maxi-

imum rate

$$R_{\text{CVMDI-asym}} = s \left(\frac{1}{\eta_B} - \frac{1}{2} \right) - s \left(\frac{2-\eta_A-\eta_B}{2|\eta_A-\eta_B|} \right) + \log_2 \left(\frac{\eta_A \eta_B}{e|\eta_A-\eta_B|} \right). \quad (\text{S191})$$

In particular, in the most asymmetric configuration, where the relay coincides with Alice ($\eta_A = 1$) [S40, S43], we recover the one-way rate of Eq. (S188).

- CV two-way protocols [S44]. In the first main variant, Bob sends coherent states to Alice, who randomly displaces their amplitudes before sending them back to Bob for heterodyne detection. In RR (Bob as encoder), this protocol has maximum rate

$$R_{\text{2way-het}} = \frac{1}{2} \left\{ s \left[\frac{2-\eta+\eta^2}{2\eta(1+\eta)} \right] + \log_2 \left[\frac{\eta(1+\eta)}{e(1-\eta)} \right] \right\}. \quad (\text{S192})$$

In the second main variant, the protocol runs as before except that Bob's measurement is homodyne detection (with switching between the quadratures). In RR, it has maximum rate [S45]

$$R_{\text{2way-hom}} = \frac{1}{4} \log_2 \left(\frac{1+\eta^2}{1-\eta} \right). \quad (\text{S193})$$

It is easy to check that both the variants scale as $\simeq \eta/4 \ln 2$ for high loss. Despite the fact that two-way protocols have lower key rates than one-way protocols in a lossy channel, they are more robust when excess noise is present. In this case, one considers the ‘‘security threshold’’ of the protocol which is defined as the maximum tolerable excess noise above which the rate becomes negative. Two-way protocols have higher security thresholds than one-way protocols [S44, S45].

B. Discrete-variable protocols

Here we consider various DV protocols. As said before, we assume the optimal asymptotic case of infinitely long keys and also ideal parameters, which here means: Unit detector efficiencies, zero dark count rates, zero intrinsic error, unit error correction efficiency, and no other internal loss in the devices. Under these assumptions, we consider the ideal BB84 protocol with single photon sources [S46], the BB84 with weak coherent pulses and decoy states [S47, S48], and DV-MDI-QKD [S49, S50].

1. Prepare&measure BB84 with ideal single-photon pulses

Let us consider the BB84 protocol [S46] assuming that Alice's source generates perfect single-photon pulses. The general formula of the key rate can be found in Ref. [S47]. It reduces to the following expression

$$R = \bar{R} \{ [1 - H_2(Q)] - \delta(Q) \}, \quad (\text{S194})$$

where H_2 is the binary Shannon entropy. In Eq. (S194), $\delta(Q) = f H_2(Q)$ is a function accounting for the leak of information from imperfect error correction, $f \geq 1$ is the efficiency of the classical error correction codes, Q is the total error rate (QBER), and \bar{R} is the total detection rate after quantum communication (the raw key). Under ideal conditions of zero dark-count rates, unit efficiency detectors, perfect visibility, and perfect classical error correction ($f = 1$), one has $Q = 0$ and obtains the following maximum rate $R_{\text{BB84-1ph}} = \eta/2$, setting the maximum rate for the current DV protocols.

2. BB84 with weak coherent pulses and decoy states

A realistic photon source is a device emitting attenuated coherent pulses. In this case, the performance of the protocol depends on an additional parameter which is the intensity of the source. In the BB84 protocol, with weak coherent pulses and decoy states [S48], Alice randomly changes the intensity μ of the pulses, and reveals publicly their values during the final classical communication. In this way Eve cannot adapt her attacks during the quantum communication. The μ -dependent key rate of the protocol is given by [S47]

$$R^\mu = \bar{R} \left\{ Y_0^\mu + Y_1^\mu \left[1 - H_2 \left(\frac{Q^\mu}{Y_1^\mu} \right) \right] - \delta(Q^\mu) \right\}, \quad (\text{S195})$$

where Q^μ is the μ -dependent QBER, and $Y_n^\mu = R_n^\mu/\bar{R}$ is the ratio between the μ -dependent detection rate R_n^μ ,

associated to Alice sending n photons, and the total detection rate \bar{R} . Assuming ideal conditions, one finds $R^\mu = e^{-\mu} \eta \mu / 2$. The optimal key rate is obtained by maximizing over the intensities, i.e., $R = \max_\mu R^\mu$. It is easy to check that the optimum is given by $\mu = 1$ and the maximum key rate becomes $R_{\text{BB84-decoy}} = \eta/(2e)$.

3. Discrete-variable MDI-QKD protocol

The general expression of the key rate is given by the following expression [S50]

$$R = P_Z^{11} Y_Z^{11} [1 - H_2(e_Z^{11})] - G_Z \delta(Q_Z), \quad (\text{S196})$$

where $P_Z^{11} = \mu_A \mu_B \exp[-(\mu_A + \mu_B)]$ is the joint probability that both emitters (with intensities μ_A and μ_B) generate a single-photon pulse. The quantity Y_Z^{11} gives the gain in the Z -basis (one assumes $Y_X^{11} = Y_Z^{11}$ for the X -basis), and e_Z^{11} is the error rate in the Z -basis. Finally, the quantity G_Z describes the gain and Q_Z the QBER, both in the Z -basis. Under ideal conditions, the μ -dependent key rate becomes

$$R^{\mu_A \mu_B} = \frac{1}{2} e^{-(\mu_A + \mu_B)} \eta_A \eta_B \mu_A \mu_B, \quad (\text{S197})$$

where η_A and η_B are the transmissivities of Alice's and Bob's channels. It is easy to check that the maximum is taken for $\mu_A = \mu_B = 1$, providing $R_{\text{DV-MDI}} = \eta/(2e^2)$.

-
- [S1] Schumacher, B. & Nielsen, M. A. Quantum data processing and error correction. *Phys. Rev. A* **54**, 2629 (1996).
- [S2] Lloyd, S. Capacity of the noisy quantum channel. *Phys. Rev. A* **55**, 1613 (1997).
- [S3] García-Patrón, R., Pirandola, S., Lloyd, S. & Shapiro, J. H. Reverse coherent information. *Phys. Rev. Lett.* **102**, 210501 (2009).
- [S4] Pirandola, S., R. García-Patrón, Braunstein, S. L. & Lloyd, L. Direct and reverse secret-key capacities of a quantum channel. *Phys. Rev. Lett.* **102**, 050503 (2009).
- [S5] Devetak, I. & Winter, A. Distillation of secret key and entanglement from quantum states. *Proc. R. Soc. A* **461**, 207 (2005).
- [S6] Holevo, A. S. Classical capacities of quantum channels with constrained inputs. *Probability Theory and Applications* **48**, 359 (2003). See also quant-ph/0211170.
- [S7] D'Ariano, G. M., Kretschmann, D., Schlingemann, D. & Werner, R. F. Reexamination of quantum bit commitment: The possible and the impossible. *Phys. Rev. A* **76**, 032328 (2007).
- [S8] Winter, A. Tight uniform continuity bounds for quantum entropies: conditional entropy, relative entropy distance and energy constraints. *Preprint arXiv:1507.07775v6* (2016).
- [S9] Nielsen, M. A. & Chuang, I. L. Quantum computation and quantum information (Cambridge University Press, Cambridge, 2000).
- [S10] Donald, M. J. & Horodecki, M. Continuity of Relative Entropy of Entanglement. *Phys. Lett. A* **264**, 257-260 (1999).
- [S11] Horodecki, K., Horodecki, M., Horodecki, P. & Oppenheim, J. Secure key from bound entanglement. *Phys. Rev. Lett.* **94**, 160502 (2005).
- [S12] Vedral, V. The role of relative entropy in quantum information theory. *Rev. Mod. Phys.* **74**, 197 (2002).
- [S13] Holevo, A. Quantum Systems, Channels, Information: A Mathematical Introduction (De Gruyter, Berlin-Boston, 2012).
- [S14] Pirandola, S. *et al.* Advances in quantum teleportation. *Nature Photon.* **9**, 641-652 (2015).
- [S15] Bennett, C. H., DiVincenzo, D. P., Smolin, J. A. & Wootters, W. K. Mixed-state entanglement and quantum error correction. *Phys. Rev. A* **54**, 3824-3851 (1996).
- [S16] Nielsen, M. A. & Chuang, I. L. Programmable Quantum Gate Arrays. *Phys. Rev. Lett.* **79**, 321 (1997).
- [S17] Ishizaka, S. & Hiroshima, T. Asymptotic Teleportation Scheme as a Universal Programmable Quantum Processor. *Phys. Rev. Lett.* **101**, 240501 (2008).
- [S18] Arvind, B. Dutta, N. Mukunda, & R. Simon. The real symplectic groups in quantum mechanics and optics.

- Pramana* **45**, 471-497 (1995).
- [S19] Banchi, L., Braunstein, S.L. & Pirandola, S. Quantum fidelity for arbitrary Gaussian states. *Phys. Rev. Lett.* **115**, 260501 (2015).
- [S20] Weedbrook, C. *et al.* Gaussian quantum information. *Rev. Mod. Phys.* **84**, 621 (2012).
- [S21] Pirandola, S., Serafini, A. & Lloyd, S. Correlation matrices of two-mode bosonic systems. *Phys. Rev. A* **79**, 052327 (2009).
- [S22] Pirandola, S. Entanglement Reactivation in Separable Environments. *New J. Phys.* **15**, 113046 (2013).
- [S23] Pirandola, S., Spedalieri, G., Braunstein, S. L., Cerf, N. J. & Lloyd, S. Optimality of Gaussian discord. *Phys. Rev. Lett.* **113**, 140405 (2014).
- [S24] Chen, X.-y. Gaussian relative entropy of entanglement. *Phys. Rev. A* **71**, 062320 (2005).
- [S25] Holevo, A. S. & Werner, R. F. Evaluating capacities of bosonic Gaussian channels. *Phys. Rev. A* **63**, 032312 (2001).
- [S26] Takeoka, M., Guha, S. & Wilde, M. M. Fundamental rate-loss tradeoff for optical quantum key distribution. *Nature Comm.* **5**, 5235 (2015).
- [S27] Goodenough, K., Elkouss, D. & Wehner, S. Assessing the performance of quantum repeaters for all phase-insensitive Gaussian bosonic channels. *Preprint arXiv:1511.08710v1* (2015).
- [S28] Pirandola, S. Quantum discord as a resource for quantum cryptography. *Sci. Rep.* **4**, 6956 (2014).
- [S29] Modi, K. *et al.* The classical-quantum boundary for correlations: Discord and related measures. *Rev. Mod. Phys.* **84**, 1655 (2012).
- [S30] Wolf, M. M., Pérez-García, D. & Giedke, G. Quantum Capacities of Bosonic Channels. *Phys. Rev. Lett.* **98**, 130501 (2007).
- [S31] Bennett, C. H., DiVincenzo, D. P., & Smolin, J. A. Capacities of Quantum Erasure Channels. *Phys. Rev. Lett.* **78**, 3217-3220 (1997).
- [S32] Vedral, V., Plenio, M. B., Rippin, M. A. & Knight, P. L. Quantifying Entanglement. *Phys. Rev. Lett.* **78**, 2275-2279 (1997).
- [S33] Devetak, I. & Shor, P.W. The Capacity of a Quantum Channel for Simultaneous Transmission of Classical and Quantum Information, *Commun. Math. Phys.* **256**, 287-303 (2005).
- [S34] Synak, B., Horodecki, K & Horodecki, M. Bounds on localisable information via semidefinite programming. *J. Math. Phys.* **46**, 082107 (2005).
- [S35] Fukuda, M. & Holevo, A. S. On Weyl covariant channels, *Preprint quant-ph/0510148* (2005).
- [S36] Pirandola, S., Mancini, S., Braunstein, S. L. & Vitali, D. Minimal qudit code for a qubit in the phase-damping channel. *Phys. Rev. A* **77**, 032309 (2008).
- [S37] Weedbrook, C. *et al.* Quantum Cryptography Without Switching. *Phys. Rev. Lett.* **93**, 170504 (2004).
- [S38] Grosshans, F. & Grangier, P. Continuous Variable Quantum Cryptography Using Coherent States. *Phys. Rev. Lett.* **88**, 057902 (2002).
- [S39] Grosshans, F. *et al.* Quantum key distribution using gaussian-modulated coherent states. *Nature* **421**, 238-241 (2003).
- [S40] Pirandola, S. *et al.* High-rate measurement-device-independent quantum cryptography. *Nature Photon.* **9**, 397-402 (2015).
- [S41] Pirandola, S. *et al.* Reply to ‘Discrete and continuous variables for measurement-device-independent quantum cryptography’. *Nature Photon.* **9**, 773-775 (2015). See also <http://arxiv.org/abs/1506.06748> (2015).
- [S42] Ottaviani, C., Spedalieri, G., Braunstein, S.L. & Pirandola, S. Continuous-variable quantum cryptography with an untrusted relay: Detailed security analysis of the symmetric configuration. *Phys. Rev. A* **91**, 022320 (2015).
- [S43] Spedalieri, G. *et al.* Quantum cryptography with an ideal local relay. *Proceedings of the SPIE Security + Defence 2015 conference on Quantum Information Science and Technology*, Toulouse, France (21-24 September 2015).
- [S44] Pirandola, S., Mancini, S., Lloyd, S. & Braunstein, S. L. Continuous-variable quantum cryptography using two-way quantum communication. *Nature Phys.* **4**, 726 (2008).
- [S45] Ottaviani, C. & Pirandola S. General immunity and superadditivity of two-way Gaussian quantum cryptography. *Sci. Rep.* **6**, 22225 (2016).
- [S46] Bennett, C. H. & Brassard, G. Quantum cryptography: Public key distribution and coin tossing. *Proc. IEEE International Conf. on Computers, Systems, and Signal Processing*, Bangalore, pp. 175-179 (1984).
- [S47] Scarani, V. *et al.* The security of practical quantum key distribution. *Rev. Mod. Phys.* **81**, 1301, (2009).
- [S48] Hwang, W.-Y. Quantum Key Distribution with High Loss: Toward Global Secure Communication. *Phys. Rev. Lett.* **91**, 057901 (2003).
- [S49] Braunstein, S. L. & Pirandola, S. Side-channel-free quantum key distribution. *Phys. Rev. Lett.* **108**, 130502 (2012).
- [S50] Lo, H.-K., Curty, M. & Qi, B. Measurement-Device-Independent Quantum Key Distribution. *Phys. Rev. Lett.* **108**, 130503 (2012).