



lated, and indeed, in  $\mathbb{H}\mathbb{H}_{k[s]}$  it is easy to prove that:

$$\text{Circuit 1} = \text{Circuit 2} = \text{Circuit 3} \quad (2)$$

The standard systems theoretic semantics allows registers to hold *arbitrary* values at the beginning of a computation. This extended notion of behaviour is not merely a theoretical curiosity: it gives the class of *complete LTI discrete dynamical systems* [18], the class of behaviours that is practically the lingua franca of control theory. The interest of systems theorists is due to practical considerations: physical systems seldom evolve from zero initial conditions.

For the sake of concreteness, consider the behaviour where the left register of (1) initially holds a 1, the other a 2. Now, inputting the stream  $-1, 1, -1, 1, \dots$  results in the output  $-2, 2, -2, 2, \dots$ . This behaviour is clearly not permitted by a stateless wire, so the proof of (2) is *not sound* for reasoning about circuits with this more liberal operational semantics. In this paper, we give a sound and complete theory to do just that.

Technically, the difference from previous work [3, 5]—where streams were handled with Laurent (formal power) series—is that here we must consider *biinfinite* streams: those sequences of elements of  $k$  that are infinite in the past *as well as* in the future, that is, elements of  $k^{\mathbb{Z}}$ . Starting with the operational description, one obtains a biinfinite trajectory by executing circuits forwards and backwards in time, for some initialisation of the registers. The dynamical system defined by a circuit is the set of trajectories obtained by considering all possible initialisations.

We obtain the equations by first showing that there is a full, but not faithful, morphism from the prop  $\text{Cospan Mat } k[s, s^{-1}]$  of cospans of matrices over the ring  $k[s, s^{-1}]$  to the prop LTI of complete LTI discrete dynamical systems. We rely on [4, 19] for a presentation of  $\text{Cospan Mat } k[s, s^{-1}]$ . The result is a sound, but not complete, proof system. The last ingredient is restricting our attention from cospans to *corelations*: this gives a faithful morphism, and allows us to present the prop of corelations as a symmetric monoidal theory.

The biinfinite trajectories admitted by (1) are a textbook example of non-controllable behaviour, whereas in [1, 3, 5, 19] all definable behaviours were controllable. We show that controllability has an elegant structural characterisation in our setting. Compositionality pays off here, giving a new technique for reasoning about control of compound systems. From the systems theoretic point of view, the results are promising since the compositional, diagrammatic techniques we bring to the subject seem well-suited to problems such as controllability of interconnections, of primary interest for multiagent and spatially interconnected systems [12].

Summing up, the original technical contributions of the paper are:

- a characterisation of the class of LTI systems as the category of corelations of matrices
- a presentation of categories of corelations of matrices as symmetric monoidal theories
- an operational semantics for the underlying syntax, which agrees with the standard systems theoretic semantics of signal flow graph
- a characterisation of controllability

Our work lies in the intersection of computer science, mathematics, and systems theory. From computer science, we use concepts of formal semantics of programming languages, with an emphasis on compositionality and a firm denotational foundation for operational definitions. From a mathematical perspective, we ob-

tain presentations of several relevant domains, and identify the rich underlying algebraic structures. For systems theory, our insight is that mere matrices are not optimised for discussing behaviour; instead it is profitable to use signal flow graphs, which treat linear subspaces rather than linear transformations as the primitive concept and are thus closer to the idea of system as a set of trajectories. At the core is the maxim—perhaps best understood by computer scientists—that the right language allows deeper insights into the underlying structure.

**Structure of the paper.** In §3 we develop a categorical account of complete LTI discrete dynamical systems, which serve as a denotational semantics for the graphical language, introduced in §4, where we also derive the equational characterisation. In §5 we discuss the operational semantics, and conclude in §6 with a structural account of controllability.

## 2. Preliminaries

We assume familiarity with basic concepts of linear algebra and category theory. A **split mono** is a morphism  $m: X \rightarrow Y$  such that there exists  $m': Y \rightarrow X$  with  $m'm = \text{id}_X$ . For the remainder of the paper  $k$  is a field: for concreteness one may take this to be the rationals  $\mathbb{Q}$ , the reals  $\mathbb{R}$  or the booleans  $\mathbb{Z}_2$ .

A **prop** is a strict symmetric monoidal category where the set of objects is the natural numbers  $\mathbb{N}$ , and monoidal product ( $\oplus$ ) on objects is addition. Homomorphism of props are identity-on-objects strict symmetric monoidal functors.

A **symmetric monoidal theory** (SMT) is a presentation of a prop: a pair  $(\Sigma, E)$  where  $\Sigma$  is a set of **generators**  $\sigma: m \rightarrow n$ , where  $m$  is the **arity** and  $n$  the **coarity**. A  $\Sigma$ -term is a obtained from  $\Sigma$ , identity  $\text{id}: 1 \rightarrow 1$  and symmetry  $\text{tw}: 2 \rightarrow 2$  by composition and monoidal product, according to the grammar

$$\tau ::= \sigma \mid \text{id} \mid \text{tw} \mid \tau ; \tau \mid \tau \oplus \tau$$

where  $;$  and  $\oplus$  satisfy the standard typing discipline that keeps track of the domains (arities) and codomains (coarities)

$$\frac{\tau: m \rightarrow d \quad \tau': d \rightarrow n}{\tau ; \tau': m \rightarrow n} \quad \frac{\tau: m \rightarrow d \quad \tau': m' \rightarrow d'}{\tau \oplus \tau': m + m' \rightarrow n + n'}$$

The second component  $E$  of an SMT is a set of **equations**, where an equation is a pair  $(\tau, \mu)$  of  $\Sigma$ -terms with compatible types, i.e.  $\tau, \mu: m \rightarrow n$  for some  $m, n \in \mathbb{N}$ .

Given an SMT  $(\Sigma, E)$ , the prop  $\mathbf{S}_{(\Sigma, E)}$  has as arrows the  $\Sigma$ -terms quotiented by the smallest congruence that includes the laws of symmetric monoidal categories and the equations  $E$ . We will sometimes abuse notation by referring to  $\mathbf{S}_{(\Sigma, E)}$  as an SMT. Given an arbitrary prop  $\mathbb{X}$ , a **presentation** of  $\mathbb{X}$  is an SMT  $(\Sigma, E)$  such that  $\mathbb{X} \cong \mathbf{S}_{(\Sigma, E)}$ .

String diagrams play an important role in this paper. Given a set of generators  $\Sigma$ , we consider string diagrams to be arrows of  $\mathbf{S}_{(\Sigma, \emptyset)}$ , that is, syntactic objects constructed by composition from the generators and quotiented by the laws of symmetric monoidal categories. For example, consider generators  $2 \rightarrow 1$  and  $0 \rightarrow 1$ , which we will draw as follows, with ‘dangling wires’ on either side accounting for the arity and coarity:

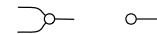

Armed with the graphical notation, we can present sets of equations as equations between diagrams. For example, the SMT of commutative monoids consists of the generators above together with equations

that respectively account for commutativity, associativity, and the unit law.

### 3. Linear time-invariant dynamical systems

This section focusses on the mathematical domains of interest for the remainder of the paper. We rely on fundamental definitions of the *behavioural approach* in control, which is informed by compositional considerations [16]. The concepts are standard in systems theory, but our categorical insights are, to the best of our knowledge, original.

Following Willems [18], a **dynamical system**  $(T, W, \mathcal{B})$  is: a **time axis**  $T$ , a **signal space**  $W$ , and a **behaviour**  $\mathcal{B} \subseteq W^T$ . We refer to  $w \in \mathcal{B}$  as **trajectories**. We consider discrete trajectories that are **biinfinite**: infinite in past and future. Our time axis is thus the integers  $\mathbb{Z}$ . The signal space is  $k^n$ , where  $n$  is the number of **terminals** of a system. These, in engineering terms, are the interconnection variables that enable interaction with an environment.

The dynamical systems of concern to us are thus specified by some natural number  $n$  and a subset  $\mathcal{B}$  of  $(k^n)^\mathbb{Z}$ . The sets  $(k^n)^\mathbb{Z}$  are  $k$ -vector spaces, with pointwise addition and scalar multiplication; we restrict attention to *linear* systems, meaning that  $\mathcal{B}$  is a  $k$ -linear subspace—i.e. closed under pointwise addition and multiplication by  $k$ -scalars—of  $(k^n)^\mathbb{Z}$ .

We partition terminals into a *domain* and *codomain*. This may seem artificial, in the sense that the assignment is arbitrary. In particular, it is crucial not to confuse the domains (codomains) with inputs (outputs). In spite of the apparent contrivedness of choosing such a partition, Willems and others have argued that it is vital for a sound theory of system *decomposition*; indeed, it enables the “tearing” of Willems’ tearing, zooming and linking modelling methodology [16].

Once the domains and codomains have been chosen, systems are linked by connecting terminals. In models of physical systems this means variable coupling or sharing [16]; in our discrete setting where behaviours are subsets of a cartesian product—i.e. relations—it amounts to relational composition. Since behaviours are both relations and linear subspaces, a central underlying mathematical notion—as in previous work [1, 3]—is a linear relation.

**Definition 3.1.** *The monoidal category  $\text{LinRel}_k$  of  $k$ -linear relations has  $k$ -vector spaces as objects, and as arrows from  $V$  to  $W$ , linear subspaces of  $V \oplus W$ , considered as  $k$ -vector spaces. Composition is relational: given  $A: U \rightarrow V$ ,  $B: V \rightarrow W$ ,  $A; B: U \rightarrow W$  is the relation*

$$\{(u, w) \mid \exists v \in V \text{ s.t. } (u, v) \in A \text{ and } (v, w) \in B\}$$

that is easily checked to be linear. Finally, the monoidal product on both objects and morphisms is direct sum.

A behaviour is **time-invariant** when for every trajectory  $w \in \mathcal{B}$  and fixed  $i \in \mathbb{Z}$ , the trajectory  $w'$  whose value at time  $t \in \mathbb{Z}$  is

$$w'(t) \stackrel{\text{def}}{=} w(t+i)$$

is also in  $\mathcal{B}$ . Time-invariance brings with it a connection with the algebra of polynomials. Following the standard approach in control theory, going back to Rosenbrock [13], we work with polynomials over an indeterminate  $s$  as well as its formal inverse  $s^{-1}$ —i.e. the elements of the ring  $k[s, s^{-1}]$ . The introduction of the formal inverse  $s^{-1}$  is a departure from previous work [3, 5] that dealt with Laurent streams (finite in the past, infinite in the future); this is necessary as it does not make sense to define the action of a polynomial fraction on a biinfinite stream.

The indeterminate  $s$  acts on a given biinfinite stream  $w \in k^\mathbb{Z}$  as a one-step delay, and  $s^{-1}$  as its inverse, a one step acceleration:

$$(s \cdot w)(t) \stackrel{\text{def}}{=} w(t-1), \quad (s^{-1} \cdot w)(t) \stackrel{\text{def}}{=} w(t+1).$$

We can extend this, in the obvious linear, pointwise manner, to an action of any polynomial  $p \in k[s, s^{-1}]$  on  $w$ . Since  $k^\mathbb{Z}$  is a  $k$ -vector space, any such  $p$  defines a  $k$ -linear map  $k^\mathbb{Z} \rightarrow k^\mathbb{Z}$ , where  $w \mapsto p \cdot w$ .

Given this, we can view  $n \times m$  matrices over  $k[s, s^{-1}]$  as  $k$ -linear maps from  $(k^m)^\mathbb{Z}$  to  $(k^n)^\mathbb{Z}$ . This can be explained succinctly as a functor from the prop  $\text{Mat } k[s, s^{-1}]$ , defined below, to the category of  $k$ -vector spaces and linear transformations  $\text{Vect}_k$ .

**Definition 3.2.** *The prop  $\text{Mat } k[s, s^{-1}]$  has as arrows  $m \rightarrow n$  the  $n \times m$ -matrices over  $k[s, s^{-1}]$ . Composition is matrix multiplication, and the monoidal product of  $A$  and  $B$  is  $\begin{bmatrix} A & 0 \\ 0 & B \end{bmatrix}$ . The symmetries are permutation matrices.*

The functor of interest

$$\theta: \text{Mat } k[s, s^{-1}] \longrightarrow \text{Vect}_k$$

takes a natural number  $n$  to the vector space  $(k^n)^\mathbb{Z}$ , and an  $n \times m$  matrix to the induced linear transformation  $(k^m)^\mathbb{Z} \rightarrow (k^n)^\mathbb{Z}$ . Note that  $\theta$  is faithful.

The final restriction on the set of behaviours is called *completeness*, and is a touch more involved. For  $t_0, t_1 \in \mathbb{Z}$ ,  $t_0 \leq t_1$ , write  $w|_{[t_0, t_1]}$  for the restriction of  $w: \mathbb{Z} \rightarrow k^n$  to the set  $[t_0, t_1] = \{t_0, t_0+1, \dots, t_1\}$ . Write  $\mathcal{B}|_{[t_0, t_1]}$  for the set of the restrictions of all trajectories  $w \in \mathcal{B}$  to  $[t_0, t_1]$ . Then  $\mathcal{B}$  is **complete** when  $w|_{[t_0, t_1]} \in \mathcal{B}|_{[t_0, t_1]}$  for all  $t_0, t_1 \in \mathbb{Z}$  implies  $w \in \mathcal{B}$ .

**Definition 3.3.** *A linear time-invariant (LTI) behaviour comprises a domain  $(k^m)^\mathbb{Z}$ , a codomain  $(k^n)^\mathbb{Z}$ , and a subset  $\mathcal{B} \subseteq (k^m)^\mathbb{Z} \oplus (k^n)^\mathbb{Z}$  such that  $(\mathbb{Z}, k^m \oplus k^n, \mathcal{B})$  is a complete, linear, time-invariant dynamical system.*

The algebra of LTI behaviours is captured concisely as a prop.

**Proposition 3.4.** *There exists a prop LTI with morphisms  $m \rightarrow n$  the LTI behaviours with domain  $(k^m)^\mathbb{Z}$  and codomain  $(k^n)^\mathbb{Z}$ . Composition is relational. The monoidal product is direct sum.*

The proof of Proposition 3.4 relies on *kernel representations* of LTI systems. The following result lets us pass between behaviours and polynomial matrix algebra.

**Theorem 3.5** (Willems [18, Th. 5]). *Let  $\mathcal{B}$  be a subset of  $(k^n)^\mathbb{Z}$  for some  $n \in \mathbb{N}$ . Then  $\mathcal{B}$  is an LTI behaviour iff there exists  $M \in \text{Mat } k[s, s^{-1}]$  such that  $\mathcal{B} = \ker(\theta M)$ .*

The prop  $\text{Mat } k[s, s^{-1}]$  is equivalent to the category  $\text{FMod } k[s, s^{-1}]$  of finite-dimensional free  $k[s, s^{-1}]$ -modules. Since  $\text{FMod } R$  over a principal ideal domain (PID)  $R$  has finite colimits [4], and  $k[s, s^{-1}]$  is a PID,  $\text{Mat } k[s, s^{-1}]$  has finite colimits, and pushouts in particular.

We can thus define the prop  $\text{Cospan Mat } k[s, s^{-1}]$  where arrows are equivalence classes of cospans of matrices. Up to isomorphism, this means we may consider arrows  $m \rightarrow n$  in this prop to comprise a natural number  $d$  together with a  $d \times m$  matrix  $A$  and a  $d \times n$  matrix  $B$ ; we write this  $m \xrightarrow{A} d \xleftarrow{B} n$ . Composition is given by pushout; see Appendix A for further details.

We can then extend  $\theta$  to the functor

$$\Theta: \text{Cospan Mat } k[s, s^{-1}] \longrightarrow \text{LinRel}_k$$

where on objects  $\Theta(n) = \theta(n) = (k^n)^\mathbb{Z}$ , and on arrows

$$m \xrightarrow{A} d \xleftarrow{B} n$$

maps to

$$\{(\mathbf{x}, \mathbf{y}) \mid (\theta A)\mathbf{x} = (\theta B)\mathbf{y}\} \subseteq (\mathbb{k}^m)^{\mathbb{Z}} \oplus (\mathbb{k}^n)^{\mathbb{Z}}. \quad (3)$$

It is straightforward to prove that this is well-defined.

**Proposition 3.6.**  $\Theta$  is a functor.

*Proof.* Identities are clearly preserved; it suffices to show that composition is too. Consider the diagram below, where the pushout is in  $\text{Mat } \mathbb{k}[s, s^{-1}]$ .

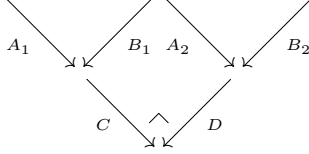

To show that  $\Theta$  preserves composition we must verify that

$$\{(\mathbf{x}, \mathbf{y}) \mid \theta C A_1 \mathbf{x} = \theta D B_2 \mathbf{y}\} = \{(\mathbf{x}, \mathbf{z}) \mid \theta A_1 \mathbf{x} = \theta B_1 \mathbf{z}\}; \{(\mathbf{z}, \mathbf{y}) \mid \theta A_2 \mathbf{z} = \theta B_2 \mathbf{y}\}.$$

The inclusion  $\subseteq$  follows from properties of pushouts in  $\text{Mat } \mathbb{k}[s, s^{-1}]$  (see [4, Prop. 5.7]). To see  $\supseteq$ , we need to show that if there exists  $\mathbf{z}$  such that  $\theta A_1 \mathbf{x} = \theta B_1 \mathbf{z}$  and  $\theta A_2 \mathbf{z} = \theta B_2 \mathbf{y}$ , then  $\theta C A_1 \mathbf{x} = \theta D B_2 \mathbf{y}$ . But  $\theta C A_1 \mathbf{x} = \theta C B_1 \mathbf{z} = \theta D A_2 \mathbf{z} = \theta D B_2 \mathbf{y}$ .  $\square$

Rephrasing the definition of  $\Theta$  on morphisms (3), the behaviour consists of those  $(\mathbf{x}, \mathbf{y})$  that satisfy

$$\theta \begin{bmatrix} A & -B \end{bmatrix} \begin{bmatrix} \mathbf{x} \\ \mathbf{y} \end{bmatrix} = \mathbf{0},$$

so one may say—ignoring for a moment the terminal domain/codomain assignment—that

$$\Theta(\overset{A}{\longleftarrow} \longleftarrow \overset{B}{\longleftarrow}) = \ker \theta \begin{bmatrix} A & -B \end{bmatrix}.$$

With this observation, as a consequence of Theorem 3.5,  $\Theta$  has as its image (essentially) the prop LTI. This proves Proposition 3.4. We denote the corestriction of  $\Theta$  by  $\bar{\Theta}$ . We thus have a full functor:

$$\bar{\Theta}: \text{Cospan Mat } \mathbb{k}[s, s^{-1}] \longrightarrow \text{LTI}.$$

**Remark 3.7.** It is important for the sequel to note that  $\bar{\Theta}$  is not faithful. For instance,  $\bar{\Theta}(\overset{[1]}{\longleftarrow} \longleftarrow \overset{[1]}{\longleftarrow}) = \bar{\Theta}(\overset{[1]}{[0]} \longleftarrow \overset{[1]}{[0]})$ , yet the cospans are not equivalent.

## 4. Presentation of LTI

In this section we give a presentation of LTI as an SMT. This means both that (i) we obtain a syntax—conveniently expressed using string diagrams—for specifying every LTI behaviour, and (ii) a sound and fully complete equational theory for reasoning about them.

### 4.1 Syntax

We start by describing the graphical syntax of dynamical systems, the arrows of the category  $\mathbb{S} = \mathbf{S}_{(\Sigma, \emptyset)}$ , where  $\Sigma$  is the set of generators:

$$\begin{aligned} & \{ \text{⌞} \text{---} \circ \text{---} \text{⌠}, \text{---} \circ \text{---}, \text{---} \bullet \text{---} \text{⌞}, \text{---} \bullet \text{---}, \text{---} \text{Ⓢ} \text{---}, \\ & \text{---} \text{⌞} \text{---}, \text{---} \circ \text{---}, \text{⌞} \text{---} \bullet \text{---}, \text{---} \bullet \text{---}, \text{---} \text{Ⓢ} \text{---} \} \\ & \cup \{ \text{---} \text{Ⓢ} \text{---} \mid a \in \mathbb{k} \} \cup \{ \text{---} \text{Ⓢ} \text{---} \mid a \in \mathbb{k} \} \quad (4) \end{aligned}$$

For each generator, we give its **denotational semantics**, an LTI behaviour, thereby defining a prop morphism  $\llbracket - \rrbracket : \mathbb{S} \rightarrow \text{LTI}$ .

$$\text{⌞} \text{---} \circ \text{---} \text{⌠} \mapsto \{((\tau/v), \tau + v) \mid \tau, v \in \mathbb{k}^{\mathbb{Z}}\}: 2 \rightarrow 1$$

$$\text{---} \circ \text{---} \mapsto \{((\tau), 0)\} \subseteq \mathbb{k}^{\mathbb{Z}}: 0 \rightarrow 1$$

$$\text{---} \bullet \text{---} \text{⌞} \mapsto \{(\tau, (\tau)) \mid \tau \in \mathbb{k}^{\mathbb{Z}}\}: 1 \rightarrow 2$$

$$\text{---} \bullet \text{---} \mapsto \{(\tau, ()) \mid \tau \in \mathbb{k}^{\mathbb{Z}}\}: 1 \rightarrow 0$$

$$\text{---} \text{Ⓢ} \text{---} \mapsto \{(\tau, a \cdot \tau) \mid \tau \in \mathbb{k}^{\mathbb{Z}}\}: 1 \rightarrow 1 \quad (a \in \mathbb{k})$$

$$\text{---} \text{Ⓢ} \text{---} \mapsto \{(\tau, s \cdot \tau) \mid \tau \in \mathbb{k}^{\mathbb{Z}}\}: 1 \rightarrow 1$$

The denotations of the mirror image generators are the opposite relations. Parenthetically, we note that a finite set of generators is possible if working over a finite field, or the field  $\mathbb{Q}$  of rationals, cf. §4.2.

The following result guarantees that the syntax is fit for purpose: every behaviour in LTI has a syntactic representation in  $\mathbb{S}$ .

**Proposition 4.1.**  $\llbracket - \rrbracket : \mathbb{S} \rightarrow \text{LTI}$  is full.

*Proof.* The fact that  $\llbracket - \rrbracket$  is a prop morphism is immediate since  $\mathbb{S}$  is free on the SMT  $(\Sigma, \emptyset)$  and there are no equations. Fullness is a consequence of the fact that  $\llbracket - \rrbracket$  factors as the composite of two full functors as follows:

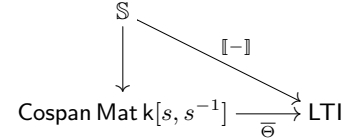

The functor  $\bar{\Theta}$  is full by definition. The existence and fullness of the functor  $\mathbb{S} \rightarrow \text{Cospan } \mathbb{k}[s, s^{-1}]$  follows from [19, Th. 3.41]. We give details in the next two subsections.  $\square$

Having defined the syntactic prop  $\mathbb{S}$  to represent arrows in LTI, our task for this section is to identify an equational theory that *characterises* LTI: i.e. one that is sound and fully complete. The first step is to use the existence of  $\Theta$ : with the results of [4, 19] we can obtain a presentation for  $\text{Cospan } \mathbb{k}[s, s^{-1}]$ . This is explained in the next two subsections: in §4.2 we present  $\text{Mat } \mathbb{k}[s, s^{-1}]$  and in §4.3, the equations for cospans of matrices.

### 4.2 Presentation of $\text{Mat } \mathbb{k}[s, s^{-1}]$

To obtain a presentation of  $\text{Mat } \mathbb{k}[s, s^{-1}]$  as an SMT we only require some of the generators:

$$\begin{aligned} & \{ \text{⌞} \text{---} \circ \text{---} \text{⌠}, \text{---} \circ \text{---}, \text{---} \bullet \text{---} \text{⌞}, \text{---} \bullet \text{---}, \text{---} \text{Ⓢ} \text{---}, \text{---} \text{Ⓢ} \text{---} \} \\ & \cup \{ \text{---} \text{Ⓢ} \text{---} \mid a \in \mathbb{k} \} \end{aligned}$$

and the following equations. First, the white and the black structure forms a (bicommutative) bimonoid:

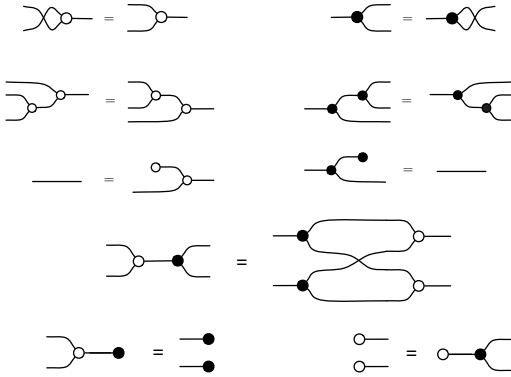

Next, the formal indeterminate  $s$  is compatible with the bimonoid structure and has its mirror image as a formal inverse.

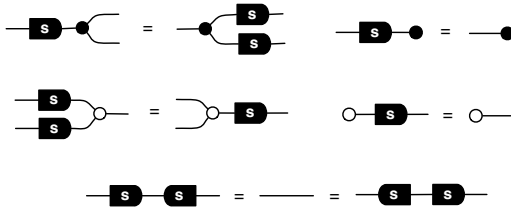

Finally, we insist that the algebra of  $k$  be compatible with the bimonoid structure and commute with  $s$ . The equations below, in which  $a, b \in k$ , are redundant if  $k = \mathbb{Q}$ ; instead, one needs an additional generator, the antipode, identified with the scalar  $-1$ . The details are not important; we merely mention that henceforward  $\blacksquare$  is synonymous with  $\boxed{-1}$ .

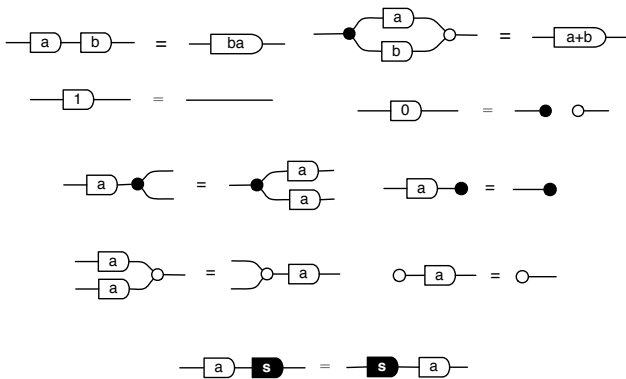

Let  $\mathbb{H}\mathbb{A}_{k[s, s^{-1}]}$  be the prop induced by the SMT consisting of the equations above. The following follows from [19, Prop. 3.9].

**Proposition 4.2.**  $\text{Mat } k[s, s^{-1}] \cong \mathbb{H}\mathbb{A}_{k[s, s^{-1}]}$ .

Arrows of  $\text{Mat } k[s, s^{-1}]$  are matrices with polynomial entries, but it may not be immediately obvious to the reader to the reader how polynomials arise with the string diagrammatic syntax. We illustrate this in the following remark.

**Remark 4.3.** Any polynomial  $p = \sum_{i=u}^v a_i s^i$ , where  $u \leq v \in \mathbb{Z}$  and with coefficients  $a_i \in k$ , can be written graphically using the building blocks of  $\mathbb{H}\mathbb{A}_{k[s, s^{-1}]}$ . Rather than giving a tedious formal

construction, we illustrate this with an example for  $k = \mathbb{R}$ . A term for  $3s^{-3} - \pi s^{-1} + s^2$  is:

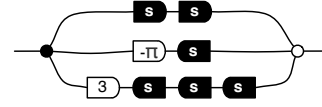

As an arrow  $1 \rightarrow 1$  in  $\text{Mat } \mathbb{R}[s, s^{-1}]$ , the above term represents a  $1 \times 1$ -matrix over  $\mathbb{R}[s, s^{-1}]$ . To demonstrate how higher-dimensional matrices can be written, we also give a term for the  $2 \times 2$ -matrix  $\begin{bmatrix} 2 & 3s \\ s^{-1} & s+1 \end{bmatrix}$ :

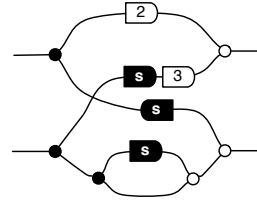

The above examples are intended to be suggestive of a normal form for terms in  $\mathbb{H}\mathbb{A}_{k[s, s^{-1}]}$ ; for further details see [19].

### 4.3 Presentation of Cospan $\text{Mat } k[s, s^{-1}]$

To obtain the equational theory of  $\text{Cospan Mat } k[s, s^{-1}]$  we need the full set of generators (4), along with the equations of  $\mathbb{H}\mathbb{A}_{k[s, s^{-1}]}$ , their mirror images, and the following

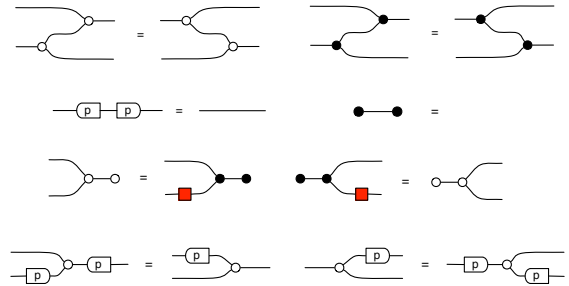

where  $p$  ranges over the nonzero elements of  $k[s, s^{-1}]$  (see Remark 4.3). The equations of  $\mathbb{H}\mathbb{A}_{k[s, s^{-1}]}$  ensure the generators of  $\mathbb{H}\mathbb{A}_{k[s, s^{-1}]}$  behave as morphisms in  $\text{Mat } k[s, s^{-1}]$ , while their mirror images ensure the remaining generators behave as morphisms in the opposite category  $\text{Mat } k[s, s^{-1}]^{\text{op}}$ . The addition equations above govern the interaction between these two sets of generators, axiomatising pushouts in  $\text{Mat } k[s, s^{-1}]$ .

Let  $\mathbb{H}\mathbb{H}^{\text{Csp}}$  denote the resulting SMT. The procedure for obtaining the equations from a distributive law of props is explained in [19, §3.3].

**Proposition 4.4** (Zanasi [19, Th. 3.41]).  $\text{Cospan Mat } k[s, s^{-1}] \cong \mathbb{H}\mathbb{H}^{\text{Csp}}$ .

Using Prop. 4.4 and the existence of  $\bar{\Theta}$ , the equational theory of  $\mathbb{H}\mathbb{H}^{\text{Csp}}$  is a sound proof system for reasoning about LTI. Due to the fact that  $\bar{\Theta}$  is not faithful (see Remark 3.7), however, the system is not complete. Achieving completeness is our task for the remainder of this section.

### 4.4 Corelations

In the category of sets, relations can be identified with jointly-mono spans of functions; that is, those spans  $X \xleftarrow{p} R \xrightarrow{q} Y$  where

the induced map  $R \xrightarrow{(p,q)} X \times Y$  is injective. Corelations are a dual concept: we consider cospans  $X \xrightarrow{i} S \xleftarrow{j} Y$  where the induced map  $X + Y \xrightarrow{[i,j]} S$  is surjective. To make sense of this more generally, one needs a category with a factorisation system. (See Appendix B for a definition.) In this subsection we identify a factorisation system in  $\text{Mat } k[s, s^{-1}]$ , and show that the induced prop  $\text{Corel } \text{Mat } k[s, s^{-1}]$  of corelations is isomorphic to LTI. We then give a presentation of  $\text{Corel } \text{Mat } k[s, s^{-1}]$  and arrive at a sound and fully complete equational theory for LTI.

**Proposition 4.5.** *Every morphism  $R \in \text{Mat } k[s, s^{-1}]$  can be factored as  $R = BA$ , where  $A$  is an epi and  $B$  is a split mono.*

*Proof.* We use the Smith normal form [10, Section 6.3]. In Appendix C.1.  $\square$

A more careful examination of Proposition 4.5 yields the following.

**Corollary 4.6.** *Let  $\mathcal{E}$  be the subcategory of epis and  $\mathcal{M}$  the subcategory of split monos. The pair  $(\mathcal{E}, \mathcal{M})$  is a factorisation system on  $\text{Mat } k[s, s^{-1}]$ , with  $\mathcal{M}$  stable under pushout.*

*Proof.* In Appendix C.2. See Appendix B for background.  $\square$

Given finite colimits and an  $(\mathcal{E}, \mathcal{M})$ -factorisation system with  $\mathcal{M}$  stable under pushouts, we may define a category of corelations. The morphisms are isomorphism classes of cospans  $X \xrightarrow{i} S \xleftarrow{j} Y$  where the copairing  $[i, j]: X + Y \rightarrow S$  is in  $\mathcal{E}$ . Composition is given by pushout, as in the category of cospans, followed by factorising the copairing of the resulting cospan. This is a dualisation of a well-known construction of relations from spans [8]; the details can be found in [7].

**Definition 4.7.** *The prop  $\text{Corel } \text{Mat } k[s, s^{-1}]$  has as morphisms equivalence classes of jointly-epic cospans in  $\text{Mat } k[s, s^{-1}]$ .*

We have a full morphism

$$F: \text{Cospan } \text{Mat } k[s, s^{-1}] \longrightarrow \text{Corel } \text{Mat } k[s, s^{-1}]$$

mapping a cospan to its jointly-epic counterpart given by the factorisation system. Then  $\bar{\Theta}$  factors through  $F$ , giving a commutative triangle:

$$\begin{array}{ccc} \text{Cospan } \text{Mat } k[s, s^{-1}] & & \\ \downarrow F & \searrow \bar{\Theta} & \\ \text{Corel } \text{Mat } k[s, s^{-1}] & \xrightarrow{\Phi} & \text{LTI} \end{array}$$

The morphism  $\Phi$  along the base of this triangle is an isomorphism of props, and this is our main technical result, Theorem 4.9. The proof relies on the following celebrated, beautiful result of systems theory.

**Proposition 4.8** (Willems [18, p.565]). *Let  $M, N$  be matrices over  $k[s, s^{-1}]$ . Then  $\ker \theta M \subseteq \ker \theta N$  iff there exists a matrix  $X$  such that  $XM = N$ .*

Further details and a brief history of the above proposition can be found in Schumacher [14, pp.7–9].

**Theorem 4.9.** *There is an isomorphism of props*

$$\Phi: \text{Corel } \text{Mat } k[s, s^{-1}] \longrightarrow \text{LTI}$$

taking a corelation  $A \rightarrow \leftarrow B$  to  $\bar{\Theta}(A \rightarrow \leftarrow B) = \ker \theta[A \text{ } - \text{ } B]$ .

*Proof.* To prove functoriality, start from the functor  $\theta: \text{Mat } k[s, s^{-1}] \rightarrow \text{Vect}_k$ . Now (i)  $\text{Vect}_k$  has an epi-mono factorisation system, (ii)  $\theta$  maps epis to epis and (iii) split monos to monos, so  $\theta$  preserves factorisations. Since it is a corollary of Prop. 3.6 that  $\theta$  preserves colimits, it follows that  $\theta$  extends to a prop functor  $\Psi: \text{Corel } \text{Mat } k[s, s^{-1}] \rightarrow \text{Corel } \text{Vect}_k$ . But  $\text{Corel } \text{Vect}_k$  is isomorphic to  $\text{LinRel}_k$  (see Appendix C.3 and [7]). By Theorem 3.5, the image of  $\Psi$  is LTI, and taking the corestriction to gives us precisely  $\Phi$ , which is therefore a full morphism of props.

As corelations  $n \rightarrow m$  are in one-to-one correspondence with epis out of  $n + m$ , to prove faithfulness it suffices to prove that if two epis  $R$  and  $S$  with the same domain have the same kernel, then there exists an invertible matrix  $U$  such that  $UR = S$ . This is immediate from Proposition 4.8: if  $\ker R = \ker S$ , then we can find  $U, V$  such that  $UR = S$  and  $VS = R$ . Since  $R$  is an epimorphism, and since  $VUR = VS = R$ , we have that  $VU = 1$  and similarly  $UV = 1$ . This proves that any two corelations with the same image are isomorphic, and so  $\Phi$  is full and faithful.  $\square$

#### 4.5 Presentation of $\text{Corel } \text{Mat } k[s, s^{-1}]$

As a consequence of Theorem 4.9, the task of obtaining a presentation of LTI is that of obtaining one for  $\text{Corel } \text{Mat } k[s, s^{-1}]$ . To do this, we start with the presentation  $\mathbb{H}\mathbb{H}^{\text{Csp}}$  for  $\text{Cospan } \text{Mat } k[s, s^{-1}]$  of §4.3; the task of this section is to identify the additional equations that equate exactly those cospans that map via  $F$  to the same corelation.

In fact, only one extra equation is required, the “white bone law”:

$$\text{O} \text{---} \text{O} = \text{O} \text{---} \text{O} \quad (5)$$

Expressed in terms of cospans, (5) asserts that  $0 \rightarrow 1 \leftarrow 0$  and  $0 \rightarrow 0 \leftarrow 0$  are identified: indeed, the two clearly yield the same corelation. Let  $\mathbb{H}\mathbb{H}^{\text{Cor}}$  be the SMT obtained from the equations of  $\mathbb{H}\mathbb{H}^{\text{Csp}}$  and equation (5).

**Theorem 4.10.**  $\text{Corel } \text{Mat } k[s, s^{-1}] \cong \mathbb{H}\mathbb{H}^{\text{Cor}}$ .

*Proof.* Since equation (5) holds in  $\text{Corel } \text{Mat } k[s, s^{-1}]$ , we have a full morphism  $\mathbb{H}\mathbb{H}^{\text{Cor}} \rightarrow \text{Corel } \text{Mat } k[s, s^{-1}]$ ; it remains to show that it is faithful. It clearly suffices to show that in the equational theory  $\mathbb{H}\mathbb{H}^{\text{Cor}}$  one can prove that every cospan is equal to its corelation. Suppose then that  $m \xrightarrow{A} k \xleftarrow{B} n$  is a cospan and  $m \xrightarrow{A'} k' \xleftarrow{B'} n$  its corelation. Then, by definition, there exists a split mono  $M: k' \rightarrow k$  such that  $MA' = A$  and  $MB' = B$ . Moreover, by the construction of the epi-split mono factorisation in

$\text{Mat } k[s, s^{-1}]$ ,  $M$  is of the form  $\begin{array}{ccc} & k' & \\ \text{O} & \text{---} & \text{O} \\ & k & \end{array} \xrightarrow{M} \begin{array}{ccc} & k & \\ \text{O} & \text{---} & \text{O} \end{array}$  where  $M': k \rightarrow k'$

is invertible. We can now give the derivation in  $\mathbb{H}\mathbb{H}^{\text{Cor}}$ :

$$\begin{array}{ccc} \begin{array}{ccc} m & \text{---} & \text{O} \\ \text{O} & \text{---} & \text{O} \\ & k & \end{array} \text{---} \begin{array}{ccc} & \text{O} & \\ \text{O} & \text{---} & \text{O} \\ & k & \end{array} \text{---} \begin{array}{ccc} & \text{O} & \\ \text{O} & \text{---} & \text{O} \\ & n & \end{array} & \stackrel{\mathbb{H}\mathbb{H}^{\text{Csp}}}{=} & \begin{array}{ccc} m & \text{---} & \text{O} \\ \text{O} & \text{---} & \text{O} \\ & k' & \end{array} \text{---} \begin{array}{ccc} & \text{O} & \\ \text{O} & \text{---} & \text{O} \\ & k & \end{array} \text{---} \begin{array}{ccc} & \text{O} & \\ \text{O} & \text{---} & \text{O} \\ & k' & \end{array} \text{---} \begin{array}{ccc} & \text{O} & \\ \text{O} & \text{---} & \text{O} \\ & n & \end{array} \\ \stackrel{\mathbb{H}\mathbb{H}^{\text{Csp}}}{=} & & \begin{array}{ccc} m & \text{---} & \text{O} \\ \text{O} & \text{---} & \text{O} \\ & k & \end{array} \text{---} \begin{array}{ccc} & \text{O} & \\ \text{O} & \text{---} & \text{O} \\ & k & \end{array} \text{---} \begin{array}{ccc} & \text{O} & \\ \text{O} & \text{---} & \text{O} \\ & n & \end{array} \\ \stackrel{(5)}{=} & & \begin{array}{ccc} m & \text{---} & \text{O} \\ \text{O} & \text{---} & \text{O} \\ & k' & \end{array} \text{---} \begin{array}{ccc} & \text{O} & \\ \text{O} & \text{---} & \text{O} \\ & n & \end{array} \end{array}$$

$\square$

We therefore have a sound and fully complete equational theory for LTI systems, and also a normal form for each LTI system: every such system can be written, in an essentially unique way, as a jointly-epic cospan of terms in  $\mathbb{H}\mathbb{A}_{k[s, s^{-1}]}$  in normal form.

**Remark 4.11.**  $\mathbb{H}^{\text{Cor}}$  (summarised in Appendix D) can also be described as having the equations of  $\mathbb{H}_{k[s, s^{-1}]}$  [4, 19], but without

$$\text{---} \text{---} \text{---} = \text{---} \text{---} \text{---}, \text{ and the related } \text{---} \text{---} \text{---} = \text{---} \text{---} \text{---}$$

and  $\text{---} \text{---} \text{---} = \text{---} \text{---} \text{---}$ . Our results generalise; given any PID  $R$  we have (informally speaking):

$$\mathbb{H}_R^{\text{Cor}} = \mathbb{H}_R - \left\{ \begin{array}{l} \text{---} \text{---} \text{---} = \text{---} \text{---} \text{---}, \\ \text{---} \text{---} \text{---} = \text{---} \text{---} \text{---}, \\ \text{---} \text{---} \text{---} = \text{---} \text{---} \text{---} \end{array} \right\}, \quad r \neq 0 \in R$$

$$\cong \text{Corel Mat } R$$

and, because of the transpose duality of matrices:

$$\mathbb{H}_R^{\text{Rel}} = \mathbb{H}_R - \left\{ \begin{array}{l} \text{---} \text{---} \text{---} = \text{---} \text{---} \text{---}, \\ \text{---} \text{---} \text{---} = \text{---} \text{---} \text{---}, \\ \text{---} \text{---} \text{---} = \text{---} \text{---} \text{---} \end{array} \right\}, \quad r \neq 0 \in R$$

$$\cong \text{Rel Mat } R.$$

The similarity between our equational presentation of  $\mathbb{H}_{k[s, s^{-1}]}^{\text{Cor}}$  and the equational presentation of  $\mathbb{H}_{k[s]}$  given in [3, 5] is remarkable, considering the differences between the intended semantics of signal flow graphs that string diagrams in those theories represent, as well as the underlying mathematics of streams, which for us are elements of the  $k$  vector space  $k^{\mathbb{Z}}$  and in [3, 5] are Laurent series. We contend that this is evidence of the *robustness* of the algebraic approach: the equational account of how the various components of signal flow graphs interact is, in a sense, a higher-level specification than the technical details of the underlying mathematical formalisation.

## 5. Operational semantics

In this section we relate the denotational account given in previous sections with an operational view.

Operational semantics is given to  $\Sigma^*$ -terms—that is, to arrows of the prop  $\mathbb{S}^* = \mathbf{S}_{(\Sigma^*, \emptyset)}$ —where  $\Sigma^*$  is obtained from set of generators in (4) by replacing the formal variables  $s$  and  $s^{-1}$  with a family of registers, indexed by the scalars of  $k$ :

$$\text{---} \text{---} \text{---} \rightsquigarrow \{ \text{---} \text{---} \text{---} \mid k \in k \}$$

$$\text{---} \text{---} \text{---} \rightsquigarrow \{ \text{---} \text{---} \text{---} \mid k \in k \}$$

The idea is that at any time during a computation the register holds the signal it has received on the previous ‘clock-tick’. There are no equations, apart from the laws of symmetric monoidal categories.

Next we introduce the structural rules: the transition relations that occur at each clock-tick, turning one  $\Sigma^*$ -term into another. Each transition is given two labels, written above and below the arrow. The upper label refers to the signals observed at the ‘dangling wires’ on the left-hand side of the term, and the lower label to those observed on the right hand side. Indeed, transitions out of a term of type  $m \rightarrow n$  have upper labels in  $k^m$  and lower labels in  $k^n$ .

Because—for the purposes of the operational account—we consider these terms to be syntactic, we must also account for the twist

$\text{---} \text{---} \text{---}$  and identity  $\text{---}$ . A summary of the structural rules is given below; the rules for the mirror image generators are symmetric, in the sense that upper and lower labels are swapped.

$$\begin{array}{ccc} \text{---} \text{---} \text{---} \xrightarrow[k]{k} \text{---} \text{---} \text{---} & \text{---} \text{---} \text{---} \xrightarrow[k]{k} \text{---} \text{---} \text{---} & \text{---} \text{---} \text{---} \xrightarrow[k]{k} \text{---} \text{---} \text{---} \\ \text{---} \text{---} \text{---} \xrightarrow[k+l]{k \ l} \text{---} \text{---} \text{---} & \text{---} \text{---} \text{---} \xrightarrow[0]{} \text{---} \text{---} \text{---} & \text{---} \text{---} \text{---} \xrightarrow[l]{l} \text{---} \text{---} \text{---} \\ \text{---} \text{---} \text{---} \xrightarrow[al]{l} \text{---} \text{---} \text{---} & \text{---} \text{---} \text{---} \xrightarrow[l]{l} \text{---} \text{---} \text{---} & \text{---} \text{---} \text{---} \xrightarrow[k]{k} \text{---} \text{---} \text{---} \\ \text{---} \text{---} \text{---} \xrightarrow[k]{k} \text{---} \text{---} \text{---} & \text{---} \text{---} \text{---} \xrightarrow[k+l]{k \ l} \text{---} \text{---} \text{---} & \text{---} \text{---} \text{---} \xrightarrow[k]{k} \text{---} \text{---} \text{---} \\ \frac{s \xrightarrow[u]{u} s' \quad t \xrightarrow[v]{v} t'}{s ; t \xrightarrow[w]{w} s' ; t'} & \frac{s \xrightarrow[u_1]{u_1} s' \quad t \xrightarrow[u_2]{u_2} t'}{s \oplus t \xrightarrow[v_1 \ v_2]{u_1 \ u_2} s' \oplus t'} & \end{array}$$

Here  $k, l, a \in k$ ,  $s, t$  are  $\Sigma^*$ -terms, and  $\mathbf{u}, \mathbf{v}, \mathbf{w}, \mathbf{u}_1, \mathbf{u}_2, \mathbf{v}_1, \mathbf{v}_2$  are vectors in  $k$  of the appropriate length. Note that the only generators that change as a result of computation are the registers; it follows this is the only source of state in any computation.

The structural rules are identical to those given in [5, §2]. Differently from [5], however, we can be more liberal with our assumptions about the *initial states* of computations. In [5] each computation starts off with all registers initialised with the  $0(\in k)$  value. For us, systems can be initialised with arbitrary elements of  $k$ .

Let  $\tau : m \rightarrow n \in \mathbb{S}$  be a  $\Sigma$ -term. Fixing an ordering of the delays  $\text{---} \text{---} \text{---}$  in  $\tau$  allows us to identify the set of delays with a finite ordinal  $[d]$ . A **register assignment** is then simply a function  $\sigma : [d] \rightarrow k$ . We may instantiate the  $\Sigma$ -term  $\tau$  with the register assignment  $\sigma$  to obtain the  $\Sigma^*$ -term  $\tau_\sigma \in \mathbb{S}^*$  of the same type: for all  $i \in [d]$  simply replace the  $i$ th delay with a register in state  $\sigma(i)$ .

A computation on  $\tau$  initialised at  $\sigma$  is an infinite sequence of register assignments and transition relations

$$\tau_\sigma \xrightarrow[\mathbf{v}_1]{\mathbf{u}_1} \tau_{\sigma_1} \xrightarrow[\mathbf{v}_2]{\mathbf{u}_2} \tau_{\sigma_2} \xrightarrow[\mathbf{v}_3]{\mathbf{u}_3} \dots$$

The **trace** of this computation is the sequence  $(\mathbf{u}_1, \mathbf{v}_1), (\mathbf{u}_2, \mathbf{v}_2), \dots$  of elements of  $k^m \oplus k^n$ .

To relate these structural rules to our denotational semantics, we introduce the notion of biinfinite trace. A biinfinite trace is a trace with an infinite past as well as future. To discuss these, we use the notion of a reverse computation: a computation using the operational rules above, but with the rules for delay having their left and right hand sides swapped, e.g.

$$\text{---} \text{---} \text{---} \xrightarrow[l]{k} \text{---} \text{---} \text{---}.$$

**Definition 5.1.** Given  $\tau : m \rightarrow n \in \mathbb{S}$ , a **biinfinite trace on  $\tau$**  is a sequence  $w \in (k^m)^{\mathbb{Z}} \oplus (k^n)^{\mathbb{Z}}$  such that there exists

- (i) a register assignment  $\sigma$ ;
- (ii) an infinite forward trace  $\phi_\sigma$  of a computation on  $\tau$  initialised at  $\sigma$ ; and,
- (iii) an infinite backward trace  $\psi_\sigma$  of a reverse computation on  $\tau$  initialised at  $\sigma$ ,

obeying

$$w(t) = \begin{cases} \phi(t) & t \geq 0; \\ \psi(-(t+1)) & t < 0. \end{cases}$$

We write  $\text{bit}(\tau)$  for the set of all biinfinite traces on  $\tau$ .

The following result gives a tight correspondence between the operational and denotational semantics, and follows via a straightforward structural induction on  $\tau$ .

**Lemma 5.2.** For any  $\tau : m \rightarrow n \in \mathbb{S}$ , we have

$$\llbracket \tau \rrbracket = \text{bit}(\tau)$$

as subsets of  $(k^m)^{\mathbb{Z}} \times (k^n)^{\mathbb{Z}}$ .

## 6. Controllability

Suppose we are given a current and a target trajectory for a system. Is it always possible, in finite time, to steer the system onto the target trajectory? If so, the system is deemed controllable, and the problem of controllability of systems is at the core of control theory. The following definition is due to Willems [17].

**Definition 6.1.** A system  $(T, W, \mathcal{B})$  (or simply the behaviour  $\mathcal{B}$ ) is **controllable** if for all  $w, w' \in \mathcal{B}$  and all times  $t_0 \in \mathbb{Z}$ , there exists  $w'' \in \mathcal{B}$  and  $t'_0 \in \mathbb{Z}$  such that  $t'_0 > t_0$  and  $w''$  obeys

$$w''(t) = \begin{cases} w(t) & t \leq t_0 \\ w'(t - t'_0) & t \geq t'_0. \end{cases}$$

As mentioned in the introduction, a novel feature of our graphical calculus is that it permits the representation of non-controllable behaviours.

**Example 6.2.** Consider the system in the introduction, represented by the signal flow graph (1). The equation

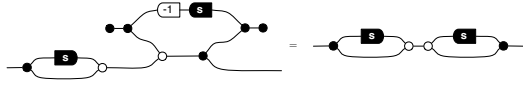

follows from the equations of LTI, and so as an LTI system (1) is the system represented by the corelation  $1 \xrightarrow{[s+1]} 1 \xleftarrow{[s+1]} 1$ .

The trajectories of this system are precisely those sequences  $w = (w_1, w_2) \in \mathbb{k}^{\mathbb{Z}} \oplus \mathbb{k}^{\mathbb{Z}}$  that satisfy  $(s+1) \cdot w_1 = (s+1) \cdot w_2$ ; that is, they satisfy the difference equation

$$w_1(t-1) + w_1(t) - w_2(t-1) - w_2(t) = 0.$$

To see that the system is non-controllable, note that this implies that every trajectory  $w$  obeys

$$w_1(t-1) - w_2(t-1) = -(w_1(t) - w_2(t)),$$

so  $(w_1 - w_2)(t) = (-1)^t c_w$  for some  $c_w \in \mathbb{k}$ . This  $c_w$  is a time-invariant property of any trajectory. Thus if  $w$  and  $w'$  are trajectories such that  $c_w \neq c_{w'}$ , then it is not possible to transition from the past of  $w$  to the future of  $w'$  along some trajectory in  $\mathcal{B}$ .

Explicitly, taking  $w(t) = ((-1)^t, 0)$  and  $w'(t) = ((-1)^t, 2)$ , it suffices to show  $\mathcal{B}$  is not controllable.

### 6.1 A categorical characterisation

We now show that controllable systems are precisely those representable as *spans* of matrices. This novel characterisation leads to new ways of reasoning about controllability of composite systems.

Among the various equivalent conditions for controllability, the existence of *image representations* is most useful for our purposes.

**Proposition 6.3** (Willems [16, p.86]). An LTI behaviour  $\mathcal{B}$  is controllable iff there exists  $M \in \text{Mat } \mathbb{k}[s, s^{-1}]$  such that  $\mathcal{B} = \text{im } \theta M$ .

Restated in our language, Prop. 6.3 states that controllable systems are precisely those representable as *spans* of matrices.

**Theorem 6.4.** Let  $m \xrightarrow{A} d \xleftarrow{B} n$  be a corelation in  $\text{Corel } \text{Mat } \mathbb{k}[s, s^{-1}]$ . Then  $\Phi(\xrightarrow{A} \xleftarrow{B})$  is controllable iff there exist matrices  $R : e \rightarrow m$ ,  $S : e \rightarrow n$  such that

$$m \xleftarrow{R} e \xrightarrow{S} n = m \xrightarrow{A} d \xleftarrow{B} n$$

as morphisms in  $\text{Corel } \text{Mat } \mathbb{k}[s, s^{-1}]$ .

*Proof.* To begin, note that the behaviour of a span is its joint image. That is,  $\Phi(\xrightarrow{R} \xrightarrow{S})$  is the composite of linear relations  $\ker \theta[\text{id}_m - R]$  and  $\ker \theta[S - \text{id}_n]$ , which comprises all  $(\mathbf{x}, \mathbf{y}) \in (\mathbb{k}^m)^{\mathbb{Z}} \oplus$

$(\mathbb{k}^n)^{\mathbb{Z}}$  such that there exists  $\mathbf{z} \in (\mathbb{k}^e)^{\mathbb{Z}}$  with  $\mathbf{x} = \theta R \mathbf{z}$  and  $\mathbf{y} = \theta S \mathbf{z}$ . Thus

$$\Phi(\xrightarrow{R} \xrightarrow{S}) = \text{im } \theta \begin{bmatrix} R \\ S \end{bmatrix}.$$

The result then follows immediately from Prop. 6.3.  $\square$

In terms of the graphical theory, this means that a term of in the canonical form  $\mathbb{H}\mathbb{A}_{\mathbb{k}[s, s^{-1}]}; \mathbb{H}\mathbb{A}_{\mathbb{k}[s, s^{-1}]}^{\text{op}}$  ('cospan form') is controllable iff we can find a derivation, using the rules of  $\mathbb{H}\mathbb{H}^{\text{Cor}}$ , that puts it in the form  $\mathbb{H}\mathbb{A}_{\mathbb{k}[s, s^{-1}]}^{\text{op}}; \mathbb{H}\mathbb{A}_{\mathbb{k}[s, s^{-1}]}$  ('span form'). This provides a general, easily recognisable representation for controllable systems.

The idea of a span representation also leads to a test for controllability: take the pullback of the cospan and check whether the system described by it coincides with the original one. Indeed, note that as  $\mathbb{k}[s, s^{-1}]$  is a PID, the category  $\text{Mat } \mathbb{k}[s, s^{-1}]$  has pullbacks. A further consequence of Th. 6.4, together with Prop. 4.8, is the following.

**Proposition 6.5.** Let  $m \xrightarrow{A} d \xleftarrow{B} n$  be a cospan in  $\text{Mat } \mathbb{k}[s, s^{-1}]$ , and write the pullback of this span  $m \xleftarrow{R} e \xrightarrow{S} n$ . Then the behaviour of the pullback span  $\Phi(\xrightarrow{R} \xrightarrow{S})$  is the maximal controllable sub-behaviour of  $\Phi(\xrightarrow{A} \xleftarrow{B})$ .

*Proof.* Suppose we have another controllable behaviour  $\mathcal{C}$  contained in  $\ker \theta[A - B]$ . Then this behaviour is the  $\Phi$ -image of some span  $m \xleftarrow{R'} e' \xrightarrow{S'} n$ . But by the universal property of the pushout, there is then a map  $b' \rightarrow b$  such that the relevant diagram commutes. This implies that the controllable behaviour  $\mathcal{C} = \text{im } \theta \begin{bmatrix} R' \\ S' \end{bmatrix}$

is contained in  $\text{im } \theta \begin{bmatrix} R \\ S \end{bmatrix}$ , as required.  $\square$

**Corollary 6.6.** Suppose that an LTI behaviour  $\mathcal{B}$  has cospan representation

$$m \xrightarrow{A} d \xleftarrow{B} n.$$

Then  $\mathcal{B}$  is controllable iff the  $\Phi$ -image of the pullback of this cospan in  $\text{Mat } \mathbb{k}[s, s^{-1}]$  is equal to  $\mathcal{B}$ .

Moreover, taking the pushout of this pullback span gives another cospan. The morphism from the pushout to the original cospan, given by the universal property of the pushout, describes the way in which the system fails to be controllable.

Graphically, the pullback may be computed by using the axioms of the theory of interacting Hopf algebras  $\mathbb{H}\mathbb{H}_{\mathbb{k}[s, s^{-1}]}$  [4, 19]. For example, the pullback span of the system of Ex. 6.2 is simply the identity span, as derived in equation (2) of the introduction. In the traditional matrix calculus for control theory, one derives this by noting the system has kernel representation  $\ker \theta \begin{bmatrix} s+1 & -(s+1) \end{bmatrix}$ , and eliminating the common factor  $s+1$  between the entries. Either way, we conclude that the maximally controllable subsystem of  $1 \xrightarrow{[s+1]} 1 \xleftarrow{[s+1]} 1$  is simply the identity system  $1 \xrightarrow{[1]} 1 \xleftarrow{[1]} 1$ .

### 6.2 Control and interconnection

From this vantage point we can make useful observations about controllable systems and their composites: we simply need to ask whether we can write them as spans. This provides a new proof of the following.

**Proposition 6.7.** Suppose that  $\mathcal{B}$  has cospan representation  $m \xrightarrow{A} d \xleftarrow{B} n$ . Then  $\mathcal{B}$  is controllable if  $A$  or  $B$  is invertible.



*Proof.* If  $A$  is invertible, then  $m \xleftarrow{A^{-1}} d \xleftarrow{B} n$  is an equivalent span; if  $B$  is invertible, then  $m \xrightarrow{A} d \xrightarrow{B^{-1}} n$ .  $\square$

More significantly, the compositionality of our framework aids understanding of how controllability behaves under the interconnection of systems—an active field of investigation in current control theory. We give an example application of our result.

First, consider the following proposition.

**Proposition 6.8.** *Let  $\mathcal{B}, \mathcal{C}$  be controllable systems, given by the respective  $\Phi$ -images of the spans  $m \xleftarrow{B_1} d \xrightarrow{B_2} n$  and  $n \xleftarrow{C_1} e \xrightarrow{C_2} l$ . Then the composite  $\mathcal{C} \circ \mathcal{B} : m \rightarrow l$  is controllable if  $\Phi(\xrightarrow{B_2} \xleftarrow{C_1})$  is controllable.*

*Proof.* Replacing  $\xrightarrow{B_2} \xleftarrow{C_1}$  with an equivalent span gives a span representation for  $\mathcal{C} \circ \mathcal{B}$ .  $\square$

**Example 6.9.** *Consider LTI systems*

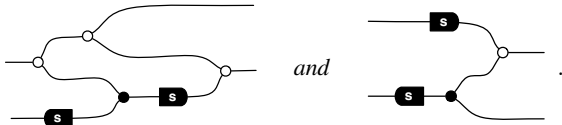

These systems are controllable because each is represented by a span in  $\text{Mat } \mathbb{k}[s, s^{-1}]$ . Indeed, recall that each generator of  $\text{LTI} = \text{Corel } \text{Mat } \mathbb{k}[s, s^{-1}]$  arises as the image of a generator in  $\text{Mat } \mathbb{k}[s, s^{-1}]$  or  $\text{Mat } \mathbb{k}[s, s^{-1}]^{\text{op}}$ ; for example, the white monoid map  $\circlearrowleft$  represents a morphism in  $\text{Mat } \mathbb{k}[s, s^{-1}]$ ,

while the black monoid map  $\circlearrowleft$  represents a morphism in  $\text{Mat } \mathbb{k}[s, s^{-1}]^{\text{op}}$ . The above diagrams are spans as we may partition the diagrams above so that each generator in  $\text{Mat } \mathbb{k}[s, s^{-1}]^{\text{op}}$  lies to the left of each generator in  $\text{Mat } \mathbb{k}[s, s^{-1}]$ .

To determine controllability of the interconnected system

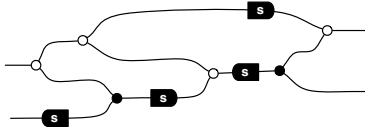

Prop. 6.8 states that it is enough to consider the controllability of the subsystem

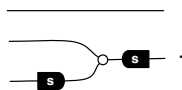

The above diagram gives a representation of the subsystem as a cospan in  $\text{Mat } \mathbb{k}[s, s^{-1}]$ . We can prove it is controllable by rewriting it as a span using an equation of LTI:

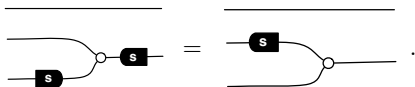

Thus the composite system is controllable.

### 6.3 Comparison to matrix methods

The facility with which the graphical calculus formalises and solves such controllability issues is especially appealing in view of potential applications in the analysis of controllability of systems over

networks (see [12]). To make the reader fully appreciate such potential, we sketch how complicated such analysis is using standard algebraic methods and dynamical system theory for the case of two single-input, single-output systems. See also pp. 513–516 of [6], where a generalization of the result of Prop. 6.8 is given in a polynomial- and operator-theoretic setting.

In the following we abuse notation by writing a matrix for its image under the functor  $\theta$ . The following is a useful result for proving the controllability of kernel representations in the single-input single-output case.

**Proposition 6.10** (Willems [16, p.75]). *Let  $\mathcal{B} \subseteq (k^2)^{\mathbb{Z}}$  be a behaviour given by the kernel of the matrix  $\begin{bmatrix} A & B \end{bmatrix}$ , where  $A$  and  $B$  are column vectors with entries in  $\mathbb{k}[s, s^{-1}]$ . Then  $\mathcal{B}$  is controllable if and only if the greatest common divisor  $\text{gcd}(A, B)$  of  $A$  and  $B$  is 1.*

Using the notation of Prop. 6.8, the trajectories of  $\mathcal{B}$  and  $\mathcal{C}$  respectively are those  $(w_1, w_2) \in (k^n)^{\mathbb{Z}} \oplus (k^m)^{\mathbb{Z}}$  and  $(w'_2, w_3) \in (k^m)^{\mathbb{Z}} \oplus (k^p)^{\mathbb{Z}}$  such that

$$\begin{bmatrix} w_1 \\ w_2 \end{bmatrix} = \begin{bmatrix} B_1 \\ B_2 \end{bmatrix} \ell_1 \quad \text{and} \quad \begin{bmatrix} w'_2 \\ w_3 \end{bmatrix} = \begin{bmatrix} C_1 \\ C_2 \end{bmatrix} \ell_2 \quad (6)$$

for some  $\ell_1 \in (k^b)^{\mathbb{Z}}$ ,  $\ell_2 \in (k^c)^{\mathbb{Z}}$ . These are the explicit image representations of the two systems. We assume without loss of generality that the representations (6) are observable (see [16]); this is equivalent to  $\text{gcd}(B_1, B_2) = \text{gcd}(C_1, C_2) = 1$ . Augmenting (6) with the interconnection constraint  $w_2 = B_2 \ell_1 = C_1 \ell_2 = w'_2$  we obtain the representation of the interconnection:

$$\begin{bmatrix} w_1 \\ w_2 \\ w'_2 \\ w_3 \\ 0 \end{bmatrix} = \begin{bmatrix} B_1 & 0 \\ B_2 & 0 \\ 0 & C_1 \\ 0 & C_2 \\ B_2 & -C_1 \end{bmatrix} \begin{bmatrix} \ell_1 \\ \ell_2 \end{bmatrix}. \quad (7)$$

Prop. 6.8 concerns the controllability of the set  $\mathcal{C} \circ \mathcal{B}$  of trajectories  $(w_1, w_3)$  for which there exist trajectories  $w_2, w'_2, \ell_1, \ell_2$  such that (7) holds.

To obtain a representation of such behavior the variables  $\ell_1, \ell_2, w_2$  and  $w'_2$  must be eliminated from (7) via algebraic manipulations (see the discussion on p. 237 of [17]). Denote  $G = \text{gcd}(B_1, C_2)$ , and write  $C_2 = GC'_2$  and  $B_1 = GB'_1$ , where  $\text{gcd}(B'_1, C'_2) = 1$ . Without entering in the algebraic details, it can be shown that a kernel representation of the projection of the behavior of (7) on the variables  $w_1$  and  $w_3$  is

$$[C'_2 B_2 \quad -B'_1 C_2] \begin{bmatrix} w_1 \\ w_3 \end{bmatrix} = 0. \quad (8)$$

We now restrict to the single-input single-output case. Recalling Prop. 6.10, the behavior represented by (8) is controllable if and only if  $\text{gcd}(C'_2 B_2, B'_1 C_1) = 1$ .

Finally then, to complete our alternate proof of the single-input single-output case of Prop. 6.8, note that  $\Theta(\xrightarrow{B_2} \xleftarrow{C_1})$  is controllable if  $\text{gcd}(B_2, C_1) = 1$ . Given the observability assumption, this implies  $\text{gcd}(C'_2 B_2, B'_1 C_1) = 1$ , and so the interconnected behaviour  $\mathcal{C} \circ \mathcal{B}$  represented by (8) is controllable.

In the multi-input, multi-output case stating explicit conditions on the controllability of the interconnection on the basis of properties of the representations of the individual systems and their interconnection is rather complicated. This makes the simplicity of Prop. 6.8 and the straightforward nature of its proof all the more appealing.

## 7. Conclusion

Willems concludes [16] with

Thinking of a dynamical system as a behavior, and of interconnection as variable sharing, gets the physics right.

In this paper we have shown that the algebra of symmetric monoidal categories gets the mathematics right.

We characterised the prop LTI of linear time invariant dynamical systems as the prop of corelations of matrices over  $k[s, s^{-1}]$  and used this fact to present it as a symmetric monoidal theory. As a result, we obtained the language of string diagrams as a syntax for LTI systems. From the point of view of formal semantics, the syntax was endowed with denotational and operational interpretations that are closely related, as well as a sound and complete system of equations for diagrammatic reasoning.

We harnessed the compositional nature of the language to provide a new characterisation of the fundamental notion of controllability, and argued that this approach is well-suited to some of the problems that are currently of interest in systems theory, for example in systems over networks, where compositionality seems to be a vital missing ingredient.

The power of compositionality will be of no surprise to researchers in concurrency theory or formal semantics of programming languages. Our theory—which, as we show in the final section, departs radically from traditional techniques—brings this insights to control theory. By establishing links between our communities, our ambition is to open up control theory to formal specification and verification.

## References

- [1] J. C. Baez, J. Erbele, Categories in control, *Theory and Applications of Categories*, vol. 30, no. 24, pp 836–881, 2015.
- [2] J. Bénabou, Introduction to bicategories I. In *Reports of the Midwest Category Seminar*, Lecture Notes in Mathematics vol. 41, pp 1–77, Springer, 1967.
- [3] F. Bonchi, P. Sobociński, F. Zanasi, A categorical semantics of signal flow graphs, *CONCUR 2014*, LNCS 8704, pp 435–450, 2014.
- [4] F. Bonchi, P. Sobociński, F. Zanasi, Interacting Hopf algebras. arXiv:1403.7048.
- [5] F. Bonchi, P. Sobociński, F. Zanasi, Full abstraction for signal flow graphs, *PoPL '15*, pp 515–526. doi:10.1145/2676726.2676993.
- [6] P.A. Fuhrmann and U. Helmke, *The Mathematics of Networks of Linear Systems*, Springer-Verlag, 2015.
- [7] B. Fong, Decorated corelations, in preparation.
- [8] R. Jayawardene and O. Wyler, Categories of relations and functional relations, *Applied Categorical Structures*, vol. 8, no. 1, pp 279–305, 2000.
- [9] A. Joyal, R. Street, The geometry of tensor calculus I, *Advances in Mathematics*, vol. 88, no. 1, pp 55–112, 1991.
- [10] T. Kailath, *Linear Systems*, Prentice-Hall, New Jersey, 1980.
- [11] U. Oberst, Multidimensional constant linear systems, *Acta Applicandae Mathematicae*, vol. 20, pp 1–175, 1990.
- [12] R. Olfati-Saber, J.A. Fax and R.M. Murray, Consensus and cooperation in networked multi-agent systems, *Proc. IEEE*, vol. 96, no. 1, pp 215–233, 2007.
- [13] H. H. Rosenbrock, *State Space and Multivariable Theory*, Wiley, New York, 1970.
- [14] J. M. Schumacher, Transformations of linear systems under external equivalence, *Linear Algebra and its Applications*, vol. 102, pp 1–33, 1988.
- [15] C. E. Shannon, The theory and design of linear differential equation machines, National Defence Research Council, 1942.
- [16] J. C. Willems, The behavioural approach to open and interconnected systems: modeling by tearing, zooming, and linking, *IEEE Control Systems Magazine*, 2007.
- [17] J. C. Willems, Models for dynamics, *Dynamics Reported, Volume 2*, eds. U. Kirchgraber and H. O. Walther, John Wiley & Sons Ltd and B. G. Teubner, 1989.
- [18] J. C. Willems, From time series to linear system—Part I. Finite dimensional linear time invariant systems, *Automatica*, vol. 22, no. 5, pp 561–580, 1986.
- [19] F. Zanasi, Interacting Hopf Algebras—the theory of linear systems, PhD Thesis, ENS Lyon, 2015.

## A. Background on cospans

Suppose  $\mathcal{C}$  is a category with pushouts. A **cospan** from  $X$  to  $Y$  in  $\mathcal{C}$  is an object  $N$  with a pair of morphisms  $X \xrightarrow{i} N \xleftarrow{o} Y$ . Given cospans  $X \xrightarrow{i_X} N \xleftarrow{o_Y} Y$ ,  $Y \xrightarrow{i_Y} M \xleftarrow{o_Z} Z$ , we may compose them by taking a pushout over  $Y$ :

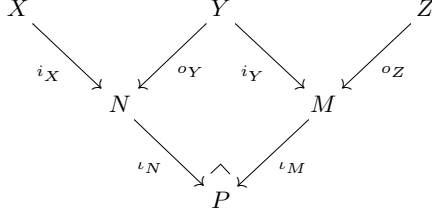

The composite is the cospan  $X \xrightarrow{i_X; i_N} P \xleftarrow{o_Z; i_M} Z$ .

Given cospans  $X \xrightarrow{i} N \xleftarrow{o} Y$ ,  $X \xrightarrow{i'} N' \xleftarrow{o'} Y$ , a **map of cospans** is a morphism  $n: N \rightarrow N'$  in  $\mathcal{C}$  such that

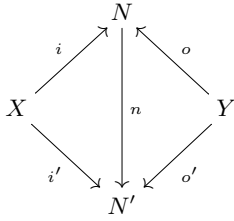

commutes. We may define a category  $\text{Cospan } \mathcal{C}$  with objects the objects of  $\mathcal{C}$  and morphisms isomorphism classes of cospans [2].

## B. Background on factorisation systems

Recall that a **factorisation system**  $(\mathcal{L}, \mathcal{R})$  in a category  $\mathcal{C}$  comprises subcategories  $\mathcal{L}, \mathcal{R}$  of  $\mathcal{C}$  such that

- (i)  $\mathcal{L}$  and  $\mathcal{R}$  contain all isomorphisms of  $\mathcal{C}$
- (ii) every morphism  $f$  of  $\mathcal{C}$  can be factored as  $f = l; r$ , where  $l \in \mathcal{L}$  and  $r \in \mathcal{R}$
- (iii) given morphisms  $f, f'$ , with factorisations  $f = l; r, f' = l'; r'$  of the above sort, for every  $u, v$  such that  $f; v = u; f'$  there exists a unique morphism  $t$  such that

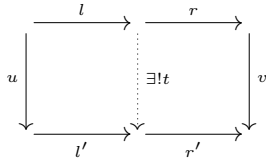

commutes.

Also recall that we say that a subcategory  $\mathcal{R}$  of  $\mathcal{C}$  is **stable under pushouts** if whenever

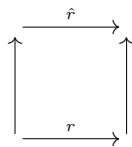

is a pushout square in  $\mathcal{C}$  such that  $r \in \mathcal{R}$ , we also have  $\hat{r} \in \mathcal{R}$ .

## C. Proofs

### C.1 Proof of Proposition 4.5

*Proof.* We use Smith normal form [10, Section 6.3]. Given any matrix  $R$ , the Smith normal form gives us  $R = VDU$ , where  $U$  and  $V$  are invertible, and  $D$  is diagonal. In graphical notation we can write it thus:

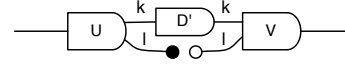

This implies we may write it as  $R = U'; D'; V'$ , where  $U'$  is a split epimorphism,  $D'$  diagonal of full rank, and  $V'$  a split monomorphism. Explicitly, the construction is given by

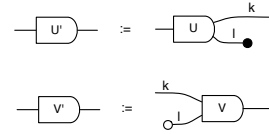

Recall that  $k[s, s^{-1}]$  is a PID, so the full rank diagonal matrix  $D'$  is epi. Then  $R = V'(D'U')$  is an epi-split mono factorisation.  $\square$

### C.2 Proof of Corollary 4.6

*Proof.* That  $(\mathcal{E}, \mathcal{M})$  is a factorisation system follows from a more general fact, true in any category, that if every arrow can be factorised as an epi followed by a split mono, then this results in a factorisation system. The only non-trivial part to check is the uniqueness condition: given epi  $e_1, e_2$ , split mono  $m_1, m_2$  and commutative diagram

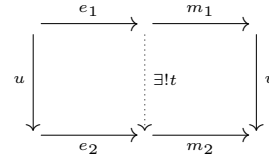

we must show that there is a unique  $t$  that makes the diagram commute. Indeed let  $t \stackrel{\text{def}}{=} m'_2 v m_1$  where  $m'_2 m_2 = id$ . To see that the right square commutes, first

$$m_2 t e_1 = m_2 m'_2 v m_1 e_1 = m_2 m'_2 m_2 e_2 u = m_2 e_2 u = v m_1 e_1$$

and since  $e_1$  is epi we have  $m_2 t = v m_1$ . For the left square,  $t e_1 = m'_2 v m_1 e_1 = m'_2 m_2 e_2 u = e_2 u$ . Uniqueness is immediate, since, e.g.  $m_2$  is mono.

To prove that  $\mathcal{M}$  is stable under pushouts, we make use of the fact that  $\text{Mat } k[s, s^{-1}]$  is equivalent to  $\text{FMod } k[s, s^{-1}]$ , and use an explicit formula for the pushout in  $\text{FMod } k[s, s^{-1}]$ . Let

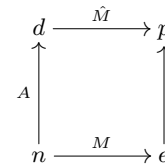

be a pushout square in  $\text{FMod } k[s, s^{-1}]$ , where  $M$  is a split mono. Write  $M': e \rightarrow n$  for the map such that  $M'M = id$ . We show that  $\hat{M}$  also splits.

First, note that the pushout  $p$  is given by  $(d \oplus e)/\text{im}[\begin{smallmatrix} A \\ -M \end{smallmatrix}]$ , with  $\hat{M}$  mapping each  $v \in e$  to the equivalence class  $\bar{v}$ ; we abuse notation to write  $v$  for both elements of  $e$  and their image in  $d \oplus e$  under the coproduct injection, and similar write  $u$  for elements of

$d$  and their images in  $d \oplus e$ . Define  $\hat{M}' : p \rightarrow e$  by  $\overline{u+v}$  maps to  $u + AM'v$ . Should this be well-defined, it is clear that  $\hat{M}'\hat{M} = \text{id}$ .

We check that  $\hat{M}'$  is well-defined. Suppose  $\overline{u' + v'} = \overline{u + v}$ ,  $u, u' \in d, v, v' \in e$ . Then  $u - u' + v - v' \in \text{im}[\begin{smallmatrix} A \\ -M \end{smallmatrix}]$ . This implies there exists  $w \in n$  such that  $u - u' = Aw, v - v' = -Mw$ . Thus

$$\begin{aligned} u + AM'v &= (u' - Aw) + AM'(v' - Mw) \\ &= u' - Aw + AM'v' + AM'Mw \\ &= u' + AM'v'. \end{aligned}$$

This shows that  $\hat{M}$  is a split mono, as required.  $\square$

### C.3 Proof that $\text{Corel Vect}_k \cong \text{LinRel}_k$

*Proof.* We show that the map

$$\text{Corel Vect}_k \longrightarrow \text{LinRel}_k$$

sending each vector space to itself and each jointly-epic cospan

$$U \xrightarrow{f} A \xleftarrow{g} V$$

to the linear subspace  $\ker[f - g]$  is a full, faithful, and bijective-on-objects functor.

Indeed, (equivalence classes of) jointly-epic cospans  $U \xrightarrow{f} A \xleftarrow{g} V$  are in one-to-one correspondence with surjective linear maps  $U \oplus V \rightarrow A$ , which are in turn, by the isomorphism theorem, in one-to-one correspondence with subspaces of  $U \oplus V$ . These correspondences are described by the kernel construction above. Thus our map is evidently full, faithful, and bijective-on-objects. It also maps identities to identities. It remains to check that it preserves composition.

Suppose we have jointly epic cospans  $U \xrightarrow{f} A \xleftarrow{g} V$  and  $V \xrightarrow{h} B \xleftarrow{k} W$ . Then their pushout is given by  $P = A \oplus B / \ker[g - h]$ , and we may draw the pushout diagram

$$\begin{array}{ccccc} U & & V & & W \\ & \searrow f & & \searrow h & \\ & A & & B & \\ & \swarrow g & & \swarrow k & \\ & & & & \\ & & & & \\ & \searrow \iota_A & & \swarrow \iota_B & \\ & & P & & \end{array}$$

We wish to show the equality of relations

$$\ker[f - g]; \ker[h - k] = \ker[\iota_A f - \iota_B g].$$

Now  $(\mathbf{u}, \mathbf{w}) \in U \oplus W$  lies in the composite relation  $\ker[f - g]; \ker[h - k]$  iff there exists  $\mathbf{v} \in V$  such that  $f\mathbf{u} = g\mathbf{v}$  and  $h\mathbf{v} = k\mathbf{w}$ . But as  $P$  is the pushout, this is true iff

$$\iota_A f\mathbf{u} = \iota_A g\mathbf{v} = \iota_B h\mathbf{v} = \iota_B k\mathbf{w}.$$

This in turn is true iff  $(\mathbf{u}, \mathbf{w}) \in \ker[\iota_A f - \iota_B k]$ , as required.  $\square$

### D. Equations of $\mathbb{I}\mathbb{H}\mathbb{H}^{\text{Cor}}$

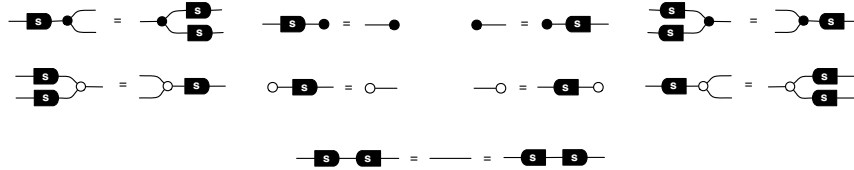
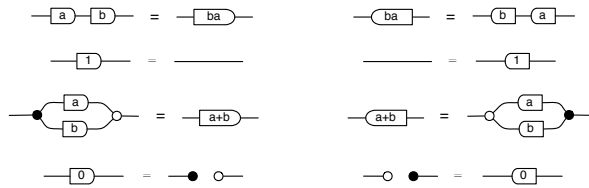
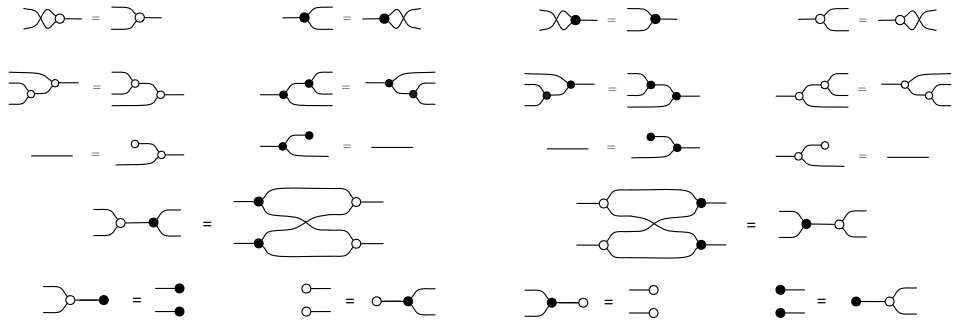

$\mathbb{I}\mathbb{H}\mathbb{H}_{k[s, s^{-1}]} + \mathbb{I}\mathbb{H}\mathbb{H}_{k[s, s^{-1}]}^{\text{OP}}$

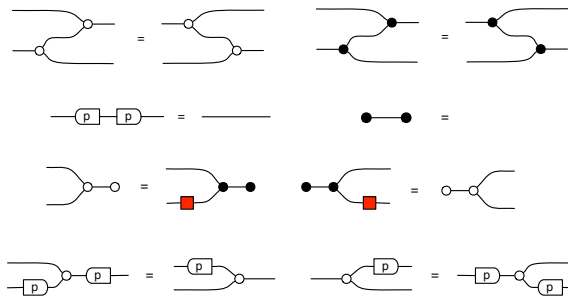

$\mathbb{I}\mathbb{H}\mathbb{H}^{\text{Csp}}$



$\mathbb{I}\mathbb{H}\mathbb{H}^{\text{Cor}}$