

# Integer Programming Models and Parameterized Algorithms for Controlling Palletizers\*

Frank Gurski<sup>†</sup>      Jochen Rethmann<sup>‡</sup>      Egon Wanke<sup>§</sup>

March 29, 2021

## Abstract

We study the combinatorial FIFO STACK-UP problem, where bins have to be stacked-up from conveyor belts onto pallets. This is done by palletizers or palletizing robots. Given  $k$  sequences of labeled bins and a positive integer  $p$ , the goal is to stack-up the bins by iteratively removing the first bin of one of the  $k$  sequences and put it onto a pallet located at one of  $p$  stack-up places. Each of these pallets has to contain bins of only one label, bins of different labels have to be placed on different pallets. After all bins of one label have been removed from the given sequences, the corresponding stack-up place becomes available for a pallet of bins of another label. All bins have the same size. The FIFO STACK-UP problem asks whether there is some processing of the sequences of bins such that at most  $p$  stack-up places are used.

In this paper we strengthen the hardness of the FIFO STACK-UP shown in [20] by considering practical cases and the distribution of the pallets onto the sequences. We introduce a digraph model for this problem, the so called decision graph, which allows us to give a breadth first search solution of running time  $\mathcal{O}(n^2 \cdot (m+2)^k)$ , where  $m$  represents the number of pallets and  $n$  denotes the total number of bins in all sequences. Further we apply methods to solve hard problems to the FIFO STACK-UP problem. Therefor we consider restricted versions of the problem, two integer programming models, exponential time algorithms, parameterized algorithms, and approximation algorithms. In order to evaluate our algorithms, we introduce a method to generate random, but realistic instances for the FIFO STACK-UP problem. Our experimental study of running times shows that the breadth first search solution on the decision graph combined with a cutting technique can be used to solve practical instances on several thousands of bins of the FIFO STACK-UP problem. Further we analyze our two integer programming approaches implemented in CPLEX and GLPK. As expected CPLEX can solve the instances much faster than GLPK and our pallet solution approach is much better than the bin solution approach.

**Keywords:** combinatorial optimization; stack-up systems; parameterized algorithms; integer programming; experimental analysis; computational complexity; directed pathwidth; discrete algorithms

---

\*Short versions of this paper appeared in Proceedings of the *International Conference on Modelling, Computation and Optimization in Information Systems and Management Sciences* (MCO 2015) [16], *International Conference on Combinatorial Optimization and Applications* (COCO 2015) [15], and *International Conference on Operations Research* (OR 2013) [14], (OR 2014) [17], (OR 2015) [18].

<sup>†</sup>University of Düsseldorf, Institute of Computer Science, Algorithmics for Hard Problems Group, 40225 Düsseldorf, Germany, [frank.gurski@hhu.de](mailto:frank.gurski@hhu.de)

<sup>‡</sup>Niederrhein University of Applied Sciences, Faculty of Electrical Engineering and Computer Science, 47805 Krefeld, Germany, [jochen.rethmann@hs-niederrhein.de](mailto:jochen.rethmann@hs-niederrhein.de)

<sup>§</sup>University of Düsseldorf, Institute of Computer Science, Algorithms and Data Structures Group, 40225 Düsseldorf, Germany, [e.wanke@hhu.de](mailto:e.wanke@hhu.de)

# 1 Introduction

This paper is about the combinatorial problem of stacking up bins from conveyor belts onto pallets. This problem originally appears in *stack-up systems* that play an important role in delivery industry and warehouses. Stack-up systems are often the back end of *order-picking systems*. A detailed description of the applied background of such systems is given in [5, 26]. Logistic experiences over 30 years lead to high flexible conveyor-based stack-up systems in delivery industry. We do not intend to modify the architecture of existing systems, but try to develop efficient algorithms to control them.

The bins that have to be stacked-up onto pallets reach the stack-up system on a main conveyor belt. At the end of the conveyor belt the bins enter the palletizing system. Here the bins are picked-up by stacker cranes or robotic arms and moved onto pallets, which are located at *stack-up places*. Often vacuum grippers are used to pick-up the bins. This picking process can be performed in different ways depending on the architecture of the palletizing system (single-line or multi-line palletizers). Full pallets are carried away by automated guided vehicles, or by another conveyor system, while new empty pallets are placed at free stack-up places.

The developers and producers of robotic palletizers distinguish between single-line and multi-line palletizing systems. Each of these systems has its advantages and disadvantages.

In *single-line palletizing systems* there is only one conveyor belt from which the bins are picked-up. Several robotic arms or stacker cranes are placed around the end of the conveyor. We model such systems by a random access storage which is automatically replenished with bins from the main conveyor, see Figure 1. The area from which the bins can be picked-up is called the storage area. The storage area is the last part of the conveyor belt where the stacker cranes or robotic arms reach the bins.

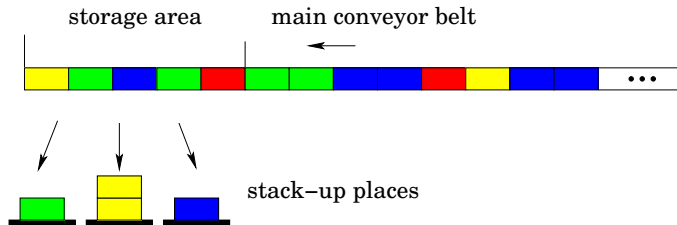

Figure 1: The single-line stack-up system using a random access storage of storage capacity 5. The colors represent the pallet labels. Bins with different colors have to be placed on different pallets, bins with the same color have to be placed on the same pallet.

In *multi-line palletizing systems* there are several buffer conveyors from which the bins are picked-up. The robotic arms or stacker cranes are placed at the end of these conveyors. Here, the bins from the main conveyor of the order-picking system first have to be distributed to the multiple infeed lines to enable parallel processing. Such a distribution can be done by some cyclic storage conveyor, see Figure 2. From the cyclic storage conveyor the bins are pushed out to the buffer conveyors. A stack-up system using a cyclic storage conveyor is, for example, located at Bertelsmann Distribution GmbH in Gütersloh, Germany. On certain days, several thousands of bins are stacked-up using a cyclic storage conveyor with a capacity of approximately 60 bins and 24 stack-up places, while up to 32 bins are destined for a pallet. This palletizing system has originally initiated our research.

If we ignore the task to distribute the bins from the main conveyor to the  $k$  buffer conveyors, i.e., if the buffer conveyors are already filled, and if each arm can only pick-up the first bin of one of the buffer conveyors, as it is the case if stacker cranes are used, then the system is called a *FIFO palletizing system*. Such systems can be modeled by several simple queues, see Figure 3.

From a theoretical point of view, an instance of the FIFO STACK-UP problem consists of  $k$  sequences  $q_1, \dots, q_k$  of bins and a number of available stack-up places  $p$ . Each bin of  $q$  is destined for exactly one pallet. The FIFO STACK-UP problem is to decide whether one can

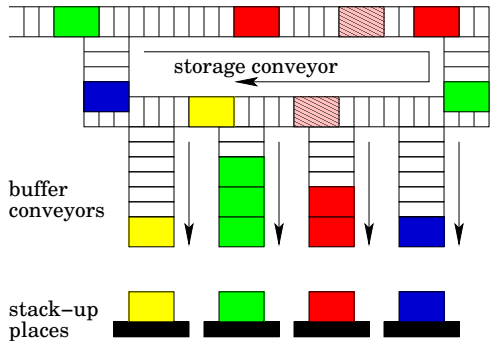

Figure 2: A multi-line stack-up system with a pre-placed cyclic storage conveyor.

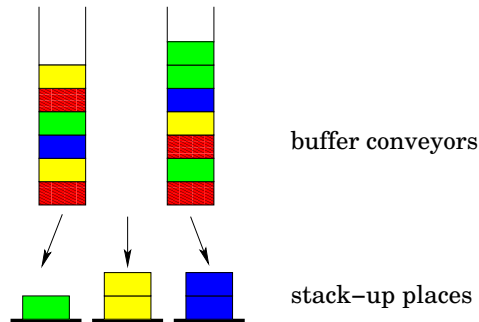

Figure 3: The FIFO stack-up system analyzed in this paper.

remove iteratively the bins from the sequences such that in each step only one of the first bins of  $q_1, \dots, q_k$  is removed and after each step at most  $p$  pallets are open. A pallet  $t$  is called *open*, if at least one bin for pallet  $t$  has already been removed from the sequences, and if at least one bin for pallet  $t$  is still contained in the remaining sequences. If a bin  $b$  is removed from a sequence then all bins located behind  $b$  are moved-up one position to the front (cf. Section 2 for the formal definition).

Every processing should absolutely avoid blocking situations. A system is *blocked*, if all stack-up places are occupied by pallets, and none of the bins that may be used in the next step are destined for an open pallet. To unblock the system, bins have to be picked-up manually and moved to pallets by human workers. Such a blocking situation is sketched in Figure 3.

The single-line stack-up problem can be defined in the same way. An instance for the single-line stack-up problem consists of one sequence  $q$  of bins, a storage capacity  $s$ , and a number of available stack-up places  $p$ . In each step one of the first  $s$  bins of  $q$  can be removed. Everything else is defined analogously.

Many facts are known about single-line stack-up systems [26, 27, 28]. In [26] it is shown that the single-line stack-up decision problem is NP-complete, but can be solved efficiently if the storage capacity  $s$  or the number of available stack-up places  $p$  is a fixed constant. The problem remains NP-complete as shown in [27], even if the sequence contains at most 9 bins per pallet. In [27], a polynomial-time off-line approximation algorithm for minimizing the storage capacity  $s$  is introduced. This algorithm yields a solution that is optimal up to a factor bounded by  $\log(p)$ . In [28] the performances of simple *on-line* stack-up algorithms are compared with optimal off-line solutions by a competitive analysis [3, 8].

The FIFO STACK-UP problem has not been studied by other authors up to now, although stack-up systems play an important role in delivery industry and warehouses. In our studies, we neither limit the number of bins for a pallet nor restrict the number of stack-up places to the number of buffer conveyors. That is, the number of stack-up places can be larger than or less than the number of buffer conveyors. We could show in [20] that the FIFO STACK-UP problem is NP-complete, but can be solved in polynomial time if the number  $k$  of sequences or the number  $p$  of stack-up places is fixed.

This paper is organized as follows. In Section 2, we give preliminaries and the problem statement. In Section 3, we recall the definition of a *sequence graph* from [20]. This digraph has a vertex for every pallet and an arc from pallet  $a$  to pallet  $b$ , if and only if in any processing pallet  $b$  can only be closed if pallet  $a$  has already been opened. We give an algorithm which allows us to compute the sequence graph in time  $\mathcal{O}(n + k \cdot m^2)$ , where  $m$  represents the number of pallets and  $n$  denotes the total number of bins in all sequences. Further we show that the hardness of the FIFO STACK-UP problem even holds for the practical case  $k < m$  and we discuss the influence of the distribution of the pallets onto the sequences.

In Section 4 we consider two further digraph models that allow us to find dynamic program-

ming solutions for the FIFO STACK-UP problem. The first digraph is the *processing graph*. It has a vertex for every possible configuration of the system and an arc from configuration  $A$  to configuration  $B$  if configuration  $B$  can be obtained from configuration  $A$  by a single processing step. The algorithmic use of the processing graph was already mentioned in [20] and will be explained more in detail here in order to ease the understanding on the second digraph model, which is called the *decision graph*. It has a vertex for every decision configuration of the system, i.e. for configurations such that for every sequence the next bin is destined for a *non-open* pallet and an arc from decision configuration  $A$  to decision configuration  $B$  if configuration  $B$  can be obtained from configuration  $A$  by a processing step including automatic steps. The decision graph allows us to give a breadth first search solution for the FIFO STACK-UP problem of running time  $\mathcal{O}(n^2 \cdot (m + 2)^k)$ .

In Section 5 we apply methods to solve hard problems to the FIFO STACK-UP problem. Therefore we consider restricted versions of the problem, exponential time algorithms, and approximation algorithms. We also give two integer programming models to solve the FIFO STACK-UP problem. The first model computes a bin solution, i.e. an order in which the bins can be removed, and the second one computes a pallet solution, i.e. an order in which the pallets can be opened. Both models are using a polynomial number of variables and a polynomial number of constraints to compute the minimum number of stack-up places. Further we study the fixed-parameter tractability of the problem. The idea behind fixed-parameter tractability is to split the complexity into two parts - one part that depends purely on the size of the input, and one part that depends on some *parameter* of the problem that tends to be small in practice. Based on our three digraph models and our two integer programming models we give parameterized algorithms for various parameters which imply efficient solutions for the FIFO STACK-UP problem restricted to small parameter values.

In Section 6 we introduce a method to generate random, but realistic instances for the FIFO STACK-UP problem. We generated instances on several thousand bins of the FIFO STACK-UP problem which could be solved by our breadth first search solution combined with some cutting technique on the decision graph in a few minutes. Further we analyze two integer programming approaches implemented in CPLEX and GLPK. As expected CPLEX can solve the instances much faster than GLPK and our pallet solution approach is much better than the bin solution approach.

## 2 Problem Statement

We consider *sequences*

$$q_1 = (b_1, \dots, b_{n_1}), \dots, q_\ell = (b_{n_{\ell-1}+1}, \dots, b_{n_\ell}), \dots, q_k = (b_{n_{k-1}+1}, \dots, b_{n_k})$$

of *bins*. All these bins are pairwise distinct. These sequences represent the buffer queues (handled by the buffer conveyors) in real stack-up systems. Each bin  $b$  is labeled with a *pallet symbol*  $plt(b)$  which can be some positive integer. We say bin  $b$  is destined for pallet  $plt(b)$ . The labels of the pallets can be chosen arbitrarily, because we only need to know whether two bins are destined for the same pallet or for different pallets. The set of all pallets of the bins in some sequence  $q_i$  is denoted by

$$plts(q_i) = \{plt(b) \mid b \in q_i\}.$$

For a list of sequences  $Q = (q_1, \dots, q_k)$  we denote

$$plts(Q) = plts(q_1) \cup \dots \cup plts(q_k).$$

For some sequence  $q = (b_1, \dots, b_n)$  we say bin  $b_i$  is *on the left of* bin  $b_j$  in sequence  $q$  if  $i < j$ . And we say that such a bin  $b_i$  is on the *position*  $i$  in sequence  $q$ , i.e. there are  $i - 1$  bins on the left of  $b$  in sequence  $q$ . The position of the first bin in some sequence  $q_i$  destined for some pallet  $t$  is denoted by  $first(q_i, t)$ , similarly the position of the last bin for pallet  $t$  in sequence  $q_i$  is denoted by  $last(q_i, t)$ . For technical reasons, if there is no bin for pallet  $t$  contained in sequence  $q_i$ , then we define  $first(q_i, t) = |q_i| + 1$ , and  $last(q_i, t) = 0$ .

Let  $Q = (q_1, \dots, q_k)$  be a list of sequences, and let  $C_Q = (i_1, \dots, i_k)$  be some tuple in  $\mathbb{N}^k$ . Such a tuple  $C_Q$  is called a *configuration*, if  $0 \leq i_j \leq |q_j|$  for each sequence  $q_j \in Q$ .<sup>1</sup> Value  $i_j$  denotes the number of bins that have been removed from sequence  $q_j$ , see Example 2.2.

A pallet  $t$  is called *open* in configuration  $C_Q = (i_1, \dots, i_k)$ , if there is a bin for pallet  $t$  at some position less than or equal to  $i_j$  in sequence  $q_j$ , i.e.  $\text{first}(q_j, t) \leq i_j$ , and if there is another bin for pallet  $t$  at some position greater than  $i_\ell$  in sequence  $q_\ell$ , i.e.  $\text{last}(q_\ell, t) > i_\ell$ , see Example 2.2. In view of the practical background we only consider sequences that contain at least two bins for each pallet. The *set of open pallets* in configuration  $C_Q$  is denoted by  $\text{open}(C_Q)$ , the number of open pallets is denoted by  $\#\text{open}(C_Q)$ .

**Remark 2.1** *Within several algorithms we will need the set of open pallets within some configuration  $C_Q$ . Therefore we first compute all the values  $\text{first}(q_i, t)$  and  $\text{last}(q_i, t)$  for  $q_i \in Q$  and  $t \in \text{plts}(Q)$  in time  $\mathcal{O}(k \cdot \max\{|q_1|, \dots, |q_k|\} + k \cdot m)$  respectively  $\mathcal{O}(n + k \cdot m)$ . Using these values we can test in time  $\mathcal{O}(k)$  whether some pallet  $t$  is open within a given configuration. By performing this test for each of the  $m$  pallets, for some configuration  $C_Q$ , we can compute  $\#\text{open}(C_Q)$  in time  $\mathcal{O}(m \cdot k)$ .*

A pallet  $t \in \text{plts}(Q)$  is called *closed* in configuration  $C_Q$ , if  $\text{last}(q_j, t) \leq i_j$  for each sequence  $q_j \in Q$ . Initially all pallets are *unprocessed*. From the time when the first bin of a pallet  $t$  has been removed from a sequence, pallet  $t$  is either open or closed.

For some configuration  $(i_1, \dots, i_k)$  we define

$$\text{front}((i_1, \dots, i_k)) = \{\text{plt}(b) \mid 1 \leq j \leq k, b \text{ is on position } i_j + 1 \text{ in sequence } q_j\}.$$

Informally speaking  $\text{front}((i_1, \dots, i_k))$  is the set of all pallets of the first bins of the remaining sequences in configuration  $(i_1, \dots, i_k)$ . (cf. Example 2.2 and Table 1).

Let  $C_Q = (i_1, \dots, i_k)$  be a configuration. The removal of the bin on position  $i_j + 1$  from sequence  $q_j$  is called a *transformation step*. A sequence of transformation steps that transforms the list  $Q$  of  $k$  sequences from the initial configuration  $(0, 0, \dots, 0)$  into the final configuration  $(|q_1|, |q_2|, \dots, |q_k|)$  is called a *processing* of  $Q$ , see Example 2.2.

It is often convenient to use pallet identifications instead of bin identifications to represent a sequence  $q$ . For  $r$  not necessarily distinct pallets  $t_1, \dots, t_r$  let  $[t_1, \dots, t_r]$  denote some sequence of  $r$  pairwise distinct bins  $(b_1, \dots, b_r)$ , such that  $\text{plt}(b_i) = t_i$  for  $i = 1, \dots, r$ . We use this notation for lists of sequences as well. Furthermore, for some positive integer value  $n$ , let  $[n] := \{1, 2, \dots, n\}$  be the set of all positive integers between 1 and  $n$ .<sup>2</sup>

**Example 2.2 (Processing)** *Consider the list  $Q = (q_1, q_2)$  of two sequences*

$$q_1 = (b_1, \dots, b_4) = [a, b, a, b]$$

and

$$q_2 = (b_5, \dots, b_{10}) = [c, d, c, d, a, b].$$

Table 1 shows a processing of  $Q$  with 2 stack-up places. The underlined bin is always the bin that will be removed in the next transformation step. The already removed bins are shown greyed out.

We consider the following problem.

**Name:** FIFO STACK-UP

**Instance:** A list  $Q = (q_1, \dots, q_k)$  of  $k$  sequences of bins, for every bin  $b$  of  $Q$  its pallet symbol  $\text{plt}(b)$ , and a positive integer  $p$ .

**Question:** Is there a processing of  $Q$ , such that in each configuration during the processing of  $Q$  at most  $p$  pallets are open?

<sup>1</sup>An alternative definition of configurations using subsequences was given in [20].

<sup>2</sup>We will use square brackets in several different notations. Although the meaning becomes clear from the context we want to emphasize this fact.

$i$	$q_1$	$q_2$	$C_Q$	$front(C_Q)$	$open(C_Q)$	bin to remove
0	$[a, b, a, b]$	$[c, d, c, d, a, b]$	(0, 0)	$\{a, c\}$	$\emptyset$	$b_5$
1	$[a, b, a, b]$	$[c, \underline{d}, c, d, a, b]$	(0, 1)	$\{a, d\}$	$\{c\}$	$b_6$
2	$[a, b, a, b]$	$[c, d, \underline{c}, d, a, b]$	(0, 2)	$\{a, c\}$	$\{c, d\}$	$b_7$
3	$[a, b, a, b]$	$[c, d, c, \underline{d}, a, b]$	(0, 3)	$\{a, d\}$	$\{d\}$	$b_8$
4	$[\underline{a}, b, a, b]$	$[c, d, c, d, a, b]$	(0, 4)	$\{a\}$	$\emptyset$	$b_1$
5	$[a, b, a, b]$	$[c, d, c, d, \underline{a}, b]$	(1, 4)	$\{a, b\}$	$\{a\}$	$b_9$
6	$[a, \underline{b}, a, b]$	$[c, d, c, d, a, b]$	(1, 5)	$\{b\}$	$\{a\}$	$b_2$
6	$[a, b, a, b]$	$[c, d, c, d, a, \underline{b}]$	(2, 5)	$\{a, b\}$	$\{a, b\}$	$b_{10}$
7	$[a, b, \underline{a}, b]$	$[c, d, c, d, a, b]$	(2, 6)	$\{a\}$	$\{a, b\}$	$b_3$
8	$[a, b, a, \underline{b}]$	$[c, d, c, d, a, b]$	(3, 6)	$\{b\}$	$\{b\}$	$b_4$
9	$[a, b, a, b]$	$[c, d, c, d, a, b]$	(4, 6)	$\emptyset$	$\emptyset$	—

Table 1: A processing of  $Q = (q_1, q_2)$  from Example 2.2 with 2 stack-up places. In this simple example it is easy to see that there is no processing of  $Q$  that needs less than 2 stack-up places, because pallets  $a$  and  $b$  as well as  $c$  and  $d$  are interlaced.

We use the following variables in the analysis of our algorithms:  $k$  denotes the number of sequences, and  $p$  stands for the number of stack-up places, while  $m$  represents the number of pallets in  $plts(Q)$ , and  $n$  denotes the total number of bins, i.e.  $n = n_k$ . Finally,  $N = \max\{|q_1|, \dots, |q_k|\}$  is the maximum sequence length.

For some instance  $I$  of the FIFO STACK-UP problem numbers are encoded binary and sequences are encoded by sequences of pallet symbols thus the size  $|I|$  can be bounded by

$$|I| \in \mathcal{O}(n \cdot \log_2(m) + \log_2(p)). \quad (1)$$

The size of the input is important for the analysis of running times in Section 5.

**Remark 2.3** *In view of the practical background, it holds  $p < m$ , otherwise each pallet could be stacked-up onto a different stack-up place. Furthermore,  $k < m$ , otherwise all bins of one pallet could be channeled into one buffer queue in the multi-line stack-up systems with pre-placed cyclic storage conveyor, see Figure 2. Finally  $m \leq \frac{n}{2} < n$ , since there are at least two bins for each pallet.*

The relation  $n \leq k \cdot N$  and the assumption  $m \leq \frac{n}{2}$  imply the following bound.

**Corollary 2.4**  $m \leq \frac{k \cdot N}{2}$ , i.e.  $m \in \mathcal{O}(k \cdot N)$ ,

The following estimation can be shown by induction on  $k$ .

**Corollary 2.5**  $k \cdot N \leq (N + 1)^k$

For the solution of the FIFO STACK-UP problem for some list of sequences  $Q$  we use the notation of a bin solution and of a pallet solution, which are defined as follows. Let  $B = (b_{\pi(1)}, \dots, b_{\pi(n)})$  be the order in which the bins are removed during a processing of  $Q$ . Then  $B$  is called a *bin solution* of  $Q$ . In Example 2.2, we have

$$B = (b_5, b_6, b_7, b_8, b_1, b_9, b_2, b_{10}, b_3, b_4) = [c, d, c, d, a, a, b, b, a, b]$$

as a bin solution.

Let  $T = (t_1, \dots, t_m)$  be the order in which the pallets are opened during the processing of  $Q$ . Then  $T$  is called a *pallet solution* of  $Q$ . In Example 2.2 we have

$$T = (c, d, a, b)$$

as a pallet solution.

### 3 NP-hardness

Next we recall the connection between the used number of stack-up places for a processing of an instance  $Q$  and the directed pathwidth of the sequence graph  $G_Q$  from [20], which is useful for our hardness results, our integer programming model for computing a pallet solution, and for several parameterized algorithms.

#### 3.1 Directed Pathwidth

According to Barát [1], the notion of directed pathwidth was introduced by Reed, Seymour, and Thomas around 1995 and relates to directed treewidth introduced by Johnson, Robertson, Seymour, and Thomas in [21]. A directed path-decomposition of a digraph  $G = (V, A)$  is a sequence  $(X_1, \dots, X_r)$  of subsets of  $V$ , called *bags*, such that the following three conditions hold true.

- (1)  $X_1 \cup \dots \cup X_r = V$ ,
- (2) for each  $(u, v) \in A$  there is a pair  $i \leq j$  such that  $u \in X_i$  and  $v \in X_j$ , and
- (3) for all  $i, j, \ell$  with  $1 \leq i < j < \ell \leq r$  it holds  $X_i \cap X_\ell \subseteq X_j$ .

The *width* of a directed path-decomposition  $\mathcal{X} = (X_1, \dots, X_r)$  is  $\max_{1 \leq i \leq r} |X_i| - 1$ . The *directed pathwidth* of  $G$ ,  $\text{d-pw}(G)$  for short, is the smallest integer  $w$  such that there is a directed path-decomposition for  $G$  of width  $w$ . For symmetric digraphs, the directed pathwidth is equivalent to the undirected pathwidth of the corresponding undirected graph [24], which implies that determining whether the pathwidth of some given digraph is at most some given value  $w$  is NP-complete. For each constant  $w$ , it is decidable in polynomial time whether a given digraph has directed pathwidth at most  $w$ , see Tamaki [29].

#### 3.2 The Sequence Graph

The sequence graph  $G_Q = (V, A)$  for an instance  $Q = (q_1, \dots, q_k)$  is defined by vertex set  $V = \text{plts}(Q)$  and the following set of arcs. There is an arc  $(u, v) \in A$  if and only if there is a sequence  $q_\ell = (b_{n_{\ell-1}+1}, \dots, b_{n_\ell})$  with two bins  $b_i, b_j$  such that  $i < j$ ,  $\text{plt}(b_i) = u$ ,  $\text{plt}(b_j) = v$ , and  $u \neq v$ .

**Example 3.1 (Sequence Graph)** Figure 4 shows the sequence graph  $G_Q$  for  $Q = (q_1, q_2, q_3)$  with sequences  $q_1 = [a, a, d, e, d]$ ,  $q_2 = [c, b, b, d]$ , and  $q_3 = [c, c, d, e, d]$ .

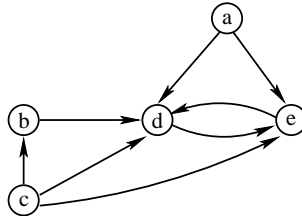

Figure 4: Sequence graph  $G_Q$  of Example 3.1.

If  $G_Q = (V, A)$  has an arc  $(u, v) \in A$  then  $u \neq v$  and for every processing of  $Q$ , pallet  $u$  is opened before pallet  $v$  is closed. Digraph  $G_Q = (V, A)$  can be computed in time  $\mathcal{O}(n + k \cdot m^2)$  by the algorithm CREATE SEQUENCE GRAPH shown in Figure 5.

A value is added to a list only if it is not already contained. To check this efficiently in time  $\mathcal{O}(1)$  we have to use a boolean array. In our algorithm  $V$  and  $L$  are implemented by boolean arrays. Therefore we need some preprocessing phase where we run through each sequence and seek for the pallets. This can be done in time  $\mathcal{O}(n + k \cdot m) \subseteq \mathcal{O}(n + m^2)$ .

In [20] we have shown the following correlation between the used number of stack-up places for a processing of an instance  $Q$  and the directed pathwidth of the sequence graph  $G_Q$ .

---

**Algorithm** CREATE SEQUENCE GRAPH
 

---

```

for each sequence  $q \in Q$  do
   $b :=$  first bin of sequence  $q$ 
  add  $plt(b)$  to vertex set  $V$ , if it is not already contained
   $L := (plt(b)) \quad \triangleright L$  contains pallets of bins up to bin  $b$ 
  for  $i := 2$  to  $|q|$  do
     $b := i$ -th bin of sequence  $q$ 
    add  $plt(b)$  to vertex set  $V$ , if it is not already contained
    if ( $i = last(q, plt(b))$ )
      for each pallet  $t \in L$  do
        if  $t \neq plt(b)$  add arc  $(t, plt(b))$  to arc set  $A$ , if it is not already contained
    if ( $i = first(q, plt(b))$ )
      append( $plt(b), L$ )
  
```

---

Figure 5: Create the sequence graph  $G = (V, A)$  for some given list of sequences  $Q$ .

**Theorem 3.2** *Let  $Q = (q_1, \dots, q_k)$  then digraph  $G_Q = (V, A)$  has directed pathwidth at most  $p-1$  if and only if  $Q$  can be processed with at most  $p$  stack-up places.*

This characterization extends the previously known areas of applications for directed pathwidth in graph databases and boolean networks, which have been shown in [6].

### 3.3 Hardness Result

Next we will discuss the hardness of the FIFO STACK-UP problem. In contrast to Section 3.2 we transform an instance of a graph problem into an instance of the FIFO STACK-UP problem.

Let  $G = (V, A)$  be some digraph and  $A = \{a_1, \dots, a_\ell\}$  its arc set. The *sequence system*  $Q_G = (q_1, \dots, q_\ell)$  for  $G$  is defined as follows.

- (1) There are  $2\ell$  bins  $b_1, \dots, b_{2\ell}$ .
- (2) Sequence  $q_i = (b_{2i-1}, b_{2i})$  for  $1 \leq i \leq \ell$ .
- (3) The pallet symbol of bin  $b_{2i-1}$  is the first vertex of arc  $a_i$  and the pallet symbol of  $b_{2i}$  is the second vertex of arc  $a_i$  for  $1 \leq i \leq \ell$ . Thus  $plts(Q_G) = V$ .

**Example 3.3 (Sequence System)** *For the digraph  $G$  of Figure 6 the corresponding sequence system is  $Q_G = (q_1, q_2, q_3, q_4, q_5, q_6, q_7)$ , where*

$$\begin{aligned}
 q_1 &= [a, b], & q_2 &= [b, c], & q_3 &= [c, d], & q_4 &= [d, e], & q_5 &= [e, a], \\
 q_6 &= [e, f], & q_7 &= [f, a].
 \end{aligned}$$

The sequence graph of  $Q_G$  is  $G$ .

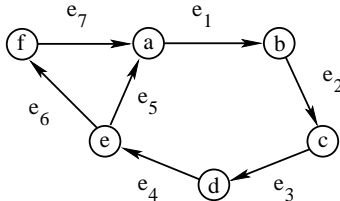

Figure 6: Digraph  $G$  of Example 3.3.

The definition of sequence system  $Q_G$  and sequence graph  $G_Q$ , defined in Section 3.2, imply the following results shown in [20].



**Proposition 3.4** ([20]) *For every digraph  $G$  it holds  $G = G_{Q_G}$ .*

**Theorem 3.5** ([20]) *The FIFO STACK-UP problem is NP-complete, even if the sequences of  $Q$  contain together at most 6 bins per pallet.*

Next we strengthen the hardness by considering further restricted versions of the FIFO STACK-UP problem. First we can bound the maximum sequence length  $N$ , since by the definition of the sequence system we obtain instances where  $N = 2$  in the proof of Theorem 3.5.

**Corollary 3.6** *The FIFO STACK-UP problem is NP-complete, even if  $N$  is bounded by some constant greater than 1. For  $N = 1$  the FIFO STACK-UP problem can obviously be solved in polynomial time.*

In order to consider the distribution of the bins of a pallet  $t$  onto the sequences we define

$$d_Q(t) = |\{q \in Q \mid t \in \text{plts}(q)\}|$$

and

$$d_Q = \max_{t \in [m]} d_Q(t).$$

By Theorem 3.5 we have shown the following result.

**Corollary 3.7** *The FIFO STACK-UP problem is NP-complete, even if  $d_Q = 6$ . For  $d_Q = 1$  the FIFO STACK-UP problem can be solved in polynomial time, since we can process all sequences one after the other.*

For  $d_Q \in \{2, \dots, 5\}$  the complexity of the FIFO STACK-UP problem remains open.

In Remark 2.3 we have restricted to practical instances where  $k < m$ . This is not given within the hardness results of [20].

**Corollary 3.8** *The FIFO STACK-UP problem is NP-complete, even if  $k < m$  and the sequences of  $Q$  contain together at most 6 bins per pallet.*

**Proof** In order to carry over the hardness to  $k < m$ , we can modify a given list of sequences  $Q = (q_1, \dots, q_k)$  as follows. We introduce  $3k$  new pallets  $a_i, b_i, c_i$  for  $1 \leq i \leq k$ . We define new sequences  $q_i$ ,  $1 \leq i \leq k$ , from the old ones by

$$q'_i = q_i \circ [a_i, a_i, b_i, b_i, c_i, c_i],$$

i.e. by concatenating  $q_i$  and  $[a_i, a_i, b_i, b_i, c_i, c_i]$ . Since list  $Q$  can be processed with at most  $p$  stack-up places, if and only if list  $Q' = (q'_1, \dots, q'_k)$  can be processed with at most  $p$  stack-up places and the number of pallets in  $Q'$  can be increased arbitrarily, the FIFO STACK-UP problem is also hard for the case  $k < m$ . □

□

## 4 Dynamic Programming Algorithms to Solve the FIFO STACK-UP Problem

Our aim in controlling FIFO stack-up systems is to compute a processing of the given sequences of bins with a minimum number of stack-up places. Such an optimal processing can always be found by computing the *processing graph* or the *decision graph*. The algorithmic use of the processing graph was already mentioned in [20] and will next be explained in more detail in order to ease the understanding in the subsequent section on the decision graph.

## 4.1 The Processing Graph

The processing graph  $G = (V, A)$  contains a vertex for every possible configuration. Each vertex  $v$  representing some configuration  $C_Q(v)$  is labeled by the number  $\#open(C_Q(v))$ . There is an arc from vertex  $u$  representing configuration  $(u_1, \dots, u_k)$  to vertex  $v$  representing configuration  $(v_1, \dots, v_k)$  if and only if  $u_i = v_i - 1$  for exactly one element of the vector and for all other elements of the vector  $u_j = v_j$ . The arc is labeled with the bin that will be removed in the corresponding transformation step.

**Example 4.1 (Processing Graph)** For the sequences of Example 2.2 we get the processing graph of Figure 7.

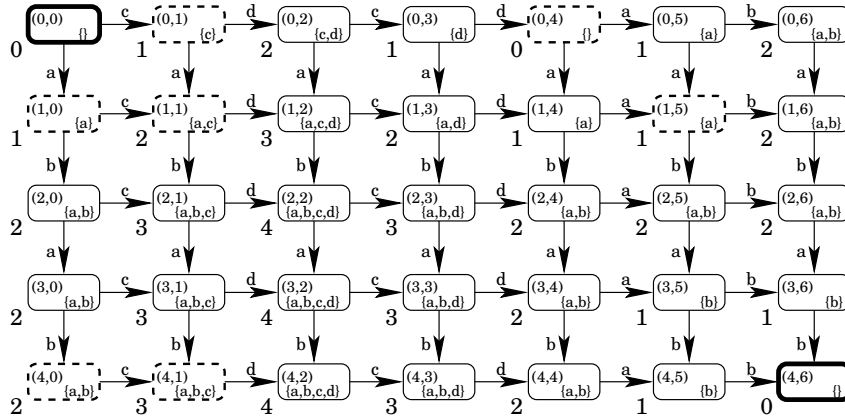

Figure 7: The processing graph of Example 2.2. Instead of the bin each arc is labeled with the pallet symbol of the bin that will be removed in the corresponding transformation step. The shaded vertices will be important in the following section. The upper left vertex represents the initial configuration and the lower right vertex represents the final configuration.

Obviously, every processing graph is directed and acyclic. Every bin solution describes a path from the initial configuration  $(0, 0, \dots, 0)$  to the final configuration  $(|q_1|, |q_2|, \dots, |q_k|)$  in the processing graph. We are interested in such paths where the maximal vertex label on that path is minimal.

The processing graph can be computed in time  $\mathcal{O}(k \cdot (N + 1)^k)$  by some breadth first search algorithm as follows. We store the already discovered configurations, i.e. the vertices of the graph, in some list  $L$ . Initially, list  $L$  contains only the initial configuration. In each step of the algorithm we take the first configuration out of list  $L$ . Let  $C_Q = (i_1, \dots, i_k)$  be such a configuration. For each  $j \in [k]$  we remove the bin on position  $i_j + 1$  from sequence  $q_j$ , and get another configuration  $C'_Q$ . We append  $C'_Q$  to list  $L$ , add it to vertex set  $V$ , if it is not already contained, and add  $(C_Q, C'_Q)$  to arc set  $A$ .

For each configuration we want to store the number of open pallets of that configuration. This can be done efficiently in the following way. First, since none of the bins has been removed from any sequence in the initial configuration, we have  $\#open((0, \dots, 0)) = 0$ . In each transformation step we remove exactly one bin for some pallet  $t$  from some sequence  $q_j$ , thus

$$\#open((i_1, \dots, i_{j-1}, i_j + 1, i_{j+1}, \dots, i_k)) = \#open((i_1, \dots, i_{j-1}, i_j, i_{j+1}, \dots, i_k)) + c_j \quad (2)$$

where  $c_j = 1$  if pallet  $t$  has been opened in the transformation step, and  $c_j = -1$  if pallet  $t$  has been closed in the transformation step. Otherwise,  $c_j$  is zero. If we put this into a formula we get

$$c_j = \begin{cases} 1, & \text{if } first(q_j, t) = i_j + 1 \text{ and } first(q_\ell, t) > i_\ell \quad \forall \ell \neq j \\ -1, & \text{if } last(q_j, t) = i_j + 1 \text{ and } last(q_\ell, t) \leq i_\ell \quad \forall \ell \neq j \\ 0, & \text{otherwise.} \end{cases}$$

Please remember our technical definition of  $first(q, t)$  and  $last(q, t)$  from page 4 for the case that  $t \notin plts(q)$ .

That means, the calculation of value  $\#open(C_Q(v))$  for the vertex  $v$  representing configuration  $C_Q(v)$  can be done in time  $\mathcal{O}(k)$  if the values  $first(q_j, t)$  and  $last(q_j, t)$  have already been calculated in some preprocessing phase. Such a preprocessing can be done in time  $\mathcal{O}(k \cdot N + k \cdot m)$  due to Remark 2.1, which can be bounded by  $\mathcal{O}(k \cdot (N+1)^k)$  due to Corollary 2.4 and Corollary 2.5. The number of vertices is in  $\mathcal{O}((N+1)^k)$ , so the vertex labels can be computed in time  $\mathcal{O}(k \cdot (N+1)^k)$ . Since at most  $k$  arcs leave each vertex, the number of arcs is in  $\mathcal{O}(k \cdot (N+1)^k)$ , and each arc can be computed in time  $\mathcal{O}(1)$ . Thus, the computing can be done in total time  $\mathcal{O}(k \cdot (N+1)^k)$ .

Let  $s$  be the vertex representing the initial configuration, and let  $topol : V \rightarrow \mathbb{N}$  be a topological ordering of the vertices of the processing graph  $G = (V, A)$  such that  $topol(u) < topol(v)$  holds for each  $(u, v) \in A$ . For some vertex  $v \in V$  and some path  $P = (v_1, \dots, v_\ell)$  with  $v_1 = s$ ,  $v_\ell = v$  and  $(v_i, v_{i+1}) \in A$  we define

$$val_P(v) := \max_{u \in P} (\#open(C_Q(u)))$$

to be the maximum vertex label on that path. Let  $\mathcal{P}(v)$  denote the set of all paths from vertex  $s$  to vertex  $v$ . Then we define

$$val(v) := \min_{P \in \mathcal{P}(v)} (val_P(v)).$$

The problem is to compute the value  $val(t)$  where  $t$  is the vertex representing the final configuration. It holds

$$val(v) = \max\{\#open(C_Q(v)), \min_{(u,v) \in A} (val(u))\}, \quad (3)$$

because each path  $P \in \mathcal{P}(v)$  must go through some vertex  $u$  with  $(u, v) \in A$ . So we may iterate over the preceding vertices of  $v$  instead of iterating over all paths. If  $\#open(C_Q(u)) < \#open(C_Q(v))$  for all preceding configurations then a pallet must have been opened in the last step to reach configuration  $C_Q(v)$ .

---

**Algorithm** FIND PATH

---

```

val[s] := 0                                ▷ Computation according to Equation (3)
for each vertex v ≠ s in order of topol do
  val[v] := ∞
  for every (u, v) ∈ A do                   ▷ Compute min_{(u,v) ∈ A} (val(u)) =: val(v)
    if (val[u] < val[v])
      val[v] := val[u]
      path[v] := u
  if (val[v] < #open[v])                    ▷ Compute max{#open(C_Q(v)), val(v)} =: val(v)
    val[v] := #open[v]

```

---

Figure 8: Finding an optimal processing by dynamic programming.

The value  $val(v_\ell)$  can be computed by Algorithm FIND PATH given in Figure 8. The corresponding path

$$P = (v_1, \dots, v_\ell) \quad (4)$$

is obtained by  $path[v_\ell] = v_{\ell-1}$ ,  $path[v_{\ell-1}] = v_{\ell-2}$ ,  $\dots$ ,  $path[v_2] = v_1$ . For the running time we observe that a topological ordering of the vertices of digraph  $G$  can be found by a depth first search algorithm in time  $\mathcal{O}(|V| + |A|)$ . The remaining work of algorithm FIND PATH can also be done in time  $\mathcal{O}(|V| + |A|)$ . In the processing graph we have  $|V| \in \mathcal{O}((N+1)^k)$ , and  $|A| \in \mathcal{O}(k \cdot (N+1)^k)$ .

It is not necessary to explicitly build the processing graph to compute an optimal processing, we have done it just for the sake of clarity and to enhance understanding. We combine the

construction of the processing graph with the topological sorting and the path finding by some breadth first search algorithm OPTIMAL BIN SOLUTION shown in Figure 9. Algorithm OPTIMAL BIN SOLUTION uses the following two operations.

- $head(L)$  yields the first entry of list  $L$  and removes it from  $L$ .
- $append(e, L)$  adds element  $e$  to the list  $L$ , if  $e$  is not already contained in  $L$ .

---

**Algorithm** OPTIMAL BIN SOLUTION

---

```

#open[ (0, ..., 0) ] := 0
val[ (0, ..., 0) ] := 0
L := ( (0, ..., 0) )
pred[ (0, ..., 0) ] := ∅
while L is not empty do
    C := head(L)
    if (pred[C] ≠ ∅)
        EXTEND PATH(C)
    for j := 1 to k do
        Cs := (i1, ..., ij + 1, ..., ik)
        if (Cs is not in L)
            compute #open[Cs] according to Equation (2)
            append(Cs, L)
        append(C, pred[Cs])

```

▷ List of uninvestigated configurations  
 ▷ List of predecessors of some configuration  
 ▷ let  $C = (i_1, \dots, i_k)$   
 ▷ all predecessors of  $C$  are computed

---

Figure 9: Construction of the processing graph and computation of an optimal bin solution at once by breadth first search.

---

**Algorithm** EXTEND PATH( $C$ )

---

```

val[C] := ∞
for each Cp in list pred[C] do
    if (val[C] > val[Cp])
        val[C] := val[Cp]
        path[C] := Cp
if (val[C] < #open[C])
    val[C] := #open[C]

```

▷ Compute  $val[C]$  due to Equation (3)

---

Figure 10: Submethod to extend a path by one vertex  $C$ .

At the end of the processing of algorithm OPTIMAL BIN SOLUTION the variable  $path$  contains a path  $P$  as shown in (4) where the maximal vertex label is minimal.

The computation of all at most  $(N + 1)^k$  values  $\#open(C_Q(v))$  can be performed in time  $\mathcal{O}(k \cdot (N + 1)^k)$ . A value is added to some list only if it is not already contained. To check this efficiently in time  $\mathcal{O}(1)$  we use a boolean array over all possible configurations. This array can be initialized in time  $\mathcal{O}((N + 1)^k)$ . Thus, we can compute the minimal number of stack-up places necessary to process the given FIFO STACK-UP problem as well as such a bin solution in time  $\mathcal{O}(k \cdot (N + 1)^k)$ .

**Theorem 4.2** *The FIFO STACK-UP problem can be solved in time  $\mathcal{O}(k \cdot (N + 1)^k)$ .*

## 4.2 The Decision Graph

During a processing of a list  $Q$  of sequences there are often configurations for which it is easy to find a bin  $b$  that can be removed such that a further processing with  $p$  stack-up places is still possible. This is the case, if bin  $b$  is destined for an already open pallet. A configuration  $(i_1, \dots, i_k)$  is called a *decision configuration*, if the bin on position  $i_j + 1$  of sequence  $q_j$  for each  $j \in [k]$  is destined for a non-open pallet, i.e.  $front((i_1, \dots, i_k)) \cap open((i_1, \dots, i_k)) = \emptyset$ . We can restrict FIFO stack-up algorithms to deal with such decision configurations, in all other configurations the algorithms automatically remove a bin for some already open pallet.

A solution to the FIFO STACK-UP problem can always be found by computing the decision graph for the given instance of the problem. The decision graph  $G = (V, A)$  has a vertex for each decision configuration into which the initial configuration can be transformed. There is an arc  $(u, v) \in A$  from a vertex  $u$  representing decision configuration  $(u_1, \dots, u_k)$  to a vertex  $v$  representing decision configuration  $(v_1, \dots, v_k)$  if and only if there is a bin  $b$  on position  $u_j + 1$  in sequence  $q_j$  such that the removal of  $b$  in the next transformation step and the execution of only automatic transformation steps afterwards lead to decision configuration  $(v_1, \dots, v_k)$ . Arc  $(u, v)$  is labeled with the pallet symbol of the bin that will be removed in the corresponding transformation step.

**Example 4.3 (Decision Graph)** In Figure 11 the decision graph for Example 2.2 is shown.

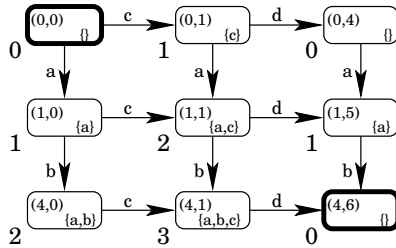

Figure 11: The decision graph of Example 2.2. It consists of the shaded vertices from the processing graph in Figure 7.

Every decision graph is directed and acyclic. Each pallet solution leads to a path from the initial configuration  $(0, 0, \dots, 0)$  to the final configuration  $(|q_1|, |q_2|, \dots, |q_k|)$  in the decision graph. We are interested in such paths where the maximal vertex label on that path is minimal.

The decision graph can be computed by some breadth first search algorithm as follows. We store the already discovered decision configurations, i.e. the vertices of the graph, in some list  $L$ . Initially, list  $L$  contains only the initial configuration. In each step of the algorithm we take the first configuration out of list  $L$ . Let  $C_Q = (i_1, \dots, i_k)$  be such a decision configuration. For each  $j \in [k]$  we remove the bin on position  $i_j + 1$  from sequence  $q_j$  and execute all automatic transformation steps. By this way we reach another decision configuration  $C'_Q = (i'_1, \dots, i'_k)$  or the final configuration, and we put this configuration into list  $L$ , we add  $C'_Q$  to vertex set  $V$ , and we add  $(C_Q, C'_Q)$  to arc set  $A$ , if it is not already contained.

We can combine the construction of the decision graph and the path finding by some breadth first search algorithm FIND OPTIMAL PALLET SOLUTION, as shown in Figure 12.

The running time of algorithm FIND OPTIMAL PALLET SOLUTION can be estimated as follows. In each sequence  $q_j$  there are bins for at most  $m$  pallets. Each pallet can be opened at most once, so in a decision configuration  $(i_1, \dots, i_k)$  it must hold  $i_j + 1 = first(q_j, t)$  for some pallet  $t$ . And since  $i_j = 0$  and  $i_j = |q_j|$  are possible as well, the decision graph has at most  $(m + 2)^k$  vertices each representing a decision configuration in list  $L$ .

We use a boolean array of size  $(m + 2)^k$  to indicate whether some decision configuration is already contained in  $L$  or not. The initialization can be performed in  $\mathcal{O}((m + 2)^k)$ . Since there are  $\mathcal{O}((m + 2)^k)$  decision configurations each having at most  $k$  predecessors we need at most

---

**Algorithm** FIND OPTIMAL PALLET SOLUTION
 

---

```

open[ (0, ..., 0) ] := ∅
#open[ (0, ..., 0) ] := 0
val[ (0, ..., 0) ] := 0
L := ( (0, ..., 0) )           ▷ List of configurations to expand
pred[ (0, ..., 0) ] := ∅      ▷ List of predecessors of some decision configuration
while L is not empty do
  C := head(L)                ▷ let C = (i1, ..., ik)
  if (pred[C] ≠ ∅)            ▷ all predecessors of C are computed
    EXTEND PATH(C)
  for j := 1 to k do
    Cs := (i1, ..., ij + 1, ..., ik)
    O := open[C] ∪ plt(bij+1)
    for ℓ := 1 to k do        ▷ perform automatic transformation steps
      while the first bin in qℓ is destined for an open pallet in O
        let Cs be the configuration obtained by removing the first bin of qℓ
      if (Cs is not in L)
        compute #open[Cs] and open[Cs] according to Remark 2.1
        append(Cs, L)
    append(C, pred[Cs])

```

---

Figure 12: Construction of the decision graph and computation of an optimal pallet solution at once by breadth first search.

$\mathcal{O}(k \cdot (m+2)^k)$  tests whether some decision configuration is already contained in  $L$ . Since each test can be done in time  $\mathcal{O}(k)$ , we can bound the running time for all tests by  $\mathcal{O}(k^2 \cdot (m+2)^k) \subseteq \mathcal{O}(n^2 \cdot (m+2)^k)$ .

The automatic transformation steps can be performed for every  $j \in [k]$  in time  $\mathcal{O}(n+k)$  and thus for all decision configurations in  $L$  in time  $\mathcal{O}((m+2)^k \cdot k \cdot (n+k))$ . The computation of  $\#open(C_s)$  for one decision configuration  $C_s$  can be done in time  $\mathcal{O}(m \cdot k)$  by Remark 2.1. Since we only compute  $\#open(C_s)$  for decision configuration  $C_s$  which is not already contained in  $L$ , for all decision configurations we need time in  $\mathcal{O}((m+2)^k \cdot m \cdot k)$ .

Thus the running time of algorithm FIND OPTIMAL PALLET SOLUTION is in  $\mathcal{O}((m+2)^k \cdot k \cdot (n+k) + (m+2)^k \cdot m \cdot k) \subseteq \mathcal{O}((m+2)^k \cdot n^2)$ .

If we have a pallet solution  $T = (t_1, \dots, t_m)$  computed by any FIFO stack-up algorithm, we can convert the pallet solution into a sequence of transformation steps, i.e. a processing of  $Q$ , in time  $\mathcal{O}(n \cdot k) \subseteq \mathcal{O}(n^2)$  by some simple algorithm: Repeatedly, in the  $i$ -th decision configuration choose the pallet  $t_i$ , remove a bin for pallet  $t_i$ , and execute all automatic transformation steps, until the next decision configuration is reached. If no bin for pallet  $t_i$  can be removed in the  $i$ -th decision configuration, or if more than  $p$  pallets are opened, reject the input. Each transformation step of these at most  $n$  steps can be done in time  $\mathcal{O}(k)$  by Equation (2).

**Theorem 4.4** *The FIFO STACK-UP problem can be solved in time  $\mathcal{O}(n^2 \cdot (m+2)^k)$ .*

Another way to describe a path from the initial configuration to the final configuration in the decision graph is as follows. Let  $s_i \in [k]$  denote the sequence from which a bin for pallet  $t_i$  will be removed in the next transformation step after reading the  $i$ -th decision configuration on a path. Then  $S = (s_1, \dots, s_m)$  is called a *sequence solution*. In Example 2.2 we have  $S = (2, 2, 1, 1)$  as a sequence solution.

There are at most  $k^m$  sequence orders  $(s_1, \dots, s_m)$ , where  $s_i \in [k]$ . The following algorithm checks in time  $\mathcal{O}(n \cdot k) \subseteq \mathcal{O}(n^2)$ , whether one sequence order describes a sequence solution: In the  $i$ -th decision configuration remove the bin from sequence  $s_i$ . Reject the input, if this is impossible.

Otherwise do all automatic transformation steps until the next decision configuration is reached. Each step can be done in time  $\mathcal{O}(k)$  by Equation (2). Reject the input, if more than  $p$  pallets are opened.

If we enumerate all  $k^m$  possible sequence orders and check each order, we can solve the FIFO STACK-UP problem.

**Theorem 4.5** *The FIFO STACK-UP problem can be solved in time  $\mathcal{O}(n^2 \cdot k^m)$ .*

## 5 Application of Methods to Solve Hard Problems to the FIFO STACK-UP Problem

Since the FIFO STACK-UP problem is NP-complete in general, it is unlikely that there exist polynomial time algorithms for the problem. This motivates us to consider restricted versions of the problem, linear programming solutions, exponential time algorithms, parameterized algorithms, and approximation algorithms.

### 5.1 Restricted Versions

We have shown that the FIFO STACK-UP problem can be solved in polynomial time for the following special cases.

- If the number  $k$  of sequences is constant then the FIFO STACK-UP problem can be solved in polynomial time  $\mathcal{O}(k \cdot (N + 1)^k)$ , see Theorem 4.2.
- If the number  $p$  of stack-up places is constant we get a polynomial running time of  $\mathcal{O}(n + m^{p+2})$  by constructing the sequence graph, see Section 5.4.1.
- If the number  $m$  of pallets is constant we get an algorithm with polynomial running time  $\mathcal{O}(n^2 \cdot m!)$ , see Section 5.4.2.
- Finally, if the number  $n$  of bins is constant, then we restrict the input size, see Equation (1) and Remark 2.3, and therefore we get a constant running time  $\mathcal{O}(1)$ .

### 5.2 Linear Programming

Next we give two linear programming approaches to solve the optimization version of the FIFO STACK-UP problem in which we have to compute a minimum number  $p$  such that a given list  $Q$  of sequences can be processed with at most  $p$  stack-up places. The first one computes a bin solution using  $\mathcal{O}(n^2)$  variables and the second one computes a pallet solution using  $\mathcal{O}(m^4)$  variables. In Section 6 we will compare both solutions implemented in CPLEX and GLPK within an experimental study of running times.

#### 5.2.1 Computing a Bin Solution

We have given a list  $Q$  of  $k$  sequences and  $n$  bins  $b_1, \dots, b_n$  which use  $m$  pallet symbols. Our aim is to find a bin solution for  $Q$ , i.e. a bijection  $\pi : [n] \rightarrow [n]$  for the bins, such that by the removal of the bins from the sequences in the order of  $\pi$  the number of needed stack-up places  $p$  is minimized.

To realize a bijection  $\pi$  we define  $n^2$  binary variables  $x_i^j \in \{0, 1\}$ ,  $i, j \in [n]$ , such that  $x_i^j$  is equal to 1, if and only if bin  $b_i$  is placed at position  $j$  by  $\pi$ . In order to map every bin  $b_i$ ,  $i \in [n]$ , on exactly one position, i.e. to ensure  $\pi$  to be surjective, we use the conditions

$$\sum_{j=1}^n x_i^j = 1 \text{ for every } i \in [n]$$

and in order to map on every position  $j \in [n]$  exactly one bin, i.e. to ensure  $\pi$  to be injective, we use the conditions

$$\sum_{i=1}^n x_i^j = 1 \text{ for every } j \in [n].$$

Further we have to ensure that all variables  $x_i^j$ ,  $i, j \in [n]$ , are in  $\{0, 1\}$ . We will denote the previous  $n^2 + 2n$  conditions by  $\text{PERMUTATION}(n, x_i^j)$ .

By  $\pi$  the relative order of the bins of each sequence  $q \in Q$  has to be preserved, consider for example the bin solution of the sequences of Example 2.2. The bins of the corresponding sequence are shown in black, the others are greyed out.

$$\begin{aligned} (b_5, b_6, b_7, b_8, \mathbf{b_1}, b_9, \mathbf{b_2}, b_{10}, \mathbf{b_3}, \mathbf{b_4}) &\rightarrow q_1 \\ (b_5, b_6, b_7, b_8, b_1, b_9, b_2, b_{10}, b_3, b_4) &\rightarrow q_2 \end{aligned}$$

We have to consider the orderings of the bins given by the  $k$  sequences  $q_1 = (b_1, \dots, b_{n_1}), \dots, q_k = (b_{n_{k-1}+1}, \dots, b_{n_k})$ . For every sequence  $q_\ell$ ,  $1 \leq \ell \leq k$ , and every bin  $b_i$  of this sequence, i.e.  $n_{\ell-1} + 1 \leq i \leq n_\ell$ , we know that if  $b_i$  is placed at position  $j$ , i.e.  $x_i^j = 1$ , then

- every bin  $b_{i'}$ ,  $i' > i$  of sequence  $q_\ell$ , i.e.  $i < i' \leq n_\ell$ , is not placed before  $b_i$ , i.e.  $x_{i'}^{j'} = 0$  for all  $j' < j$ , which is ensured by  $x_{i'}^{j'} \leq 1 - x_i^j$  and
- every bin  $b_{i'}$ ,  $i' < i$  of sequence  $q_\ell$ , i.e.  $n_{\ell-1} + 1 \leq i' < i$ , is not placed after  $b_i$ , i.e.  $x_{i'}^{j'} = 0$  for all  $j' > j$ , which is ensured by  $x_{i'}^{j'} \leq 1 - x_i^j$ .

Since we have  $\mathcal{O}(n^2)$  pairs  $(j', j)$  and  $\mathcal{O}(N^2)$  pairs  $(i', i)$ , and since we have  $k$  sequences, there are at most  $\mathcal{O}(k \cdot n^2 \cdot N^2)$  such conditions. We will denote these conditions by  $\text{SEQUENCEORDER}(Q, x_i^j)$ .

By an integer valued variable  $p$  we count the number of used stack-up places for some given sequence  $Q$  as follows.

$$\text{minimize } p \tag{5}$$

subject to

$$\text{PERMUTATION}(n, x_i^j), \text{ and } \text{SEQUENCEORDER}(Q, x_i^j) \tag{6}$$

$$\text{and } \sum_{t=1}^m f(t, c) \leq p \text{ for every } c \in [n-1] \tag{7}$$

$$\text{and } f(t, c) = \left( \bigvee_{i \in [n], j \leq c, \text{plt}(b_i)=t} x_i^j \right) \wedge \left( \bigvee_{i \in [n], j > c, \text{plt}(b_i)=t} x_i^j \right) \tag{8}$$

For the correctness note that subexpression  $f(t, c)$  is equal to one if and only if in the considered ordering of the bins there is a bin  $b'$  with  $\text{plt}(b') = t$  opened at a step  $\leq c$  and there is a bin  $b''$  with  $\text{plt}(b'') = t$  opened at a step  $> c$ , if and only if pallet  $t$  is open after the  $c$ -th bin has been removed.

**Remark 5.1** Equation (8) is propositional logic and not a linear function in standard form. Propositional logic can be reformulated for binary integer linear programming using the results of [13] which show that every  $n$ -ary boolean function  $f(x_1, \dots, x_n) = x_{n+1}$  can be defined with a binary linear program using  $n+1$  boolean variables  $x_1, \dots, x_{n+1}$ . In order to express Equation (8) we need to define binary conjunctions and an  $n$ -ary disjunction.

- Every conjunction  $x_1 \wedge x_2$ ,  $x_1, x_2 \in \{0, 1\}$  can be realized by introducing a new variable  $x_3 \in \{0, 1\}$  and three conditions

$$x_3 - x_1 \leq 0, \quad x_3 - x_2 \leq 0, \quad x_1 + x_2 - x_3 \leq 1$$

such that finally  $x_3 = x_1 \wedge x_2$ .



- Every  $n$ -ary disjunction  $x_1 \vee x_2 \vee \dots \vee x_n$  can be realized by introducing a new variable  $x_{n+1} \in \{0, 1\}$  and  $n + 1$  conditions

$$x_1 - x_{n+1} \leq 0, \quad x_2 - x_{n+1} \leq 0, \quad \dots, \quad x_n - x_{n+1} \leq 0, \quad x_1 + x_2 + \dots + x_n - x_{n+1} \geq 0$$

such that finally  $x_{n+1} = x_1 \vee x_2 \vee \dots \vee x_n$ .

Next these two transformations are applied on Equation (8). We define  $m \cdot (n - 1) \leq n^2$  binary variables  $g(t, c) \in \{0, 1\}$ ,  $t \in [m]$ ,  $c \in [n - 1]$  such that

$$g(t, c) = \bigvee_{i \in [n], j \leq c, \text{plt}(b_i) = t} x_i^j,$$

which can be realized by

$$x_i^j - g(t, c) \leq 0 \quad \text{for every } i \in [n], j \leq c, \text{plt}(b_i) = t, t \in [m], c \in [n - 1] \quad (9)$$

$$\text{and} \quad \left( \sum_{i \in [n], j \leq c, \text{plt}(b_i) = t} x_i^j \right) - g(t, c) \geq 0 \quad \text{for every } t \in [m], c \in [n - 1] \quad (10)$$

Further we define  $m \cdot (n - 1) \leq n^2$  binary variables  $h(t, c) \in \{0, 1\}$ ,  $t \in [m]$ ,  $c \in [n - 1]$  such that

$$h(t, c) = \bigvee_{i \in [n], j > c, \text{plt}(b_i) = t} x_i^j,$$

which can be realized by

$$x_i^j - h(t, c) \leq 0 \quad \text{for every } i \in [n], j > c, \text{plt}(b_i) = t, t \in [m], c \in [n - 1] \quad (11)$$

$$\text{and} \quad \left( \sum_{i \in [n], j > c, \text{plt}(b_i) = t} x_i^j \right) - h(t, c) \geq 0 \quad \text{for every } t \in [m], c \in [n - 1] \quad (12)$$

Finally we define  $m \cdot (n - 1) \leq n^2$  binary variables  $f(t, c) \in \{0, 1\}$ ,  $t \in [m]$ ,  $c \in [n - 1]$ , such that  $f(t, c) = g(t, c) \wedge h(t, c)$ , which can be realized by

$$f(t, c) - g(t, c) \leq 0 \quad \text{for every } t \in [m], c \in [n - 1] \quad (13)$$

$$\text{and} \quad f(t, c) - h(t, c) \leq 0 \quad \text{for every } t \in [m], c \in [n - 1] \quad (14)$$

$$\text{and} \quad g(t, c) + h(t, c) - f(t, c) \leq 1 \quad \text{for every } t \in [m], c \in [n - 1] \quad (15)$$

**Theorem 5.2** For every list  $Q$  of sequences the integer linear program (5)-(7),(9)-(15) computes the minimum number of stack-up places  $p$  in a processing of  $Q$ .

### 5.2.2 Computing a Pallet Solution

By Theorem 3.2 the minimum number of stack-up places can be computed by the directed pathwidth of the sequence graph  $G_Q$  plus one. In the following we use the fact that the directed pathwidth equals the directed vertex separation number [32].

For a digraph  $G = (V, A)$  on  $n$  vertices, we denote by  $\Pi(G)$  the set of all bijections  $\pi : [n] \rightarrow [n]$  of its vertex set. Given a bijection  $\pi \in \Pi(G)$  we define for  $i \in [n]$  the vertex sets  $L(i, \pi, G) = \{u \in V \mid \pi(u) \leq i\}$  and  $R(i, \pi, G) = \{u \in V \mid \pi(u) > i\}$ . Every position  $i \in [n]$  is called a cut. This allows us to define the directed vertex separation number for digraph  $G$  as follows.

$$\text{d-vsn}(G) = \min_{\pi \in \Pi(G)} \max_{1 \leq i \leq |V|} |\{u \in L(i, \pi, G) \mid \exists v \in R(i, \pi, G) : (v, u) \in A\}|$$

An integer linear program for computing the directed vertex separation number for some given sequence graph  $G_Q = (V, A)$  on  $m$  vertices is as follows. To realize  $\pi$  we define  $m^2$  binary variables  $x_i^j \in \{0, 1\}$ ,  $i, j \in [m]$ , such that  $x_i^j$  is equal to 1, if and only if pallet  $v_i$  is placed at position  $j$  by

$\pi$ . Additionally we use a variable  $w$  in order to count the vertices adjacent to the right side of the cuts.

$$\text{minimize } w \tag{16}$$

subject to

$$\text{PERMUTATION}(m, x_i^j) \tag{17}$$

$$\text{and } \sum_{j=1}^c Y(j, c) \leq w \text{ for every } c \in [m-1] \tag{18}$$

$$\text{and } Y(j, c) = \bigvee_{\substack{j' \in \{c+1, \dots, m\} \\ i, i' \in [m], (v_{i'}, v_i) \in A}} (x_i^j \wedge x_{i'}^{j'}) \tag{19}$$

For the correctness note that subexpression  $Y(j, c)$  is equal to one if and only if there exists an arc from a vertex on a position  $j' > c$  to a vertex on position  $j$ .

**Remark 5.3** Equation (19) is propositional logic and not a linear function in standard form. In order to express Equation (19) we need to define binary conjunctions and an  $n$ -ary disjunction, see Remark 5.1.

We define  $m^4$  binary variables  $X(i, i', j, j') \in \{0, 1\}$ ,  $i, i', j, j' \in [m]$ , such that  $X(i, i', j, j') = x_i^j \wedge x_{i'}^{j'}$ , which can be realized by

$$X(i, i', j, j') - x_i^j \leq 0 \quad \text{for every } i, i', j, j' \in [m] \tag{20}$$

$$\text{and } X(i, i', j, j') - x_{i'}^{j'} \leq 0 \quad \text{for every } i, i', j, j' \in [m] \tag{21}$$

$$\text{and } x_i^j + x_{i'}^{j'} - X(i, i', j, j') \leq 1 \quad \text{for every } i, i', j, j' \in [m] \tag{22}$$

We define  $\mathcal{O}(m^2)$  binary variables  $Y(j, c) \in \{0, 1\}$  for  $j, c \in [m-1]$ ,  $j \leq c$ , such that

$$Y(j, c) = \bigvee_{\substack{j' \in \{c+1, \dots, m\} \\ i, i' \in [m], (v_{i'}, v_i) \in A}} X(i, i', j, j'),$$

which can be realized by

$$X(i, i', j, j') - Y(j, c) \leq 0 \quad \text{for every } j' \in \{c+1, \dots, m\}, i, i' \in [m], (v_{i'}, v_i) \in A, j, c \in [m-1] \tag{23}$$

$$\text{and } \left( \sum_{\substack{j' \in \{c+1, \dots, m\} \\ i, i' \in [m], (v_{i'}, v_i) \in A}} X(i, i', j, j') \right) - Y(j, c) \geq 0 \quad \text{for every } j, c \in [m-1] \tag{24}$$

**Theorem 5.4** For every list  $Q$  of sequences the integer linear program (16)-(18),(20)-(24) computes the minimum number of stack-up places  $p = w + 1$  in a processing of  $Q$ .

### 5.3 Exact Exponential Time Algorithms

The running time of exponential time algorithms is often given in the  $\mathcal{O}^*$ -notation, which hides polynomial factors.

**Theorem 5.5** The FIFO STACK-UP problem can be solved in time  $\mathcal{O}^*(2^m)$ .

**Proof** The directed pathwidth of a digraph  $G = (V, A)$  can be computed in time  $\mathcal{O}^*(2^{|V|})$  by [2]. Since the sequence graph  $G_Q$  can be constructed in time  $\mathcal{O}(n + k \cdot m^2)$  by algorithm CREATE SEQUENCE GRAPH shown in Figure 5, the statement follows by Theorem 3.2.  $\square$

$\square$

## 5.4 Parameterized Algorithms

Within parameterized complexity we consider a two dimensional analysis of the computational complexity of a problem. Denoting the input by  $I$ , the two considered dimensions are the size  $|I|$  and a parameter  $\kappa(I)$ , see [9] for a survey.

A *parameterized problem* is a pair  $(\Pi, \kappa)$ , where  $\Pi$  is a decision problem,  $\mathcal{I}$  the set of all instances of  $\Pi$  and  $\kappa : \mathcal{I} \rightarrow \mathbb{N}$  is a so called *parameterization* or *parameter*. The parameter  $\kappa(I)$  should be small for all inputs  $I \in \mathcal{I}$ . Please note that the following running times are exponential, but for small values of  $\kappa(I)$  they may be good in practice.

- An algorithm  $A$  is an *xp-algorithm with respect to  $\kappa$* , if there are two computable functions  $f, g : \mathbb{N} \rightarrow \mathbb{N}$  such that for every instance  $I \in \mathcal{I}$  the running time of  $A$  on  $I$  (with input size  $|I|$ ) is at most  $f(\kappa(I)) \cdot |I|^{g(\kappa(I))}$ . A typical running time is  $2^{\kappa(I)} \cdot |I|^{3 \cdot \kappa(I)}$ . A parameterized problem  $(\Pi, \kappa)$  belongs to the class XP and is called *slice-wise polynomial*, if there is an xp-algorithm with respect to  $\kappa$  which decides  $\Pi$ .
- An algorithm  $A$  is an *fpt-algorithm with respect to  $\kappa$* , if there is a computable function  $f : \mathbb{N} \rightarrow \mathbb{N}$  such that for every instance  $I \in \mathcal{I}$  the running time of  $A$  on  $I$  (with input size  $|I|$ ) is at most  $f(\kappa(I)) \cdot |I|^c$  for some fixed  $c \in \mathbb{N}$ . A typical running time is  $2^{\kappa(I)} \cdot |I|^2$ . A parameterized problem  $(\Pi, \kappa)$  belongs to the class FPT and is called *fixed-parameter tractable*, if there is an fpt-algorithm with respect to  $\kappa$  which decides  $\Pi$ .

Fixed-parameter algorithms have shown to be useful in several fields, among there are: phylogenetics [12], biopolymer sequences comparison [4], artificial intelligence, constraint satisfaction, and database problems [11], geometric problems [10], and cognitive modeling [30].

In order to show fixed-parameter intractability, it is useful to show the hardness with respect to one of the classes  $W[t]$  for some  $t \geq 1$  which were introduced by Downey and Fellows [7] in terms of weighted satisfiability problems on classes of circuits. The following relations – the so called W-hierarchy – hold and all inclusions are assumed to be strict.

$$\text{FPT} \subseteq W[1] \subseteq W[2] \subseteq \dots \subseteq \text{XP}$$

For the FIFO STACK-UP problem we choose the number of sequences  $k$  or the number of pallets  $m$  and others as a parameter  $\kappa(I)$  from the instance  $I$ , in order to obtain the following parameterized problem.

**Name:**  $\kappa(I)$ -FIFO STACK-UP

**Instance:** A list  $Q = (q_1, \dots, q_k)$  of sequences and a positive integer  $p$ .

**Parameter:**  $\kappa(I)$

**Question:** Is there a processing of  $Q$ , such that in each configuration during the processing of  $Q$  at most  $p$  pallets are open?

We give two useful instruments to obtain fpt-results used in the next subsections. The first result gives a connection between the existence of ILP formulations and fixed-parameter tractability w.r.t. the number of variables.

**Theorem 5.6** ([22],[25]) *If for some problem  $\Pi$  there is an ILP using  $\ell$  variables, then  $\Pi$  can be solved for every instance  $I$  in time  $\mathcal{O}(|I| \cdot \ell^{\mathcal{O}(\ell)})$ .*

The next remark states the running time of an exhaustive search for problems in NP. The correctness follows immediately by the definition of NP-completeness.

**Remark 5.7** ([31]) *If some problem  $\Pi$  belongs to NP, then there is some polynomial  $q$  such that  $\Pi$  can be solved for every instance  $I$  in time  $\mathcal{O}(2^{q(|I|)})$ .*

### 5.4.1 XP-Algorithms

**Parameterization by number of sequences  $k$**  By Theorem 4.2 we obtain an xp-algorithm with respect to the parameter  $k$ .

**Theorem 5.8** *There is an xp-algorithm that solves  $k$ -FIFO STACK-UP in time  $\mathcal{O}(k \cdot (N + 1)^k)$ .*

**Parameterization by number of stack-up places  $p$**  The directed pathwidth of a digraph  $G = (V, A)$  can be computed in time  $\mathcal{O}(|A| \cdot |V|^{\text{d-pw}(G)+1}) \subseteq \mathcal{O}(|V|^{\text{d-pw}(G)+3})$  by [29] and the sequence graph  $G_Q$  can be computed in time  $\mathcal{O}(n + k \cdot m^2)$  which can be bounded by  $\mathcal{O}(n + m^3)$  due to Remark 2.3. Thus the FIFO STACK-UP problem can be solved by Theorem 3.2 in time  $\mathcal{O}(n + m^{p+2})$ .

**Theorem 5.9** *There is an xp-algorithm that solves  $p$ -FIFO STACK-UP in time  $\mathcal{O}(n + m^{p+2})$ .*

### 5.4.2 FPT-Algorithms

**Parameterization by number of bins  $n$**  We generate all possible bin orders  $(b_{\pi(1)}, \dots, b_{\pi(n)})$  and verify, whether this can be a processing. This leads to a simple but very inefficient algorithm with running time  $\mathcal{O}(n^2 \cdot n!)$ , where  $\mathcal{O}(n^2)$  time is needed for each verification.

**Theorem 5.10** *There is an fpt-algorithm that solves  $n$ -FIFO STACK-UP in time  $\mathcal{O}(n! \cdot n^2)$ .*

Alternatively we can apply Theorem 5.6, Remark 5.1, and Theorem 5.2. Integer program (5)-(7),(9)-(15) has at most  $4n^2 + 1 \in \mathcal{O}(n^2)$  variables and a polynomial number of constraints. From Theorem 5.6 it follows that the FIFO STACK-UP problem is fixed-parameter tractable for the parameter  $n$ .

**Theorem 5.11** *There is an fpt-algorithm that solves  $n$ -FIFO STACK-UP in time  $\mathcal{O}(|I| \cdot (4n^2 + 1)^{\mathcal{O}(n^2)})$ .*

Alternatively we can apply Remark 5.7. Since we assume that  $p \leq m \leq n$ , the size of an instance  $I$  can be bounded by  $|I| \in \mathcal{O}(n \cdot \log(n))$ , see Equation (1), and by Remark 5.7 it follows that the FIFO STACK-UP problem is fixed-parameter tractable for the parameter  $n$ .

**Theorem 5.12** *There is an fpt-algorithm that solves  $n$ -FIFO STACK-UP in time  $\mathcal{O}(2^{q(n \cdot \log(n))})$  for some polynomial  $q$ .*

**Parameterization by number of pallets  $m$**  Let  $(t_1, \dots, t_m)$  be a permutation of the pallets of  $plts(Q)$ . It can be checked in time  $\mathcal{O}(n \cdot k) \subseteq \mathcal{O}(n^2)$  whether this permutation describes a processing of  $Q$  using at most  $p$  stack-up places, see Section 4.2. There are  $m!$  permutations of the pallets. If we enumerate all  $m!$  possible pallet orders and check each order, we can solve the FIFO STACK-UP problem.

**Theorem 5.13** *There is an fpt-algorithm that solves  $m$ -FIFO STACK-UP in time  $\mathcal{O}(n^2 \cdot m!)$ .*

Alternatively we can apply Theorem 5.6, Remark 5.3, and Theorem 5.4. Integer linear program (16)-(18),(20)-(24) has at most  $m^4 + 2m^2 + 1 \in \mathcal{O}(m^4)$  variables and a polynomial number of constraints. From Theorem 5.6 it follows that the FIFO STACK-UP problem is fixed-parameter tractable for the parameter  $m$ .

**Theorem 5.14** *There is an fpt-algorithm that solves  $m$ -FIFO STACK-UP in time  $\mathcal{O}(|I| \cdot (m^4 + 2m^2 + 1)^{\mathcal{O}(m^4)})$ .*

We also can apply the relation to directed pathwidth given in Theorem 3.2. Since the directed pathwidth of a digraph  $G = (V, A)$  can be computed in time  $\mathcal{O}(1.89^{|V|})$  by [24], and since the sequence graph  $G_Q$  can be constructed in time  $\mathcal{O}(n + k \cdot m^2)$  by algorithm CREATE SEQUENCE GRAPH shown in Figure 5, the next result follows by Theorem 3.2.

**Theorem 5.15** *There is an fpt-algorithm that solves  $m$ -FIFO STACK-UP in time  $\mathcal{O}(n + k \cdot m^2 + 1.89^m)$ .*

Alternatively we can apply the relation to directed pathwidth given in Theorem 3.2 and Proposition 3.4. Let  $(Q, p)$  be an instance for the FIFO STACK-UP problem with values  $(n, m, k, N)$ . We start to compute from  $Q$  the sequence graph  $G_Q = (V, A)$  in time  $\mathcal{O}(n + k \cdot m^2)$ . Then from  $G_Q$  we build up the sequence system  $Q'_{G_Q}$  with values  $(n', m', k', N')$  in time  $\mathcal{O}(|V| + |A|) \subseteq \mathcal{O}(m^2)$ . By Theorem 3.2 and Proposition 3.4 list  $Q$  can be processed with at most  $p$  stack-up places, if and only if list  $Q'$  can be processed with at most  $p$  stack-up places. Further we know that  $k' \in \mathcal{O}(m^2)$  and  $N' = 2$ . By applying Theorem 4.2 for  $Q'$  we can solve the FIFO STACK-UP problem in time  $\mathcal{O}(k' \cdot (N' + 1)^{k'}) \subseteq \mathcal{O}(m^2 \cdot 3^{m^2})$ .

**Theorem 5.16** *There is an fpt-algorithm that solves  $m$ -FIFO STACK-UP in time  $\mathcal{O}(m^2 \cdot 3^{m^2} + n + k \cdot m^2)$ .*

**Parameterization by combined parameters** In the case of W[1]-hardness with respect to some parameter  $\ell$  a natural question is whether the problem remains hard for *combined* parameters, i.e. parameters  $(\ell, \ell')$  that consists of two or even more parts of the input. Since the existence of an fpt-algorithm w.r.t. parameter  $k$  is open up to now, we next conclude an fpt-algorithm with respect to parameter  $(k, m)$ , by the result of Theorem 4.5.

**Theorem 5.17** *There is an fpt-algorithm that solves  $(k, m)$ -FIFO STACK-UP in time  $\mathcal{O}(n^2 \cdot k^m)$ .*

In practice  $k$  is much smaller than  $m$ , since there are much fewer buffer conveyors than pallets, thus this solution is better than  $\mathcal{O}(n^2 \cdot m!)$ . In order to show a better fpt-algorithm with respect to parameter  $(k, m)$ , we consider the result of Theorem 4.4.

**Theorem 5.18** *There is an fpt-algorithm that solves  $(k, m)$ -FIFO STACK-UP in time  $\mathcal{O}(n^2 \cdot (m + 2)^k)$ .*

Since there are much fewer buffer conveyors than pallets in practice, this solution is better than  $\mathcal{O}(n^2 \cdot k^m)$ .

## 5.5 Approximation

Since the directed pathwidth of a digraph  $G = (V, A)$  can be approximated by a factor of  $\mathcal{O}(\log^{1.5} |V|)$  by [23], the FIFO STACK-UP problem can be approximated using the sequence graph  $G_Q$  by Theorem 3.2.

**Theorem 5.19** *There is an approximation algorithm that solves the optimization version of the FIFO STACK-UP problem up to a factor of  $\mathcal{O}(\log^{1.5} m)$ .*

## 6 Experimental Results

Next we want to evaluate an implementation of algorithm FIND OPTIMAL PALLET SOLUTION given in Figure 12 and our two linear programming approaches given in (5)-(7),(9)-(15) and (16)-(18),(20)-(24) using GLPK and CPLEX.

### 6.1 Creating Instances

Since there are no benchmark data sets for the FIFO STACK-UP problem we generated randomly instances by an algorithm, which allows to give the following parameters.

- $p_{\max}$  an upper bound on the number of stack-up places needed to process the generated sequences

- $k$  number of sequences
- $m$  number of pallets
- $r_{\min}$  and  $r_{\max}$  the minimum and maximum number of bins per pallet
- $d$  maximum number of sequences on which the bins of each pallet can be distributed

The idea is to compute a bin solution  $B = (b_1, \dots, b_n)$  with respect to the given parameters and to distribute the bins to the  $k$  sequences such that the relative order will be preserved, i.e.  $b_i$  will be placed left of  $b_j$  in some sequence, if  $i < j$  in  $B$ . The algorithm is shown in Figure 13.

---

**Algorithm** RANDOM INSTANCES

---

<pre> #open := 0; open := <math>\emptyset</math>; avg := <math>(r_{\min} + r_{\max})/2</math> for all <math>i := 1</math> to <math>m</math> step 2 do   <math>r := \text{random}(0, r_{\max} - r_{\min})</math>   <math>\text{no}[i] := \text{avg} + r</math>   <math>\text{no}[i + 1] := \text{avg} - r</math> for all <math>i \in [m]</math> and <math>j \in [d]</math> do   <math>\text{seq}[i][j] := \text{random}(1, k)</math> for all <math>i \in [k]</math> do <math>q_i := ()</math> unproc := <math>[m]</math>; <math>i := 0</math>; while <math>i &lt; n</math> do   <math>i = i + 1</math>   if #open = <math>p</math>     <math>\text{plt} := \text{choose some pallet of open at random}</math>   else     <math>\text{plt} := \text{choose some pallet of open} \cup \text{unproc at random}</math>   if <math>\text{plt} \in \text{unproc}</math>     <math>\#open := \#open + 1</math>; <math>\text{open} := \text{open} \cup \{\text{plt}\}</math>; <math>\text{unproc} := \text{unproc} - \{\text{plt}\}</math>   <math>r := \text{random}(1, d)</math>   <math>s := \text{seq}[\text{plt}][r]</math>   append bin <math>b_i</math> to sequence <math>q_s</math>   <math>\text{no}[\text{plt}] := \text{no}[\text{plt}] - 1</math>   if <math>\text{no}[\text{plt}] = 0</math>     <math>\#open := \#open - 1</math>; <math>\text{open} := \text{open} - \{\text{plt}\}</math>; </pre>	<p>► Description of Functions and Variables:</p> <p>► <math>\text{random}(\ell, u)</math>: int // choose some value in <math>[\ell, u]</math></p> <p>► at random</p> <p>► <math>\text{no}[1 \dots m]</math>: int // number bins for each pallet</p> <p>► <math>n</math>: int // total number of bins, <math>n = \sum_{i=1}^m \text{no}[i]</math></p> <p>► <math>\text{seq}[1 \dots m][1 \dots d]</math>: int // for each individual pallet there are up to <math>d</math> sequences, on which to distribute the bins</p>
--	--

---

Figure 13: Construction of random instances for the FIFO STACK-UP problem.

## 6.2 Implementations

We consider the breadth first search based solution FIND OPTIMAL PALLET SOLUTION for the FIFO STACK-UP problem given in Figure 12. For several practical instance sizes the running time of this solution is too huge for computations, e.g.  $m = 254$  and  $k = 10$  lead a time of  $\mathcal{O}(n^2 \cdot (m + 2)^k) = \mathcal{O}(n^2 \cdot 2^{80})$ . Therefore we used a cutting technique on the decision graph  $G = (V, A)$  by restricting to vertices  $v \in V$  representing configurations  $C_Q(v)$  such that  $\#open(C_Q(v)) \leq p_{\max}$  and increasing the value of  $p_{\max}$  by 5 until a solution is found, see Figure 14. We have implemented algorithm FIND OPTIMAL PALLET SOLUTION as a single-threaded program in C++ on a standard Linux PC with 3.30 GHz CPU and 7.7 GiB RAM.

Our two linear programming approaches given in (5)-(7),(9)-(15) and (16)-(18),(20)-(24) have been realized in GLPK v4.43 and CPLEX 12.6.0.0 and have been run on the same machine. GLPK is single-threaded, while CPLEX uses all 4 cores of the CPU.

---

**Algorithm** ITERATIVE PROCESS

---

```
 $p_{\max} := 5;$   
level := 0; ▷ last level without cuts  
 $L[0] := ( (0, \dots, 0) )$  ▷  $L[0]$ : level 0 only contains the initial configuration  
 $pred[ (0, \dots, 0) ] := \emptyset$   
 $val[ (0, \dots, 0) ] := 0$   
 $open[ (0, \dots, 0) ] := \emptyset$   
while BFS( $p_{\max}$ ) yields no solution do  
     $p_{\max} := p_{\max} + 5$ 
```

---

Figure 14: Iterative process of our cutting technique.

---

**Algorithm** BFS( $p$ )

---

```
for  $\ell := \text{level} + 1$  to  $m$  do ▷  $\ell$ : level in the decision graph  
  for each configuration  $C \in L[\ell - 1]$  do ▷  $L[\ell]$ : list of nodes in level  $\ell$   
    if ( $pred[C] \neq \emptyset$ )  
      EXTEND PATH( $C$ )  
      for  $j := 1$  to  $k$  do  
         $C_s := (i_1, \dots, i_j + 1, \dots, i_k)$   
         $O := open[C] \cup plt(b_{i_j+1})$   
        for  $i := 1$  to  $k$  do ▷ perform automatic transformation steps  
          while the first bin in  $q_i$  is destined for an open pallet in  $O$   
            let  $C_s$  be the configuration obtained by removing the first bin of  $q_i$   
          if ( $C_s$  is not in  $L[\ell]$  and  $\#open(C_s) \leq p$ ) ▷ Cut  
            append( $C_s, L[\ell]$ )  
            append( $C, pred[C_s]$ )  
            if ( $C_s$  is final) return  $C_s$   
        if  $\ell - 1 \neq p$  then erase( $C, L[\ell - 1]$ ) ▷ remove  $C$  from list  $L[\ell - 1]$   
level :=  $p$ ;
```

---

Figure 15: BFS.

### 6.3 Evaluation

First we consider our implementation of algorithm FIND OPTIMAL PALLET SOLUTION. In Table 2 we list our chosen parameters. For each assignment we randomly generated and solved 10 instances to compute the average time for solving an instance with the given parameters. Our results show that we can solve practical instances on several thousand bins in a few minutes.

Next we consider our two linear programming models realized in GLPK and CPLEX. Since the size of the instances of Table 2 was so high that none of the ILP approaches was able to solve them, we generated much smaller parameters in the instances of Table 3. For each assignment we randomly generated and solved 10 instances in order to compute the average time for solving the same instances with the given parameters by our two linear programming models using GLPK and CPLEX.

Our results show that algorithm FIND OPTIMAL PALLET SOLUTION can be used to solve practical instances on several thousand bins of the FIFO STACK-UP problem. Our two linear programming approaches can only be used to handle instances up to 100 bins and less than 10 pallets. Since it is a commercial product of high licence cost CPLEX can solve the instances much faster than the open-source solver GLPK and, as expected, the pallet solution approach is much better than the bin solution approach.

	Instance							BFS and cutting Pallet Solution
	$n$	$p_{\max}$	$m$	$k$	$r_{\min}$	$r_{\max}$	$d$	
1.	1500	14	100	8	10	20	4	0.14
2.	1500	14	100	8	10	20	6	0.12
3.	1500	14	100	8	10	20	8	0.08
4.	2000	14	100	8	10	30	4	0.17
5.	2000	14	100	8	10	30	6	0.15
6.	2000	14	100	8	10	30	8	0.13
7.	2500	14	100	8	10	40	4	0.22
8.	2500	14	100	8	10	40	6	0.10
9.	2500	14	100	8	10	40	8	0.07
10.	6000	18	300	10	15	25	5	5.78
11.	6000	18	300	10	15	25	7	3.72
12.	6000	18	300	10	15	25	10	2.01
13.	7500	18	300	10	15	35	5	7.78
14.	7500	18	300	10	15	35	7	2.83
15.	7500	18	300	10	15	35	10	2.07
16.	9000	18	300	10	15	45	5	4.21
17.	9000	18	300	10	15	45	7	2.23
18.	9000	18	300	10	15	45	10	1.45
19.	12500	22	500	12	20	30	6	92.52
20.	12500	22	500	12	20	30	9	52.74
21.	12500	22	500	12	20	30	12	42.81
22.	15000	22	500	12	20	40	6	103.24
23.	15000	22	500	12	20	40	9	49.54
24.	15000	22	500	12	20	40	12	32.85
25.	17500	22	500	12	20	50	6	88.52
26.	17500	22	500	12	20	50	9	38.61
27.	17500	22	500	12	20	50	12	41.70

Table 2: Running times in seconds for randomly generated instances for finding optimal solutions of the FIFO STACK-UP problem by algorithm FIND OPTIMAL PALLET SOLUTION.

## 7 Conclusions and Outlook

In this paper we consider three graph models for the FIFO STACK-UP problem. Based on these models we have shown a breadth first search solution and two linear programming solutions to solve the problem. Further we have given parameterized algorithms w.r.t. several parameters which are summarized in Table 4. We also could give a first approximation result for minimizing the number of stack-up places.

In our future work we want to determine the complexity of the FIFO STACK-UP problem for  $d_Q \in \{2, \dots, 5\}$ . Further we intend to find better approximation algorithms, try to improve the running time of the given parameterized algorithms, and explore the existence of fpt-algorithms w.r.t. parameters  $k$  and  $p$ . Due Tamaki (Section 6 in [29]) the existence of an fpt-algorithm for the directed pathwidth problem w.r.t. the standard parameter is still open. By Theorem 3.2 such an algorithm would imply an fpt-algorithm for the FIFO STACK-UP problem w.r.t.  $p$ , and vice versa.

We are also interested in on-line algorithms for instances where we only know the first  $c$  bins of every sequence instead of the complete sequences [3, 8]. Especially, we are interested in the answer to the following question: Is there a  $d$ -competitive on-line algorithm? Such an algorithm must compute a processing of some  $Q$  with at most  $p \cdot d$  stack-up places, if  $Q$  can be processed with at most  $p$  stack-up places. First approaches for on-line algorithms for controlling palletizers



	Instance							GLPK		CPLEX	
	$n$	$p_{\max}$	$m$	$k$	$r_{\min}$	$r_{\max}$	$d$	Bin	Pallet	Bin	Pallet
								Solution	Solution	Solution	Solution
1.	15	2	3	2	4	6	2	41.4	0.1	0.1	0.1
2.	20	2	4	2	4	6	2	-	0.1	1.7	0.1
3.	30	4	5	4	4	8	2	-	0.7	66.8	0.2
4.	48	4	6	4	6	10	2	-	2.5	932.6	1.2
5.	64	4	8	5	6	10	2	-	684.6	-	16.3
6.	100	5	10	5	5	15	2	-	-	-	282.3

Table 3: Running times in seconds for randomly generated instances for finding optimal solutions of the FIFO stack-up problem. Running times of more than 1800 seconds = 30 minutes are indicated by a bar (-).

parameter	$k$	$p$	$m$	$n$	$(k, m)$
FPT	?	?	+	+	+
XP	+	+	+	+	+

Table 4: Parameterized complexity of the FIFO STACK-UP problem

are presented in [19].

In real life the bins arrive at the stack-up system on the main conveyor of a pick-to-belt orderpicking system. That means, the distribution of bins to the sequences, for example by some pre-placed cyclic storage conveyor, has to be computed. Up to now we consider the distribution as given. We intend to consider how to compute an optimal distribution of the bins from the main conveyor onto the sequences such that a minimum number of stack-up places is necessary to stack-up all bins from the sequences.

## References

- [1] J. Barát. Directed pathwidth and monotonicity in digraph searching. *Graphs and Combinatorics*, 22:161–172, 2006.
- [2] H. L. Bodlaender, F.V. Fomin, A.M.C.A. Koster, D. Kratsch, and D.M. Thilikos. A note on exact algorithms for vertex ordering problems on graphs. *Theory of Computing Systems*, 50(3):420–432, 2012.
- [3] A. Borodin. *On-line Computation and Competitive Analysis*. Cambridge Univ. Press, 1998.
- [4] L. Cai, X. Huang, C. Liu, F.A. Rosamond, and Y. Song. Parameterized complexity and biopolymer sequence comparison. *The Computer Journal*, 51(3):270–291, 2008.
- [5] R. de Koster. Performance approximation of pick-to-belt orderpicking systems. *European Journal of Operational Research*, 92:558–573, 1994.
- [6] M. Dehmer and F. Emmert-Streib, editors. *Quantitative Graph Theory: Mathematical Foundations and Applications*. Crc Pr Inc, New York, 2014.
- [7] R.G. Downey and M.R. Fellows. *Parameterized Complexity*. Springer-Verlag, New York, 1999.
- [8] A. Fiat and G.J. Woeginger. *Online Algorithms: The state of the art*, volume 1442 of *LNCS*. Springer-Verlag, 1998.

- [9] J. Flum and M. Grohe. *Parameterized Complexity Theory*. Springer-Verlag, Berlin, 2006.
- [10] P. Giannopoulos, C. Knauer, and S. Whitesides. Parameterized complexity of geometric problems. *The Computer Journal*, 51(3):372–384, 2008.
- [11] G. Gottlob and S. Szeider. Fixed-parameter algorithms for artificial intelligence, constraint satisfaction and database problems. *The Computer Journal*, 51(3):303–325, 2008.
- [12] J. Gramm, A. Nickelsen, and T. Tantau. Fixed-parameter algorithms in phylogenetics. *The Computer Journal*, 51(1):79–101, 2008.
- [13] F. Gurski. Efficient binary linear programming formulations for boolean functions. *Statistics, Optimization and Information Computing*, 2(4):274–279, 2014.
- [14] F. Gurski, J. Rethmann, and E. Wanke. Moving bins from conveyor belts onto pallets using FIFO queues. In *Operations Research Proceedings (OR 2013), Selected Papers*, pages 185–191. Springer-Verlag, 2014.
- [15] F. Gurski, J. Rethmann, and E. Wanke. Directed pathwidth and palletizers. In *Proceedings of the International Conference on Combinatorial Optimization and Applications*, volume 9486 of *LNCS*, pages 31–44. Springer-Verlag, 2015.
- [16] F. Gurski, J. Rethmann, and E. Wanke. A practical approach for the FIFO stack-up problem. In *Modelling, Computation and Optimization in Information Systems and Management Sciences*, volume 360 of *Advances in Intelligent Systems and Computing*, pages 141–152. Springer-Verlag, 2015.
- [17] F. Gurski, J. Rethmann, and E. Wanke. Algorithms for controlling palletizers. In *Operations Research Proceedings (OR 2014), Selected Papers*, pages 197–203. Springer-Verlag, 2016.
- [18] F. Gurski, J. Rethmann, and E. Wanke. An experimental study of algorithms for controlling palletizers. In *Operations Research Proceedings (OR 2015), Selected Papers*. Springer-Verlag, 2016. to appear.
- [19] F. Gurski, J. Rethmann, and E. Wanke. On-line algorithms for controlling palletizers (Abstract). International Conference on Operations Research (OR 2016), 2016.
- [20] F. Gurski, J. Rethmann, and E. Wanke. On the complexity of the fifo stack-up problem. *Mathematical Methods of Operations Research*, 83(1):33–52, 2016.
- [21] T. Johnson, N. Robertson, P.D. Seymour, and R. Thomas. Directed tree-width. *Journal of Combinatorial Theory, Series B*, 82:138–155, 2001.
- [22] R. Kannan. Minkowski’s convex body theorem and integer programming. *Mathematics of Operations Research*, 12:415–440, 1987.
- [23] S. Kintali, N. Kothari, and A. Kumar. Approximation algorithms for digraph width parameters. *Theoretical Computer Science*, 562:365–376, 2015.
- [24] K. Kitsunai, Y. Kobayashi, K. Komuro, H. Tamaki, and T. Tano. Computing directed pathwidth in  $O(1.89^n)$  time. In *Proceedings of International Workshop on Parameterized and Exact Computation*, volume 7535 of *LNCS*, pages 182–193. Springer-Verlag, 2012.
- [25] H.W. Lenstra. Integer programming with a fixed number of variables. *Mathematics of Operations Research*, 8:538–548, 1983.
- [26] J. Rethmann and E. Wanke. Storage controlled pile-up systems, theoretical foundations. *European Journal of Operational Research*, 103(3):515–530, 1997.

- [27] J. Rethmann and E. Wanke. On approximation algorithms for the stack-up problem. *Mathematical Methods of Operations Research*, 51:203–233, 2000.
- [28] J. Rethmann and E. Wanke. Stack-up algorithms for palletizing at delivery industry. *European Journal of Operational Research*, 128(1):74–97, 2001.
- [29] H. Tamaki. A Polynomial Time Algorithm for Bounded Directed Pathwidth. In *Proceedings of Graph-Theoretical Concepts in Computer Science*, volume 6986 of *LNCS*, pages 331–342. Springer-Verlag, 2011.
- [30] I. van Rooij and T. Wareham. Parameterized complexity in cognitive modeling: Foundations, applications and opportunities. *The Computer Journal*, 51(3):385–404, 2008.
- [31] G.J. Woeginger. Space and time complexity of exact algorithms: Some open problems. In *Proceedings of the International Workshop on Parameterized and Exact Computation*, volume 3162 of *Lecture Notes in Computer Science*, pages 281–290. Springer-Verlag, 2004.
- [32] B. Yang and Y. Cao. Digraph searching, directed vertex separation and directed pathwidth. *Discrete Applied Mathematics*, 156(10):1822–1837, 2008.