

ON THE SET OF L-SPACE SURGERIES FOR LINKS

EUGENE GORSKY AND ANDRÁS NÉMETHI

ABSTRACT. It is known that the set of L-space surgeries on a nontrivial L-space knot is always bounded from below. However, already for two-component torus links the set of L-space surgeries might be unbounded from below. For algebraic two-component links we provide three complete characterizations for the boundedness from below: one in terms of the h -function, one in terms of the Alexander polynomial, and one in terms of the embedded resolution graph. They show that the set of L-space surgeries is bounded from below for most algebraic links. In fact, the used property of the h -function is a sufficient condition for non-algebraic L-space links as well.

1. INTRODUCTION

1.1. A 3-manifold is called an L-space, if its Heegaard-Floer homology has the minimal possible rank. L-spaces have been recently explored and applied to various problems in low-dimensional topology [33]. Being an L-space reflects several deep surgery, topological and geometrical properties. A link in S^3 is called an L-space link if all sufficiently large surgeries along its components are L-spaces.

Definition 1.1.1. Let $L = L_1 \cup \dots \cup L_r \subset S^3$ be a link with r components. We define $\mathbf{LS}(L) \subset \mathbb{Z}^r$ to be the set of all r -tuples (d_1, \dots, d_r) such that the surgery $S_{d_1, \dots, d_r}^3(L)$ of S^3 along L with coefficients (d_1, \dots, d_r) is an L-space.

By definition, L is an L-space link if and only if $(\mathbb{Z}_{\geq N})^r \subset \mathbf{LS}(L)$ for some N . The structure of the set \mathbf{LS} for knots is described by the following result.

Theorem 1.1.2. ([31, 33], [14, Lemma 2.13]) *Let K be a nontrivial L-space knot. Then $S_d^3(K)$ is an L-space if and only if $d \geq 2g(K) - 1$. In other words, $\mathbf{LS}(K) = [2g(K) - 1, +\infty)$.*

On the other hand, already for two-component links the structure of the set \mathbf{LS} becomes very complicated. For example, the sets $\mathbf{LS}(T(2p, 2q))$ for two-component torus links were studied for $p = 1$ in [21] and for $p > 1$ in [10], and happen to be unbounded from below (see Figure 1 for the structure of \mathbf{LS} for the $(4, 6)$ torus link). In this paper, we study the following basic question about L-space links.

Problem 1.1.3. *For which L-space links the set $\mathbf{LS}(L)$ is bounded from below?*

Note that by a theorem of Liu [21] the Heegaard-Floer homology of any surgery on a 2-component L-space link is completely determined by its Heegaard-Floer link homology, which, in its turn, is determined by the bivariate Alexander polynomial. However, it appears to be hard to use this algorithm directly to determine the set $\mathbf{LS}(L)$. We give the following partial answer.

Assume that L has 2 components. Let h be the h -function for L (defined in [11]), h_i are the h -functions for L_i and v^* is the point naturally dual to v , see Definition 3.4.1 for all details. A

The first author was partially supported by RFBR grants 13-01-00755, 16-01-00409 and NSF grants DMS-1403560, DMS-1559338.

The second author was partially supported by NKFIH Grant 112735 and ERC Adv. Grant LDTBud of A. Stipsicz at Rényi Institute of Math., Budapest.

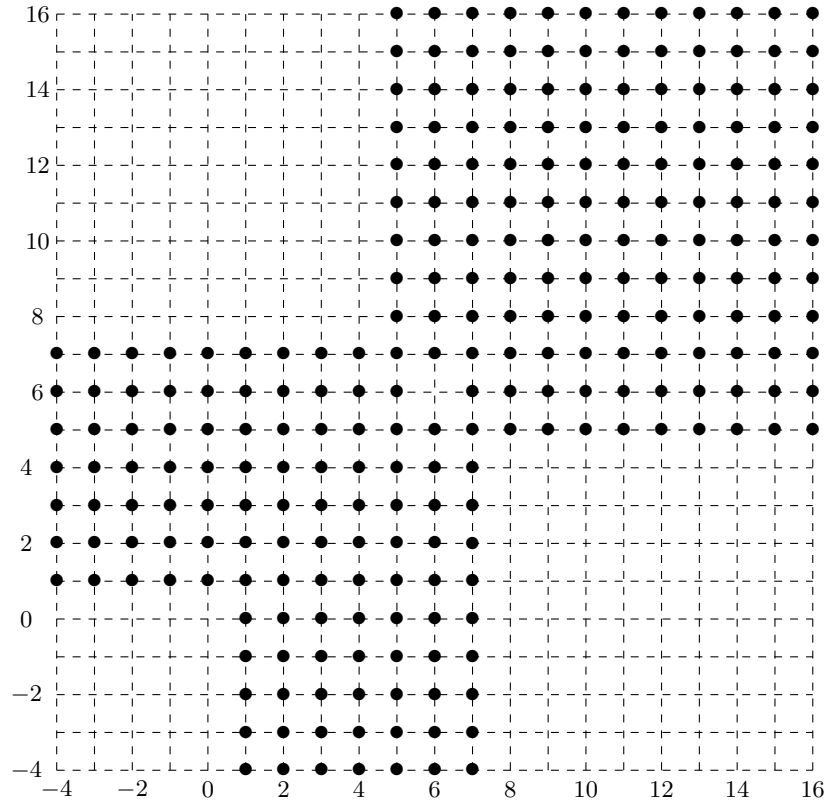

FIGURE 1. The set \mathbf{LS} for the $(4, 6)$ torus link

point $v = (v_1, v_2) \in \mathbb{Z}^2$ is called *good* for L , if $h(v_1, v_2) > h_1(v_1)$ and $h(v_1, v_2) > h_2(v_2)$. It is called *very good*, if both v and v^* are good.

Theorem 1.1.4. *Suppose that for a 2-component L -space link L there is a very good point $v \in \mathbb{Z}^2$. Then $\mathbf{LS}(L)$ is bounded from below, moreover,*

$$\mathbf{LS}(L) \subset \{(d_1, d_2) : d_1 > 0, d_2 > 0, d_1 d_2 > l^2\},$$

where l is the linking number between L_1 and L_2 .

The proof uses Heegaard Floer link homology, especially properties of the surgery complex developed in [22, 21].

Informally, Theorem 1.1.4 shows that ‘for most’ L -space links the set $\mathbf{LS}(L)$ is bounded from below. For algebraic links we will provide several characterizations of the boundedness property. The simplest case with $\mathbf{LS}(L)$ bounded from below is provided by the link of singularity $\{(x^2 - y^3)(x^3 - y^2) = 0\}$, consisting of two trefoils with linking number 4. See Figure 2 for the shape of $\mathbf{LS}(L)$. However, the above Theorem can also be used for non-algebraic links: see Example 8.1.1 for the Whitehead link, where the set \mathbf{LS} was already described in [21].

Still, there are large classes of L -space links such that $\mathbf{LS}(L)$ is unbounded from below.

Example 1.1.5. Suppose that K is an L -space knot, m and n are positive coprime integers and $n/m > 2g(K) - 1$. By [9], the two-component cable link $K_{2m, 2n}$ is an L -space link. Then the set $\mathbf{LS}(K_{2m, 2n})$ is unbounded from below. For the proof and for other examples see section 8.

1.2. For algebraic 2-component links the next Theorem 1.2.2 characterizes completely all cases when $\mathbf{LS}(L)$ is unbounded from below.

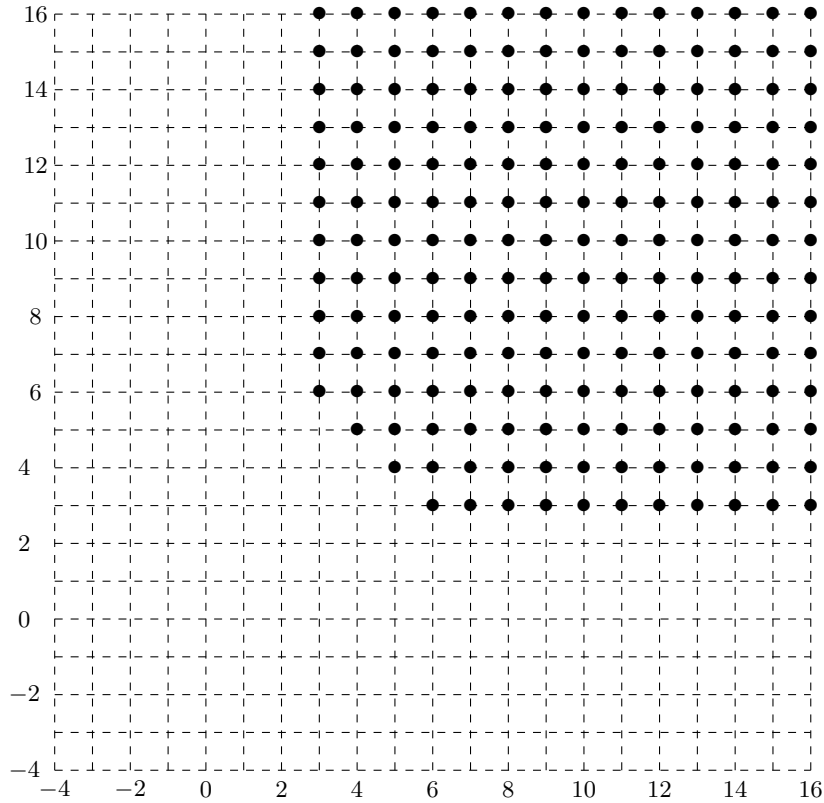

FIGURE 2. The set \mathbf{LS} for a pair of “transversal” trefoils with linking number 4

Consider a plane curve singularity germ $C = C_1 \cup C_2 \subset (\mathbb{C}^2, 0)$ with two components. Its intersection $L = L_1 \cup L_2$ with a small sphere centered at the origin is called an algebraic link. By [10] all algebraic links are L-space links.

Let $\Delta(t_1, t_2) = \sum a_{v_1, v_2} t_1^{v_1} t_2^{v_2} = \sum_{v \in \mathbb{Z}^2} a_v t^v$ denote the Alexander polynomial of $L = L_1 \cup L_2$. It is also a complete invariant of the embedded topological type [41]. For its relation with other invariants and several properties see [11]. The relation between Δ , the h -functions and the semigroup of the singularity is reviewed in Subsection 5.1. It is known that

$$(1.2.1) \quad a_v \in \{0, 1\} \text{ for all } v.$$

Define the set $\text{Supp}(\Delta) = \{v \in \mathbb{Z}^2 : a_v = 1\}$ and the partial order on \mathbb{Z}^2 by

$$(u_1, u_2) \preceq (v_1, v_2) \Leftrightarrow u_1 \leq v_1 \text{ and } u_2 \leq v_2.$$

We say that Δ is of *ordered type*, if for all $u, v \in \text{Supp}(\Delta)$ one has either $u \preceq v$ or $v \preceq u$.

Furthermore, each L_i is an iterated torus knot, and as such, whenever it is non-trivial there exists a unique integer m_i such that $S_{m_i}^3(L_i)$ is reducible. If L_i is the unknot then we set $m_i = 1$.

Theorem 1.2.2. *For a 2-component algebraic link L the following facts are equivalent:*

- (1) $\mathbf{LS}(L)$ is bounded from below;
- (2) the intersections of $\mathbf{LS}(L)$ with the lines $\{m_1\} \times \mathbb{Z}$ and $\mathbb{Z} \times \{m_2\}$ are both bounded from below,
- (3) there exists a very good point $v \in \mathbb{Z}^2$ for L ;
- (4) $\Delta(L)$ is not of ordered type.

The proof uses several ingredients, including theory of normal surface singularities and classification and properties of algebraic plane curve singularities. In fact, we even add another equivalent criterion to the above list, which is formulated in terms of the Artin's minimal cycle [1, 2] (associated with negative definite graph manifolds).

1.3. The organization of the paper is the following.

In section 2 we introduce notations and we recall basic facts regarding L -space links.

In section 3 we recall the needed results regarding Link Floer homology and surgery complexes (following [21] and [22]) and we prove Theorem 1.1.4.

In section 4 we treat the combinatorics of connected negative definite graphs. The interest in them is motivated by the fact that graph manifolds associated with such graphs are exactly the links of normal surface singularities. For such 3-manifold, by a result of second author [29], being an L -space can be reinterpreted by the 'rationality' of the graph (in the sense of Artin [1, 2]). We discuss properties of rational graphs, including Laufer's algorithm [17], one of the main tools of the present note. Here a key 'simplicity' property is also introduced.

We also prove the next general statement of independent interest (see section 4 for all necessary definitions).

Theorem 1.3.1. *Let Y be a graph manifold corresponding to the negative definite rational graph Γ , and let K_v be the knot in Y corresponding to a vertex v of Γ . Then $Y_d(K_v)$ is an L space for $d \ll 0$ if and only if the coefficient of E_v in the minimal cycle of Γ equals 1.*

In section 5 we discuss invariants of algebraic links: semigroup, Alexander polynomial, h -function, and several relations connecting them. We also establish certain 'arithmetical' properties of determinants of subgraphs, which will be crucial in the discussion of the orderability of the support of the Alexander polynomial.

In section 6 we characterize the $(d_1 \gg 0, d_2 \ll 0)$ region of $\mathbf{LS}(L)$ via the following results.

Theorem 1.3.2. (a) *Assume that $L \subset S^3$ is an L -space link with two components, and $S_{d_1, d_2}^3(L)$ is an L -space for some integers $d_1 \gg 0, d_2 \ll 0$. Then L_2 is an unknot.*

(b) *Assume that L is an algebraic link with two components associated with the curve singularity $(C, 0) \subset (\mathbb{C}^2, 0)$. Then the following facts are equivalent.*

- (1) *L_2 is an unknot, or equivalently, $(C_2, 0)$ is smooth;*
- (2) *$(d_1, d_2) \in \mathbf{LS}(L)$ for any $d_1 \gg 0$ and $d_2 \ll 0$;*
- (3) *$(d_1, d_2) \in \mathbf{LS}(L)$ for any $d_1 \geq m_1$ and $d_2 \ll 0$;*
- (4) *if Γ is the embedded resolution graph of $(C, 0) \subset (\mathbb{C}^2, 0)$, and v_2 supports the arrowhead of L_2 then v_2 is simple vertex of Γ .*

Some parts of Theorem 1.2.2 follow from the constructions and results established in different sections. Section 7 finishes the proof. In section 8 we present several examples illustrating the main results.

1.4. Recently appeared articles [13, 36, 37] discuss the set of *rational* L -space filling slopes $\mathbf{LS}_{\mathbb{Q}}(L) \subset \mathbb{Q}^2$ for a 3-manifold with torus boundary. Clearly, $\mathbf{LS}(L) = \mathbf{LS}_{\mathbb{Q}}(L) \cap \mathbb{Z}^2$. It follows from [36, Theorem 1.6] that every horizontal (or vertical) section of $\mathbf{LS}_{\mathbb{Q}}(L)$ is either empty, or it is an interval (maybe consisting of one point or half-infinite) or it is a complement to an interval. This result combined with our statement does not prove the analogue of Theorem 1.2.2 for $\mathbf{LS}_{\mathbb{Q}}(L)$. We will come back to this extension (and other relations with [36]) in a forthcoming work.

1.5. Acknowledgements. The authors are grateful to Jennifer Hom, Yajing Liu, Sarah Rasmussen and Jacob Rasmussen for the useful discussions. E. G. would like to thank Rényi Mathematical Institute (Budapest, Hungary) for the hospitality, and Russian Academic Excellence Project 5-100. Many computations of Heegaard Floer homology for surgeries on algebraic links were done with the help of the program [12] written by Jonathan Hanselman.

2. L-SPACES AND L-SPACE LINKS

2.1. L-spaces. Given a 3-manifold M , we denote by $\text{HF}^-(M)$ the minus version of its Heegaard Floer homology of M , cf. [35]. It canonically splits as a direct sum over the spin^c structures of M :

$$\text{HF}^-(M) = \bigoplus_{s \in H_1(M)} \text{HF}^-(M, s).$$

$\text{HF}^-(M)$ admits an action of an operator U of homological degree (-2) , which preserves this decomposition.

Definition 2.1.1. A rational homology sphere M is called an L-space, if $\text{HF}^-(M, s)$ is isomorphic as $\mathbb{F}[U]$ -module to $\mathbb{F}[U]$ for all s .

We are mostly interested in rational homology spheres, and specifically in graph manifolds. An important family of graph manifolds are given by links of complex normal surface singularities: they are graph manifolds associated with connected negative definite graphs. In this way the link constitute a bridge between topological and analytical invariants. This is reflected totally in the next characterization of L-spaces given by the second author.

Theorem 2.1.2 ([29]). *A graph manifold associated with a connected and negative definite plumbing graph is an L-space if and only if the graph is rational.*

Rational graphs are described in a purely combinatorial way, for more details see [1, 2, 17] and section 4 here. Since they are stable by taking subgraphs or decreasing the Euler decorations of the graph (see [17]), one has the following.

Corollary 2.1.3 ([29]). *Suppose that a negative definite graph Γ defines an L-space (e.g. it represents S^3). If Γ' is either a subgraph of Γ , or it is obtained from Γ by decreasing the Euler decorations, then Γ' defines an L-space too.*

In this note we focus on surgery 3-manifolds $S_{d_1, \dots, d_r}^3(L)$, where $L = \{L_i\}_{i=1}^r$ is a link of S^3 .

Definition 2.1.4. $L \subset S^3$ is called an L-space link, if the surgery manifold $S_d^3(L) = S_{d_1, \dots, d_r}^3(L)$ is an L-space for $d_i \gg 0$, $i = 1, \dots, r$.

The basic examples we treat are the algebraic links determined by (embedded) plane curve singularities (however several of our results generalise for arbitrary links as well). Algebraic plane curves are coded by their embedded resolution graphs, which are connected negative definite graphs (representing S^3) endowed with arrowhead vertices (representing the link components) [8, 30]. Usually if I is the intersection form of a graph Γ , then we define the determinant of Γ as $\det(\Gamma) := \det(-I)$. If the algebraic link is coded in the graph Γ , and the arrowhead of L_i is supported by the vertex v_i then we set $m_i := \det(\Gamma \setminus v_i)$.

Theorem 2.1.5 ([10]). *If L is an algebraic link, and $d_i > m_i$ for all i , then S_d^3 is an L-space.*

In fact, if the supporting vertices v_i are all distinct, then $S_d^3(L)$ is an L-space whenever $d_i \geq m_i$ for all i , cf. [10]. For algebraic links and for any $d \in \mathbb{Z}^r$, the surgery manifolds $S_d^3(L)$

are graph manifolds, see e.g. [26, 27]. The construction of these graphs runs as follows. Given a plane curve singularity C , consider its (not necessarily minimal) embedded good resolution obtained by a sequence of blowups. Let Γ be the dual graph and $\{v_i\}_i$ the supporting vertices of the arrowheads representing $\{L_i\}_i$ as above. Then we obtain the graph of $S_d^3(L)$ from Γ if we replace each arrowhead representing L_i by a genuine vertex (connected by an edge to v_i) and endow it with self-intersection $d_i - m_i$. (We supply here another interpretation of the integers m_i : if C_i is the curve component providing L_i , and v_i is the vertex representing the irreducible exceptional curve E_i , then m_i is the multiplicity along E_i of the total transform of C_i .)

2.2. Notations. Regarding links and their surgeries we adopt the following notations.

Define a partial order on \mathbb{Z}^r by $u \preceq v$ if $u_i \leq v_i$ for all i . For $u, v \in \mathbb{Z}^r$ set

$$\inf(u, v) := (\min(u_1, v_1), \dots, \min(u_r, v_r)), \quad \sup(u, v) := (\max(u_1, v_1), \dots, \max(u_r, v_r)).$$

If L is a link with r components then define L_K as the sub-link whose components are indexed by the subset $K \subset \{1, \dots, r\}$. Let l_{ij} denote the linking number between the components L_i and L_j ($i \neq j$). Following [15], to a vector (d_1, \dots, d_r) of surgery coefficients we associate the *framing matrix* $\Lambda = \Lambda(d)$ with entries

$$\Lambda_{ij} = \begin{cases} d_i & \text{if } i = j \\ l_{ij} & \text{if } i \neq j. \end{cases}$$

We will denote the i -th row of Λ by Λ_i , and for $K \subset \{1, \dots, r\}$ define $\Lambda_K := \sum_{i \in K} \Lambda_i$. E.g., for $r = 2$, we get (with $l = l_{12}$)

$$\Lambda = \begin{pmatrix} d_1 & l \\ l & d_2 \end{pmatrix}.$$

If $S_d^3(L)$ is a rational homology sphere then the order of its first homology is $|\det(\Lambda)|$.

We define the vector $c(L) = (c_1, \dots, c_r)$ by $c_i = 2g(L_i) + \sum_{j \neq i} l_{ij}$. Given $v \in \mathbb{Z}^r$, we set

$$v^* := c(L) - v.$$

For $K \subset \{1, \dots, r\}$, we define v_K as the projection of v to the coordinate subspace labeled by K . Finally, $\overline{K} := \{1, \dots, r\} \setminus K$. We work over the field $\mathbb{F} = \mathbb{Z}/2\mathbb{Z}$.

3. LINK FLOER HOMOLOGY AND SURGERIES ON L-SPACE LINKS

In this section we describe the multi-component version of the surgery complex, following [21] and [22]. We assume that L is an L-space link, then by [21, Lemma 1.10] all its sublinks L_K are L-space links too.

3.1. Link Floer homology. An r -component link L in S^3 defines a \mathbb{Z}^r filtration (called the Alexander filtration) on the Heegaard Floer complex for S^3 [32]. This filtration is usually labeled by the lattice

$$\mathbb{H}(L) := \mathbb{Z}^r + \ell, \quad \text{where } \ell := (l_1, \dots, l_r), \quad l_i = (\sum_{j \neq i} l_{ij})/2.$$

For every sublink $L_K \subset L$ there is a natural projection map

$$\pi_K : \mathbb{H}(L) \rightarrow \mathbb{H}(L_K), \quad \pi_K(v) = (v - \ell(L))_K + \ell(L_K).$$

However, by technical reasons (to match with the Hilbert function of algebraic links and with the notations of [11]) we prefer to work with the lattice \mathbb{Z}^r instead of $\mathbb{H}(L)$ and reverse the direction of the Alexander filtration. This is done via the map of lattices $\phi_L : \mathbb{H}(L) \rightarrow \mathbb{Z}^r$

$$(3.1.1) \quad v \mapsto \phi_L(v) := -v + c(L)/2.$$

Then in the following diagram of projections commute:

$$\begin{array}{ccc} \mathbb{H}(L) & \xrightarrow{\phi_L} & \mathbb{Z}^r \\ \pi_K \downarrow & & \downarrow v \mapsto v_K \\ \mathbb{H}(L_K) & \xrightarrow{\phi_{L_K}} & \mathbb{Z}^{|K|} \end{array}$$

With these notations, we define a subcomplex $A_{\overline{K}}^-(v) := A_{L_K}^-(v_K)$ for every $v \in \mathbb{Z}^r$, which depends only on the projection v_K onto the sublattice labeled by K . It is spanned by the generators with i -th Alexander filtration greater than or equal to v_i for all $i \in K$. It is known [32] that

$$(3.1.2) \quad A^-(v) \simeq A_{\overline{K}}^-(v) \text{ if } v_i \ll 0 \text{ for } i \notin K.$$

If L is an L-space link, it follows from [22, Theorem 10.1] that $H_*(A_{\overline{K}}^-(v)) \simeq \mathbb{F}[U][[-2h_K(v)]]$, where $h_K(v) = h_K(v_K)$ is a certain integer-valued function. (This is the definition of the h -function.) It is proven in [11] that this function is completely determined by the multi-variable Alexander polynomial of L_K . It follows from (3.1.2) (or see [11]) that

$$(3.1.3) \quad h(v) = h_K(v) \text{ if } v_i \ll 0 \text{ for } i \notin K.$$

The function h is weakly increasing:

$$h(v) \geq h(w) \text{ if } v \succeq w,$$

$h(v) \geq 0$ for all v , and

$$(3.1.4) \quad h_{K_2}(v) \geq h_{K_1}(v) \text{ if } K_1 \subset K_2.$$

We will also need the next symmetry property of the h -function (cf. [21, Lemma 5.5]):

$$(3.1.5) \quad h(v^*) = h(v) - |v| + |c(L)|/2.$$

Note that after applying ϕ_L , one gets $\phi_L(-v) = c(L) - \phi_L(v)$. This yields a simpler equation

$$h(\phi_L(-v)) = h(\phi_L(v)) + |v|,$$

which is more standard in Heegaard Floer literature.

3.2. Maps between subcomplexes. Let $z_K(v)$ denote the generator in the homology of $A_{\overline{K}}^-(v)$. For $K_1 \subset K_2$ the complex $A_{\overline{K_2}}^-(v)$ is a subcomplex of the complex $A_{\overline{K_1}}^-(v)$, so one can define the inclusion maps

$$j_{K_1, K_2} : A_{\overline{K_2}}^-(v) \hookrightarrow A_{\overline{K_1}}^-(v)$$

such that for $K_1 \subset K_2 \subset K_3$ one has $j_{K_1, K_2} \circ j_{K_2, K_3} = j_{K_1, K_3}$. It is proven in [11] that j_{K_1, K_2} does not vanish on homology, in fact,

$$(3.2.1) \quad j_{K_1, K_2}(z_{K_2}(v)) = U^{h_{K_2}(v) - h_{K_1}(v)} z_{K_1}(v).$$

Set, as above, the dual point $v^* = c(L) - v$. For every K , the dual point $(v_K)^* := c(L_K) - v_K$ of v_K is determined in the projected lattice $\mathbb{Z}^{|K|}$. From the definition directly follows the next

Lemma 3.2.2. $(v_K)^*$ and v^* are related by $(v_K)^* = (v^* - \Lambda_{\overline{K}})_{K_1}$.

One can also define another, the ‘dual’ map

$$j_{K_1, K_2}^\vee : A_{\overline{K_2}}^-((u_{K_2})^*) \rightarrow A_{\overline{K_1}}^-((u_{K_1})^*)$$

by the equation

$$(3.2.3) \quad j_{K_1, K_2}^\vee(z_{K_2}((u_{K_2})^*)) = U^{h_{K_2}(u) - h_{K_1}(u)} z_{K_1}((u_{K_1})^*).$$

Lemma 3.2.4. *For $K_1 \subset K_2$ the following equation holds:*

$$(3.2.5) \quad j_{K_1, K_2}^\vee(z_{K_2}(v)) = U^{h_{K_2}(v^* - \Lambda_{\overline{K_2}}) - h_{K_1}(v^* - \Lambda_{\overline{K_2}})} z_{K_1}(v - \Lambda_{K_2 - K_1}).$$

Proof. After substitution $u = w^*$ and applying Lemma 3.2.2 one transforms (3.2.3) into:

$$j_{K_1, K_2}^\vee(z_{K_2}(w - \Lambda_{\overline{K_2}})) = U^{h_{K_2}(w^*) - h_{K_1}(w^*)} z_{K_1}(w - \Lambda_{\overline{K_1}}).$$

Now substitute $w = v + \Lambda_{\overline{K_2}}$ and use $w^* = v^* - \Lambda_{\overline{K_2}}$ and $w - \Lambda_{\overline{K_1}} = v - \Lambda_{K_2 - K_1}$. \square

Example 3.2.6. If $i \in K$ then $j_{K-i, K}^\vee(z_K(v)) = U^{h_K(v^* - \Lambda_{\overline{K}}) - h_{K-i}(v^* - \Lambda_{\overline{K}})} z_{K-i}(v - \Lambda_i)$.

3.3. Surgery complex. The surgery complex is a direct sum $\mathcal{C} = \bigoplus_{K, v} A_K^-(v)$, see Figure 3. The differential consists of three parts: internal differential ∂_{in} defined in each $A_K^-(v)$, and “short” and “long” differentials acting between different $A_K^-(v)$. The “short” differential sends $A_K^-(v)$ to $A_{K-i}^-(v)$ via the map $j_{K-i, K}(v)$ for all $i \in K$. The “long” differential sends $A_K^-(v)$ to $A_{K-i}^-(v - \Lambda_i)$ and is given by the map $j_{K-i, K}^\vee(v)$ for all $i \in K$. We refer to [21, Lemma 5.5] for further details and for the proof of the duality between the “short” and “long” parts of the differential. The complex decomposes into a direct sum of $|\det \Lambda|$ subcomplexes corresponding to $spin^c$ -structures on the surgery manifold $S_d^3(L)$. We will write ∂_{ext} for the sum of “short” and “long” differentials, so that $\partial = \partial_{in} + \partial_{ext}$.

Remark 3.3.1. In [21, 22] and in the knot surgery formula (which may be more familiar to experts in Heegaard Floer homology) the “long” differential shifts the Alexander grading by Λ_i rather than $(-\Lambda_i)$. This difference is caused by the equation (3.1.1), which reverses the direction of all Alexander gradings.

If we take the homology of $A_K^-(v)$ at each vertex (i. e. with respect to ∂_{in}), we get at every place v a copy of $\mathbb{F}[U]$ generated by $z_K(v)$. On the homology of ∂_{in} the external differential ∂_{ext} (or ∂) induces the following differential (since we work over \mathbb{F} , we ignore the signs):

$$(3.3.2) \quad \partial(z_K(v)) = \sum_{i \in K} U^{h_K(v) - h_{K-i}(v)} z_{K-i}(v) + U^{h_K(v^* - \Lambda_{\overline{K}}) - h_{K-i}(v^* - \Lambda_{\overline{K}})} z_{K-i}(v - \Lambda_i).$$

The complex is absolutely graded, and ∂ has homological degree (-1) . It is important to note that in general this complex may not give the Heegaard-Floer homology due to the presence of the higher differentials. There is, however, a spectral sequence [19] such that $E_\infty = \text{HF}^-(S_d^3(L))$ and $E_2 = H_*(H_*(\mathcal{C}, \partial_{in}), \partial)$.

Theorem 3.3.3. ([21, Theorem 1.17]) *For two-component L -space links, the spectral sequence associated with the filtration on the link surgery complex degenerates at E_2 page, hence*

$$\text{HF}^-(S_{d_1, d_2}^3(L)) \simeq H_*(\mathcal{C}, \partial) \simeq H_*(H_*(\mathcal{C}, \partial_{in}), \partial).$$

The simplified surgery complex for a two-component L -space link is shown in Figure 4. Here

$$v^* = c(L) - v = (2g_1 + l - v_1, 2g_2 + l - v_2)$$

and, as above, g_i is the genus of a component L_i and l is the linking number between the components.

In what follows we will need some information about the absolute homological gradings on the surgery complex. These can be reconstructed from (3.3.2) and the following result.

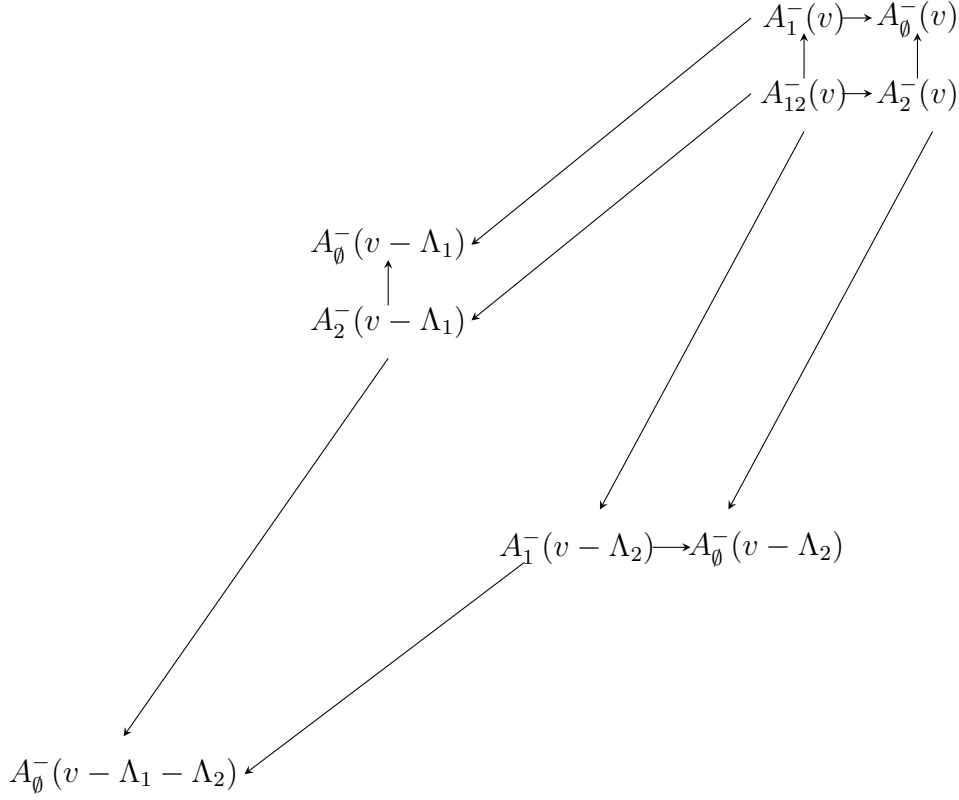

FIGURE 3. General scheme of Manolescu-Ozsváth surgery complex

Lemma 3.3.4. *For any fixed v and arbitrary u the absolute homological gradings of the generators z_\emptyset are given by the formula*

$$\deg(z_\emptyset(v + \Lambda u)) = (u, \Lambda u) + (\gamma, u) + \text{const},$$

where $\gamma = (2v_i - 2g_i + d_i)_{i=1}^r$ and the constant depends only on the class of the spin^c structure on $S_d^3(L)$ represented by v (that is, only on the sublattice $(v + \Lambda u)_u$).

Proof. Let us abbreviate $\deg(v) := \deg(z_\emptyset(v))$. Then, by (3.3.2),

$$\partial(z_{\{i\}}(v)) = U^{h_i(v)} z_\emptyset(v) + U^{h_i(v^* - \Lambda_{\{i\}})} z_\emptyset(v - \Lambda_i),$$

and two terms in the right hand side have the same homological degree. By Lemma 3.2.2 and (3.1.5) one has:

$$h_i(v^* - \Lambda_{\{i\}}) = h_i((v_i)^*) = h_i(2g_i - v_i) = h_i(v_i) + g_i - v_i.$$

Since $\deg(U) = -2$, it follows that

$$\deg(v - \Lambda_i) - \deg(v) = 2(g_i - v_i) = 2g_i - 2(e_1, v).$$

For $u \in \mathbb{Z}^2$ define $Q(u) := \deg(v + \Lambda u)$. Then

$$\begin{aligned} (3.3.5) \quad Q(u - e_i) - Q(u) &= \deg(v + \Lambda u - \Lambda_i) - \deg(v + \Lambda u) \\ &= 2g_i - 2(e_i, v + \Lambda u) = 2(g_i - v_i) - 2(e_i, \Lambda u). \end{aligned}$$

The equations (3.3.5) determine the function Q up to an overall constant (depending only on the lattice $(v + \Lambda u)_u$). It remains to notice that the quadratic function $Q'(u) := (u, \Lambda u) + (\gamma, u)$

$$\begin{array}{ccccc}
z_\emptyset(v - \Lambda_1) & \xleftarrow{h_1(v^* - \Lambda_2)} & z_{\{1\}}(v) & \xrightarrow{h_1(v)} & z_\emptyset(v) \\
\uparrow & & \uparrow & & \uparrow \\
& & h_2(v - \Lambda_1) & & h_2(v) \\
& & & & \\
& & h(v) - h_1(v) & & \\
& & & & \\
z_{\{2\}}(v - \Lambda_1) & \xleftarrow{h(v^*) - h_2(v^*)} & z_{\{1,2\}}(v) & \xrightarrow{h(v) - h_2(v)} & z_{\{2\}}(v) \\
\downarrow & & \downarrow & & \downarrow \\
& & h_2(v^*) & & h_2(v^* - \Lambda_1) \\
& & & & \\
& & h(v^*) - h_1(v^*) & & \\
& & & & \\
z_\emptyset(v - \Lambda_1 - \Lambda_2) & \xleftarrow{h_1(v^*)} & z_{\{1\}}(v - \Lambda_2) & \xrightarrow{h_1(v - \Lambda_2)} & z_\emptyset(v - \Lambda_2)
\end{array}$$

FIGURE 4. Powers of U in the surgery complex for a two-component L-space link

satisfies the same identities:

$$\begin{aligned}
Q'(u - e_i) - Q'(u) &= -2(e_i, \Lambda u) + (e_i, \Lambda e_i) - (\gamma, e_i) \\
&= -2(e_i, \Lambda u) + d_i - \gamma_i = 2(g_i - v_i) - 2(e_i, \Lambda u),
\end{aligned}$$

hence $Q(u) = Q'(u) + \text{const}$. □

Corollary 3.3.6. *The absolute homological gradings of the generators $z_K(v)$ are given by*

$$\begin{aligned}
\deg(z_K(v + \Lambda u)) &= \deg(z_\emptyset(v + \Lambda u)) - 2h_K(v + \Lambda u) + |K| \\
&= (u, \Lambda u) + (\gamma, u) - 2h_K(v + \Lambda u) + |K| + \text{const}.
\end{aligned}$$

Proof. We prove by induction on $|K|$ that

$$(3.3.7) \quad \deg(z_K(v)) = \deg(z_\emptyset(v)) - 2h_K(v) + |K|.$$

For $K = \emptyset$ the equation is clear. Assume that (3.3.7) holds for $K - i$, then (3.3.2) implies:

$$\deg(z_K(v)) - 1 = \deg(z_{K-i}(v)) - 2h_K(v) + 2h_{K-i}(v),$$

so (3.3.7) holds for K as well. □

3.4. Very good points and bounded surgeries. From now on we consider only links with two components.

Definition 3.4.1. Let us call a lattice point $v = (v_1, v_2) \in \mathbb{Z}^2$ *good* for an L-space link L , if $h(v) > h_1(v_1)$ and $h(v) > h_2(v_2)$, and *very good* for L , if both v and v^* are good for L .

The following theorem is one of the main results of the article.

Theorem 3.4.2 (Theorem 1.1.4). *Suppose that there exists a very good point for an L-space link L . Then for all L-space surgeries on L the framing matrix Λ is positive definite.*

Proof. Suppose that v is a very good point for L . Consider the surgery complex for a (d_1, d_2) -surgery of S^3 along L with $spin^c$ structure, corresponding to v . Since v is very good, all four numbers $h(v) - h_1(v)$, $h(v) - h_2(v)$, $h(v^*) - h_1(v^*)$, $h(v^*) - h_2(v^*)$ are strictly positive, hence the boundary $\partial(z_{\{1,2\}}(v))$ is divisible by U . Consider the cycle

$$Z(v) := U^{-1}\partial(z_{\{1,2\}}(v)).$$

One has $\partial Z(v) = 0$ and $UZ(v) \in \text{Im } \partial$. Since $S_d^3(L)$ is an L-space, its homology $H_*(\mathcal{C}, \partial)$ is isomorphic to $\mathbb{Z}[U]$, hence it has no nontrivial element annihilated by U . Hence, one should have $Z(v) = \partial\alpha$. Such an α must have the form

$$(3.4.3) \quad \alpha = \sum_{u \in \mathbb{Z}^2 \setminus (0,0)} U^{N(u)} z_{\{1,2\}}(v + \Lambda u)$$

for some $N(u) \geq 0$ (otherwise $\partial\alpha$ would contain more terms).

Let us compare the homological degrees in (3.4.3). By Corollary 3.3.6 we have

$$\begin{aligned} \deg(\alpha) &= \deg(z_{\{1,2\}}(v + \Lambda u)) - 2N(u) \leq \deg(z_{\{1,2\}}(v + \Lambda u)) \\ &= (u, \Lambda u) + (\gamma, u) - 2h(v + \Lambda u) + 2 + \text{const} \leq (u, \Lambda u) + (\gamma, u) + 2 + \text{const}. \end{aligned}$$

We conclude that the quadratic form $Q(u) = (u, \Lambda u) + (\gamma, u)$ is bounded from below on $\mathbb{Z}^2 \setminus \{(0, 0)\}$. Since this happens for any v (hence any γ), Λ must be positive definite. \square

Remark 3.4.4. One can apply a similar argument for knots, where the very good points can be defined by inequalities

$$h(v) > 0, \quad h(v^*) = h(2g - v) > 0.$$

However, for any L-space knot $h(v) > 0$ if and only if $v > 0$, and $h(v^*) > 0$ if and only if $v < 2g$. Therefore for any nontrivial L-space knot all points $v \in [1, 2g - 1]$ are very good. Similarly to Theorem 1.1.4, one proves that all L-space surgeries on a *nontrivial* L-space knot are positive (cf. Theorem 1.1.2).

Remark 3.4.5. At present, we cannot generalize Theorem 1.1.4 to the case of links with 3 or more components, since the cycle $Z(v)$ may be annihilated by a higher differential.

4. NEGATIVE DEFINITE GRAPH MANIFOLDS AND THEIR SURGERIES

4.1. Consider a rational homology sphere graph manifold Y corresponding to a negative definite plumbing graph Γ . Each vertex v defines a knot K_v in Y . The pair (Γ, v) and an integer d' determine another plumbing graph $\Gamma_{d'}$ constructed as follows. We add to the graph Γ (whose shape and decorations we keep) another new vertex, say v_{new} , with decoration d' (and genus zero), which is connected to vertex v by an edge. Then $\det(\Gamma_{d'}) = -d' \det(\Gamma) - \det(\Gamma \setminus v)$, denoted by $-d$ (recall that $\det(\Gamma) = \det(-I_\Gamma)$). Hence $\Gamma_{d'}$ is a negative definite graph whenever $d < 0$. This graph represents the surgery 3-manifold $Y_d(K_v)$. If $d \neq 0$ then $Y_d(K_v)$ is a rational homology sphere with $|H_1(Y_d(K_v))| = |d|$. (This is compatible with the construction from subsection 2.1, where $\det(\Gamma) = 1$ and $\det(\Gamma \setminus v_i) = m_i$.)

If Γ is any connected negative definite graph with vertices \mathcal{V} and plumbed 4-manifold $P(\Gamma)$, then its lattice L is $H_2(P(\Gamma), \mathbb{Z})$ with intersection form (\cdot, \cdot) . If $\{E_v\}_{v \in \mathcal{V}}$ denote the cores in $P(\Gamma)$, then $L = \mathbb{Z}\langle E_v \rangle_v$, and the intersection form I associated with Γ is exactly $(E_v, E_w)_{v,w}$.

The Lipman cone in L is defined (see e.g. [20, 27]) by

$$(4.1.1) \quad C(\Gamma) = \{Z \in L : (Z, E_v) \leq 0 \text{ for all } v \in \mathcal{V}\}.$$

The *minimal* (or fundamental) cycle $Z_{\min} = Z_{\min}(\Gamma)$ of Γ is the unique non-zero minimal element in $C(\Gamma)$, cf. [1, 2]. It is known (e.g. [2]) that if $Z = \sum_v n_v E_v \in C(\Gamma)$ then $n_v \geq 0$ for all v , and if additionally $Z \neq 0$ then $n_v > 0$ for all v . In particular $\sum_v E_v \leq Z_{\min} \leq Z$ for any $Z \in C(\Gamma)$.

The minimal cycle can be used to define *rational graphs* via *Laufer's Rationality Criterion* [17]. First we recall Laufer's algorithm, whose output is the minimal cycle. This provides a *computation sequence* $\{z_i\}_{i=0}^t \in L$, such that z_0 is one of the arbitrarily chosen base elements E_v , $z_t = Z_{\min}$, and $\{z_i\}_{i=0}^t$ is constructed inductively as follows [17]. Assume that z_i was already constructed. If $(z_i, E_v) \leq 0$ for all v then we stop: $i = t$, and $z_i = Z_{\min}$. If $(z_i, E_v) > 0$ for a certain v , then choose one of such vertices, say $v(i)$, and set $z_{i+1} = z_i + E_{v(i)}$, and restart the algorithm again. The procedure necessarily stops after finitely many steps, and the final z_t is always Z_{\min} (though the sequence is not necessarily unique).

Then, *Laufer's Rationality Criterion* says that Γ is rational if and only if along an arbitrarily chosen computation sequence (hence along all the computation sequences) at every step $i < t$ one has $(z_i, E_{v(i)}) = 1$, see [17]. (We will call the integers $(z_i, E_{v(i)})$ 'testing numbers'.)

It is not hard to verify using this criterion that rational graphs are stable by taking subgraphs or by decreasing the decorations of a graph. In both these two cases one can construct a computation sequence for a subgraph, or for a modified graph with decreased decorations, which is the (starting) part of a computation sequence of the original graph.

Definition 4.1.2. Fix a connected negative definite graph Γ . A vertex v of Γ is called *simple* if the coefficient of E_v in $Z_{\min}(\Gamma)$ equals 1.

Since $\sum_v E_v \leq Z_{\min} \leq Z$ for any $Z \in C(\Gamma)$, v is simple if and only if there exists $Z \in C(\Gamma)$, whose E_v -coefficient is 1.

The following theorem describes when the set of L-space surgeries of Y along K_v is bounded. (Recall, see Theorem 2.1.2, that a negative definite graph Γ defines an L-space if and only if Γ is rational.)

Theorem 4.1.3. *Assume that Γ is a negative definite rational graph (so Y is an L-space). Then the following statements hold:*

- a) For $d \gg 0$, $Y_d(K_v)$ is an L-space.
- b) For $d \ll 0$, $Y_d(K_v)$ is an L-space if and only if v is a simple vertex of Γ .

Proof. Note that $d \gg 0$ (resp. $d \ll 0$) if and only if $d' \gg 0$ (resp. $d' \ll 0$). The proof of (a) is identical to the proof of the main theorem of [10]. Next we prove (b). Since for $d' \ll 0$ the graph $\Gamma_{d'}$ is negative definite, the statement transforms into the rationality of $\Gamma_{d'}$.

Let n denote the coefficient of E_v in Z_{\min} .

Suppose that $\Gamma_{d'}$ is rational. Let us run Laufer's algorithm for $Z_{\min}(\Gamma_{d'})$ in such a way that z_0 is a base element of $L(\Gamma)$ and at all steps we choose $E_{v(i)}$ from the support of Γ whenever is possible. Then at an intermediate steps we have $x_i = Z_{\min}(\Gamma)$. The next choice is necessarily $E_{v(i)} = E_{new}$, and the Laufer's testing number is $(x_i, E_{new}) = (Z_{\min}(\Gamma), E_{new}) = n$. Hence $n = 1$ by Laufer's Criterion. See also [18, Corollary 4.1].

In fact, we proved the following *general fact*: if Δ is a subgraph of a rational graph Δ' , and (v, v') is an edge in Δ' such that $v \in \Delta$ but $v' \notin \Delta$, then the E_v -coefficient of $Z_{\min}(\Delta)$ is 1.

Conversely, assume that $n = 1$, and we prove that $\Gamma_{d'}$ is rational for $d' \ll 0$. This essentially follows from [18, Theorem 4.8], but we present here a slightly shorter proof (adopted to this situation) for the reader's convenience. Following [38, 40] we introduce some notations.

For any graph G , we say that $u \in \mathcal{V}(G)$ is a *Tjurina vertex* of G if $(Z_{\min}(G), E_u) = 0$.

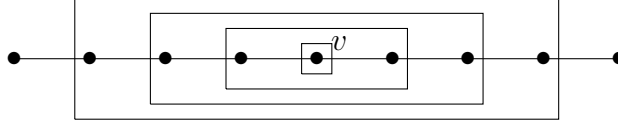
FIGURE 5. Resolution of A_9 singularity and the subgraphs Δ_i

Let Δ_1 be the connected component of the set of Tjurina vertices of Γ (as full subgraph), which contains v (if v is not a Tjurina vertex, $\Delta_1 = \emptyset$). $\Delta_1 \subsetneq \Gamma$ since $(Z_{\min}(\Gamma), E_u)$ cannot be zero for all $u \in \mathcal{V}(\Gamma)$. Let Δ_2 be the connected component of the set of Tjurina vertices of Δ_1 , which contains v etc. By repeating this procedure, we obtain a sequence of properly nested subgraphs:

$$\Gamma \supsetneq \Delta_1 \supsetneq \Delta_2 \supsetneq \dots \supsetneq \Delta_k = \emptyset.$$

We claim that if $d' \leq -k$ and $\Gamma_{d'}$ is negative definite then $\Gamma_{d'}$ is rational. Indeed, let us run the Laufer's algorithm for $\Gamma_{d'}$. We start with $z_0 = E_{new}$, hence $z_1 = E_{new} + E_v$. Then the next few steps are identical with the steps of the algorithm for Γ , hence at some point we obtain the cycle $z_s = E_{new} + Z_{\min}(\Gamma)$. (The assumption is used here: since the E_v -multiplicity in $Z_{\min}(\Gamma)$ is 1, during the steps between $E_{new} + E_v$ and $E_{new} + Z_{\min}(\Gamma)$ we do not need to add E_v , hence we never test for (x_i, E_v) , which is changed by the presence of E_{new} .) Note that $(z_s, E_u) = (Z_{\min}, E_u) \leq 0$ for $u \in \mathcal{V} \setminus v$ and $(z_s, E_{new}) = 1 + d' \leq 0$. If v is not a Tjurina vertex for Γ , we have $(Z_{\min}(\Gamma), E_v) \leq -1$, hence $(z_s, E_v) \leq 0$, and the algorithm stops, $Z_{\min}(\Gamma_{d'}) = E_{new} + Z_{\min}(\Gamma)$ with testing numbers 1 along all the steps. If v is a Tjurina vertex for Γ , we need to continue with $z_{s+1} = z_s + E_v$ (whose testing number is 1 again). Then along the next few steps we choose $v(i)$ imposed by the algorithm of $Z_{\min}(\Delta_1)$. Hence, we will arrive at the cycle $z_{s'} = E_{new} + Z_{\min}(\Gamma) + Z_{\min}(\Delta_1)$. This cycle satisfies $(z_{s'}, E_u) \leq 0$ for $u \in \mathcal{V} \setminus v$ (even for $v \in \mathcal{V}(\Gamma \setminus \Delta_1)$) thanks to the above *general fact* regarding subgraphs of rational graphs, applied for the pair $\Delta_1 \subset \Gamma$. Furthermore, $(z_{s'}, E_{new}) = 2 + d' \leq 0$ too (since $Z_{\min}(\Delta_1) \leq Z_{\min}(\Gamma)$, hence both have E_v -coefficient 1). Thus the only vertex that eventually needs correction is v . Note that again $(z_{s'}, E_v) = (E_{new}, E_v) + (Z_{\min}(\Gamma) + Z_{\min}(\Delta_1), E_v) \leq 1$. We repeat this procedure until we get the cycle

$$z_t = E_{new} + Z_{\min}(\Gamma) + Z_{\min}(\Delta_1) + \dots + Z_{\min}(\Delta_{k-1}).$$

Then, $(x_t, E_u) \leq 0$ for all vertices of $\Gamma_{d'}$, hence $z_t = Z_{\min}(\Gamma_{d'})$. Since along all the steps the testing numbers $(x_i, E_{v(i)}) = 1$, $\Gamma_{d'}$ is rational. \square

Example 4.1.4. Consider the plumbing graph for the lens space $L(10, 9)$ (or A_9 singularity) shown in Figure 5 (nine (-2) -vertices). Its minimal cycle has coefficient 1 at each vertex. One can check that a d -surgery on its central vertex v is an L -space if and only if $d' \in (-\infty, -4] \cup [-1, +\infty)$. The rectangles represent the subgraphs Δ_i appearing in the proof of Theorem 4.1.3. (Note that Γ_{-3} is negative definite but not rational.)

Remark 4.1.5. (*Analytic interpretation of simple vertices.*) Assume that (X, o) is a rational complex normal surface singularity (that is, its geometric genus is zero, or equivalently, any of its good resolution graphs is rational). Let $(C, o) \subset (X, o)$ be an irreducible curve in it. Assume that Γ is the resolution graph of a good embedded resolution $\tilde{X} \rightarrow X$ (that is, the total transform of C is a normal crossing divisor). Let E_v be the irreducible exceptional curve, which intersects the strict transform of (C, o) . Then the vertex v is simple if and only if (C, o) is smooth. Indeed, for rational singularities the pull-back of the maximal ideal of $\mathcal{O}_{X,o}$ is $\mathcal{O}_{\tilde{X}}(-Z_{\min})$ and it has no basepoint [1, 2]. Hence, the multiplicity of (C, o) (that is, the intersection of (C, o) with

a generic linear form) is the E_v -multiplicity of $Z_{\min}(\Gamma)$. But $\text{mult}_o(C, o) = 1$ if and only if (C, o) is smooth.

5. INVARIANTS OF ALGEBRAIC LINKS

5.1. Semigroup, Alexander polynomial and the h -function. Let $C = C_1 \cup C_2 \subset (\mathbb{C}^2, 0)$ be a plane curve singularity with 2 components. Let $L = L_1 \cup L_2 \subset S^3$ be the corresponding link. Let $\gamma_i : (\mathbb{C}, 0) \rightarrow (C_i, 0)$ be the normalization of C_i .

Definition 5.1.1. For any function $f \in \mathbb{C}\{x, y\}$ set $\nu_i(f) = \text{ord}_t(f(\gamma_i(t)))$. The semigroup S_C of the germ C is the set of pairs $(\nu_1(f), \nu_2(f)) \in (\mathbb{Z}_{\geq 0})^2$ for all $f \in \mathbb{C}\{x, y\}$.

One defines similarly the semigroup of a one-component curve. If C_1 is a component of $C = C_1 \cup C_2$ then S_{C_1} is the image of the first projection of S_C .

In the next proposition K is an algebraic knot, S is the semigroup of the corresponding curve-germ, $\Delta(t)$ is the Alexander polynomial of K . It is well-known that the degree μ of $\Delta(t)$ is twice the genus of K .

Proposition 5.1.2. [6] *With these notations the following statements hold. For $s \geq \mu$ one has $s \in S$ (in fact, μ is optimal with this property, that is, μ is the conductor of S), and $\sum_{s \in S} t^s = \Delta(t)/(1-t)$.*

Corollary 5.1.3. *For any $M \geq \mu$ all the coefficients of the polynomial $\Delta(t) \cdot \frac{1-t^M}{1-t}$ are equal to 0 or 1. If $\mu \leq s < M$ then the coefficient at t^s in this polynomial equals 1.*

5.2. We will also need the following facts about two-component algebraic links (see [6, 11] and references therein):

- (1) The topologically defined h -function (cf. 3.1) of an algebraic link coincides with the (analytic) Hilbert function of C and it is determined by the semigroup as follows: $h(v_1 + 1, v_2) = h(v_1, v_2) + 1$, if there exists $u \in S_C$ such that $u_1 = v_1$ and $u_2 \geq v_2$. Otherwise $h(v_1 + 1, v_2) = h(v_1, v_2)$. The difference $h(v_1, v_2 + 1) - h(v_1, v_2)$ can be described in a similar way.
- (2) If $u, v \in S_C$ then $\inf(u, v) \in S_C$ as well. Hence $v \in S_C$ if and only if

$$h(v_1 + 1, v_2) = h(v_1, v_2 + 1) = h(v_1, v_2) + 1.$$

- (3) A coefficient a_v ($v = (v_1, v_2)$) of $t_1^{v_1} t_2^{v_2}$ in the Alexander polynomial equals

$$a_v = h(v_1 + 1, v_2) + h(v_1, v_2 + 1) - h(v_1, v_2) - h(v_1 + 1, v_2 + 1).$$

Using the above description of $h(v)$, one can check that

$$a_v = \begin{cases} 1 & \text{if } h(v_1 + 1, v_2) = h(v_1, v_2 + 1) = h(v_1 + 1, v_2 + 1) = h(v_1, v_2) + 1, \\ 0 & \text{otherwise.} \end{cases}$$

- (4) In particular, if $a_v = 1$ (so $v \in \text{Supp}(\Delta)$) then v belongs to the semigroup of C . Furthermore, $v \in \text{Supp}(\Delta)$ if and only if $v \in S_C$, and $S_C \cap \{(v_1, u_2) : u_2 > v_2\} = S_C \cap \{(u_1, v_2) : u_1 > v_1\} = \emptyset$. This also shows that $\text{Supp}(\Delta)$ cannot have distinct pairs u, v with $u_1 = v_1$ or with $u_2 = v_2$.
- (5) Using (3.1.5), $v \in \text{Supp}(\Delta)$ if and only if $v \in S_C$ and $v^* - \mathbf{1} \in S_C$. (Here $\mathbf{1} = (1, 1)$.) Hence $v \in \text{Supp}(\Delta)$ if and only if $c - \mathbf{1} - v \in \text{Supp}(\Delta)$.
- (6) $h(v) = h(\text{sup}(v, (0, 0)))$, and the h -functions for the components of L are given by:

$$h_1(v) = h(v_1, 0), \quad h_2(v) = h(0, v_2).$$

Lemma 5.2.1. *A point $v = (v_1, v_2)$ is good for an algebraic link L if and only if there exist semigroup points*

$$a \in [v_1, +\infty) \times [0, v_2 - 1] \text{ and } b \in [0, v_1 - 1] \times [v_2, +\infty).$$

Proof. Consider the difference

$$h(v) - h_1(v) = h(v_1, v_2) - h(v_1, 0) = \sum_{j=0}^{v_2-1} (h(v_1, j+1) - h(v_1, j)).$$

In the last sum each summand is either equal to 0 or to 1, hence $h(v) - h_1(v) > 0$ if and only if $h(v_1, j+1) - h(v_1, j) = 1$ for at least one $j \in [0, v_2 - 1]$. The latter equation holds if there is a semigroup point $a = (a_1, a_2)$ such that $a_1 \geq v_1$ and $a_2 = j$. \square

Lemma 5.2.2. *If the Alexander polynomial Δ is not of ordered type then there is a very good point for L .*

Proof. Suppose that the Alexander polynomial Δ is not of ordered type. This means that there are points $u = (u_1, u_2), v = (v_1, v_2) \in \text{Supp}(\Delta)$ such that $u_1 < v_1$ but $u_2 > v_2$.

Since u and v are both in the semigroup, by Lemma 5.2.1 all points w satisfying

$$(5.2.3) \quad \inf(u, v) + \mathbf{1} \preceq w \preceq \sup(u, v)$$

are good. Furthermore, by the symmetry of Δ , the points $c - \mathbf{1} - u$ and $c - \mathbf{1} - v$ belong to its support too, and clearly

$$\inf(c - \mathbf{1} - u, c - \mathbf{1} - v) + \mathbf{1} \preceq c - w \preceq \sup(c - \mathbf{1} - u, c - \mathbf{1} - v),$$

hence $w^* = c - w$ is a good point too. Therefore any w satisfying (5.2.3) is very good. \square

Lemma 5.2.4. *Suppose that $0 < v_1 < l := \text{lk}(L_1, L_2)$ and v_1 belongs to the semigroup of C_1 . Then there exists $v_2 > 0$ such that $(v_1, v_2) \in \text{Supp}(\Delta)$.*

Proof. By Torres formula [39]

$$(5.2.5) \quad \Delta(t, 1) = \frac{\Delta_1(t)}{1-t} \cdot (1-t^l),$$

where $\Delta_1(t)$ is the Alexander polynomial of L_1 . By Proposition 5.1.2 the coefficient of t^{v_1} in $\frac{\Delta_1(t)}{1-t}$ equals 1. Since $v_1 < l$, the coefficient of t^{v_1} in polynomial from the right hand side of (5.2.5) equals 1 as well. But this number, read from the left hand side of (5.2.5), is

$$\sum_{v_2 > 0} a_{v_1, v_2} = |\{v_2 : (v_1, v_2) \in \text{Supp}(\Delta)\}|. \quad \square$$

5.3. The Alexander polynomial from resolution graphs. Let Γ be the dual graph (with non-arrowhead vertices \mathcal{V} and two arrowheads) of a good embedded resolution of $(C, 0) \subset (\mathbb{C}^2, 0)$. Let I be the intersection matrix and define m_{vw} as the (v, w) -entry of $-I^{-1}$. It is well known that $m_{vw} \geq 0$ (see also 5.4.1(b) below). If v_1 and v_2 support the arrowheads corresponding to the link components, and δ_w denotes the valency of the non-arrowhead vertex w (including the arrowhead supporting edges) then (see e.g. [8])

$$(5.3.1) \quad \Delta(t_1, t_2) = \prod_{u \in \mathcal{V}} (1 - t_1^{m_{uv_1}} t_2^{m_{uv_2}})^{\delta_u - 2}.$$

Sometimes (for brevity) we use splice diagrams instead of resolution (for their definition, properties and equivalence with resolution graphs, see [8]). They can be obtained as follows: one erases all two-valent vertices from Γ and write on the u -end of an edge (u, v) of the resulting

graph the determinant of the connected component of $\Gamma - u$ containing v (see also figures below). By Lemma 5.4.1(b) and (5.3.1) this data is sufficient to recover the Alexander polynomial from the splice diagram (see also [8]).

5.4. Determinantal properties of resolution graphs. We will need several arithmetical properties of the multiplicities m_{vw} (and of the decorations of the splice diagrams). We list here some of them. Recall that by our convention $\det(G) = \det(-I_G)$ and $\det(\emptyset) = 1$. Hence $\det(G) > 0$ for any subgraph G of Γ . Moreover $\det(\Gamma) = 1$.

Consider a decomposition of a negative definite connected graph \tilde{G} (with no arrowheads) shown in Figure 6, and let \overline{uv} denote the shortest path in G connecting u and v . (If G is merely an edge then its determinant is 1.) Set also

$$\det(G') = a, \det(G \cup G'' \cup v) = p, \det(G'') = p', \det(G \cup G' \cup u) = a', \det(G - \overline{uv}) = g.$$

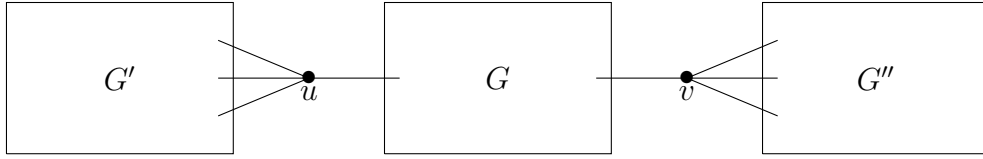

FIGURE 6. Decomposition of Γ in Lemma 5.4.1

Part (a) of the next Lemma is proved in [5, Lemma 4.0.1], part (b) in [8].

Lemma 5.4.1. (a) $\det(G) \cdot \det(\tilde{G}) = a'p - ap'g^2$.

(b) If $\tilde{G} = \Gamma$ then $m_{uv} = \det(\Gamma - \overline{uv}) = ap'g$.

Lemma 5.4.2. Consider again Figure 6 with a, p, a', p' as above. Assume that $\det(\tilde{G}) = 1$ and $G - \overline{uv} = \emptyset$ (so $g = 1$). Then there exists positive integers z and w such that

$$(5.4.3) \quad \frac{a'}{p'} > \frac{z}{w} > \frac{a}{p},$$

i.e., (zp, zp') and (wa, wa') are not comparable with respect to the partial order of \mathbb{Z}^2 . Additionally,

$$(5.4.4) \quad \begin{cases} (a) \text{ if } E_u^2 = -1 \text{ and } G' \text{ is connected then } z < a, \\ (b) \text{ if } E_v^2 = -1 \text{ and } G'' \text{ is connected then } w < p'. \end{cases}$$

Proof. Let u', v' be the neighbors of u and v in G , respectively (they may coincide). Set $z_1 = \det(G' \cup u)$ and $w_1 = \det(G'' \cup v \cup G \setminus u')$. If we apply Lemma 5.4.1(a) to u' and v we get

$$a'w_1 - z_1p' = \det(G - u') > 0 \Rightarrow \frac{a'}{p'} > \frac{z_1}{w_1}.$$

If we apply Lemma 5.4.1(a) to u' and u we obtain

$$pz_1 - aw_1 = \det(\emptyset) = 1 > 0 \Rightarrow \frac{z_1}{w_1} > \frac{a}{p}.$$

By similar computation for $w_2 = \det(G'' \cup v)$ and $z_2 = \det(G' \cup u \cup G \setminus v')$ we get that both pairs (z_1, w_1) and (z_2, w_2) satisfy (5.4.3).

In the situation of (5.4.4)(a), if u'' is the neighbour of u in G' then (5.4.1)(a) applied for $\tilde{G} = G' \cup u$ gives $z_1 = a - \det(G' - u'') < a$. Hence (z_1, w_1) satisfies all wished properties.

In case (b) similarly $w_2 < p'$, hence (z_2, w_2) satisfies the needed properties.

Finally, assume that both assumptions of (a) and (b) are satisfied. Then, if $w_1 < p'$ then (z_1, w_1) satisfies all requirements, if $z_2 < a$ then (z_2, w_2) works; and if $z_2 \geq a$ and $w_1 \geq p'$ then $z_2 \geq a > z_1$ and $w_1 \geq p' > w_2$ and (z_1, w_2) is the right choice. \square

6. LINKS WITH A TRIVIAL COMPONENT

6.1. In Figures 1 and 2 the sets $\mathbf{LS}(L)$ do not contain points where the surgery coefficients have large absolute values of opposite signs. The following results confirms that this is typical for $\mathbf{LS}(L)$.

Theorem 6.1.1. *Suppose that $L \subset S^3$ is an L-space link with two components, $d_1 \gg 0, d_2 \ll 0$ and $S_{d_1, d_2}^3(L)$ is an L-space. Then L_2 is an unknot.*

Proof. By [21, Theorem 1.10] both components L_1 and L_2 are L-space knots. Consider the 3-manifold $Y = S_{d_2}^3(L_2)$, then $S_{d_1, d_2}^3(L) = Y_{d_1}(L_1)$ is a large surgery on Y along a knot L_1 . By [33, 22] if $Y_{d_1}(L_1)$ is an L-space for $d_1 \gg 0$, then Y itself is an L-space. Hence $S_{d_2}^3(L_2)$ is an L-space. Suppose that L_2 is nontrivial. Then by Theorem 1.1.2 $S_{d_2}^3(L_2)$ is an L-space if and only if $d_2 \geq 2g(L_2) - 1$, which contradicts $d_2 \ll 0$. \square

For algebraic links we have the following complete characterization.

Theorem 6.1.2. *Suppose that L is an algebraic link with two components associated with the curve singularity $(C, 0) \subset (\mathbb{C}^2, 0)$. Then the following facts are equivalent.*

- (1) L_2 is an unknot, or equivalently, $(C_2, 0)$ is smooth;
- (2) $(d_1, d_2) \in \mathbf{LS}(L)$ for any $d_1 \gg 0$ and $d_2 \ll 0$;
- (3) $(d_1, d_2) \in \mathbf{LS}(L)$ for any $d_1 \geq m_1$ and $d_2 \ll 0$;
- (4) if Γ is the embedded resolution graph of $(C, 0) \subset (\mathbb{C}^2, 0)$, and v_2 supports the arrowhead of L_2 then v_2 is simple vertex of Γ .

Proof. (2) \Rightarrow (1) follows from Theorem 6.1.1, (3) \Rightarrow (2) is evident, (4) \Leftrightarrow (1) follows from Remark 4.1.5. Hence we have to prove (1) \Rightarrow (3). We proceed similarly to the proof of the main theorem in [10]. We can assume that the self-intersection of v_1 in Γ is -1 . Recall from 2.1 that the graph of the surgery manifold is obtained from Γ by adding two additional vertices with framings $d_1 - m_1$ and $d_2 - m_2$ glued to the vertices v_1 and v_2 . Assume first that $d_1 > m_1$. By plumbing calculus we can replace the first new vertex by the chain of (-2) -vertices. Let us call the resulting graph by Γ' .

Let us add an extra (-1) -vertex to the end of this chain, and call the graph with this extra vertex Γ'_{-1} . By consecutively blowing down this (-1) -vertex and the chain of (-2) -vertices, we obtain a graph representing $S_{d_2}^3(L_2) = L(d_2, 1)$. For $d_2 \ll 0$ we conclude that Γ'_{-1} is negative definite and rational. But Γ' is a subgraph of Γ'_{-1} , so it is rational too.

If $d_1 = m_1$ then by plumbing calculus one can delete the zero-vertex and its support vertex v_1 , hence we need to show that the surgery along v_2 of $\Gamma \setminus v_1$ is rational. But v_2 is simple in Γ (by (4) \Leftrightarrow (1)), hence it is simple in $\Gamma \setminus v_1$ too. Hence we can conclude by Theorem 4.1.3. \square

Corollary 6.1.3. *If L is an algebraic link with two components and (at least) one of the components is unknot then $\mathbf{LS}(L)$ is not bounded from below.*

Remark 6.1.4. By the classification of algebraic knots (or by Proposition 5.1.2) L_2 is unknot if and only if its Alexander polynomial $\Delta_2(t) = 1$. Hence, by formula of Torres [39], this happens exactly when $\Delta(1, t) = (1 - t^l)/(1 - t)$, where l is the linking number.

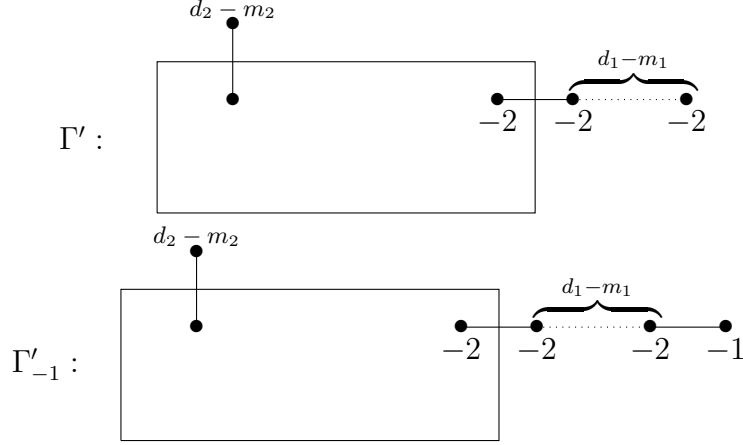
FIGURE 7. The graphs Γ (top) and Γ' (bottom)7. WHEN IS $\mathbf{LS}(L)$ BOUNDED FROM BELOW?

7.1. In this section we provide several characterizations of the boundedness from below of $\mathbf{LS}(L)$ for algebraic links (in particular, we prove Theorem 1.2.2).

Let Γ be the dual graph of the minimal good embedded resolution of C [8]. If the strict transforms of C_1 and C_2 intersect the same irreducible exceptional component, say E_v , then we call C_1 and C_2 (and L_1 and L_2) *parallel*. Otherwise the strict transforms of C_1 and C_2 intersect transversally two different components, let their index be v_1 and v_2 .

Theorem 7.1.1. *For a 2–component algebraic link L the following facts are equivalent:*

- (1) *the intersections of $\mathbf{LS}(L)$ with lines $\{m_1\} \times \mathbb{Z}$ and $\mathbb{Z} \times \{m_2\}$ are both bounded from below;*
- (2) *$\mathbf{LS}(L)$ is bounded from below;*
- (3) *there exists a very good point $v \in \mathbb{Z}^2$ for L ;*
- (4) *$\Delta(L)$ is not of ordered type;*
- (5) *L is not parallel, and the vertex v_1 is not simple in the graph $\Gamma \setminus v_2$, and v_2 is not simple in the graph $\Gamma \setminus v_1$ (in the sense of Definition 4.1.2).*

7.2. First we outline its proof. Part (2) \Rightarrow (1) is clear, (3) \Rightarrow (2) follows from Theorem 1.1.4, (4) \Rightarrow (3) is proven in Lemma 5.2.2. Part (1) \Rightarrow (5) will follow from the next Lemma.

Lemma 7.2.1. *a) If C_1 and C_2 are parallel then Δ is of ordered type, and $m_1 = m_2$, and $(\{m_1\} \times \mathbb{Z}) \cup (\mathbb{Z} \times \{m_2\}) \setminus (m_1, m_2) \subset \mathbf{LS}(L)$.*

b) If v_2 is a simple vertex for $\Gamma \setminus v_1$ then $\mathbf{LS}(L) \cap (\{m_1\} \times \mathbb{Z})$ is unbounded from below.

In fact, the previous implications together with Lemma 7.2.1 finish completely the case of parallel components. Finally, it remains to prove (5) \Rightarrow (4) in the non–parallel case.

Proof of Lemma 7.2.1. (a) Consider the surgery manifold $S^3_{m_1, d_2}(L)$. It is represented by a graph Γ with two additional vertices with decorations 0 and $d_2 - m_2$, connected to v . By 0–splitting (cf. [30]) the first new vertex together with v can be deleted, and we remain with the rational graph $\Gamma \setminus v$ and another component consisting of a single vertex decorated by $d_2 - m_2$, which is a lens space whenever $d_2 \neq m_2$. Furthermore, by (5.3.1), $\text{Supp}(\Delta)$ sits on a line.

(b) Consider again $S^3_{m_1, d_2}(L)$. By 0–splitting (of the first new vertex) this is equivalent with the surgery of $\Gamma \setminus v_1$ along v_2 . But this is rational for $d_2 \ll 0$ by Theorem 4.1.3. \square

7.3. The remained implication (5) \Rightarrow (4) (for non-parallel case) will be proved in two steps. We need to prove that whenever $v_1 \neq v_2$ and if v_i is not simple in $\Gamma \setminus v_j$ ($(i, j) = (1, 2)$ or $(2, 1)$) then Δ is not ordered. First we consider that particular family of graphs when both v_1 and v_2 are (-1) -vertices. In this case the assumption is satisfied. Indeed, the two (-1) -vertices cannot be adjacent (since Γ is negative definite), hence v_1 has at least two adjacent vertices in $\Gamma \setminus v_2$. Since any multiplicity of the minimal cycle is at least one, a (-1) -vertex with at least two neighbors cannot have multiplicity one in the minimal cycle (cannot be in the Lipman cone).

The first step of (5) \Rightarrow (4) is the following.

Theorem 7.3.1. *Assume that the two components of L are not parallel, and both arrowheads are supported by (-1) -vertices. Then Δ is not of ordered type.*

Proof of Theorem 7.3.1. It is convenient to use the following terminology, which helps to test Alexander polynomials of non-ordered type. A polynomial $\Delta \in \mathbb{Z}[t_1, t_2]$ is an extension of $\Delta' \in \mathbb{Z}[t_1, t_2]$, if there exist polynomials $P_1, \dots, P_N \in \mathbb{Z}[t_1, t_2]$, such that $\Delta = P_1 \cdots P_N \cdot \Delta'$, and all the non-zero coefficients of all the P_i 's and Δ' are positive. We call the polynomials P_i *extension factors*. Since any coefficients of Δ is 0 or 1, any non-zero monomial of $P_1 \cdots P_N$ gives a shifted copy of $\text{Supp}(\Delta')$ is $\text{Supp}(\Delta)$. In particular, if Δ' is not of ordered type, then Δ necessarily is not of ordered type as well.

We need to discuss two families of splice diagrams following [8, App. to Ch. I]. Recall (cf. [8]) that m_{uv} (needed in the formula of Δ) reads from the diagram as the product of decorations along but not on the path connecting v_i and v_j .

(I) The first one has the following form with $s > n$ and $r > n$ (these inequalities imply that the supporting vertices are automatically (-1) -vertices in Γ):

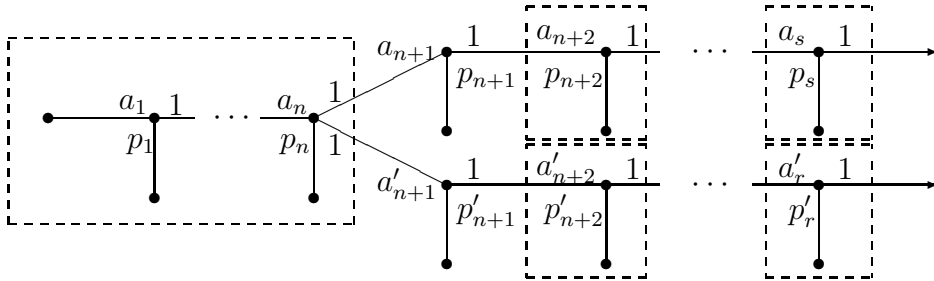

We decompose the set of vertices in several disjoint subsets, accordingly Δ will be a product of polynomials. The contribution of the vertices from the left dash-box is $P_0(t_1, t_2) = \tilde{P}_0(t_1^{p_{n+1} \cdots p_s} \cdot t_2^{p'_{n+1} \cdots p'_r})$, where

$$\tilde{P}_0(t) = \frac{(t^{a_1 p_1 \cdots p_n} - 1)(t^{a_2 p_2 \cdots p_n} - 1) \cdots (t^{a_n p_n} - 1)^2}{(t^{p_1 \cdots p_n} - 1)(t^{a_1 p_2 \cdots p_n} - 1) \cdots (t^{a_n} - 1)}.$$

Note that $\tilde{P}_0(t_1, t_2)$ is the Alexander polynomial of the link (with parallel components), determined by the diagram in the dash-box (and its two arrows correspond to the cutting edges). Hence, by (1.2.1), all the non-zero coefficients of \tilde{P} are 1, and P_0 can be an extension factor.

The contributions from small dash-boxes are also extension factors. Indeed, the box containing the vertex with adjacent weight a_{n+2} , p_{n+2} and 1 has the multiplicative contribution $P_{n+2}(t_1, t_2) = \tilde{P}_{n+2}(t_1^{a_{n+2} p_{n+3} \cdots p_s} \cdot t_2^{p_{n+1} a_n p_n p_{n+1} \cdots p'_r})$, where $\tilde{P}_{n+2}(t) = (t^{p_{n+2}} - 1)/(t - 1)$. We will denote these extension factors by P_{n+2}, \dots, P_s and P'_{n+2}, \dots, P'_r .

The contribution from the remaining four vertices is $\Delta'(t_1, t_2) = \tilde{\Delta}'(t_1^{p_{n+2} \cdots p_s}, t_2^{p'_{n+2} \cdots p'_r})$, where

$$\tilde{\Delta}'(t_1, t_2) = \frac{(t_1^{p_{n+1} a_{n+1}} t_2^{p_{n+1} a_n p_n p'_{n+1}} - 1)}{(t_1^{a_{n+1}} t_2^{a_n p_n p'_{n+1}} - 1)} \cdot \frac{(t_1^{p'_{n+1} p_n a_n p_{n+1}} t_2^{a'_{n+1} p'_{n+1}} - 1)}{(t_1^{p_n a_n p_{n+1}} t_2^{a'_{n+1}} - 1)}.$$

Obviously, Δ' is not of ordered type if and only if $\tilde{\Delta}'$ is not of ordered type. But $\tilde{\Delta}'$ is not of ordered type since in its support one has the two lattice points $(a_{n+1}, a_n p_n p'_{n+1})$ and $(p_n a_n p_{n+1}, a'_{n+1})$. We recall (see [8, page 51]) that for an irreducible component the $(p_i, a_i)_i$ splice diagram decorations are related with the Newton pairs by $a_{i+1} = q_{i+1} + p_i p_{i+1} a_i$. Therefore, $a_{n+1} - p_n a_n p_{n+1} = q_{n+1} > 0$ and $a'_{n+1} - a_n p_n p'_{n+1} = q'_{n+1} > 0$. (These inequalities follow from Lemma 5.4.1(a) as well.)

Since $\Delta = P_0 \cdot P_{n+2} \cdots P_r \cdot P'_{n+2} \cdots P'_r \cdot \Delta'$, the polynomial Δ is not of ordered type.

(I.Deg) Let us show that the ‘degenerate cases’ of family (I), when $s = n$ and/or $r = n$ cannot occur. Indeed, $s = n$ and $r = n$ cannot happen, since this is exactly the parallel case. If $s > n$ and $r = n$, then one of the supporting vertices (say v_2) is the n -th node, which is not the last node of C_1 . This v_2 cannot be a (-1) -vertex (in fact, its decoration is $-1 - \lceil p_{n+1}/q_{n+1} \rceil$, where (p_i, q_i) are the Newton pairs of C_1 , cf. [24]). Hence this case cannot occur as well.

(II) The second family has the next form, again with $s > n$ and $r > n$. Like above, these inequalities guarantee that both supporting vertices are automatically (-1) -vertices.

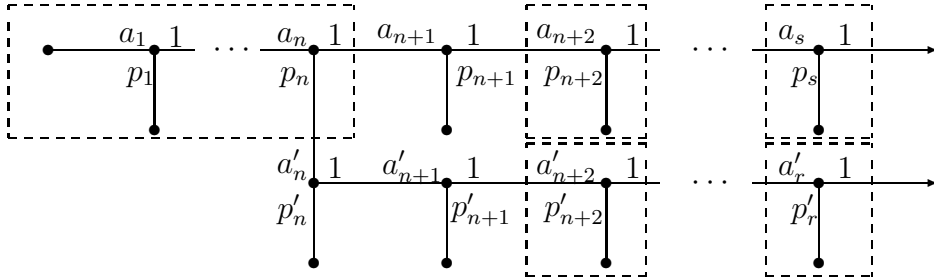

The contributions from the dash-boxes are extension factors as above. The contributions from the remaining three pairs of vertices is $\Delta'(t_1, t_2) = \tilde{\Delta}'(t_1^{p_{n+2} \cdots p_s}, t_2^{p'_{n+2} \cdots p'_r})$, where

$$\tilde{\Delta}'(t_1, t_2) = \frac{\mathbf{t}^{p_{n+1} X} - 1}{\mathbf{t}^X - 1} \cdot \frac{\mathbf{t}^{p'_n Z} - 1}{\mathbf{t}^Z - 1} \cdot \frac{\mathbf{t}^{p'_{n+1} Y} - 1}{\mathbf{t}^Y - 1} \quad (\mathbf{t}^{(a_1, a_2)} = t_1^{a_1} t_2^{a_2})$$

$$X = (a_{n+1}, a_n p'_n p'_{n+1}), \quad Z = (a_n p_{n+1}, a'_n p'_{n+1}), \quad Y = (p'_n a_n p_{n+1}, a'_{n+1}).$$

Note that by edge-inequalities of the splice diagram $p_n a'_n > a_n p'_n$, $a_{n+1} > a_n p_n p_{n+1}$, and $a'_{n+1} > a'_n p'_n p'_{n+1}$. Using these, if $a_n \leq a'_n$ then one verifies that Y and $X + (p'_n - \min\{p_n, p'_n\})Z$ is an un-ordered pair in the support of $\tilde{\Delta}'$.

Assume next that $a_n > a'_n$. Then we will use the contribution from the extension factor $P_0(t_1, t_2)$ from the left dash-box as well. Let g be an irreducible singularity with splice decorations $(a_i, p_i)_{i=1}^{n-1}$, let $\Delta_g(t)$ denote the Alexander polynomial of g . One can check that $P_0(t_1, t_2) = \tilde{P}_0(t_1^{p_{n+2} \cdots p_s}, t_2^{p'_{n+2} \cdots p'_r})$, where

$$\tilde{P}_0(t_1, t_2) = \Delta_g(t) \frac{t^{a_n} - 1}{t - 1}$$

with the substitution $t = t_1^{p_n p_{n+1}} t_2^{p'_n p'_{n+1}}$. Set also $T := (p_n p_{n+1}, p'_n p'_{n+1})$. One shows (by induction the number of Newton pairs) that $\mu(g) < a_{n-1} p_{n-1}$. On the other hand, $a_{n-1} p_{n-1} < a_n/p_n < a'_n/p'_n < a'_n < a_n$, hence by Corollary 5.1.3 \tilde{P}_0 has all coefficients 0 or 1 and the coefficient of t^{a_n} equals 1. All this shows that $a'_n \cdot T$ is in the support of $\tilde{P}_0 \cdot \tilde{\Delta}'$. Then, one verifies that Y and $a'_n \cdot T$ are unordered pairs in the support of $\tilde{P}_0 \cdot \tilde{\Delta}'$.

(II.Deg) Next we discuss three degenerate cases of (II) corresponding to $r = n$ and/or $s = n$.

This is the place of a very important warning. If $r > n$ then the supporting vertex of this component (the r -th node) is automatically a (-1) -vertex, however this is not the case when $r = n$. Thus, if $r = n$, we have to impose this extra condition. The point is that if we consider the ‘long graph case’ with $r > n$ and we wish to make induction by considering its shorter subgraph by deleting say one splice component, the shorter graph might not have this extra condition (hence their Alexander polynomial might be ordered). In particular, inductions of this type cannot be implemented. The non-ordered property of Δ for long graphs ($r > n$) is imposed by the contribution from the long hands, for short graph ($r = n$) by the extra assumption about the existence of (-1) -vertices. This explain also why we didn’t handle in cases (I)-(II) the $(n + 1)$ -th nodes as extension factors (though they are, but Δ' associated with a shorter graph might not have the non-ordered property without extra assumptions).

It is not easy to combine the decoration of the splice diagram (which gives naturally Δ) with the extra assumption regarding the (-1) -vertices in Γ . This is exactly the role of Lemma 5.4.2. The cases (a), (b) and (a)-(b) of (5.4.4) correspond to the three degenerations of (II).

(II.Deg.a) Assume that $s = n$ but $r > n$, and in the resolution graph Γ the supporting vertex of L_2 is a (-1) -vertex (in the splice diagram this is the node with decorations $a_n, p_n, 1$).

Set $T := (p_n, p'_n p'_{n+1})$, $Z = (a_n, a'_n p'_{n+1})$ and $Y = (p'_n a_n, a'_{n+1})$. Then $\Delta = P_0 P'_{n+2} \cdots P'_r \Delta'$, where P'_{n+1}, \dots, P'_r are extension factors, $P_0 = \tilde{P}_0(t_1, t_2^{p'_{n+2} \cdots p'_r})$, where \tilde{P}_0 is obtained from $\Delta_g(t)(t^{a_n} - 1)/(t - 1)$ by substitution $t = \mathbf{t}^T$, and $\Delta' = \tilde{\Delta}'(t_1, t_2^{p'_{n+2} \cdots p'_r})$, where

$$\tilde{\Delta}'(t_1, t_2) = \frac{\mathbf{t}^{p'_n Z} - 1}{\mathbf{t}^Z - 1} \cdot \frac{\mathbf{t}^{p'_{n+1} Y} - 1}{\mathbf{t}^Y - 1}.$$

By (5.4.4)(a) there exists a pair of positive integers (z, w) such that $a'_n/p'_n > z/w > a_n/p_n$ and $z < a_n$. Note that $z > a_n w/p_n \geq a_n/p_n$ and (by edge inequality of the diagram) $a'_n > a_n p'_n/p_n \geq a_n/p_n$. But $a_n/p_n > a_{n-1} p_{n-1} > \mu(g)$. Hence $zT \in \text{Supp}(\tilde{P} \tilde{\Delta}')$ (since $z < a_n$), and $a'_n T \in \text{Supp}(\tilde{P} \tilde{\Delta}')$ provided that $a'_n < a_n$.

If $a'_n < a_n$ then $a'_n T$ and Y are unordered pairs in $\text{Supp}(\tilde{P} \tilde{\Delta}')$, if $w < p'_n$ then zT and wZ are unordered. Finally, if $a_n \leq a'_n$ and $w \geq p'_n$ then zT and Y are unordered pairs.

(II.Deg.b) Assume that $s > n$ and $r = n$, and in the resolution graph Γ the supporting vertex of L_1 is a (-1) -vertex (in the splice diagram this is the node with decorations $a'_n, p'_n, 1$).

Though the graph is not symmetric to the case (II.Deg.a), the computations and the proof is. We write only the generators (and all the other details are left to the reader). $T = (p_n p_{n+1}, p'_n)$, $X = (a_{n+1}, a_n p'_n)$, $Z = (a_n p_{n+1}, a'_n)$. (5.4.4)(b) provides a pair (z, w) with $a'_n/p'_n > z/w > a_n/p_n$ and $w < p'_n$. Then if $z < a_n$ then zT and wZ are unordered, if $p_n < p'_n$ then $p_n Z$ and X are unordered, and if $z \geq a_n$ and $p_n \geq p'_n$ then wZ and X are unordered pairs.

(II.Deg.c) Assume $s = r = n$ and assume also that in the resolution graph Γ both arrowhead-supporting vertices have decoration (-1) .

Set $T = (p_n, p'_n)$ and $Z = (a_n, a'_n)$. Then $\Delta = P_0 \Delta'$, where $P_0 = \Delta_g(\mathbf{t}^T)(\mathbf{t}^{a_n T} - 1)/(\mathbf{t}^T - 1)$ and $\Delta' = (\mathbf{t}^{p'_n Z} - 1)/(\mathbf{t}^Z - 1)$. By (a)-(b) of (5.4.4) there exist (z, w) with $a'_n/p'_n > z/w > a_n/p_n$, $z < a_n$ and $w < p'_n$. Hence zT and wZ are unordered. \square

Example 7.3.2. Consider the algebraic link L corresponding to a singularity $C = C_1 \cup C_2$. Suppose that C_1 and C_2 are singular and the tangent lines to C_1 and to C_2 are distinct. Then the Alexander polynomial is not of ordered type (and $\text{LS}(L)$ is bounded below, cf. Theorem 7.1.1). Indeed, C_1 and C_2 are non-parallel and both are supported by (-1) -vertices.

7.4. The second step of the implication (5) \Rightarrow (4). In order to finish the proof of Theorem 7.1.1 we need to finish the implication (5) \Rightarrow (4) (for non-parallel case).

Consider the minimal embedded resolution of C . In the non-parallel case C_1 and C_2 are supported on different vertices v_1 and v_2 . For the case when these are both (-1) -vertices, Theorem 7.3.1 states that $\Delta(t_1, t_2)$ is not of ordered type. Hence, we need to consider the case when only one component (say, C_2) is supported at the (-1) -vertex, and C_1 is resolved automatically by the minimal resolution of C_2 .

Theorem 7.4.1. *Assume that the resolution graph Γ is the minimal good resolution of C_2 , and the arrowhead of C_1 is glued to some arbitrarily chosen vertex of $\Gamma \setminus v_2$. If $\Delta(t_1, t_2)$ is of ordered type then v_1 is a simple vertex in $\Gamma \setminus v_2$.*

Proof. Note that $\Gamma \setminus v_2$ has two components. One of them is a string (it supports the decoration p_s in the diagram below). Since the minimal cycle of a string is reduced, if v_1 is one of its vertices it automatically satisfies the wished simplicity. Thus we assume that v_1 is in the other component, denoted by Γ' . We will use the following splice diagram (which codes the needed multiplicities/determinants), where we also distinguish the vertex v_3 , vertex of Γ' adjacent to v_2 in the resolution graph Γ . (In particular, the splice diagram is not minimal, the v_3 -node has valency two). In this diagram v_1 is sitting between two nodes, but for any other choice of v_1 the proof runs identically (see below). Set also $g := p_{n+1} \cdots p_{s-1}$.

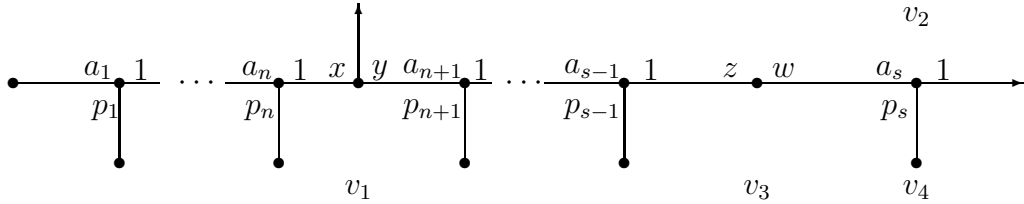

Recall that $C(\Gamma)$ denote the Lipman cone (4.1.1), let $pr_{12}C(\Gamma) \subset \mathbb{Z}^2$ be its projection to the coordinates of v_1 and v_2 . Let m_{uv} denote the entries of $-I^{-1}$ as in 5.3. Then, for any $v \in \mathcal{V}$ the cycles $E_v^* := \sum_u m_{uv} E_u$ belongs to $C(\Gamma)$. In fact, they generate the real cone, since $(E_v^*, E_w) = 0$ if $v \neq w$ and $= -1$ for $v = w$. Hence $(m_{uv_1}, m_{uv_2}) \in pr_{12}C(\Gamma)$ for any u . One has the following inclusion:

$$(7.4.2) \quad \text{Supp}(\Delta) \subset pr_{12}C(\Gamma).$$

This follows from the expansion of the right hand side of (5.3.1) as power series in t_1, t_2 .

Our goal is to construct a cycle in $C(\Gamma')$ (hence supported on Γ') with E_{v_1} -multiplicity 1.

First we consider the projection $pr_{12}(E_{v_3}^*) = (m_{v_3 v_1}, m_{v_3 v_2}) = (xgw, zp_s)$. The entry xgw can be compared with the linking number $l = m_{v_1 v_2} = xgp_s$ of the components of C . Indeed, if we apply 5.4.1(a) for the string (without arrowhead) staying right to v_3 and for G the edge

adjacent to v_2 we obtain $w < p_s$. Therefore, $xgw \leq l - xg$. On the other hand, using again 5.4.1(a) we have $x \geq a_n p_n y \geq 2$. Thus $xgw \leq l - 2$.

Next, $m_{v_3 v_1} \geq m_{v_1 v_1}$. Indeed, $m_{v_3 v_1}$ (resp. $m_{v_1 v_1}$) is the multiplicity of C_1 along E_{v_3} (resp. E_{v_1}), and in the resolution process of Γ there is a sequence of blowups whose first member creates E_{v_1} and the last one E_{v_3} (here one uses the minimality of Γ and the fact that there is no extra blowup imposed by C_1). Hence $\mu(C_1) \leq m_{v_1 v_1} \leq m_{v_3 v_1} = xgw$.

Therefore, by Proposition 5.1.2 $xgw + 1$ is in the semigroup of C_1 , and by Lemma 5.2.4 there exists q_2 such that

$$(7.4.3) \quad Q := (xgw + 1, q_2) \in \text{Supp}(\Delta).$$

Next, since $w < p_s$ (see above), by (5.3.1) $pr_{12}(wE_{v_4}^*) \in \text{Supp}(\Delta)$ too. Its coordinates are (wgx, wa_s) . This can be compared with the other support point from (7.4.3). Since Δ is of ordered type, we conclude $N := q_2 - wa_s > 0$.

Using again the determinantal property 5.4.1(a) for Γ and the edge $(v_3 v_2)$, we get $wa_s = zp_s + 1$. By a computation

$$(7.4.4) \quad Q + N \cdot pr_{12}(E_{v_3}^*) = (N + 1)pr_{12}(E_{v_4}^*) + (1, 0).$$

Note that by (7.4.2) $Q \in pr_{12}C(\Gamma)$, hence there exists a cycle $D \in C(\Gamma)$ such that $pr_{12}(D) = Q + N \cdot pr_{12}(E_{v_3}^*)$. Then, finally we define the cycle F' on $L(\Gamma')$ as the restriction of $F := D - (N + 1)E_{v_4}^*$ on Γ' . First notice that by (7.4.4) the E_{v_2} -multiplicity of F is 0, therefore for any E_u with $u \in \mathcal{V}(\Gamma')$ one has $(F, E_u)_\Gamma = (F', E_u)_{\Gamma'}$. But $(F, E_u)_\Gamma \leq 0$ since $D \in C(\Gamma)$ and $(E_{v_4}^*, E_u) = 0$. Hence $F' \in C(\Gamma')$. On the other hand, the E_{v_1} -multiplicity of F' is 1 by (7.4.4). This ends the proof in the case of this position of the arrowhead of C_1 .

If the v_1 node coincides with the n -th node of the diagram, then one has to make the modification $x = a_n$ and $g := p_n \cdots p_{s-1}$. If it is one the n -th leg then $g = a_n p_{n+1} \cdots p_{s-1}$. One verifies that in any situation $xg > 1$, and the above proof runs with these modifications.

This ends the proof of Theorems 7.4.1 and 7.1.1. \square

8. EXAMPLES

8.1. We illustrate the above results with explicit examples.

Example 8.1.1. The h -function for the Whitehead link (in appropriate normalization of Alexander gradings) is shown in Figure 8. The bivariate Alexander polynomial equals $\Delta(t_1, t_2) = -(1 - t_1^{-1})(1 - t_2^{-1})$ and $c = (0, 0)$. By (3.1.3) we get

$$h_1(v_1) = h(v_1, -1) = \max(v_1, 0), \quad h_2(v_2) = h(-1, v_2) = \max(v_2, 0).$$

The point $v = (0, 0)$ (circled in Figure 8) is good ($h(0, 0) = 1$ while $h_1(0) = h_2(0) = 0$) and self-dual, so it is very good. Therefore all L-space surgeries on the Whitehead link have positive coefficients, in agreement with [21, Proposition 6.4].

Example 8.1.2. Consider the singularity $(x^2 - y^3)(x^3 - y^2) = 0$, corresponding to a pair of trefoils with linking number 4. The bivariate Alexander polynomial equals $\Delta(t_1, t_2) = (1 + t_1^2 t_2^3)(1 + t_1^3 t_2^2)$. The graph of the h -function is given in the Figure 9 (the semigroup is bold). For a point $v = (3, 3)$ one has $h(v) = 3$ and $h_1(v) = h_2(v) = 2$. Since $c = (6, 6)$, one has $v^* = v$, so v is very good. For $\mathbf{LS}(L)$ see Figure 2.

Example 8.1.3. Consider the family $L(s)$ consisting of the trefoil L_1 and its $(2, 2s + 1)$ cable L_2 . $L(s)$ is algebraic for $s \geq 6$: L_2 is the link of the singularity $(x, y) = (t^4, t^6 + t^{2s-5})$. Then

$$\Delta = (1 + t_1^4 t_2^2 + t_1^6 t_2^3 + t_1^8 t_2^4 + t_1^{10} t_2^5 + t_1^{14} t_2^7)(1 + t_1^{2s+1} t_2^6).$$

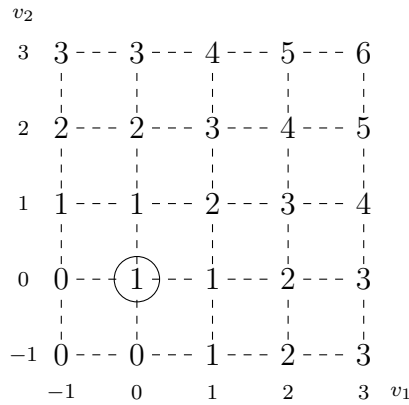

FIGURE 8. h -function for the Whitehead link

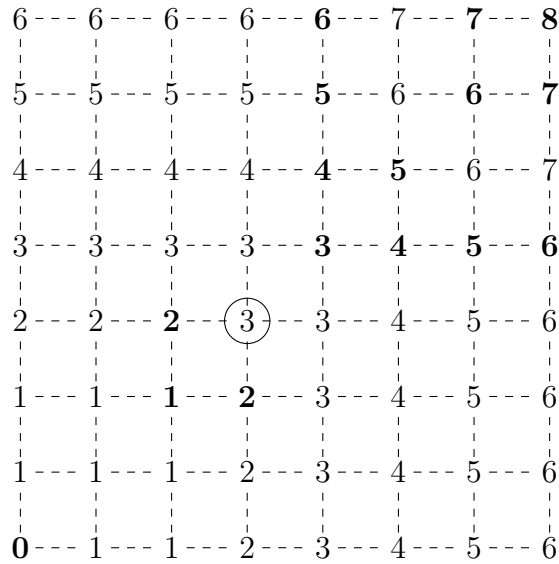

FIGURE 9. h -function for a pair of ‘transversal’ trefoils

For $s = 6$ the polynomial Δ is of ordered type (see Figure 10). For $s \geq 7$ $\text{Supp}(\Delta)$ contains the unordered points $u = (14, 7)$ and $v = (2s + 1, 6)$, see Figure 11 for $\text{Supp}(\Delta(L(7)))$.

In fact, one can check (see, e.g. [10]) that $(d, 26) \in \text{LS}(L(6))$ for any $d \in \mathbb{Z}$.

Example 8.1.4. Let L be an algebraic link such that L_1 is an (p_1, a_1) torus knot, and L_2 is its (p_2, a_2) cable, where $a_2 = a_1 p_1 p_2 + q_2$ ($q_2 > 0$). (This means that L_2 has Newton pairs $(p_1, a_1), (p_2, q_2)$, the splice diagram has two nodes decorated with (p_1, a_1) and (p_2, a_2) , and the first node supports L_1 .) Then Δ is of ordered type if and only if $q_2 < p_2$.

Indeed, in this case v_1 is the node of the star-shaped graph $\Gamma \setminus v_2$ with three legs, and its self-intersection is $e := -\lceil p_2/q_2 \rceil - 1$, cf. [24]. If $q_2 < p_2$ then $e \leq -3$ and v_1 is simple ($Z_{\min} = \sum_u E_u$), otherwise $e = -2$ and v_1 is not simple in $\Gamma \setminus v_2$.

Example 8.1.5. With the notation of previous example, assume that $p_1 = 2, a_1 = 3, p_2 = 3, q_2 = 2$. This is an algebraic link consisting of the trefoil and its $(3, 20)$ cable. Since $q_2 < p_2$, the Alexander polynomial of L is of ordered type, cf. 8.1.4, see Figure 12 for its support.

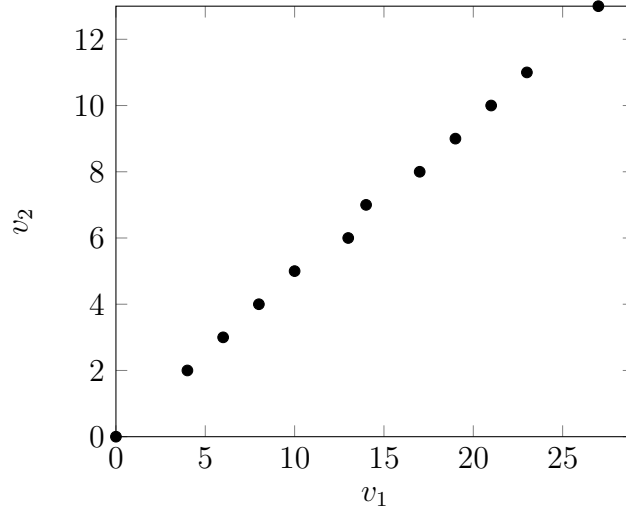
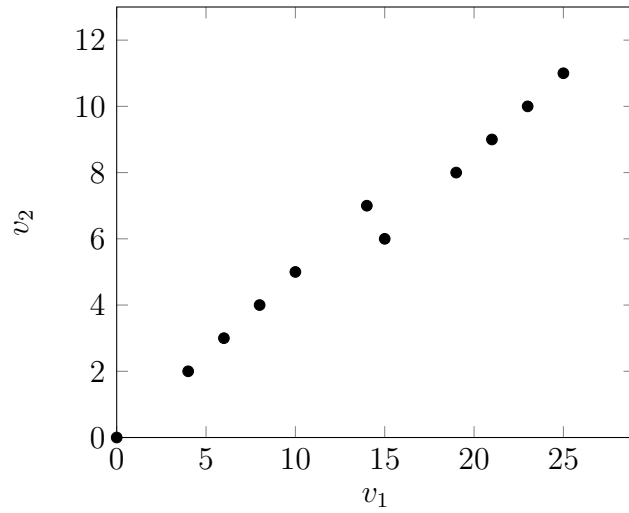
FIGURE 10. The support of the Alexander polynomial of $L(6)$ FIGURE 11. The support of the Alexander polynomial of $L(7)$

Therefore $\mathbf{LS}(L)$ is unbounded from below, nevertheless, only one of ‘test lines’ $\{m_1\} \times \mathbb{Z}$, $\mathbb{Z} \times \{m_2\}$ confirms this fact. The set $\mathbf{LS}(L)$ (computed using [12]) is shown in Figure 13.

Proof of the statement of Example 1.1.5. Let K be an L-space knot and $n/m > 2g(K) - 1$. Then (e.g. by [9, Proposition 2.1]) the (mn, d) -surgery on $K_{2m,2n}$ yields a connected sum

$$S_{mn,d}^3(K_{2m,2n}) = S_{n/m}^3(K) \# L(m, n) \# L(d - mn, 1).$$

Since $n/m > 2g(K) - 1$, $S_{n/m}^3(K)$ is an L-space, so for all $d \neq mn$ the 3-manifold $S_{mn,d}^3(K_{2m,2n})$ is an L-space too. Therefore $(mn, d) \in \mathbf{LS}(K_{2m,2n})$ for all $d \neq mn$, and $\mathbf{LS}(K_{2m,2n})$ is unbounded. \square

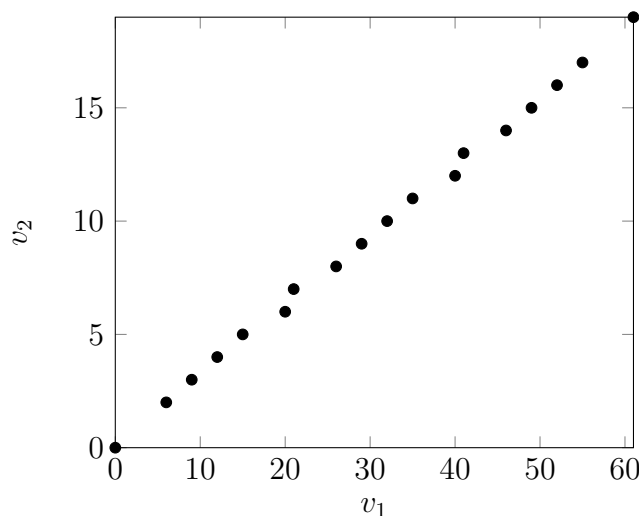
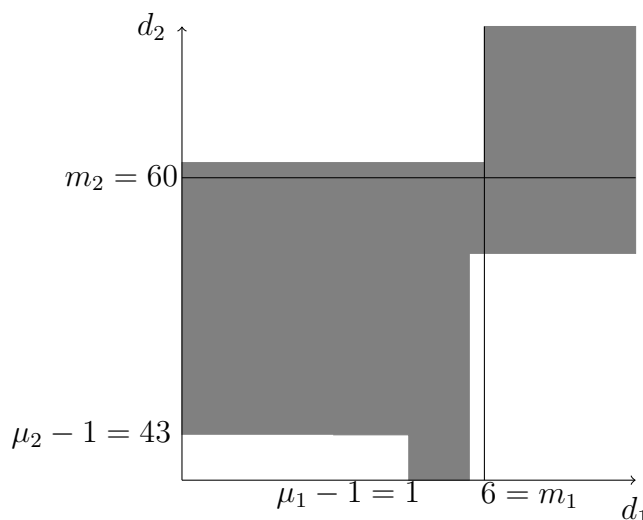

FIGURE 12. The support of the Alexander polynomial in Example 8.1.5

FIGURE 13. Sketch of $\mathbf{LS}(L)$ in Example 8.1.5

REFERENCES

- [1] M. Artin. Some numerical criteria for contractibility of curves on algebraic surfaces. *Amer. J. of Math.* **84** (1962), 485–496.
- [2] M. Artin. On isolated rational singularities of surfaces. *Amer. J. of Math.* **88** (1966), 129–136.
- [3] S. Boyer, C. McA. Gordon, L. Watson. On L -spaces and left-orderable fundamental groups. *Math. Ann.* **356** (2013), no. 4, 1213–1245.
- [4] M. Borodzik, S. Rasmussen. In preparation.
- [5] G. Braun, A. Némethi. Surgery formula for Seiberg-Witten invariants of negative definite plumbed 3-manifolds. *J. Reine Angew. Math.* **638** (2010), 189–208.
- [6] A. Campillo, F. Delgado, S. M. Gusein-Zade. The Alexander polynomial of a plane curve singularity via the ring of functions on it. *Duke Math J.* **117** (2003), no. 1, 125–156.
- [7] A. Campillo, F. Delgado, K. Kiyek. Gorenstein property and symmetry for one-dimensional local Cohen-Macaulay rings. *Manuscripta Math.* **83** (1994), no. 3-4, 405–423.
- [8] D. Eisenbud, W. Neumann. Three-dimensional link theory and invariants of plane curve singularities. *Annals of Mathematics Studies*, 110. Princeton University Press, Princeton, NJ, 1985.

- [9] E. Gorsky, J. Hom. Cable links and L-space surgeries. To appear in Quantum Topology. arXiv:1502.05425
- [10] E. Gorsky, A. Némethi. Links of plane curve singularities are L-space links. Algebraic and Geometric Topology **16** (2016) 1905–1912.
- [11] E. Gorsky, A. Némethi. Lattice and Heegaard–Floer homologies of algebraic links. Int. Math. Res. Not. IMRN 2015, no. 23, 12737–12780.
- [12] J. Hanselman. `tree_manifolds_HFhat`, a Python program computing \widehat{HF} for plumbing trees. Available at http://math.columbia.edu/~jhansel/graph_manifolds_program.html
- [13] J. Hanselman, J. Rasmussen, S. Rasmussen, L. Watson. Taut foliations on graph manifolds. arXiv:1508.05911
- [14] M. Hedden. On knot Floer homology and cabling. II. Int. Math. Res. Not. IMRN 2009, no. 12, 2248–2274.
- [15] R. Kirby. A calculus for framed links in S^3 . Invent. Math. **45** (1978), no. 1, 35–56.
- [16] T. László, A. Némethi. Reduction theorem for lattice cohomology, Int. Math. Res. Notices **2015**, Issue 11 (2015), 2938–2985.
- [17] H.B. Laufer. On rational singularities, Amer. J. of Math. **94** (1972), 597–608.
- [18] D. T. Lê, M. Tosun. Combinatorics of rational singularities. Comment. Math. Helv. **79** (2004), 582–604.
- [19] T. Lidman. Framed Floer Homology. arXiv:1109.3756
- [20] Lipman, J.: Rational singularities, with applications to algebraic surfaces and unique factorization, Inst. Hautes Études Sci. Publ. Math. **36** (1969), 195–279.
- [21] Y. Liu. L-space surgeries on links. To appear in Quantum Topology. arXiv:1409.0075
- [22] C. Manolescu, P. Ozsváth. Heegaard Floer homology and integer surgeries on links. arXiv:1011.1317
- [23] J. Milnor. Singular points of complex hypersurfaces, Annals of Math. Studies, **61**, Princeton University Press, 1968.
- [24] A. Némethi. Dedekind sums and the signature of $f(x, y) + z^N$, II. Selecta Mathematica, New Series **5** (1999), 161–179.
- [25] A. Némethi. On the Ozsváth–Szabó invariant of negative definite plumbed 3-manifolds, Geometry and Topology **9** (2005), 991–1042.
- [26] A. Némethi. On the Heegaard Floer homology of $S^3_{-d}(K)$ and unicuspidal rational plane curves, *Fields Institute Communications*, Vol. **47**, 2005, 219–234; “Geometry and Topology of Manifolds”, Eds: H.U. Boden, I. Hambleton, A.J. Nicas and B.D. Park,
- [27] A. Némethi. Graded roots and singularities, (contains also the preprint ‘On the Heegaard Floer homology of $S^3_{-p/q}(K)$ ’, math.GT/0410570); Proc. *Advanced School and Workshop on Singularities in Geometry and Topology* ICTP (Trieste, Italy), World Sci. Publ., Hackensack, NJ, 2007, 394–463.
- [28] A. Némethi. The Seiberg–Witten invariants of negative definite plumbed 3-manifolds, Journal of EMS **13**(4) (2011), 959–974.
- [29] A. Némethi. Links of rational singularities, L-spaces and LO fundamental groups. arXiv:1510.07128
- [30] W. Neumann. A calculus for plumbing applied to the topology of complex surface singularities and degenerating complex curves. Trans. Amer. Math. Soc. **268** (1981), no. 2, 299–344.
- [31] P. Ozsváth, Z. Szabó. Knot Floer homology and rational surgeries. Algebr. Geom. Topol. **11** (2011), no. 1, 1–68.
- [32] P. Ozsváth, Z. Szabó. Holomorphic discs, link invariants and the multi-variable Alexander polynomial. Algebr. Geom. Topol. **8** (2008), no. 2, 615–692.
- [33] P. Ozsváth, Z. Szabó. On knot Floer homology and lens space surgeries. Topology **44** (2005), no. 6, 1281–1300.
- [34] P. Ozsváth, Z. Szabó. On the Floer homology of plumbed three-manifolds. Geom. Topol. **7** (2003), 185–224.
- [35] P. Ozsváth, Z. Szabó. Holomorphic disks and topological invariants for closed three-manifolds. Ann. of Math. (2) **159** (2004), no. 3, 1027–1158.
- [36] J. Rasmussen, S. Rasmussen. Floer Simple Manifolds and L-Space Intervals. To appear in *Advances in Mathematics*. arXiv:1508.05900
- [37] S. Rasmussen. L-space intervals for Graph Manifolds and Cables. To appear in *Compositio Mathematica*. arXiv:1511.04413
- [38] M. Spivakovskiy. Sandwich singularities and desingularisation of surfaces by normalized Nash transformations, Ann. Math. **131** (1990), pp.411–491.
- [39] G. Torres. On the Alexander polynomial. Ann. of Math. (2) **57**, (1953). 57–89.
- [40] G. N. Tyurina. Absolute isolatedness of rational singularities and rational triple points, Fonc. Anal. Appl. **2** (1968), pp. 324–332.

- [41] M. Yamamoto. Classification of isolated algebraic singularities by their Alexander polynomials. *Topology* **23** (3) (1984), 277–287.

DEPARTMENT OF MATHEMATICS, UC DAVIS, ONE SHIELDS AVENUE, DAVIS, CA 95616

NATIONAL RESEARCH UNIVERSITY HIGHER SCHOOL OF ECONOMICS, USACHEVA 6, MOSCOW, RUSSIA

E-mail address: egorskiy@math.ucdavis.edu

ALFRÉD RÉNYI INSTITUTE OF MATHEMATICS, HUNGARIAN ACADEMY OF SCIENCES, REÁLTANODA
UTCA 13-15, H-1053, BUDAPEST, HUNGARY

ELTE - UNIVERSITY OF BUDAPEST, HUNGARY

BCAM - BASQUE CENTER FOR APPLIED MATHEMATICS, BILBAO, SPAIN

E-mail address: nemethi.andras@renyi.mta.hu