

The Enhancement of Supersymmetry in M-strings

Yuji SUGIMOTO¹

*Department of Physics, Graduate School of Science,
Osaka University, Toyonaka, 560-0043, Japan*

Abstract

We study two M5-branes on A_1 ALE space. We introduce some M2-branes suspended between the M5-branes. Then, the boundaries of M2-branes look like strings. We call them “M-strings”. The M-strings have $\mathcal{N} = (4, 0)$ supersymmetry by considering the brane configuration on A_1 ALE space. We calculate the partition function of M-strings by using the refined topological vertex formalism. We find that the supersymmetry of M-strings gets enhanced to $\mathcal{N} = (4, 4)$ by tuning some Kähler parameters. Furthermore, we discuss another possibility of the enhancement of supersymmetry which is different from the above one.

arXiv:1508.02125v3 [hep-th] 13 Jun 2016

¹sugimoto@het.phys.sci.osaka-u.ac.jp

Contents

1	Introduction	1
2	Brane configuration and M-strings	2
3	Refined topological vertex	3
3.1	Computation of partition function	3
3.2	Enhancement of Supersymmetry	6
4	Discussion	10
A	Definition and Formula	14
B	Recursion Formula and Flop Transition	15
B.1	Simple case	15
B.2	Little complicated case	16

1 Introduction

M5-branes are mysterious objects in M theory. The low energy theories on coincident multiple M5-branes are 6 dimensional $\mathcal{N} = (2, 0)$ theories whose Lagrangians are not known. Then, one of the methods whom we can use to analyze is the duality.

We consider two M5-branes on A_1 ALE space. When two M5-branes are separated by introducing some M2-branes, we can see some 2 dimensional objects in the boundaries of the M2-branes and M5-branes. We call them “M-strings” [1][2][3][4][5][6][7]. This configuration is dual to a (p, q) 5-brane web [8]. Furthermore, the (p, q) 5-brane web is dual to the refined topological string [9][10] on a non-compact toric Calabi-Yau manifold [11][12]. Thus, we can calculate the partition function of M-strings by using the refined topological vertex formalism [13][14][15][16][17][18][19][20][21][22][23].

The M-strings have $\mathcal{N} = (4, 4)$ supersymmetry in flat space [1]. When we put the M-strings on A_1 ALE space, the supersymmetry is broken to $\mathcal{N} = (4, 0)$. Furthermore, in order to use the duality to the refined topological string, we consider some deformations by giving masses to the bifundamental hypermultiplets. These deformations do not break the $\mathcal{N} = (4, 0)$ supersymmetry anymore [3]. According to [1][2][3], the partition function of M-strings agrees with the elliptic genus of the supersymmetric gauge theory through the chain of dualities.

In this paper, we consider one of the web diagrams which is dual to the above situation. This diagram is also related to the web diagram which is discussed in [3] under the flop transition [24][25][26]. We calculate the partition function of M-strings by using the refined topological vertex formalism. Our result is consistent with [2][3] under the flop transition. Then, we find that the supersymmetry of M-strings gets enhanced to $\mathcal{N} = (4, 4)$ by tuning some Kähler parameters. Such a tuning of the Kähler parameters is discussed in the literature, for instance as in [27]

The organization of this paper is as follows: In section 2, we review two M5-branes on A_1 ALE space very briefly. We also introduce the web diagram which corresponds to the M2-M5 brane

system. More detailed discussion about our model is written in [1][2][3]. In section 3, we calculate the partition function by using the refined topological vertex formalism. Then, by tuning some Kähler parameters, we find that the partition function of M-strings in A_1 ALE space agrees with that in flat space. This partition function is also coincident with the elliptic genus of the $\mathcal{N} = (4, 4)$ $U(k)$ gauge theory for further setting some other Kähler parameters. Finally, in section 4, we discuss our results and another possibility of the enhancement of supersymmetry by tuning some Kähler parameters which are different from the above choices.

2 Brane configuration and M-strings

Consider the M2-M5 brane system on A_1 ALE space. We call the boundaries of M2- and M5-branes “M-strings” (see Fig. 1) [1]. According to a discussion in [1], the M-strings have $\mathcal{N} = (4, 4)$ supersymmetry in flat space. However the supersymmetry is broken to $\mathcal{N} = (4, 0)$ on A_1 ALE space because of orbifolding [3].

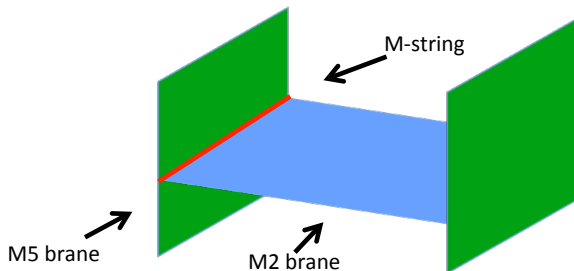

Figure 1: The brane configuration. The M2-brane, M5-branes, and M-strings are denoted by the blue sheet, green sheets, and red lines, respectively.

M theory	X_0	X_1	X_2	X_3	X_4	X_5	X_6	X_7	X_8	X_9	X_{\natural}
2 M5	○	○	○	○	○	○					
k M2	○	○					○				
A_1 ALE								○	○	○	○

Table 1: The brane setup where A_1 ALE space is spanned by $X_7, X_8, X_9, X_{\natural}$ and k is the number of the M2-branes.

Let us consider the chain of dualities between M theory and Type IIB superstring theory [3]. We set X_1 as M-theory circle. Then the M5-branes and the M2-branes become the D4-branes and the F1-branes, respectively. After T-duality along the X_7 , we get the D5-NS5 brane web (see Fig. 2). Then, in order to connect this geometry to the refined topological string, we introduce some mass parameters and Ω -background by fibering over the circle.² These mass parameters correspond to the blow-up parameters in the web diagram.

²Strictly speaking, we need consider a further compactification on another S^1 , and we fiber the space over this circle. Its discussion is written in [1][2][3]

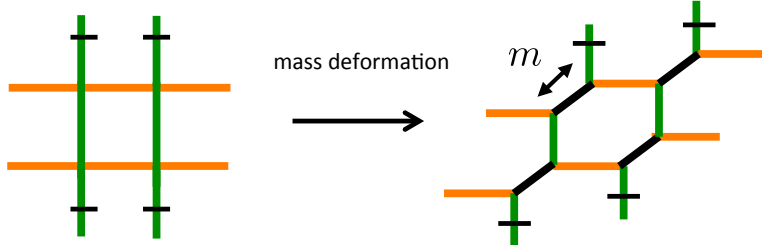

Figure 2: The brane web and its blow-up. The D5-branes and NS5-branes are denoted by the green lines and orange lines, respectively.

This web diagram is related to the web diagram in Fig. 3 (b) under the flop transition [26]. In section 3, we will calculate the partition function of M-strings corresponding to the web diagram (b) by using the topological vertex formalism.

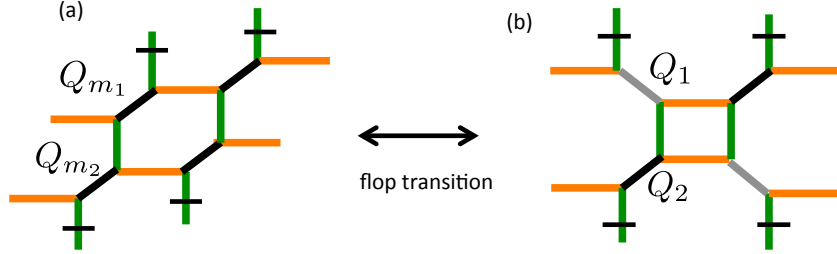

Figure 3: The flop transition. We define the Kähler parameters Q_{m_1} , Q_{m_2} , Q_1 , and Q_2 which denote the mass deformations. The diagram (a) is discussed in [2][3]. We will discuss the diagram (b).

3 Refined topological vertex

3.1 Computation of partition function

In section 2, we have introduced the M-strings and discussed how to be related to the web diagram. In this section, we calculate the partition function of M-strings.

We define some Kähler parameters Q_1 , Q_2 , Q_3 , Q'_1 , Q'_2 , Q'_3 , Q_f , Q_b , and some Young diagrams ν_1 , ν_2 as in Fig. 4, where ν_1^t and ν_2^t denote the transpose of ν_1 and ν_2 respectively. Then we write the partition function for the diagram (a) by using the refined topological vertex formalism,

$$\mathcal{Z} = \sum_{\nu_1, \nu_2} (-Q_b)^{|\nu_1| + |\nu_2|} \mathcal{Z}_{\nu_1 \nu_2}(t, q, Q) \mathcal{Z}_{\nu_2^t \nu_1^t}(q, t, Q') f_{\nu_1}(q, t)^{-1} f_{\nu_2}(q, t), \quad (3.1)$$

where the function $\mathcal{Z}_{\nu_1 \nu_2}(t, q, Q)$ is the building block in Fig. 4 (b1) which is defined by

$$\begin{aligned} \mathcal{Z}_{\nu_1 \nu_2}(t, q, Q) := & \sum_{\mu_1, \mu_2, \mu_3, \mu_f} (-Q_1)^{|\mu_1|} (-Q_2)^{|\mu_2|} (-Q_3)^{|\mu_3|} (-Q_f)^{|\mu_f|} \\ & \times C_{\mu_1^t \mu_3 0}(t, q) C_{\mu_1 \mu_f^t \nu_1}(q, t) C_{\mu_f \mu_2^t \nu_2}(q, t) C_{\mu_3^t \mu_2 0}(t, q) \tilde{f}_{\mu_f^t}(q, t) \tilde{f}_{\mu_3^t}(q, t)^{-1}. \end{aligned} \quad (3.2)$$

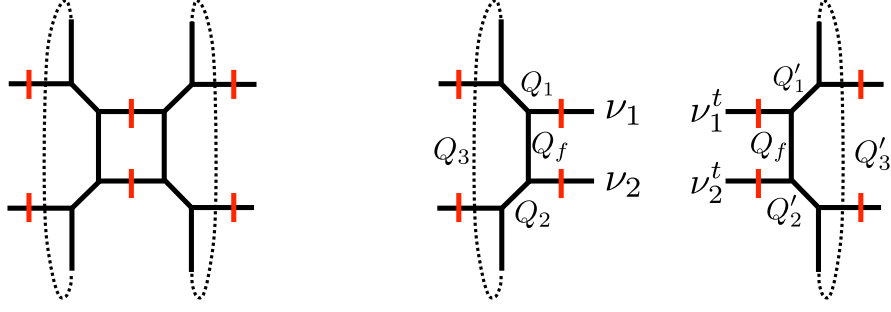

Figure 4: The figure (a) is the web diagram corresponding to the M2-M5 brane system. The parameters Q_3 and Q_f denote the Kähler parameters along the vertical direction, whereas the parameter Q_b denotes the Kähler parameter along the horizontal direction. The figure (b1) and (b2) are its building blocks. The preferred direction is denoted by some red lines.

We also define the topological vertex $C_{\lambda\mu\nu}(t, q)$ and the framing factors $f_\mu(t, q)$ and $\tilde{f}_\mu(t, q)$ as

$$C_{\lambda\mu\nu}(t, q) = t^{-\frac{\|\mu^t\|^2}{2}} q^{\frac{\|\mu\|^2 + \|\nu\|^2}{2}} \tilde{Z}_\nu(t, q) \sum_{\eta} \left(\frac{q}{t}\right)^{\frac{|\eta| + |\lambda| - |\mu|}{2}} s_{\lambda^t/\eta}(t^{-\rho} q^{-\nu}) s_{\mu/\eta}(t^{-\nu^t} q^{-\rho}), \quad (3.3)$$

$$\tilde{Z}_\nu(t, q) = \prod_{(i,j) \in \nu} (1 - q^{\nu_i - j} t^{\nu_j^t - i + 1})^{-1}, \quad (3.4)$$

$$f_\mu(t, q) = (-1)^{|\mu|} q^{-\frac{\|\mu\|^2}{2}} t^{\frac{\|\mu^t\|^2}{2}}, \quad (3.5)$$

$$\tilde{f}_\mu(t, q) = (-1)^{|\mu|} \left(\frac{t}{q}\right)^{\frac{|\mu|}{2}} q^{-\frac{\|\mu\|^2}{2}} t^{\frac{\|\mu^t\|^2}{2}}. \quad (3.6)$$

Physically, the variables t and q are related to the gauge theory parameters (or Ω -background) as follows,

$$t = e^{-2\pi i \epsilon_1}, \quad q = e^{2\pi i \epsilon_2}. \quad (3.7)$$

By substituting above definitions into (3.2), we obtain

$$\begin{aligned} \mathcal{Z}_{\nu_1 \nu_2}(t, q, Q) &= \sum_{\{\mu\}, \{\eta\}} (-Q_1)^{|\mu_1|} (-Q_2)^{|\mu_2|} Q_3^{|\mu_3|} Q_f^{|\mu_f|} \\ &\times \tilde{Z}_{\nu_1}(q, t) \tilde{Z}_{\nu_2}(q, t) t^{\frac{\|\nu_1\|^2 + \|\nu_2\|^2}{2}} \left(\frac{q}{t}\right)^{\frac{|\eta_1| - |\eta_2| - |\eta_3| + |\eta_4|}{2}} \left(\frac{t}{q}\right)^{\frac{|\mu_3|}{2} - \frac{|\mu_f|}{2}} \\ &\times s_{\mu_1/\eta_1}(t^{-\rho}) s_{\mu_3/\eta_1}(q^{-\rho}) s_{\mu_1^t/\eta_2}(q^{-\rho} t^{-\nu_1^t}) s_{\mu_f^t/\eta_2}(t^{-\rho} q^{-\nu_1}) \\ &\times s_{\mu_f^t/\eta_3}(q^{-\rho} t^{-\nu_2}) s_{\mu_2^t/\eta_3}(q^{-\nu_2^t} t^{-\rho}) s_{\mu_3/\eta_4}(t^{-\rho}) s_{\mu_2/\eta_4}(q^{-\rho}). \end{aligned} \quad (3.8)$$

We can calculate (3.8) by using some formulas in Appendix. Then we obtain

$$\begin{aligned}
\hat{\mathcal{Z}}_{\nu_1\nu_2}(t, q, Q) &= \tilde{Z}_{\nu_1}(q, t)\tilde{Z}_{\nu_2}(q, t)t^{\frac{1}{2}(\|\nu_1\|^2+\|\nu_2\|^2)} \\
&\times \prod_{i,j=1}^{\infty} \prod_{n=0}^{\infty} \left[\left\{ \frac{1 - Q_1\Lambda^n t^{-\nu_{1,i}+j-\frac{1}{2}} q^{i-\frac{1}{2}}}{1 - Q_1\Lambda^n t^{j-\frac{1}{2}} q^{i-\frac{1}{2}}} \frac{1 - Q_1^{-1}\Lambda^{n+1} t^{j-\frac{1}{2}} q^{-\nu_{1,j}^t+i-\frac{1}{2}}}{1 - Q_1^{-1}\Lambda^{n+1} t^{j-\frac{1}{2}} q^{i-\frac{1}{2}}} \right. \right. \\
&\times \frac{1 - Q_2\Lambda^n t^{j-\frac{1}{2}} q^{-\nu_{2,j}^t+i-\frac{1}{2}}}{1 - Q_2\Lambda^n t^{j-\frac{1}{2}} q^{i-\frac{1}{2}}} \frac{1 - Q_2^{-1}\Lambda^{n+1} t^{-\nu_{2,i}+j-\frac{1}{2}} q^{i-\frac{1}{2}}}{1 - Q_2^{-1}\Lambda^{n+1} t^{j-\frac{1}{2}} q^{i-\frac{1}{2}}} \\
&\times \frac{1 - Q_1Q_3\Lambda^n t^{-\nu_{1,i}+j-\frac{1}{2}} q^{i-\frac{1}{2}}}{1 - Q_1Q_3\Lambda^n t^{j-\frac{1}{2}} q^{i-\frac{1}{2}}} \frac{1 - (Q_1Q_3)^{-1}\Lambda^{n+1} t^{i-\frac{1}{2}} q^{-\nu_{1,j}^t+j-\frac{1}{2}}}{1 - (Q_1Q_3)^{-1}\Lambda^{n+1} t^{i-\frac{1}{2}} q^{j-\frac{1}{2}}} \\
&\times \left. \frac{1 - Q_2Q_3\Lambda^n t^{j-\frac{1}{2}} q^{-\nu_{2,j}^t+i-\frac{1}{2}}}{1 - Q_2Q_3\Lambda^n t^{j-\frac{1}{2}} q^{i-\frac{1}{2}}} \frac{1 - (Q_2Q_3)^{-1}\Lambda^{n+1} t^{-\nu_{2,i}+j-\frac{1}{2}} q^{i-\frac{1}{2}}}{1 - (Q_2Q_3)^{-1}\Lambda^{n+1} t^{j-\frac{1}{2}} q^{i-\frac{1}{2}}} \right\} \\
&\times \left\{ \frac{1 - Q_f\Lambda^n t^{-\nu_{2,i}+j-1} q^{-\nu_{1,j}^t+i}}{1 - Q_f\Lambda^n t^{j-1} q^i} \frac{1 - Q_f^{-1}\Lambda^{n+1} t^{-\nu_{1,i}+j-1} q^{-\nu_{2,j}^t+i}}{1 - Q_f^{-1}\Lambda^{n+1} t^{i-1} q^j} \right. \\
&\times \left. \frac{1 - \Lambda^{n+1} t^{-\nu_{1,i}+j-1} q^{-\nu_{1,j}^t+i}}{1 - \Lambda^{n+1} t^{j-1} q^i} \frac{1 - \Lambda^{n+1} t^{-\nu_{2,i}+j-1} q^{-\nu_{2,j}^t+i}}{1 - \Lambda^{n+1} t^{j-1} q^i} \right\}^{-1} \Bigg], \\
(\Lambda &:= Q_1Q_2Q_3Q_f),
\end{aligned} \tag{3.9}$$

where we divide (3.9) by the trivial building block,

$$\hat{\mathcal{Z}}_{\nu_1\nu_2} := \frac{\mathcal{Z}_{\nu_1\nu_2}}{\mathcal{Z}_{\emptyset\emptyset}}. \tag{3.10}$$

After some calculation, we obtain the building block in Fig. 4 (b1),

$$\begin{aligned}
\hat{\mathcal{Z}}_{\nu_1\nu_2}(t, q, Q) &= \tilde{Z}_{\nu_1}(q, t)\tilde{Z}_{\nu_2}(q, t)t^{\frac{1}{2}(\|\nu_1\|^2+\|\nu_2\|^2)} \\
&\times \prod_{n=0}^{\infty} \prod_{(i,j) \in \nu_1} \left\{ \frac{(1 - Q_1\Lambda^n t^{-\nu_{1,i}+j-\frac{1}{2}} q^{i-\frac{1}{2}})(1 - Q_1^{-1}\Lambda^{n+1} t^{\nu_{1,i}-j+\frac{1}{2}} q^{-i+\frac{1}{2}})}{(1 - Q_f\Lambda^n t^{\nu_{1,i}-j} q^{\nu_{2,j}^t-i+1})(1 - Q_f^{-1}\Lambda^{n+1} t^{-\nu_{1,i}+j-1} q^{-\nu_{2,j}^t+i})} \right. \\
&\times \frac{(1 - Q_1Q_3\Lambda^n t^{-\nu_{1,i}+j-\frac{1}{2}} q^{i-\frac{1}{2}})(1 - Q_1^{-1}Q_3^{-1}\Lambda^{n+1} t^{\nu_{1,i}-j+\frac{1}{2}} q^{-i+\frac{1}{2}})}{(1 - \Lambda^{n+1} t^{-\nu_{1,i}+j-1} q^{-\nu_{1,j}^t+i})(1 - \Lambda^{n+1} t^{\nu_{1,i}-j} q^{\nu_{2,j}^t-i+1})} \Bigg\} \\
&\times \prod_{(i,j) \in \nu_2} \left\{ \frac{(1 - Q_2\Lambda^n t^{\nu_{2,i}-j+\frac{1}{2}} q^{-i+\frac{1}{2}})(1 - Q_2^{-1}\Lambda^{n+1} t^{-\nu_{2,i}+j-\frac{1}{2}} q^{i-\frac{1}{2}})}{(1 - Q_f\Lambda^n t^{-\nu_{2,i}+j-1} q^{-\nu_{1,j}^t+i})(1 - Q_f^{-1}\Lambda^{n+1} t^{\nu_{2,i}-j} q^{\nu_{1,j}^t-i+1})} \right. \\
&\times \left. \frac{(1 - Q_2Q_3\Lambda^n t^{\nu_{2,i}-j+\frac{1}{2}} q^{-i+\frac{1}{2}})(1 - Q_2^{-1}Q_3^{-1}\Lambda^{n+1} t^{-\nu_{2,i}+j-\frac{1}{2}} q^{i-\frac{1}{2}})}{(1 - \Lambda^{n+1} t^{-\nu_{2,i}+j-1} q^{-\nu_{2,j}^t+i})(1 - \Lambda^{n+1} t^{\nu_{2,i}-j} q^{\nu_{2,j}^t-i+1})} \right\},
\end{aligned} \tag{3.11}$$

and the building block in Fig. 4 (b2),

$$\begin{aligned}
\hat{Z}_{\nu_2^t \nu_1^t}(q, t, Q') &= \tilde{Z}_{\nu_1^t}(t, q) \tilde{Z}_{\nu_2^t}(t, q) q^{\frac{1}{2}(\|\nu_1^t\|^2 + \|\nu_2^t\|^2)} \\
&\times \prod_{n=0}^{\infty} \prod_{(i,j) \in \nu_1} \left\{ \frac{(1 - Q'_1 \Lambda^n t^{-\nu_1, i+j-\frac{1}{2}} q^{i-\frac{1}{2}})(1 - Q'^{-1}_1 \Lambda^{n+1} t^{\nu_1, i-j+\frac{1}{2}} q^{-i+\frac{1}{2}})}{(1 - Q_f \Lambda^n t^{\nu_1, i-j+1} q^{\nu_{2,j}^t - i})(1 - Q_f^{-1} \Lambda^{n+1} t^{-\nu_1, i+j} q^{-\nu_{2,j}^t + i-1})} \right. \\
&\times \left. \frac{(1 - Q'_1 Q'_3 \Lambda^n t^{-\nu_1, i+j-\frac{1}{2}} q^{i-\frac{1}{2}})(1 - Q'^{-1}_1 Q'^{-1}_3 \Lambda^{n+1} t^{\nu_1, i-j+\frac{1}{2}} q^{-i+\frac{1}{2}})}{(1 - \Lambda^{n+1} t^{-\nu_1, i+j} q^{-\nu_{1,j}^t + i-1})(1 - \Lambda^{n+1} t^{\nu_1, i-j+1} q^{\nu_{1,j}^t - i})} \right\} \\
&\times \prod_{(i,j) \in \nu_2} \left\{ \frac{(1 - Q'_2 \Lambda^n t^{\nu_2, i-j+\frac{1}{2}} q^{-i+\frac{1}{2}})(1 - Q'^{-1}_2 \Lambda^{n+1} t^{-\nu_2, i+j-\frac{1}{2}} q^{i-\frac{1}{2}})}{(1 - Q_f \Lambda^n t^{-\nu_2, i+j} q^{-\nu_{1,j}^t + i-1})(1 - Q_f^{-1} \Lambda^{n+1} t^{\nu_2, i-j+1} q^{\nu_{1,j}^t - i})} \right. \\
&\times \left. \frac{(1 - Q'_2 Q'_3 \Lambda^n t^{\nu_2, i-j+\frac{1}{2}} q^{-i+\frac{1}{2}})(1 - Q'^{-1}_2 Q'^{-1}_3 \Lambda^{n+1} t^{-\nu_2, i+j-\frac{1}{2}} q^{i-\frac{1}{2}})}{(1 - \Lambda^{n+1} t^{-\nu_2, i+j} q^{-\nu_{2,j}^t + i-1})(1 - \Lambda^{n+1} t^{\nu_2, i-j+1} q^{\nu_{2,j}^t - i})} \right\}.
\end{aligned} \tag{3.12}$$

By substituting (3.11), (3.12) into (3.1), we find

$$\begin{aligned}
\hat{Z} &= \sum_{\nu_1, \nu_2} \left(-\bar{Q}_b \sqrt{\frac{t}{q}}\right)^{|\nu_1|} \left(-\bar{Q}'_b \sqrt{\frac{t}{q}}\right)^{|\nu_2|} \\
&\times \prod_{(i,j) \in \nu_1} \frac{\theta_1(\tau; u_{ij}^1) \theta_1(\tau; U_{ij}^{2f}) \theta_1(\tau; u_{ij}'^1) \theta_1(\tau; u_{ij}'^{13})}{\theta_1(\tau; y_{ij}^{123}) \theta_1(\tau; v_{ij}^{\nu_1}) \theta_1(\tau; Y_{ij}^f) \theta_1(\tau; V_{ij}^{\nu_1})} \\
&\times \prod_{(i,j) \in \nu_2} \frac{\theta_1(\tau; \tilde{u}_{ij}^2) \theta_1(\tau; \tilde{U}_{ij}^{1f}) \theta_1(\tau; \tilde{u}_{ij}^2) \theta_1(\tau; \tilde{u}_{ij}^{23})}{\theta_1(\tau; w_{ij}^f) \theta_1(\tau; v_{ij}^{\nu_2}) \theta_1(\tau; W_{ij}^{123}) \theta_1(\tau; V_{ij}^{\nu_2})},
\end{aligned} \tag{3.13}$$

where we define some variables as follows:

$$\begin{aligned}
e^{2\pi i \tau} &= \Lambda, \quad \bar{Q}_b = Q_b \sqrt{Q_1 Q'_1 Q_2 / Q'_2}, \quad \bar{Q}'_b = Q_b \sqrt{Q'_1 Q'_2 Q_2 / Q_1}, \\
e^{2\pi i u_{ij}^I} &= Q_I^{-1} t^{\nu_1, i-j+\frac{1}{2}} q^{-i+\frac{1}{2}}, \quad e^{2\pi i \tilde{u}_{ij}^I} = Q_I^{-1} t^{-\nu_2, i+j-\frac{1}{2}} q^{i-\frac{1}{2}}, \\
e^{2\pi i U_{ij}^I} &= Q_I^{-1} t^{-\nu_1, i+j-\frac{1}{2}} q^{i-\frac{1}{2}}, \quad e^{2\pi i \tilde{U}_{ij}^I} = Q_I^{-1} t^{\nu_2, i-j+\frac{1}{2}} q^{-i+\frac{1}{2}}, \\
e^{2\pi i y_{ij}^I} &= Q_I^{-1} t^{\nu_1, i-j+1} q^{\nu_{2,j}^t - i}, \quad e^{2\pi i Y_{ij}^I} = Q_I^{-1} t^{-\nu_1, i+j} q^{-\nu_{2,j}^t + i-1}, \\
e^{2\pi i w_{ij}^I} &= Q_I^{-1} t^{\nu_2, i-j+1} q^{\nu_{1,j}^t - i}, \quad e^{2\pi i W_{ij}^I} = Q_I^{-1} t^{-\nu_2, i+j} q^{-\nu_{1,j}^t + i-1}, \\
e^{2\pi i v_{ij}^{\nu_1}} &= t^{\nu_1, i-j+1} q^{\nu_{1,j}^t - i}, \quad e^{2\pi i V_{ij}^{\nu_1}} = t^{\nu_1, i-j} q^{\nu_{1,j}^t - i+1}.
\end{aligned} \tag{3.14}$$

This expression is slightly different from [3]. However one can show that (3.14) agrees with the result in [3] under the flop transition [26]³.

3.2 Enhancement of Supersymmetry

In this subsection, we observe the enhancement of supersymmetry by tuning the Kähler parameters to special values. Consider the following constraints,

$$Q_2 = \sqrt{\frac{q}{t}}, \quad Q'_2 = \sqrt{\frac{t}{q}} (= Q_2^{-1}). \tag{3.15}$$

³Where we impose the condition $\frac{Q_2}{Q_1} = \frac{Q'_1}{Q'_2}$ which is also used in the reference [3]

Then, the infinite products $\prod_{n=0}^{\infty} \prod_{(i,j) \in \nu_2} (1 - \Lambda^n t^{-\nu_2, i+j} q^{i-1})$ in (3.12) become zero unless the Young diagram ν_2 becomes empty. Thus, after some cancellations, we find

$$\hat{\mathcal{Z}} = \sum_{\nu_1} (-Q_b \sqrt{Q_1 Q'_1})^{|\nu_1|} \prod_{(i,j) \in \nu_1} \frac{\theta_1(\tau; u_{ij}^1) \theta_1(\tau; u_{ij}^{-1})}{\theta_1(\tau; v_{ij}^{\nu_1}) \theta_1(\tau; V_{ij}^{\nu_1})}, \quad (3.16)$$

where we define

$$e^{2\pi i u_{ij}^{-1}} = Q_1 t^{-\nu_1, i+j - \frac{1}{2}} q^{i - \frac{1}{2}}. \quad (3.17)$$

Therefore, we obtain the partition function of k M-strings as follows,

$$\mathcal{Z}_{M\text{-strings}}^k = \sum_{|\nu_1|=k} \prod_{(i,j) \in \nu_1} \frac{\theta_1(\tau; u_{ij}^1) \theta_1(\tau; u_{ij}^{-1})}{\theta_1(\tau; v_{ij}^{\nu_1}) \theta_1(\tau; V_{ij}^{\nu_1})}. \quad (3.18)$$

This partition function agrees with the partition function of M-strings in flat space when we tune the Kähler parameters as follow,

$$Q_1 = Q'_1{}^{-1}. \quad (3.19)$$

According to a discussion in [1], by tuning the Kähler parameters as follows,

$$Q_1 = Q'_1{}^{-1} = \sqrt{\frac{t}{q}}, \quad (3.20)$$

and performing appropriate normalization, the partition function of M-strings (3.18) agrees with the elliptic genus of the $\mathcal{N} = (4, 4)$ $U(k)$ pure gauge theory.

We interpret this result by using the geometric transition [9][28]. In unrefined case ($t = q$), the Kähler parameters become 1,

$$Q_2 = Q'_2 = 1. \quad (3.21)$$

Usually, by the geometric transition[9], the Kähler parameters become multiplicity of branes. However, in this case, the Kähler parameters are 1. This means that there are no branes. Thus, we can remove the framing as in Fig. 5.

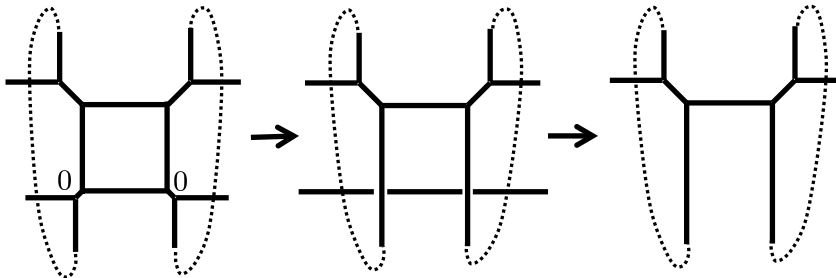

Figure 5: The geometric transition. We can remove the framing and the result is on the right figure.

The right figure of Fig. 5 is related to the web diagram which is considered in [1][3] under the flop transition (see Fig. 6). The Kähler parameters are related as follows,

$$Q' = \tilde{Q}'_1 \tilde{Q}'_1 \tilde{Q}'_1, \quad Q'_1 = \tilde{Q}'_1{}^{-1}, \quad Q_b = \tilde{Q}'_1 \tilde{Q}_b. \quad (3.22)$$

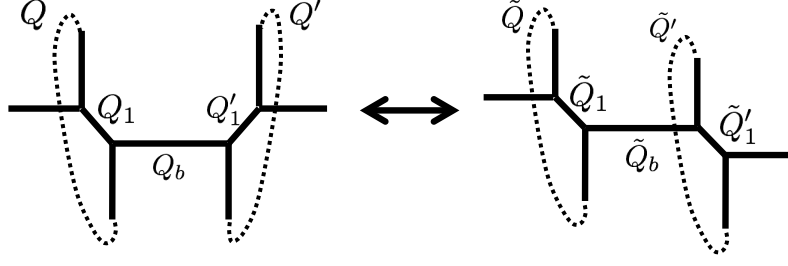

Figure 6: The flop transition.

Thus, we observe that the supersymmetry of M-strings gets enhanced to the $\mathcal{N} = (4, 4)$ by tuning the Kähler parameters.

Moreover, we can interpret this enhancement in terms of the 2 dimensional field theory which is dual to the M-strings.

According to a discussion in [3][29], this M2-M5 brane system is dual to the D1-D5 brane system on A_1 ALE space. k M2-branes, 2 M5-branes, and A_1 ALE space correspond to k D1-branes, A_1 ALE space, and 2 D5-branes, respectively.

IIB theory	X_0	X_1	X_2	X_3	X_4	X_5	X_6	X_7	X_8	X_9
2 D5	○	○	○	○	○	○				
k D1	○	○								
A_1 ALE							○	○	○	○

Table 2: The brane setup which is dual to the M2-M5 brane system in section 2. The M-strings correspond to k D1-branes.

In this case, the theory on k D1-branes is the $\mathcal{N} = (4, 0)$ $U(k)$ gauge theory with one adjoint, two chiral multiplets and two fermi multiplets. If we remove the D5-branes, the theory on k D1-branes is the $\mathcal{N} = (4, 4)$ $U(k)$ pure gauge theory. Therefore, in terms of duality, removal of the framing corresponds to removal of the D5-branes.

We can generalize this enhancement to the theory on multiple M5-branes on A_{N-1} ALE space. This M theory system is dual to the (p, q) 5-brane web which is drawn in Fig. 7. By using the result in [3], the partition function of M M5 branes on A_{N-1} singularity is as follow,

$$\hat{\mathcal{Z}}_M^{A_{N-1}} = \sum_{\text{all indices}} \prod_{s=1}^{M-1} \prod_{a=1}^N \left(\bar{Q}_{f,a}^{(s)} \right)^{|\mu_a^{(s)}|} \prod_{(i,j) \in \mu_a^{(s)}} \prod_{b=1}^N \frac{\theta_1(\tau; z_{ab}^{(s)}(i, j)) \theta_1(\tau; w_{ab}^{(s)}(i, j))}{\theta_1(\tau; u_{ab}^{(s)}(i, j)) \theta_1(\tau; v_{ab}^{(s)}(i, j))}, \quad (3.23)$$

where we define

$$\begin{aligned} e^{2\pi z_{ab}^{(s)}(i, j)} &= \left(Q_{ab}^{(s+1)} \right)^{-1} t^{-\mu_{a,i}^{(s)} + j - 1/2} q^{-\mu_{b,j}^{(s+1),t} + i - 1/2}, \\ e^{2\pi w_{ab}^{(s)}(i, j)} &= \left(Q_{ba}^{(s)} \right)^{-1} t^{\mu_{a,i}^{(s)} - j + 1/2} q^{\mu_{b,j}^{(s-1),t} - i + 1/2}, \\ e^{2\pi u_{ab}^{(s)}(i, j)} &= \left(\hat{Q}_{ba}^{(s)} \right)^{-1} t^{\mu_{a,i}^{(s)} - j} q^{\mu_{b,j}^{(s),t} - i + 1}, \\ e^{2\pi v_{ab}^{(s)}(i, j)} &= \left(\hat{Q}_{ab}^{(s)} \right)^{-1} t^{-\mu_{a,i}^{(s)} + j - 1} q^{-\mu_{b,j}^{(s),t} + i}, \end{aligned} \quad (3.24)$$

and the some parameters $\bar{Q}_{f,a}^{(s)}$, $Q_{ab}^{(s)}$, and $\hat{Q}_{ab}^{(s)}$ are defined as follows,

$$\begin{aligned}
\bar{Q}_{f,a}^{(s)} &= \left(\frac{q}{t}\right)^{\frac{N-1}{2}} Q_{f,a}^{(s)} \prod_{b=1}^N Q_b^{(s)}, \\
\hat{Q}_{ab}^{(s)} &= \begin{cases} 1, & \text{for } a = b \\ \tilde{Q}_{ab}^{(s)}, & \text{for } a \neq b \end{cases} \\
\tilde{Q}_{ab}^{(s)} &= \begin{cases} \prod_{i=b}^{a-1} Q_{\tau_i}^{(s)}, & \text{for } a > b \\ Q_{\tau}, & \text{for } a = b \\ Q_{\tau} / \prod_{i=a}^{b-1} Q_{\tau_i}^{(s)}, & \text{for } a < b \end{cases} \\
Q_{ab}^{(s)} &= \begin{cases} Q_a^{(s)} \prod_{i=b}^N Q_{\tau_i}^{(s)}, & (\text{mod } Q_{\tau}) \quad \text{for } a = 1 \\ Q_a^{(s)} \prod_{i=1}^{a-1} Q_{\tau_i}^{(s)} \prod_{j=b}^N Q_{\tau_j}^{(s)}. & (\text{mod } Q_{\tau}) \quad \text{for } a \neq 1 \end{cases} \quad (3.25)
\end{aligned}$$

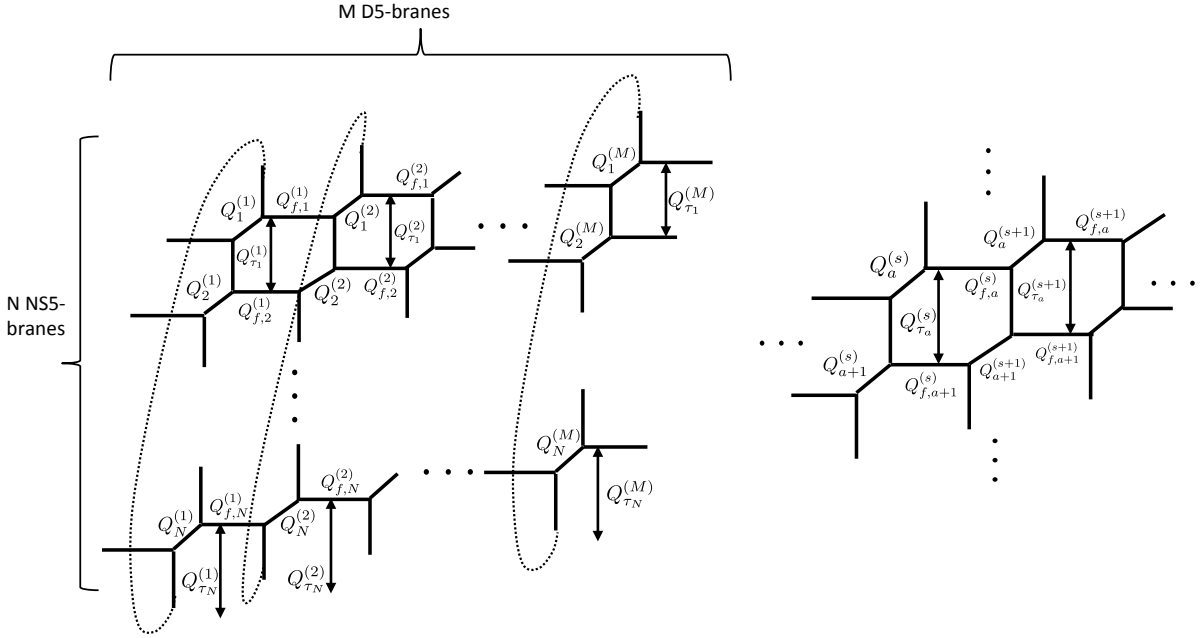

Figure 7: The type IIB brane web which is dual to the M theory system. The right figure is the fraction of the web diagram. The Kähler parameters $Q_a^{(s)}$ and $Q_{\tau_a}^{(s)}$ denote the mass deformations and the distance between two NS5-branes, respectively. The parameters $Q_{f,a}^{(s)}$ denote the Kähler parameters along the horizontal direction.

If we tune the Kähler parameters at the fixed a ,

$$Q_a^{(s)} = \sqrt{\frac{t}{q}}, \quad s = 1, 2, \dots, M \quad (3.26)$$

the contribution of $\mu_a^{(s)}$,

$$\prod_{s=1}^{M-1} \prod_{(i,j) \in \mu_a^{(s)}} \prod_{b=1}^N \frac{\theta_1(\tau; z_{ab}^{(s)}(i,j)) \theta_1(\tau; w_{ab}^{(s)}(i,j))}{\theta_1(\tau; u_{ab}^{(s)}(i,j)) \theta_1(\tau; v_{ab}^{(s)}(i,j))}, \quad (3.27)$$

becomes zero unless the Young diagram $\mu_a^{(s)}$ becomes empty. After several cancellation, the partition function becomes $\hat{\mathcal{Z}}_M^{AN-2}$. In terms of this web diagram, this corresponds to remove the a -th framing by using the geometric transition. In terms of the D1-D5 system on A_{M-1} ALE space, this corresponds to remove one of N D5-branes.

For example, let us consider $a = 1$ case in (3.26). Then the partition function is

$$\hat{\mathcal{Z}}_M^{AN-1} = \sum_{\text{all indices}} \prod_{s=1}^{M-1} \prod_{a=2}^N (\bar{Q}_{f,a}^{(s)})^{|\mu_a^{(s)}|} \prod_{(i,j) \in \mu_a^{(s)}} \prod_{b=1}^N \frac{\theta_1(\tau; z_{ab}^{(s)}(i,j)) \theta_1(\tau; w_{ab}^{(s)}(i,j))}{\theta_1(\tau; u_{ab}^{(s)}(i,j)) \theta_1(\tau; v_{ab}^{(s)}(i,j))}. \quad (3.28)$$

Here we consider $b = 1$ in (3.28). For $b = 1$ and $a > 2$, (3.25) becomes

$$Q_{a1}^{(s+1)} = \sqrt{\frac{t}{q}} \prod_{i=1}^{a-1} Q_{\tau_i}^{(s)}, \quad Q_{1a}^{(s)} = \sqrt{\frac{t}{q}} \prod_{i=a}^N Q_{\tau_i}^{(s)},$$

$$\hat{Q}_{a1}^{(s)} = \prod_{i=1}^{a-1} Q_{\tau_i}^{(s)}, \quad \hat{Q}_{1a}^{(s)} = \prod_{i=a}^N Q_{\tau_i}^{(s)}. \quad (3.29)$$

Then, the contribution of $b = 1$ in (3.28) becomes 1. Therefore, the result is as follows,

$$\hat{\mathcal{Z}}_M^{AN-1} = \sum_{\text{all indices}} \prod_{s=1}^{M-1} \prod_{a=2}^N (\bar{Q}_{f,a}^{(s)})^{|\mu_a^{(s)}|} \prod_{(i,j) \in \mu_a^{(s)}} \prod_{b=2}^N \frac{\theta_1(\tau; z_{ab}^{(s)}(i,j)) \theta_1(\tau; w_{ab}^{(s)}(i,j))}{\theta_1(\tau; u_{ab}^{(s)}(i,j)) \theta_1(\tau; v_{ab}^{(s)}(i,j))}. \quad (3.30)$$

This partition function is the same as $\hat{\mathcal{Z}}_M^{AN-2}$ in appropriate redefinitions of the Kähler parameters.

Therefore, by tuning the Kähler parameters such as (3.26), the supersymmetry of M-strings gets enhanced to $\mathcal{N} = (4, 4)$.

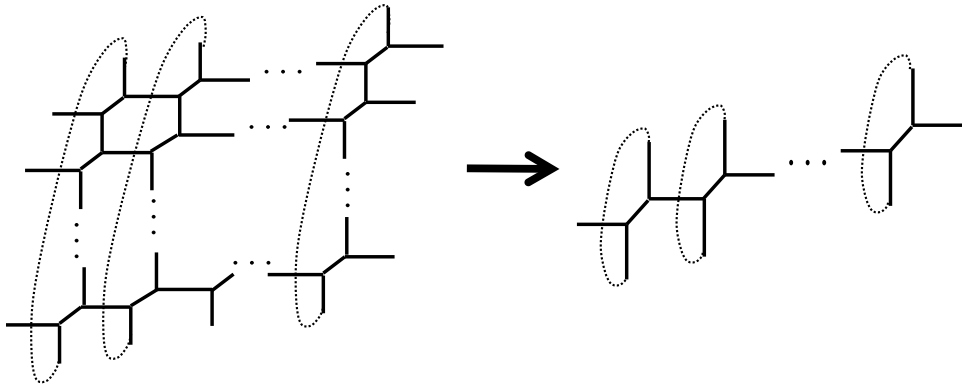

Figure 8: The enhancement of supersymmetry. By tuning the Kähler parameters, the web diagram reduces to the right figure through the geometric transition.

4 Discussion

In this paper, we have calculated the partition function of M-strings by using the refined topological vertex formalism. This partition function is consistent with [3] under the flop transition. Then we

have found that, by tuning the Kähler parameters, the partition function of M-strings has agreed with the $\mathcal{N} = (4, 4)$ partition function of M-strings. We have interpreted this result by considering the geometric transition. We have also interpreted this enhancement in terms of D1-D5 brane system on A_{N-1} ALE space.

Now we want to consider another possibility of the enhancement of supersymmetry. As we mentioned in the previous subsection, the theory on k D1-branes is the $\mathcal{N} = (4, 0)$ $U(k)$ gauge theory with one adjoint, two chiral multiplets and two fermi multiplets. By combining $\mathcal{N} = (4, 0)$ vector multiplet with adjoint multiplet, and $\mathcal{N} = (4, 0)$ chiral multiplets with fermi multiplets, we may be able to obtain $\mathcal{N} = (4, 4)$ vector multiplet and two chiral multiplets. Therefore, we can expect the enhancement of supersymmetry which is different from the one in the previous section.

In order to consider, we calculate the elliptic genus which can be compared with the M-strings partition function calculated by the refined topological string theory. The elliptic genus of the gauge theory can be calculated by using the localization method [30][31][32][33][34]. We can write the elliptic genus of the $\mathcal{N} = (4, 4)$ $U(k)$ gauge theory with two flavors,

$$\begin{aligned}
\mathcal{Z}_{Eu}(t, q, Q_f) &= \oint du_\alpha \left(\frac{2\pi\eta^2(\tau)}{i} \right)^k \frac{1}{k!} \prod_{\alpha, \beta=1}^k \frac{\theta_1(\tau; u_\alpha - u_\beta) \theta_1(\tau; \epsilon_1 + \epsilon_2 + u_\alpha - u_\beta)}{\theta_1(\tau; \epsilon_1 + u_\alpha - u_\beta) \theta_1(\tau; \epsilon_2 + u_\alpha - u_\beta)} \\
&\times \prod_{\alpha=1}^k \frac{\theta_1(\tau; \frac{-\epsilon_1 + \epsilon_2}{2} - \xi_f + u_\alpha) \theta_1(\tau; \frac{-\epsilon_1 + \epsilon_2}{2} + \xi_f - u_\alpha)}{\theta_1(\tau; \frac{\epsilon_1 + \epsilon_2}{2} - \xi_f + u_\alpha) \theta_1(\tau; \frac{\epsilon_1 + \epsilon_2}{2} + \xi_f - u_\alpha)} \\
&\times \prod_{\alpha=1}^k \frac{\theta_1(\tau; \frac{-\epsilon_1 + \epsilon_2}{2} + \xi_f + u_\alpha) \theta_1(\tau; \frac{-\epsilon_1 + \epsilon_2}{2} - \xi_f - u_\alpha)}{\theta_1(\tau; \frac{\epsilon_1 + \epsilon_2}{2} + \xi_f + u_\alpha) \theta_1(\tau; \frac{\epsilon_1 + \epsilon_2}{2} - \xi_f - u_\alpha)}, \tag{4.1}
\end{aligned}$$

where the variable ξ_f denotes the fugacity.

By calculating as with the reference [3], (4.1) may be written as

$$\begin{aligned}
\mathcal{Z}_{Eu} &\sim \sum_{|\nu_1| + |\nu_2| = k} \prod_{\substack{(i_1, j_1) \in \nu_1 \\ (i_2, j_2) \in \nu_1}} \frac{\theta_1(\tau; (j_1 - j_2 + 1)\epsilon_1 + (i_1 - i_2 + 1)\epsilon_2) \theta_1(\tau; (j_1 - j_2)\epsilon_1 + (i_1 - i_2)\epsilon_2)}{\theta_1(\tau; (j_1 - j_2)\epsilon_1 + (i_1 - i_2 + 1)\epsilon_2) \theta_1(\tau; (j_1 - j_2 + 1)\epsilon_1 + (i_1 - i_2)\epsilon_2)} \\
&\times \prod_{(i, j) \in \nu_1} \frac{\theta_1(\tau; (j - 1)\epsilon_1 + i\epsilon_2) \theta_1(\tau; -j\epsilon_1 - (i - 1)\epsilon_2)}{\theta_1(\tau; j\epsilon_1 + i\epsilon_2) \theta_1(\tau; (-j + 1)\epsilon_1 - (i - 1)\epsilon_2)} \\
&\times \prod_{(i, j) \in \nu_1} \frac{\theta_1(\tau; 2\xi_f + (j - 1)\epsilon_1 + i\epsilon_2) \theta_1(\tau; -2\xi_f - j\epsilon_1 - (i - 1)\epsilon_2)}{\theta_1(\tau; 2\xi_f + j\epsilon_1 + i\epsilon_2) \theta_1(\tau; -2\xi_f + (-j + 1)\epsilon_1 - (i - 1)\epsilon_2)} \\
&\times \prod_{\substack{(i_1, j_1) \in \nu_2 \\ (i_2, j_2) \in \nu_2}} \frac{\theta_1(\tau; (j_1 - j_2 + 1)\epsilon_1 + (i_1 - i_2 + 1)\epsilon_2) \theta_1(\tau; (j_1 - j_2)\epsilon_1 + (i_1 - i_2)\epsilon_2)}{\theta_1(\tau; (j_1 - j_2)\epsilon_1 + (i_1 - i_2 + 1)\epsilon_2) \theta_1(\tau; (j_1 - j_2 + 1)\epsilon_1 + (i_1 - i_2)\epsilon_2)} \\
&\times \prod_{(i, j) \in \nu_2} \frac{\theta_1(\tau; -2\xi_f + (j - 1)\epsilon_1 + i\epsilon_2) \theta_1(\tau; 2\xi_f - j\epsilon_1 - (i - 1)\epsilon_2)}{\theta_1(\tau; -2\xi_f + j\epsilon_1 + i\epsilon_2) \theta_1(\tau; 2\xi_f + (-j + 1)\epsilon_1 - (i - 1)\epsilon_2)} \\
&\times \prod_{(i, j) \in \nu_2} \frac{\theta_1(\tau; (j - 1)\epsilon_1 + i\epsilon_2) \theta_1(\tau; -j\epsilon_1 - (i - 1)\epsilon_2)}{\theta_1(\tau; j\epsilon_1 + i\epsilon_2) \theta_1(\tau; (-j + 1)\epsilon_1 - (i - 1)\epsilon_2)}. \tag{4.2}
\end{aligned}$$

On the other hand, we rewrite the partition function calculated by the refined topological string,

$$\begin{aligned}
\hat{\mathcal{Z}} &= \sum_{\nu_1, \nu_2} \left(Q_1 Q'_1 Q_2 Q'_2 Q_b \right)^{\frac{|\nu_1| + |\nu_2|}{2}} \\
&\times \prod_{(i,j) \in \nu_1} \frac{\theta_1(\tau; u_{ij}^1) \theta_1(\tau; U_{ij}^{2f}) \theta_1(\tau; u_{ij}^{1'}) \theta_1(\tau; U_{ij}^{2f'})}{\theta_1(\tau; \hat{y}_{ij}^f) \theta_1(\tau; v_{ij}^{\nu_1}) \theta_1(\tau; Y_{ij}^f) \theta_1(\tau; V_{ij}^{\nu_1})} \\
&\times \prod_{(i,j) \in \nu_2} \frac{\theta_1(\tau; \tilde{u}_{ij}^{2'}) \theta_1(\tau; \tilde{U}_{ij}^{1f'}) \theta_1(\tau; \tilde{u}_{ij}^2) \theta_1(\tau; \tilde{U}_{ij}^{1f})}{\theta_1(\tau; w_{ij}^f) \theta_1(\tau; v_{ij}^{\nu_2}) \theta_1(\tau; \hat{W}_{ij}^f) \theta_1(\tau; V_{ij}^{\nu_2})},
\end{aligned} \tag{4.3}$$

where we define

$$e^{2\pi i \hat{y}_{ij}^f} = Q_I^{-1} t^{-\nu_1, i+j-1} q^{-\nu_2, j+i}, \quad e^{2\pi i \hat{W}_{ij}^f} = Q_I^{-1} t^{\nu_2, i-j} q^{\nu_1, j-i+1}. \tag{4.4}$$

Then, we define the partition function of k M-strings as follows,

$$\begin{aligned}
\hat{\mathcal{Z}}_{M\text{-strings}}^k &= \sum_{|\nu_1| + |\nu_2| = k} \prod_{(i,j) \in \nu_1} \frac{\theta_1(\tau; u_{ij}^1) \theta_1(\tau; U_{ij}^{2f}) \theta_1(\tau; u_{ij}^{1'}) \theta_1(\tau; U_{ij}^{2f'})}{\theta_1(\tau; \hat{y}_{ij}^f) \theta_1(\tau; v_{ij}^{\nu_1}) \theta_1(\tau; Y_{ij}^f) \theta_1(\tau; V_{ij}^{\nu_1})} \\
&\times \prod_{(i,j) \in \nu_2} \frac{\theta_1(\tau; \tilde{u}_{ij}^{2'}) \theta_1(\tau; \tilde{U}_{ij}^{1f'}) \theta_1(\tau; \tilde{u}_{ij}^2) \theta_1(\tau; \tilde{U}_{ij}^{1f})}{\theta_1(\tau; w_{ij}^f) \theta_1(\tau; v_{ij}^{\nu_2}) \theta_1(\tau; \hat{W}_{ij}^f) \theta_1(\tau; V_{ij}^{\nu_2})}
\end{aligned} \tag{4.5}$$

Then, we find that (4.2) is similar to (4.5). Indeed, for $\nu_1 = \emptyset$ or $\nu_2 = \emptyset$, (4.2) agrees with (4.5) by tuning the Kähler parameters as follows,

$$Q_1 = Q_2 = \sqrt{\frac{1}{tq}}, \quad Q'_1 = Q'_2 = \sqrt{tq}. \tag{4.6}$$

(4.6) means that we set the mass parameter m to zero. The partition function (4.5) in $\nu_1 = \emptyset$ or $\nu_2 = \emptyset$ means that we take the contribution of the strings which are stretched along the lower framing (Fig. 9 (a)) or the upper framing (Fig. 9 (b)).

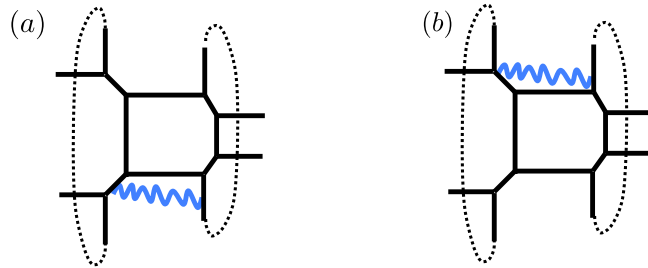

Figure 9: The contribution of strings.

Thus, we can expect the enhancement of supersymmetry which is different from the one in the previous section.

However, we could not obtain the elliptic genus which agreed with the partition function of M-strings perfectly. This result about the elliptic genus depends on taking some poles. Therefore, we would like to consider this problem as a future work.

Acknowledgement

I would like to thank Satoshi Yamaguchi for several discussion and check the manuscript. I would also like to thank to Hironori Mori for some comments and discussion.

A Definition and Formula

The theta function, the refined topological vertex, and its gluing factor are defined as follows:

- The theta function and its property

$$\begin{aligned}\theta_1(\tau; z) &= -ie^{\frac{i\pi\tau}{4}} e^{i\pi z} \prod_{n=0}^{\infty} \left\{ (1 - e^{2\pi i(n+1)\tau})(1 - e^{2\pi i(n+1)\tau} e^{2\pi iz})(1 - e^{2\pi in\tau} e^{-2\pi iz}) \right\} \\ &= -ie^{\frac{i\pi\tau}{4}} (e^{i\pi z} - e^{-i\pi z}) \\ &\quad \times \prod_{n=0}^{\infty} \left\{ (1 - e^{2\pi i(n+1)\tau})(1 - e^{2\pi i(n+1)\tau} e^{2\pi iz})(1 - e^{2\pi i(n+1)\tau} e^{-2\pi iz}) \right\}\end{aligned}\tag{A.1}$$

$$\theta_1(\tau; -z) = -\theta_1(\tau; z)\tag{A.2}$$

- The refined topological vertex

$$\begin{aligned}C_{\lambda\mu\nu}(t, q) &= t^{-\frac{\|\mu^t\|^2}{2}} q^{\frac{\|\mu\|^2 + \|\nu\|^2}{2}} \tilde{Z}_\nu(t, q) \\ &\quad \times \sum_{\eta} \left(\frac{q}{t}\right)^{\frac{|\eta| + |\lambda| - |\mu|}{2}} s_{\lambda^t/\eta}(t^{-\rho} q^{-\nu}) s_{\mu/\eta}(t^{-\nu^t} q^{-\rho})\end{aligned}\tag{A.3}$$

$$\tilde{Z}_\nu(t, q) = \prod_{(i,j) \in \nu} (1 - q^{\nu_i - j} t^{\nu_j^t - i + 1})^{-1}$$

- The gluing factors

$$f_\mu(t, q) = (-1)^{|\mu|} q^{-\frac{\|\mu\|^2}{2}} t^{\frac{\|\mu^t\|^2}{2}}, \quad \tilde{f}_\mu(t, q) = (-1)^{|\mu|} \left(\frac{t}{q}\right)^{\frac{|\mu|}{2}} q^{-\frac{\|\mu\|^2}{2}} t^{\frac{\|\mu^t\|^2}{2}},\tag{A.4}$$

We can use some formulas to calculate the partition function and the recursion formula that we will explain in the next subsection:

- Some formulas about schur polynomial

$$s_{\lambda/\mu}(\alpha \mathbf{x}) = \alpha^{|\lambda| - |\mu|} s_{\lambda/\mu}(\mathbf{x})\tag{A.5}$$

$$\sum_{\eta} s_{\eta/\lambda}(\mathbf{x}) s_{\eta/\mu}(\mathbf{y}) = \prod_{i,j=1}^{\infty} (1 - x_i y_j)^{-1} \sum_{\tau} s_{\mu/\tau}(\mathbf{x}) s_{\lambda/\tau}(\mathbf{y})\tag{A.6}$$

$$\sum_{\eta} s_{\eta^t/\lambda}(\mathbf{x}) s_{\eta/\mu}(\mathbf{y}) = \prod_{i,j=1}^{\infty} (1 + x_i y_j) \sum_{\tau} s_{\mu^t/\tau}(\mathbf{x}) s_{\lambda^t/\tau^t}(\mathbf{y})\tag{A.7}$$

- Normalization

$$\prod_{i,j=1}^{\infty} \frac{1 - Qq^{\nu_i - j} t^{\mu_j^t - i + 1}}{1 - Qq^{-j} t^{-i + 1}} = \prod_{(i,j) \in \nu} (1 - Qq^{\nu_i - j} t^{\mu_j^t - i + 1}) \prod_{(i,j) \in \mu} (1 - Qq^{-\mu_i + j - 1} t^{-\nu_j^t + i})\tag{A.8}$$

$$\prod_{i,j=1}^{\infty} \frac{1 - Qt^{\nu_j^t - i + \frac{1}{2}} q^{-j + \frac{1}{2}}}{1 - Qt^{-i + \frac{1}{2}} q^{-j + \frac{1}{2}}} = \prod_{(i,j) \in \nu} (1 - Qq^{-j + \frac{1}{2}} t^{i - \frac{1}{2}})\tag{A.9}$$

$$\prod_{i,j=1}^{\infty} \frac{1 - Qq^{\nu_i - j + \frac{1}{2}} t^{-i + \frac{1}{2}}}{1 - Qq^{-j + \frac{1}{2}} t^{-i + \frac{1}{2}}} = \prod_{(i,j) \in \nu} (1 - Qq^{j - \frac{1}{2}} t^{-i + \frac{1}{2}})\tag{A.10}$$

- Some factor calculation

$$\sum_{(i,j) \in \nu} (\nu_i - j + \nu_j^t - i + 1) = \frac{\|\nu\|^2}{2} + \frac{\|\nu^t\|^2}{2}, \quad \sum_{(i,j) \in \nu} (j - i) = \frac{\|\nu\|^2}{2} \quad (\text{A.11})$$

$$\sum_{(i,j) \in \nu} \mu_j^t = \sum_{(i,j) \in \mu} \nu_j^t, \quad \sum_{(i,j) \in \nu} \nu_j^t = \|\nu^t\|^2 \quad (\text{A.12})$$

$$\sum_{(i,j) \in \nu} (\nu_j^t - i) = \frac{\|\nu^t\|^2}{2} - \frac{|\nu|}{2}, \quad \sum_{(i,j) \in \nu} (\nu_i - j) = \frac{\|\nu\|^2}{2} - \frac{|\nu|}{2} \quad (\text{A.13})$$

$$\sum_{(i,j) \in \mu} i = \frac{\|\mu^t\|}{2} + \frac{|\mu|}{2}, \quad \sum_{(i,j) \in \mu} j = \frac{\|\mu\|}{2} + \frac{|\mu|}{2} \quad (\text{A.14})$$

B Recursion Formula and Flop Transition

In this section, we calculate the building block about two cases, and we derive the recursion formula. Then, we discuss how to connect two building blocks under the flop transition.

B.1 Simple case

we consider the following web diagrams, (a) and (b).

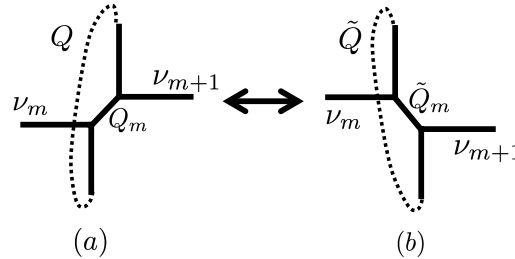

Figure B.1: The simple web diagrams where Q_m and QQ_m denote the mass deformation and the radius of compactification, respectively. The preferred direction is along the horizontal.

Then, we can write the partition function for the web diagram (a),

$$\begin{aligned} \mathcal{Z}_{\nu_m \nu_{m+1}}^{(a)} &= \sum_{\mu_m, \mu} (-Q_m)^{|\mu_m|} (-Q)^{|\mu|} C_{\mu \mu_m \nu_m^t}(t, q) C_{\mu^t \mu_m^t \nu_{m+1}}(q, t) \\ &= q^{\frac{1}{2} \|\nu_m^t\|} t^{\frac{1}{2} \|\nu_{m+1}\|} \tilde{Z}_{\nu_m^t}(t, q) \tilde{Z}_{\nu_{m+1}}(q, t) \\ &\quad \times \sum_{\mu_m, \mu, \eta_{1,2}} (-Q_m)^{|\mu_m|} (-Q)^{|\mu|} s_{\mu/\eta_1}(t^{-\rho+\frac{1}{2}} q^{-\nu_m^t-\frac{1}{2}}) s_{\mu^t/\eta_2}(q^{-\rho+\frac{1}{2}} t^{-\nu_{m+1}-\frac{1}{2}}) \\ &\quad \times s_{\mu_m^t/\eta_1}(q^{-\rho} t^{-\nu_m}) s_{\mu_m/\eta_2}(t^{-\rho} q^{-\nu_{m+1}^t}). \end{aligned} \quad (\text{B.1})$$

In order to calculate this, we consider the following equation,

$$A(x_1, x_2, x_3, x_4) = \sum_{\mu_m, \mu, \eta_{1,2}} \alpha_m^{|\mu_m|} \alpha^{|\mu|} s_{\mu/\eta_1}(x_1) s_{\mu^t/\eta_2}(x_2) s_{\mu_m^t/\eta_1}(x_3) s_{\mu_m/\eta_2}(x_4). \quad (\text{B.2})$$

We can use the formula in the reference [1]. Then we obtain

$$\begin{aligned}
\hat{\mathcal{Z}}_{\nu_m \nu_{m+1}}^{(a)} &:= \mathcal{Z}_{\nu_m \nu_{m+1}}^{(a)} / \mathcal{Z}_{\emptyset \emptyset}^{(a)} \\
&= q^{\frac{1}{2} \|\nu_m^t\| t^{\frac{1}{2}} \|\nu_{m+1}\|} \\
&\quad \times \prod_{n=0}^{\infty} \prod_{(i,j) \in \nu_m} \frac{(1 - Q_m Q_\tau^n t^{-\nu_{m,i} + j - \frac{1}{2}} q^{-\nu_{m+1,j}^t + i - \frac{1}{2}}) (1 - Q_m^{-1} Q_\tau^{n+1} t^{\nu_{m,i} - j + \frac{1}{2}} q^{\nu_{m+1,j}^t - i + \frac{1}{2}})}{(1 - Q_\tau^n t^{\nu_{m,i} - j + 1} q^{\nu_{m,j}^t - i}) (1 - Q_\tau^{n+1} t^{-\nu_{m,i} + j} q^{-\nu_{m,j}^t + i - 1})} \\
&\quad \times \prod_{(i,j) \in \nu_{m+1}} \frac{(1 - Q_m Q_\tau^n t^{\nu_{m+1,i} - j + \frac{1}{2}} q^{\nu_{m,j}^t - i + \frac{1}{2}}) (1 - Q_m^{-1} Q_\tau^{n+1} t^{-\nu_{m+1,i} + j - \frac{1}{2}} q^{-\nu_{m,j}^t + i - \frac{1}{2}})}{(1 - Q_\tau^n t^{\nu_{m+1,i} - j} q^{\nu_{m+1,j}^t - i + 1}) (1 - Q_\tau^{n+1} t^{-\nu_{m+1,i} + j - 1} q^{-\nu_{m,j}^t + i})},
\end{aligned} \tag{B.3}$$

where we define $Q_\tau = Q_m Q$.

Next we calculate the partition function for the web diagram (b). This calculation is the same as the partition function $\mathcal{Z}_{\nu_m \nu_{m+1}}^{(a)}$. Then we obtain

$$\begin{aligned}
\mathcal{Z}_{\nu_m \nu_{m+1}}^{(b)} &= \sum_{\mu_m, \mu} (-\tilde{Q}_m)^{|\mu_m|} (-\tilde{Q})^{|\mu|} C_{\mu_m \mu \nu_m^t}(t, q) C_{\mu_m^t \mu^t \nu_{m+1}}(q, t) \\
&= q^{\frac{1}{2} \|\nu_m^t\| t^{\frac{1}{2}} \|\nu_{m+1}\|} \tilde{Z}_{\nu_m^t}(t, q) \tilde{Z}_{\nu_{m+1}}(q, t) \\
&\quad \times \sum_{\mu_m, \mu, \eta_{1,2}} (-\tilde{Q}_m)^{|\mu_m|} (-\tilde{Q})^{|\mu|} s_{\mu_m / \eta_1}(t^{-\rho + \frac{1}{2}} q^{-\nu_m^t - \frac{1}{2}}) s_{\mu_m^t / \eta_2}(q^{-\rho + \frac{1}{2}} t^{-\nu_{m+1} - \frac{1}{2}}) \\
&\quad \times s_{\mu^t / \eta_1}(q^{-\rho} t^{-\nu_m}) s_{\mu / \eta_2}(t^{-\rho} q^{-\nu_{m+1}}),
\end{aligned} \tag{B.4}$$

and

$$\begin{aligned}
\hat{\mathcal{Z}}_{\nu_m \nu_{m+1}}^{(b)} &:= \mathcal{Z}_{\nu_m \nu_{m+1}}^{(b)} / \mathcal{Z}_{\emptyset \emptyset}^{(b)} \\
&= q^{\frac{1}{2} \|\nu_m^t\| t^{\frac{1}{2}} \|\nu_{m+1}\|} \\
&\quad \times \prod_{n=0}^{\infty} \prod_{(i,j) \in \nu_m} \frac{(1 - \tilde{Q}_m \tilde{Q}_\tau^n t^{\nu_{m,i} - j + \frac{1}{2}} q^{\nu_{m+1,j}^t - i + \frac{1}{2}}) (1 - \tilde{Q}_m^{-1} \tilde{Q}_\tau^{n+1} t^{-\nu_{m,i} + j - \frac{1}{2}} q^{-\nu_{m+1,j}^t + i - \frac{1}{2}})}{(1 - \tilde{Q}_\tau^n t^{\nu_{m,i} - j + 1} q^{\nu_{m,j}^t - i}) (1 - \tilde{Q}_\tau^{n+1} t^{-\nu_{m,i} + j} q^{-\nu_{m,j}^t + i - 1})} \\
&\quad \times \prod_{(i,j) \in \nu_{m+1}} \frac{(1 - \tilde{Q}_m \tilde{Q}_\tau^n t^{-\nu_{m+1,i} + j - \frac{1}{2}} q^{-\nu_{m,j}^t + i - \frac{1}{2}}) (1 - \tilde{Q}_m^{-1} \tilde{Q}_\tau^{n+1} t^{\nu_{m+1,i} - j + \frac{1}{2}} q^{\nu_{m,j}^t - i + \frac{1}{2}})}{(1 - \tilde{Q}_\tau^n t^{\nu_{m+1,i} - j} q^{\nu_{m+1,j}^t - i + 1}) (1 - \tilde{Q}_\tau^{n+1} t^{-\nu_{m+1,i} + j - 1} q^{-\nu_{m,j}^t + i})}.
\end{aligned} \tag{B.5}$$

These results agree with each other under the flop transition (see Fig. B.1). The Kähler parameters are related as follows,

$$Q_m = \tilde{Q}_m^{-1}, \quad Q_\tau = \tilde{Q}_\tau (Q = \tilde{Q}_m \tilde{Q} \tilde{Q}_m). \tag{B.6}$$

B.2 Little complicated case

In this subsection we calculate the following web diagram (see Fig. B.2).

We have already written the partition function for the web diagram (c) in section 3. In order to calculate this, we consider the following equation,

$$\begin{aligned}
F(x_1, x_2, \dots, x_8) &= \sum_{\mu_{f,1,2,3}, \eta_{1,2,3,4}} \alpha_f^{|\mu_f|} \alpha_1^{|\mu_1|} \alpha_2^{|\mu_2|} \alpha_3^{|\mu_3|} \beta_1^{|\eta_1|} \beta_2^{|\eta_2|} \beta_3^{|\eta_3|} \beta_4^{|\eta_4|} \\
&\quad \times s_{\mu_1 / \eta_1}(\mathbf{x}_1) s_{\mu_3 / \eta_1}(\mathbf{x}_2) s_{\mu_1^t / \eta_2}(\mathbf{x}_3) s_{\mu_f^t / \eta_2}(\mathbf{x}_4) \\
&\quad \times s_{\mu_f^t / \eta_3}(\mathbf{x}_5) s_{\mu_2^t / \eta_3}(\mathbf{x}_6) s_{\mu_3 / \eta_4}(\mathbf{x}_7) s_{\mu_2 / \eta_4}(\mathbf{x}_8).
\end{aligned} \tag{B.7}$$

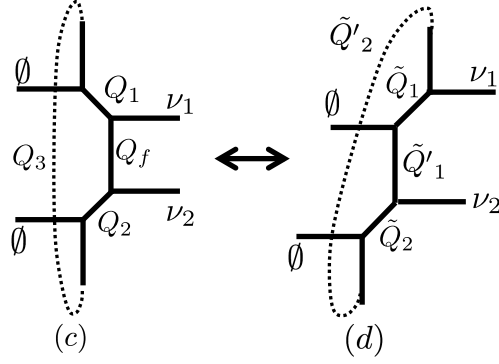

Figure B.2: The flop transition for the little complicated web diagram.

We calculate (B.7) by using some formulas in Appendix A. Then we obtain

$$\begin{aligned}
F(\mathbf{x}_i) &= \prod_{i,j=1}^{\infty} \frac{(1 + \alpha_1 x_1^i x_3^j)(1 + \alpha_2 x_6^i x_8^j)(1 + \alpha_1^{-1} \Lambda \beta_3 \beta_4 x_2^i x_4^j)(1 + \alpha_2^{-1} \Lambda \beta_1 \beta_2 x_5^i x_7^j)}{(1 - \alpha_3 x_2^i x_7^j)(1 - \alpha_f x_4^i x_5^j)(1 - \alpha_f^{-1} \Lambda \beta_1 \beta_4 x_3^i x_6^j)(1 - \alpha_3^{-1} \Lambda \beta_2 \beta_3 x_1^i x_8^j)} \\
&\times \frac{(1 + \alpha_1 \alpha_3 \beta_1 x_3^i x_7^j)(1 + \alpha_2 \alpha_3 \beta_4 x_2^i x_6^j)(1 + \alpha_1^{-1} \alpha_2^{-1} \Lambda \beta_2 x_4^i x_8^j)(1 + \alpha_2^{-1} \alpha_3^{-1} \Lambda \beta_2 x_1^i x_5^j)}{(1 - \Lambda \beta_2 \beta_3 \beta_4 x_1^i x_2^j)(1 - \Lambda \beta_1 \beta_3 \beta_4 x_3^i x_4^j)(1 - \Lambda \beta_1 \beta_2 \beta_4 x_5^i x_6^j)(1 - \Lambda \beta_1 \beta_2 \beta_3 x_7^i x_8^j)} \\
&\times \frac{(1 + \alpha_1 \Lambda x_1^i x_3^j)(1 + \alpha_2 \Lambda x_6^i x_8^j)(1 + \alpha_1^{-1} \Lambda^2 \beta_3 \beta_4 x_2^i x_4^j)(1 + \alpha_2^{-1} \Lambda^2 \beta_1 \beta_2 x_5^i x_7^j)}{(1 - \alpha_3 \Lambda x_2^i x_7^j)(1 - \alpha_f \Lambda x_4^i x_5^j)(1 - \alpha_f^{-1} \Lambda^2 \beta_1 \beta_4 x_3^i x_6^j)(1 - \alpha_3^{-1} \Lambda^2 \beta_2 \beta_3 x_1^i x_8^j)} \\
&\times \frac{(1 + \alpha_1 \alpha_3 \Lambda \beta_1 x_3^i x_7^j)(1 + \alpha_2 \alpha_3 \beta_4 \Lambda x_2^i x_6^j)(1 + \alpha_1^{-1} \alpha_2^{-1} \Lambda^2 \beta_2 x_4^i x_8^j)(1 + \alpha_2^{-1} \alpha_3^{-1} \Lambda^2 \beta_2 x_1^i x_5^j)}{(1 - \Lambda^2 \beta_2 \beta_3 \beta_4 x_1^i x_2^j)(1 - \Lambda^2 \beta_1 \beta_3 \beta_4 x_3^i x_4^j)(1 - \Lambda^2 \beta_1 \beta_2 \beta_4 x_5^i x_6^j)(1 - \Lambda^2 \beta_1 \beta_2 \beta_3 x_7^i x_8^j)} \\
&\times F(\Lambda \mathbf{x}_i) \\
&=: G(\mathbf{x}) F(\Lambda \mathbf{x}_i).
\end{aligned} \tag{B.8}$$

($\Lambda := \alpha_1 \alpha_2 \alpha_3 \alpha_f$)

Thus, we get

$$F(x_i) = \prod_{i=1}^{\infty} G(\Lambda^{i-1} \mathbf{x}) \lim_{n \rightarrow \infty} F(\Lambda^n \mathbf{x}_i). \tag{B.9}$$

In order to consider the non-zero value for $\lim_{n \rightarrow \infty} F(\Lambda^n \mathbf{x}_i)$, we set the representation of some schur functions to trivial. In order to do this, we restrict (B.7) to

$$\begin{aligned}
\mu_3^t &= \eta_1, & \mu_1^t &= \eta_1, & \mu_f &= \eta_2, & \mu_1 &= \eta_2, \\
\mu_2 &= \eta_3, & \mu_f &= \eta_3, & \mu_2^t &= \eta_4, & \mu_3^t &= \eta_4.
\end{aligned} \tag{B.10}$$

Then we obtain⁴

$$\begin{aligned}
\lim_{n \rightarrow \infty} F(\Lambda^n \mathbf{x}_i) &= \sum_{\eta} \Lambda^{|\eta|} \Gamma^{|\eta|} \\
&= \prod_{k=1}^{\infty} (1 - \Lambda^k \Gamma^k)^{-1}.
\end{aligned} \tag{B.11}$$

($\Gamma := \beta_1 \beta_2 \beta_3 \beta_4$)

⁴We assume $\lim_{n \rightarrow \infty} \Lambda^n = 0$.

Therefore, we conclude

$$F(\mathbf{x}_i) = \prod_{k=1}^{\infty} (1 - \Lambda^k \Gamma^k)^{-1} \prod_{i=1}^{\infty} G(\Lambda^{i-1} \mathbf{x}). \quad (\text{B.12})$$

Next we calculate the partition function for the web diagram (d). This partition function has been calculated in the reference [3]. Then, in the above definition of the Kähler parameters, we find

$$\begin{aligned} \hat{\mathcal{Z}}_{\nu_1 \nu_2} &= \tilde{Z}_{\nu_1}(q, t) \tilde{Z}_{\nu_2}(q, t) t^{\frac{1}{2}(\|\nu_1\|^2 + \|\nu_2\|^2)} \\ &\times \prod_{n=0}^{\infty} \prod_{(i,j) \in \nu_1} \left\{ \frac{(1 - \tilde{Q}_1 \Lambda^n t^{\nu_{1,i} - j + \frac{1}{2}} q^{-i + \frac{1}{2}}) (1 - \tilde{Q}_1^{-1} \Lambda^{n+1} t^{-\nu_{1,i} + j - \frac{1}{2}} q^{i - \frac{1}{2}})}{(1 - \Lambda^{n+1} t^{-\nu_{1,i} + j - 1} q^{-\nu_{1,j}^t + i}) (1 - \Lambda^{n+1} t^{\nu_{1,i} - j} q^{\nu_{1,j}^t - i + 1})} \right\} \\ &\times \frac{(1 - \tilde{Q}_1 \tilde{Q}_2 \tilde{Q}'_1 \Lambda^n t^{\nu_{1,i} - j + \frac{1}{2}} q^{-i + \frac{1}{2}}) (1 - \tilde{Q}_1^{-1} \tilde{Q}_2^{-1} \tilde{Q}'_1^{-1} \Lambda^{n+1} t^{-\nu_{1,i} + j - \frac{1}{2}} q^{i - \frac{1}{2}})}{(1 - \tilde{Q}_1 \tilde{Q}'_1 \Lambda^n t^{\nu_{1,i} - j} q^{\nu_{2,j}^t - i + 1}) (1 - \tilde{Q}_2 \tilde{Q}'_2 \Lambda^n t^{-\nu_{1,i} + j - 1} q^{-\nu_{2,j}^t + i})} \\ &\times \prod_{(i,j) \in \nu_2} \left\{ \frac{(1 - \tilde{Q}_2 \Lambda^n t^{\nu_{2,i} - j + \frac{1}{2}} q^{-i + \frac{1}{2}}) (1 - \tilde{Q}_2^{-1} \Lambda^{n+1} t^{-\nu_{2,i} + j - \frac{1}{2}} q^{i - \frac{1}{2}})}{(1 - \Lambda^{n+1} t^{-\nu_{2,i} + j - 1} q^{-\nu_{2,j}^t + i}) (1 - \Lambda^{n+1} t^{\nu_{2,i} - j} q^{\nu_{2,j}^t - i + 1})} \right\} \\ &\times \frac{(1 - \tilde{Q}_1 \tilde{Q}_2 \tilde{Q}'_2 \Lambda^n t^{\nu_{2,i} - j + \frac{1}{2}} q^{-i + \frac{1}{2}}) (1 - \tilde{Q}_1^{-1} \tilde{Q}_2^{-1} \tilde{Q}'_2^{-1} \Lambda^{n+1} t^{-\nu_{2,i} + j - \frac{1}{2}} q^{i - \frac{1}{2}})}{(1 - \tilde{Q}_1 \tilde{Q}'_1 \Lambda^n t^{-\nu_{2,i} + j - 1} q^{-\nu_{1,j}^t + i}) (1 - \tilde{Q}_2 \tilde{Q}'_2 \Lambda^n t^{\nu_{2,i} - j} q^{\nu_{1,j}^t - i + 1})} \left. \right\}. \quad (\text{B.13}) \end{aligned}$$

Again these results agree with each other under the flop transition. The Kähler parameters are related as follows,

$$Q_1 = \tilde{Q}_1^{-1}, \quad Q_f = \tilde{Q}_1 \tilde{Q}'_1, \quad Q_2 = \tilde{Q}_2, \quad Q_3 = \tilde{Q}_1 \tilde{Q}'_2. \quad (\text{B.14})$$

References

- [1] B. Haghighat, A. Iqbal, C. Kozcaz, G. Lockhart and C. Vafa, “M-Strings,” *Commun. Math. Phys.* **334** (2015) 2, 779 [arXiv:1305.6322 [hep-th]].
- [2] S. Hohenegger and A. Iqbal, “M-strings, elliptic genera and $\mathcal{N} = 4$ string amplitudes,” *Fortsch. Phys.* **62**, 155 (2014) [arXiv:1310.1325 [hep-th]].
- [3] B. Haghighat, C. Kozcaz, G. Lockhart and C. Vafa, “Orbifolds of M-strings,” *Phys. Rev. D* **89**, no. 4, 046003 (2014) [arXiv:1310.1185 [hep-th]].
- [4] H. C. Kim, S. Kim, S. S. Kim and K. Lee, “The general M5-brane superconformal index,” arXiv:1307.7660.
- [5] J. Kim, S. Kim, K. Lee and J. Park, “Super-Yang-Mills theories on $S^4 \times \mathbb{R}$,” *JHEP* **1408**, 167 (2014) [arXiv:1405.2488 [hep-th]].
- [6] S. Hohenegger, A. Iqbal and S. J. Rey, “M-strings, monopole strings, and modular forms,” *Phys. Rev. D* **92**, no. 6, 066005 (2015) [arXiv:1503.06983 [hep-th]].
- [7] H. Hayashi, S. S. Kim, K. Lee, M. Taki and F. Yagi, “A new 5d description of 6d D-type minimal conformal matter,” *JHEP* **1508**, 097 (2015) [arXiv:1505.04439 [hep-th]].
- [8] O. Aharony, A. Hanany and B. Kol, “Webs of (p,q) five-branes, five-dimensional field theories and grid diagrams,” *JHEP* **9801** (1998) 002 [hep-th/9710116].
- [9] R. Gopakumar and C. Vafa, “M theory and topological strings. 1.,” hep-th/9809187.
- [10] R. Gopakumar and C. Vafa, “M theory and topological strings. 2.,” hep-th/9812127.
- [11] N. C. Leung and C. Vafa, “Branes and toric geometry,” *Adv. Theor. Math. Phys.* **2** (1998) 91 [hep-th/9711013].
- [12] T. J. Hollowood, A. Iqbal and C. Vafa, “Matrix models, geometric engineering and elliptic genera,” *JHEP* **0803** (2008) 069 [hep-th/0310272].
- [13] M. Aganagic, M. Marino and C. Vafa, “All loop topological string amplitudes from Chern-Simons theory,” *Commun. Math. Phys.* **247** (2004) 467 [hep-th/0206164].
- [14] A. Iqbal, “All genus topological string amplitudes and five-brane webs as Feynman diagrams,” hep-th/0207114.
- [15] A. Iqbal and A. K. Kashani-Poor, “Instanton counting and Chern-Simons theory,” *Adv. Theor. Math. Phys.* **7** (2004) 457 [hep-th/0212279].
- [16] A. Iqbal and A. K. Kashani-Poor, “SU(N) geometries and topological string amplitudes,” *Adv. Theor. Math. Phys.* **10** (2006) 1 [hep-th/0306032].
- [17] T. Eguchi and H. Kanno, “Topological strings and Nekrasov’s formulas,” *JHEP* **0312** (2003) 006 [hep-th/0310235].
- [18] M. Aganagic, A. Klemm, M. Marino and C. Vafa, “The Topological vertex,” *Commun. Math. Phys.* **254** (2005) 425 [hep-th/0305132].

- [19] H. Awata and H. Kanno, “Instanton counting, Macdonald functions and the moduli space of D-branes,” JHEP **0505** (2005) 039 [hep-th/0502061].
- [20] A. Iqbal, C. Kozcaz and C. Vafa, “The Refined topological vertex,” JHEP **0910** (2009) 069 [hep-th/0701156].
- [21] M. Taki, “Refined Topological Vertex and Instanton Counting,” JHEP **0803** (2008) 048 [arXiv:0710.1776 [hep-th]].
- [22] H. Awata and H. Kanno, “Refined BPS state counting from Nekrasov’s formula and Macdonald functions,” Int. J. Mod. Phys. A **24** (2009) 2253 [arXiv:0805.0191 [hep-th]].
- [23] A. Iqbal and C. Kozcaz, “Refined Topological Strings and Toric Calabi-Yau Threefolds,” arXiv:1210.3016 [hep-th].
- [24] A. Iqbal and A. K. Kashani-Poor, “The Vertex on a strip,” Adv. Theor. Math. Phys. **10** (2006) 317 [hep-th/0410174].
- [25] Y. Konishi and S. Minabe, “Flop invariance of the topological vertex,” Int. J. Math. **19** (2008) 27 [math/0601352 [math-ag]].
- [26] M. Taki, “Flop Invariance of Refined Topological Vertex and Link Homologies,” arXiv:0805.0336 [hep-th].
- [27] H. Hayashi, H. C. Kim and T. Nishinaka, “Topological strings and 5d T_N partition functions,” JHEP **1406** (2014) 014 doi:10.1007/JHEP06(2014)014 [arXiv:1310.3854 [hep-th]].
- [28] M. Taki, “Surface Operator, Bubbling Calabi-Yau and AGT Relation,” JHEP **1107**, 047 (2011) doi:10.1007/JHEP07(2011)047 [arXiv:1007.2524 [hep-th]].
- [29] K. Okuyama, “D1-D5 on ALE space,” JHEP **0512**, 042 (2005) doi:10.1088/1126-6708/2005/12/042 [hep-th/0510195].
- [30] F. Benini, R. Eager, K. Hori and Y. Tachikawa, “Elliptic genera of two-dimensional $N=2$ gauge theories with rank-one gauge groups,” Lett. Math. Phys. **104** (2014) 465 [arXiv:1305.0533 [hep-th]].
- [31] F. Benini, R. Eager, K. Hori and Y. Tachikawa, “Elliptic Genera of 2d $\mathcal{N} = 2$ Gauge Theories,” Commun. Math. Phys. **333** (2015) 3, 1241 [arXiv:1308.4896 [hep-th]].
- [32] A. Gadde and S. Gukov, “2d Index and Surface operators,” JHEP **1403** (2014) 080 [arXiv:1305.0266 [hep-th]].
- [33] J. A. Harvey, S. Lee and S. Murthy, “Elliptic genera of ALE and ALF manifolds from gauged linear sigma models,” JHEP **1502** (2015) 110 [arXiv:1406.6342 [hep-th]].
- [34] M. Honda and Y. Yoshida, “Supersymmetric index on $T^2 \times S^2$ and elliptic genus,” arXiv:1504.04355 [hep-th].