

The Right Normal Form of Braids is Regular

Vincent Jugé ^{*†}

May 19, 2019

Braids can be represented geometrically as curve diagrams. The geometric complexity of a braid is the minimal complexity of a curve diagram representing it, and tight curve diagrams are representatives of minimal complexity. These diagrams give rise to normal forms of braids, via relaxation algorithms. We study here the right relaxation algorithm and the associated normal form. We prove that this normal form is regular and prefix-closed. We also provide a deterministic automaton that recognises this normal form, and prove that the size of this automaton is approximately minimal.

1 Introduction

In this paper, we introduce and study combinatorial aspects of braids. Braid groups can be approached from various points of view, including algebraic and geometric ones.

In the algebraic viewpoint, the braid group is defined by a finite presentation, i.e. a generating family and relations. Two of the most widely used generating families are the Artin generators and the Garside generators. We shall hereafter consider some generating family \mathfrak{X} (with $\mathfrak{X} = \mathfrak{A}$ or $\mathfrak{X} = \mathfrak{G}$ in most cases) and shall consider braids as equivalence classes of finite words over the finite alphabet \mathfrak{X} .

A normal form consists in choosing exactly one representative in each equivalence class. Three important desirable properties are computability, regularity and geodicity. The normal form is computable if, from each word \mathbf{w} over the alphabet \mathfrak{X} , one can compute the word \mathbf{x} that is equivalent to \mathbf{w} and that belongs to the normal form; in particular, if a normal form is computable, then the word problem is solvable. The normal form is regular if it forms a regular subset of the language \mathfrak{X}^* of all finite words over the alphabet \mathfrak{X} . The normal form is geodesic if its elements are the shortest representatives of their equivalence classes.

^{*}Mines ParisTech, 60 boulevard Saint-Michel, 75272 Paris Cedex 06, France

[†]Université Paris Diderot, Sorbonne Paris Cité, LIAFA, UMR 7089 CNRS, F-75205 Paris, France.

Note that the notion of geodcity is related to the notion of shortest path in the Cayley graph generated by the family \mathfrak{X} and that, unlike computability or regularity, geodcity depends on the family \mathfrak{X} . More precisely, if \mathfrak{X} and \mathfrak{Y} are two finite generating families, embedding \mathfrak{X} into the set \mathfrak{Y}^* allows to consider normal forms over the alphabet \mathfrak{X} as normal forms over the alphabet \mathfrak{Y} : if a normal form is computable (respectively, regular) on the alphabet \mathfrak{X} , it will remain computable (respectively, regular) on the alphabet \mathfrak{Y} . However, it may be geodesic on the alphabet \mathfrak{X} and non-geodesic on the alphabet \mathfrak{Y} (see [8, Example 4.4.2] for an automatic group in which some generating family admits no regular geodesic normal form).

Let us come back to the specific case of the braid group. The Artin definition of the braid group is

$$B_n = \langle \sigma_1, \dots, \sigma_{n-1} \mid \sigma_i \sigma_{i+1} \sigma_i = \sigma_{i+1} \sigma_i \sigma_{i+1}, \sigma_i \sigma_j = \sigma_j \sigma_i \text{ if } |i - j| \geq 2 \rangle.$$

The set $\mathfrak{A} = \{\sigma_1, \sigma_1^{-1}, \dots, \sigma_{n-1}, \sigma_{n-1}^{-1}\}$ is that of Artin generators. They are often considered as the “most natural” generators because of their rôle in the representation of braids as an isotopy class of *braid diagrams*, as illustrated in Figure 1.

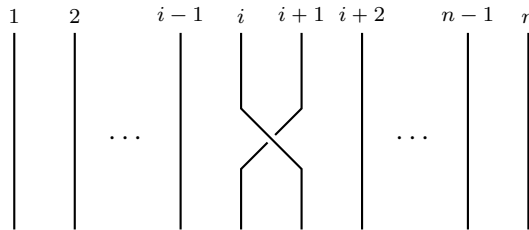

Figure 1: Braid diagram of the generator σ_i ($1 \leq i \leq n - 1$)

Since the word problem in the braid group B_n is decidable, the **ShortLex** normal form over Artin generators is computable, in addition to being geodesic. However, the regularity of **ShortLex** is an open problem. In fact, except for B_2 and B_3 , it is not known whether there exists a regular geodesic normal form for the set of Artin generators.

The monoid of positive braids B_n^+ has a lattice structure for the left-divisibility relation [6]. Hence, consider the braid $\Delta_n = \text{LCM}(\sigma_1, \dots, \sigma_{n-1})$, which we call *Garside element* of the monoid. Note that the set $\mathfrak{G}^+ = \{\beta \in B_n^+ : \beta \text{ left-divides } \Delta_n\}$ generates the braid monoid. The set $\mathfrak{G} = \mathfrak{G}^+ \cup \{\beta : \beta^{-1} \in \mathfrak{G}^+\}$ is that of *Garside generators*.

The *symmetric Garside normal form* over the braid group is built as follows. First, each braid word \mathbf{w} is rewritten under the form $\Delta_n^{-k} \cdot \mathbf{v}$, where $k \geq 0$ and $\mathbf{v} \in B_n^+$, for instance by using rewriting rules of the form

$$\mathbf{a} \cdot \sigma_i^{-1} \cdot \mathbf{b} \mapsto \Delta^{-2} \cdot \mathbf{a} \cdot (\sigma_i^{-1} \cdot \Delta) \cdot \Delta \cdot \mathbf{b}.$$

Second, positive left-divisors of \mathbf{v} are taken out incrementally, thereby factoring \mathbf{v} as a product $\mathbf{v} = u_1 \cdots u_\ell$, where $u_i = \text{GCD}(\Delta_n, u_i u_{i+1} \cdots u_\ell)$ and u_ℓ is non-trivial. Finally,

Δ_n^{-1} divisors appearing in the power Δ_n^{-k} are cancelled out with the leftmost factors $u_1 \cdots u_k$, which provides us with a word of the form $w_1^{-1} \cdots w_k^{-1} u_{k+1} \cdots u_\ell$, where each factor w_i or u_i belongs to the set \mathfrak{G}^+ . The word $w_1^{-1} \cdots w_k^{-1} u_{k+1} \cdots u_\ell$ is the symmetric Garside normal form of the braid word \mathbf{w} .

The Garside normal form was very successful because it is simultaneously regular, synchronously automatic (hence, very easy to compute incrementally) and geodesic on the family \mathfrak{G} .

Unlike the algebraic approach of braids, the geometric point of view is based on geometric representations of braids, not on combinatorial relations on words. The most widely used representation of braids are *integral laminations* of the disk and *curve diagrams*. Below, we shall focus mainly on the first of these (dual) representations. While braids appeared as sets of words on a finite alphabet and acted on such words, they appear here as sets of integral laminations and act on such laminations.

The lamination \mathbf{L} consists in one “fixed puncture” (in black) and n “mobile punctures” (in white) situated on an horizontal axis, as well as $n + 1$ closed curves, enclosing the fixed puncture and from 0 to n mobile punctures. Then, each braid $\beta \in B_n$ acts on the lamination \mathbf{L} as follows: starting from the left of a braid diagram \mathcal{D} representing β , we let the punctures “slide” along the strands of the \mathcal{D} , until we reach the right of \mathcal{D} , whereas the $n + 1$ curves have to follow the motion prescribed by the punctures. Doing so, we obtain the lamination $\beta \cdot \mathbf{L}$, which will henceforth represent the braid β itself.

Figure 2 illustrates the action of the braid σ_2 onto laminations.

In spite of its differences with the algebraic approach, the lamination-based point of view on braids provides a way of obtaining normal forms (and so would the curve-diagram-based point of view). First, to each lamination we associate an equivalent “tight” lamination. Second, thanks to a *relaxation algorithm*, we perform successive simplifications of this tight lamination. Each simplification consists in making some braid act on our lamination in order to obtain a “simplified” tight lamination. We perform such simplifications until reaching a “trivial” lamination that represents the trivial braid. Finally, having found a product of braids that maps the original lamination to the trivial one, inverting that product yields a normal form for the original lamination.

Note the similarity between these two processes: we begin with some “cleaning” step, then perform iteratively simplifications, and finally gather our results in order to obtain the desired normal form.

We focus below on a specific relaxation algorithm, which is the right-relaxation algorithm considered in [3]. We call the associated normal form *right normal form*. Each simplification is obtained by making act a “sliding braid” (i.e. a braid of the form $\sigma_i \cdots \sigma_j$ or $\sigma_i^{-1} \cdots \sigma_j^{-1}$, where $i \leq j$), and so that the braid chosen is “maximal” in some sense that we must make clear in the following pages.

Our main contribution consists in proving that the right normal form is regular. There

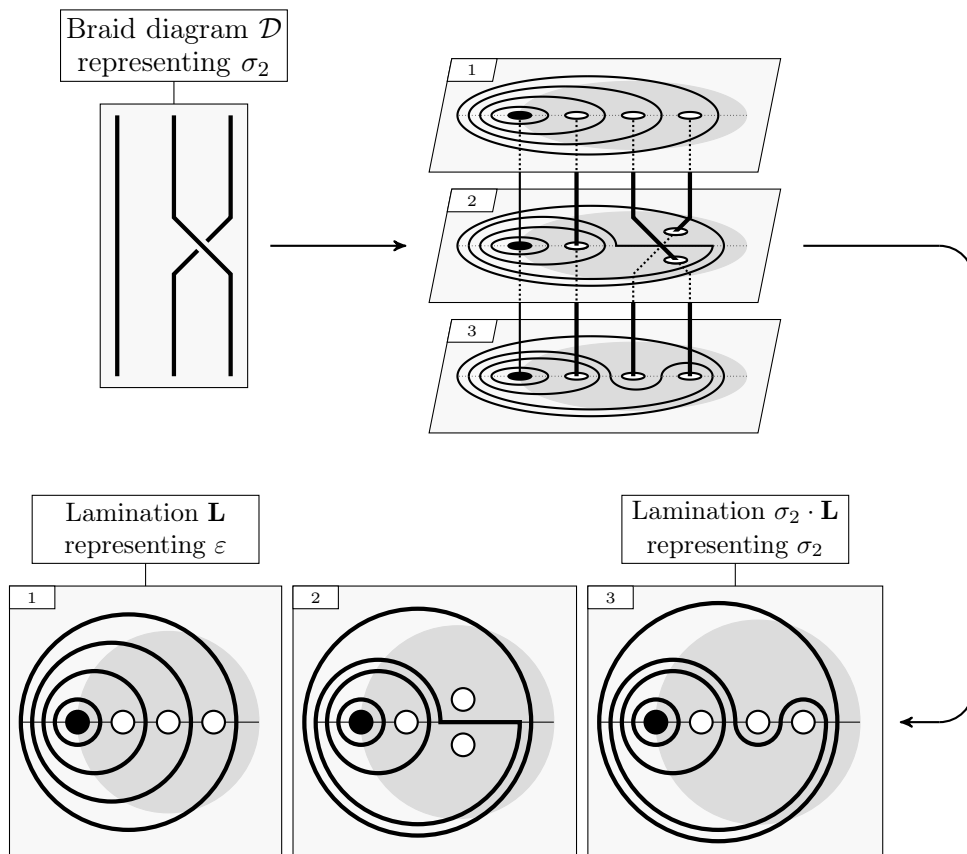

Figure 2: Braid acting on a lamination

already exists normal forms based on applying simplification algorithms: the untangling process of [7] over laminations provides a quasi-geodesic normal form, while the Bressaud normal form [2] that relies on an alternative geometric representation of braids is asynchronously automatic. To our knowledge, our result provides the first known example of regular normal form obtained by applying a relaxation algorithm on braid laminations. However, this normal form does not preserve the braid positivity (i.e. the normal form of a positive braid may contain negative factors) and is not geodesic (for Artin, Garside or sliding generators): for example, the right normal form of the braid $\sigma_2^2 \cdot \sigma_1$ is the word $\sigma_2 \cdot \sigma_2 \cdot \sigma_1 \sigma_2 \cdot \sigma_2^{-1}$.

We also prove some related results about the right normal form: we first show how to read the σ -positivity (i.e. positivity for the Dehornoy ordering on braids) of a braid on its right normal form; then, we find upper and lower bounds on the size of automata accepting the right normal form, providing such an automaton whose size is approximately optimal. Therefore, the geometric approach that leads to the right normal form seems to be as successful as the algebraic approach that led to the Garside normal form.

Finally, let us mention here two objects, which we call *lamination trees* and *cell map*, that

we introduced in order to prove the above-mentioned results. These objects seem to be interesting in themselves, as they proved to be very helpful for capturing the topological and combinatorial nature of laminations.

2 Braids and Curve Diagrams

The group of braids with n strands is usually known by its algebraic description, due to Artin.

Definition 2.1 (Braid group).

The group of braids with n strands is the group

$$B_n = \langle \sigma_1, \dots, \sigma_{n-1} \mid \sigma_i \sigma_{i+1} \sigma_i = \sigma_{i+1} \sigma_i \sigma_{i+1}, \sigma_i \sigma_j = \sigma_j \sigma_i \text{ if } |i - j| \geq 2 \rangle.$$

■

However, in this paper we focus on an other, equivalent approach of the group of braids, that is, we consider the group of braids with n strands is usually known to be the mapping class group of the unit disk with n punctures. More details can be found in [1].

Let $D^2 \subseteq \mathbb{C}$ be the open unit disk and let $P_n \subseteq (-1, 1)$ be a set of size n : we will refer to the elements of P_n as being *mobile punctures* in the disk D^2 . In addition, we will call *fixed puncture* the point -1 , and call *punctures* the elements of the set $\overline{P_n} := P_n \cup \{-1\}$. Let H_n be the group of orientation-preserving homeomorphisms $h : \mathbb{C} \mapsto \mathbb{C}$ such that $h(P_n) = P_n$, $h(-1) = -1$ and $h(\partial D^2) = \partial D^2$, i.e. the orientation-preserving homeomorphisms fixing -1 , ∂D^2 and P_n set-wise.

Theorem 2.2.

The group B_n of braids with n strands is isomorphic to the quotient group of H_n by the isotopy relation.

■

According to standard notations for braids, we will denote below the class of the homeomorphism $h \circ h'$ by $[h \circ h'] = [h'][h]$: composition to the left gives rise to a braid multiplication to the right, and vice-versa.

It is remarkable that this characterisation does *not* depend on which set P_n of mobile punctures we chose. Therefore, in what follows, we shall never consider the set P_n as fixed. In addition, we will always order the elements of the set $\overline{P_n}$ as follows: $\overline{P_n} = \{p_0, \dots, p_n\}$, where $-1 = p_0 < p_1 < \dots < p_n$.

Moreover, each braid appears as a class of homeomorphisms of \mathbb{C} , which conveys the idea of giving a graphical representation of the braid.

Definition 2.3 (Lamination).

Let us consider a set $\overline{P_n}$ of $n + 1$ punctures, the leftmost of which is fixed.

An n -strand lamination of the disk D^2 is the union, hereafter denoted by \mathcal{L} , of the set $\overline{P_n}$, and of $n + 1$ non-intersecting smooth closed curves $\mathcal{L}_0, \dots, \mathcal{L}_n$ such that each curve \mathcal{L}_j splits the plane \mathbb{C} into (a) one inner part that contains -1 and j mobile punctures, and (b) one outer part that contains $+1$ and $n - j$ mobile punctures. ■

We identify braids to isotopy classes of laminations (see [1] for details): if \mathcal{L} and \mathcal{L}' are laminations (defined up to isotopy), then there exists a unique braid β that sends \mathcal{L} to \mathcal{L}' . Hence, we call *circular* a lamination whose curves are circles; since all circular laminations are isotopic to each other, we will identify each braid β to the laminations of the form $h(\mathbf{L})$, where \mathbf{L} is some circular lamination and $h \in H_n$ is a representative of β . Finally, we call *trivial* the laminations that represent the trivial braid ε .

In Figure 3 as well as in the sequel of the document, mobile punctures are indicated by white dots and the fixed puncture is indicated by a black dot; the gray area represents the unit disk D^2 , and the real axis \mathbb{R} is drawn with a thin horizontal line. Hereafter, and depending on the context, we may omit to represent the unit disk D^2 , as well as the names p_0, \dots, p_n .

In addition, we will always denote by \mathcal{L}_j the j -th curve of the lamination \mathcal{L} , i.e. the curve of \mathcal{L} whose left part contains exactly j mobile punctures.

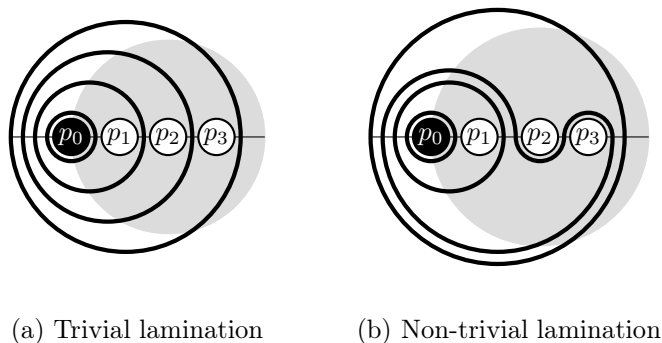

Figure 3: Two laminations

Then, following Dynnikov and Wiest [7], we define the norm of a lamination, and the *laminated norm* of a braid.

Definition 2.4 (Laminated norm and tight lamination).

Let $\beta \in B_n$ be a braid with n strands, and let \mathcal{L} be a lamination representing β , with set of punctures $\overline{P_n}$.

We call *real points of \mathcal{L}* the elements of the set $\mathcal{L}_{\mathbb{R}} := \mathcal{L} \cap \mathbb{R} \setminus \overline{P_n}$, i.e. the number of intersection points between the segment \mathbb{R} and the $n + 1$ curves of the lamination \mathcal{L} . The laminated norm of \mathcal{L} , denoted by $\|\mathcal{L}\|_{\ell}$, is the cardinality of the set $\mathcal{L}_{\mathbb{R}}$.

Moreover, if, among all the laminations \mathcal{L}' that represent β , \mathcal{L} is a lamination with the minimal laminated norm, then we say that \mathcal{L} is a *tight lamination*. In this case, we also

define the laminated norm of the braid β , which we denote by $\|\beta\|_\ell$, as the cardinality of the set $\mathcal{L}_\mathbb{R}$. ■

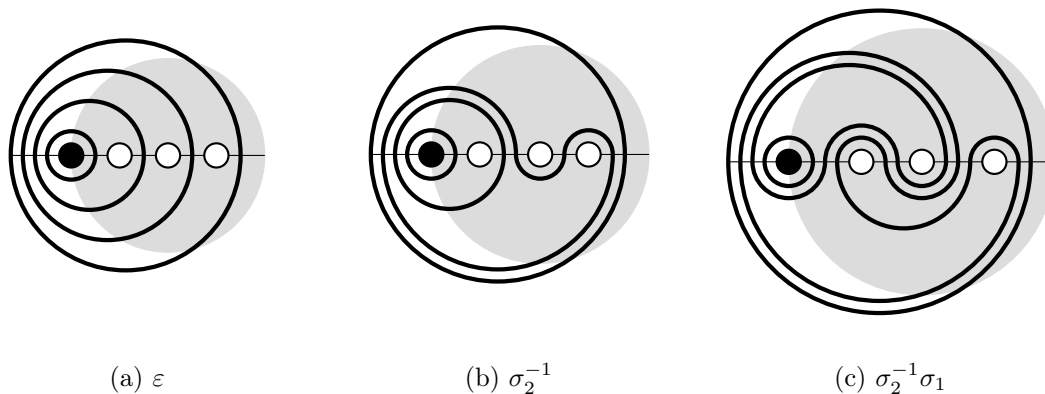

Figure 4: Identifying braids to tight laminations

Tight laminations are crucial, as each braid is identified to a restricted class of tight laminations (see [6, 7, 9] for details).

Theorem 2.5.

Two tight laminations represent the same braid if and only if they are related by an isotopy that preserves the real axis \mathbb{R} set-wise and the set $\{-1, 1\}$ point-wise. ■

Thanks to Theorem 2.5, we will henceforth refer to *the* tight lamination of a braid, implicitly assuming that we are considering laminations up to isotopy of \mathbb{C} preserving \mathbb{R} set-wise and $\{-1, 1\}$ point-wise.

3 Lamination, Planar Trees and Cell Map

By their very definition, laminations can be expected to have a wealth of combinatorial and topological properties. Such properties might both simplify the presentation and the use of laminations, going from the continuous world of drawings to the discrete world of combinatorial objects. In addition, they also might provide insights on some topological quantities observed above, such as the laminated norm. In such a context, we first want to define more closely some geometric objects directly related to laminations, then introduce combinatorial structures indirectly linked to laminations, and finally prove simple yet remarkable properties satisfied by those combinatorial structures.

3.1 Arcs, Bigons and Cells

Since each lamination is composed of curves that intersect the real axis and split the complex plane into finite and infinite zones, we first introduce specific such objects. These objects will be the basis for defining combinatorial tools we want to use in the subsequent sections of this paper.

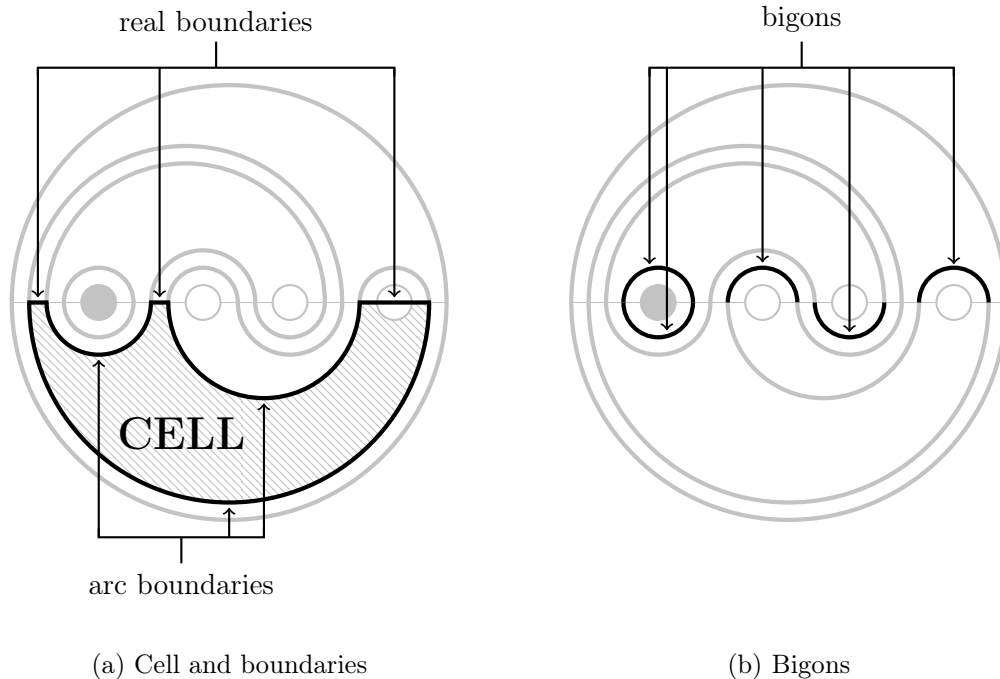

Definition 3.1 (Arcs).

A curve \mathcal{C} is called upper — respectively, a lower — curve if it is contained in the upper half-plane $\{z \in \mathbb{C} : \text{Im}(z) \geq 0\}$ — respectively, the lower half-plane $\{z \in \mathbb{C} : \text{Im}(z) \leq 0\}$.

If the curve \mathcal{C} has exactly two points on the real axis \mathbb{R} and if these points are exactly the endpoints of \mathcal{C} , then we say that \mathcal{C} is an arc. We call left endpoint of \mathcal{C} the smallest endpoint and call right endpoint of \mathcal{C} the biggest endpoint. In addition, we call real projection of \mathcal{C} and denote by $\pi(\mathcal{C})$ the open interval $(e, E) \subseteq \mathbb{R}$, where e is the left endpoint of \mathcal{C} and E is the right endpoint of \mathcal{C} .

Finally, if \mathcal{L} is a lamination and A is an arc that belongs to \mathcal{L} , then we say that A is an arc of \mathcal{L} . ■

Definition 3.2 (Bigon).

Let \mathcal{L} be a lamination. A bigon of \mathcal{L} is an arc of \mathcal{L} whose real projection is minimal for the inclusion ordering. ■

Since bigons are arcs whose real projections are minimal, we focus on the relation on arcs induced by the inclusion relation on their real projections.

Definition 3.3 (Covering ordering).

Let \mathcal{L} be a lamination, and let A and A' be two arcs of \mathcal{L} . We say that A covers A' , which we denote by $A' \stackrel{\pi}{\subseteq} A$, if the relation $\pi(A') \subseteq \pi(A)$ holds.

If $\pi(A') \subsetneq \pi(A)$, then we say that A strictly covers A' , which we denote by $A' \stackrel{\pi}{\subsetneq} A$.

Finally, if a real point p belongs to $\pi(A)$, then we also say that A covers p , which we denote by $p \stackrel{\pi}{\in} A$. ■

Definition 3.4 (Cells and boundaries).

Let \mathcal{L} be a lamination. We call cell of \mathcal{L} each finite connected component of the set $\mathbb{C} \setminus (\mathcal{L} \cup \mathbb{R})$.

In addition, we call arc boundary of a cell C each arc of \mathcal{L} that belongs to the boundary ∂C , and real boundary of C each connected component of the set $\mathbb{R} \cap \partial C$. Observe that one arc boundary of C covers all the other boundaries of C : we call that boundary parent boundary of C , and the other arc boundaries of C are called children boundaries of C .

Finally, we say that C is an upper cell if it is contained in the half plane $\{z \in \mathbb{C} : \text{Im}(z) \geq 0\}$, and a lower cell otherwise. ■

3.2 Bigons

Specialising the notion of covering ordering for stating which punctures of a lamination are covered by a given arc, we come up with the notion of span of an arc.

Definition 3.5 (Span of an arc).

Let \mathcal{L} be a tight lamination with set of punctures $\overline{P}_n = \{p_0, p_1, \dots, p_n\}$, and let A be an arc of the lamination \mathcal{L} .

We call span of A in the lamination \mathcal{L} , and denote by $\mathbf{span}_{\mathcal{L}}(A)$, the set $\{i \in \{0, \dots, n\} : p_i \stackrel{\pi}{\in} A\}$.

By extension, for each point $p_i \in \{p_0, \dots, p_n\}$, we call span of p_i the singleton set $\{i\}$. ■

The notion of span plays a crucial role in providing an intrinsic characterisation of tight laminations (see [6, 9] for details), which will be much easier to handle than some minimality requirement.

Proposition 3.6.

A lamination is tight if and only if each of its arcs (or, equivalently, each of its bigons) has a non-empty span. ■

Furthermore, Lemma 3.7 follows immediately from the fact that the arcs of a lamination must not cross each other.

Lemma 3.7.

Let \mathcal{L} be a tight lamination, and let A and A' be upper (respectively, lower) arcs of \mathcal{L} . Either $\pi(A) \subseteq \pi(A')$ or $\pi(A) \supseteq \pi(A')$ or $\pi(A) \cap \pi(A') = \emptyset$. ■

In what follows, we will denote by $A \overset{\pi}{\circ} A'$ the fact that $\pi(A) \cap \pi(A') = \emptyset$. Lemma 3.7 can hence be reformulated as follows: if A and A' are upper (respectively, lower) arcs of \mathcal{L} , then either $A \overset{\pi}{\subseteq} A'$ or $A \overset{\pi}{\supseteq} A'$ or $A \overset{\pi}{\circ} A'$.

Corollary 3.8.

Let \mathcal{L} be a tight lamination, and let A be an upper arc of \mathcal{L} . The following propositions are equivalent:

- (i) the arc A is a bigon;
- (ii) no upper arc of \mathcal{L} is strictly covered by A ;
- (iii) for each upper arc A' of \mathcal{L} , either $A \overset{\pi}{\subseteq} A'$ or $A \overset{\pi}{\circ} A'$;
- (iv) no endpoint of any upper arc of \mathcal{L} is covered by A ;
- (v) for each lower arc A' of \mathcal{L} , either $A \overset{\pi}{\subseteq} A'$ or $A \overset{\pi}{\circ} A'$;
- (vi) no endpoint of any lower arc of \mathcal{L} is covered by A ;
- (vii) no real point of \mathcal{L} is covered by A .

Similar statements hold when A is a lower arc. ■

Proof. The implications (vii) \Rightarrow (i), (i) \Rightarrow (ii), (iii) \Leftrightarrow (iv), and (v) \Leftrightarrow (vi) are immediate. Moreover, Lemma 3.7 shows that (ii) \Rightarrow (iii). Finally, since \mathcal{L} is tight, being an endpoint of some upper arc of \mathcal{L} is equivalent to being an endpoint of some lower arc of \mathcal{L} (i.e. to being a real point of \mathcal{L}), which proves that (iv) \Leftrightarrow (vi) \Leftrightarrow (vii). □

In addition, and although Proposition 3.6 gives a necessary and sufficient condition for a lamination to be tight, it does not provide us with any algorithm for computing such a tight lamination. We consider below such an algorithm, based on the notion of *extensions*.

Definition 3.9 (Extensions of an arc).

Let \mathcal{L} be a lamination let A be an arc of \mathcal{L} . We call left extension of A , and denote by $\overleftarrow{\mathfrak{e}}(A)$, the arc of \mathcal{L} with which A shares its left endpoint. We call right extension of A , and denote by $\overrightarrow{\mathfrak{e}}(A)$, the arc of \mathcal{L} with which A shares its right endpoint. ■

Algorithm 1 transforms a lamination into a tight lamination representing the same braid. It uses two steps. First, we “normalise” the arcs of the lamination, making sure that we

will not create accidental intersections between arcs. Second, we remove incrementally all the useless bigons, thereby demonstrating that each bigon of each lamination *must* indeed cover some point $p \in \overline{P_n}$.

Note that, for implementation purposes, actually drawing each arc would be useless: the only relevant information is the vertical (upper or lower) orientation of each arc and the locations of its endpoints (which, for instance, can be assumed to be decimal numbers). However, our goal here is mainly to show how one can build a tight lamination and why we can henceforth assume that we deal with tight laminations, but *not* to provide efficient ready-to-use algorithms.

```

input : Lamination  $\mathcal{L}$ 

For each interval  $I$ , we denote by  $\mathcal{C}^\uparrow(I)$  the upper semi-circle with diameter  $I$  and
by  $\mathcal{C}^\downarrow(I)$  the lower semi-circle with diameter  $I$ ;
for each upper arc  $A \subseteq \mathcal{L}$  do
  | replace the arc  $A$  by  $\mathcal{C}^\uparrow(\pi(A))$ 
end
for each lower arc  $A \subseteq \mathcal{L}$  do
  | replace the arc  $A$  by  $\mathcal{C}^\downarrow(\pi(A))$ 
end
while  $\mathcal{L}$  contains a bigon  $B$  that covers no point  $p \in \overline{P_n}$  do
  | let  $e_\ell, e'_\ell, e_r$  and  $e'_r$  be such that  $\pi(B) = (e_\ell, e_r)$ ,  $\pi(\overleftarrow{\mathbf{e}}(B)) = (e_\ell, e'_\ell)$  and
  |  $\pi(\overrightarrow{\mathbf{e}}(B)) = (e_r, e'_r)$ ;
  | if  $B$  is an upper arc then
  |   | replace the arcs  $B$ ,  $\overleftarrow{\mathbf{e}}(B)$  and  $\overrightarrow{\mathbf{e}}(B)$  by  $\mathcal{C}^\downarrow(e'_\ell, e'_r)$ 
  | else
  |   | replace the arcs  $B$ ,  $\overleftarrow{\mathbf{e}}(B)$  and  $\overrightarrow{\mathbf{e}}(B)$  by  $\mathcal{C}^\uparrow(e'_\ell, e'_r)$ 
  | end
end

output: Modified, tight lamination  $\mathcal{L}$ 

```

Algorithm 1: Tightening a lamination

In addition, arcs can be (partially) ordered from left to right in a natural way.

Definition 3.10 (Left-right order in \mathcal{L}).

Let \mathcal{L} be a lamination, and let A and B be two arcs or punctures of \mathcal{L} .

We say that A lies to the left of B in \mathcal{L} , which we denote by $A <_{\mathcal{L}} B$, if and only if $\max \text{span}_{\mathcal{L}}(A) < \min \text{span}_{\mathcal{L}}(B)$. The order $<_{\mathcal{L}}$ is called left-right order in \mathcal{L} . ■

Proposition 3.11.

Let \mathcal{L} be a tight lamination, and let A and A' be two distinct bigons of \mathcal{L} . Either $A <_{\mathcal{L}} A'$ or $A' <_{\mathcal{L}} A$ or $\pi(A) = \pi(A')$; in the latter case, the union $A \cup A'$ is the (innermost) curve \mathcal{L}_0 . ■

Proof. If $\pi(A) \cap \pi(A') \neq \emptyset$, then Corollary 3.8 proves that $\pi(A) \subseteq \pi(A') \subseteq \pi(A)$. Hence, we have $\pi(A) = \pi(A')$, and therefore $A \cup A'$ is a closed curve, i.e. one curve \mathcal{L}_i of \mathcal{L} . The internal area of \mathcal{L}_i contains no other curve of \mathcal{L} , hence $i = 0$.

However, if $\pi(A) \cap \pi(A') = \emptyset$, then of course either $A <_{\mathcal{L}} A'$ or $A' <_{\mathcal{L}} A$. □

In particular, the left-right order in \mathcal{L} induces a total order on the set \mathcal{S} of bigons that are not contained in \mathcal{L}_0 . Moreover, if \mathcal{L} is non-trivial, then the set \mathcal{S} is non-empty, and its elements are greater than any of the two bigons that belong to \mathcal{L}_0 . This leads to the notion of *rightmost bigon*, which is already an important notion in [3].

Definition 3.12 (Rightmost bigon).

Let \mathcal{L} be a tight lamination. We call rightmost bigon of \mathcal{L} the $<_{\mathcal{L}}$ -maximal bigon of \mathcal{L} .

■

3.3 Lamination Trees

We introduce now *lamination trees*, which are the first discrete combinatorial object we mentioned above. Indeed, from Lemma 3.7 follows a remarkable result about the structure of the covering order $\stackrel{\pi}{\subseteq}$.

Definition 3.13 (Lamination trees and reduced arc trees).

Let \mathcal{L} be tight lamination with set of punctures \overline{P}_n . The upper lamination tree (or upper tree) of \mathcal{L} is the ordered tree defined as follows, and which we denote by $\mathcal{T}^{\uparrow}(\mathcal{L})$.

The vertices of $\mathcal{T}^{\uparrow}(\mathcal{L})$ are the upper arcs of \mathcal{L} and the points $p \in \overline{P}_n$. For each upper cell \mathcal{C} of \mathcal{L} , with major arc boundary A :

- for each arc boundary B of \mathcal{C} such that $A \neq B$, the arc A is the father of B ;
- if some puncture $p_i \in \overline{P}_n$ belongs to a real boundary of \mathcal{C} , then the arc A is the father of p_i ;
- the children of A are ordered according to the order $<_{\mathcal{L}}$.

We define similarly the lower arc tree of \mathcal{L} , which we denote by $\mathcal{T}^{\downarrow}(\mathcal{L})$. Finally, when we refer to some arc tree, regardless of whether this is the upper or the lower arc tree, we will just write $\mathcal{T}^{\updownarrow}(\mathcal{L})$.

In addition, we define the (upper and lower) reduced arc trees of \mathcal{L} , which we respectively denote by $\mathcal{T}_{\text{red}}^{\uparrow}(\mathcal{L})$ and $\mathcal{T}_{\text{red}}^{\downarrow}(\mathcal{L})$, by removing the vertices $p_i \in \overline{P}_n$ from the arc trees $\mathcal{T}^{\updownarrow}(\mathcal{L})$. ■

Observe that the (outermost) curve \mathcal{L}_n contains exactly one upper arc and one lower arc, which are maximum elements for the relation $\stackrel{\pi}{\subseteq}$. Hence, Definition 3.13 indeed defines trees. Moreover, note that two distinct points $p_i, p_j \in \overline{P}_n$ cannot belong to real

boundaries of the same cell, since they have to be separated by some arc of \mathcal{L} ; hence, no arc of \mathcal{L} has more than one puncture among its children.

Moreover, if A and B are two upper (respectively, lower) arcs of \mathcal{L} , then $A \stackrel{\pi}{\subsetneq} B$ if and only if B is an ancestor of A in $\mathcal{T}^\uparrow(\mathcal{L})$; similarly, if $p \in \{p_i : 0 \leq i \leq n\}$, then $p \stackrel{\pi}{\in} B$ if and only if B is an ancestor of p in $\mathcal{T}^\uparrow(\mathcal{L})$.

Figure 5 shows the two arc trees $\mathcal{T}^\uparrow(\mathcal{L})$ and $\mathcal{T}^\downarrow(\mathcal{L})$. Each arc A is represented by a white circle lying on A ; each point $p_i \in \overline{P_n}$ is represented by a black circle. The edges of $\mathcal{T}_{\text{red}}^\uparrow(\mathcal{L})$ are plain straight lines; the edges of $\mathcal{T}^\downarrow(\mathcal{L})$ that do not belong to $\mathcal{T}_{\text{red}}^\downarrow(\mathcal{L})$ are dotted straight lines.

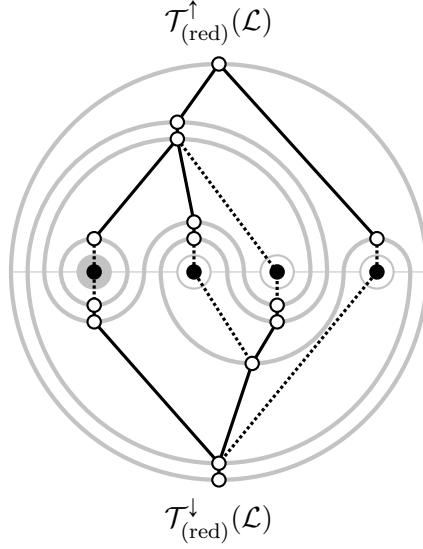

Figure 5: (Reduced) arc trees of a tight lamination

In addition, the leaves of $\mathcal{T}_{\text{red}}^\uparrow(\mathcal{L})$ and $\mathcal{T}^\downarrow(\mathcal{L})$ are remarkable.

Proposition 3.14.

Let \mathcal{L} be a tight lamination. The leaves of the trees $\mathcal{T}^\downarrow(\mathcal{L})$ (respectively, $\mathcal{T}_{\text{red}}^\uparrow(\mathcal{L})$) are the points $p \in \overline{P_n}$ (respectively, the bigons of \mathcal{L}). ■

Proof. First, each point p must be a leaf of $\mathcal{T}^\downarrow(\mathcal{L})$, and the converse holds due to Proposition 3.6. The equivalence between (i) and (ii) in Corollary 3.8 proves the second part of Proposition 3.14. □

Corollary 3.15.

Let \mathcal{L} be a tight lamination. Let A be an arc of \mathcal{L} and let C_1, \dots, C_k be the children of A . The family $(\text{span}_{\mathcal{L}}(C_i))_{1 \leq i \leq k}$ forms a partition of $\text{span}_{\mathcal{L}}(A)$ into intervals. ■

Corollary 3.16.

Let \mathcal{L} be a tight lamination and let B be a bigon of \mathcal{L} . The set $\mathbf{span}_{\mathcal{L}}(B)$ is a singleton. ■

Moreover, the leaves of $\mathcal{T}_{\text{red}}^{\uparrow}(\mathcal{L})$ are the bigons of \mathcal{L} and $<_{\mathcal{L}}$ induces a total order on the set of upper (respectively, lower) bigons of \mathcal{L} , which gives rise to the following definition.

Definition 3.17 (Leftmost and rightmost bigons and spans of an arc).

Let \mathcal{L} be a tight lamination and let A be an arc of \mathcal{L} . Let B_{ℓ} be the leftmost leaf of $\mathcal{T}^{\uparrow}(\mathcal{L})$ that descends from A : since B_{ℓ} is a bigon, let $\{i_{\ell}\}$ be the span of B_{ℓ} in \mathcal{L} . We call B_{ℓ} the leftmost bigon of A , and i_{ℓ} the leftmost span of A . In addition, we define similarly the rightmost bigon and the rightmost span of A . ■

Proposition 3.18.

Let \mathcal{L} be a non-trivial, tight lamination with rightmost bigon A , let k be the rightmost span of \mathcal{L} , and let B be some arc of \mathcal{L} . Then, $\min(\mathbf{span}_{\mathcal{L}}(B)) \leq k$. Moreover, if A and B have opposite vertical orientations (i.e. one is an upper arc and the other one a lower arc), then $\min(\mathbf{span}_{\mathcal{L}}(B)) \leq k - 1$. ■

Proof. Without loss of generality, we assume here that A is an upper bigon. Let C be the rightmost bigon B , with some span $\{i\} \subseteq \mathbf{span}_{\mathcal{L}}(B)$. Since A is the rightmost bigon of \mathcal{L} , then either $C = A$, in which case B is an upper arc and $\min(\mathbf{span}_{\mathcal{L}}(B)) \leq i = k$, or $C < A$, in which case $\min(\mathbf{span}_{\mathcal{L}}(B)) \leq i < k$. □

Moreover, span, covering relation and left-right order are tightly connected to each other, as illustrated by Proposition 3.19.

Proposition 3.19.

Let \mathcal{L} be a tight lamination, let A and B be two upper (respectively, lower) arcs of \mathcal{L} , and let p_i be a point in the set $\{p_j : 0 \leq j \leq n + 1\}$:

- if $A \stackrel{\pi}{\subseteq} B$, then $\mathbf{span}_{\mathcal{L}}(A) \subseteq \mathbf{span}_{\mathcal{L}}(B)$; if $\mathbf{span}_{\mathcal{L}}(A) \subsetneq \mathbf{span}_{\mathcal{L}}(B)$, then $A \stackrel{\pi}{\subsetneq} B$;
- $A \leq B$ if and only if $A \stackrel{\pi}{\subseteq} B$ or $A < B$.

■

3.4 Cell Map

We introduce then *cell maps*, which are the second discrete combinatorial object we advertised above.

Definition 3.20 (Cell map).

Let \mathcal{L} be tight lamination. The cell map of the lamination \mathcal{L} , which we denote by $\mathcal{M}(\mathcal{L})$, is the bipartite planar map (i.e. an embedding of a planar graph into the plane) obtained as follows:

- inside each cell of \mathcal{L} lies a vertex of the map $\mathcal{M}(\mathcal{L})$; we identify below the cell to the vertex it contains;
- for each cell C of \mathcal{L} and each real boundary B of C , we draw, inside the cell C itself, one half-edge between the vertex C and the midpoint of the real boundary B , so that the half-edges drawn from C do not cross each other;
- for each real boundary B , which lies at the border of two cells C and C' , we merge the half-edges that link the midpoint of B to the vertices C and C' , thereby obtaining one edge of the map $\mathcal{M}(\mathcal{L})$ between C and C' .

■

Note that the cell map is neither supposed to be connected nor simple, since two cells may have more than one common real boundary. Actually, each cell map has several connected components and contains multiple edges, although it does not contain loops.

Figure 6 shows the cell map $\mathcal{M}(\mathcal{L})$, whose edges are plain lines and whose vertices are white circles. Moreover, we highlighted one of the connected components of the map by drawing its edges with dotted curves (whereas the other edges are drawn with plain curves).

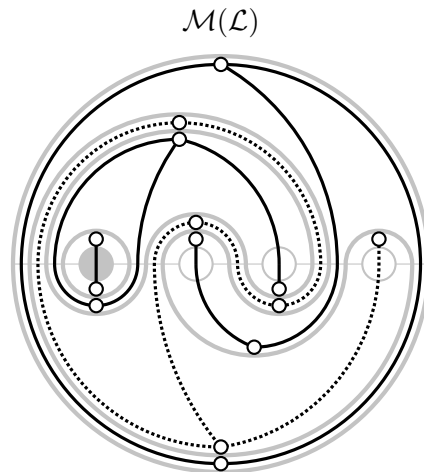

Figure 6: Cell map of a tight lamination

Note that, although the cell map is not connected in general, the relative positions of its connected components is important. Indeed, the topological properties of tight laminations are reflected on their cell maps and arc trees.

Theorem 3.21.

Let \mathcal{L} be a tight lamination and let $\mathcal{M}(\mathcal{L})$ be the cell map of \mathcal{L} . The map $\mathcal{M}(\mathcal{L})$ consists of $n + 1$ connected components C_0, \dots, C_n , which we can order so that

- the component C_0 consists of two vertices and one edge;
- each component C_i (with $1 \leq i \leq n$) has a “lasso” shape, i.e. contains one unique cycle, and has at most one vertex of degree 3; moreover, that cycle has an even length and encloses the components C_0, \dots, C_{i-1} .

■

Proof. Let $\mathcal{L}_0, \dots, \mathcal{L}_n$ be the $n + 1$ curves of the lamination \mathcal{L} . Then, let \mathcal{Z}_0 be the inner area defined by the curve \mathcal{L}_0 and, for $1 \leq i \leq n$, let \mathcal{Z}_i be the area enclosed between the curves \mathcal{L}_{i-1} and \mathcal{L}_i . For each integer $i \leq n$, the set $\{\mathcal{C} : \mathcal{C} \subseteq \mathcal{Z}_i\}$ is a connected component of the cell map $\mathcal{M}(\mathcal{L})$, and we define \mathcal{C}_i to be that component.

Since $\|\mathcal{L}\|_\ell$ is minimal, the curve \mathcal{L}_0 must consist of two bigons with the same real projection, hence C_0 consists of two vertices and one edge. In addition, each component \mathcal{C}_i with $1 \leq i \leq n$ must contain one unique cycle, which encloses the components C_0, \dots, C_{i-1} : indeed, by construction of the areas \mathcal{Z}_j , the set $\bigcup_{j \leq i-1} \mathcal{Z}_j$ is the unique “hole” in the area \mathcal{Z}_i .

Moreover, the map $\mathcal{M}(\mathcal{L})$ is bipartite, as the set of upper cells and the set of lower cells are two independent components of $\mathcal{M}(\mathcal{L})$. Therefore, each cycle must have an even length.

Finally, for $1 \leq i \leq n$ and for each vertex $C \in \mathcal{C}_i$ of degree 1, the cell C has exactly one arc boundary, which must be a bigon, and exactly one real boundary, which must contain the unique puncture of \mathcal{Z}_i . If D is another vertex of \mathcal{C}_i with degree 1, then C and D must therefore share the same real boundary, and $\{C, D\}$ is itself a connected component of $\mathcal{M}(\mathcal{L})$, although it contains no cycle. Hence, \mathcal{C}_i may have at most one vertex with degree 1: since \mathcal{C}_i already has one unique cycle, \mathcal{C}_i must have a lasso shape. □

Note that each component \mathcal{C}_i (with $1 \leq i \leq n$) either contains only simple edges or contains exactly one double edge, which then forms the cycle (of length 2) of the component.

From that property about cell maps follows immediately an analogous property about the shapes of arc trees.

Corollary 3.22.

Let \mathcal{L} be a tight lamination. The trees $\mathcal{T}_{\text{red}}^\uparrow(\mathcal{L})$ and $\mathcal{T}_{\text{red}}^\downarrow(\mathcal{L})$ are unary-binary, i.e. each node in those trees has at most two children. ■

Proof. Each vertex A of \mathcal{L} is the parent arc boundary of some cell \mathcal{C} whose children boundaries are the children A_1, \dots, A_k of the arc A in the tree $\mathcal{T}_{\text{red}}^\uparrow(\mathcal{L})$. Hence, the cell \mathcal{C} has $k + 1$ real boundaries, i.e. degree $k + 1$ in the map $\mathcal{M}(\mathcal{L})$. Since no vertex of $\mathcal{M}(\mathcal{L})$ has a degree more than 3, the result follows. □

Lemma 3.23.

Let \mathcal{L} be a non-trivial tight lamination, with rightmost span i , and let B be one (upper

or lower) father of p_i . If $0 \in \mathbf{span}_{\mathcal{L}}(B)$, then the children of B are one arc with span $\{0, 1, \dots, j-1\}$, one arc with span $\{j, \dots, i-1\}$ and the point p_i . \blacksquare

Proof. Without loss of generality, we assume hereafter that B is an upper arc such that $0 \in \mathbf{span}_{\mathcal{L}}(B)$. Since i is the rightmost span of \mathcal{L} , we know that p_i is the rightmost child of B . Since $\{0, i\} \subseteq \mathbf{span}_{\mathcal{L}}(B)$, we know that $\mathbf{span}_{\mathcal{L}}(B) = \{0, \dots, i\}$ and that B is not a bigon.

Let A be the rightmost bigon of \mathcal{L} . The arc $\overleftarrow{\mathfrak{e}}(A)$ is a child of B , and the arcs A , B and $\overleftarrow{\mathfrak{e}}(A)$ all belong to the same curve \mathcal{L}_u of the lamination \mathcal{L} . Since \mathcal{L}_u intersects once the interval $(-\infty, -1)$, we know that $0 \notin \mathbf{span}_{\mathcal{L}}(\overleftarrow{\mathfrak{e}}(A))$.

Hence, the arc B must have an additional child. Since $\mathbf{span}_{\mathcal{L}}(B)$, $\mathbf{span}_{\mathcal{L}}(\overleftarrow{\mathfrak{e}}(A))$ and $\{i\}$ form a partition of $\mathbf{span}_{\mathcal{L}}(B)$ into intervals, Lemma 3.23 follows. \square

4 The Right Normal Form is Regular

We present now a *right-relaxation algorithm*, introduced by Caruso [3] and based on ideas of Dynnikov and Wiest [7]. This algorithm consists in applying a sequence of elementary homeomorphisms to a given tight curve diagram, in order to obtain a tight curve diagram of the trivial braid ε . This algorithm gives rise to a *right normal form*, which is the main concern of this paper.

We first introduce to notions central to the right-relaxation algorithm: the family of *sliding braids* and the *right-relaxation move*.

Definition 4.1 (Sliding braid).

The family of sliding braids is the family that contains the following braids, for some integers k and ℓ such that $1 \leq k < \ell \leq n$:

- $[k \curvearrowright \ell] = \sigma_k^{-1} \cdot \sigma_{k+1}^{-1} \cdots \sigma_{\ell-1}^{-1}$;
- $[k \curvearrowleft \ell] = \sigma_k \cdot \sigma_{k+1} \cdots \sigma_{\ell-1}$;
- $[k \curvearrowright \ell] = \sigma_\ell \cdot \sigma_{\ell-1} \cdots \sigma_k$;
- $[k \curvearrowleft \ell] = \sigma_\ell^{-1} \cdot \sigma_{\ell-1}^{-1} \cdots \sigma_k^{-1}$.

\blacksquare

Definition 4.2 (Right-relaxation move).

Let β be a non-trivial braid, let \mathcal{L} be the tight lamination that represents β , let A be the rightmost bigon of \mathcal{L} and let j be the rightmost span of \mathcal{L} . We define the right-relaxation move of β , which we denote by $\mathbf{R}(\beta)$, as follows.

If A is an upper (respectively, lower) arc, let B be the lower (respectively, upper) parent of p_j :

- if $\mathbf{span}_{\mathcal{L}}(B) = \{i, \dots, j\}$ for some $i \geq 1$, then $\mathbf{R}(\beta) = [i \curvearrowright j]$ (respectively, $\mathbf{R}(\beta) = [i \curvearrowleft j]$);

- if $\mathbf{span}_{\mathcal{L}}(B) = \{0, \dots, j\}$, let C be the second child of B , with $\mathit{span} \{k, \dots, j-1\}$ for some $k \geq 1$; then, $\mathbf{R}(\beta) = [k \leftarrow j]$ (respectively, $\mathbf{R}(\beta) = [k \leftarrow j]$). ■

Note that Proposition 3.18 proves that $\mathbf{span}_{\mathcal{L}}(B)$ must indeed be some interval $\{i, \dots, j\}$ with $0 \leq i < j$, while Lemma 3.23 shows that, if $i = 0$, then B must have two children, and the arc C is such that $\mathbf{span}_{\mathcal{L}}(C)$ is some interval $\{k, \dots, j-1\}$ with $1 \leq k < j$. This proves the soundness of Definition 4.2.

Right-relaxation moves are at the core of the right normal form, as they allow incremental simplifications of laminations.

Lemma 4.3.

Let β be a non-trivial braid. We have: $\|\beta \cdot \mathbf{R}(\beta)\|_{\ell} \leq \|\beta\|_{\ell} - 1$. ■

Proof. Let \mathcal{L} be the tight lamination, with set of punctures $\overline{P_n}$, that represents β . Let \mathcal{L}' be the lamination obtained from \mathcal{L} as follows:

- if $0 \notin \mathbf{span}_{\mathcal{L}}(B)$, the puncture p_i is slid along the arc B until it reaches the real axis;
- if $0 \in \mathbf{span}_{\mathcal{L}}(B)$, then the puncture p_i is slid along the arc C until it reaches the real axis.

If ρ denotes the real point to which the puncture p_i was slid, then \mathcal{L}' is a lamination with the same arcs as \mathcal{L} , with set of punctures $\overline{P_n} \cup \{\rho\} \setminus \{p_i\}$, and that represents the braid $\beta \cdot \mathbf{R}(\beta)$. Moreover, the arc A covers none of the new punctures, hence \mathcal{L}' is not tight. This proves that $\|\beta \cdot \mathbf{R}(\beta)\|_{\ell} < \|\mathcal{L}'\|_{\ell} = \|\mathcal{L}\|_{\ell} = \|\beta\|_{\ell}$, i.e. that $\|\beta \cdot \mathbf{R}(\beta)\|_{\ell} \leq \|\beta\|_{\ell} - 1$. □

Lemma 4.3 proves that one cannot perform infinitely many successive right-relaxation moves, which leads to the following definition.

Definition 4.4 (Right normal form).

Let $\beta \in B_n$ be a braid, and let β_0, \dots, β_k be the finite sequence of braids such that $\beta_0 = \beta$, $\beta_{i+1} = \beta_i \cdot \mathbf{R}(\beta_i)$ when $0 \leq i < k$ and $\beta_k = \varepsilon$.

We call right normal form of the braid β , and denote by $\mathbf{NF}_r(\beta)$, the word $\mathbf{R}(\beta_{k-1})^{-1} \|\mathbf{R}(\beta_{k-2})^{-1} \|\dots \|\mathbf{R}(\beta_0)^{-1}$, where $\|$ denotes the concatenation of (braid) letters: the i -th letter of the k -letter-long word $\mathbf{NF}_r(\beta)$ is the sliding braid $\mathbf{R}(\beta_{k-i})^{-1}$. ■

Note that Definition 4.4 is not constructive per se. Nevertheless, using Algorithm 1 makes this definition constructive, as it provides us with a way of computing the right normal form of any braid. Indeed, for each braid $\beta \in B_n$, we can compute a (non necessarily tight) lamination of β . Then, using repeatedly Algorithm 1 and applying right-relaxation moves, we can indeed compute the right normal form of β . However, such a way of proceeding would be terribly inefficient in practice: algorithms for manipulating directly

tight laminations of braids are much better suited than such algorithms where we switch between tight and non-tight laminations.

In addition, and as its name suggests, the right normal form is indeed a normal form, as shown below.

Proposition 4.5.

Let $\beta \in B_n$ be a braid, with right normal form $\mathbf{R}(\beta_{k-1})^{-1} \|\mathbf{R}(\beta_{k-2})^{-1} \|\dots \|\mathbf{R}(\beta_0)^{-1}$. The following equality of braids holds: $\beta = \mathbf{R}(\beta_{k-1})^{-1} \cdot \mathbf{R}(\beta_{k-2})^{-1} \dots \mathbf{R}(\beta_0)^{-1}$. ■

Proof. An easy induction shows that $\beta_i = \beta \cdot \mathbf{R}(\beta_0) \cdot \mathbf{R}(\beta_1) \dots \mathbf{R}(\beta_{i-1})$, whence $\varepsilon = \beta_k = \beta \cdot \mathbf{R}(\beta_0) \cdot \mathbf{R}(\beta_1) \dots \mathbf{R}(\beta_{k-1})$. The result follows. □

One key feature of the right normal form is that it is prefix-closed. More precisely, the set of words $\{\mathbf{NF}_r(\beta) : \beta \in B_n\}$ is prefix-closed. This follows from the equality $\mathbf{NF}_r(\beta) = \mathbf{NF}_r(\beta \cdot \mathbf{R}(\beta)) \|\mathbf{R}(\beta)^{-1}$, which holds for each non-trivial braid β .

This prefix-closure property offers numerous possibilities, by identifying each braid to its right normal form — we call *right normal words* the words that belong to the set $\{\mathbf{NF}_r(\beta) : \beta \in B_n\}$. Indeed, one may embed the group of braids into an oriented or non-oriented tree structure, where the children of the right normal word \mathbf{w} are the right normal words of the type $\mathbf{w} \|\lambda$.

Such a structure may be useful for studying random processes: for instance, we may define a random walk by jumping from one right normal word to one of its children that we choose at random. Another example is testing if a braid sequence is a right normal word: it is possible to proceed by induction, checking only whether, for some right normal word \mathbf{w} and some braid letter λ , the sequence $\mathbf{w} \|\lambda$ is a right normal word. The latter property will be useful when proving that the set $\{\mathbf{NF}_r(\beta) : \beta \in B_n\}$ is regular.

Definition 4.6 (Neighbour arcs).

Let \mathcal{L} be a tight lamination and let p be a point on the open real interval $(\min \mathcal{L}_{\mathbb{R}}, \max \mathcal{L}_{\mathbb{R}})$. We call left neighbour of p in \mathcal{L} the point $p_-^{\mathcal{L}} := \max\{z \in \mathcal{L}_{\mathbb{R}} : z < p\}$ and right neighbour of p in \mathcal{L} the point $p_+^{\mathcal{L}} := \min\{z \in \mathcal{L}_{\mathbb{R}} : z > p\}$.

The point $p_-^{\mathcal{L}}$ belongs to two arcs of \mathcal{L} : we call them the left upper arc and the left lower arc of p in \mathcal{L} , and denote them respectively by $\mathcal{A}_-^{\uparrow}(p, \mathcal{L})$ and by $\mathcal{A}_-^{\downarrow}(p, \mathcal{L})$. Similarly, the point $p_+^{\mathcal{L}}$ belongs to two arcs of \mathcal{L} , which we call the right upper arc and the right lower arc of p in \mathcal{L} , and denote them respectively by $\mathcal{A}_+^{\uparrow}(p, \mathcal{L})$ and by $\mathcal{A}_+^{\downarrow}(p, \mathcal{L})$. The four arcs $\mathcal{A}_-^{\uparrow}(p, \mathcal{L})$, $\mathcal{A}_-^{\downarrow}(p, \mathcal{L})$, $\mathcal{A}_+^{\uparrow}(p, \mathcal{L})$ and $\mathcal{A}_+^{\downarrow}(p, \mathcal{L})$ are called neighbour arcs of p in \mathcal{L} . ■

Neighbour arcs give then rise to the following notions.

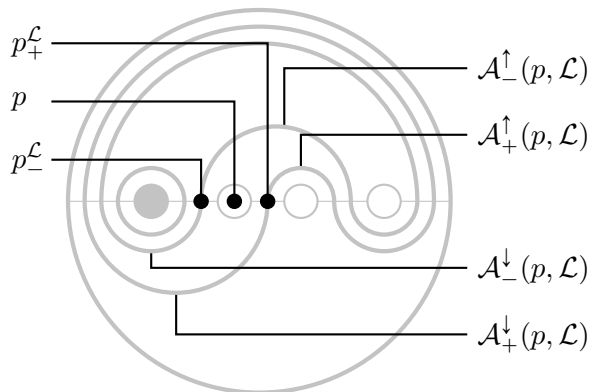
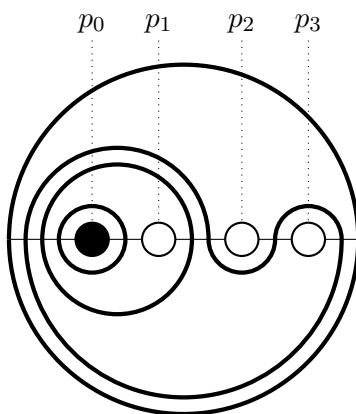

Figure 7: A puncture and its neighbours



		$\text{TR}_\beta(i, \vartheta, \diamond)$				
		i				
		1	2	3		
ϑ	\uparrow	$(\{0\}, \emptyset)$	$(\{0, 1\}, \emptyset)$	$(\{3\}, \{0, 1, 2, 3\})$	-	\diamond
		$(\{0, 1\}, \emptyset)$	$(\{3\}, \{0, 1, 2, 3\})$	$(\{3\}, \{0, 1, 2, 3\})$	+	
	\downarrow	$(\{0\}, \emptyset)$	$(\{2\}, \emptyset)$	$(\{2\}, \emptyset)$	-	
		$(\{0, 1\}, \emptyset)$	$(\{2\}, \emptyset)$	$(\{0, 1, 2, 3\}, \{3\})$	+	

Figure 8: A tight lamination and its extended trace

Definition 4.7 (Extended span and (extended) trace).

Let \mathcal{L} be a tight lamination that represents some braid β , and let k be the rightmost span of \mathcal{L} . Let A be an arc of \mathcal{L} . We define the extended span of A as the pair $(\text{span}_{\mathcal{L}}(A), \text{span}_{\mathcal{L}}(\vec{\epsilon}(A)))$ if $k \in \text{span}_{\mathcal{L}}(A)$, or $(\text{span}_{\mathcal{L}}(A), \emptyset)$ if $k \notin \text{span}_{\mathcal{L}}(A)$.

Then, for $1 \leq i \leq n$, $\vartheta \in \{\downarrow, \uparrow\}$ and $\diamond \in \{+, -\}$, we denote by $\text{tr}_\beta(i, \vartheta, \diamond)$ (respectively, $\text{TR}_\beta(i, \vartheta, \diamond)$) the span (respectively, the extended span) of the arc $\mathcal{A}_\diamond^\vartheta(p_i, \mathcal{L})$.

The trace of β is defined as the mapping

$$\begin{aligned} \mathrm{tr}_\beta & : \{1, \dots, n\} \times \{\downarrow, \uparrow\} \times \{+, -\} \mapsto 2^{\{0, \dots, n\}} \\ & (i, \vartheta, \diamond) \mapsto \mathrm{tr}_\beta(i, \vartheta, \diamond) \end{aligned}$$

and the extended trace of β is defined as the mapping

$$\begin{aligned} \mathrm{TR}_\beta & : \{1, \dots, n\} \times \{\downarrow, \uparrow\} \times \{+, -\} \mapsto 2^{\{0, \dots, n\}} \times 2^{\{0, \dots, n\}}. \\ & (i, \vartheta, \diamond) \mapsto \mathrm{TR}_\beta(i, \vartheta, \diamond) \end{aligned}$$

■

Note that, according to Proposition 3.18, saying that $k \in \mathbf{span}_\mathcal{L}(A)$ is equivalent to saying that $k \leq \max(\mathbf{span}_\mathcal{L}(A))$. Consequently, if $k \in \mathbf{span}_\mathcal{L}(A)$, then $k \in \mathbf{span}_\mathcal{L}(\overrightarrow{\mathbf{e}}(A))$ as well, and the right endpoint of A is also the right endpoint of $\overrightarrow{\mathbf{e}}(A)$.

For example, Figure 8 represents the tight diagram \mathcal{L} associated to the braid $\beta = \sigma_2^{-1}$ and the trace of β . Here, $\mathrm{TR}_\beta(3, \downarrow, +) = (\{0, 1, 2, 3\}, \{3\})$. Indeed, the rightmost span of \mathcal{L} is 3, the span of $\mathcal{A}_+^\downarrow(p_3)$ is $\{0, 1, 2, 3\}$, and $\mathcal{A}_+^\downarrow(p_3)$ shares its right endpoint with an arc of span $\{3\}$.

We provide then necessary and sufficient conditions, in terms of neighbouring arcs and of their spans, for a word $\mathbf{w}\|\lambda$ to be a right normal word.

Theorem 4.8.

Let β be some braid and let k and ℓ be integers such that $0 < k < \ell \leq n$. The equality $\mathbf{NF}_r(\beta \cdot [k \curvearrowright \ell]) = \mathbf{NF}_r(\beta)\|[k \curvearrowright \ell]$ holds if and only if the following conditions are fulfilled:

1. $\mathrm{tr}_\beta(k, \downarrow, +) \neq \{k\}$;
2. either $\mathrm{tr}_\beta(k, \uparrow, +) = \{0, \dots, k\}$ or $\mathrm{tr}_\beta(k, \uparrow, -) \subseteq \{k, \dots, \ell - 1\}$;
3. if $\ell < n$, then $\ell + 1 \in \mathrm{tr}_\beta(i, \uparrow, -) \cap \mathrm{tr}_\beta(i, \downarrow, -)$ for each integer $i \geq \ell + 2$;
4. if $\ell < n$, then $k \in \mathrm{tr}_\beta(\ell + 1, \uparrow, +)$;
5. if $\ell < n$, then either $\mathrm{tr}_\beta(\ell + 1, \downarrow, +) \neq \{\ell + 1\}$ or $\mathrm{tr}_\beta(\ell + 1, \uparrow, -) \subseteq \{k + 1, \dots, \ell\}$.

Analogous conditions, where upper arcs are replaced by lower arcs and vice-versa, characterize whether the equality $\mathbf{NF}_r(\beta \cdot [k \curvearrowright \ell]) = \mathbf{NF}_r(\beta)\|[k \curvearrowright \ell]$ holds. ■

Proof. Let us denote the braid $[k \curvearrowright \ell]$ by λ : we begin by showing how to draw the tight lamination of a braid β , knowing the tight lamination of the braid $\beta \cdot \lambda$ itself and knowing that $\mathbf{R}(\beta \cdot \lambda) = \lambda^{-1}$.

Let $\overline{\mathcal{L}}$ be the tight lamination of $\beta \cdot \lambda$, with set of punctures \overline{P}_n . As suggested in the proof of Lemma 4.3, the puncture p_ℓ of $\overline{\mathcal{L}}$ is slid along one neighbouring arc of p_ℓ , and arrives at some position $\rho \in (p_{k-1}, p_k)$. Then, applying Algorithm 1 amounts to doing what follows.

1. For each (lower) arc \overline{A} of $\overline{\mathcal{L}}$ with span $\{\ell\}$ in $\overline{\mathcal{L}}$, let consider the real projections $(e, E) := \pi(\overleftarrow{\mathbf{e}}(\overline{A}))$ and $(e', E') := \pi(\overrightarrow{\mathbf{e}}(\overline{A}))$. Proposition 3.18 shows that $e' < e < p_{\ell-1} < E < p_{\ell} < E' < p_{\ell+1}$. We merge the arcs \overline{A} , $\overleftarrow{\mathbf{e}}(\overline{A})$ and $\overrightarrow{\mathbf{e}}(\overline{A})$ into one upper arc with real projection (e', e) .
2. We do not modify other arcs of $\overline{\mathcal{L}}$.

Doing so, we obtain a lamination \mathcal{L} with set of punctures $\overline{P}_n \cup \{\rho\} \setminus \{p_{\ell}\}$, which represents the braid β .

Then, Proposition 3.18 proves that the intervals $\text{tr}_{\beta, \lambda}(\ell, \uparrow, -)$ and $\text{tr}_{\beta, \lambda}(\ell, \uparrow, +)$ are respectively of the form $\{i, \dots, \ell - 1\}$ and $\{j, \dots, \ell\}$, with either $j = 0 < i = k \leq \ell - 1$ or $1 \leq j = k \leq i \leq \ell - 1$.

We prove now that β satisfies the requirements enumerated in Theorem 4.8.

1. If $\text{tr}_{\beta}(k, \downarrow, +) = \{k\}$, then this means that the arc $\mathcal{A}_+^{\downarrow}(\rho, \mathcal{L})$, which must also be an arc of $\overline{\mathcal{L}}$ as is each lower arc of \mathcal{L} , has its real projection in the interval (p_{k-1}, p_k) , hence covers no puncture of $\overline{\mathcal{L}}$, contradicting the tightness of $\overline{\mathcal{L}}$.
2. The arcs $\mathcal{A}_+^{\uparrow}(p_{\ell}, \overline{\mathcal{L}})$, $\mathcal{A}_-^{\uparrow}(p_{\ell}, \overline{\mathcal{L}})$ and $\mathcal{A}_-^{\downarrow}(p_{\ell}, \overline{\mathcal{L}})$ were merged into
 - the arc $\mathcal{A}_-^{\uparrow}(\rho, \mathcal{L})$, with span $\text{tr}_{\beta}(k, \uparrow, -) = \{k, \dots, i\} \subseteq \{k, \dots, \ell - 1\}$, if $j \geq 1$;
 - the arc $\mathcal{A}_+^{\uparrow}(\rho, \mathcal{L})$, with span $\text{tr}_{\beta}(k, \uparrow, +) = \{0, \dots, k\}$, if $j = 0$.
3. Consider some $i \geq \ell + 2$. Proposition 3.18 implies that $p_{\ell+1} \stackrel{\pi}{\in} \mathcal{A}_-^{\uparrow}(p_i, \overline{\mathcal{L}})$, and $\mathcal{A}_-^{\uparrow}(p_i, \overline{\mathcal{L}}) = \mathcal{A}_-^{\uparrow}(p_i, \mathcal{L})$, whence $\ell + 1 \in \text{tr}_{\beta}(i, \uparrow, -)$ and, similarly, $\ell + 1 \in \text{tr}_{\beta}(i, \downarrow, -)$.
4. The upper father of p_{ℓ} in $\overline{\mathcal{L}}$ is $\mathcal{A}_+^{\uparrow}(p_{\ell}, \overline{\mathcal{L}})$ and covers ρ . If $\ell < n$, then $\mathcal{A}_+^{\uparrow}(p_{\ell+1}, \mathcal{L}) = \mathcal{A}_+^{\uparrow}(p_{\ell+1}, \overline{\mathcal{L}})$, and Proposition 3.18 states that $p_{\ell} \stackrel{\pi}{\in} \mathcal{A}_+^{\uparrow}(p_{\ell+1}, \overline{\mathcal{L}})$. Hence, $p_{\ell} \stackrel{\pi}{\in} \mathcal{A}_+^{\uparrow}(p_{\ell}, \overline{\mathcal{L}}) \stackrel{\pi}{\subseteq} \mathcal{A}_+^{\uparrow}(p_{\ell+1}, \mathcal{L})$ and $\rho \stackrel{\pi}{\in} \mathcal{A}_+^{\uparrow}(p_{\ell}, \overline{\mathcal{L}}) \stackrel{\pi}{\subseteq} \mathcal{A}_+^{\uparrow}(p_{\ell+1}, \mathcal{L})$, i.e. $k \in \text{tr}_{\beta}(\ell + 1, \uparrow, +)$.
5. If $\ell < n$ and if $\text{tr}_{\beta}(\ell + 1, \downarrow, +) = \{\ell + 1\}$, the puncture $p_{\ell+1}$ belongs to a lower bigon A in \mathcal{L} . As a lower arc of \mathcal{L} , A also belongs to $\overline{\mathcal{L}}$, although it cannot be a bigon of $\overline{\mathcal{L}}$. Hence, let B be the (lower) rightmost bigon of $\overline{\mathcal{L}}$: we have $p_{\ell} \in \pi(B) \subsetneq \pi(A) \subseteq (p_{\ell-1}, p_{\ell+2})$.

In addition, let C be the left extension of A in \mathcal{L} and D be the left extension of B in $\overline{\mathcal{L}}$. Proposition 3.18 shows that both C and D cover $p_{\ell-1}$, and since $B \stackrel{\pi}{\subsetneq} A$ it follows that $\mathcal{A}_-^{\uparrow}(p_{\ell+1}, \mathcal{L}) = C \stackrel{\pi}{\subsetneq} D = \mathcal{A}_-^{\uparrow}(p_{\ell}, \overline{\mathcal{L}})$. Finally, observe that $\rho \stackrel{\pi}{\in} \mathcal{A}_-^{\uparrow}(p_{\ell}, \overline{\mathcal{L}})$, hence that $\pi(C) \subseteq \pi(D) \subseteq (\rho, p_{\ell}) \subseteq (\rho, p_{\ell+1})$. It follows that C has span $\text{tr}_{\beta}(\ell + 1, \uparrow, -) \subseteq \{k + 1, \dots, \ell\}$ in \mathcal{L} .

Conversely, we prove that, if the braid β satisfies the requirements enumerated in Theorem 4.8, the relation $\mathbf{R}(\beta \cdot [k \curvearrowright \ell]) = [k \curvearrowleft \ell]$ holds. We proceed by first showing how to draw the tight lamination of the braid $\beta \cdot [k \curvearrowright \ell]$.

Let \mathcal{L} be the tight lamination of β and let \mathbf{A}^{\uparrow} be the set of the upper arcs of \mathcal{L} . We partition \mathbf{A}^{\uparrow} in several subsets:

- $\Omega_1 = \{A \in \mathbf{A}^\uparrow : k \in \mathbf{span}_{\mathcal{L}}(A) \subseteq \{0, \dots, \ell - 1\}\},$
- $\Omega_2 = \{A \in \mathbf{A}^\uparrow : \{\ell, \ell + 1\} \subseteq \mathbf{span}_{\mathcal{L}}(A) \subseteq \{k + 1, \dots, n\}\},$
- $\Omega_3 = \{A \in \mathbf{A}^\uparrow : \ell \in \mathbf{span}_{\mathcal{L}}(A) \subseteq \{k + 1, \dots, \ell\}\},$
- $\Omega_4 = \{A \in \mathbf{A}^\uparrow : \{k, \ell\} \subseteq \mathbf{span}_{\mathcal{L}}(A) \subseteq \{0, \dots, \ell\}\},$
- $\Omega_5 = \{A \in \mathbf{A}^\uparrow : \ell + 1 \in \mathbf{span}_{\mathcal{L}}(A) \subseteq \{\ell + 1, \dots, n\}\},$
- $\Omega_6 = \{A \in \mathbf{A}^\uparrow : \mathbf{span}_{\mathcal{L}}(A) \subseteq \{0, \dots, k - 1\}\},$
- $\Omega_7 = \{A \in \mathbf{A}^\uparrow : \mathbf{span}_{\mathcal{L}}(A) \subseteq \{k + 1, \dots, \ell - 1\}\},$
- $\Omega_8 = \{A \in \mathbf{A}^\uparrow : \mathbf{span}_{\mathcal{L}}(A) \subseteq \{\ell + 2, \dots, n\}\}$ and
- $\Omega_9 = \{A \in \mathbf{A}^\uparrow : \{k, \ell + 1\} \subseteq \mathbf{span}_{\mathcal{L}}(A)\}.$

First, suppose that some arc A belongs to Ω_8 . Let B be the leftmost bigon of A and let $\{j\}$ be the span of B in \mathcal{L} . Since $\{j\} = \mathbf{span}_{\mathcal{L}}(B) \subseteq \mathbf{span}_{\mathcal{L}}(A) \subseteq \{\ell + 2, \dots, n\}$, we know that $j \geq \ell + 2$, and since $B = \mathcal{A}_-^\uparrow(p_j)$, the requirement 3 is falsified. This contradiction proves that $\Omega_8 = \emptyset$.

Then, if $\ell = n$, then of course $\Omega_2 = \Omega_5 = \emptyset$. If $\ell < n$, then the requirement 4 indicates that $k \in \mathbf{span}_{\mathcal{L}}(\mathcal{A}_+^\uparrow(p_{\ell+1}, \mathcal{L}))$. Consequently, $p_{\ell+1}$ is a child of $\mathcal{A}_+^\uparrow(p_{\ell+1}, \mathcal{L})$, and therefore each upper arc A that covers $p_{\ell+1}$ also covers p_k , whence $\Omega_2 = \Omega_5 = \emptyset$.

Moreover, let us extend the notations $\overset{\pi}{\subseteq}$ and $\overset{\pi}{\in}$ as follows: if X and Y are two subsets of \mathbf{A}^\uparrow such that $A \overset{\pi}{\subseteq} B$ for each pair $(A, B) \in X \times Y$, then we write $X \overset{\pi}{\subseteq} Y$. Similarly, if $p \in \mathbb{R}$ is such that $p \overset{\pi}{\in} A$ for each arc $A \in X$, then we write $p \overset{\pi}{\in} X$. With these notations come the following relations.

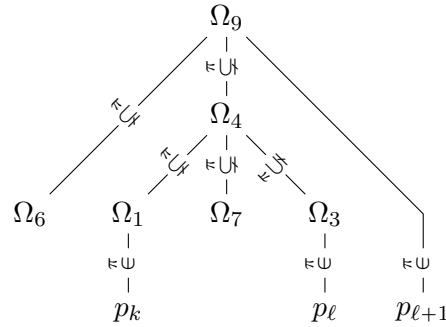

In addition, note that, for each point $p \in \mathbb{R}$, the relation $\overset{\pi}{\subseteq}$ induces a total order on the set $\{A \subseteq \mathcal{L} : A \text{ upper arc}, p \overset{\pi}{\in} A\}$. Consequently, each set Ω_i (for $i \in \{1, 3, 4, 9\}$) is totally ordered by $\overset{\pi}{\subseteq}$: we denote by $A_1^i \overset{\pi}{\subseteq} \dots \overset{\pi}{\subseteq} A_{\omega_i}^i$ the elements of Ω_i , where $\omega_i = \#\Omega_i$, and we denote by (e_j^i, E_j^i) the real projection of the arc A_j^i .

It is then straightforward to see that the elements of $(p_\ell, p_{\ell+1}) \cap \mathcal{L}$ are

$$p_\ell < E_1^3 < \dots < E_{\omega_3}^3 < E_1^4 < \dots < E_{\omega_4}^4 < p_{\ell+1}.$$

Hence, let a_j^- and a_j^+ (for $1 \leq j \leq \omega_1$) and ρ be real numbers such that

$$p_\ell < E_1^3 < \dots < E_{\omega_3}^3 < a_{\omega_1}^- < \dots < a_1^- < \rho < a_1^+ < \dots < a_{\omega_1}^+ < E_1^4 < \dots < E_{\omega_4}^4 < p_{\ell+1}.$$

Let us draw a lamination $\overline{\mathcal{L}}$ as follows. First, we replace each arc $A_j^1 \in \Omega_1$ by three arcs:

- one upper arc $A_j^{1,1}$ with real projection (E_j^1, a_j^-) ;
- one lower arc $A_j^{1,2}$ with real projection (a_j^-, e_j^+) ;
- one upper arc $A_j^{1,3}$ with real projection (e_j^+, a_j^+) .

Then, we replace the puncture p_k by the new puncture ρ , and do not modify the other arcs or punctures of \mathcal{L} .

The drawing $\overline{\mathcal{L}}$ obtained doing so is indeed a lamination, whose set of punctures is $\overline{P_n} \cup \{\rho\} \setminus \{p_i\}$. Indeed, it suffices to check that its arcs can be drawn so that they do not cross each other or, equivalently, that if X and Y are both upper (or lower) arcs of $\overline{\mathcal{L}}$, then either $\pi(X) \subseteq \pi(Y)$ or $\pi(X) \supseteq \pi(Y)$ or $\pi(X) \cap \pi(Y) = \emptyset$. The case where either both or none of X and Y are arcs of \mathcal{L} is immediate, and so is the case where X is of the type $A_j^{1,2}$. Finally, if X is of the type $A_j^{1,1}$ or $A_j^{1,3}$, it suffices to treat separately the cases where $Y \in \Omega_i$ for $i \in \{3, 4, 6, 7, 9\}$, and each of these cases is immediate too.

In addition, each arc $A_j^{1,i}$ (for $1 \leq i \leq 3$) covers either p_ℓ or ρ , each common lower arc of \mathcal{L} and $\overline{\mathcal{L}}$ covers a point p_i with $i \neq k$ (thanks to the requirement 1) and each common upper arc of \mathcal{L} and $\overline{\mathcal{L}}$ covering p_k also covers p_ℓ . Hence, since \mathcal{L} is tight, so is $\overline{\mathcal{L}}$.

Moreover, let B be the rightmost bigon of $\overline{\mathcal{L}}$, with $\text{span}\{i\}$ in $\overline{\mathcal{L}}$. If $i \geq \ell + 1$, then B is also the rightmost bigon of \mathcal{L} , with $\mathbf{span}_{\mathcal{L}}(B) = \mathbf{span}_{\overline{\mathcal{L}}}(B) = \{i\}$. In particular, we have $B = \mathcal{A}_-^\uparrow(p_i, \mathcal{L}) = \mathcal{A}_+^\uparrow(p_i, \mathcal{L})$ or $B = \mathcal{A}_-^\downarrow(p_i, \mathcal{L}) = \mathcal{A}_+^\downarrow(p_i, \mathcal{L})$, depending on whether B is an upper or a lower arc. Consequently,

- if $i \geq \ell + 2$, the requirement 3 states that $\ell + 1 \in \mathbf{span}_{\mathcal{L}}(B)$, which is false;
- if $i = \ell + 1$ and if B is an upper bigon, then the requirement 4 states that $k \in \mathbf{span}_{\mathcal{L}}(B)$, which is false;
- if $i = \ell + 1$ and if B is a lower bigon, then $\overleftarrow{\mathbf{e}}(B) = \mathcal{A}_-^\uparrow(p_{\ell+1}, \mathcal{L})$, hence the requirement 5 shows that $\overleftarrow{\mathbf{e}}(B) \in \Omega_3$; that is why $\overleftarrow{\mathbf{e}}(B) <_{\overline{\mathcal{L}}} \rho <_{\overline{\mathcal{L}}} p_{\ell+1}$, which means that B must cover both ρ and $p_{\ell+1}$, hence that B is not a bigon of $\overline{\mathcal{L}}$.

It follows that $i \geq \ell$, i.e. that $A_1^{1,2}$ is the rightmost bigon of $\overline{\mathcal{L}}$.

Finally, according to the requirement 2, two cases are possible:

- if $\text{tr}_\beta(k, \uparrow, +) = \{0, \dots, k\}$, then $A_1 = \mathcal{A}_+^\uparrow(p_k, \mathcal{L})$ and $p_0 \stackrel{\pi}{\in} A_1^{1,3}$; since the interval (p_k, E_1^1) contains no element of $\overline{\mathcal{L}}_{\mathbb{R}}$, the diagram \mathcal{L} is thus obtained from $\overline{\mathcal{L}}$ by sliding the puncture ρ along the arc $\mathcal{A}_-^\uparrow(\rho, \overline{\mathcal{L}})$, then merging arcs of $\overline{\mathcal{L}}$ like in the first paragraph of the proof;
- if $\text{tr}_\beta(k, \uparrow, -) \subseteq \{k, \dots, \ell - 1\}$, then $p_k \stackrel{\pi}{\in} \mathcal{A}_-^\uparrow(p_k)$ and $A_1 = \mathcal{A}_-^\uparrow(p_k, \mathcal{L})$; since the

interval (e_1^1, p_k) contains no element of $\overline{\mathcal{L}}_{\mathbb{R}}$, the diagram \mathcal{L} is us obtained from $\overline{\mathcal{L}}$ by sliding the puncture ρ along $\mathcal{A}_+^{\uparrow}(\rho, \overline{\mathcal{L}})$, then merging arcs of $\overline{\mathcal{L}}$.

In both cases, $\overline{\mathcal{L}}$ represents the braid $\beta \cdot \lambda$, with $\mathbf{R}(\beta \cdot \lambda) = \lambda^{-1}$: this completes the proof of Theorem 4.8. \square

Theorem 4.8 paves the way for proving that the right normal form is regular. The next step on that relies on the notions of *extended span* and *reduced diagram*.

Theorem 4.9.

Let Σ be the set of all braid letters $[k \curvearrowright \ell]$ or $[k \curvearrowleft \ell]$ where $1 \leq k < \ell \leq n$. There exists two functions **decide** and **compute** that take as inputs the trace TR_{β} of some braid β and a braid $\lambda \in \Sigma$, and such that

1. **decide** $(\text{TR}_{\beta}, \lambda) = \mathbf{true}$ if $\mathbf{NF}_r(\beta) \parallel \lambda$ is a right normal word, and **false** otherwise;
2. if $\mathbf{NF}_r(\beta) \parallel \lambda$ is a right normal word, then **compute** $(\text{TR}_{\beta}, \lambda) = \text{TR}_{\beta \cdot \lambda}$.

■

Proof. Theorem 4.8 implies that knowing tr_{β} is sufficient to check whether $\mathbf{R}(\beta \cdot \lambda) = \lambda^{-1}$. Hence, knowing TR_{β} is also sufficient, which proves the first part of Theorem 4.9.

We prove now the second part of Theorem 4.9 when $\lambda = [k \curvearrowright \ell]$ and $\beta \neq \varepsilon$: let \mathcal{L} and $\overline{\mathcal{L}}$ be the (non-trivial) tight laminations that represent respectively the braids β and $\beta \cdot \lambda$, such that $\mathbf{R}(\beta \cdot \lambda) = \lambda^{-1}$. In addition, consider the functions $\psi : i \mapsto i - \mathbf{1}_{k < i}$ and

$$\begin{aligned} \Psi & : I & \mapsto & \{x : \psi(\min I) \leq x \leq \max I\} \text{ if } I \neq \emptyset, \text{ or } \emptyset \text{ if } I = \emptyset; \\ \Psi^* & : I & \mapsto & \{x : \psi(\min I) \leq x \leq \psi(\max I)\} \text{ if } I \neq \emptyset, \text{ or } \emptyset \text{ if } I = \emptyset; \\ \Theta^{\uparrow} & : (I, J) & \mapsto & (\Psi(I), \Psi(J)) \text{ if } \{k, \ell\} \subseteq I, \text{ or } (\Psi^*(I), \emptyset) \text{ if } \{k, \ell\} \not\subseteq I; \\ \Theta^{\downarrow} & : (I, J) & \mapsto & (\Psi(I), \Psi(J)) \text{ if } \{k, \ell\} \subseteq J, \text{ or } (\Psi^*(I), \emptyset) \text{ if } \{k, \ell\} \not\subseteq J, \end{aligned}$$

where I and J are subintervals of $\{0, \dots, n\}$. These five functions will play a crucial role in computing $\text{TR}_{\beta \cdot \lambda}$.

Indeed, remember how the lamination $\overline{\mathcal{L}}$ was drawn in the second part of the proof of Theorem 4.8. We split the set \mathbf{A}^{\uparrow} of upper arcs of \mathcal{L} into 6 subsets Ω_i (for $i \in \{1, 3, 4, 6, 7, 9\}$) and replaced each arc A_j^{\uparrow} by three arcs $A_j^{1,1}$, $A_j^{1,2}$ and $A_j^{1,3}$, then replaced the puncture p_k by a new puncture ρ , and did not modify any other arc or puncture.

Furthermore, let A be an arc of both \mathcal{L} and $\overline{\mathcal{L}}$, i.e. an arc of \mathcal{L} that does not belong to Ω_1 , with real projection (e, E) . Proposition 3.18 shows that $e < \rho$, hence that $\mathbf{SPAN}_{\overline{\mathcal{L}}}(A) = (\Psi^*(\mathbf{span}_{\mathcal{L}}(A)), \emptyset)$ if $E < \rho$ and $\mathbf{span}_{\overline{\mathcal{L}}}(A) = \Psi(\mathbf{span}_{\mathcal{L}}(A))$ if $E > \rho$.

In addition, if $E > \rho$, let I, J be subintervals of $\{0, \dots, n\}$ such that $\mathbf{SPAN}_{\mathcal{L}}(A) = (I, J)$, and let m be the rightmost span of \mathcal{L} : note that $m \leq \ell + 1$. If $m = \ell + 1$, then $(\rho, p_{\ell+1}) \cap \mathcal{L}_{\mathbb{R}} = \emptyset$, and therefore $E > p_{\ell+1}$, so that $J \neq \emptyset$; if $m \leq \ell$, then of course $J \neq \emptyset$ as well. Hence, in both cases, we have $J = \mathbf{span}_{\mathcal{L}}(\overline{\mathcal{L}}(A))$.

If A is an upper arc, then $E > \rho$ iff $\{k, \ell\} \subseteq \mathbf{span}_{\mathcal{L}}(A) = I$. If A is a lower arc, then $E > \rho$ iff $\{k, \ell\} \subseteq \mathbf{span}_{\mathcal{L}}(\overrightarrow{\mathcal{E}}(A))$, i.e. iff $\{k, \ell\} \subseteq J$, since the equality $\mathbf{span}_{\mathcal{L}}(\overrightarrow{\mathcal{E}}(A)) = J$ holds whenever $E > \rho$. Overall, this proves that $\mathbf{SPAN}_{\overline{\mathcal{L}}}(A) = \Theta^\uparrow(\mathbf{SPAN}_{\mathcal{L}}(A))$ for all upper arcs $A \notin \Omega_1$ of \mathcal{L} , and that $\mathbf{SPAN}_{\overline{\mathcal{L}}}(A) = \Theta^\downarrow(\mathbf{SPAN}_{\mathcal{L}}(A))$ for all lower arcs A of \mathcal{L} .

One may then compute $\mathrm{TR}_{\beta, \lambda}$ as a function of TR_β and of λ , as follows.

1. Let (\diamond, u, v) the unique triple in $\{(+, 0, k)\} \cup \{(-, k, z) : k \leq z < \ell\}$ such that $\mathrm{tr}_\beta(k, \uparrow, \diamond) = \{u, \dots, v\}$. In \mathcal{L} , the upper father of p_k has a span $\{u, \dots, v\}$, whence

$$\begin{aligned}\mathrm{TR}_{\beta, \lambda}(\ell, \uparrow, +) &= (\{u, \dots, \ell\}, \{\ell\}); \\ \mathrm{TR}_{\beta, \lambda}(\ell, \uparrow, -) &= (\{v, \dots, \ell - 1\}, \emptyset); \\ \mathrm{TR}_{\beta, \lambda}(\ell, \downarrow, \pm) &= (\{\ell\}, \{u, \dots, \ell\}).\end{aligned}$$

2. If $k \in \mathrm{tr}_\beta(\ell + 1, \uparrow, -)$, then $p_{\ell+1}$ has the same neighbour arcs in \mathcal{L} and in $\overline{\mathcal{L}}$. However, if $k \notin \mathrm{tr}_\beta(\ell + 1, \uparrow, -)$, then $\Omega_4 = \emptyset$, $\mathcal{A}_+^\uparrow(p_{\ell+1}, \overline{\mathcal{L}}) = \mathcal{A}_+^\uparrow(p_{\ell+1}, \mathcal{L}) = A_1^9$, $\mathcal{A}_+^\downarrow(p_{\ell+1}, \overline{\mathcal{L}}) = \mathcal{A}_+^\downarrow(p_{\ell+1}, \mathcal{L})$, $\mathcal{A}_-^\uparrow(p_{\ell+1}, \overline{\mathcal{L}}) = A_{\omega_1}^{1,3}$ and $\mathcal{A}_-^\downarrow(p_{\ell+1}, \overline{\mathcal{L}}) = A_{\omega_1}^{1,2}$. Moreover, the children of A_1^9 in \mathcal{L} are $A_{\omega_1}^1$, $A_{\omega_3}^3$ and $p_{\ell+1}$, from left to right. It follows that $\min \mathbf{span}_{\mathcal{L}}(A_1^9) = \min \mathbf{span}_{\mathcal{L}}(A_{\omega_1}^1) = \min \mathbf{span}_{\overline{\mathcal{L}}}(A_{\omega_1}^{1,3})$, hence that

$$\begin{aligned}\mathrm{TR}_{\beta, \lambda}(\ell + 1, \uparrow, +) &= \Theta^\uparrow(\mathrm{TR}_\beta(\ell + 1, \uparrow, +)); \\ \mathrm{TR}_{\beta, \lambda}(\ell + 1, \downarrow, +) &= \Theta^\downarrow(\mathrm{TR}_\beta(\ell + 1, \downarrow, +)); \\ \mathrm{TR}_{\beta, \lambda}(\ell + 1, \uparrow, -) &= \Theta^\uparrow(\mathrm{TR}_\beta(\ell + 1, \uparrow, -)) \text{ if } k \in \mathrm{tr}_\beta(\ell + 1, \uparrow, -) \\ &\quad (\Psi^*(\mathrm{tr}_\beta(\ell + 1, \uparrow, +)), \{\ell\}) \text{ if } k \notin \mathrm{tr}_\beta(\ell + 1, \uparrow, -); \\ \mathrm{TR}_{\beta, \lambda}(\ell + 1, \downarrow, -) &= \Theta^\downarrow(\mathrm{TR}_\beta(\ell + 1, \downarrow, -)) \text{ if } k \in \mathrm{tr}_\beta(\ell + 1, \uparrow, -) \\ &\quad (\{\ell\}, \Psi^*(\mathrm{tr}_\beta(\ell + 1, \uparrow, +))) \text{ if } k \notin \mathrm{tr}_\beta(\ell + 1, \uparrow, -).\end{aligned}$$

3. If $k \notin \mathrm{tr}_\beta(\ell, \uparrow, +)$, and therefore $k \notin \mathrm{tr}_\beta(\ell, \uparrow, -)$, then p_ℓ has the same neighbour arcs in \mathcal{L} and in $\overline{\mathcal{L}}$.

If $k \in \mathrm{tr}_\beta(\ell, \uparrow, +)$ and $k \notin \mathrm{tr}_\beta(\ell, \uparrow, -)$, then $\mathcal{A}_+^\uparrow(p_\ell, \overline{\mathcal{L}}) = A_{\omega_1}^{1,1}$, $\mathcal{A}_+^\downarrow(p_\ell, \overline{\mathcal{L}}) = A_{\omega_1}^{1,2}$, $\mathcal{A}_-^\uparrow(p_\ell, \overline{\mathcal{L}}) = \mathcal{A}_-^\uparrow(p_\ell, \mathcal{L}) = A_{\omega_7}^7$, $\mathcal{A}_-^\downarrow(p_\ell, \overline{\mathcal{L}}) = \mathcal{A}_-^\downarrow(p_\ell, \mathcal{L})$ and $\mathcal{A}_+^\uparrow(p_\ell, \mathcal{L}) = A_1^4$. Moreover, the children of A_1^4 in \mathcal{L} are $A_{\omega_1}^1$, $A_{\omega_7}^7$ and p_ℓ , from left to right. It follows that $\min \mathbf{span}_{\mathcal{L}}(A_{\omega_7}^7) = \max \mathbf{span}_{\mathcal{L}}(A_{\omega_1}^1) = 1 + \min \mathbf{span}_{\overline{\mathcal{L}}}(A_{\omega_1}^{1,1})$ and $\min \mathbf{span}_{\mathcal{L}}(A_1^4) = \min \mathbf{span}_{\mathcal{L}}(A_{\omega_1}^1) = \min \mathbf{span}_{\overline{\mathcal{L}}}(A_{\omega_1}^{1,3})$.

If $k \in \mathrm{tr}_\beta(\ell, \uparrow, -)$, and therefore $k \in \mathrm{tr}_\beta(\ell, \uparrow, +)$, then $\mathcal{A}_+^\uparrow(p_\ell, \overline{\mathcal{L}}) = A_{\omega_1}^{1,1}$, $\mathcal{A}_+^\downarrow(p_\ell, \overline{\mathcal{L}}) = A_{\omega_1}^{1,2}$, $\mathcal{A}_-^\uparrow(p_\ell, \overline{\mathcal{L}}) = A_{\omega_1}^{1,1}$, $\mathcal{A}_-^\downarrow(p_\ell, \overline{\mathcal{L}}) = \mathcal{A}_-^\downarrow(p_\ell, \mathcal{L})$ and $\mathcal{A}_+^\uparrow(p_\ell, \mathcal{L}) = A_{\omega_1}^1$.

Putting these three cases together, it comes that

$$\begin{aligned}
\text{TR}_{\beta.\lambda}(\ell - 1, \uparrow, +) &= \Theta^\uparrow(\text{TR}_\beta(\ell, \uparrow, +)) \text{ if } k \notin \text{tr}_\beta(\ell, \uparrow, +) \\
&\quad (\Psi(\text{tr}_\beta(\ell, \uparrow, -), \emptyset) \text{ if } k \in \text{tr}_\beta(\ell, \uparrow, +) \text{ and } k \notin \text{tr}_\beta(\ell, \uparrow, -)) \\
&\quad (\{\ell - 1\}, \emptyset) \text{ if } k \in \text{tr}_\beta(\ell, \uparrow, -); \\
\text{TR}_{\beta.\lambda}(\ell - 1, \uparrow, -) &= \Theta^\uparrow(\text{TR}_\beta(\ell, \uparrow, -)) \text{ if } k \notin \text{tr}_\beta(\ell, \uparrow, -) \\
&\quad (\{\ell - 1\}, \emptyset) \text{ if } k \in \text{tr}_\beta(\ell, \uparrow, -); \\
\text{TR}_{\beta.\lambda}(\ell - 1, \downarrow, +) &= \Theta^\downarrow(\text{TR}_\beta(\ell, \uparrow, +)) \text{ if } k \notin \text{tr}_\beta(\ell, \uparrow, +) \\
&\quad (\{\ell\}, \Psi(\text{tr}_\beta(\ell, \uparrow, +)) \text{ if } k \in \text{tr}_\beta(\ell, \uparrow, +) \text{ and } k \notin \text{tr}_\beta(\ell, \uparrow, -)) \\
&\quad (\{\ell\}, \Psi(\text{tr}_\beta(\ell, \uparrow, -) \cup \{\ell\}) \text{ if } k \in \text{tr}_\beta(\ell, \uparrow, -); \\
\text{TR}_{\beta.\lambda}(\ell - 1, \downarrow, -) &= \Theta^\downarrow(\text{TR}_\beta(\ell, \downarrow, -)).
\end{aligned}$$

4. Let i be an integer such that $i \notin \{k, \ell, \ell + 1\}$. The neighbour arcs of p_i in \mathcal{L} either belong to Ω_1 (in which case the arc A_j^1 will be replaced by $A_j^{1,1}$ if $i > k$, or $A_j^{1,3}$ if $i < k$) or are also neighbour arcs of p_i in $\overline{\mathcal{L}}$. Consequently, we have

$$\begin{aligned}
\text{TR}_{\beta.\lambda}(\overline{\psi}(i), \uparrow, +) &= (\{i + 1, \dots, \ell\}, \{\ell\}) \text{ if } i < k, k \in \text{tr}_\beta(i, \uparrow, +) \text{ and} \\
&\quad \ell \notin \text{tr}_\beta(i, \uparrow, +) \\
&\quad (\{i, \dots, \ell - 1\}, \emptyset) \text{ if } k < i < \ell \text{ and } k \in \text{tr}_\beta(i, \uparrow, +) \\
&\quad \Theta^\uparrow(\text{tr}_\beta(i, \uparrow, +)) \text{ otherwise;} \\
\text{TR}_{\beta.\lambda}(\overline{\psi}(i), \uparrow, -) &= (\{i, \dots, \ell\}, \{\ell\}) \text{ if } i < k, k \in \text{tr}_\beta(i, \uparrow, -) \text{ and } \ell \notin \text{tr}_\beta(i, \uparrow, -) \\
&\quad (\{i - 1, \dots, \ell - 1\}, \emptyset) \text{ if } k < i < \ell \text{ and } k \in \text{tr}_\beta(i, \uparrow, -) \\
&\quad \Theta^\uparrow(\text{tr}_\beta(i, \uparrow, -)) \text{ otherwise;} \\
\text{TR}_{\beta.\lambda}(\overline{\psi}(i), \downarrow, +) &= \Theta^\downarrow(\text{TR}_\beta(i, \downarrow, +)); \\
\text{TR}_{\beta.\lambda}(\overline{\psi}(i), \downarrow, -) &= \Theta^\downarrow(\text{TR}_\beta(i, \downarrow, -)).
\end{aligned}$$

This disjunction of cases provides us with a complete characterization of $\text{tr}_{\beta.\lambda}$ as a function depending only on tr_β and of λ , which completes the proof of Theorem 4.9. \square

Corollary 4.10.

Let $\mathcal{A} = (\Sigma, Q, i, \delta, Q)$ be a deterministic automaton, with

- alphabet $\Sigma = \{[k \curvearrowright \ell] : 1 \leq k < \ell \leq n\} \cup \{[k \curvearrowleft \ell] : 1 \leq k < \ell \leq n\}$;
- state set $Q = \{\text{TR}_\beta : \beta \in B_n\}$;
- initial state $i = \text{TR}_\epsilon$;
- transition function $\delta = \{(\text{TR}_\beta, \lambda, \text{TR}_{\beta.\lambda}) : \mathbf{R}(\beta \cdot \lambda) = \lambda^{-1}\}$;
- set of accepting states Q .

The automaton \mathcal{A} accepts exactly the language of all right normal words. \blacksquare

Figure 9 presents the minimal automaton accepting the language $\mathbf{NF}_r(B_3)$. This minimal automaton is obtained by merging states of the above defined automaton \mathcal{A} . Hence, each state \mathbf{s} of the minimal automaton is a subset of Q , and is represented in Figure 9 by some braid β such that $\text{TR}_\beta \in \mathbf{s}$. The initial state is the state $\{\text{TR}_\varepsilon\}$, and each state is accepting. Moreover, for the sake of readability of Figure 9, we chose to denote by $\overline{\beta}$ the braid β^{-1} .

5 Right Normal Form and Braid Positivity

One of the main features of the braid group is that it is *left-orderable*, meaning that there exists a total order \triangleleft on B_n such that, if α , β and γ are braids such that $\alpha \triangleleft \beta$, then $\gamma \cdot \alpha \triangleleft \gamma \cdot \beta$. Such a property allows us to characterize the order \triangleleft just by knowing its positive elements, i.e. the set $\{\alpha \in B_n : \varepsilon \triangleleft \alpha\}$.

One such left-order is called the *Dehornoy order*. This order has been thoroughly studied [4, 5, 6], and its set of positive elements can be represented simply in terms of σ -positive braids.

Definition 5.1 (σ_i - and σ -positivity).

Let $\beta \in B_n$ be a braid on n strands, and $\sigma_i \in B_n$ be an Artin generator of B_n , where $i \leq n$. We say that β is σ_i -neutral if it belongs to the subgroup of B_n generated by the set $\{\sigma_j : i + 1 \leq j \leq n\}$.

We also say that α is σ_i -positive (respectively, σ_i -negative) if it can be expressed as a product $\alpha = \gamma_0 \sigma_i^\epsilon \gamma_1 \sigma_i^\epsilon \dots \sigma_i^\epsilon \gamma_k$ such that $k \geq 1$, each braid γ_j is σ_i -neutral, and $\epsilon = 1$ (respectively, $\epsilon = -1$).

Finally, we say that α is σ -positive (respectively, σ -negative) if it is σ_i -positive (respectively, σ_i -negative) for some $i \leq n$. ■

This notion of σ -positivity and -negativity has a wealth of properties, including the fact that every non-trivial braid is either σ -positive or σ -negative, but not both (a proof of this result can be found in [6]). It immediately follows that the Dehornoy order \triangleleft , defined as $\alpha \triangleleft \beta$ if and only if $\alpha^{-1}\beta$ is σ -positive, has the property of being a total left-order.

Moreover, σ -positivity and -negativity is directly expressible in terms of tight diagrams.

Definition 5.2 (Second right arcs).

Let \mathcal{L} be a tight lamination and let p_i be some puncture of \mathcal{L} such that $0 \leq i \leq n - 1$. We call second right neighbour of p in \mathcal{L} the point $p_{++}^\mathcal{L} = (p_+^\mathcal{L})_+^\mathcal{L} = \min\{z \in \mathcal{L}_\mathbb{R} : z > p_+^\mathcal{L}\}$.

The point $p_{++}^\mathcal{L}$ belongs to two arcs of \mathcal{L} : we call these arcs the second right upper arc and the second right lower arc of p in \mathcal{L} , and denote them respectively by $\mathcal{A}_{++}^\uparrow(p, \mathcal{L})$ and by $\mathcal{A}_{++}^\downarrow(p, \mathcal{L})$. The two arcs $\mathcal{A}_{++}^\uparrow(p, \mathcal{L})$ and $\mathcal{A}_{++}^\downarrow(p, \mathcal{L})$ are called second right arcs of p in \mathcal{L} . ■

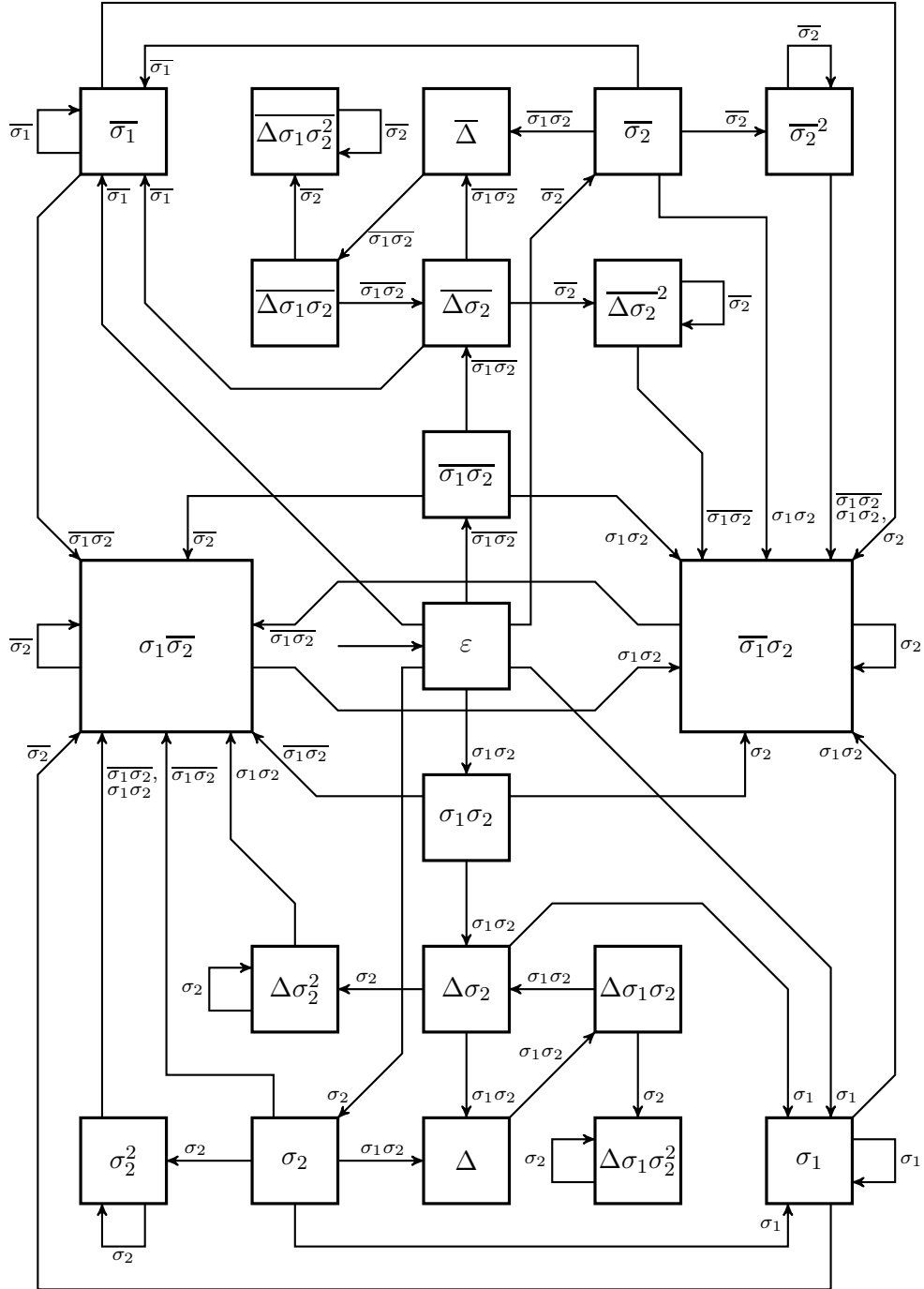

Figure 9: Minimal automaton accepting the language $\mathbf{NF}_r(B_3)$

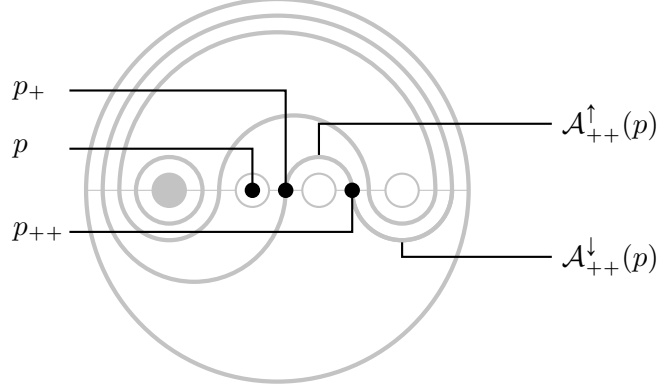

Figure 10: A puncture and its second right neighbour and arcs

Note that the point p_{++} always exists, since $\mathcal{L}_{\mathbb{R}}$ intersects the open intervals (p_{n-1}, p_n) and $(p_n, 1)$.

Second right arcs provide us with a geometrical characterisation of σ_1 -positive and -negative braids (see [6] for details), which we reformulate here.

Lemma 5.3.

Let \mathcal{L} be the tight lamination of a braid $\beta \in B_n$ and let i be some integer such that $1 \leq i \leq n - 1$. The braid β is σ_i -neutral if and only if $0 \in \text{tr}_{\beta}(j, \uparrow, +) \cap \text{tr}_{\beta}(j, \downarrow, +)$ for all $j < i$. In addition, β is

- σ_i -positive if and only if it is σ_i -neutral and $i \in \text{span}_{\mathcal{L}}(\mathcal{A}_{++}^{\uparrow}(p_{i-1}, \mathcal{L})) \subseteq \{i, \dots, n\}$;
- σ_i -negative if and only if it is σ_i -neutral and $i \in \text{span}_{\mathcal{L}}(\mathcal{A}_{++}^{\downarrow}(p_{i-1}, \mathcal{L})) \subseteq \{i, \dots, n\}$.

■

From Lemma 5.3 follows a characterisation of the σ_i -positive and -negative braids according to their right normal forms. Indeed, for each integer $j \in \{1, \dots, n\}$, let \mathcal{S}_j^{\uparrow} , $\mathcal{S}_j^{\downarrow}$ and Σ_j be respectively the subsets $\{[j \curvearrowright v] : j < v\}$, $\{[j \curvearrowleft v] : j < v\}$ and $\bigcup_{k \geq j} (\mathcal{S}_k^{\uparrow} \cup \mathcal{S}_k^{\downarrow})$ of the language Σ of all sliding braids.

Theorem 5.4.

Let $\beta \in B_n$ be a braid. The braid β is σ_i -positive (respectively, σ_i -negative) if and only if $\mathbf{NF}_r(\beta) \in \Sigma_{i+1}^* \cdot \mathcal{S}_i^{\uparrow} \cdot \Sigma_i^*$ (respectively, $\mathbf{NF}_r(\beta) \in \Sigma_{i+1}^* \cdot \mathcal{S}_i^{\downarrow} \cdot \Sigma_i^*$). ■

Proof. First, note that the sets $\{\varepsilon\}$, $\Sigma_{i+1}^* \cdot \mathcal{S}_i^{\uparrow} \cdot \Sigma_i^*$ and $\Sigma_{i+1}^* \cdot \mathcal{S}_i^{\downarrow} \cdot \Sigma_i^*$ for $(1 \leq i \leq n - 1)$ form a partition of the set Σ^* . Moreover, a braid β such that $\mathbf{NF}_r(\beta) \in \Sigma_{i+1}^* \cdot \mathcal{S}_i^{\uparrow}$ (respectively, $\mathbf{NF}_r(\beta) \in \Sigma_{i+1}^* \cdot \mathcal{S}_i^{\downarrow}$) is clearly σ_i -positive (respectively, -negative). Hence, and without loss of generality, it suffices to prove that if β is a σ_i -positive braid and if $\mathbf{R}(\beta \cdot [i \curvearrowright j]) = [i \curvearrowleft j]$ for some $j > i$, then $\beta \cdot [i \curvearrowright j]$ is σ_i -positive.

Then, let \mathcal{L} and $\overline{\mathcal{L}}$ be tight laminations of β and $\beta \cdot [i \curvearrowright j]$. Since β is σ_i -positive, let Lemma 5.3 states that $0 \in \text{tr}_\beta(j, \uparrow, +) \cap \text{tr}_\beta(j, \downarrow, +) = \text{tr}_{\beta \cdot [i \curvearrowright j]}(j, \uparrow, +) \cap \text{tr}_{\beta \cdot [i \curvearrowright j]}(j, \downarrow, +)$ for all $j < i$. Furthermore, let $A := \mathcal{A}_{++}^\uparrow(p_{i-1}, \mathcal{L}) = \mathcal{A}_{++}^\uparrow(p_{i-1}, \overline{\mathcal{L}})$. Lemma 5.3 also states $i \in \mathbf{span}_{\mathcal{L}}(A) \subseteq \{i, \dots, n\}$, and Theorem 4.8 proves that $\mathbf{span}_{\mathcal{L}}(A) \neq \{i\}$. It follows that $\{i, i+1\} \subseteq \mathbf{span}_{\mathcal{L}}(A)$ and therefore $i \in \mathbf{span}_{\overline{\mathcal{L}}}(A) \subseteq \{i, \dots, n\}$, which completes the proof. \square

It follows that the sets $\{\mathbf{NF}_r(\beta) : \beta \text{ is } \sigma_i\text{-positive}\}$ and $\{\mathbf{NF}_r(\beta) : \beta \text{ is } \sigma_i\text{-negative}\}$ are regular, and that each prefix of a σ_i -positive word must be σ_i -positive or σ_i -neutral.

6 Is That Automaton Really Efficient?

Corollary 4.10 provides us with a deterministic automaton that accepts the right normal form. A natural question is that of the size of the deterministic automaton for that normal form. Is the automaton provided in Corollary 4.10 optimal or close to optimal? Before answering this question, we first introduce some combinatorial objects arising from the concepts of arc trees and of neighbour arcs.

Definition 6.1 (Neighbour trees).

Let \mathcal{L} be tight lamination, with set of punctures \overline{P}_n and with rightmost span k . Let A_n^\uparrow be the upper arc contained in the curve \mathcal{L}_n , and let Λ^\uparrow be the set of upper arcs of \mathcal{L} defined as

$$\Lambda^\uparrow = \{\mathcal{A}_\pm^\uparrow(p_i) : 0 \leq i \leq n\} \cup \{A_n^\uparrow\} \cup \{A : p_k \stackrel{\pi}{\in} A \text{ and } \exists i \leq n, \overline{\mathbf{e}}(A) = \mathcal{A}_\pm^\downarrow(p_i)\}.$$

The upper neighbour tree of the lamination \mathcal{L} which we denote by $\mathcal{N}^\uparrow(\mathcal{L})$, is the ordered tree whose vertices are the elements of $\Lambda^\uparrow \cup \overline{P}_n$ and in which the ancestorship relation is equal to the covering relation. In particular, if $w_1 <_{\mathcal{L}} \dots <_{\mathcal{L}} w_k$ are the children of v in $\mathcal{N}^\uparrow(\mathcal{L})$, then w_i is the i -th child of v .

We define similarly the lower neighbour tree of \mathcal{L} , which we denote by $\mathcal{N}^\downarrow(\mathcal{L})$. Finally, when we refer to some neighbour tree, regardless of whether this is the upper or the lower neighbour tree, we will just write $\mathcal{N}^\dagger(\mathcal{L})$. \blacksquare

Note that, following Proposition 3.14, the leaves of $\mathcal{N}^\dagger(\mathcal{L})$ are the punctures $p_i \in \overline{P}_n$ and the leaves of $\mathcal{N}^\dagger(\mathcal{L}) \setminus \{p_i : 0 \leq i \leq n\}$ (i.e. the deepest internal nodes of $\mathcal{N}^\dagger(\mathcal{L})$) are the bigons of \mathcal{L} .

Lemma 6.2. Let β and β' be braids, with respective tight laminations \mathcal{L} and \mathcal{L}' . If $\mathcal{N}^\uparrow(\mathcal{L}) = \mathcal{N}^\uparrow(\mathcal{L}')$ and $\mathcal{N}^\downarrow(\mathcal{L}) = \mathcal{N}^\downarrow(\mathcal{L}')$, then $\text{TR}_\beta = \text{TR}_{\beta'}$.

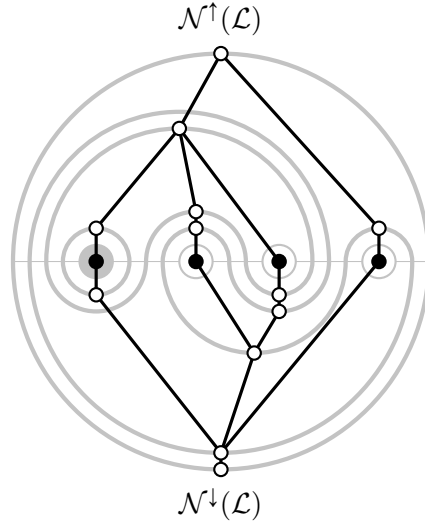

Figure 11: Neighbour trees of a tight lamination

Proof. Let Λ^\uparrow and Λ^\downarrow be the respective sets of internal nodes of $\mathcal{N}^\uparrow(\mathcal{L})$ and of $\mathcal{N}^\downarrow(\mathcal{L})$, and let A_n^\uparrow and A_n^\downarrow be the respective roots of $\mathcal{N}^\uparrow(\mathcal{L})$ and of $\mathcal{N}^\downarrow(\mathcal{L})$.

Let $p_i \in \overline{P_n}$ be some puncture of \mathcal{L} . If p_i has a left brother in $\mathcal{N}^\uparrow(\mathcal{L})$, then $\mathcal{A}_-^\uparrow(p_i, \mathcal{L})$ is the rightmost such brother; otherwise, $\mathcal{A}_-^\uparrow(p_i, \mathcal{L})$ is the father of p_i in $\mathcal{N}^\uparrow(\mathcal{L})$. Hence, one can identify which node of $\mathcal{N}^\downarrow(\mathcal{L})$ is $\mathcal{A}_-^\uparrow(p_i, \mathcal{L})$ and, similarly, one identifies the arcs $\mathcal{A}_-^\downarrow(p_i, \mathcal{L})$ and $\mathcal{A}_+^\downarrow(p_i, \mathcal{L})$ among the nodes of $\mathcal{N}^\downarrow(\mathcal{L})$.

Moreover, let k be the rightmost span of \mathcal{L} . Let $A_1 \stackrel{\pi}{\subsetneq} \dots \stackrel{\pi}{\subsetneq} A_u$ be the arcs covering p_k and belonging to Λ^\uparrow . Likewise, let $B_1 \stackrel{\pi}{\subsetneq} \dots \stackrel{\pi}{\subsetneq} B_v$ be the arcs covering p_k and belonging to Λ^\downarrow . One checks immediately that $u = v$ and that $A_j = \overline{\mathfrak{e}}(B_j)$ whenever $1 \leq j \leq u$. Hence, one identifies each of the arcs of $\{A : p_k \stackrel{\pi}{\in} A \text{ and } \exists i \leq n, \overline{\mathfrak{e}}(A) = \mathcal{A}_\pm^\downarrow(p_i)\}$ among the nodes of $\mathcal{N}^\downarrow(\mathcal{L})$.

This means that we can compute $\text{TR}_\beta(i, \vartheta, \diamond)$ for each triple $(i, \vartheta, \diamond) \in \{0, \dots, n\} \times \{\uparrow, \downarrow\} \times \{+, -\}$, i.e. that the trees $\mathcal{N}^\uparrow(\mathcal{L})$ and $\mathcal{N}^\downarrow(\mathcal{L})$ uniquely determine TR_β , which completes the proof. \square

Corollary 6.3.

Let $\mathcal{A} = (\Sigma, Q, i, \delta, Q)$ be the automaton provided in Corollary 4.10. Its state set Q is of size $\#Q \leq 2^{10n+14}$. \blacksquare

Proof. Let \mathbf{N} be the set $\{(\mathcal{N}^\uparrow(\mathcal{L}), \mathcal{N}^\downarrow(\mathcal{L})) : \mathcal{L} \text{ is a tight diagram}\}$ and let \mathbf{TR} be the set $\{\text{TR}_\beta : \beta \in B_n\}$. Lemma 6.2 states that there exists some surjective projection $\mathbf{N} \mapsto \mathbf{TR}$, hence that $\#\mathbf{TR} \leq \#\mathbf{N}$. Since $Q = \mathbf{TR}$, it remains to show that $\#\mathbf{N} \leq 2^{10n+14}$.

Then, let β be a braid, with tight lamination \mathcal{L} . By definition, both trees $\mathcal{N}^\dagger(\mathcal{L})$ have exactly $n + 1$ leaves and from 1 to $4(n + 1) + 1$ internal nodes.

It follows that

$$\#\mathbf{N} \leq \left(\sum_{i=n+1}^{5n+6} C_i \right)^2 \leq C_{5n+7}^2,$$

where C_k is the k -th Catalan number, i.e. the number of ordered trees with exactly k nodes. Since $C_k \leq 4^k$, the result follows. \square

We can then prove that the size of the automaton \mathcal{A} has the same order of magnitude as the minimal size we might have hoped for.

Proposition 6.4.

Let $\mathcal{A}_{\min} = (\Sigma, Q_{\min}, i_{\min}, \delta_{\min}, F_{\min})$ be the minimal deterministic automaton that accepts the set of right normal words for the braid group B_n . The sets F_{\min} and Q_{\min} are equal, with cardinality $\#Q_{\min} \geq 2^{(n-1)/2}$. \blacksquare

Proof. Let \mathcal{A}_{\min} be above automaton. Since \mathcal{A}_{\min} is minimal, each of its states is co-accessible: from each state $s \in Q_{\min}$, one can reach a state $s' \in F_{\min}$. Since the right normal form is prefix-closed, it follows that $Q_{\min} \subseteq F_{\min}$, i.e. that $F_{\min} = Q_{\min}$.

To each braid α corresponds a unique right normal word in Σ^* , hence one unique state in Q_{\min} : we denote that state by $\delta^*(\alpha)$. Now, let $m = \lfloor \frac{n-1}{2} \rfloor$. To each tuple $\epsilon = (\epsilon_1, \epsilon_2, \dots, \epsilon_m) \in \{-1, 1\}^m$, we associate the braid $\beta_\epsilon = \sigma_1^{\epsilon_1} \sigma_3^{\epsilon_2} \dots \sigma_{2m-1}^{\epsilon_m} \in B_n$. An immediate induction shows that $\sigma_1^{\epsilon_1} \sigma_3^{\epsilon_2} \dots \sigma_{2m-1}^{\epsilon_m}$ is a right normal word.

Then, if ϵ and η are different tuples in $\{-1, 1\}^m$, consider some integer $i \leq m$ such that $\epsilon_i \neq \eta_i$: without loss of generality, we assume that $\epsilon_i = -1$ and that $\eta_i = 1$. One shows easily that $\mathbf{NF}_r(\beta_\epsilon) \parallel [2i \curvearrowright n]$ is a right normal word, although $\mathbf{NF}_r(\beta_\eta) \parallel [2i \curvearrowright n]$ is not. This shows that $\delta^*(\beta_\epsilon) \neq \delta^*(\beta_\eta)$ and, consequently, that $\#Q_{\min} \geq 2^m \geq 2^{(n-1)/2}$. \square

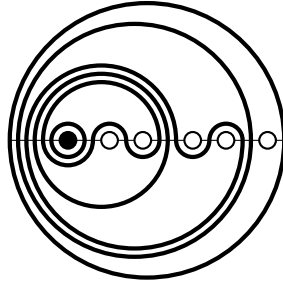

Figure 12: The braid $\beta_{(1,-1)}$ (for $n = 5$)

Corollary 6.5.

Both automata \mathcal{A} and \mathcal{A}_{\min} introduced in Corollary 4.10 and Proposition 6.4 have state sets with cardinalities $2^{\Omega(n)}$. \blacksquare

References

- [1] Joan Birman. *Braids, Links and Mapping Class Groups*. Annals of Math. Studies, Princeton Univ. Press, 1974.
- [2] Xavier Bressaud. A normal form for braids. *J. Knot Theory Ramifications*, 17(6):697–732, 2008.
- [3] Sandrine Caruso. Algorithme de relaxations par la droite et spirales d’un diagramme de courbes. <http://perso.univ-rennes1.fr/sandrine.caruso/spirales.pdf>, 2012.
- [4] Patrick Dehornoy. Deux propriétés des groupes de tresses. *C. R. Acad. Sci. Paris Sér. I Math.*, 315(6):633–638, 1992.
- [5] Patrick Dehornoy. Braid groups and left distributive operations. *Trans. Amer. Math. Soc.*, 345(1):115–150, 1994.
- [6] Patrick Dehornoy, Ivan Dynnikov, Dale Rolfsen, and Bert Wiest. *Why are braids orderable?*, volume 14 of *Panoramas et Synthèses [Panoramas and Syntheses]*. Société Mathématique de France, Paris, 2002.
- [7] Ivan Dynnikov and Bert Wiest. On the complexity of braids. *J. Eur. Math. Soc. (JEMS)*, 9(4):801–840, 2007.
- [8] David Epstein, Mike Paterson, James Cannon, Derek Holt, Silvio Levy, and William Thurston. *Word Processing in Groups*. A. K. Peters, Ltd., Natick, MA, USA, 1992.
- [9] Roger Fenn, Michael Greene, Dale Rolfsen, Colin Rourke, and Bert Wiest. Ordering the braid groups. *Pacific J. Math.*, 191(1):49–74, 1999.